

SONY

User Guide

Personal Computer
VGN-CS series



Contents

Before Use	6
Notice	7
ENERGY STAR	8
Documentation	9
Ergonomic Considerations	12
Getting Started	14
Locating Controls and Ports	15
About the Indicator Lights	21
Connecting a Power Source	22
Using the Battery Pack	23
Shutting Down Your Computer Safely	30
Using Your VAIO Computer	31
Using the Keyboard	32
Using the Touch Pad	33
Using the Special-function Button	34
Using the Touch Sensor Buttons	35
Using the Built-in MOTION EYE Camera	39
Using the Optical Disc Drive	42
Using the ExpressCard Module	51
Using the Memory Stick	55
Using the SD Memory Card	60

- Using the Internet.....63
- Using Wireless LAN (WLAN)64
- Using the Bluetooth Function.....71
- Using Peripheral Devices.....77
 - Connecting External Speakers78
 - Connecting an External Display.....79
 - Selecting Display Modes.....82
 - Using the Multiple Monitors Function.....83
 - Connecting an External Microphone.....85
 - Connecting a Universal Serial Bus (USB) Device.....86
 - Connecting a Printer89
 - Connecting an i.LINK Device90
 - Connecting to a Network (LAN)92
- Customizing Your VAIO Computer93
 - Setting the Password.....94
 - Using Fingerprint Authentication.....101
 - Setting Up Your Computer with VAIO Control Center.....109
 - Using the Power Saving Modes.....110
 - Managing Power with VAIO Power Management.....115
 - Configuring Your Modem117
- Upgrading Your VAIO Computer.....119
 - Adding and Removing Memory.....120

Precautions	126
Handling the LCD Screen	127
Using the Power Source	128
Handling Your Computer	129
Handling the Built-in MOTION EYE Camera.....	131
Handling Floppy Disks	132
Handling Discs	133
Using the Battery Pack	134
Using Headphones	135
Handling the Memory Stick	136
Handling the Hard Disk	137
Updating Your Computer	138
Troubleshooting	139
Computer	141
System Security	147
Battery.....	148
Built-in MOTION EYE Camera.....	150
Internet.....	153
Networking	155
Bluetooth Technology	159
Optical Discs	164
Display	168
Printing.....	172
Microphone	173

Mouse	174
Speakers	175
Touch Pad.....	177
Keyboard.....	178
Floppy Disks	179
Audio/Video.....	180
Memory Stick	182
Peripherals.....	183
Support Options	184
Sony Support Information	185
e-Support	186
Trademarks	188

Before Use

Congratulations on your purchase of this Sony VAIO® computer, and welcome to the on-screen User Guide. Sony has combined leading-edge technology in audio, video, computing, and communications to provide state-of-the-art personal computing experience.



External views illustrated in this manual may look slightly different from those of your computer.

Notice

© 2008 Sony Corporation. All rights reserved.

This manual and the software described herein, in whole or in part, may not be reproduced, translated, or reduced to any machine-readable form without prior written approval.

Sony Corporation provides no warranty with regard to this manual, the software, or other information contained herein and hereby expressly disclaims any implied warranties or merchantability or fitness for any particular purpose with regard to this manual, the software, or such other information. In no event shall Sony Corporation be liable for any incidental, consequential, or special damages, whether based on tort, contract, or otherwise, arising out of or in connection with this manual, the software, or other information contained herein or the use thereof.

In the manual, the ™ or ® marks are not specified.

Sony Corporation reserves the right to make any modification to this manual or the information contained herein at any time without notice. The software described herein is governed by the terms of a separate user license agreement.

ENERGY STAR



As an ENERGY STAR Partner, Sony has determined that this product meets the ENERGY STAR guidelines for energy efficiency.

The International ENERGY STAR Office Equipment Program is an international program that promotes energy saving through the use of computers and office equipment. The program backs the development and dissemination of products with functions that effectively reduce energy consumption.

For detailed information on the ENERGY STAR Program, visit the following web sites:

- <http://www.energystar.gov> (USA)
- <http://www.eu-energystar.org> (Europe)

This computer is designed in compliance with the ENERGY STAR standards and delivered with the following power saving settings:

- The LCD backlight is turned off automatically after about 15 minutes of inactivity.
- The computer enters Sleep mode automatically after about 30 minutes of inactivity.

Press any key to bring the computer back into Normal mode.

For detailed information on power saving modes, see **Using the Power Saving Modes (page 110)**.

Documentation

Your documentation includes printed information and user guides to read on your VAIO computer.

Printed Documentation

- ❑ **Quick Start Guide** — Describes the process from unpacking to starting up your VAIO.
- ❑ **Troubleshooting and Recovery Guide** — Contains solutions to problems other than those you encounter during normal operation.
- ❑ **Regulations, Guarantee, EULA and Service Support** — Contains Sony guarantee conditions, safety / regulations, modem regulations, wireless LAN regulations, wireless WAN regulations, Bluetooth regulations, end user software license agreement, and Sony support services information.

Non-printed Documentation

- ❑ **User Guide** (this manual) — Explains features of your computer. It also includes information about the software programs included with your computer, as well as information on solving common problems. The **User Guide** is provided in PDF format for easy browsing and printing.

To view this on-screen guide:

- 1 Double-click the **VAIO User Guide** icon on the desktop.
- 2 Open the folder for your language.
- 3 Select the guide you want to read.



You can manually browse to the user guides by going to **Computer > VAIO (C:)** (your C drive) > **Documentation > Documentation** and opening the folder for your language.

To go to web sites described in this manual by clicking their respective URLs beginning with <http://>, your computer must be connected to the Internet.

- ❑ **Specifications** — The online specifications describe the hardware and software configurations of your VAIO computer.

To view the online specifications:

- 1 Connect to the Internet.
- 2 Go to the Sony online support web site at <http://www.vaio-link.com>.



You may have a separate disc that includes documentation for the bundled accessories.

Windows Help and Support

Windows Help and Support is a comprehensive resource for practical advice, tutorials, and demonstrations to help you learn to use your computer.

Use the search feature, index, or table of contents to view all Windows Help resources, including those on the Internet.

To access **Windows Help and Support**, click **Start**  and **Help and Support**. Or go to **Windows Help and Support** by pressing and holding the Microsoft Windows key and pressing the **F1** key.

Further Sources

- Consult the help files included with the software you are using for detailed information on features and troubleshooting.
- Go to <http://www.club-vaio.com> to find online tutorials about your favorite VAIO software.

Ergonomic Considerations

You will be using your computer as a portable device in a variety of environments. Whenever possible, you should attempt to take account of the following ergonomic considerations for both stationary and portable environments:

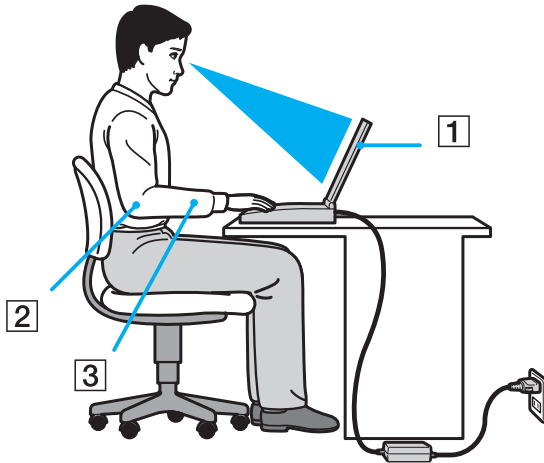

- ❑ **Position of your computer** – Place the computer directly in front of you (1). Keep your forearms horizontal (2), with your wrists in a neutral, comfortable position (3) while using the keyboard, touch pad, or external mouse. Let your upper arms hang naturally at your sides. Take frequent breaks while using your computer. Excessive use of the computer may strain eyes, muscles, or tendons.
- ❑ **Furniture and posture** – Sit in a chair with good back support. Adjust the level of the chair so your feet are flat on the floor. A footrest may make you more comfortable. Sit in a relaxed, upright posture and avoid slouching forward or leaning far backwards.

- ❑ **Viewing angle of the computer's display** – Use the display's tilting feature to find the best position. You can reduce eye strain and muscle fatigue by adjusting the tilt of the display to the proper position. Adjust the brightness level of the display as well.
- ❑ **Lighting** – Choose a location where windows and lights do not cause glare and reflection on the display. Use indirect lighting to avoid bright spots on the display. Proper lighting adds to your comfort and work efficiency.
- ❑ **Positioning an external display** – When using an external display, set the display at a comfortable viewing distance. Make sure the display screen is at eye level or slightly lower when you are sitting in front of the monitor.

Getting Started

This section describes how to get started using your VAIO computer.

- ❑ **Locating Controls and Ports** ([page 15](#))
- ❑ **About the Indicator Lights** ([page 21](#))
- ❑ **Connecting a Power Source** ([page 22](#))
- ❑ **Using the Battery Pack** ([page 23](#))
- ❑ **Shutting Down Your Computer Safely** ([page 30](#))

Locating Controls and Ports

Take a moment to identify the controls and ports shown on the following pages.

Front

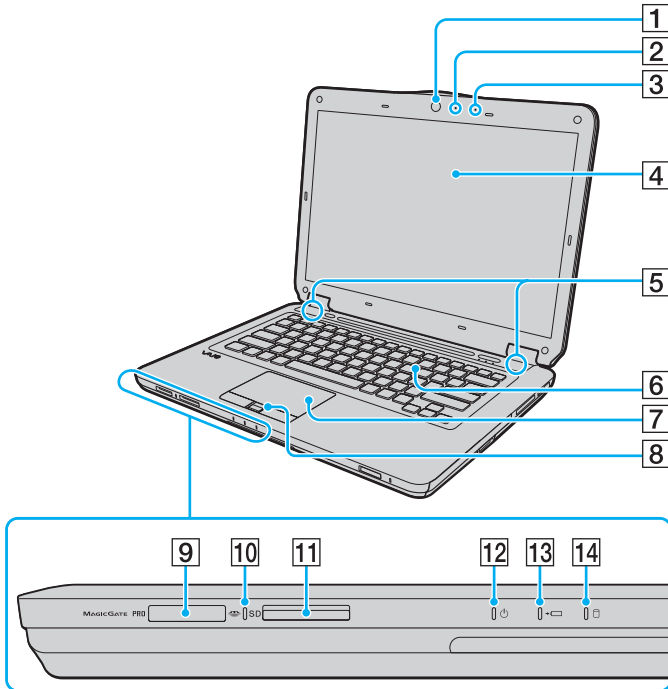

- 1 Built-in **MOTION EYE** camera ([page 39](#))
- 2 Built-in **MOTION EYE** camera indicator ([page 21](#))
- 3 Built-in microphone (monaural)
- 4 LCD screen ([page 127](#))
- 5 Built-in speakers (stereo)
- 6 Keyboard ([page 32](#))
- 7 Touch pad ([page 33](#))
- 8 Fingerprint sensor^{*1} ([page 101](#))
- 9 Memory Stick slot^{*2} ([page 55](#))
- 10 Media Access indicator ([page 21](#))
- 11 **SD** memory card slot ([page 60](#))
- 12 Power indicator ([page 21](#))
- 13 Charge indicator ([page 21](#))
- 14 Hard disk drive/Optical disc drive indicator ([page 21](#))

*1 On selected models only.

*2 Your computer supports both standard- and Duo-size Memory Stick.

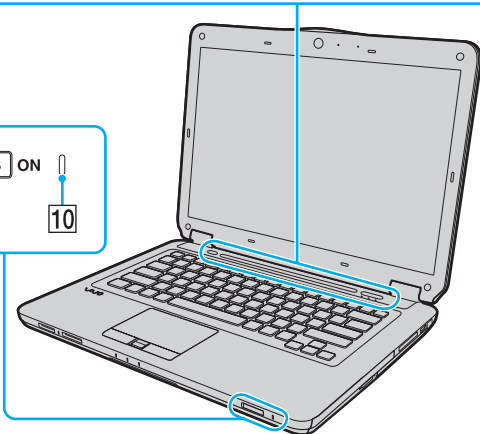
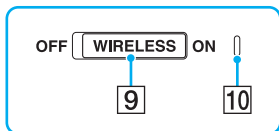
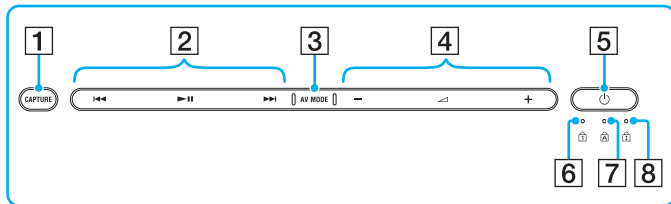

1 CAPTURE button* (page 34)

2 Playback control area*

◀◀: Fast-rewind

▶▶: Play/Pause

▶▶▶: Fast-forward

For information on how to use the touch sensor buttons above, see **Controlling Music and Video Playback** (page 36).

3 AV MODE button* (page 35)

4 Volume control area*

−/+ : Volume

◁ : Muting

For information on how to use the touch sensor buttons above, see **Controlling Music and Video Playback** (page 36).

5 Power button

6 Num lock indicator (page 21)

7 Caps lock indicator (page 21)

8 Scroll lock indicator (page 21)

9 WIRELESS switch (page 64)

10 WIRELESS indicator (page 21)

* On selected models only.

Back

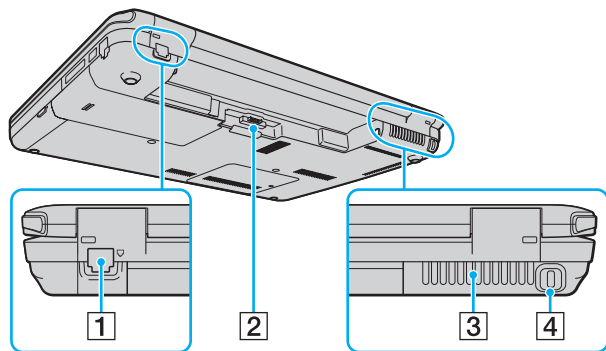

- 1 Modem port ([page 63](#))
- 2 Battery connector ([page 23](#))
- 3 Air vent
- 4 Security slot

Right

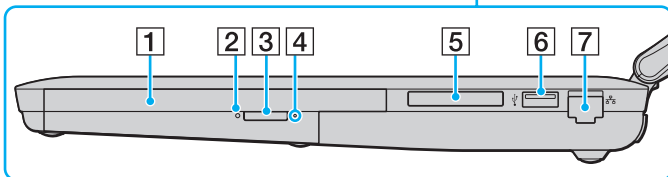
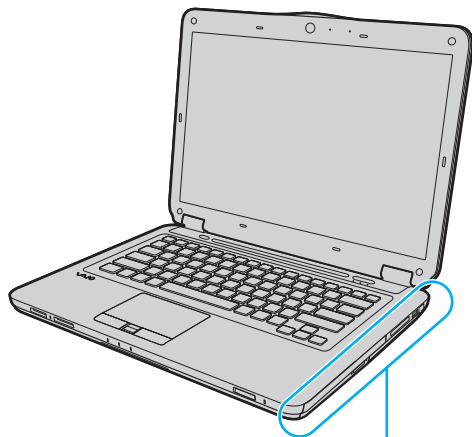

- 1 Optical disc drive ([page 42](#))
- 2 Optical disc drive indicator ([page 21](#))
- 3 Drive eject button ([page 42](#))
- 4 Manual eject hole ([page 164](#))
- 5 ExpressCard/34 slot ([page 51](#))
- 6 Hi-Speed USB (USB 2.0) port* ([page 86](#))
- 7 Network (Ethernet) port ([page 92](#))

* Supports high-/full-/low- speeds.

Left

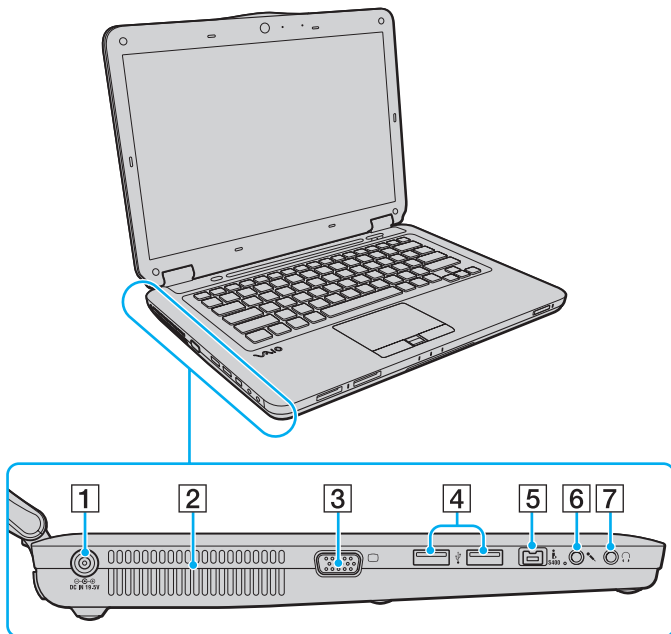

- 1 DC IN port (page 22)
- 2 Air vent
- 3 Monitor port (page 79)
- 4 Hi-Speed USB (USB 2.0) ports* (page 86)
- 5 i.LINK 4-pin (S400) port (page 90)
- 6 Microphone jack (page 85)
- 7 Headphones jack (page 78)

* Support high-/full-/low- speeds.



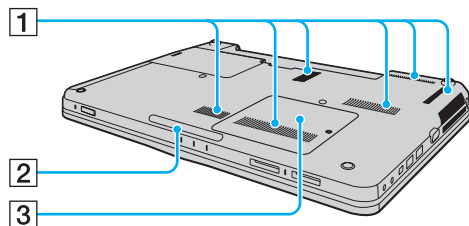



Bottom



- 1 Air vents
- 2 Illumination lamp ([page 109](#))
- 3 Memory module compartment cover ([page 120](#))

About the Indicator Lights

Your computer is equipped with the following indicator lights:

Indicator	Functions
Power 	Illuminates in green when the computer is on, blinks slowly in orange while the computer is in Sleep mode, and turns off when the computer is off or in Hibernate mode.
Charge 	Illuminates while the battery pack is charging. See Charging the Battery Pack (page 26) for more information.
Hard disk drive/Optical disc drive 	Illuminates while the drive is reading or writing data. Do not place the computer into Sleep mode or turn it off when this indicator is lit.
Media Access	Illuminates while data is being read from or written to a memory card. (Do not place the computer into Sleep mode or turn it off when this indicator is lit.) When the indicator is unlit, the memory card is not in use.
Built-in MOTION EYE camera	Illuminates while the built-in MOTION EYE camera is in use.
Optical disc drive	Illuminates while the drive is reading or writing data. When the indicator is unlit, the optical disc media is not in use.
Num lock 	Press the Num Lk key to activate the numeric keypad. Press it a second time to deactivate the numeric keypad. The numeric keypad is not active when the indicator is unlit.
Caps lock 	Press the Caps Lock key to type letters in uppercase. Letters appear in lowercase if you press the Shift key while the indicator is lit. Press the key a second time to turn off the indicator. Normal typing resumes when the Caps lock indicator is unlit.
Scroll lock 	Press the Scr Lk key to change how you scroll the display. Normal scrolling resumes when the Scroll lock indicator is unlit. The Scr Lk key functions differently depending on the program you are using and does not work with all programs.
WIRELESS	Illuminates when the WIRELESS switch is turned on, provided that one or more wireless options are enabled in the VAIO Smart Network window.

Connecting a Power Source

You can use either an AC adapter or a rechargeable battery pack for supplying power to your computer.

Using the AC Adapter



Use only the supplied AC adapter for your computer.

To use the AC adapter

- 1 Plug one end of the power cord (1) into the AC adapter (3).
- 2 Plug the other end of the power cord into an AC outlet (2).
- 3 Plug the cable connected to the AC adapter (3) into the **DC IN** port (4) on the computer.

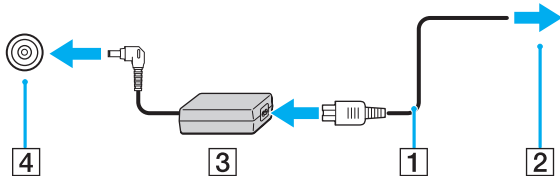

! The shape of the DC In plug varies depending on the AC adapter.



To disconnect your computer completely from AC power, unplug the AC adapter.

Make sure that the AC outlet is easily accessible.

If you do not intend to use your computer for a long period of time, place the computer into Hibernate mode. See **Using Hibernate Mode** (page 113). This power saving mode saves the time of shutting down and resuming.

Using the Battery Pack

The battery pack supplied with your computer is not fully charged at the time of delivery.

Installing the Battery Pack

To install the battery pack

- 1 Turn off the computer and close the LCD screen lid.
- 2 Slide the battery **LOCK** switch (1) inward.

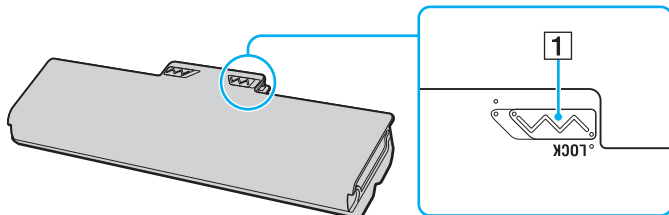

- 3 Slide the battery pack diagonally into the battery compartment until the projections (2) on either side of the battery compartment fit into the U-shaped cuts (3) on either side of the battery pack.

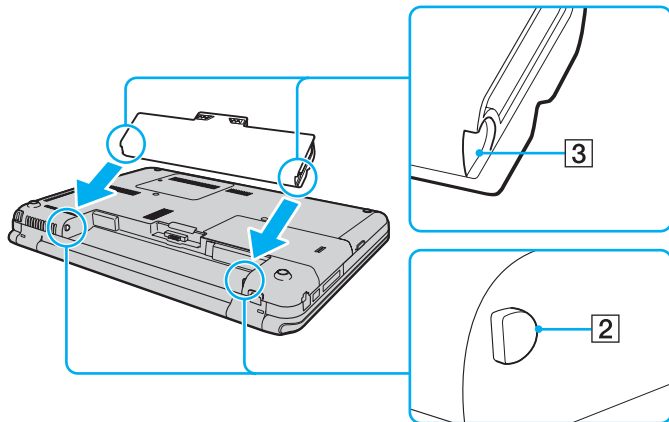

- 4 Rotate the battery pack in the direction of the arrow, and push the battery pack down into the compartment until it clicks into place.

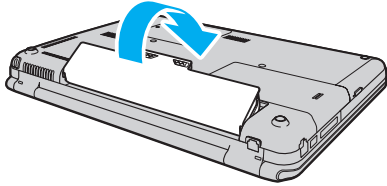

- 5 Slide the battery **LOCK** switch outward to secure the battery pack on the computer.



When your computer is directly connected to AC power and has a battery pack installed, it uses power from the AC outlet.



Certain rechargeable batteries do not meet Sony quality and safety standards. For safety reasons this computer only functions with genuine Sony battery packs designed for this model. If an unauthorized battery pack is installed, the battery will not be charged and the computer will not function.

Charging the Battery Pack

The battery pack supplied with your computer is not fully charged at the time of delivery.

To charge the battery pack

1 Install the battery pack.

2 Connect the AC adapter to the computer.

The charge indicator light turns on while the battery pack is charging. When the battery pack charges close to the maximum charge level you selected with the battery charge functions, the charge indicator turns off. To select your desired maximum charge level, see **Using the Battery Charge Functions (page 28)**.

Charge indicator status	Meaning
Lit in orange	The battery pack is charging.
Blinks along with the green power indicator	The battery pack is running out of power. (Normal mode)
Blinks along with the orange power indicator	The battery pack is running out of power. (Sleep mode)
Blinks fast in orange	A battery error has occurred due to a failed battery pack or an unlocked battery pack.

! Charge the battery pack as described in this manual from your first battery charge.



Keep the battery pack in your computer while it is directly connected to AC power. The battery pack continues to charge while you are using the computer.

If the battery charge level falls below 10%, you should either connect the AC adapter to recharge the battery pack or shut down your computer and install a fully charged battery pack.

Your computer is supplied with a lithium ion battery pack and can be recharged any time. Charging a partially discharged battery pack does not affect the battery life.

While some software applications or peripheral devices are in use, your computer may not enter Hibernate mode even when battery life is low. To avoid loss of data when using battery power, you should save your data frequently and manually activate a power management mode, such as Sleep or Hibernate.

If the battery pack wears out when the computer enters Sleep mode, you will lose all unsaved data. Going back to the previous work state is impossible. To avoid loss of data, you should save your data frequently.

When your computer is directly connected to AC power and has a battery pack installed, it uses power from the AC outlet.

Using the Battery Charge Functions

You can select the battery charging method for your battery pack with the **Battery Charge Functions**. To make the battery life longer, enable the battery care function.

To enable the battery care function

- 1 Click **Start**, **All Programs**, and **VAIO Control Center**.
- 2 Click **Power Management** and then **Battery Charge Functions**.
- 3 Click to select the **Enable Battery Care Function** check box in the right pane.
- 4 Click **Advanced**.
- 5 Select the desired maximum charge level.
- 6 Click **OK**.

To check the battery wear level

Follow steps 1 to 4 in **To enable the battery care function** above and check detailed information. If the battery wear level is high, replace the battery pack with a new genuine Sony battery pack.

Removing the Battery Pack

! You may lose data if you remove the battery pack while your computer is on and not connected to the AC adapter or if you remove the battery pack while the computer is in Sleep mode.

To remove the battery pack

- 1 Turn off the computer and close the LCD screen lid.
- 2 Slide the battery **LOCK** switch (1) inward.
- 3 Slide and hold the battery **RELEASE** latch (2) inward, put your fingertip underneath the tab (3) on the battery pack, and turn the battery pack in the direction of the arrow, and then slide it away from the computer.

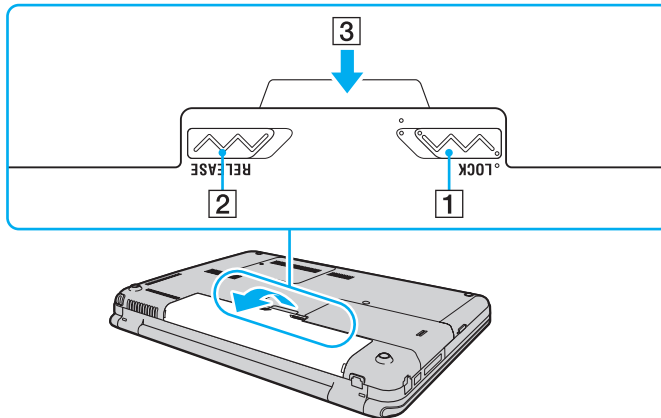

Shutting Down Your Computer Safely

To avoid losing unsaved data, be sure to shut down your computer properly, as described below.

To shut down your computer

- 1 Turn off any peripherals connected to the computer.
- 2 Click **Start**, the arrow  next to the **Lock** button, and then **Shut Down**.
- 3 Respond to any prompts warning you to save documents or to consider other users and wait for the computer to turn off automatically.
The power indicator light turns off.

Using Your VAIO Computer

This section describes how to get the most out of using your VAIO computer.

- ❑ **Using the Keyboard** ([page 32](#))
- ❑ **Using the Touch Pad** ([page 33](#))
- ❑ **Using the Special-function Button** ([page 34](#))
- ❑ **Using the Touch Sensor Buttons** ([page 35](#))
- ❑ **Using the Built-in MOTION EYE Camera** ([page 39](#))
- ❑ **Using the Optical Disc Drive** ([page 42](#))
- ❑ **Using the ExpressCard Module** ([page 51](#))
- ❑ **Using the Memory Stick** ([page 55](#))
- ❑ **Using the SD Memory Card** ([page 60](#))
- ❑ **Using the Internet** ([page 63](#))
- ❑ **Using Wireless LAN (WLAN)** ([page 64](#))
- ❑ **Using the Bluetooth Function** ([page 71](#))









Using the Keyboard

Your keyboard is very similar to a desktop computer keyboard, but has additional keys that perform model-specific tasks. The VAIO-Link web site (<http://www.vaio-link.com>) also contains glossary information to help you use the keyboard.

Combinations and Functions with the Fn Key



Some keyboard functions can be used only after the operating system is finished launching.

Combinations/Feature	Functions
Fn +  (F2): speaker switch	Turns on and off the built-in speakers and the headphones.
Fn +  (F3/F4): speaker volume	Changes the volume level. To increase the volume, keep pressing Fn+F4 or press Fn+F4 and then ↑ or → . To decrease the volume, keep pressing Fn+F3 or press Fn+F3 and then ↓ or ← .
Fn +  (F5/F6): brightness control	Changes the LCD brightness of your computer screen. To increase lighting intensity, keep pressing Fn+F6 or press Fn+F6 and then ↑ or → . To decrease lighting intensity, keep pressing Fn+F5 or press Fn+F5 and then ↓ or ← .
Fn +  /  (F7): display output	Toggles among your computer screen, an external display, and simultaneous output to both.
Fn +  /  (F9/F10): zoom	Changes the view size of your screen. To make the screen view look smaller and further away (zoom out), press Fn+F9 . To make the screen view look bigger and closer (zoom in), press Fn+F10 . See the help file included with the VAIO Control Center for more information.
Fn +  (F12): hibernate	Provides the lowest level of power consumption. When you execute this command, the states of the system and the connected peripheral devices are saved to the hard disk drive and the system power is turned off. To return the system to its original state, use the power button to turn on the power. For details on power management, see Using the Power Saving Modes (page 110).

Using the Touch Pad

You can point to, select, drag, and scroll objects on the screen using the touch pad.

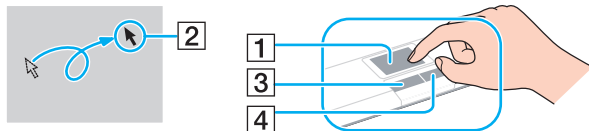

Action	Description
Point	Slide your finger on the touch pad (1) to place the pointer (2) on an item or object.
Click	Press the left button (3) once.
Double-click	Press the left button twice.
Right-click	Press the right button (4) once. In many applications, this action displays a shortcut menu.
Drag	Slide your finger on the touch pad while pressing the left button.
Scroll	Slide your finger along the right edge of the touch pad to scroll vertically. Slide your finger along the bottom edge to scroll horizontally (the scroll function is available only with applications that support a touch pad scroll feature).



You can disable/enable the touch pad while a mouse is connected to your computer. To change the touch pad settings, click **Start, All Programs, VAIO Control Center, Keyboard and Mouse** and **Pointing Device**.



Be sure to connect a mouse before disabling the touch pad. If you disable the touch pad without connecting a mouse, you will be able to use only the keyboard for pointer operations.

Using the Special-function Button

Your computer may be equipped with a special button to help you use specific functions of the computer.

See the online specifications to find out whether your computer is equipped with the special button.

Special-function button	Functions
CAPTURE button 	Launches the WebCam Companion 2 and captures still images and movies with the built-in MOTION EYE camera. For more information on the WebCam Companion 2 , see the help file included with the software.

Using the Touch Sensor Buttons

Your computer may be equipped with the touch sensor buttons. You can control music and video playback or adjust the playback volume by pressing the button or swiping your fingertip over the playback control area or the volume control area. The built-in lamps underneath the touch sensor buttons illuminate according to operations you perform with the buttons. See the online specifications to find out whether your computer is equipped with the touch sensor buttons.



Some operations with the touch sensor buttons may not be available depending on the software you use.

Using the AV MODE Button

You can launch the **VAIO Launcher** with the **AV MODE** button. In the **VAIO Launcher**, you can select and launch your desired software for music or video playback with other touch sensor buttons.

To launch the VAIO Launcher

Press the **AV MODE** button on the touch sensor.

To select and launch the software for music or video playback

Press or press and hold ►► or ◀◀ to select your desired software, and then press ►||.





You can also select your desired software by swiping your fingertip over the playback control area.

You can change the default software options in the **VAIO Launcher**. To do so, press and hold the **AV MODE** button to display the setup window.

Controlling Music and Video Playback

You can use the software you launched with the **VAIO Launcher**, for example the **Windows Media Center**, for music or video playback, and control playback or adjust the playback volume with the touch sensor buttons.





To control music and video playback

To	Actions
Play	Press ▶ .
Pause	Press ▶ during playback. Press again to resume playback.
Stop	Press and hold ▶ during playback.
Fast-forward	Press and hold ▶▶ during playback.
Skip to the beginning of the next track or chapter	Press ▶▶ during playback.
	Swipe your fingertip to the right over the playback control area during playback. 
Fast-rewind	Press and hold ◀◀ during playback.
Skip to the beginning of the current track or chapter	Press ◀◀ during playback.
	Swipe your fingertip to the left over the playback control area during playback. 



You can start swiping from anywhere on the playback control area to control music and video playback.

To adjust the playback volume

To	Actions
Increase the volume	Press + .
Keep increasing the volume	Press and hold + .
	Swipe your fingertip to the right over the volume control area. 
Decrease the volume	Press - .
Keep decreasing the volume	Press and hold - .
	Swipe your fingertip to the left over the volume control area. 
Turn off the volume	Press  twice.
Restore the volume	Press  twice when the volume is turned off.
	Press + or - , or swipe your fingertip over the volume control area.



You can start swiping from anywhere on the volume control area to adjust the playback volume.

Using the Built-in MOTION EYE Camera

Your computer is equipped with a built-in **MOTION EYE** camera.

The built-in **MOTION EYE** camera adds video functionality to instant messaging software and video editing software and enables you to capture still images and movies with the preinstalled image capture software.

Turning on the computer activates the built-in **MOTION EYE** camera. Video conference is possible with the appropriate software.

Note that launching or exiting your instant messaging or video editing software does not activate or deactivate the built-in **MOTION EYE** camera, respectively.



The built-in **MOTION EYE** camera cannot be shared by more than one software application. If another software application is using the camera, exit the application before using the built-in **MOTION EYE** camera with your desired application.



The viewer window may show some noise, for example horizontal streaks, if you view a rapid-moving object. This is normal and does not indicate a malfunction.

You cannot operate the built-in **MOTION EYE** camera with the **Microsoft Windows Movie Maker** software.

Capturing Still Images

To capture a still image

- 1 Press the **CAPTURE** button on your computer or click **Start, All Programs, ArcSoft WebCam Companion 2**, and **WebCam Companion 2** to launch the **WebCam Companion 2**.
- 2 Click the **Capture** icon in the main window.
- 3 Frame your subject in the viewfinder.
- 4 Press the **CAPTURE** button on your computer or click the **Capture** button below the displayed image.
The current image in the viewfinder is captured and its thumbnail image is added as a thumbnail in the left pane of the main window.



When capturing an image in a dark place, click the **WebCam Settings** icon after step 2 and select the low light or low light compensation option in the properties window.

The **WebCam Companion 2** provides many more features. See the help file included with the software for more information.

Capturing Movies

To capture a movie

- 1 Press the **CAPTURE** button on your computer or click **Start, All Programs, ArcSoft WebCam Companion 2**, and **WebCam Companion 2** to launch the **WebCam Companion 2**.
- 2 Click the **Record** icon in the main window.
- 3 Frame your subject in the viewfinder.
- 4 Press the **CAPTURE** button on your computer or click the **Record Video** button below the displayed image to start movie recording.
- 5 When finished, press the **CAPTURE** button or click the **Record Video** button once again to stop movie recording. The first scene of the captured movie is added as a thumbnail in the left pane of the main window.



When capturing a movie in a dark place, click the **WebCam Settings** icon after step 2 and select the low light or low light compensation option in the properties window.

The **WebCam Companion 2** provides many more features. See the help file included with the software for more information.

Using the Optical Disc Drive

Your computer is equipped with an optical disc drive.

To insert a disc

- 1 Turn on the computer.
- 2 Press the drive eject button (1) to open the drive.
The tray slides out.
- 3 Place a disc in the middle of the tray with the label side facing upward and gently push it down until the disc clicks into place.

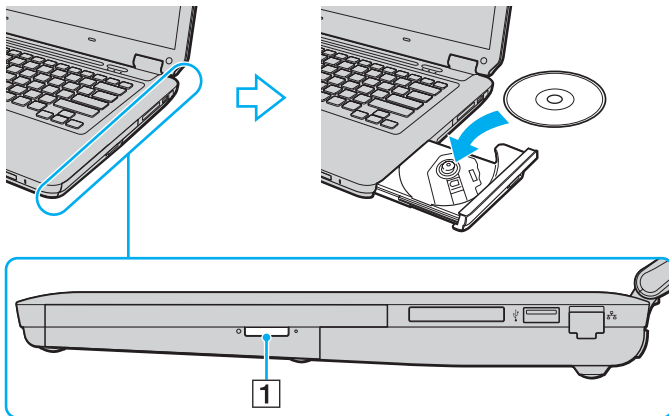

4 Close the tray by pushing it in gently.



Do not remove the optical disc when your computer is in a power saving mode (Sleep or Hibernate). Doing so may cause the computer to malfunction.



If you plan to use an external optical disc drive, connect the drive before you launch any preinstalled disc operation program.

Reading and Writing Optical Discs

Your computer plays and records CDs, DVDs, and Blu-ray Disc™ media, depending on the model you purchased. Check your specifications for the type of optical disc drive installed on your model.

Use the table below to see which types of media your optical disc drive supports.

PR: playable and recordable
 P: playable but not recordable
 -: not playable or recordable

	CD-ROM	Video CD	Music CD	CD Extra	CD-R/RW	DVD-ROM	DVD-Video	BD-ROM	DVD-R/RW	DVD+R/RW	DVD+R DL	DVD-R DL	DVD-RAM	BD-R ^{*9} /RE ^{*10}
DVD±RW/±R DL/RAM	P	P	P	P	PR	P	P	-	PR ^{*1} *2	PR	PR ^{*5}	PR ^{*6}	PR ^{*3} *4	-
Blu-ray Disc Combo	P	P	P	P	PR ^{*8}	P	P	P	PR ^{*1} *2	PR	PR ^{*5}	PR ^{*6}	PR ^{*3} *4	P ^{*11} *12
Blu-ray Disc	P	P	P	P	PR ^{*8}	P	P	P	PR ^{*1} *2	PR	PR ^{*5}	PR ^{*6}	PR ^{*3} *4	PR ^{*7} *11 *12

*1 Supports writing data to DVD-R discs compliant with DVD-R for General Version 2.0/2.1.

*2 Supports writing data to DVD-RW discs compliant with DVD-RW Version 1.1/1.2.

*3 The DVD±RW/RAM disc drive on your computer does not support the DVD-RAM cartridge. Use non-cartridge discs or discs with a removable cartridge.

*4 Writing data to single-sided DVD-RAM discs (2.6 GB) compliant with DVD-RAM Version 1.0 is not supported. DVD-RAM Version 2.2/12X-SPEED DVD-RAM Revision 5.0 disc is not supported.

*5 Writing data to DVD+R DL (Double Layer) discs is available only on discs supporting DVD+R DL (Double Layer) recording.

*6 Writing data to DVD-R DL (Dual Layer) discs is available only on discs supporting DVD-R DL (Dual Layer) recording.

*7 Supports writing data to BD-R Version 1.1 discs (single-layer discs with the capacity of 25 GB, dual-layer discs with the capacity of 50 GB) and BD-RE Version 2.1 discs (single-layer discs with the capacity of 25 GB, dual-layer discs with the capacity of 50 GB).

*8 Writing data to Ultra Speed CD-RW discs is not supported on the models with certain types of the Blu-ray Disc drive.

*9 BD-R stands for Blu-ray Disc-Recordable in Version 1.1 format.

*10 BD-RE stands for Blu-ray Disc-Rewritable in Version 2.1 format.

*11 The Blu-ray Disc drive on your computer does not support BD-RE Disc media in Version 1.0 format and Blu-ray Disc media with a cartridge.

*12 Playback of BD-R LTH TYPE media is supported only on the models with the Blu-ray Disc drive.

! This product is designed to play back discs that conform to the Compact Disc Digital Audio standard specifications (CD Standard). A DualDisc is a two sided disc product with a DVD recorded layer on one side and a digital audio layer on the other side. Be aware that the audio side (non-DVD side) of a DualDisc may not play on this product because it does not conform to the CD Standard.

When you buy pre-recorded or blank discs for use with your VAIO computer, be sure to read the notices on the disc package carefully to check both playback and recording compatibility with your computer's optical disc drives. Sony does NOT guarantee the compatibility of VAIO optical disc drives with discs that are not compliant with the official "CD," "DVD," or "Blu-ray Disc" standard. USING NON-COMPLIANT DISCS CAN CAUSE FATAL DAMAGE TO YOUR VAIO PC OR CREATE SOFTWARE CONFLICTS AND CAUSE SYSTEM HANGING.

For inquiries about disc formats, contact the individual publisher of the pre-recorded disc or the manufacturer of the recordable disc.



8 cm disc writing is not supported.

! To play copyright protected Blu-ray Disc media continuously, you need to update the AACS key. Note that the AACS key update requires Internet access.

As with other optical media devices, circumstances may limit compatibility or prevent Blu-ray Disc media playback. VAIO computers may not support movie playback on packaged media recorded in AVC or VC1 format at high bit rates.

Region settings are required for some contents on DVDs and BD-ROM Disc media. If the region setting on the optical disc drive does not match the region coding on the disc, playback is not possible.

Unless your external display is compliant with the High-bandwidth Digital Content Protection (HDCP) standard, you cannot play or view the contents on copyright protected Blu-ray Disc media.

Some contents may restrict video output to standard definition or prohibit analog video output. It is strongly recommended that a digital HDCP-compliant environment be implemented for optimum compatibility and viewing quality.

Notes on writing data to a disc

- ❑ Only use circular discs. Do not use discs in any other shape (star, heart, card, etc.), as this may damage the optical disc drive.
- ❑ Do not strike or shake your computer while the optical disc drive is writing data to a disc.
- ❑ Do not use memory-resident utility software while the optical disc drive is writing data to a disc. This may cause your computer to malfunction.
- ❑ Do not plug or unplug the AC adapter while the optical disc drive is writing data to a disc.

Notes on playing discs

To achieve optimum performance when playing discs, you should follow these recommendations.

- ❑ Some CD players and computer optical disc drives may not be able to play audio CDs created with the CD-R or CD-RW media.
- ❑ Some DVD players and computer optical disc drives may not be able to play DVDs created with the DVD+R DL, DVD-R DL, DVD+R, DVD+RW, DVD-R, DVD-RW, or DVD-RAM media.
- ❑ Do not place your computer into either of the power saving modes while your computer is playing a disc.
- ❑ Region code indicators are labeled on the discs or packages to indicate in which region and on what type of player you can play the disc. Unless the region code indicates "2" (Europe belongs to region "2") or "all" (this means that you can play this disc in most regions of the world), you cannot play the disc on your computer.



If you change the region code while the **WinDVD** or **WinDVD BD** software is running, restart the software or eject the disc and re-insert it to make the new setting effective.

- ❑ Do not try to change the region code settings of the drive. Any difficulties caused by changing the region code settings of the drive are not covered by the warranty.

Playing CDs

To play an audio CD

- 1 Insert a disc into the optical disc drive.
- 2 If nothing appears on the desktop, click **Start, All Programs**, and the desired CD software to play the CD.
If the **Audio CD** window appears, click to select an option.

Copying Files to CDs

To copy files to a disc

- 1 Insert a disc into the optical disc drive.
If the **AutoPlay** window appears, click **Burn files to disc** and follow the on-screen instructions until the empty disc folder appears.
- 2 Open the folder that contains the file(s) you want to copy and drag them to the empty disc folder.
- 3 Close the disc folder.

Playing DVDs

To play a DVD

- 1 Close all running software applications.
- 2 Insert a DVD into the optical disc drive.
- 3 If nothing appears on the desktop, click **Start, All Programs**, and the desired DVD software to play the DVD.

For instructions on how to use the software, see the help file included with your DVD software.

Copying Files to DVDs

To copy files to a disc

- 1 Connect the AC adapter to the computer.
- 2 Close all running software applications.
- 3 Insert a disc into the optical disc drive.
- 4 If nothing appears on the desktop, click **Start, All Programs**, and the desired DVD burning software to copy files to the disc.

For instructions on how to use the software, see the help file included with your DVD burning software.

Playing Blu-ray Disc Media

! The Blu-ray Disc playback function is available on selected models only. See the online specifications to find out the type of your optical disc drive, and then **Reading and Writing Optical Discs (page 44)** to find out about the supported disc media.

To play a Blu-ray Disc media

- 1 Close all running software applications.
- 2 Insert a Blu-ray Disc media into the optical disc drive.
- 3 If nothing appears on the desktop, click **Start, All Programs**, and the desired Blu-ray Disc software to play the disc.

For instructions on how to use the software, see the help file included with your software.

Using the ExpressCard Module

Your computer is equipped with either a Universal ExpressCard slot* or an ExpressCard/34 slot* for transferring data among digital cameras, camcorders, music players, and other audio/video devices. The former can accommodate either an ExpressCard/34 (34 mm wide) or ExpressCard/54 (54 mm wide) module* as shown below and the latter can accommodate only an ExpressCard/34 module* only.

- ExpressCard/34 module*



- ExpressCard/54 module*



Your computer is equipped with an ExpressCard/34 slot*.

* Referred to as the ExpressCard slot and the ExpressCard module in this manual.

Inserting an ExpressCard Module

! Your computer is supplied with a slot protector in the ExpressCard slot. Remove the slot protector before you use the slot.

Use care when inserting or removing the ExpressCard module from the slot. Do not force it in or out of the slot.



You do not need to shut down your computer before inserting or removing the ExpressCard module.

To insert an ExpressCard module

- 1 Locate the ExpressCard slot.
- 2 Push the ExpressCard slot protector so that the protector pops out.
- 3 Gently take hold of the ExpressCard slot protector and pull it out of the slot.
- 4 Hold the ExpressCard module with the arrow facing upward and pointing toward the slot.
- 5 Carefully slide the ExpressCard module into the slot until it clicks into place.
Do not force it into the slot.

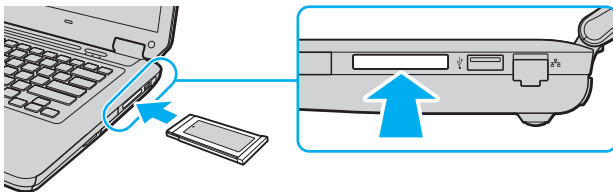

! Insert the ExpressCard slot protector to block any particles from entering the slot when not using an ExpressCard module. Before moving your computer, be sure to insert the ExpressCard slot protector into the slot.



If the module does not go into the slot easily, remove it gently and verify you are inserting it in the proper direction.

Make sure you use the most recent software driver provided by the ExpressCard module manufacturer.

Removing an ExpressCard Module

Follow the steps below to remove the ExpressCard module while your computer is on. If it is not removed properly, your system may not work properly.

To remove an ExpressCard module



To remove an ExpressCard module when your computer is off, skip steps 1 to 4.

- 1 Double-click the **Safely Remove Hardware** icon on the taskbar.
- 2 Select the hardware you want to unplug.
- 3 Click **Stop**.
- 4 Follow the on-screen instructions to remove the ExpressCard module.
- 5 Push in the ExpressCard module toward the computer so that the module pops out.
- 6 Gently take hold of the ExpressCard module and pull it out of the slot.

Using the Memory Stick

Memory Stick is a compact, portable, and versatile IC recording media especially designed for exchanging and sharing digital data with compatible products, such as digital cameras, mobile phones, and other devices. Because it is removable, it can be used for external data storage.

Before You Use the Memory Stick

The Memory Stick slot on your computer can accommodate both standard- and Duo-size media and supports Memory Stick PRO and Memory Stick PRO-HG Duo formats with high speed data transfer and large data capacity capabilities.



You can insert a Duo-size Memory Stick directly into the Memory Stick slot without using a Memory Stick Duo adaptor.



Before using a Memory Stick Micro (M2), be sure to insert it into an M2 Standard-size adaptor or M2 Duo adaptor. If you insert the media directly into the Memory Stick slot without the adaptor, you may not be able to remove it from the slot.

For the latest information about the Memory Stick, visit the Memory Stick web site at <http://www.memorystick.com/en/>.



Your computer has been tested and found compatible with Sony branded Memory Stick with capacity of up to 16 GB that are available as of May 2008. However, not all Memory Stick that meet the same specifications as the compatible media are guaranteed of compatibility.

Inserting a Memory Stick with multiple conversion adapters is not guaranteed of compatibility.

MagicGate is the general name of the copyright protection technology developed by Sony. Use a Memory Stick with the MagicGate logo to use this feature.

Except for your personal use, it is against the copyright law to use any audio and/or image data you recorded without prior consent from the respective copyright holders. Accordingly, the Memory Stick with such copyrighted data can be used only within the law.

The Memory Stick slot on your computer does not support 8-bit parallel data transfer (high speed data transfer).

The Memory Stick Micro in an M2 Duo adaptor may not operate properly if it is additionally inserted into a Memory Stick Duo adaptor.

Inserting a Memory Stick

To insert a Memory Stick

- 1 Locate the Memory Stick slot.
- 2 Hold the Memory Stick with the arrow facing upward and pointing toward the slot.
- 3 Carefully slide the Memory Stick into the slot until it clicks into place.
The Memory Stick is automatically detected by your system and the contents on the Memory Stick are displayed. If nothing appears on the desktop, click **Start, Computer**, and double-click the Memory Stick icon.

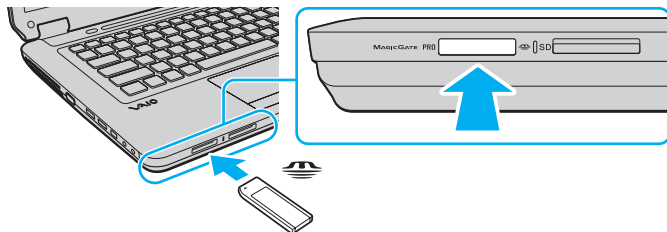

! Be sure to hold the Memory Stick with the arrow pointing in the correct direction as you insert it into the slot. To avoid damaging your computer or the Memory Stick, do not force the Memory Stick into the slot if you cannot insert it smoothly.

Do not insert more than one Memory Stick into the slot. Improper insertion of the media may damage both your computer and the media.

To view the contents on the Memory Stick

- 1 Click **Start** and **Computer** to open the **Computer** window.
- 2 Double-click the Memory Stick icon to view the list of data files saved in the Memory Stick.

To format a Memory Stick

The Memory Stick has been formatted in the factory default setting and is ready for use.

If you want to reformat the media with your computer, follow these steps.

! Be sure to use the device that is designed to format the media and supports the Memory Stick when formatting the media.

Formatting the Memory Stick erases the entire data on the media. Before formatting the media, make sure that it does not contain your valuable data.

Do not remove the Memory Stick from the slot while formatting. This could cause a malfunction.

- 1 Carefully slide the Memory Stick into the slot until it clicks into place.
- 2 Click **Start** and **Computer** to open the **Computer** window.
- 3 Right-click the Memory Stick icon and select **Format**.
- 4 Click **Restore device defaults**.

! The size of the allocation unit and file system may change.

Do not select **NTFS** from the **File system** drop-down list as it may cause a malfunction.



The formatting process will be completed more quickly if you select **Quick Format** in **Format options**.

- 5 Click **Start**.
- 6 Follow the on-screen instructions.

! It may take time to format the Memory Stick depending on the media type.

Removing a Memory Stick

! Do not remove the Memory Stick while the Media Access indicator light is lit. If you do, you may lose data. Large volumes of data may take time to load, so make sure the indicator is unlit before removing the Memory Stick.

To remove a Memory Stick

- 1** Check that the Media Access indicator light is unlit.
- 2** Push in the Memory Stick toward the computer and release. The Memory Stick ejects.
- 3** Pull the Memory Stick out of the slot.

! Always remove the Memory Stick gently, or it may pop out unexpectedly.

Using the SD Memory Card

Your computer is equipped with an **SD** memory card slot. You can use this slot to transfer data among digital cameras, camcorders, music players, and other audio/video devices.

Before You Use the SD Memory Card

The **SD** memory card slot on your computer supports the following memory cards:

- SD memory card
- SDHC memory card
- MultiMediaCard (MMC)

For the latest information on compatible memory cards, see **Sony Support Information (page 185)** to visit the appropriate support web site.



Your computer has been tested and found compatible only with major memory cards available as of May 2008. However, not all memory cards that meet the same specifications as the compatible media are guaranteed of compatibility.

Always insert the correct memory card into the **SD** memory card slot.

SD memory cards with capacity of up to 2 GB and SDHC memory cards with capacity of up to 32 GB have been tested and found compatible with your computer.

The **SD** memory card slot on your computer does not support the high-speed data transfer feature of the SD memory card and the SDHC memory card.

Do not attempt to insert an SD memory card or SD memory card adapter of a different type into the **SD** memory card slot. An incompatible memory card or memory card adapter may cause difficulty in removing from the slot and can cause damage to your computer.

Use care when inserting or removing an SD memory card from the **SD** memory card slot. Do not force the SD memory card in or out of the slot.

Inserting an SD Memory Card

To insert an SD memory card

- 1 Locate the **SD** memory card slot.
- 2 Hold the SD memory card with the arrow facing upward and pointing toward the slot.

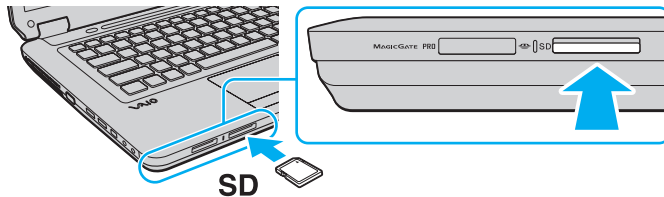

- 3 Carefully slide the SD memory card into the slot until it clicks into place.
Do not force the card into the slot.



If the SD memory card does not go into the slot easily, remove it gently and verify you are inserting it in the proper direction.

Removing an SD Memory Card

! Do not remove an SD memory card while the Media Access indicator light is lit. If you do, the card or its data may become damaged.

To remove an SD memory card

- 1 Check that the Media Access indicator light is unlit.
- 2 Push in the SD memory card toward the computer and release.
The SD memory card ejects.
- 3 Pull the SD memory card out of the slot.

Using the Internet

Setting Up a Dial-up Internet Connection

Before you can connect to the Internet, you need to connect your computer to a telephone line with a telephone cable (not supplied) and have an account with an Internet Service Provider (ISP).

To connect a telephone cable

- 1 Plug one end of the phone cable (1) into the modem port  on the computer.
- 2 Plug the other end into the wall jack (2).

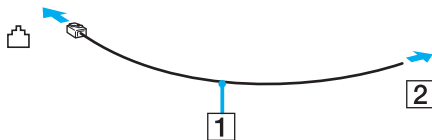

Your computer does not work with party lines, cannot be connected to a coin-operated telephone, and may not work with multiple telephone lines or a private branch exchange (PBX). Some of these connections may result in excess electrical current and could cause a malfunction in the internal modem.

If you connect a telephone cable coming through a splitter, the modem or connected device may not work properly.

To set up a dial-up connection to the Internet

- 1 Click **Start** and **Control Panel**.
- 2 Click **Connect to the Internet** under **Network and Internet**.
The **Connect to the Internet** window appears.
- 3 Click **Dial-up**.
- 4 Follow the on-screen instructions.

Using Wireless LAN (WLAN)

Using the Sony Wireless LAN (WLAN), all your digital devices with built-in WLAN function communicate freely with each other through a network. A WLAN is a network in which a user can connect to a Local Area Network (LAN) through a wireless (radio) connection. This eliminates the need to pull cables or wires through walls and ceilings.

The Sony WLAN supports all normal Ethernet connectivity, but with the added benefits of mobility and roaming. You can still access information, Internet/intranet and network resources, even in the middle of a meeting, or as you move from one place to another.

You can communicate without an access point, which means that you can communicate with a limited number of computers (ad-hoc). Or you can communicate through an access point, which allows you to create a full infrastructure network.



In some countries, using WLAN products may be restricted by the local regulations (e.g. limited number of channels). Therefore, before activating the WLAN function, read the wireless LAN regulations guide carefully.

WLAN uses the IEEE 802.11a^{*}/b/g standard or the IEEE 802.11n^{*} draft standard, which specifies the used technology. The standard includes the encryption methods: Wired Equivalent Privacy (WEP), which is a security protocol, Wi-Fi Protected Access 2 (WPA2), and Wi-Fi Protected Access (WPA). Proposed jointly by the IEEE and Wi-Fi Alliance, both WPA2 and WPA are specifications of standards based on interoperable security enhancements that increase the level of data protection and access control for existing Wi-Fi networks. WPA has been designed to be forward compatible with the IEEE 802.11i specification. It utilizes the enhanced data encryption TKIP (Temporal Key Integrity Protocol) in addition to user authentication using 802.1X and EAP (Extensible Authentication Protocol). Data encryption protects the vulnerable wireless link between clients and access points. Besides that, there are other typical LAN security mechanisms to ensure privacy, such as: password protection, end-to-end encryption, virtual private networks, and authentication. WPA2, the second generation of WPA, provides stronger data protection and network access control and is also designed to secure all versions of 802.11 devices, including 802.11b, 802.11a, 802.11g, and 802.11n draft standard, multi-band and multi-mode. In addition, based on the ratified IEEE 802.11i standard, WPA2 provides government grade security by implementing the National Institute of Standards and Technology (NIST) FIPS 140-2 compliant AES encryption algorithm and 802.1X-based authentication. WPA2 is backward compatible with WPA.

* See the online specifications to find out whether your model supports the IEEE 802.11a standard and/or the IEEE 802.11n draft standard.

The IEEE 802.11b/g standard is a wireless LAN standard, using the 2.4 GHz bandwidth. The IEEE 802.11g standard provides high-speed communications, faster than the IEEE 802.11b standard.

The IEEE 802.11a standard is a wireless LAN standard, using the 5 GHz bandwidth.

The IEEE 802.11n draft standard is a wireless LAN standard, using the 2.4 or 5 GHz bandwidth.

Wireless LAN devices using the 2.4 GHz bandwidth cannot communicate with devices using the 5 GHz bandwidth because the frequencies are different.

The 2.4 GHz bandwidth used by wireless LAN compatible devices is also used by other various devices. Although technologies to minimize interference from other devices that use the same bandwidth are employed on wireless LAN compatible devices, such interference may cause lower communication speed, narrower communication range, or broken wireless connections.

The communication speed varies depending on the distance between communication devices, existence of obstacles between such devices, the device configuration, the radio conditions, and the software in use. In addition, communications may be cut off depending on the radio conditions.

The communication range varies depending on the actual distance between communication devices, existence of obstacles between such devices, the radio conditions, the ambient environment that includes existence of walls and materials of such walls, and the software in use.

Actual communication speed may not be as fast as the one displayed on your computer.

Deploying IEEE 802.11b and IEEE 802.11g products on the same wireless network may reduce the communication speed due to radio interference. Taking this into consideration, the IEEE 802.11g products are designed to reduce the communication speed to ensure communications with IEEE 802.11b products. When the communication speed is not as fast as expected, changing the wireless channel on the access point may increase the communication speed.

Communicating without an Access Point (Ad-hoc)

An ad-hoc network is a network in which a LAN is created only by the wireless devices themselves, with no other central controller or access point. Each device communicates directly with other devices in the network. You can set up an ad-hoc network easily at home.

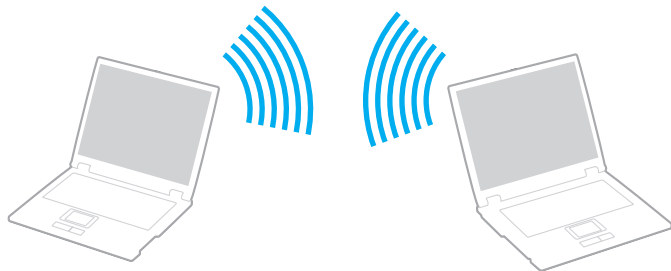

To communicate without an access point (ad-hoc)



You cannot select the 5 GHz bandwidth, which is used for the IEEE 802.11a standard, on ad-hoc networks.

The IEEE 802.11n draft standard, using the 2.4 or 5 GHz bandwidth, is not available on ad-hoc networks.

- 1 Turn on the **WIRELESS** switch.
- 2 Click the button next to or above your desired wireless option(s) in the **VAIO Smart Network** window. Make sure the **WIRELESS** indicator light turns on.
- 3 Click **Start** and **Control Panel**.
- 4 Click **View network status and tasks** under **Network and Internet**.
- 5 Click **Set up a connection or network** on the left pane. The **Set up a connection or network** window appears.
- 6 Select an option to specify the ad-hoc network settings and click **Next**.
- 7 Follow the on-screen instructions.



Communicating with an Access Point (Infrastructure)

An infrastructure network is a network that extends an existing wired local network to wireless devices by providing an access point (not supplied). The access point bridges the wireless and wired LAN and acts as a central controller for the wireless LAN network. The access point coordinates transmission and reception from multiple wireless devices within a specific range. The access point will select which channel to use on an infrastructure network.

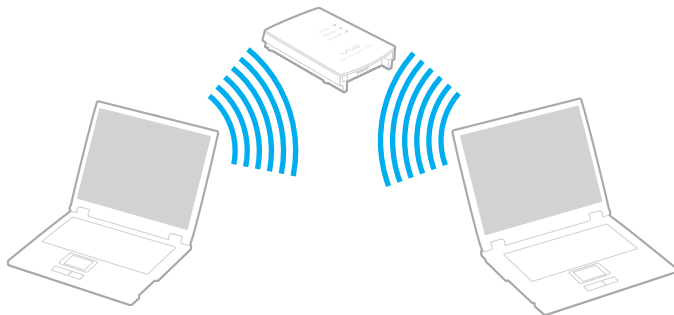
! For details on how to select the channel that will be used by the access point, see the manual that came with your access point.



To connect to a wireless network

- 1 Make sure an access point is set up.
See the manual that came with your access point for more information.
- 2 Turn on the **WIRELESS** switch.
- 3 Click the button next to or above your desired wireless option(s) in the **VAIO Smart Network** window.
Make sure the **WIRELESS** indicator light turns on.
- 4 Right-click  or  on the taskbar and select **Connect to a network**.
- 5 Select the desired access point and click **Connect**.



For WPA-PSK or WPA2-PSK authentication, you must enter a passphrase. The passphrase is case sensitive and must be a text string between 8 and 63 characters in length or a hexadecimal string of 64 characters.

Stopping Wireless LAN Communication

To stop wireless LAN communication

Click the button next to or above the **WLAN** icon in the **VAIO Smart Network** window.

! Turning off the wireless LAN function while accessing remote documents, files, or resources may result in data loss.

Using the Bluetooth Function

You can establish wireless communication between your computer and other Bluetooth devices such as another computer or a mobile phone. You can transfer data between these devices without cables at a range of up to 10 meters in an open area.

To start Bluetooth communications

- 1 Turn on the **WIRELESS** switch.
- 2 Click the button next to or above the **Bluetooth** icon in the **VAIO Smart Network** window.
Make sure the **WIRELESS** indicator light turns on.

Notes on using the Bluetooth function

- ❑ The data transfer rate varies, depending on the following conditions:
 - ❑ Obstacles, such as walls, located between devices
 - ❑ Distance between devices
 - ❑ Material used in walls
 - ❑ Proximity to microwaves and cordless telephones
 - ❑ Radio frequency interference and other environmental conditions
 - ❑ Device configuration
 - ❑ Type of software application
 - ❑ Type of operating system
 - ❑ Use of both wireless LAN and Bluetooth functions at the same time on your computer
 - ❑ Size of file being exchanged
- ❑ Note that large files may occasionally be corrupted during continuous transfer due to limitations of the Bluetooth standard and electromagnetic interference in the environment.
- ❑ All Bluetooth devices must be certified to make sure that the applicable standard requirements are maintained. Even if standards are met, individual device performance, specifications, and operation procedures can vary. Data exchange may not be possible in all situations.
- ❑ Video and audio may not be synchronized if you play videos on your computer with audio output from a connected Bluetooth device. This is a frequent occurrence with Bluetooth technology and is not a malfunction.

- ❑ The 2.4 GHz band, with which Bluetooth devices or wireless LAN devices work, is used by various devices. Bluetooth devices use the technology to minimize the interference from other devices that use the same wave length. Simultaneous use of the Bluetooth function and wireless communication devices, however, may cause radio interference and result in reduced communication speeds and distances than the standard values.



Read the Bluetooth regulations guide before using the Bluetooth function.

- ❑ The Bluetooth function may not work with other devices, depending on the manufacturer or the software version employed by the manufacturer.
- ❑ Connecting multiple Bluetooth devices to your computer may cause bandwidth congestion, resulting in poor performance of the devices. This is normal with Bluetooth technology and is not a malfunction.

Bluetooth Security

The Bluetooth wireless technology has an authentication function, which allows you to determine with whom you choose to communicate. With the authentication function, you can prevent any anonymous Bluetooth devices from accessing your computer.

The first time two Bluetooth devices communicate, a common passkey (a password required for authentication) should be determined for both devices to be registered. Once a device is registered, there is no need to re-enter the passkey.



The passkey can be different each time, but must be the same at both ends.

For certain devices, such as a mouse, no passkey can be entered.

Communicating with Another Bluetooth Device

You can connect your computer to a Bluetooth device such as another computer, a mobile phone, a PDA, a headset, a mouse, or a digital camera without the use of any cables.



To communicate with another Bluetooth device

To communicate with another Bluetooth device, you first need to set up the Bluetooth function. For setting up and using the Bluetooth function, search for Bluetooth information using **Windows Help and Support**. To open **Windows Help and Support**, click **Start** and **Help and Support**.

Stopping Bluetooth Communications

To stop Bluetooth communications

- 1 Turn off the Bluetooth device that is communicating with your computer.
- 2 Click the button next to or above the **Bluetooth** icon in the **VAIO Smart Network** window.

Using Peripheral Devices

You can add functionality to your VAIO computer by using the various ports on the computer.

- ❑ **Connecting External Speakers** ([page 78](#))
- ❑ **Connecting an External Display** ([page 79](#))
- ❑ **Selecting Display Modes** ([page 82](#))
- ❑ **Using the Multiple Monitors Function** ([page 83](#))
- ❑ **Connecting an External Microphone** ([page 85](#))
- ❑ **Connecting a Universal Serial Bus (USB) Device** ([page 86](#))
- ❑ **Connecting a Printer** ([page 89](#))
- ❑ **Connecting an i.LINK Device** ([page 90](#))
- ❑ **Connecting to a Network (LAN)** ([page 92](#))

Connecting External Speakers

You can connect external sound output devices (not supplied), such as speakers or headphones, to your computer.

To connect external speakers

- 1 Plug the speaker cable (1) (not supplied) into the headphones jack (2) 🎧.
- 2 Plug the other end of the speaker cable to the external speaker (3).
- 3 Turn down the volume of the speakers before you turn them on.

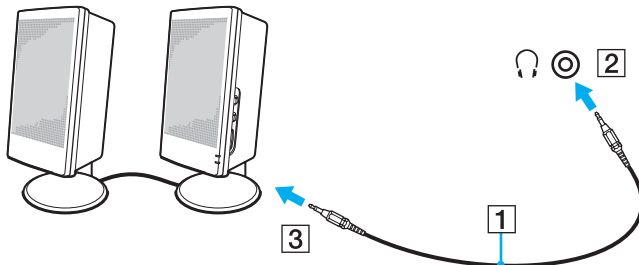

Make sure your speakers are designed for computer use.



Do not place floppy disks on the speakers. Their magnetic field may damage the data on the disks.

Connecting an External Display

You can connect an external display (not supplied) to your computer. For example, you can use the computer with a computer display or a projector.



Connect the power cord of your external display after connecting all other cables.

Connecting a Computer Display

You can connect a computer display (monitor) to your computer.

To connect a computer display

- 1 If necessary, plug one end of the display's power cord (1) into your display, and the other end into an AC outlet.
- 2 Plug the display cable (2) (not supplied) into the monitor port (3) on the computer.

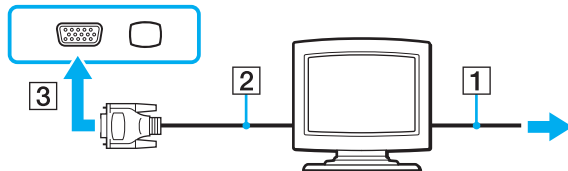

Connecting a Multimedia Computer Display

You can connect a multimedia computer display that includes built-in speakers and a microphone to your computer.

To connect a multimedia computer display

- 1 Plug the power cord of your multimedia computer display (1) into an AC outlet.
- 2 Plug the display cable (2) (not supplied) into the monitor port (3) □ on the computer.
- 3 Plug the speaker cable (4) (not supplied) into the headphones jack (5) 🎧 on the computer.
- 4 Plug the microphone cable (6) (not supplied) into the microphone jack (7) 🎤 on the computer.

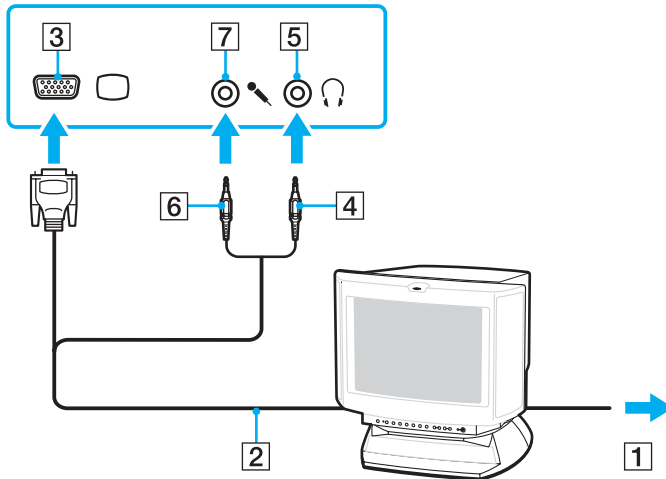

Connecting a Projector

You can connect a projector (for example, the Sony LCD projector) to your computer.

To connect a projector

- 1 Connect the power cord (1) of your projector into an AC outlet.
- 2 Plug a display cable (2) (not supplied) into the monitor port (3) □ on the computer.
- 3 Plug an audio cable (4) (not supplied) into the headphones jack (5) 🎧 on the computer.
- 4 Plug the display cable and the audio cable into the jack and port on the projector (6).

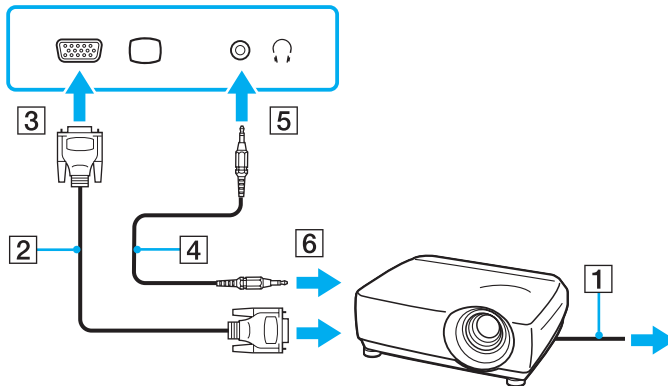

Selecting Display Modes

You can select which display to use as the primary monitor when an external display (desktop monitor, etc.) is connected to your computer.

If you want to work on your computer screen and the external display at the same time, see **Using the Multiple Monitors Function (page 83)** for more information.

To select a display

- 1 Click **Start** and **Control Panel**.
- 2 Click **Additional Options**.
- 3 Click **NVIDIA Control Panel**.
- 4 Select the display setup option under **Display**.
- 5 Follow the on-screen instructions to change the settings.



You may not be able to display the same contents on your computer screen and the external display or projector at the same time, depending on the type of your external display or projector.

Before turning on your computer, turn on the external display.

Using the Multiple Monitors Function

The Multiple Monitors function allows you to distribute portions of your desktop across separate displays. For example, if you have an external display connected to the monitor port, your computer screen and the external display can function as a single desktop.

You can move the cursor from one display to the other. This allows you to drag objects, such as an open application window or a toolbar, from one display to the other.

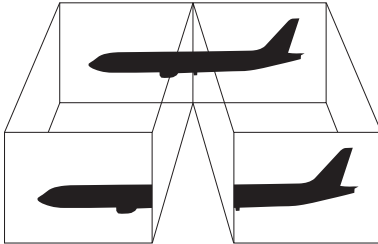

Your external display may not support the Multiple Monitors function.

Certain software applications may not be compatible with Multiple Monitors settings.

Make sure that your computer does not enter Sleep or Hibernate mode while you are using the Multiple Monitors function. Otherwise, the computer may not return to Normal mode.

If you set different colors on each display, do not expand a single window across two displays. Otherwise, your software may not work properly.

Set fewer colors or a lower resolution for each display.

To use the Multiple Monitors function

- 1 Click **Start** and **Control Panel**.
- 2 Click **Adjust screen resolution** under **Appearance and Personalization**.
- 3 Right-click the number **2** monitor and select **Attached**.
- 4 Click **OK**.
At the confirmation prompt, click **Yes**.



Additionally, you can set the display colors and resolution for each display and customize the Multiple Monitors function.

Connecting an External Microphone

If you need to use a sound input device (for example, to chat over the Internet), you need to plug in an external microphone (not supplied).

To connect an external microphone

Plug the microphone cable (1) into the microphone jack (2) .

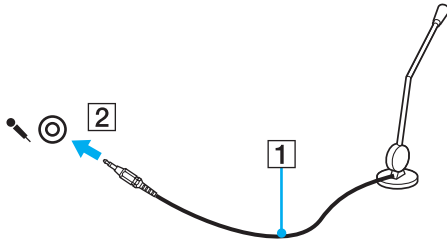

Make sure your microphone is designed for computer use.

Connecting a Universal Serial Bus (USB) Device

To protect your computer and/or USB devices from damage, observe the following:

- ❑ When moving the computer with USB devices connected, avoid exposing the USB ports to shock or impact.
- ❑ Do not put the computer into a bag or carrying case when it has USB devices connected.

Connecting a USB Mouse

To connect a USB mouse

- 1 Choose the USB port (1)  you prefer to use.
- 2 Plug the USB mouse cable (2) into the USB port.
- You can now use your USB mouse (not supplied) (3).

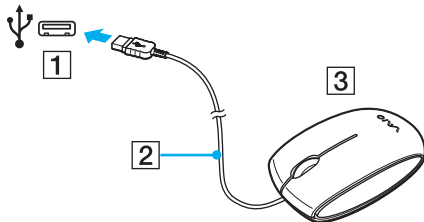

Connecting a USB Floppy Disk Drive

You can purchase a USB floppy disk drive and connect it to your computer.

To connect a USB floppy disk drive

- 1 Choose the USB port (1)  you prefer to use.
 - 2 Plug the USB floppy disk drive cable (2) into the USB port.
- Your USB floppy disk drive (3) is now ready for use.

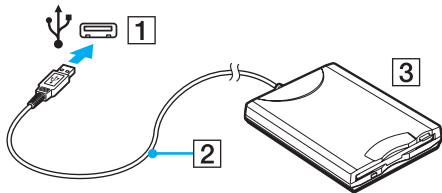

! When using a USB floppy disk drive, do not apply force to the USB port. This may cause a malfunction.

Disconnecting a USB floppy disk drive

You can disconnect a USB floppy disk drive when your computer is on or off. Disconnecting the drive when the computer is in a power saving mode (Sleep or Hibernate) may cause the computer to malfunction.

To disconnect a USB floppy disk drive



To disconnect a USB floppy disk drive when your computer is off, skip steps 1 to 5.

- 1 Close all programs accessing the floppy disk drive.
- 2 Double-click the **Safely Remove Hardware** icon on the taskbar.
- 3 Select the floppy disk drive you want to unplug.
- 4 Click **Stop**.
- 5 Follow the on-screen instructions to remove the floppy disk drive.
- 6 Disconnect the floppy disk drive from the computer.

Connecting a Printer

You can connect a Windows-compatible printer to your computer to print documents.

Connecting a Printer Using the USB Port

You can connect a USB printer compatible with your version of Windows to the computer.

To connect a printer using the USB port

- 1 Plug the power cord (1) of your printer into an AC outlet.
- 2 Choose the USB port (3)  you prefer to use.
- 3 Plug one end of a USB printer cable (2) (not supplied) into the USB port and the other end to your printer.

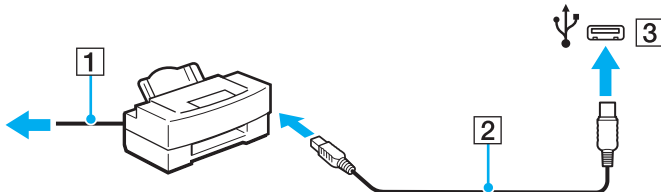

Connecting an i.LINK Device

Notes on connecting i.LINK devices

- ❑ Your computer is equipped with an i.LINK port, which you can use to connect an i.LINK device, such as a digital video camcorder.
- ❑ The i.LINK port on your computer does not supply power to external devices that are generally powered through i.LINK ports.
- ❑ The i.LINK port supports transfer rates up to 400 Mbps. However, the actual transfer rate depends on the transfer rate of the external device.
- ❑ The optional i.LINK cables may not be available in some countries or areas.
- ❑ An i.LINK connection with other compatible devices is not fully guaranteed.
- ❑ The i.LINK connection may not be available depending on the software applications, operating system, and i.LINK-compatible devices you use. See the manual that came with your software for more information.
- ❑ Check the working conditions and operating system compatibility of i.LINK-compatible PC peripherals (for example, an HDD or a CD-RW drive) before you connect them to your computer.

Connecting a Digital Video Camcorder

To connect a digital video camcorder

Plug one end of an i.LINK cable (1) (not supplied) into the i.LINK port (2) on the computer and the other end into the DV In/Out port (3) on the digital video camcorder.

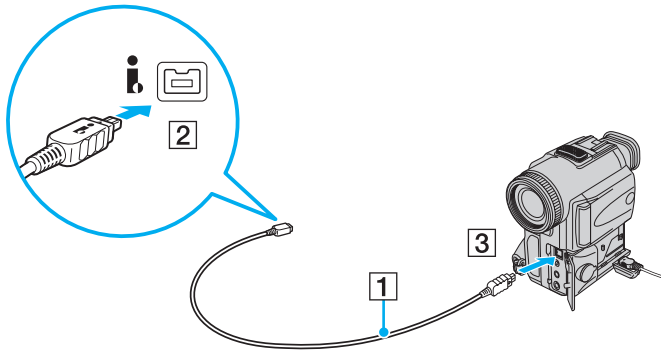

On Sony digital video cameras, ports labeled **DV Out**, **DV In/Out**, or **i.LINK** are i.LINK-compatible.

The Sony digital video camcorder shown here is an example. Your digital video camcorder may need to be connected differently.

You cannot access the pictures stored on a Memory Stick when using an i.LINK connection.

Connecting to a Network (LAN)

You can connect your computer to 100BASE-TX/10BASE-T-type networks with an Ethernet network cable. Connect one end of a network cable (not supplied) to the network (Ethernet) port on the computer and the other end to your network. For detailed settings and devices needed to connect to the network, ask your network administrator.

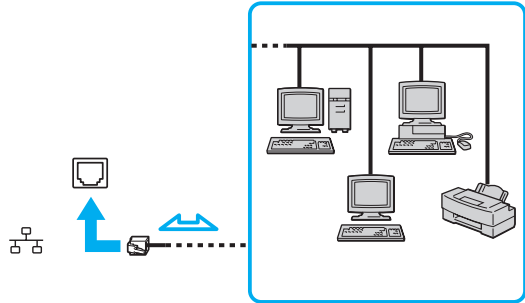

Your computer can be connected to the network with the default settings.

!
Do not plug a telephone cable into the network (LAN) port on your computer.
If the network (LAN) port is connected to one of the telephone lines mentioned below, high electric current to the port may cause damage, overheating, or fire.

- Home (intercom speakerphone) or business-use telephone lines (multi-line business telephone)
- Public telephone subscriber line
- PBX (private branch exchange)

Do not plug a telephone cable into the network (Ethernet) port.

Customizing Your VAIO Computer

This section briefly describes how to change the main settings of your VAIO computer. Among other things, you will learn how to use and customize the look of your Sony software and utilities.

- ❑ **Setting the Password** ([page 94](#))
- ❑ **Using Fingerprint Authentication** ([page 101](#))
- ❑ **Setting Up Your Computer with VAIO Control Center** ([page 109](#))
- ❑ **Using the Power Saving Modes** ([page 110](#))
- ❑ **Managing Power with VAIO Power Management** ([page 115](#))
- ❑ **Configuring Your Modem** ([page 117](#))

Setting the Password

Use one of the BIOS functions to set the password.

Once you have set the password, you will be prompted to enter the password after the VAIO logo appears to start your computer. The power-on password allows you to protect your computer from unauthorized access.

Adding the Power-on Password

The power-on password is provided to protect your computer from unauthorized access.

There are two types of the power-on passwords: the machine password and the user password. The machine password is provided for users with administrative rights on the computer to change all the setup options in the BIOS setup screen, as well as to start the computer. The user password is provided for the standard users to allow for changing some of the BIOS setup options, as well as starting the computer. To set the user password, you must first set the machine password.



Once you have set the power-on password, you cannot start your computer without entering the password. Be sure not to forget the password. Write down your password and keep it safe and private from other people.

If you forget the power-on password and need assistance to reset it, a password reset fee will be charged, and your computer may need to be sent in for service to reset the password.



If your computer is equipped with a fingerprint sensor and you have set the power-on password in conjunction with the fingerprint authentication function, you can substitute fingerprint authentication for password entry when turning on your computer. For more information, see **Using Fingerprint Authentication (page 101)**.

To add the power-on password (machine password)

- 1 Turn on the computer.
- 2 Press the **F2** key when the VAIO logo appears.
The BIOS setup screen appears. If not, restart the computer and press the **F2** key several times when the VAIO logo appears.
- 3 Press the **←** or **→** key to select **Security** to display the **Security** tab, select **Set Machine Password**, and then press the **Enter** key.
- 4 On the password entry screen, enter the password twice and press the **Enter** key.
The password can be up to 32 alphanumeric characters (including spaces) long.
- 5 Select **Password when Power On** under **Security** and press the **Enter** key.
- 6 Change the setting from **Disabled** to **Enabled**.
- 7 Press the **←** or **→** key to select **Exit**, select **Exit Setup**, and then press the **Enter** key.
At the confirmation prompt, press the **Enter** key.

To add the power-on password (user password)



Make sure you set the machine password before setting the user password.

- 1 Turn on the computer.
- 2 Press the **F2** key when the VAIO logo appears.
The BIOS setup screen appears. If not, restart the computer and press the **F2** key several times when the VAIO logo appears.
- 3 Enter the machine password and press the **Enter** key.
- 4 Press the **←** or **→** key to select **Security** to display the **Security** tab, select **Set User Password**, and then press the **Enter** key.
- 5 On the password entry screen, enter the password twice and press the **Enter** key.
The password can be up to 32 alphanumeric characters (including spaces) long.
- 6 Press the **←** or **→** key to select **Exit**, select **Exit Setup**, and then press the **Enter** key.
At the confirmation prompt, press the **Enter** key.

Changing/Removing the Power-on Password

To change or remove the power-on password (machine password)

- 1 Turn on the computer.
- 2 Press the **F2** key when the VAIO logo appears.
The BIOS setup screen appears. If not, restart the computer and press the **F2** key several times when the VAIO logo appears.
- 3 Enter the machine password and press the **Enter** key.
- 4 Press the **←** or **→** key to select **Security** to display the **Security** tab, select **Set Machine Password**, and then press the **Enter** key.
- 5 On the password entry screen, enter the current password once and a new password twice, and then press the **Enter** key.
To remove the password, leave the **Enter New Password** and **Confirm New Password** fields blank and press the **Enter** key.
- 6 Press the **←** or **→** key to select **Exit**, select **Exit Setup**, and then press the **Enter** key.
At the confirmation prompt, press the **Enter** key.

To change or remove the power-on password (user password)

- 1 Turn on the computer.
- 2 Press the **F2** key when the VAIO logo appears.
The BIOS setup screen appears. If not, restart the computer and press the **F2** key several times when the VAIO logo appears.
- 3 Enter the user password and press the **Enter** key.
- 4 Press the **←** or **→** key to select **Security** to display the **Security** tab, select **Set User Password**, and then press the **Enter** key.
- 5 On the password entry screen, enter the current password once and a new password twice, and then press the **Enter** key.
To remove the password, leave the **Enter New Password** and **Confirm New Password** fields blank and press the **Enter** key.
- 6 Press the **←** or **→** key to select **Exit**, select **Exit Setup**, and then press the **Enter** key.
At the confirmation prompt, press the **Enter** key.

Adding the Windows Password

The Windows password comes in handy when you have to share a single computer with other people. By setting the Windows password, you can protect your user account from unauthorized access.

Entry of the Windows password will be prompted after you select your user account.

! Be sure not to forget the password. Write down your password and keep it safe and private from other people.



If your computer is equipped with a fingerprint sensor and you have set the Windows password in conjunction with the fingerprint authentication function, you can substitute fingerprint authentication for password entry when turning on your computer. For more information, see **Using Fingerprint Authentication (page 101)**.

To add the Windows password

- 1 Click **Start** and **Control Panel**.
- 2 Click **User Accounts and Family Safety** or **User Accounts**.
- 3 Click **User Accounts**.
- 4 Click **Create a password for your account** under **Make changes to your account**.
- 5 In the **New password** and **Confirm new password** fields, enter the password for your account.
- 6 Click **Create password**.



See **Windows Help and Support** for more information on the Windows password.

Changing/Removing the Windows Password

To change the Windows password

- 1 Click **Start** and **Control Panel**.
- 2 Click **User Accounts and Family Safety** or **User Accounts**.
- 3 Click **User Accounts**.
- 4 Click **Change your password**.
- 5 In the **Current password** field, enter your current password.
- 6 In the **New password** and **Confirm new password** fields, enter a new password.
- 7 Click **Change password**.

To remove the Windows password

- 1 Click **Start** and **Control Panel**.
- 2 Click **User Accounts and Family Safety** or **User Accounts**.
- 3 Click **User Accounts**.
- 4 Click **Remove your password**.
- 5 In the **Current password** field, enter the current password that you want to remove.
- 6 Click **Remove password**.

Using Fingerprint Authentication

Your computer may be equipped with a fingerprint sensor to provide you with additional convenience. A small horizontal bar located between the left and right touch pad buttons is the sensor of the fingerprint reader and will be referred to as the fingerprint sensor hereinafter.

See the online specifications to find out whether your model is equipped with the fingerprint sensor.

Once you have registered your fingerprint(s), the fingerprint authentication function offers:

- ❑ A substitute for password entry
 - ❑ Logging onto Windows ([page 106](#))
If you have registered your fingerprints for your user account, you can substitute fingerprint authentication for password entry when logging onto Windows.
 - ❑ **Power-on Security** feature ([page 106](#))
If you have set the power-on password ([page 94](#)), you can substitute fingerprint authentication for password entry when starting your computer.
- ❑ **Password Bank** for quick web site access ([page 107](#))
You can substitute fingerprint authentication for entering information (user accounts, passwords, etc.) required to access the password-protected web sites.
- ❑ **File Safe** feature to encrypt/decrypt data ([page 107](#))
With the **File Safe** feature, you can encrypt files and folder to create an encrypted archive. To decrypt or access such encrypted archives, you can use the fingerprint authentication or enter the password you specified for encryption.
- ❑ Application launcher function for quick application access ([page 107](#))
Once you have assigned an application to your finger, you can then swipe the finger across the fingerprint sensor to launch the assigned application.

Precautions on Using Fingerprint Authentication

- ❑ The fingerprint authentication technology does not ensure complete user authentication or complete protection of your data and hardware.
Sony assumes no liability for any problems and damages arising out of your use of or inability to use the fingerprint sensor.
- ❑ The fingerprint recognition rate depends on your operating conditions and varies among individuals as well.
- ❑ Be sure to make a backup copy of the data stored on the hard disk drive, especially in the encrypted archives created with the **File Safe** feature, before sending your computer for repair.
Sony assumes no liability for any loss or modification of your data that might have occurred during the course of repair.
- ❑ In case the hard disk drive has to be initialized, for example after the repair work, the fingerprint templates will be lost. You will have to register them all over again.
- ❑ The maintenance and management of data concerning fingerprint authentication must be carried out at your own risk. Sony assumes no liability for any defects arising out of your data maintenance and management.
- ❑ Before disposing of your computer or transferring it to a third person, it is strongly recommended you erase the fingerprint data registered on the fingerprint sensor after erasing the data stored on your hard disk drive. See **Erasing the Registered Fingerprints (page 108)** for the detailed procedure.
- ❑ A fingerprint sensor may malfunction or be damaged if you scratch its surface with:
 - ❑ a solid or sharp-pointed object
 - ❑ fine objects, for example swiping a finger covered with dirt across the fingerprint sensor
- ❑ Discharge static electricity from your finger by touching a metallic object especially during dry seasons (e.g. winter) before scanning your fingerprint. Static electricity may cause the fingerprint sensor to malfunction.

Registering a Fingerprint

To use the fingerprint authentication function, you must register your fingerprint(s) in your computer.

 Set the Windows password on your computer before registration. See **Adding the Windows Password** (page 99) for the detailed instructions.

To register a fingerprint

 Up to 10 fingerprints can be registered for each user and up to 21 fingerprints can be registered for logging onto your system using the **Power-on Security** feature. You can also select the fingerprint you want to use for the **Power-on Security** feature later.

- 1 Click **Start, All Programs, Protector Suite QL, and Control Center**.
- 2 Click **Fingerprints** and **Initialize**.
- 3 Follow the on-screen instructions.

 For detailed information, see the help file.

If you have failed to register a fingerprint, follow these steps to try again.

- 1 Place the top joint of your finger on the fingerprint sensor (1).

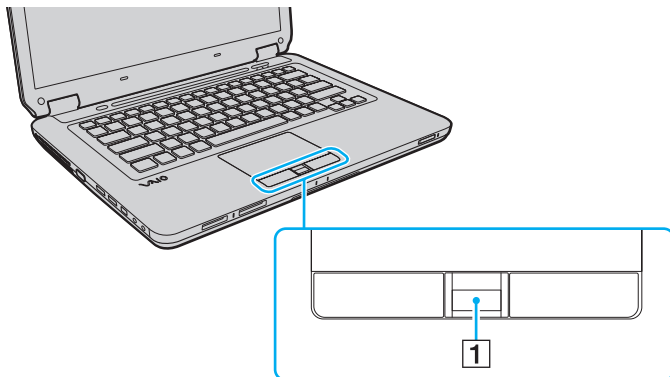

- 2 Swipe your finger perpendicularly across the fingerprint sensor.

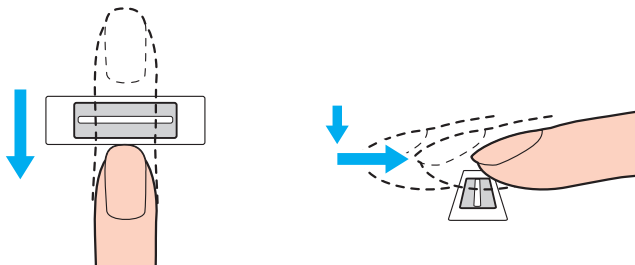

! Place your fingertip flat in the center of the fingerprint sensor.

Scan your fingerprint from the top joint of the finger to the fingertip.

Keep your finger in contact with the fingerprint sensor while swiping.

Fingerprint registration may fail if you move your finger too fast or too slow. Let the fingerprint sensor take about one second to scan your fingerprint.

You may not be able to register and/or have your fingerprint(s) recognized if your finger is excessively dry or wet, wrinkled, injured, dirty, etc.

Register more than one fingerprint in case that the fingerprint sensor fails to recognize the fingerprint.

Up to 10 fingerprints can be registered per person. Note that up to 21 fingerprints can be registered for logging onto your system using the **Power-on Security** feature.

Be sure to clean your fingertip(s) and the fingerprint sensor before swiping in order to keep good recognition performance.

Logging Onto Your System

To use the fingerprint authentication function in place of password entry to log onto your system, you need to set the power-on and Windows passwords and configure your computer for fingerprint authentication.

For setting the power-on and Windows passwords, see **Setting the Password (page 94)**.

For detailed information, see the help file included with the **Protector Suite QL**.

Logging onto Windows

If you have registered your fingerprints for your user account, you can substitute fingerprint authentication for Windows password entry. To log onto Windows, swipe the registered finger across the fingerprint sensor when the Windows log-on screen appears.

Power-on Security feature

If you have set the power-on password ([page 94](#)), you can substitute fingerprint authentication for password entry when starting your computer.

Using the Password Bank

Once you have registered your user information (user accounts, passwords, etc.) for web sites in the **Password Bank**, you can substitute fingerprint authentication for entering information required to access the password-protected web sites.

For detailed information, see the help file included with the **Protector Suite QL**.



You may not be able to use the **Password Bank** feature depending on the web site you access.

Using the File Safe Feature

With the **File Safe** feature, you can create an encrypted archive to include a file and/or folder for protection against unauthorized access. The encrypted archive can be decrypted or unlocked for included file/folder access by swiping your finger across the fingerprint sensor or entering the backup password you specified for encryption.

For detailed information, see the help file included with the **Protector Suite QL**.

Using the Application Launcher

The application launcher feature is available on your computer for launching your preferred application (executable file) that is assigned to one of your fingers with a registered fingerprint. Once you have assigned an application to your finger, you can launch the assigned application simply by swiping the finger across the fingerprint sensor.

For detailed information, see the help file included with the **Protector Suite QL**.

Erasing the Registered Fingerprints

Before disposing of your computer or transferring it to a third person, it is strongly recommended you erase the fingerprint data registered on the fingerprint sensor after erasing the data stored on your hard disk drive.

To erase the registered fingerprints

- 1 Turn on the computer.
- 2 Press the **F2** key when the VAIO logo appears.
The BIOS setup screen appears. If not, restart the computer and press the **F2** key several times when the VAIO logo appears.
- 3 Press the **←** or **→** key to select **Security** to display the **Security** tab.
- 4 Press the **↓** key to select **Clear Fingerprint Data** and press the **Enter** key.
- 5 At the confirmation prompt, select **Continue** and press the **Enter** key.
The fingerprint data registered on the fingerprint sensor is erased automatically after your system restarts.

Setting Up Your Computer with VAIO Control Center

The **VAIO Control Center** utility allows you to access system information and to specify preferences for system behavior.

To use VAIO Control Center

- 1 Click **Start, All Programs, and VAIO Control Center**.
- 2 Select the desired control item and change the settings.
- 3 Once finished, click **OK**.
The setting of the desired item has been changed.



For more information about each option, see the help file included with the **VAIO Control Center**.

Some of the control items will not be visible if you open the **VAIO Control Center** as a standard user.

Changing the default illumination lamp activity

The illumination lamp on the bottom of your computer illuminates depending on your actions or the computer's status. You can change this default activity of the lamp to make it stay unlit by following these steps:

- 1 Click **Start, All Programs, and VAIO Control Center**.
- 2 Click **Display and Illumination LED Setting**.
- 3 Click to cancel the **Enable the Illumination LED** check box.
- 4 Click **OK**.

Using the Power Saving Modes

You can take advantage of the power management settings to conserve battery life. In addition to the normal operating mode, which allows you to turn off specific devices, your computer has two distinct power saving modes: Sleep and Hibernate. When using battery power, you should be aware that the computer will automatically enter Hibernate mode if the remaining battery life becomes short, regardless of the power management setting you select.

! If the battery charge level falls below 10%, you should either connect the AC adapter to recharge the battery pack or shut down your computer and install a fully charged battery pack.

Using Normal Mode

This is the normal state of the computer when it is in use. The green power indicator light is lit in this mode. To save power while not working, you can turn off a specific device such as the LCD screen or the hard disk drive.

Using Sleep Mode

Sleep mode turns off the LCD screen and places the storage device(s) and the CPU into a low power consumption mode. The orange power indicator light blinks slowly in this mode.



If you do not intend to use your computer for a long period of time while it is disconnected from AC power, place the computer into Hibernate mode or turn it off.

To activate Sleep mode

Click **Start**, the arrow next to the **Lock** button, and **Sleep**.



When your computer is in Sleep mode, you cannot insert a disc.

Your computer comes out of Sleep mode quicker than out of Hibernate mode.

Sleep mode uses more power than Hibernate mode.



If the battery runs down while your computer is in Sleep mode, you will lose all unsaved data. Going back to the previous work state is impossible. To avoid loss of data, you should save your data frequently.

To return to Normal mode

- ❑ Press any key.
- ❑ Press the power button on your computer.



If you press and hold the power button for more than four seconds, your computer will turn off automatically. You will lose all unsaved data.



You can use **VAIO Control Center** to configure your computer to return to Normal mode when you open the LCD screen lid. This power resuming preference will be lost if you remove both the AC adapter and the battery pack. See **Setting Up Your Computer with VAIO Control Center** ([page 109](#)).

If the computer is not used for a certain period of time, it will enter Sleep mode. To modify this, you can change the Sleep mode settings.

To change the Sleep mode settings

- 1 Right-click the power status icon on the taskbar and select **Power Options**.
- 2 Click **Change plan settings** under the current power plan.
- 3 Change the time to place the computer into Sleep mode and click **Save Changes**.

Using Hibernate Mode

In Hibernate mode, the state of the system is saved on the hard disk drive and power is turned off. Even when the battery runs down, no data will be lost. The power indicator light is unlit in this mode.



If you do not intend to use your computer for a long period of time, place the computer into Hibernate mode. This power saving mode saves you the time of shutting down and resuming.

To activate Hibernate mode

Press the **Fn+F12** keys.

The computer enters Hibernate mode.

Alternatively, you can click **Start**, the arrow next to the **Lock** button, and **Hibernate** to place the computer into Hibernate mode.



When your computer is in Hibernate mode, you cannot insert a disc.

Hibernate mode requires more time than Sleep mode to be activated.

Hibernate mode uses less power than Sleep mode.



Do not move your computer before its power indicator light turns off.

To return to Normal mode

Press the power button.

The computer returns to its normal state.

! If you press and hold the power button for more than four seconds, your computer will turn off automatically.



It takes more time to return to Normal mode from Hibernate mode than from Sleep mode.

You can use **VAIO Control Center** to configure your computer to return to Normal mode when you open the LCD screen lid. This power resuming preference will be lost if you remove both the AC adapter and the battery pack. See **Setting Up Your Computer with VAIO Control Center** ([page 109](#)).

Managing Power with VAIO Power Management

Power management helps you set up power plans for running on AC or battery power to suit your requirements for power consumption.

The **VAIO Power Management** is a software application developed exclusively for VAIO computers. With this software application, you can enhance the Windows power management functions to ensure better operation of your computer and longer battery life. See the help file included with the software for more information.

Selecting a Power Plan

When you start the computer, a power status icon appears on the taskbar. This icon indicates what kind of power source you are using at that time, for example, AC power. Click this icon to display the window that shows your power status.

The **VAIO Power Management** function is added to the Windows **Power Options Properties**.

To select a power plan

- 1 Right-click the power status icon on the taskbar and select **Power Options**.
- 2 Select your desired power plan.

To change the power plan settings

- 1 Click **Change plan settings** under your desired power plan in the **Power Options** window.
Change the Sleep mode and display settings as needed.
- 2 If you need to change the advanced settings, click **Change advanced power settings** and go to step 3.
Otherwise, click **Save changes**.
- 3 Click the **VAIO Power Management** tab.
Change the settings for each item.
- 4 Click **OK**.

VAIO Power Management Viewer

You can view performance with the power plan that was modified with the **VAIO Power Management**.

To start VAIO Power Management Viewer

- 1 Click **Start, All Programs**, and **VAIO Control Center**.
- 2 Click **Power Management** and **VAIO Power Management Viewer**.

Configuring Your Modem

Before you can start using your internal modem (not all modems are built-in), or each time you use your modem while traveling, make sure that the country of the active location defined in the **Phone and Modem Options** window matches the country you are dialing from.

To change the country settings for your modem

- 1 Click **Start** and **Control Panel**.
- 2 Click **Hardware and Sound**.
- 3 Click **Phone and Modem Options**.
The **Location Information** window appears.
- 4 Enter the required information, and then click **OK**.
The **Phone and Modem Options** window appears.
- 5 Select your location on the **Dialing Rules** tab.
- 6 Click the **Edit** button to change the current configuration.
The **Edit Location** window appears.
Or
Click the **New** button to configure your modem.
The **New Location** window appears.
- 7 Check the country/region settings, and make sure it matches the place you are dialing from.



Pulse dial may not be supported in some counties or areas.

- 8 If you modified your location settings, click **Apply**, and then **OK**.
The **Phone and Modem Options** window appears.

- 9 Check that your modem is listed on the **Modems** tab.
If your modem is not listed, click **Add** and follow the wizard.
- 10 Click **Apply/OK**. Your modem is configured.

! Before applying new country settings, make sure your phone cable is disconnected from your computer.

Upgrading Your VAIO Computer

Your VAIO computer and memory modules use high precision components and electronic connectors technology. To avoid invalidation of the warranty during your product warranty period, we recommend that:

- You should contact your dealer to install a new memory module.
- You should not install it yourself, if you are not familiar with upgrading memory on a computer.
- You should not touch the connectors or open the memory module compartment cover.

For the type of module and the amount of memory installed on your model, see the online specifications.

Contact VAIO-Link if you need assistance.

Adding and Removing Memory

If you want to expand the functionality of your computer, you can increase the amount of memory by installing optional memory modules. Before you upgrade your computer's memory, read the notes and procedures in the following pages.

Notes on adding/removing memory modules

- ❑ Be sure to place your computer on a flat surface before adding or removing memory modules.
- ❑ Be careful when changing memory. Improper installation of memory modules may cause damage to your system. This damage may void your manufacturer's warranty.
- ❑ Only use memory modules that are compatible with your computer. If a memory module is not detected by the computer or the Windows operating system becomes unstable, contact the sales dealer or the manufacturer of your memory module.
- ❑ Electrostatic discharge (ESD) can damage electronic components. Before touching a memory module, ensure the following:
 - ❑ The procedures described in this document assume user familiarity with the general terminology associated with personal computers and with the safety practice and regulatory compliance requirements for using and modifying electronic equipment.
 - ❑ Turn off your computer and disconnect it from its power sources (battery pack and AC adapter) and from any telecommunication links, networks, or modems before you remove any cover or panel from the computer. Failure to do so may result in personal injury or equipment damage.
 - ❑ ESD can damage memory modules and other components. Install the memory module only at an ESD workstation. If such a station is not available, do not work in a carpeted area, and do not handle materials that produce or hold static electricity (cellophane wrappers, for example). Ground yourself by maintaining contact with an unpainted metal portion of the chassis while performing the procedure.

- Do not open the memory module package before you are ready to change the module. The package protects the module from ESD.
- Use the special bag supplied with the memory module or wrap the module in aluminum foil to protect it from ESD.
- Introducing any liquids, foreign substances, or objects into the memory module slots or other internal components of your computer will result in damage to the computer and any repair costs will not be covered by the warranty.
- Do not place the memory module in a location subject to:
 - Heat sources such as radiators or air ducts
 - Direct sunlight
 - Excessive dust
 - Mechanical vibration or shock
 - Strong magnets or speakers that are not magnetically shielded
 - Ambient temperature of more than 35°C or less than 5°C
 - High humidity
- Handle the memory module with care. To avoid injuries to your hands and fingers, do not touch the edges of the components and circuit boards inside your computer.

Removing and Installing a Memory Module

To change or add a memory module

- 1 Shut down the computer and disconnect all peripheral devices.
- 2 Unplug the computer and remove the battery pack.
- 3 Wait about an hour until the computer cools down.
- 4 Unscrew the screw (indicated by the arrow below) on the bottom of the computer and remove the memory module compartment cover.

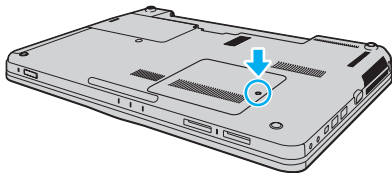

- 5 Touch a metal object to discharge static electricity.

6 Remove the currently installed memory module as follows:

- ❑ Pull the latches in the direction of the arrows (1).
The memory module is released.
- ❑ Make sure that the memory module tilts up and then pull it out in the direction of the arrow (2).

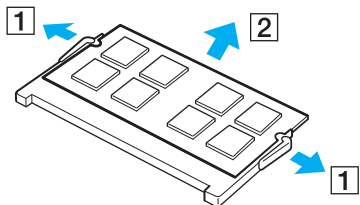

- 7 Remove the new memory module from its packaging.
- 8 Slide the memory module into the memory module slot and push it in until it clicks into place.

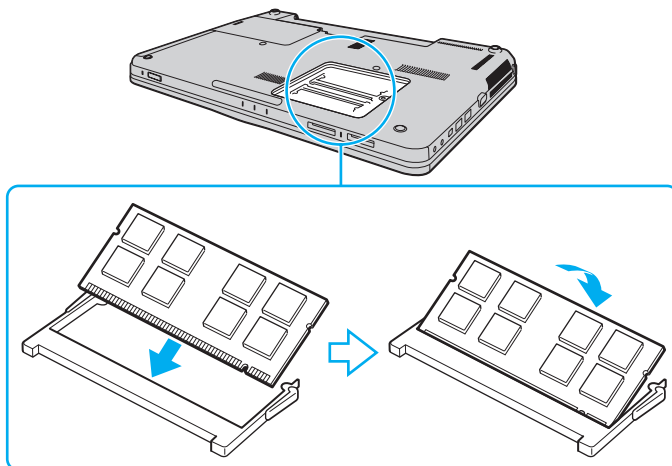

!
Do not touch any other components on the motherboard.

If you want to install only one memory module, be sure to use the slot closer to the front of your computer.

Be sure to insert the connector edge of the memory module into the slot while aligning the notch on the module with the small projection in the open slot. Do not force the memory module into the slot in a wrong orientation, as it may cause damage to the slot and the module.

- 9 Replace the memory module compartment cover.
- 10 Tighten the screw on the bottom of the computer.
- 11 Reinstall the battery pack and turn on the computer.

Viewing the Amount of Memory

To view the amount of memory

- 1 Turn on the computer.
- 2 Click **Start**, **All Programs**, and **VAIO Control Center**.
- 3 Click **System Information** and **System Information**.
You can view the amount of system memory in the right pane. If the additional memory does not appear, repeat the installation procedure and restart the computer.

Precautions

This section describes safety guidelines and precautions to help you protect your VAIO computer from potential damage.

- ❑ **Handling the LCD Screen** ([page 127](#))
- ❑ **Using the Power Source** ([page 128](#))
- ❑ **Handling Your Computer** ([page 129](#))
- ❑ **Handling the Built-in MOTION EYE Camera** ([page 131](#))
- ❑ **Handling Floppy Disks** ([page 132](#))
- ❑ **Handling Discs** ([page 133](#))
- ❑ **Using the Battery Pack** ([page 134](#))
- ❑ **Using Headphones** ([page 135](#))
- ❑ **Handling the Memory Stick** ([page 136](#))
- ❑ **Handling the Hard Disk** ([page 137](#))
- ❑ **Updating Your Computer** ([page 138](#))

Handling the LCD Screen

- ❑ Do not leave the LCD screen facing the sun. This could damage the LCD screen. Be careful when using your computer near a window.
- ❑ Do not scratch the surface of the LCD screen or exert pressure on it. This could cause a malfunction.
- ❑ Using your computer in low temperature conditions may produce a residual image on the LCD screen. This is not a malfunction. When the computer returns to normal temperature, the screen returns to normal.
- ❑ A residual image may appear on the LCD screen if the same image is displayed for a long period of time. The residual image disappears after a while. You can use a screen saver to prevent residual images.
- ❑ The LCD screen becomes warm during operation. This is normal and does not indicate a malfunction.
- ❑ The LCD screen is manufactured using high-precision technology. You may, however, see tiny black points and/or bright points (red, blue, or green) that continuously appear on the LCD screen. This is a normal result of the manufacturing process and does not indicate a malfunction.
- ❑ Avoid rubbing the LCD screen. This could damage the screen. Use a soft, dry cloth to wipe the surface of the LCD screen.
- ❑ Do not change the LCD screen orientation setting in the **Tablet PC Settings** window even when there are change options available for selection, as this may make your computer unstable. Sony assumes no liability for any malfunctions arising from changes to the settings.

Using the Power Source

- ❑ See the online specifications to check the power operation of your model.
- ❑ Do not share the AC outlet with other power-consuming equipment, such as a photocopier or a shredder.
- ❑ You can purchase a power strip with a surge protector. This device helps prevent damage to your computer caused by sudden power surges, in an electrical storm, for example.
- ❑ Do not place heavy objects on the power cord.
- ❑ To disconnect the cord, pull it out by holding the plug. Never pull the cord itself.
- ❑ Unplug your computer from the AC outlet if you are not planning to use the computer for a long period of time.
- ❑ Make sure that the AC outlet is easily accessible.
- ❑ When the AC adapter is not used, unplug it from the AC outlet.
- ❑ Use the AC adapter supplied with your computer or genuine Sony products. Do not use any other AC adapter as it may cause a malfunction.

Handling Your Computer

- ❑ Clean the cabinet with a soft cloth, which is dry or lightly moistened with a mild detergent solution. Do not use any type of abrasive pad, scouring powder, or solvent such as alcohol or benzene, as these may damage the finish of your computer.
- ❑ If you drop a solid object or any liquid onto your computer, shut down the computer, unplug it, and remove the battery pack. You may want to have the computer checked by qualified personnel before operating it again.
- ❑ Do not drop your computer or place any objects on top of the computer.
- ❑ Do not place your computer in a location subject to:
 - ❑ Heat sources, such as radiators or air ducts
 - ❑ Direct sunlight
 - ❑ Excessive dust
 - ❑ Moisture or rain
 - ❑ Mechanical vibration or shock
 - ❑ Strong magnets or speakers that are not magnetically shielded
 - ❑ Ambient temperature of more than 35°C or less than 5°C
 - ❑ High humidity
- ❑ Do not place electronic equipment near your computer. The electromagnetic field of the equipment may cause the computer to malfunction.
- ❑ Use your computer on a solid, stable surface.
- ❑ We advise not to use your computer directly on your lap. The temperature of the bottom of the unit may rise during normal operation, and after an extended time, could cause discomfort or burns.

- ❑ Provide adequate air circulation to prevent internal overheating. Do not place your computer on porous surfaces such as rugs, blankets, couches, or beds, or near materials such as curtains or draperies that may block its air vents.
- ❑ Your computer, the AC adapter, or the battery pack may become hot during usage. This is not a malfunction.
- ❑ Your computer uses high-frequency radio signals and may cause interference to radio or TV reception. If this occurs, relocate the computer a suitable distance away from the set.
- ❑ Use only specified peripheral equipment and interface cables. Otherwise, problems may occur.
- ❑ Do not use cut or damaged connection cables.
- ❑ If your computer is brought directly from a cold location to a warm one, moisture may condense inside the computer. In this case, allow at least one hour before turning on the computer. If any problems occur, unplug the computer and contact VAIO-Link.
- ❑ Make sure you disconnect the AC adapter and remove the battery pack before cleaning your computer.
- ❑ To avoid losing data when your computer is damaged, back up your data regularly.

Handling the Built-in MOTION EYE Camera

- ❑ Do not touch the lens protection cover of the built-in **MOTION EYE** camera, as it may cause scratches on the cover and such scratches will appear on the captured images.
- ❑ Do not let the direct sunlight get into the lens of the built-in **MOTION EYE** camera regardless of your computer's power state, as it may cause the camera to malfunction.
- ❑ The built-in **MOTION EYE** camera is disabled while videos or still images are imported from an i.LINK-compatible device connected to the i.LINK port.
- ❑ Clean the lens protection cover of the built-in **MOTION EYE** camera with a blower brush or a soft brush. If the cover is extremely dirty, wipe it off with a soft dry cloth. Do not rub the cover, as it is sensitive to pressure.

Handling Floppy Disks

- ❑ Do not open the shutter manually and touch the internal components of the floppy disk.
- ❑ Keep floppy disks away from magnets.
- ❑ Keep floppy disks away from direct sunlight and other sources of heat.
- ❑ Keep floppy disks away from any liquid. Do not let them get wet. When you are not using your floppy disk, always remove it from the floppy disk drive and put it in a storage case.
- ❑ If the floppy disk comes with a label, make sure that the label is properly affixed. If the edge of the label is curled up, the label may stick to the inside of the floppy disk drive and cause a malfunction or damage your floppy disk.

Handling Discs

- ❑ Do not touch the surface of the disc.
- ❑ Fingerprints and dust on the surface of a disc may cause read errors. Always hold the disc by its edges and central hole, as shown below:

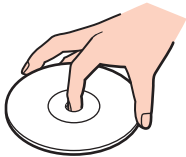

- ❑ Proper care of the disc is essential to its continuous reliability. Do not use solvents (such as benzine, thinner, alcohol, commercially available cleaners, or anti-static spray) which may cause damage to the disc.
- ❑ For normal cleaning, hold the disc by its edges and use a soft cloth to wipe the surface from the center out.
- ❑ If the disc is badly soiled, moisten a soft cloth with water, wring it out well, and use it to wipe the surface of the disc from the center out. Wipe off any remaining moisture with a dry soft cloth.
- ❑ Never affix an adhesive label to a disc. This will affect the use of the disc and may result in an irreparable problem.

Using the Battery Pack

- ❑ Do not leave battery packs in temperatures above 60°C, such as in a car parked in the sun or under direct sunlight.
- ❑ Battery life is shorter in a cold environment. This is due to decreased battery efficiency at low temperatures.
- ❑ Charge battery packs at temperatures between 10°C to 30°C. Lower temperatures require longer charging time.
- ❑ Certain rechargeable battery packs do not meet Sony quality and safety standards. For safety reasons this computer only functions with genuine Sony battery packs designed for this model. If an unauthorized battery pack is installed, the battery pack will not be charged and the computer will not function.
- ❑ While the battery pack is in use or being charged, heat builds up in the battery pack. This is normal and is not cause for concern.
- ❑ Keep the battery pack away from all sources of heat.
- ❑ Keep the battery pack dry.
- ❑ Do not open or try to disassemble the battery pack.
- ❑ Do not expose the battery pack to any mechanical shock, such as dropping it on a hard surface.
- ❑ If you are not using your computer for a long period of time, remove the battery pack from the computer to prevent damage to the battery pack.
- ❑ If you have not used the battery pack for a considerable amount of time, the remaining battery life may become short. However, this is normal and does not indicate a malfunction, because the battery pack will gradually discharge over time even when not in use. Connect the AC adapter to your computer and recharge the battery pack before using the computer again.
- ❑ You do not need to discharge the battery pack before recharging.
- ❑ If the battery pack quickly runs out of power after fully charged, it may be reaching the end of its life and should be replaced.

Using Headphones

- ❑ **Road safety** – Do not use headphones while driving, cycling, or operating any motorized vehicle. It may create a traffic hazard and is illegal in some areas. It can also be potentially dangerous to play loud music while walking, especially at pedestrian crossings.
- ❑ **Preventing hearing damage** – Avoid using headphones at high volume. Hearing experts advise against continuous, loud and extended play. If you experience a ringing in your ears, reduce the volume or discontinue use.

Handling the Memory Stick

- Do not touch the Memory Stick connector with your finger or metallic objects.
- Use only the adhesive label supplied with the Memory Stick as a label.
- Do not bend, drop, or expose the Memory Stick.
- Do not disassemble or modify the Memory Stick.
- Do not let the Memory Stick get wet.
- Do not use or store the Memory Stick in a location subject to:
 - Static electricity
 - Electrical noise
 - Extremely high temperatures, such as in a car parked in the sun
 - Direct sunlight
 - High humidity
 - Corrosive substances
- Use the storage case supplied with the Memory Stick.
- Be sure to make a backup copy of your valuable data.
- Keep the Memory Stick and the Memory Stick adaptors out of reach of children. There is a risk of swallowing them.
- When using the Memory Stick Duo, do not use a fine-tipped pen to write on the label adhered to the Memory Stick Duo. Exerting pressure on the media may damage internal components.

Handling the Hard Disk

The hard disk drive has a high storage density and reads or writes data in a short time. However, it can be easily damaged by mechanical vibration, shock, or dust.

Although the hard disk drive has the internal safety device to prevent losing data due to mechanical vibration, shock or dust, you should be careful when handling your computer.

To avoid damaging your hard disk drive

- Do not subject your computer to sudden movements.
- Keep your computer away from magnets.
- Do not place your computer in a location subject to mechanical vibration or in an unstable position.
- Do not move your computer while the power is on.
- Do not turn off the power or restart your computer while reading or writing data to the hard disk drive.
- Do not use your computer in a place subject to extreme changes in temperature.



If the hard disk drive is damaged, the data cannot be restored.

Updating Your Computer

Be sure to install the latest updates on your computer with the following software applications so that the computer can run more efficiently.

Windows Update

Click **Start, All Programs, and Windows Update** and then follow the on-screen instructions.

VAIO Update 4

Click **Start, All Programs, VAIO Update 4, and VAIO Update Options** and then follow the on-screen instructions.



Your computer must be connected to the Internet to download the updates.

Troubleshooting

This section describes how to solve common problems you might encounter when using your VAIO computer. Many problems have simple solutions. Try these suggestions before contacting VAIO-Link.

- ❑ **Computer** ([page 141](#))
- ❑ **System Security** ([page 147](#))
- ❑ **Battery** ([page 148](#))
- ❑ **Built-in MOTION EYE Camera** ([page 150](#))
- ❑ **Internet** ([page 153](#))
- ❑ **Networking** ([page 155](#))
- ❑ **Bluetooth Technology** ([page 159](#))
- ❑ **Optical Discs** ([page 164](#))
- ❑ **Display** ([page 168](#))
- ❑ **Printing** ([page 172](#))
- ❑ **Microphone** ([page 173](#))
- ❑ **Mouse** ([page 174](#))
- ❑ **Speakers** ([page 175](#))
- ❑ **Touch Pad** ([page 177](#))
- ❑ **Keyboard** ([page 178](#))
- ❑ **Floppy Disks** ([page 179](#))
- ❑ **Audio/Video** ([page 180](#))

- ❑ **Memory Stick** ([page 182](#))
- ❑ **Peripherals** ([page 183](#))

Computer

What should I do if my computer does not start?

- ❑ Make sure your computer is securely plugged into a power source and turned on and the power indicator light is lit.
- ❑ Make sure the battery pack is installed properly and charged.
- ❑ Make sure the floppy disk drive (if applicable) is empty.
- ❑ If your computer is plugged into a power strip or an uninterruptible power supply (UPS), make sure the power strip or UPS is plugged into a power source and turned on.
- ❑ If you are using an external display, make sure it is plugged into a power source and turned on. Make sure the brightness and contrast controls are adjusted correctly. See the manual that came with your display for more information.
- ❑ Unplug the AC adapter and remove the battery pack. Wait three to five minutes. Reinstall the battery pack, plug the AC adapter, and then press the power button to turn on your computer.
- ❑ Condensation may cause your computer to malfunction. If this occurs, do not use the computer for at least one hour.
- ❑ Remove any extra memory modules you may have installed since purchase.
- ❑ Check that you are using the supplied Sony AC adapter. For your safety, use only the genuine Sony rechargeable battery pack and AC adapter, which are supplied by Sony for your VAIO computer.

What should I do if the green power indicator light turns on but my screen remains blank?

- If the illumination lamp is on, press any key.
- Press the **Alt+F4** keys several times to close the application window. An application error may have been occurred.
- Press the **Ctrl+Alt+Delete** keys and click the arrow next to the **Shut down** button and **Restart**.
- Press and hold the power button for more than four seconds to shut down your computer. Unplug the AC adapter and leave the computer for about five minutes. Then plug the AC adapter and turn on the computer again.

! Turning off your computer with the power button or the **Ctrl+Alt+Delete** keys may cause loss of unsaved data.

What should I do if my computer or software stops responding?

- If your computer stops responding while a software application is running, press the **Alt+F4** keys to close the application window.
- If the **Alt+F4** keys do not work, click **Start**, the arrow next to the **Lock** button, and **Shut Down** to turn off your computer.
- If your computer does not turn off, press the **Ctrl+Alt+Delete** keys and click the arrow  next to the **Shut down** button and **Shut Down**.
If the **Windows Security** window appears, click **Shut Down**.

! Turning off your computer with the **Ctrl+Alt+Delete** keys or the power button may cause loss of unsaved data.

- If your computer still does not turn off, press and hold the power button until the computer turns off.
- Remove the AC adapter and battery pack.
- Try reinstalling the software.
- Contact the software publisher or designated provider for technical support.

Why doesn't my computer enter Sleep or Hibernate mode?

Your computer may become unstable if the operating mode is changed before the computer completely enters Sleep or Hibernate mode.

To restore your computer to normal mode

- 1 Close all open programs.
- 2 Click **Start**, the arrow next to the **Lock** button, and **Restart**.
- 3 If your computer does not restart, press the **Ctrl+Alt+Delete** keys and click the arrow next to the **Shut down** button and **Restart**.
- 4 If this procedure does not work, press and hold the power button until the computer turns off.



Turning off your computer with the power button may cause loss of unsaved data.

What should I do if the charge indicator light is blinking fast and my computer does not start?

- This problem could be due to the battery pack not being installed properly. To resolve this problem, turn off your computer and remove the battery pack. Then reinstall the battery pack to the computer again. For details, see **Installing the Battery Pack (page 23)**.
- If the problem persists after performing the above, it means the installed battery pack is not compatible. Remove the battery pack and contact VAIO-Link.

What should I do if a message window, notifying of incompatibility or improper installation of the battery pack, appears and my computer enters Hibernate mode?

- ❑ This problem could be due to the battery pack not being installed properly. To resolve this problem, turn off your computer and remove the battery pack. Then reinstall the battery pack to the computer again. For details, see **Installing the Battery Pack (page 23)**.
- ❑ If the problem persists after performing the above, it means the installed battery pack is not compatible. Remove the battery pack and contact VAIO-Link.

Why does the System Properties window display a slower CPU speed than the maximum?

This is normal. Because your computer's CPU utilizes a type of CPU speed controlling technology for power conservation purposes, System Properties may display the current CPU speed instead of the maximum speed.

What should I do if Windows does not start and a message appears, when I start my computer?

If you enter a wrong power-on password three times consecutively, the **Enter Onetime Password** message appears and Windows will not start. Press and hold the power button for more than four seconds to check that the power indicator light turns off. Wait for 10 or 15 seconds, then restart your computer and enter the correct password. When entering the password, check that the Num lock and Caps lock indicators are unlit. If both or either of the lights is lit, press the **Num Lk** (or **Num Lock**) key or the **Caps Lock** key to turn off the indicator before entering the password.

What should I do if my game software does not work or it keeps crashing?

- ❑ Check the web site of the game if there are any patches or updates to download.
- ❑ Make sure you have installed the latest video driver.
- ❑ On some VAIO models, the graphics memory is shared with the system. The optimal graphic performance in this case is not guaranteed.

What should I do if I cannot remember the power-on password?

If you have forgotten the power-on password, contact VAIO-Link to reset it. A reset fee will be charged.

How can I change the boot device order?

You can use one of the BIOS functions to change the boot device order. Follow these steps:

- 1 Turn on your computer.
- 2 Press the **F2** key when the VAIO logo appears.
The BIOS setup screen appears. If not, restart the computer and press the **F2** key several times when the VAIO logo appears.
- 3 Press the **←** or **→** key to select **Boot**.
- 4 Press the **↑** or **↓** key to select the drive whose boot device order you want to change.
- 5 Press the **F5** or **F6** key to change the boot device order.
- 6 Press the **←** or **→** key to select **Exit**, select **Exit Setup**, and then press the **Enter** key.
At the confirmation prompt, press the **Enter** key.

Why doesn't my screen turn off after the automatic turn-off time has passed?

The **VAIO Original Screen Saver** disables the timer setting, which you can select using the Windows power options, for your screen to turn off.

Select a screen saver other than the **VAIO Original Screen Saver**.

What should I do if I cannot boot my computer from the USB floppy disk drive connected to the computer?

To boot your computer from the USB floppy disk drive, you need to change the boot device.

Turn on your computer and press the **F11** key when the VAIO logo appears.

How do I check the volume of the recovery partition?

Your built-in storage device* contains the recovery partition where data for the system recovery is stored. To check the volume of the recovery partition, follow these steps:

* See the online specifications to find out about your storage device configuration.

1 Click **Start**, right-click **Computer**, and select **Manage**.

2 Click **Disk Management** under **Storage** on the left pane.

The volume of the recovery partition and the total volume of the C drive are displayed in the **Disk 0** row on the center pane.

System Security

How can I protect my computer against security threats, such as viruses?

The Microsoft Windows operating system is preinstalled on your computer. The best way to protect your computer against security threats, such as viruses, is to download and install the latest Windows updates regularly.

You can get important Windows updates by doing the following:



Your computer must be connected to the Internet to download the updates.

- 1 Connect to the Internet.
- 2 Double-click the **Windows Security Alerts** icon on the taskbar.
- 3 Follow the on-screen instructions to set up automatic or scheduled updates.

How do I keep my antivirus software updated?

You can keep the **McAfee Internet Security Suite** software program current with the latest updates from McAfee, Inc.

To download and install the latest security updates, follow these steps:

- 1 Click **Start, All Programs, McAfee, and McAfee SecurityCenter**.
- 2 Click the button located at the upper left corner of the window to update the software.
- 3 Follow the on-screen instructions to download updates.

See the help file included with your software program for more information.

Battery

How do I find the battery charging status?

See **Charging the Battery Pack** ([page 26](#)).

When is my computer using AC power?

When your computer is directly connected to the AC adapter, it uses AC power, even if the battery pack is installed.

When should I recharge the battery pack?

- When the battery charge level falls below 10%.
- When both the charge and power indicator lights blink.
- When you have not used the battery pack for a long period of time.

When should I replace the battery pack?

If the battery pack quickly runs out of power after fully charged, it may be reaching the end of its life and should be replaced.

To check the battery wear level, see **To check the battery wear level** ([page 28](#)).

Should I be concerned that the installed battery pack is warm?

No, it is normal for the battery pack to be warm when it is powering your computer.

Can my computer enter Hibernate mode while using battery power?

Your computer can enter Hibernate mode while using battery power, but some software programs and peripheral devices prevent the system from entering Hibernate mode. If you are using a program that prevents the system from entering Hibernate mode, save your data frequently to avoid losing data. See **Using Hibernate Mode (page 113)** for information on how you can manually activate Hibernate mode.

Built-in MOTION EYE Camera

Why does the viewer window show no images or poor-quality images?

- ❑ The built-in **MOTION EYE** camera cannot be shared by more than one software application. If another software application is using the camera, exit the application before using the built-in **MOTION EYE** camera.
- ❑ The video memory of your computer may be insufficient for displaying images from the built-in **MOTION EYE** camera. Lowering the resolution or reducing the colors of the LCD screen might help.
- ❑ The viewer window may show some noise, for example horizontal streaks, if you view a rapid-moving object. This is normal and does not indicate a malfunction.
- ❑ If the problem persists, restart your computer.

Why are captured images poor in quality?

- ❑ The images captured under the fluorescent light may show reflections of light.
- ❑ A dark portion in captured images may appear as a noise.
- ❑ If the lens protection cover is dirty, you cannot take a clear shot. Clean the cover. See **Handling the Built-in MOTION EYE Camera (page 131)**.

Why do captured images contain dropped frames and audio interruptions?

- ❑ The effect settings on your software application may cause dropped frames. See the help file included with your software application for more information.
- ❑ There may be more software applications running than your computer can handle. Exit the applications that you are not currently using.
- ❑ The power management function of your computer may be active. Check the CPU performance.

Why does movie playback show dropped frames when my computer is running on the battery?

The battery pack is running out of power. Connect your computer to an AC power source.

Why do the images captured by the built-in MOTION EYE camera flicker?

This problem occurs when you use the camera under fluorescent lights due to the mismatch between lighting output frequency and shutter speed.

To reduce flicker noise, change the direction of the camera or the brightness of camera images. In some software applications, you can set an appropriate value to one of the camera properties (e.g. light source, flicker, etc.) to eliminate flicker noise.

Why is the video input from the built-in MOTION EYE camera suspended for a few seconds?

The video input may be suspended for a few seconds if:

- a shortcut key with the **Fn** key is used.
- the CPU load increases.

This is normal and does not indicate a malfunction.

Why can't I use the built-in MOTION EYE camera?

- ❑ The built-in **MOTION EYE** camera cannot be shared by more than one software application. If another software application is using the camera, exit the application before using the built-in **MOTION EYE** camera.
- ❑ If the problem persists, you must reinstall the driver software for the camera. Follow these steps:
 - 1 Click **Start, Control Panel, Hardware and Sound**, and **Device Manager**.
 - 2 Double-click **Imaging devices**.
 - 3 Right-click the device name for your camera and click **Update Driver Software**.

What should I do if my computer becomes unstable when it enters a power saving mode while the built-in MOTION EYE camera is in use?

- ❑ Do not place your computer into Sleep or Hibernate mode while you are using the built-in **MOTION EYE** camera.
- ❑ If your computer automatically enters Sleep or Hibernate mode, change the corresponding power saving mode setting. To change the setting, see **Using the Power Saving Modes (page 110)**.

Internet

What should I do if my modem does not work?

- ❑ Make sure the telephone cable is securely plugged into the modem port on your computer and the wall jack.
- ❑ Make sure the telephone cable is working. Plug the cable into an ordinary telephone and listen for a dial tone.
- ❑ Make sure that the telephone number the program is dialing is correct.
- ❑ Make sure the software you are using is compatible with your computer's modem. (All preinstalled Sony programs are compatible.)
- ❑ Make sure the modem is the only device connected to your telephone line.
- ❑ Follow these steps to check the settings:
 - 1 Click **Start** and **Control Panel**.
 - 2 Click **Hardware and Sound**.
 - 3 Click **Phone and Modem Options**.
 - 4 On the **Modems** tab, check that your modem is listed.
 - 5 On the **Dialing Rules** tab, check the location information is correct.

Why is my modem connection slow?

Your computer is equipped with a V.92/V.90 compatible modem. Many factors may influence modem connection speed, including telephone line noise or compatibility with telephone equipment, such as fax machines or other modems. If you think your modem is not connecting properly to other PC-based modems, fax machines, or your ISP, do any of the following:

- ❑ Ask your telephone company to verify your telephone line is free of any line noise.
- ❑ If your problem is fax-related, make sure there are no problems with the fax machine you are calling and that it is compatible with fax modems.
- ❑ If you are having a problem connecting with your ISP, make sure the ISP is not experiencing technical problems.
- ❑ If you have a second telephone line, try connecting the modem to that line.

Networking

What should I do if my computer cannot connect to a wireless LAN access point?

- Connection capability is affected by distance and obstructions. You may need to move your computer away from obstructions or closer to any access point you may be using.
- Make sure the **WIRELESS** switch is on and the **WIRELESS** indicator light is lit on your computer.
- Make sure power to the access point is on.
- Follow these steps to check the settings:
 - 1 Click **Start** and **Control Panel**.
 - 2 Click **View network status and tasks** under **Network and Internet**.
 - 3 Click **Connect to a network** to confirm that your access point is selected.
- Make sure the encryption key is correct.
- Make sure **Maximum Performance** is selected for **Wireless Adapter Settings** in the **Power Options** window. Selecting any other option may result in a communication failure. To change the settings, follow these steps:
 - 1 Right-click the power status icon on the taskbar and select **Power Options**.
 - 2 Click **Change plan settings** under the current power plan.
 - 3 Click **Change advanced power settings**.
 - 4 Select the **Advanced settings** tab.
 - 5 Double-click **Wireless Adapter Settings** and **Power Saving Mode**.
 - 6 Select **Maximum Performance** from the drop-down list both for **On battery** and **Plugged in**.

What should I do if I cannot access the Internet?

- ❑ Check the access point settings. See the manual that came with your access point for more information.
- ❑ Make sure your computer and the access point are connected to one another.
- ❑ Move your computer away from obstacles or closer to any access point you may be using.
- ❑ Make sure your computer is properly configured for Internet access.
- ❑ Make sure **Maximum Performance** is selected for **Wireless Adapter Settings** in the **Power Options** window. Selecting any other option may result in a communication failure. Follow the steps in **What should I do if my computer cannot connect to a wireless LAN access point? (page 155)** to change the settings.

Why is the data transfer speed slow?

- ❑ The wireless LAN data transfer speed is affected by distance and obstructions between devices and access points. Other factors include device configurations, radio conditions, and software compatibility. To maximize the data transfer speed, move your computer away from obstacles or closer to any access point you may be using.
- ❑ If you are using a wireless LAN access point, the device may be temporarily overloaded depending on how many other devices are communicating via the access point.
- ❑ If your access point interferes with other access points, change the access point channel. See the manual that came with your access point for more information.
- ❑ Make sure **Maximum Performance** is selected for **Wireless Adapter Settings** in the **Power Options** window. Selecting any other option may result in a communication failure. Follow the steps in **What should I do if my computer cannot connect to a wireless LAN access point? (page 155)** to change the settings.

How do I avoid data transfer interruptions?

- ❑ When your computer is connected to an access point, data transfer interruptions may occur if a large file is exchanged or the computer is placed in close proximity to microwaves and cordless telephones.
- ❑ Move your computer closer to the access point.
- ❑ Make sure the access point connection is intact.
- ❑ Change the access point channel. See the manual that came with your access point for more information.
- ❑ Make sure **Maximum Performance** is selected for **Wireless Adapter Settings** in the **Power Options** window. Selecting any other option may result in a communication failure. Follow the steps in **What should I do if my computer cannot connect to a wireless LAN access point? (page 155)** to change the settings.

What are channels?

- ❑ Wireless LAN communication uses divided frequency bands known as channels. Third-party wireless LAN access point channels may be preset to different channels from Sony devices.
- ❑ If you are using a wireless LAN access point, see connectivity information contained in the manual that came with your access point.

Why does the network connection stop when I change the encryption key?

Two computers with the wireless LAN function may lose a peer-to-peer network connection if the encryption key is changed. You can either change the encryption key back to the original profile or re-enter the key on both computers so the key matches.

How do I display the VAIO Smart Network window?

To display the **VAIO Smart Network** window on the desktop, follow these steps:

- 1 Click **Start**, **All Programs**, and **VAIO Control Center**.
- 2 Click **Network Connections** and **VAIO Smart Network**.
- 3 Click **Advanced** in the right pane.



For information on the **VAIO Smart Network** software, see the help file included with the software.

Bluetooth Technology

What should I do if other Bluetooth devices cannot find my computer?

- Make sure both devices have the Bluetooth function enabled.
- If the **WIRELESS** indicator light is unlit, turn on the **WIRELESS** switch.
- You cannot use the Bluetooth function when your computer is in a power saving mode. Bring the computer back to Normal mode, then turn on the **WIRELESS** switch.
- Your computer and the device may be too far apart. Wireless Bluetooth technology works best when the devices are within 10 meters of each other.

Why can't my computer find other Bluetooth devices?

If the connected device is also connected to other devices, it may not appear in the **Bluetooth Devices** window or you may not be able to communicate with the device.

What should I do if I cannot find the Bluetooth device I want to communicate with?

- Check that the Bluetooth function of the device you want to communicate with is on. See the other device's manual for more information.
- If the device you want to communicate with is already communicating with another Bluetooth device, it may not be found or it may not be able to communicate with your computer.
- To allow other Bluetooth devices to communicate with your computer, follow these steps:
 - 1 Click **Start, Control Panel, Hardware and Sound, Bluetooth Devices**, and **Bluetooth Settings**.
 - 2 Click the **Options** tab and select the **Allow Bluetooth devices to find this computer** check box.

What should I do if other Bluetooth devices cannot connect to my computer?

- ❑ Make sure the other devices are authenticated.
- ❑ To allow other Bluetooth devices to communicate with your computer, follow these steps:
 - 1 Click **Start, Control Panel, Hardware and Sound, Bluetooth Devices**, and **Bluetooth Settings**.
 - 2 Click the **Options** tab and select the **Allow Bluetooth devices to find this computer** check box.
- ❑ The data transfer distance can be shorter than 10 meters depending on existing obstacles between the two devices, on radio wave quality, and on the operating system or the software in use. Move your computer and Bluetooth devices closer to each other.
- ❑ If the device you want to communicate with is already communicating with another Bluetooth device, it may not be found or it may not be able to communicate with your computer.
- ❑ Check that the Bluetooth function of the device you want to communicate with is on. See the other device's manual for more information.

Why is my Bluetooth connection slow?

- ❑ The data transfer speed depends on the obstructions and/or the distance between the two devices, on the radio wave quality, and on the operating system or the software in use. Move your computer and Bluetooth devices closer to each other.
- ❑ The 2.4 GHz radio frequency used by Bluetooth and wireless LAN devices is also used by other devices. Bluetooth devices incorporate technology that minimizes interference from other devices using the same wavelength, however, communication speed and connection range may be reduced. Interference from other devices may also stop communications altogether.
- ❑ Connection capability is affected by distance and obstructions. You may need to move your computer away from obstacles or closer to the device to which it is connected.
- ❑ Identify and remove obstacles between your computer and the device to which it is connected.
- ❑ Note that large files may occasionally be corrupted during continuous transfer due to limitations of the Bluetooth standard and electromagnetic interference in the environment.

What should I do if my computer becomes unstable when I use a Bluetooth audio device?

Your computer may become unstable if you change a sound output device to a Bluetooth audio device while audio or video playback software is running.

When you listen to playback audio from your Bluetooth audio device, connect the Bluetooth audio device to the computer first and then launch your audio or video playback software.

See the help file for detailed information on connecting the Bluetooth audio device.

Why can't I use the services supported by the connected Bluetooth device?

Connection is only possible for services also supported by the computer with the Bluetooth function. For more details, search for Bluetooth information using **Windows Help and Support**. To open **Windows Help and Support**, click **Start** and **Help and Support**.

Can I use a device with Bluetooth technology on airplanes?

With Bluetooth technology, your computer transmits a radio frequency of 2.4 GHz. Sensitive locations, such as hospitals and airplanes, may have restrictions on use of Bluetooth devices to avoid radio interference. Check with facility staff to see if use of the Bluetooth function on the computer is permitted.

Why can't I use the Bluetooth function when I log onto my computer as a user with a standard user account?

The Bluetooth function may not be available to a user with a standard user account on your computer. Log onto the computer as a user with administrative rights.

Why can't I connect to a Bluetooth device through a Personal Area Network (PAN)?

If the device to which you want to connect does not support Bluetooth communication in Personal Area Network User (PANU) mode, you cannot connect to the device through a PAN.

Why can't I use the Bluetooth devices when I switch users?

If you switch users without logging off your system, the Bluetooth devices will not work. Be sure to log off before switching users. To log off your system, click **Start**, the arrow next to the **Lock** button, and **Log Off**.

Why can't I exchange business card data with a mobile phone?

The business card exchange function is not supported.

Optical Discs

Why does my computer freeze when I try to read a disc?





The disc that your computer is trying to read may be dirty or damaged. Follow these steps:

- 1 Press the **Ctrl+Alt+Delete** keys and click the arrow next to the **Shut down** button and **Restart** to restart the computer.
- 2 Remove the disc from the optical disc drive.
- 3 Check the disc for dirt or damage. If you need to clean the disc, see **Handling Discs (page 133)** for instructions.

What should I do if the drive tray does not open?

- Make sure your computer is on.
- Press the drive eject button.
- If the drive eject button does not work, click **Start** and **Computer**, right-click the optical disc drive icon, and select **Eject**.
- If none of the above options work, insert a thin, straight object (such as a paper clip) in the manual eject hole on the optical disc drive.
- Try restarting your computer.

What should I do if I cannot play a disc properly on my computer?

- ❑ Make sure the disc is inserted into the optical disc drive with the label facing upward.
- ❑ Make sure the necessary program(s) is installed according to the manufacturer's instructions.
- ❑ If a disc is dirty or damaged, your computer will stop responding. Follow these steps:
 - 1 Press the **Ctrl+Alt+Delete** keys and click the arrow next to the **Shut down** button and **Restart** to restart the computer.
 - 2 Remove the disc from the optical disc drive.
 - 3 Check the disc for dirt or damage. If you need to clean the disc, see **Handling Discs (page 133)** for instructions.
- ❑ If you are playing a disc and cannot hear sound, do any of the following:
 - ❑ The volume may have been turned off by  (the touch sensor button) or the **Fn+F2** keys. Press  twice or the **Fn+F2** keys once again.
 - ❑ The volume may have been minimized by  (the touch sensor button) or the **Fn+F3** keys. Press  (the touch sensor button) several times or keep pressing  or the **Fn+F4** keys to turn up the volume loud enough to hear sound.
 - ❑ Right-click the volume icon on the taskbar and click **Open Volume Mixer** to check the settings.
 - ❑ Check the volume setting in the audio mixer.
 - ❑ If you are using external speakers, check the volume settings on the speakers and the connections between the speakers and your computer.
 - ❑ Make sure the correct driver software is installed. Follow these steps:
 - 1 Click **Start** and **Control Panel**.
 - 2 Click **System and Maintenance**.
 - 3 Click **System**.

- 4 Click **Device Manager** on the left pane.
The **Device Manager** window appears with a listing of your computer's hardware devices.
If an "X" or an exclamation point appears on the listed device, you may need to enable the device or reinstall the drivers.
 - 5 Double-click the optical disc drive device to open a list of the optical disc drives of your computer.
 - 6 Double-click the desired drive.
You can confirm the driver software by selecting the **Driver** tab, and clicking **Driver Details**.
 - 7 Click **OK** to close the window.
- Make sure an adhesive label is not affixed to a disc. Adhesive labels can come off while the disc is in the optical disc drive and damage the drive or cause it to malfunction.
 - If a region code warning appears, the disc may be incompatible with the optical disc drive. Check the package to make sure the region code is compatible with the optical disc drive.
 - If you notice condensation on your computer, do not use the computer for at least one hour. Condensation can cause the computer to malfunction.
 - Make sure your computer is running on the AC power supply and try the disc again.

What should I do if I cannot play Blu-ray Disc media?

! This Q & A entry applies to selected models only. See the online specifications to find out the type of your optical disc drive, and then **Reading and Writing Optical Discs (page 44)** to find out about the supported disc media.

You may not be able to play some Blu-ray Disc contents on your computer. To play such contents, download and install the latest updates for **WinDVD BD** using **VAIO Update**.

To download and install the updates on the computer, it must be connected to the Internet. For information on how to connect the computer to the Internet, see **Using the Internet (page 63)**.

What should I do if I cannot write data to CD media?

- Make sure you neither launch any software application nor allow any to launch automatically, not even a screen saver.
- Stop using the keyboard.
- If you are using a CD-R/RW disc with an adhesive label affixed, replace it with one with no affixed adhesive label. Using a disc with an affixed adhesive label could cause a write error or other damage.

What should I do if I cannot write data to DVD media?

- Make sure you are using the correct DVD recordable media.
- Check which DVD recordable format is compatible with your optical disc drive. Note the possibility that some brands of DVD recordable media do not work.

Display

Why did my screen go blank?

- ❑ Your computer screen may go blank if the computer loses power or enters a power saving mode (Sleep or Hibernate). If the computer is in LCD (Video) Sleep mode, press any key to bring the computer back into Normal mode. See **Using the Power Saving Modes (page 110)** for more information.
- ❑ Make sure your computer is securely plugged into a power source and turned on and the power indicator light is lit.
- ❑ If your computer is using battery power, make sure the battery pack is installed properly and is charged. See **Using the Battery Pack (page 23)** for more information.
- ❑ If the display output is directed to the external display, press the **Fn+F7** keys. See **Combinations and Functions with the Fn Key (page 32)** for more information.

Why doesn't my screen display a video?

- ❑ If the display output is directed to the external display and the external display is disconnected, you cannot display a video on your computer screen. Stop video playback, change the display output to the computer screen, and then restart video playback. See **Selecting Display Modes (page 82)**. Alternatively, you can press the **Fn+F7** keys to change the display output. See **Combinations and Functions with the Fn Key (page 32)** for more information.
- ❑ The video memory of your computer may be insufficient for displaying high resolution videos. In this case, lower the resolution of the LCD screen.

To change the screen resolution, follow these steps:

- 1 Right-click the desktop and select **Personalize**.
- 2 Click **Display Settings**.
- 3 Move the slider under **Resolution** to the left to reduce or to the right to increase the screen resolution.



You can check the total amount of the graphics and video memory available. Right-click on the desktop, select **Personalize**, and click **Display Settings**, **Advanced Settings**, and the **Adaptor** tab. The displayed value may be different from the actual amount of memory on your computer.

What should I do if my screen is dark?

Press the **Fn+F6** keys to brighten your computer screen.

What should I do if the LCD brightness of my screen changes?

The LCD brightness setting, adjusted with the **Fn+F5/F6** keys, is temporary and may be restored to the original setting when your computer returns to Normal mode from Sleep or Hibernate mode. To save your preference for the brightness, follow these steps:

- 1 Right-click the power status icon on the taskbar and select **Power Options**.
- 2 Click **Change plan settings** under the current power plan.
- 3 Click **Change advanced power settings**.
- 4 Select the **Advanced settings** tab.
- 5 Double-click **Display**.
- 6 Adjust the LCD brightness setting in the item for brightness adjustment.

What should I do if the external display remains blank?

If you cannot change the display output with the **Fn+F7** keys, you need to change the settings for the external display with **VAIO Control Center**. To change the settings, launch the **VAIO Control Center**, select the control item for the external display, and then click to select the check box for changing the options to detect the external display. Then, use the **Fn+F7** keys to change the display output.

How do I run Windows Aero?

! This Q & A entry applies to selected models only.

To run Windows Aero, follow these steps:

- 1 Click **Start** and **Control Panel**.
- 2 Click **Customize colors** under **Appearance and Personalization**.
- 3 Click **Open classic appearance properties for more color options**.
- 4 Select **Windows Aero** from the **Color scheme** options on the **Appearance** tab.
- 5 Click **OK**.

For information about the Windows Aero features, such as Windows Flip 3D, see **Windows Help and Support**.

Printing

What should I do if I cannot print a document?

- ❑ Make sure your printer is on, and the printer cable is securely connected to the ports on the printer and your computer.
- ❑ Make sure your printer is compatible with the Windows operating system installed on your computer.
- ❑ You may need to install the printer driver software before you use your printer. See the manual that came with your printer for more information.
- ❑ If your printer is not functioning after your computer resumes from a power saving mode (Sleep or Hibernate), then restart the computer.
- ❑ If the bidirectional communication functions are provided with your printer, disabling the functions on your computer may enable printing. Follow these steps:
 - 1 Click **Start** and **Control Panel**.
 - 2 Click **Printer** under **Hardware and Sound**.
 - 3 Right-click the printer icon and select **Properties**.
 - 4 Click the **Ports** tab.
 - 5 Click to cancel the **Enable bidirectional support** check box.
 - 6 Click **OK**.

This disables the bidirectional communication functions of the printer, such as data transfer, status monitoring, and remote panel.

Microphone

What should I do if my microphone does not work?

- ❑ If you are using an external microphone, make sure the microphone is turned on and is properly plugged into the microphone jack on your computer.
- ❑ Your sound input device may have been incorrectly configured. To configure the sound input device, follow these steps:
 - 1 Close all open programs.
 - 2 Click **Start** and **Control Panel**.
 - 3 Click **Hardware and Sound**.
 - 4 Click **Manage audio devices** under **Sound**.
 - 5 On the **Recording** tab, select the desired device for sound input and click **Set Default**.

How can I prevent microphone feedback?

Microphone feedback occurs when the microphone receives the sound from a sound output device, such as a speaker.

To prevent this problem:

- ❑ Keep the microphone away from a sound output device.
- ❑ Turn down the volume of the speakers and the microphone.

Mouse

What should I do if my computer does not recognize my mouse?

- Make sure your mouse is securely plugged into the port.
- Restart your computer with your mouse connected.





What should I do if the pointer does not move when I use my mouse?

- Make sure another mouse is not connected.
- If the pointer does not move while a software application is running, press the **Alt+F4** keys to close the application window.
- If the **Alt+F4** keys do not work, press the Windows key once and then the **→** key several times, select **Restart** with the **↑** or **↓** key, and press the **Enter** key to restart your computer.
- If your computer does not restart, press the **Ctrl+Alt+Delete** keys, select the arrow next to the **Shut down** button with the **↓** and **→** keys and then **Restart** with the **↑** or **↓** key, and press the **Enter** key to restart your computer.
- If this procedure does not work, press and hold the power button until the computer turns off.





! Turning off your computer with the power button may cause loss of unsaved data.

Speakers

What should I do if my external speakers do not work?

- ❑ If you are using a program that has its own volume control, make sure the volume control is properly set. See the program's help file for more information.
- ❑ Make sure your speakers are properly connected and the volume is turned up loud enough to hear sound.
- ❑ Make sure your speakers are designed for computer use.
- ❑ If your speakers have a muting button, set the button to off.
- ❑ The volume may have been turned off by  (the touch sensor button) or the **Fn+F2** keys. Press  twice or the **Fn+F2** keys once again.
- ❑ The volume may have been minimized by  (the touch sensor button) or the **Fn+F3** keys. Press  (the touch sensor button) several times or keep pressing  or the **Fn+F4** keys to turn up the volume loud enough to hear sound.
- ❑ If your speakers require external power, make sure the speakers are connected to a power source. See the manual that came with your speakers for more information.
- ❑ Check the Windows volume controls by clicking the volume icon on the taskbar.
- ❑ Your sound output device may have been incorrectly configured. To change the sound output device, see **How do I change the sound output device? (page 181)**.

What should I do if I do not hear sound from the built-in speakers?

- ❑ If you are using a program that has its own volume control, make sure the volume control is properly set. See the program's help file for more information.
- ❑ The volume may have been turned off by  (the touch sensor button) or the **Fn+F2** keys. Press  twice or the **Fn+F2** keys once again.
- ❑ The volume may have been minimized by  (the touch sensor button) or the **Fn+F3** keys. Press  (the touch sensor button) several times or keep pressing  or the **Fn+F4** keys to turn up the volume loud enough to hear sound.
- ❑ Check the Windows volume controls by clicking the volume icon on the taskbar.
- ❑ Your sound output device may have been incorrectly configured. To change the sound output device, see **How do I change the sound output device? (page 181)**.

Touch Pad

What should I do if the touch pad does not work?

- ❑ You may have disabled the touch pad without connecting a mouse to your computer. See [Using the Touch Pad \(page 33\)](#).
- ❑ Make sure that a mouse is not connected to your computer.
- ❑ If the pointer does not move while a software application is running, press the **Alt+F4** keys to close the application window.
- ❑ If the **Alt+F4** keys do not work, press the Windows key once and then the **→** key several times, select **Restart** with the **↑** or **↓** key, and press the **Enter** key to restart your computer.
- ❑ If your computer does not restart, press the **Ctrl+Alt+Delete** keys, select the arrow next to the **Shut down** button with the **↓** and **→** keys and then **Restart** with the **↑** or **↓** key, and press the **Enter** key to restart your computer.
- ❑ If this procedure does not work, press and hold the power button until the computer turns off.

!
Turning off your computer with the power button may cause loss of unsaved data.

Keyboard

What should I do if the keyboard configuration is wrong?

The language layout of your computer's keyboard is labeled on the packaging box. If you choose a different regional keyboard when you complete the Windows setup, the key configuration will be mismatched.

To change the keyboard configuration, follow these steps:

- 1 Click **Start** and **Control Panel**.
- 2 Click **Clock, Language, and Region**, and click **Regional and Language Options**.
- 3 Change the settings as desired.

What should I do if I cannot enter certain characters with the keyboard?

If you cannot enter **U, I, O, P, J, K, L, M**, and so on, the **Num Lk** key may be activated. Check that the Num lock indicator light is unlit. If the Num lock indicator is lit, press the **Num Lk** key to turn it off before entering these characters.

Floppy Disks

Why doesn't the Safely Remove Hardware icon appear on the taskbar when the drive is connected?

Your computer does not recognize the floppy disk drive. First, make sure the USB cable is properly connected to the USB port. If you need to secure the connection, wait a few moments for the computer to recognize the drive. If the icon still does not appear, follow these steps:

- 1 Close all programs that are accessing the floppy disk drive.
- 2 Wait for the indicator light on the floppy disk drive to turn off.
- 3 Push the eject button to remove the disk, and disconnect the USB floppy disk drive from your computer.
- 4 Reconnect the floppy disk drive by plugging the USB cable into the USB port.
- 5 Restart the computer by clicking **Start**, the arrow next to the **Lock** button, and **Restart**.

What should I do if I cannot write data to a floppy disk?

- Make sure the floppy disk is properly inserted in the drive.
- If the disk is inserted properly and you are still unable to write data to it, the disk may be full or write-protected. You can either use a floppy disk that is not write-protected or disable the write-protect feature.

Audio/Video

What should I do if I cannot use my DV camcorder?

If a message appears stating that the i.LINK device is disconnected or turned off, the i.LINK cable may not be securely plugged into the port on your computer or camcorder. Unplug the cable, and plug it in once again. See **Connecting an i.LINK Device** (page 90) for more information.



i.LINK is a trademark of Sony Corporation used only to designate that a product contains an IEEE 1394 connection. The procedure to establish an i.LINK connection may vary, depending on a software application, an operating system, and a compatible i.LINK device. Not all products with an i.LINK connection can communicate with each other. See the manual that came with your compatible i.LINK device for more information on operating conditions and proper connection. Before connecting compatible i.LINK PC peripherals to your system, such as a CD-RW or hard disk drive, confirm their operating system compatibility and required operating conditions.

How do I turn off the Windows startup sound?

To turn off the Windows startup sound, follow these steps:

- 1 Click **Start** and **Control Panel**.
- 2 Click **Hardware and Sound**.
- 3 Click **Manage audio devices** under **Sound**.
- 4 On the **Sounds** tab, click to cancel the **Play Windows Startup sound** check box.
- 5 Click **OK**.

How do I change the sound output device?

If you do not hear sound from the device connected to the USB port, you need to change the device for sound output.

- 1 Close all open programs.
- 2 Click **Start** and **Control Panel**.
- 3 Click **Hardware and Sound**.
- 4 Click **Manage audio devices** under **Sound**.
- 5 On the **Playback** tab, select the desired device for sound output and click **Set Default**.

Memory Stick

What should I do if I cannot use Memory Stick formatted on a VAIO computer on other devices?

You may need to reformat your Memory Stick.

Formatting Memory Stick erases all data, including music data previously saved on it. Before you reformat Memory Stick, back up important data and confirm that the media does not contain files you want to keep.

- 1 Copy the data from the Memory Stick onto your hard disk drive to save data or images.
- 2 Format the Memory Stick by following the steps in **To format a Memory Stick (page 58)**.

Why can't I save music files onto my Memory Stick?

Copyright protected music can only be checked out to Memory Stick with the MagicGate logo.

! Use of recorded music requires permission from the copyright holders.

Sony is not responsible for music files that cannot be recorded from a CD or downloaded from other sources.

Can I copy images from a digital camera using Memory Stick?

Yes, and you can view video clips that you have recorded with Memory Stick-compatible digital cameras.

Why can't I write data to Memory Stick?

Some versions of Memory Stick are equipped with an erasure prevention switch to protect data from accidental erasure or overwriting. Make sure the erasure prevention switch is off.

Peripherals

What should I do if I cannot connect a USB device?

- ❑ If applicable, check the USB device is turned on and using its own power supply. For example, if you are using a digital camera, check if the battery is charged. If you are using a printer, check if the power cable is connected properly to the AC outlet.
- ❑ Try using another USB port on your computer. The driver could be installed to the specific port you used the first time you connected the device.
- ❑ See the manual that came with your USB device for more information. You may need to install software before you connect the device.
- ❑ Try connecting a simple, low-powered device such as a mouse to test if the port is working at all.
- ❑ USB hubs may prevent a device from working because of a power distribution failure. We recommend you connect the device directly to your computer without a hub.

Support Options

This section contains information on where to go for answers to questions about your VAIO computer.

- ❑ **Sony Support Information** ([page 185](#))
- ❑ **e-Support** ([page 186](#))

Sony Support Information

See the following sources for answers in the sequence listed below.

See **Documentation (page 9)** for details on the printed and non-printed documentation supplied with your computer, as well as further sources of reference.

- ❑ Go to the help files that accompany your software for instructions on using the software.
- ❑ Use the search function in **Windows Help and Support** by pressing and holding the Microsoft Windows key and pressing the **F1** key.
- ❑ **VAIO-Link web site:** If you have any problem with the computer, you can access the VAIO-Link web site for troubleshooting. Go to <http://www.vaio-link.com>.
- ❑ **e-Support:** This interactive part of our web site <http://www.vaio-link.com> allows you to get in contact with our dedicated support team over the Internet. Using a personalized account, you can log your technical queries with ease.
- ❑ **VAIO-Link help lines:** Before contacting VAIO-Link by telephone, try to solve the problem by reading the printed and non-printed documentation.
- ❑ Visit the other Sony web sites:
 - ❑ <http://www.club-vaio.com> if you want to know more about VAIO and become part of the growing VAIO community.
 - ❑ <http://www.sonystyle-europe.com> for online purchases.
 - ❑ <http://www.sony.net> for other Sony products.



You need to set up an Internet connection before you can access the online features described here.

e-Support

What is e-Support?

If you have searched our user guides and web site (<http://www.vaio-link.com>) but have not found an answer to your question or issue, use e-Support to solve it.

Our e-Support Web Portal is an interactive web site on which you can submit any technical query you may have regarding your computer and receive answers from our dedicated support team.

Every submitted query will result in a unique 'case number' to ensure smooth communication between yourself and the e-Support Team.

Who can use e-Support?

All registered VAIO customers are entitled to unlimited access to the VAIO-Link e-Support Web Portal.

How can I access the e-Support portal?

When you register your computer, you will automatically receive an e-mail with the link to the e-Support Web Portal, your Customer ID and a basic explanation within a few hours.

All you need to do is activate your account by clicking on the provided link in the e-mail.

You are now ready to create your first case.

You can access the e-Support Web Portal from any computer with an active Internet connection.

A complete help file is available on the e-Support Web Portal to help you use our e-Support Service.

Can I submit questions in my native language?

Since you are interacting with our e-Support Team through a portal, which connects you directly to our central database, e-Support will only accept and deal with queries submitted in English, French or German.

Can I submit my questions at any time?

Yes, you can submit your questions 24/7, but keep in mind that our e-Support Team can only answer your queries from Monday till Friday between 8 am and 6 pm.

Is there a cost involved for using e-Support?

No, this is a free of charge service offered to all registered VAIO customers.

How do I know when the e-Support Team has handled my query/case?

As soon as your case has been dealt with by our e-Support Team, you will receive an e-mail, notifying you that your case has been updated.

Trademarks

Sony, Battery Checker, Click to Disc, Click to Disc Editor, SonicStage Mastering Studio, VAIO Control Center, VAIO Edit Components, VAIO Media plus, VAIO Movie Story, VAIO MusicBox, VAIO Power Management, VAIO Power Management Viewer, VAIO Update are trademarks or registered trademarks of Sony Corporation.



and "Memory Stick," "Memory Stick Duo," "MagicGate," "OpenMG," "MagicGate Memory Stick," "Memory Stick PRO," "Memory Stick PRO-HG," "Memory Stick Micro," "M2," Memory Stick logo, VAIO, and the VAIO logo are trademarks or registered trademarks of Sony Corporation.

Blu-ray Disc™ and the Blu-ray Disc logo are trademarks of the Blu-ray Disc Association.

Intel, Pentium, and Intel SpeedStep are trademarks or registered trademarks of Intel Corporation.

Microsoft Windows Vista, Windows Media Center Edition, MS Works, Microsoft Office 2007 Home & Student, Microsoft Office Ready 2007 and the Windows logo are trademarks or registered trademarks of Microsoft Corporation in the U.S. and other countries.

i.LINK is a trademark of Sony used only to designate that a product contains an IEEE 1394 connection.

Roxio Easy Media Creator is a trademark of Sonic Solutions.

WinDVD for VAIO and WinDVD BD for VAIO are trademarks of InterVideo, Inc.

ArcSoft and the ArcSoft logo are registered trademarks of ArcSoft, Inc. ArcSoft WebCam Companion is a trademark of ArcSoft, Inc.

ATI and ATI Catalyst are trademarks of Advanced Micro Devices, Inc.

The Bluetooth word mark and logos are owned by the Bluetooth SIG, Inc., and any use of such marks by Sony Corporation is under license. Other trademarks and trade names are those of their respective owners.

Design and specifications are subject to change without notice.  **Bluetooth®**

The ExpressCard word mark and logos are owned by the PCMCIA and any use of such marks by Sony Corporation is under license. Other trademarks and trade names are those of their respective owners.

SD Logo is a trademark. 

SDHC Logo is a trademark. 

MultiMediaCard™ is a trademark of MultiMediaCard Association.

ENERGY STAR and the ENERGY STAR mark are registered U.S. marks.

All other names of systems, products, and services are trademarks of their respective owners. In the manual, the ™ or ® marks are not specified.

Specifications are subject to change without notice. All other trademarks are trademarks of their respective owners.

See the online specifications to find out what software is available for your model.

