

Sony Notebook User Guide

PCG-R600 Series



Read this first

Notice

© 2001 Sony Corporation. All rights reserved.

This manual and the software described herein, in whole or in part, may not be reproduced, translated, or reduced to any machine-readable form without prior written approval.

Sony Corporation provides no warranty with regard to this manual, the software, or other information contained herein and hereby expressly disclaims any implied warranties or merchantability or fitness for any particular purpose with regard to this manual, the software or such other information. In no event shall Sony Corporation be liable for any incidental, consequential, or special damages, whether based on tort, contract, or otherwise, arising out of or in connection with this manual, the software, or other information contained herein or the use thereof.

Macrovision: This product incorporates copyright protection technology that is protected by method claims of certain U.S. patents and other intellectual property rights owned by Macrovision Corporation and other rights owners. Use of this copyright protection technology must be authorized by Macrovision Corporation, and is intended for home and other limited viewing uses only unless otherwise authorized by Macrovision Corporation. Reverse engineering or disassembly is prohibited.

Sony Corporation reserves the right to make any modification to this manual or the information contained herein at any time without notice. The software described herein is governed by the terms of a separate user license agreement.

Sony, DVgate, i.LINK™, Jog Dial™ Control, PictureGear, PictureToy, MovieShaker, Smart Capture, SonicStage, Sony Notebook Setup, UI Design Selector, VisualFlow, Memory Stick™ and the Memory Stick logo, VAIO and the VAIO logo are trademarks of Sony Corporation. The Microsoft, Windows, the Windows logo, Windows Media and Outlook trademarks or registered trademarks of U.S. Microsoft Corporation in the U.S. and other countries.

i.LINK™ is a trademark of Sony used to designate that a product contains an IEEE1394-connection.

Adobe® and Adobe® Acrobat® Reader are trademarks of Adobe Systems Incorporated.

QuickTime and the QuickTime logo are trademarks used under license. QuickTime is registered in the U.S. and other countries.

RealPlayer and RealJukebox are trademarks or registered trademarks of RealNetworks, Inc. in the U.S. and other countries.

PowerPanel is a trademark of Phoenix Technologies Ltd.

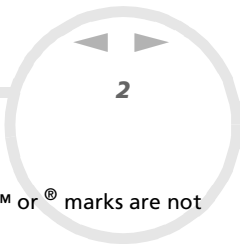

Symantec Norton AntiVirus is a trademark of Symantec Corporation.

All other names of systems, products and services are trademarks of their respective owners. In the manual, the ™ or ® marks are not specified.

Specifications are subject to change without notice.

All other trademarks are trademarks of their respective owners.

Energy Star®

As an Energy Star® Partner, Sony has determined that this product meets the Energy Star® guidelines for energy efficiency.

The International ENERGY STAR® Office Equipment Program is an international program that promotes energy saving through the use of computers and their office equipment. The program backs the development and dissemination of products with functions that effectively reduce energy consumption. It is an open system in which business proprietors can participate voluntarily. The targeted products are office equipment such as computers, displays, printers, facsimiles and copiers. Their standards and logos are uniform among participating nations.

ENERGY STAR is a U.S. registered mark.



Safety information

Owner's record

The serial number and model number are located on the bottom of your Sony notebook. Record the serial number in the space provided here. Refer to the model number and serial number if you call VAIO-Link.

Serial number: _____

Model number: PCG-622M (PCG-R600MEP) / PCG-621M (PCG-R600HEP/HEPD)

Warnings

General

- Opening the unit, for whatever reason, could lead to damages that are not covered by the guarantee.
- To avoid electrical shock, do not open the cabinet. Refer servicing to qualified personnel only.
- To prevent fire or shock hazard, do not expose your VAIO notebook to rain or moisture.
- Avoid using the modem during a severe electrical storm.
- Do not use the modem or a telephone to report a gas leak in the vicinity of the leak.
- To change the backup battery, please contact your nearest Sony Service Center.
- Before you connect peripherals, turn off the computer and all peripherals.
- Connect the power cord only after connecting all cables.
- Turn on the computer only after turning off all peripherals.

- ❑ The magnetic properties of some objects can have serious consequences for your hard disk drive. They can erase the data on the hard disk drive and cause the computer to malfunction. Do not place your computer near or on any objects which emit magnetic fields, mainly:
 - ❑ TV sets
 - ❑ Speakers
 - ❑ Magnets
 - ❑ Magnetic bracelets.

Audio/video

- ❑ Audio and picture distortion may occur if this equipment is positioned in close proximity to any equipment emitting electromagnetic radiation.

Connectivity

- ❑ Never install modem or telephone wiring during a severe lightning storm.
- ❑ Never install telephone jacks in wet locations unless the jack is specifically designed for wet locations.
- ❑ Be cautious when installing or modifying telephone lines.
- ❑ Use your notebook only with the supplied AC adapter. To disconnect your notebook completely from mains voltage, unplug the AC adapter. AC adapter mains connector and power cord: hazardous voltage to EN 60950. All other connectors for this notebook are SELV (Safety Extra Low Voltage), according to EN 60950.
- ❑ Please make sure that the socket outlet is easily accessible.
- ❑ Never touch uninsulated telephone wire or terminals unless the telephone line has been disconnected at the network interface.

Optical disc drive

- ❑ Misuse of the optical instruments supplied with your notebook can cause eye hazard. As the laser beam used in this product is harmful to eyes, do not attempt any disassembling process. For servicing, refer to qualified personnel only.
- ❑ There are visible and invisible radiations when the optical disc drive is open: avoid direct exposure to the laser beam.

Regulatory information

This product conforms to the following European Directive:

1999/5/EC (radio equipment and telecommunications terminal equipment Directive).



This product complies with EN 55022 Class B and EN 55024 for use in following areas: residential, commercial and light-industrial.

This product has been tested and found compliant with the limits set out in the EMC Directive for using connection cables not longer than 3 metres (9.8 feet).

The optical disc drive is classified as a CLASS 1 LASER PRODUCT and complies with the Laser Product Safety Standard EN 60825-1. Repair and maintenance only by authorized Sony technicians. Improper repairs and use can create safety hazards.

**CLASS 1
LASER PRODUCT
TO EN 60825-1**

Disposing of lithium ion batteries

- ❑ Do not handle damaged or leaking lithium ion batteries. Dispose of promptly and properly at end-of-life.
- ❑ Danger of explosion if the battery is incorrectly replaced. Replace only with the same or equivalent type recommended by the manufacturer. Discard used batteries according to the manufacturer's instructions.
- ❑ The battery pack used in this device may present a fire or chemical burn hazard if mistreated. Do not disassemble, heat above 60°C (140°F) or incinerate.
- ❑ Keep away from children.
- ❑ In some areas the disposal of lithium ion batteries in household or business waste may be prohibited.
- ❑ Use the public collection system.

Disposing of internal memory backup battery

- ❑ Your notebook is equipped with an internal memory backup battery that should not have to be replaced during the lifetime of the product. For changing this battery, please contact VAIO-Link.
- ❑ Dispose of properly at end-of-life.
- ❑ In some areas the disposal of lithium ion and other non-hazardous batteries in household or business waste may be prohibited.
- ❑ Please use the public collection system.

Welcome

Congratulations on purchasing a Sony VAIO notebook. Sony has combined leading-edge technology in audio, video, computing and communications to provide you with state-of-the-art personal computing.

Here are just some of the features your VAIO notebook has to offer:

- ❑ **Exceptional performance** - Your PC includes a fast processor and an internal modem.
- ❑ **Portability** - The rechargeable battery pack provides hours of use without AC power.
- ❑ **Sony audio and video quality** - A high-resolution LCD screen enables you to take advantage of today's advanced multimedia applications, games, and entertainment software.
- ❑ **Multimedia features** – Enjoy audio and video CDs.
- ❑ **Interconnectivity** – Your computer has Ethernet and i.LINK™ functionalities. i.LINK™ is a bi-directional digital interface for exchanging data.
- ❑ **Windows®** - Your system includes the Microsoft Windows® XP Professional operating system.
- ❑ **Communications** - Access popular online services, send and receive e-mails, browse the Internet...
- ❑ **Excellent customer support** - If you are experiencing any problems with your computer, please check the VAIO-Link website for a possible solution:

<http://www.vaio-link.com>

Before contacting VAIO-Link, you may try to solve the problem by reading the User Guide or the manuals and help files for the peripherals or software.

Documentation pack

Your Documentation Pack contains paper and online user guides on a Documentation CD-ROM.

Printed documentation

- ❑ A **Getting Started** brochure, where you find a brief description of the items in your box, some specifications of your notebook, and how to setup your notebook;
- ❑ A **Customer Guide**, where you find all the basic information you need to start using your notebook, as well as troubleshooting and VAIO-Link information;
- ❑ Your **Sony Guarantee conditions**;
- ❑ A **Safety Regulations** flyer;
- ❑ A **Modem Regulations** flyer.

Online documentation

- 1 The Sony Notebook User Guide:
 - ❑ **Using Your Sony Notebook** shows you how to use the standard components of your system. In this part of the manual you will also find out what you can do with a **Memory Stick™**.
 - ❑ **Connecting Peripheral Devices** explains how you can add functionality by connecting various peripherals.
 - ❑ **Getting Help** explains the support options available to you, and offers basic troubleshooting tips.
 - ❑ **Precautions** provides facts and advice about using your notebook.
 - ❑ **Specifications** provides details on your computer, drivers and accessories.
 - ❑ **Glossary** refers to terms used in this manual.

- 2 Refer to your **Software Guide** for information on the bundled software and the Sony applications.
 - ❑ **About the Software** is a short description of the features of the software pre-installed on your system.
 - ❑ **Customizing your notebook** explains how to set your system and power management.
 - ❑ **Using the Product Recovery CD-ROMs** explains how to perform a system and application recovery.
- 3 Consult the **Online Help** files of the software you are using for detailed information on features and troubleshooting.
- 4 Refer to the Microsoft **Quick Start** manual for more information on Windows®.
- 5 Go to <http://www.club-vaio.sony-europe.com> to find online tutorials about your favorite VAIO software.

Your notebook and its accessories

Remove the following hardware items from the box:

1

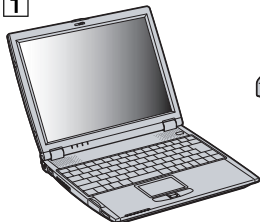

2

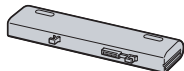

3



4



5

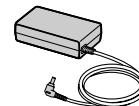

6



7



8



9

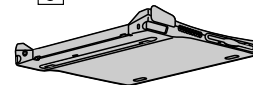

1	main unit	6	power cord
2	rechargeable battery pack	7	phone plug (country specific)
3	product recovery CD-ROMs	8	phone cable
4	documentation pack	9	docking station (only bundled with PCG-R600HEPD)
5	AC adapter		

Ergonomic considerations

You will be using your notebook as a portable device in a variety of environments. Whenever possible, you should attempt to take account of the following ergonomic considerations to both stationary and portable environments.

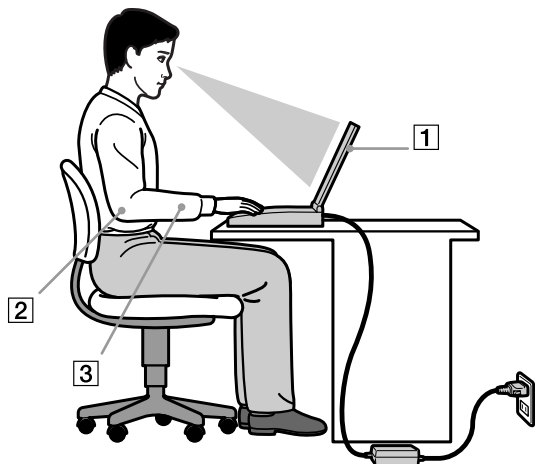

- ❑ **Position of your computer** – Place the computer directly in front of you (1). Keep your forearms horizontal (2), with your wrists in a neutral, comfortable position (3) while using the keyboard, touchpad, or external mouse. Let your upper arms hang naturally at your sides. Have breaks during sessions with your computer. Excessive use of the computer may strain muscles or tendons.
- ❑ **Furniture and posture** – Sit in a chair with good back support. Adjust the level of the chair so your feet are flat on the floor. A footrest may make you more comfortable. Sit in a relaxed, upright posture and avoid slouching forward or leaning far backwards.

- ❑ **Viewing angle of the computer's display** – Use the display's tilting feature to find the best position. You can reduce eye strain and muscle fatigue by adjusting the tilt of the display to the proper position. Adjust the brightness setting of the display as well.
- ❑ **Lighting** – Choose a location where windows and lights do not create glare and reflection on the display. Use indirect lighting to avoid bright spots on the display. You can also purchase accessories for your display that help reduce glare. Proper lighting adds to your comfort and work effectiveness.
- ❑ **Placement of an external display** – When using an external display, set the display at a comfortable viewing distance. Make sure the display screen is at eye level or slightly lower when you are sitting in front of the monitor.

Using your notebook

This section describes how to start using your computer and how to use your computer's internal and external devices.

Locating controls and connectors

Right

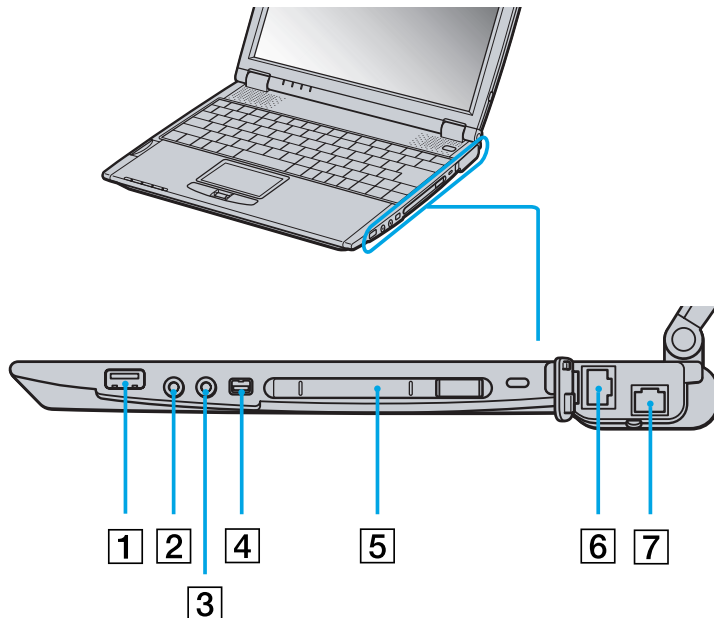

1	USB connector	(page 62)
2	headphone connector	(page 61)
3	microphone connector	(page 61)
4	S400 i.LINK™ connector	(page 64)
5	PC Card slot	(page 33)
6	Ethernet network connector	(page 68)
7	phone line jack	(page 43)

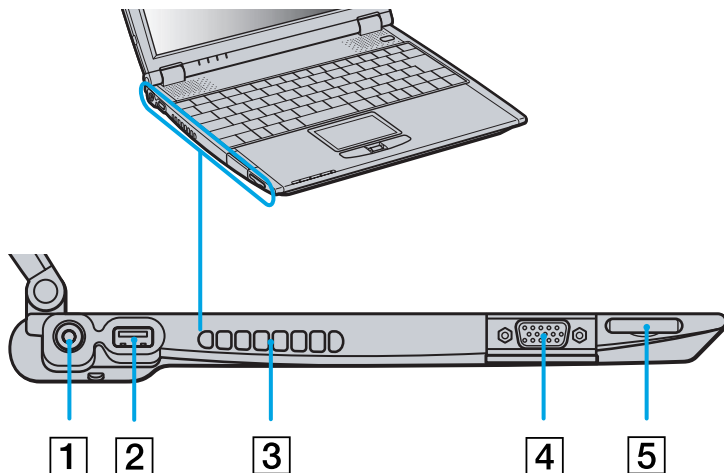
Left

1	DC In	(page 17)	4	monitor connector	(page 57)
2	USB connector	(page 62)	5	MagicGate™ Memory Stick™ slot	(page 35)
3	ventilation slot	/			



Front

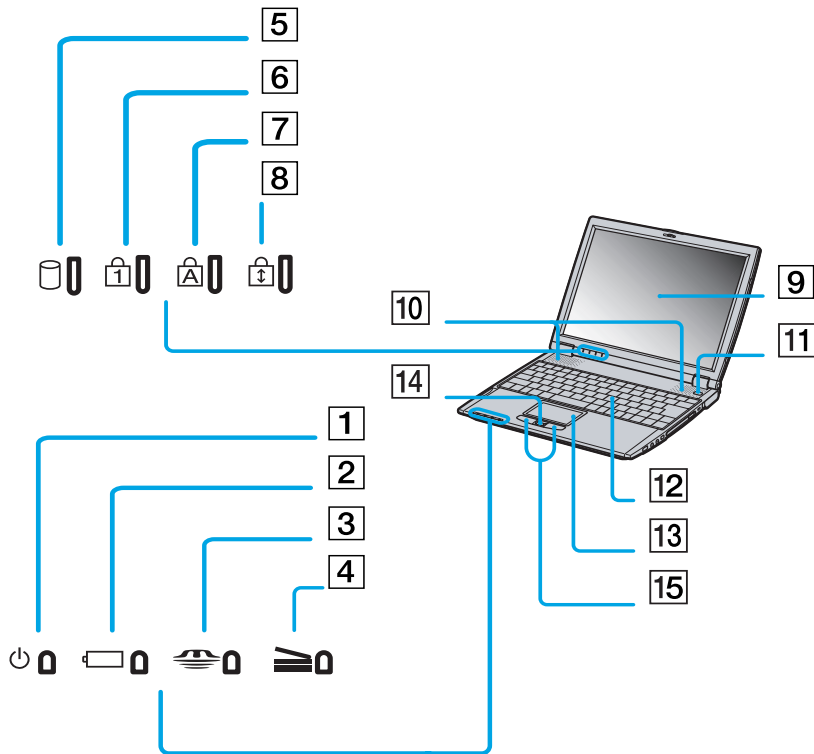

1	power indicator	(page 21)
2	battery indicator	(page 27)
3	Memory Stick™ indicator	(page 27)
4	docking station indicator	(page 27)
5	hard disk drive indicator	(page 27)
6	Num Lock indicator	(page 27)
7	Caps Lock indicator	(page 27)
8	Scroll Lock indicator	(page 27)
9	LCD screen	(page 28)
10	speakers	(page 28)
11	power switch	(page 21)
12	keyboard	(page 24)
13	touchpad	(page 29)
14	Jog Dial™	(page 30)
15	left/right buttons	(page 29)

There is a ventilation slot located near the power switch. Do not cover the ventilation slot when your computer is on.

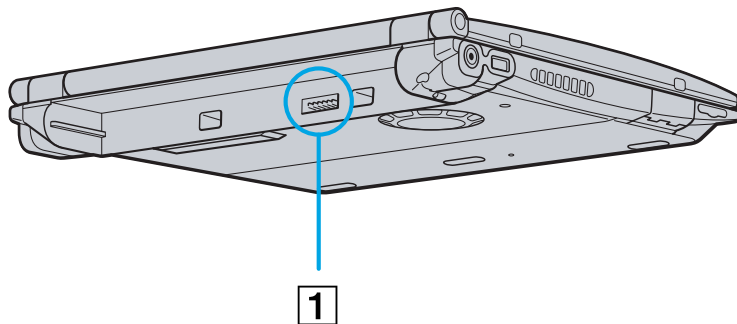
Back

1	battery connector	(page 18)
---	-------------------	---------------------------

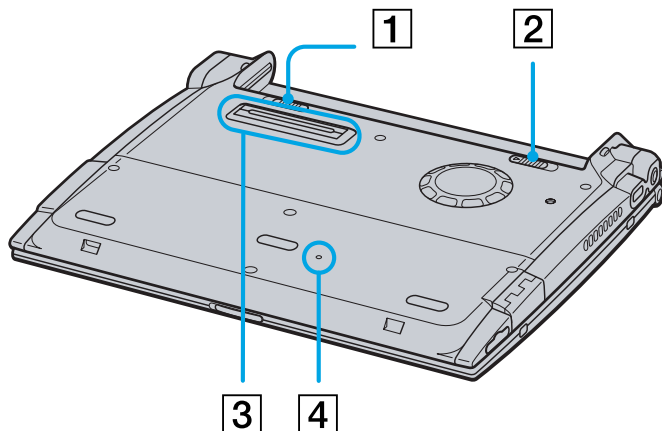
Bottom

1	battery lock lever	(page 18)
2	battery release lever	(page 18)
3	docking connector	(page 47)
4	reset switch	/

Connecting a power source

You can use either an AC adapter or a rechargeable battery pack as a power source.

Using the AC adapter

To use the AC adapter, proceed as follows:

- 1 Plug the cable attached to the AC adapter (1) into the DC In connector (2) on the computer.
- 2 Plug one end of the power cord (3) into the AC adapter.
- 3 Plug the other end of the power cord into an AC outlet.

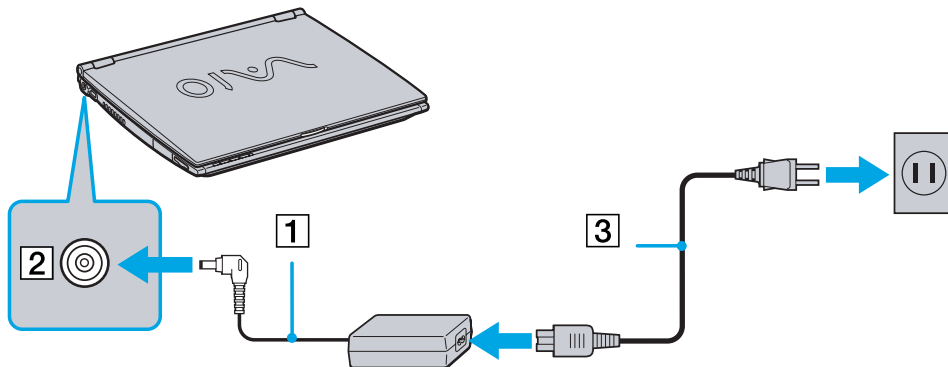

Use your notebook only with the supplied AC adapter.

If the main unit is connected to an optional docking station, you can only use the DC In connector on the docking station.

To disconnect your notebook completely from mains voltage, unplug the AC adapter.

Make sure that the socket outlet is easily accessible.

Using the battery pack

You can use a battery pack as a source of power.

The battery pack supplied with your computer is not fully charged at the time of purchase.

Inserting the battery pack

To insert the battery, proceed as follows:

- 1 Move the lock lever (1) on the bottom of the computer to the **Unlock** position.

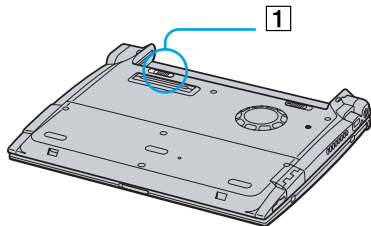

- 2 Align the grooves (2) and tabs on the battery (3) with the tabs and notches on the back of the computer, and then slide the battery towards the computer until it clicks into place.

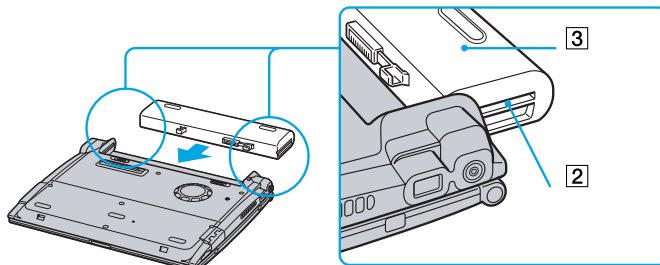

- 3 Slide the lock lever into the **Lock** position to secure the battery on the computer.

 When the computer is directly connected to AC power and has a battery pack inserted in the battery bay, it uses power from the AC outlet.

! Make sure the cover is closed before inserting the battery pack.

Charging the battery pack

To charge the battery pack, proceed as follows:

- 1 Connect the AC adapter to the computer.
- 2 Insert the battery pack.

The computer automatically charges the battery (the battery indicator light flashes in a double blink pattern as the battery charges). When the battery is 85% full, the battery indicator light turns off. This process takes approximately two and a half hours if the notebook is on. To charge the battery completely, continue charging for an additional hour.

<i>Battery indicator light status</i>	<i>meaning</i>
On	The computer is using battery power.
Single blink	The battery is running out of power.
Double blink	The battery is charging.
Off	The computer is using AC power.

 When the battery is running out of power, both the battery and power indicators blink.

Keep the battery pack in the computer while it is directly connected to AC power. The battery pack continues to charge while you are using the computer.

If the battery level falls to below 10%, you should either attach the AC adapter to recharge the battery or shut down your computer and insert a fully charged battery.

You can extend battery life by changing the power management modes in the PowerPanel utility.

The battery pack supplied with your computer is a lithium ion battery and can be recharged any time. Charging a partially discharged battery does not affect battery life.

The battery indicator light is on while you use the battery pack as a power source. When the battery life is nearly depleted, the battery indicator starts flashing.

Removing the battery pack

To remove the battery pack, proceed as follows:

- 1 Turn off the computer and close the cover.
- 2 Slide the lock lever (1) to the **Unlock** position.
- 3 Slide the release lever (2) to the **Unlock** position and slide the battery away from the computer.

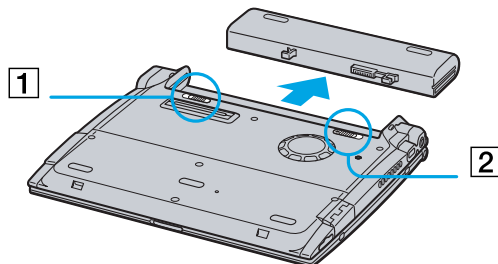

You can remove the battery pack without turning off the computer when it is connected to the mains voltage (AC adapter).

Close the cover before you remove the battery pack.

You may lose data if you remove the battery pack while the computer is on and not connected to the AC adapter or if you remove the battery while the computer is in **Standby** mode.

Starting your notebook

To start your computer, proceed as follows:

- 1 Slide the LCD lock lever (1) in the direction of the arrow, and lift the cover.

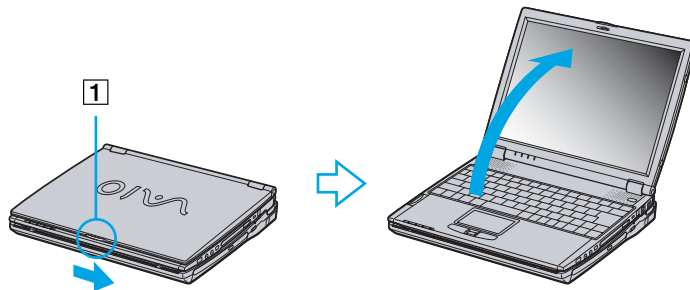

- 2 Press the power switch (2) of the computer until the green power indicator (3) light turns on.

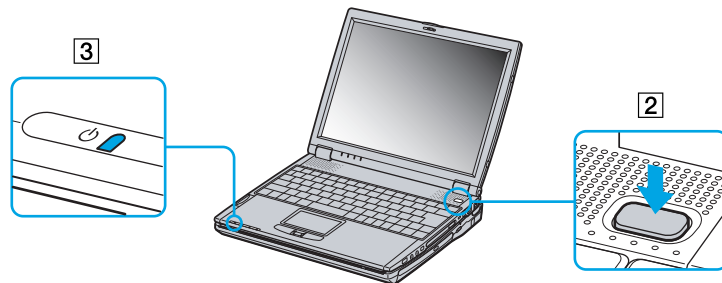

- 3 If necessary, press **<Fn>+<F5>** to adjust the brightness controls for the LCD display. To increase the brightness, use the up or right arrow keys. To decrease, use the down or left arrow keys.

 If you hold the power switch in the on position for more than four seconds, the computer will turn off.

Shutting down your notebook

It is important that you shut down your computer properly so you do not lose unsaved data.

To shut down your computer, proceed as follows:

- 1 Click the **Start** button.
- 2 Click **Turn Off Computer**.
The **Turn off computer** screen appears.
- 3 Click **Turn Off**.
Wait for your computer to turn off automatically.
The power indicator turns off.
- 4 Turn off any peripherals connected to your computer.

 Respond to any prompts warning you to save documents or to consider other users.

If you are unable to shut down your computer;

- Close all software in use.

- If applicable, remove the PC Card. To do so, double-click the **Safely Remove Hardware** icon in the taskbar. Select the hardware you want to unplug and click **Stop**.

- Disconnect any USB devices.

Press **<Alt>+<F4>** and select **Turn Off** from the screen that appears.

If this does not work, you can press the power button for more than four seconds. This will shut down the computer. This operation may result in loss of data.

If you want to shut down the computer for a short period only, you can save power by using the **Standby** mode. Go to the **Start** menu, select **Turn Off Computer**, and then click on **Stand By**.

Registering your notebook

By registering your computer, you can take advantage of Sony's commitment to quality customer support and receive the following benefits:

- ❑ **VAIO-Link** – If you are experiencing any problems with your computer, you can check the VAIO-Link website for a possible solution:
<http://www.vaio-link.com>
- ❑ **Guarantee** – Protect your investment. See the **Guarantee** sheet for the terms and conditions and refer to your **Customer Service Guide** for more information.

To register your Sony VAIO desktop, proceed as follows:



- 1 Click on the **VAIO Online Registration** icon in the **Start** menu.
- 2 Fill in your Registration card fields.
- 3 Scroll down to the bottom of the form and click **Send**.
- 4 Click **OK**.

 To access the online Registration Web page, you must have an Internet connection, connect your phone line and configure your modem.

Using the keyboard

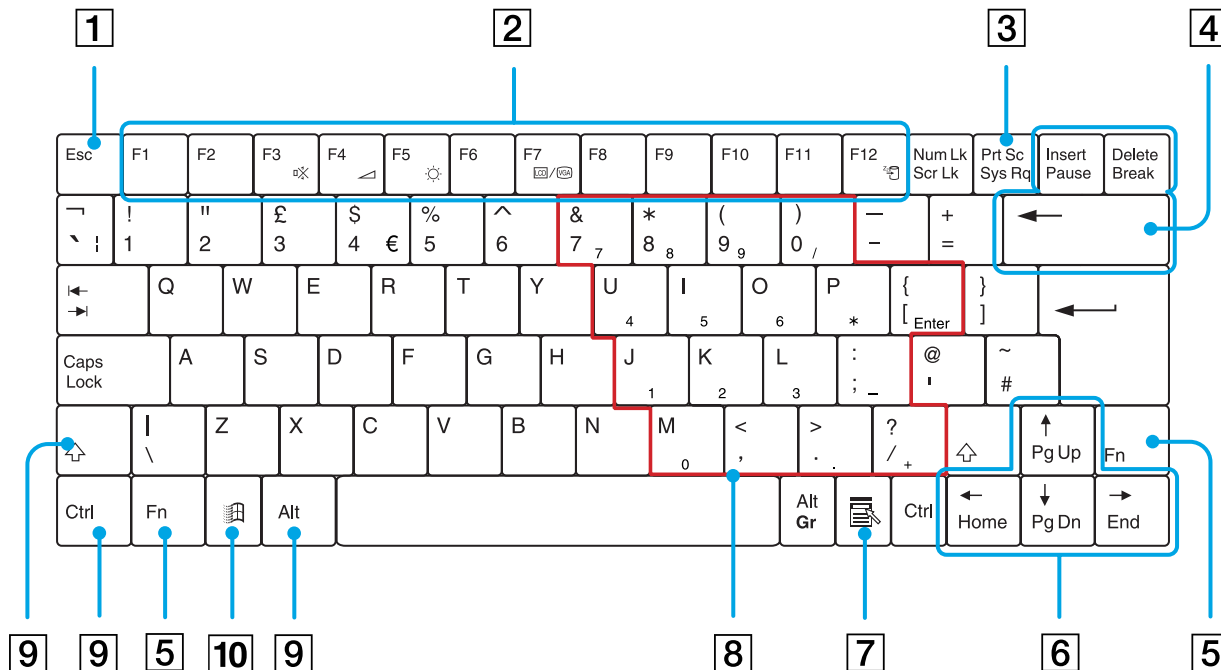
Your keyboard is very similar to a desktop computer's, but the keyboard has additional keys that perform specific notebook-related tasks.











<i>Keys</i>	<i>Descriptions</i>
Escape key (1)	The <Esc> (Escape) key is used to cancel commands.
Function keys (2)	The twelve function keys along the top of the keyboard are used to perform designated tasks. For example, in many applications, <F1> is the Help key. The task associated with each function key may vary from one application to the next.
Print Screen key (3)	The <Print Screen> key takes an electronic snapshot of the screen and moves it to the Windows Clipboard . You can then paste the screenshot into a document and print it.
Correction keys (4)	The <Insert> , <Back Space> and <Delete> keys enable you to make corrections.
<Fn> key (5)	The <Fn> key is used in combination with other keys to execute commands.
Navigation keys (6)	These keys enable you to move the cursor on the screen.
Application key (7) 	The Application key displays a shortcut menu; pressing this key is equivalent to clicking the right mouse button.
Numeric keypad area (8)	Contains the keys found on a typical calculator. Use the numeric keypad area to type numbers or to perform mathematical calculations such as addition and subtraction. Note that you must press the <Num Lock> key to activate the numeric keypad. When you do so, the <Num Lock> indicator illuminates.
Operator keys (9)	Several keys are always used with at least one other key: <Ctrl> , <Alt> , and <Shift> . When held down with another key, the <Ctrl> (Control) and <Alt> (Alternate) keys offer another way to execute commands. For example, in many applications, instead of choosing the Save command from a menu, you can hold down <Ctrl> and press <S> (referred to as <Ctrl>+<S>). The <Shift> key is used to produce capital letters or special symbols such as @ and \$.
Windows® key (10) 	The key with the Windows® logo displays the Windows® Start menu; it is equivalent to clicking the Start button on the taskbar.





Combinations and functions with the <Windows> key





Combinations

Functions















 + F1	Displays Help and Support Center .
 + Tab	Switches the selected button on the taskbar.
 + E	Displays My Computer .
 + F	Displays the Search Results window to find a file or folder. This is equivalent to selecting Search and then All files and folders from the Start menu.
 + Ctrl + F	Displays the Search Results - Computers window where you can locate other computers.
 + M	Minimizes all displayed windows.
Shift +  + M	Returns all minimized windows to their previous size.
 + R	Displays the Run window. This is equivalent to selecting Run from the Start menu.
<Fn> +  + Insert	Displays the System Properties window. This is equivalent to double-clicking the System icon in the Control Panel .

Indicators

Indicator	Functions
Power 	Power on: lights green. Standby mode: flashes amber. Hibernate mode: turns off.
Battery 	Indicates the status of the battery inserted in the computer.
Memory Stick™ 	Turns on when the Memory Stick™ is in use. Turns off when the Memory Stick™ is no longer in use.
Docking station 	Turns on when the docking station is in use. Turns off when the docking station is no longer in use.

Light	On	Off
 hard disk	Data is read from or written to the hard drive. Do not enter Standby mode or turn off the computer when this indicator light is on.	The hard drive is not being accessed.
 Num Lock	Turns on when the number keys in the numeric keypad are active.	Turns off when the alphanumeric character keys in the keypad area are active.
 Caps Lock	Turns on when the letters appear in uppercase as you type. The <Shift> key lowers the case of typed letters when Caps Lock is on.	Turns off when the letters appear in lowercase as you type (unless you hold down the <Shift> key).
 Scroll Lock	Turns on when the screen scrolls differently (depends on the application, no effect in many applications.)	Turns off when the information moves across the display normally.

Combinations and functions with the <Fn> key

Combinations/ Feature	Functions
<Fn>+  (ESC): Standby	Puts the system into Standby mode, a power management state. To return the system to the active state, press any key.
<Fn>+  (F3): speaker switch	Toggles the built-in speaker on and off.
<Fn> +  (F4): speaker volume	Adjusts the built-in speaker volume. To increase volume, press <Fn>+<F4> and then  or  To decrease volume, press <Fn>+<F4> and then  or 
<Fn> +  (F5): brightness control	Adjusts the brightness of the LCD. To increase lightness intensity, press <Fn>+<F5> and then  or  To decrease light intensity, press <Fn>+<F5> and then  or 
<Fn>+  /  (F7)*: switch to the external display	Toggles between the LCD, external display (connected to the monitor connector) and both LCD and external display.
<Fn>+  (F12): Hibernate	Provides for the lowest level of power consumption. When you execute this command, the states of the system and of the peripheral devices are written to the hard disk and the system power is turned off. To return the system to its original state, use the power switch to turn on the power.

* First you need to connect your external display, then you turn on your notebook. When you connect your external display when the computer is already on, you cannot use the key combination <Fn>+<F7>.

* This function can only be used by the first user to log in. It will not work if you have switched to another user account.

 Some functions are not available until Windows is launched.

Using the touchpad

The keyboard contains a cursor-pointing device, your touchpad. You can point to, select, drag, and scroll objects on the screen using the built-in touchpad.

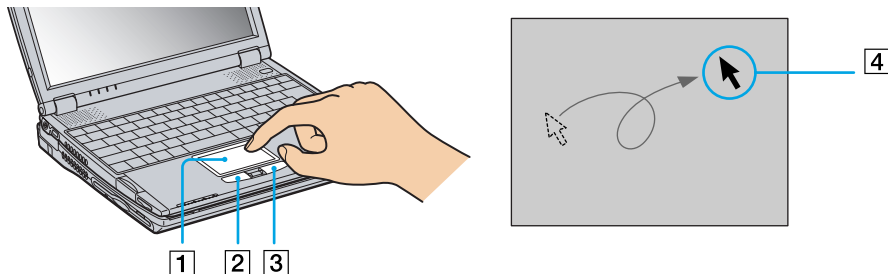

<i>Action</i>	<i>Description</i>
point	Slide one finger on the touchpad (1) to place the pointer (4) on an item or object.
click	Press the left button (2) once.
double-click	Press the left button twice.
right-click	Press the right button (3) once. In many applications, this action displays a shortcut menu.
drag	Slide one finger while pressing the left button.
scroll	Move your finger along the right edge of the touchpad to scroll vertically. Move your finger along the bottom to scroll horizontally. (The scroll function is available only with applications that support a touchpad scroll feature.)

Using the Jog Dial™

Your computer is equipped with a **Jog Dial™** (1) between the right and the left buttons of your computer. You can turn (2) or / and press (3) the Jog Dial™ to scroll the window, select a software, adjust the internal speaker volume, etc.

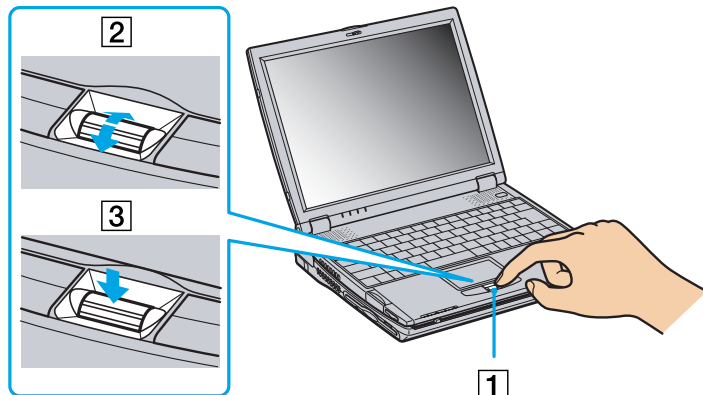



The Jog Dial™ window is always displayed on the screen. This window has two modes: Launcher mode or Guide mode.



The Jog Dial™ window is in Launcher mode until you start an application or the Jog Dial™ window becomes active. When an arrow appears next to an item in the Jog Dial™ window, you can display a submenu for that item by selecting it and pressing the Jog Dial™.



The Jog Dial™ window switches to Guide mode when you start an application and its window becomes active. Depending on the application, the Jog Dial™ window displays different commands that you can select or execute by rotating or pressing the Jog Dial™.

 You can adjust the size of the Jog Dial™ window or close it. To display the Jog Dial™ window, double-click  or  in the system tray.

To use the Jog Dial™ in Launcher mode, proceed as follows:

- 1 Click the **Jog Dial™** window or press the Jog Dial™ while pressing the <Ctrl> key to switch to Launcher mode.
- 2 Turn the Jog Dial™ to select an item, then press the Jog Dial™. The Jog Dial™ window switches to Guide mode, and shows the Jog Dial™ function.



- 3 Turn or press the Jog Dial™ to use the Jog Dial™ function.
- 4 To select another item, switch to Launcher mode and repeat this procedure.

Software supporting Jog Dial™

If the Sony software supporting the Jog Dial™ control is active, you can use Jog Dial™ control functions allocated to each software.

Software not supporting Jog Dial™

If the software in use does not support the Jog Dial™, you can scroll the window or adjust the window size.

Using PC Cards

Your computer includes a PC Card slot. PC Cards allow you to connect portable external devices.

Inserting a PC Card

To insert a PC Card, proceed as follows:

- 1 Insert the PC Card into the PC Card slot, front label facing up (1).

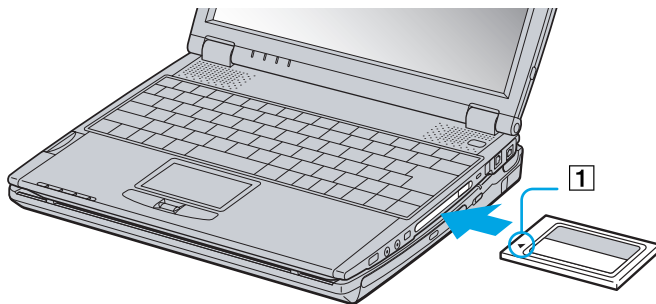

- 2 Gently push the card into the slot until the card is fixed into the connector.



Some PC Cards may require you to disable idle devices when using the PC Card. You can use Sony Notebook Setup to disable devices.

Be sure to use the most recent software driver provided by the PC Card manufacturer.

If an "!" mark appears on the **Device Manager** tab in the **System Properties** dialog box, remove the software driver and then reinstall it.

You do not need to shut down the computer before inserting or removing a PC Card.

Do not force a PC Card into the slot. It may damage the connector pins. If you have difficulty inserting a PC Card, check that you are inserting the PC Card in the correct direction. See the manual supplied with your PC Card for more information on use.

For some PC Cards, if you alternate between **Normal** power operation and **Standby** or **Hibernate** power management modes while the card is inserted, you may find that a device connected to your system is not recognized. Reboot your system to correct the problem.

The computer will return to its original state if you restart it.

You can connect the optional PCGA-CD51/A CD-ROM drive or the optional PCGA-CDRW52 CD-RW drive to the PC Card slot on your notebook. However, do not connect these drives if the main unit is docked. A simultaneous use may cause malfunction.

Removing a PC Card

Follow the steps below to remove the PC Card while your computer is on. If it is not removed properly, your system may not work properly. If you want to remove a PC Card when your computer is off, skip steps 1 to 7.

To remove a PC Card, proceed as follows:

- 1 Double-click the **Safely Remove Hardware** icon in the system tray.
The **Safely Remove Hardware** dialog box appears.
- 2 Select the hardware you want to unplug.
- 3 Click **Stop**.
- 4 In the **Stop a Hardware Device** dialog box, confirm that the device can be safely removed from the system.
- 5 Click **OK**.
A dialog box appears, explaining that it is safe to remove the device.
- 6 Click **OK**.
- 7 Click **Close**.
- 8 Eject the PC Card release button (1) and then press it to eject the card.
- 9 Gently press the card and pull it out.

 If you unplug the PC Card from the computer when it is still turned on, your system might crash and you might lose data that you did not save before.

While the card is inserted, your computer may not enter the **Hibernate** power management mode. It may enter **Standby** mode. It is recommended that you remove the card when your computer enters **Hibernate** mode by pressing the **<Fn>+<F12>** keys or by using the PowerPanel Utility, and when it is set to enter **Hibernate** automatically while using a battery as the source of power.

Some PC Cards or their functions may not be compatible with this computer.

- ! Do not select and stop a USB disk drive, a Sony i.LINK™ CD-RW/DVD-ROM drive or a Sony i.LINK™ DVD-ROM drive.
- ! If you stopped a Sony i.LINK™ CD-RW/DVD-ROM drive or a Sony i.LINK™ DVD-ROM drive by mistake, disconnect the docking station and connect it again.

Using Memory Stick™

Your VAIO computer is designed to support the Memory Stick™. The Memory Stick™ is a compact, portable, and versatile device especially designed for exchanging and sharing digital data with compatible products. Because it is removable, it can be used for external data storage.

Use the flash memory technology to download anything that can be converted into digital data, such as pictures, music, words, sounds, movies and photographs.

Foreseen as the universal data storage device of the future, the Memory Stick™ can already be used with an ever-increasing range of compatible products, including:

- ❑ Audio systems
- ❑ Visual devices
- ❑ VAIO products
- ❑ CLIE handhelds
- ❑ Mobile phones.

There are currently two different types of Memory Stick™:

- ❑ The generic Memory Stick™, coloured blue.
- ❑ The MagicGate Memory Stick™, coloured white.

 You can purchase Memory Sticks™ from the Sony Style website (<http://www.sonystyle-europe.com>), or from your local Sony dealer.

Why Memory Stick™?

Sony's vision is to expand the world of communication, promoting the portability of digital data. The Memory Stick™ is the resulting medium, through which digital devices can be instantly connected. With it, you can download data from any compatible device, then transfer it to another in a single and instant transfer.

The main advantages of the Memory Stick™ are its:

- ❑ **Compactness:** with dimensions of just 21.5 mm (W) x 2.8 mm (H) x 50 mm (D), compatible products can also be small, lightweight and attractive in their design.
- ❑ **Capacity:** Its data capacity far exceeds that of a floppy disk.
- ❑ **Security:** its lock option means you can protect your data from accidental erasure.
- ❑ **Versatility:** memory capacity ranges from 4MB up to 128MB (the equivalent capacity of 88 floppy disks).
- ❑ **Reliability:** by way of protecting the hardware and its contents, the number of terminals is reduced to only 10 pins. This, and the overall robust structure of the stick, gives it a longer lifespan than other storage devices.
- ❑ **Durability:** the same Memory Stick™ can be used tens of thousands of times.
- ❑ **Forward compatibility:** the Memory Stick's™ current format is designed to be compatible with future products and higher capacity Memory Sticks™.

The future of Memory Stick™

Memory Stick's™ potential is virtually unlimited, with the number of **compatible products** increasing rapidly in both personal and professional spheres.

The introduction of the 256 MB and 512 MB Memory Stick™ is anticipated in 2002, and a 1 gigabyte **capacity** Memory Stick™ is expected in 2003. Additionally, the native transfer speed of the Memory Stick™ will be increased to accommodate the increasing capacity. By the end of 2002, Memory Stick's™ **transfer speed** will be increased by eight times to a maximum of 20MB/sec.

Generic Memory Stick™

The original Memory Stick™, blue in colour, can be used to record image data taken with digital still cameras, etc. or data from the PC. With it, you can record, play back and transfer various kinds of data at any given time.



Because it is easy to remove and transport safely, you can use Memory Stick™ anywhere by inserting it into any compatible device to transfer and share the information you have saved.

For you, this means you can expand the capabilities of your VAIO computer in the following scenarios:

- ❑ With your still digital camera, share your holiday pictures instantly by e-mail.
- ❑ From your handycam to your VAIO, make the most of your captured moments with the VAIO's movie editing tools.
- ❑ Carry pictures on you by copying image files from the Internet to your VAIO to your CLIE handheld.
- ❑ With your voice recorder, add your voice to e-mails so your tone is never misunderstood.

The blue Memory Stick™ is currently available with a 4MB, 8MB, 16MB, 32MB, 64MB or a 128MB memory (the equivalent capacity of 88 floppy disks).

 Generic Memory Sticks™ cannot be used with the Memory Stick™ Walkman, or with data that is protected by copyright.

MagicGate Memory Stick™

The MagicGate Memory Stick™, white in colour, records PC and image data just like its blue counterpart; the difference is it uses the MagicGate copyright protection technology.



With this type of Memory Stick™, also called the MG Memory Stick™, you can enjoy the following features:

- ❑ 32MB, 64MB and 128MB capacity versions.
- ❑ Storage of up to 120 minutes of audio data.
- ❑ Download and save:
 - ❑ digital music
 - ❑ pictures
 - ❑ movies, and more.
- ❑ Combine data files to add music to your home movies, for example.
- ❑ Transfer and share data between several digital products.
- ❑ MagicGate Copyright Protection Technology.
- ❑ SDMI (Secure Digital Music Initiative) Compliance.
- ❑ SonicStage software.

So that you further distinguish a MagicGate Memory Stick™ from a generic one, look for:

- ❑ the  logo printed on it
- ❑ a protruding dot located on the back.

 MagicGate is a copyright protection technology that complies with the standards set by SDMI (Secure Digital Music Initiative, an organization working to draw up industry standard specifications in order to protect copyrights of digital music).

The  logo indicates the copyright protection system devised by Sony. It is not meant to guarantee compatibility with other media.

MagicGate

MagicGate refers to the copyright protection technology used by the MagicGate Memory Stick™ and other MagicGate Memory Stick™ compatible devices.

The Memory Stick™ Walkman and MagicGate Memory Stick™ work together to check the data and ensure it complies with copyright protection.

If no problems are detected, the data is exchanged in encrypted form; if authentication is not passed, data cannot be exchanged or played back.

SonicStage

This is a copyright protection technology that is used to manage the digital music content downloaded to the PC from CDs, the Internet and/or other sources.

Software installed on the PC records music content in encrypted form onto the hard disk. As well as allowing you to enjoy music on the PC, this technology protects against unauthorized distribution on the Internet. Since it is compatible with MagicGate, you can use SonicStage to transfer music that you have downloaded onto your PC to your MG Memory Stick™, and playback on other Magic Gate-equipped devices and media.

Copyright protection

People who create artistic works such as music are entitled to a "copyright", meaning that they have exclusive rights to dictate how their work is used. When they are created, artistic works are automatically protected by a copyright without having to submit notification or registration, and may not be used without the permission of the person who created the work.

In the music world, however, illegal acts of distributing music without the permission of the artist, particularly on the Internet, have recently been on the increase. That is why the Recording Industry

Association of America (RIAA) took the initiative to organize a forum called Secure Music Digital Initiative (SDMI) to study technology for protecting copyrights during the electronic distribution of music. Sony offers the MagicGate Memory Stick™ and Memory Stick™ Walkman with a copyright protection function that complies with SDMI standards, thereby providing an environment where individuals can record and enjoy third-party music data without worrying about copyright infringement.

 Literary works that are recorded by individuals are permitted for private usage only.

Compatible devices

There are nearly 80 Memory Stick™-enabled products on the market or announced for introduction worldwide, ranging from camcorders and portable music players to voice recorders and many other electronic devices.

You can currently use Memory Sticks™ with the following Sony products:

Visual:

- Cybershot digital camera
- Mavica digital camera
- PC, TRV and VX series digital video cameras
- LC data projector

Audio:

- MS Walkman
- MS Hi-fi system
- Network Walkmans
- Voice recorders

Other:

- ❑ VAIO notebooks
- ❑ VAIO desktops
- ❑ CLIE Handheld Entertainment Organiser
- ❑ Sony mobile phones
- ❑ Digital printers
- ❑ AIBO the Sony Entertainment Robot

To find out more about the products available in your country, go to:

<http://www.sonystyle-europe.com>

Inserting a Memory Stick™

To insert a Memory Stick™, proceed as follows:

- 1 Once you have stored your data from your digital device, insert the Memory Stick™ with the arrow facing up and toward the Memory Stick™ slot.
- 2 Carefully slide the Memory Stick™ into the slot until it clicks in place. The Memory Stick™ is automatically detected by your system and appears in your **My Computer** window as a local drive, under the appropriate letter (depending on the configuration of your computer).

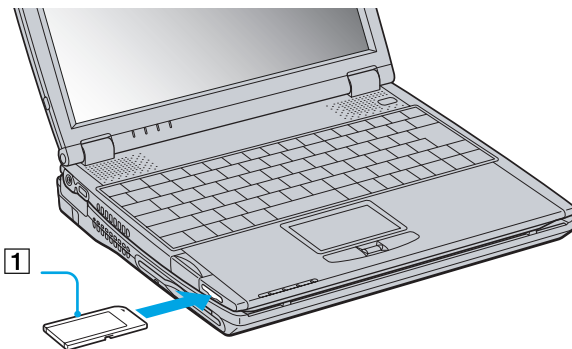

Hold the Memory Stick™ with the arrow pointing in the correct direction when you insert it into the slot. To avoid damaging the computer or the Memory Stick™, do not force the Memory Stick™ into the slot if it does not insert smoothly.

Removing a Memory Stick™

To remove a Memory Stick™ using the Memory Stick™ slot, proceed as follows:

- 1 Check that the access light is off.

- 2 Push the Memory Stick™ in toward the notebook.
The Memory Stick™ ejects.
 - 3 Pull the Memory Stick™ out of the slot.
-  Always remove the Memory Stick™ gently, or it may pop out unexpectedly.
It is recommended to remove the Memory Stick™ before shutting down the computer.

Write-protecting a Memory Stick™

Memory Sticks™ are designed with an erasure prevention switch to protect valuable data from accidental erasure or overwriting.

Move the tab to the right or left to set or release write-protection. When the erasure prevention switch is off, data can be saved on the Memory Stick™. When the erasure prevention switch is on, data can be read from but not saved on the Memory Stick™.

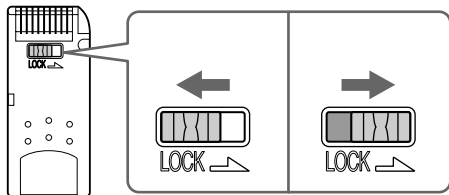

Using the modem

Your notebook is equipped with an internal modem.

You need to connect to a phone line to take advantage of online services and the Internet, but also to register your computer and software online, and to contact VAIO-Link.

To connect a phone line, proceed as follows:

- 1 Plug one end of the phone cable (1) into the phone line jack on the computer.

2 Plug the other end into the wall jack (2).

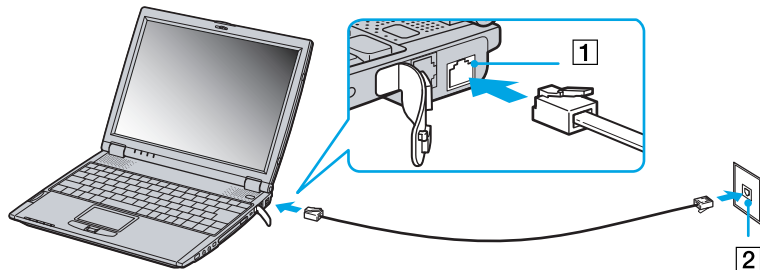

 Do not pull the flexible cover too forcefully.

A country-specific phone plug is supplied with your VAIO notebook, allowing you to plug the phone line into the wall jack. We recommend you to use the supplied plug, because the usage of any other phone plug can decrease the connection quality.

Your computer cannot be connected to a coin-operated telephone, and may not work with multiple phone lines or a private branch exchange (PBX). If you connect the modem to a parallel connected phone line, the modem or the other connected device may not function properly. Some of these connections may result in excess electrical current and could cause a malfunction in the internal modem.

Phone cable and connectors are TNV (Telecommunications Network Voltage) compliant, according to EN60950.

Only DTMF (Dual Tone Multi Frequency) signalling (tone dialling) is supported.

Using power saving modes

When you use a battery as the source of power for your computer, you can take advantage of power management settings to conserve battery life. In addition to the normal operating mode, which allows you to turn off specific devices, your computer has two distinct power saving modes: **Standby** and **Hibernate**. When using battery power, you should be aware that the computer automatically enters **Hibernate** mode when the remaining battery charge drops below 7 percent, regardless of the power management setting you select.

 If the battery level falls below 10 percent, you should either attach the AC adapter to recharge the battery or shut down your computer and insert a fully charged battery.

Using Normal mode

This is the normal state of your computer when it is in use. The green power indicator light is on in this mode. To save power, you can turn off a specific device such as the LCD or the hard disk.

Using Standby mode

The computer saves the current state of the system in RAM and switches off power to the CPU. The amber power light flashes in this mode.

To activate Standby mode, proceed as follows:

Press the **<Fn>** and **<Esc>** keys simultaneously.

To return to Normal mode, proceed as follows:

Press any key.

Using Hibernate mode

The state of the system is saved on the hard disk and power is turned off. The power indicator light is off in this mode.

To activate Hibernate mode, proceed as follows:

Press **<Fn>+<F12>**.

The **Save to Disk Manager** screen appears and the notebook enters Hibernate mode.

To return to Normal mode, proceed as follows:

Turn on the computer by pressing the power button.

The computer returns to its previous state.



When the computer is in **Hibernate** mode, you cannot insert a disc.

Hibernate mode requires more time than **Standby** mode to be activated.

It takes more time to return to normal mode from **Hibernate** mode than from **Standby** mode.

Hibernate mode uses less power than **Standby** mode.

Do not move the notebook until its power indicator turns off.

Connecting peripheral devices

You can add functionality to your computer by connecting or using any of these peripherals. Before you connect peripherals, turn off the computer and all peripherals. Connect the power cord only after connecting all cables. Turn on the computer only after turning on all peripherals.

- ❑ Connecting a docking station ([page 47](#))
- ❑ Connecting an external display ([page 56](#))
- ❑ Connecting external speakers ([page 61](#))
- ❑ Connecting an external microphone ([page 61](#))
- ❑ Connecting a Universal Serial Bus (USB) mouse ([page 62](#))
- ❑ Connecting a printer ([page 63](#))
- ❑ Connecting an i.LINK™ device ([page 64](#))
- ❑ Connecting to a network (LAN) ([page 68](#))

Connecting a docking station

You can use the PCGA-DSM5 CD-RW/DVD docking station* or the PCGA-DSD5 DVD docking station (both optional) to connect peripheral devices such as a printer or an external display or to use diskettes. Different ports are available when the main unit is docked and not docked.

* Bundled with PCG-R600HEPD.

Locating the docking station controls and connectors

Right & Front

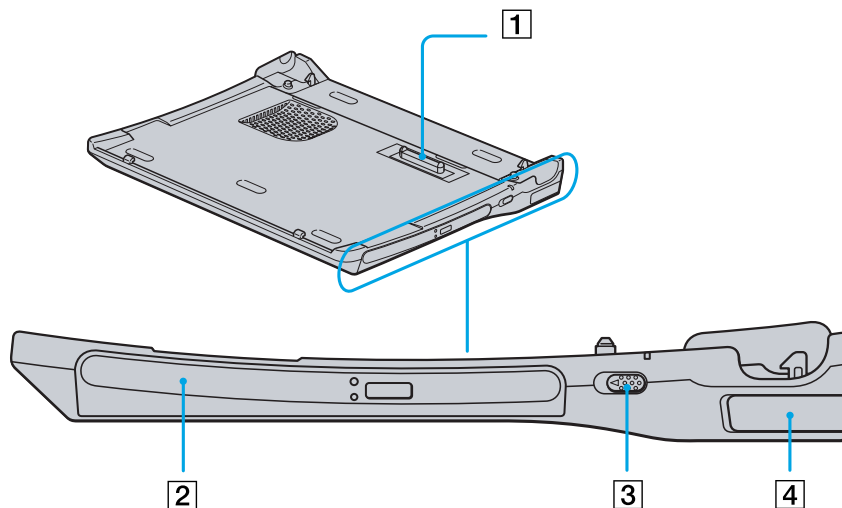

1	docking connector	(page 47)
2	CD-RW/DVD-ROM drive or DVD-ROM drive	(page 52) / (page 53)
3	UNDOCK switch	(page 51)
4	release lever	(page 51)

 All connectors are SELV (Safety Extra Low Voltage) according to EN60950.

Left & Bottom

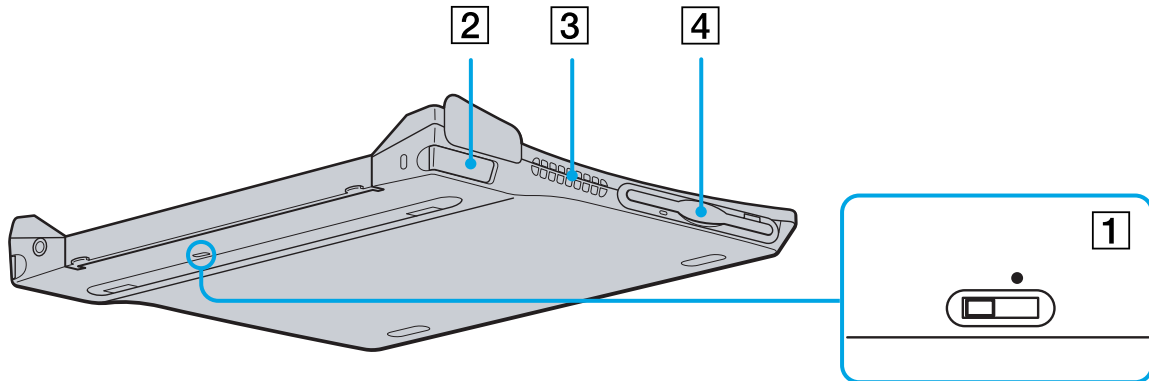

1	i.LINK™ network switch	(page 64)
2	release lever	(page 51)
3	ventilation slot	/
4	floppy disk drive	(page 54)

Back

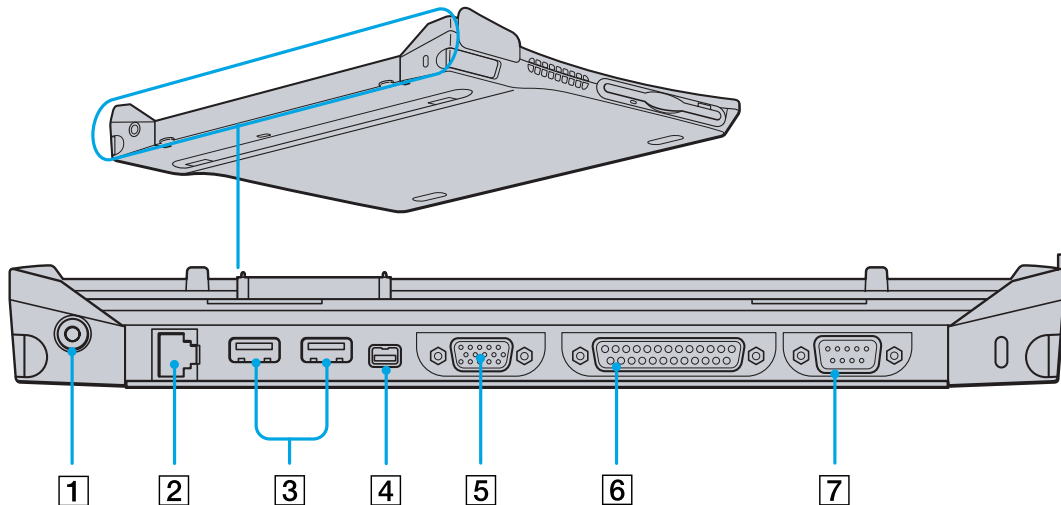

1	DC In	(page 17)
2	Ethernet network connector	(page 68)
3	USB connectors	(page 62)
4	S400 i.LINK™ connector	(page 64)
5	monitor connector	(page 57)
6	printer connector	(page 63)
7	serial port	/

Attaching your computer to the docking station

To connect your computer to the docking station, proceed as follows:

- 1 Plug the AC adapter cable into the DC In connector on the docking station and the other end to an AC outlet.
The DC In LED turns on.
- 2 Close the cover of your computer.
- 3 Grab the sides of the notebook in both ends.
- 4 Insert the front of the notebook into the docking station tabs (1).

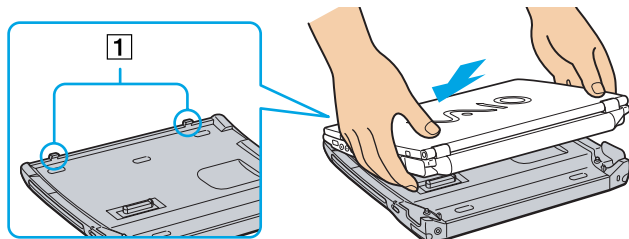

- 5 Press the bottom of the notebook on the docking station until you hear two clicks.
The docking station is now connected to the computer.

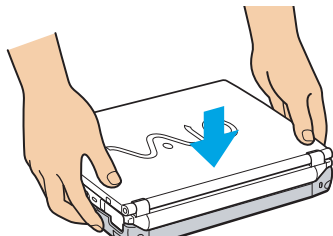

 You cannot connect the docking station when the notebook is in a power saving mode. Return to normal mode before docking.

Do not connect the docking station when the battery is removed.

If the battery is charged, you can connect the notebook to the docking station even when the notebook is on.

Make sure all cables and peripherals are removed before connecting your main unit to the docking station.

The LCD display may be damaged if you press the top of the notebook too forcefully.

Disconnecting your computer from the docking station

To disconnect your computer from the docking station, proceed as follows:

- 1 If the notebook is off, simply follow steps 3 to 5.
- 2 If the notebook is on, click **Start**, then **Eject PC** or pull the UNDOCK switch towards you.
- 3 Close the cover of your notebook.
- 4 Grab the right and left release levers (1) and pull them to the outside until you hear two clicks.

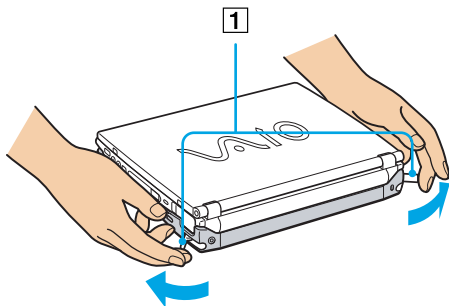

- 5 Release the notebook from the docking station.

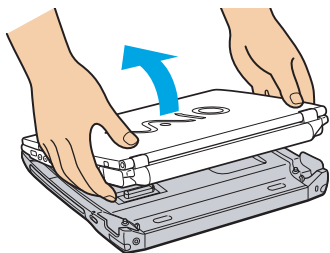

 Do not undock the notebook when the docking station indicator is on. If you undock when the docking station indicator on the notebook is on, you may lose data or malfunction may occur. Make sure all cables and peripherals are removed before disconnecting the main unit from the docking station.

Make sure the battery is connected when you undock the main unit while it is running.

If you undock when battery power is low, you may lose data.

If the i.LINK™ device is connected, stop the i.LINK™ device before undocking.

You cannot undock when the notebook is in a power saving mode. Return to normal mode before undocking.

Do not place any objects on top of the notebook when you handle the release levers.

Do not wait too long before you release the notebook from the docking station.

Using the optical disk drive on the docking station

The docking station is equipped with an optical disk drive*. From the docking station, you can listen to audio CDs or use the recovery CDs, play DVDs and burn CDs**.

* PCGA-DSM5 docking station: CD-RW/DVD-ROM drive / PCGA-DSD5 docking station: DVD-ROM drive

** PCGA-DSM5 docking station only.

To insert a disk, proceed as follows:

- 1 Turn on the computer.
- 2 Press the eject button to open the optical disk drive.
The tray slides out.
- 3 Place an optical disk in the middle of the tray with the label side facing up until the disk clicks into place.
- 4 Close the tray by pushing it gently.

 When the computer is in **Standby** or **Hibernate** mode, you cannot insert or remove a disk.

Be sure to seat the disk firmly over the disk drive hub fingers. If you do not seat the disk firmly, you could damage your disk drive and you may not be able to open the tray.

When you finish using a disk, wait until the LED indicator turns off and then press the Eject button to remove the disk.

If the disk does not come out when you press the eject button, go to **My Computer**. Select the drive, click the right button of your mouse and select **Eject**. If it still doesn't work, turn off the computer and insert a thin, pointed object (e.g. a paper clip) into the manual eject hole.

You can also connect the optional PCGA-CD51/A CD-ROM drive or the optional PCGA-CDRW52 CD-RW drive to the PC Card slot on your notebook. However, do not connect these drives if the main unit is docked. A simultaneous use may cause malfunction.

Using the DVD function

To achieve optimum performance when playing **DVD-ROM** discs, you should follow these recommendations.

- ❑ You can play DVDs using the DVD-ROM drive and the WinDVD software. See the help file on the WinDVD software for details.
- ❑ Close all open applications before playing a DVD-ROM movie.
- ❑ When playing DVD movies on battery power, set the power management profile to DVD. With other profiles, the movies can be choppy.
- ❑ Do not switch power saving modes while playing a DVD video.
- ❑ If the virus checker is active, you need to disable it.
- ❑ Do not use resident disc utilities or resident utilities to speed up the access of discs, because they may cause the system to become unstable.
- ❑ Make sure that the screensaver is deactivated.
- ❑ Depending on the display setup properties you selected, you may use the **<Fn>+<F>** command to expand the screen to full screen size.
- ❑ Region codes indicators are labeled on the DVD discs to indicate in which region and on what type of player you can play the disc. Unless a '2' (Europe belongs to region '2') or 'all' (this means that you can play this DVD everywhere in the world) is labeled on your DVD disc or on the packaging, you cannot play the disc on this player.
- ❑ Do not try to change the region code settings of the DVD-ROM drive. Any difficulties caused by changing the region code settings of DVD-ROM drive are out of warranty.

Using the CD-RW function

To burn CDs, you can use CD-RW and CD-R discs:

- ❑ The **CD-RW** (CD-ReWritable) disc is a data memory medium that can be used to write, erase and rewrite a program or other data.
- ❑ The **CD-R** (CD-Recordable) disc is a data memory medium that can be used to write a program or other data, but once only.

To achieve optimum performance when writing data on a CD-RW disc, follow these recommendations :

- ❑ Before writing to a new CD-RW, you must first format the disc. If you do not format the disc, your computer will not recognize it.
- ❑ To make a CD-R's data readable on a CD-ROM drive, you need to close the session when you eject it. To complete this process, follow the instructions included with your software.
- ❑ Only use circular discs. Do not use discs with any other shape (star, heart, card, etc.), as this may damage the CD-RW drive.
- ❑ Do not strike or shake the computer while writing data to a disc.
- ❑ For optimal writing speed, deactivate the screensaver before writing data to a disc.
- ❑ Memory-resident disc utilities may cause unstable operation or data loss. Deactivate these utilities before writing data to a disc.
- ❑ For best results, use CD-Rs that are compatible with 4x speed, as the software pre-installed on your computer is preset to that speed. Your VAIO notebook does not support 1x writing speed.
- ❑ When using a software application to burn CDs, be sure to exit and close all other applications.
- ❑ Exit anti-virus software before writing data to a disc.
- ❑ Never touch the surface of the disc. Fingerprints and dust on the surface of a disc may cause writing errors.
- ❑ Do not put your VAIO notebook into a power saving mode while using the pre-installed software.
- ❑ Always use the AC adapter as the power source for your computer when you write data to a CD-RW or CD-R. It is not possible to burn CDs when the CD-RW/DVD-ROM docking station is not connected to AC power.

Using the floppy disk drive on the docking station

The docking station is equipped with an internal floppy disk drive.



You can also use an external USB floppy disk drive on the undocked main unit. It is not possible to use any USB floppy disk drive when the notebook is docked.

Inserting a diskette

To insert a diskette, proceed as follows:

- 1 Hold the diskette with the label side facing up.
- 2 Gently push the diskette into the floppy disk drive until it clicks into place.

Removing a diskette

To remove a diskette, proceed as follows:

- 1 Wait until the LED indicator turns off.
- 2 Press the eject button to remove the diskette.

Connecting an external display

You can connect an external display to your notebook. For example, you can use your computer with the following devices:

- ❑ Computer display (monitor)
- ❑ Projector

 Turn off your computer and the peripherals, unplug the AC adapter and the power cord before connecting the external display.
Connect the power cord after connecting all other cables.
Turn on the peripherals, then turn on your computer.

Connecting a computer display

You can connect a computer display either directly to your notebook or via the docking station.

You may not be able to display the computer's LCD and the external display together, depending on the type of computer display and projector used.

When you connect an external display to the monitor connector, you can press **<Fn>+<F7>** to toggle the output between the Liquid Crystal Display (LCD), the external monitor or both devices.

To connect a computer display to your notebook, proceed as follows:

- 1 Plug the monitor plug (1) into the notebook monitor connector (2).
- 2 Plug the power cord (3) into an AC outlet.

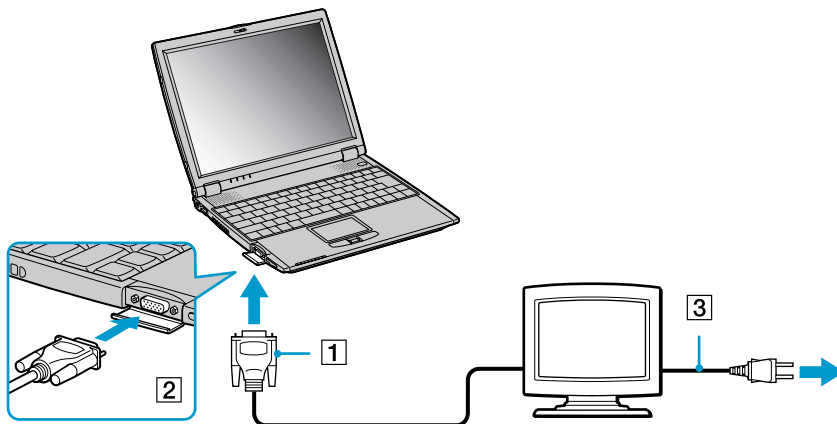

 You cannot use the monitor connector on your notebook when the docking station is connected to the notebook.

To connect a computer display to the docking station, proceed as follows:

- 1 Plug the monitor plug (1) into the docking station monitor connector (2).
- 2 Plug the power cord (3) into an AC outlet.

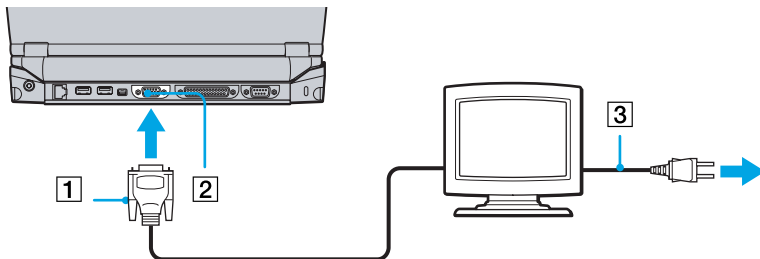

 If the main unit is docked, you can only use the monitor connector on the docking station

Connecting a projector

You can connect a projector (such as the Sony LCD projector) directly to your notebook or via the docking station.

To connect a projector to your notebook, proceed as follows:

- 1 Plug the RGB signal cable (1) into the notebook monitor connector identified by the I/O symbol.
- 2 Plug the audio cable (2) into the earphone connector identified by the  symbol.
- 3 Connect the power cord (3) of the projector into an AC outlet.

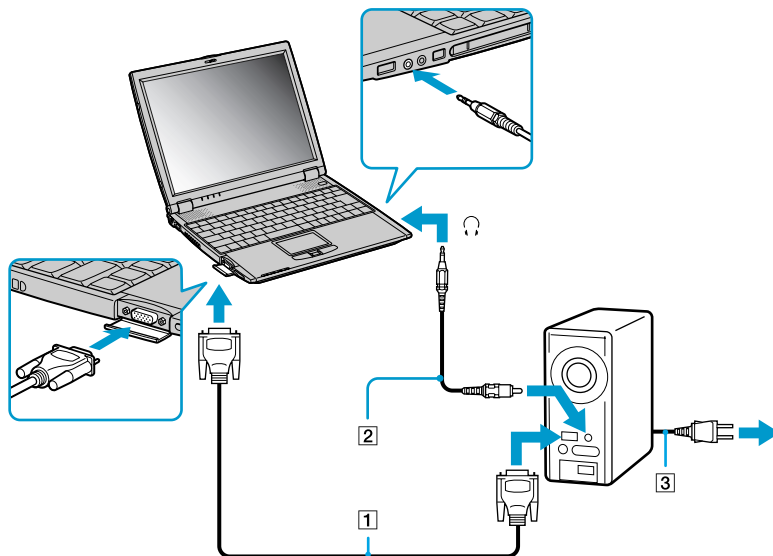

You cannot use the monitor connector on your notebook when the docking station is connected to the notebook.

To connect a projector to your docking station, proceed as follows:

- 1 Plug the RGB signal cable (1) into the docking station monitor connector identified by the I/O symbol.
- 2 Plug the audio cable (2) into the notebook earphone connector identified by the  symbol.
- 3 Connect the power cord (3) of the projector into an AC outlet.

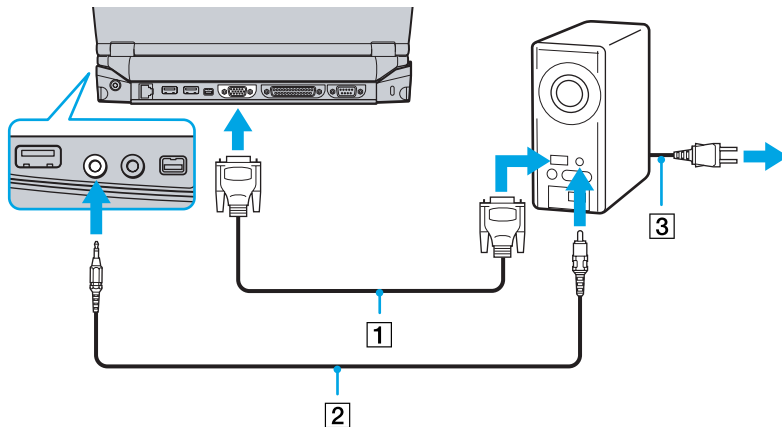



 If the main unit is docked, you can only use the monitor connector on the docking station.

Connecting external speakers

You can enhance the sound quality of your computer by connecting external speakers.

To connect external speakers, proceed as follows:

- 1 Plug the speaker cable into the notebook earphone connector identified by the  symbol.
- 2 Turn down the volume of the speakers before you turn them on.

 Make sure your speakers are designed for computer use.

Do not place diskettes on the speakers; their magnetic field may damage the data on the diskettes.

Connecting an external microphone

It is possible to plug in an external microphone to your VAIO notebook.

To connect an external microphone, proceed as follows:

Plug the microphone cable into the microphone connector identified by the  symbol.

 Make sure your microphone is designed for computer use.

Connecting a Universal Serial Bus (USB) mouse

You can connect a USB device (e.g. mouse, floppy disk drive, printer...) to your notebook or to your docking station. If the main unit is docked, you can only use the USB connectors on the docking station.

To connect a USB mouse to the notebook, proceed as follows:

Plug the USB cable (1) into one of the notebook USB connectors (2) identified by the  symbol.

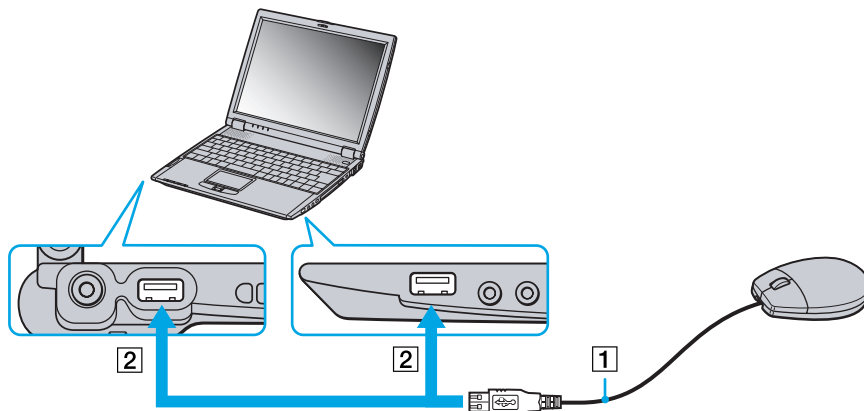

To connect a USB mouse to the docking station, proceed as follows:

Plug the USB cable (1) into one of the docking station USB connectors (2) identified by the  symbol.

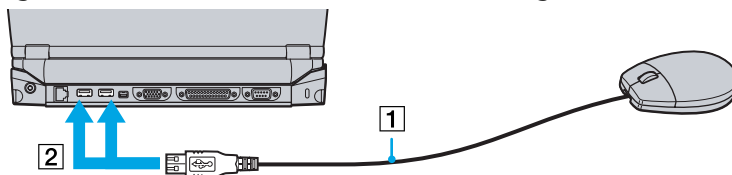

 You do not need to shut down the computer before connecting or disconnecting a USB peripheral. You can connect the optional Sony USB mouse (PCGA-UMS1 series). As the driver for this mouse is preinstalled on your computer, you can use the mouse by just connecting it.

Connecting a printer

You can connect a Windows-compatible printer to your computer to print documents.

Connecting a printer using the USB connector

To connect a printer using the USB connector, proceed as follows

- 1 Plug an optional USB printer cable into one of the USB connectors on your computer or your docking station. A USB connector is identified by the  symbol.
- 2 Plug the printer power cord into an AC outlet.

 Before using the printer, you may need to change the **Printer** settings in the **Sony Notebook Setup** software.
Turn off your computer and the printer, unplug the AC adapter and the power cord before connecting the printer.

Connecting a printer using the printer connector

The docking station (optional) is equipped with a printer connector.

To connect a printer using the printer connector, proceed as follows:

- 1 Plug the printer cable (1) supplied with the printer into the docking station printer connector (2) identified by the  symbol.
- 2 Plug the printer power cord (3) into an AC outlet.

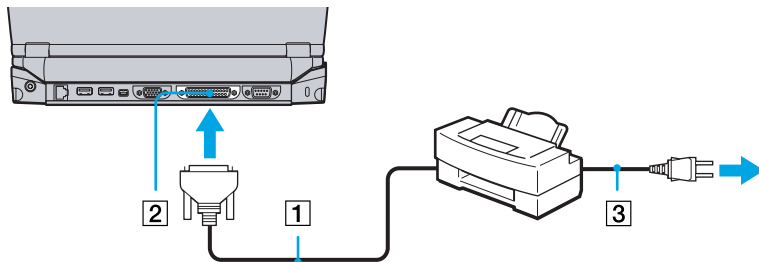

 Before using the printer, you may need to change the **Printer** settings in the **Sony Notebook Setup** software.

Connecting an i.LINK™ device

Your computer includes an i.LINK™ (IEEE1394) connector, which you can use to connect to an i.LINK™ device such as a digital video camera recorder or to connect two VAIO notebooks in order to copy, delete or edit files.

The i.LINK™ connector of your notebook does not supply power to external devices generally powered by i.LINK™ connectors.

The i.LINK™ connector supports transfer rates up to 400 Mbps; however, the actual transfer rate depends on the transfer rate of the external device.

The i.LINK™ features available may vary depending on the software applications you use. Refer to the documentation that came with your software for more information.

i.LINK™ cables compatible with your VAIO notebook include cables with the following part numbers: VMC-IL4415A (a 1.5 meter cable with a 4-pin connector at each end), VMC-IL4408Series (a 0.8 meter cable with a 4-pin connector at each end).

 An i.LINK™ connection with other compatible devices is not fully guaranteed.

The i.LINK™ connection varies depending on the software applications, operating system and i.LINK™ compatible devices you use. Refer to the documentation that came with your software for more information.

Check the working conditions and OS compatibility of i.LINK™-compatible PC peripherals (HDD, CD-RW drive etc.) before you connect them to your notebook.

Connecting a digital video camera recorder

To connect a digital video camera recorder to your notebook, proceed as follows:

- 1 Plug one end of the i.LINK™ cable (1) into the i.LINK™ connector (2) of the computer and the other end into the DV Out connector (3) on the digital video camera recorder.

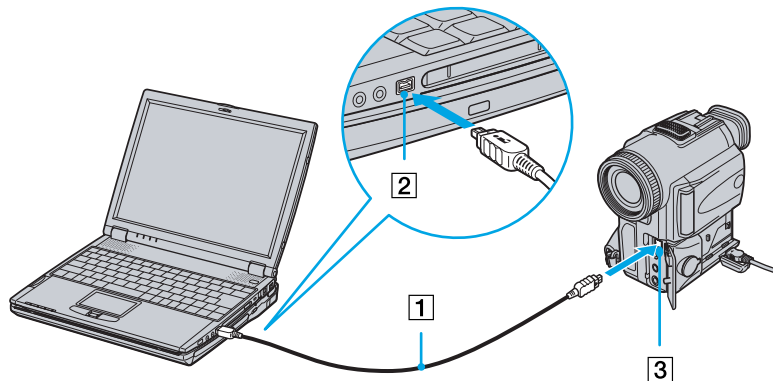

- 2 Launch the DVgate application.

To connect a digital video camera recorder to the docking station, proceed as follows:

- 1 Plug one end of the i.LINK™ cable (1) into the i.LINK™ connector (2) of the docking station and the other end into the DV Out connector (3) on the digital video camera recorder.

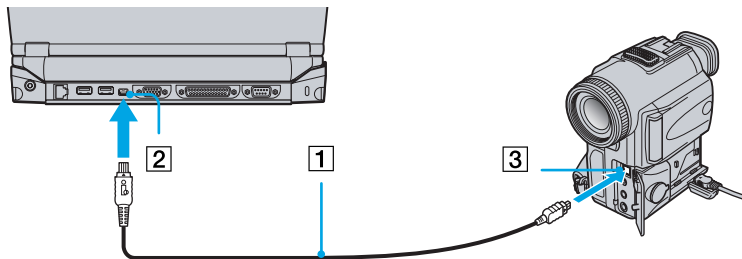

- 2 Launch the DVgate application.

 On Sony digital video cameras, connectors labeled **DV Out**, **DV In/Out** or **i.LINK™** are i.LINK™-compatible.

The Sony digital video camera recorder is an example; your digital video camera recorder may need to be connected differently.

If your digital video camera recorder includes a Memory Stick™ slot, you can copy images from it to your computer via a Memory Stick™. To do so, simply copy images on the Memory Stick™, then insert it into the Memory Stick™ slot of your computer.

Connecting two VAIO notebooks

With Smart Connect you can copy, edit or delete files on another VAIO computer (equipped with Smart Connect) connected to your computer with an optional i.LINK™ cable (1).

You can also print a document on a printer connected to another VAIO computer.

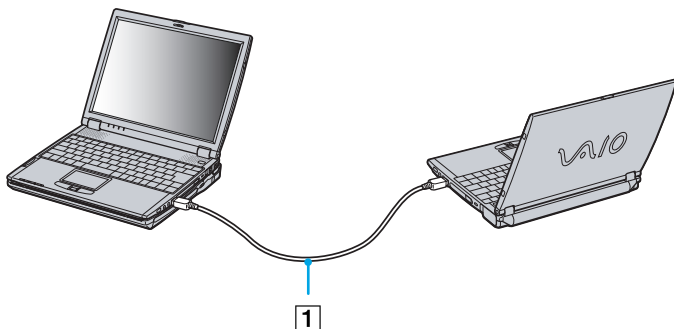

If the notebook is connected to the optional docking station, proceed as follows to exchange data with another computer using an i.LINK™ cable (optional):

- 1 Disconnect your notebook from the docking station.
- 2 Disconnect all cables from the docking station.
- 3 Set the i.LINK™ network switch on the bottom of the docking station to the position marked by a dot (to the right) by means of a thin pen tip.
- 4 Connect the docking station to your notebook as described in **Connecting a docking station (page 47)**.
- 5 Turn on the notebook.
- 6 Connect your computer to another computer with the i.LINK™ cable.

 When you use Smart Connect to connect two VAIO computers, you must assign each computer a unique name by which it can be identified when the two computers are networked.

Do not set the i.LINK™ network switch on the docking station when the notebook is on. It causes malfunction.

Set the i.LINK™ network switch on the docking station after removing all cables connected to the docking station.

When using Smart Connect, do not connect or remove the docking station. Smart Connect may become unavailable.

Set the i.LINK™ network switch to the off position once you have finished exchanging data.

Connecting to a network (LAN)

You can connect your notebook or your docking station to 10BASE-T/100BASE-TX-type networks via an Ethernet network cable. For the detailed settings and devices needed to connect to the network, consult your Network Administrator.

To connect your notebook to a LAN, proceed as follows:

Connect the network cable to the Ethernet network connector (1) on the notebook.

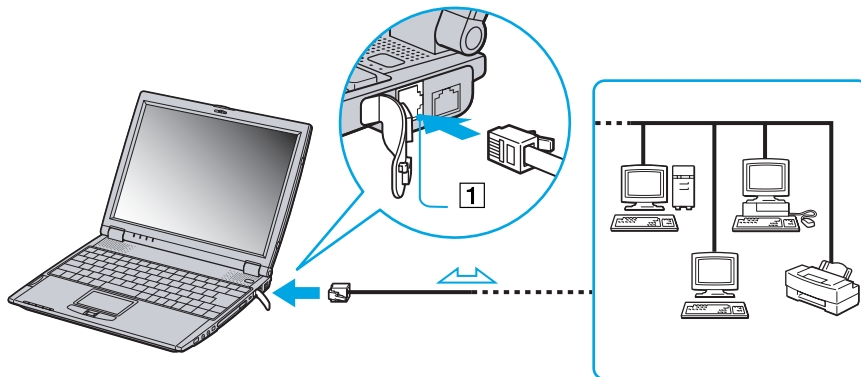

To connect your docking station to a LAN, proceed as follows:

Connect the network cable to the Ethernet network connector (1) on the docking station.

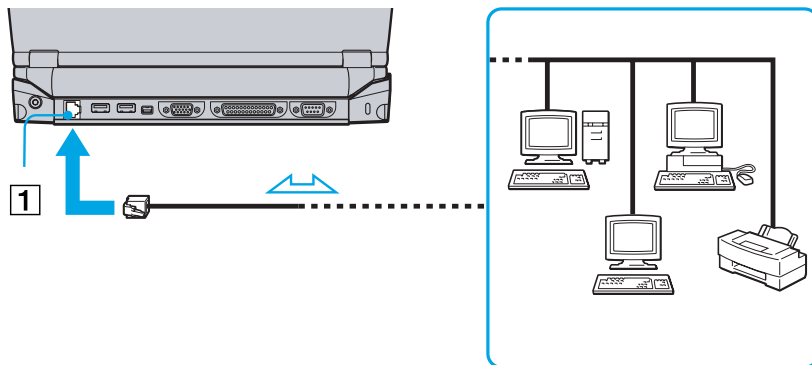

 If the main unit is docked, you can only use the ethernet network connector on the docking station.

For more information about connecting your notebook to the network, please consult the Hardware troubleshooting section of the Vaio-Link website:

[How to troubleshoot network problems](#)

! Do not plug a phone cable into the Ethernet network connector on your notebook.

Getting help

This section describes how to get help and support from Sony, and provides troubleshooting tips for your computer.

Sony support options

Sony provides several support options for your computer.

Printed documentation supplied with your notebook

- ❑ A **Getting Started** brochure, where you find a brief description of the items in your box, some specifications of your notebook, and how to setup your notebook;
- ❑ A **Customer Guide**, where you find all the basic information you need to start using your notebook, as well as troubleshooting and VAIO-Link information;
- ❑ Your **Sony Guarantee conditions**;
- ❑ A **Safety Regulations** flyer;
- ❑ A **Modem Regulations** flyer.

Online user guides on your computer's hard drive

- ❑ The **Sony notebook user guide (hardware guide)** explains how to use your computer, connect peripheral devices. It contains a list of specifications of your computer and accessories.
- ❑ The **About the software on your Sony notebook guide (software guide)** lists the pre-installed software titles and explains how to use the utility programs and perform basic computer tasks. Go to <http://www.club-vaio.sony-europe.com> to find online tutorials about your favorite VAIO software.
- ❑ The **Customer Service Guide** gives you complete information on the VAIO-Link Services.

Other sources of information

- ❑ The **Online help files** that accompany your pre-installed software contain instructions on using the software.
 - ❑ **VAIO-Link website:** if you have any problem with your computer, you can access the VAIO-Link web site. Go to:
<http://www.vaio-link.com>
 - ❑ **VAIO-Link Response Centre:** Before contacting VAIO-Link Response Centre, try to solve the problem by reading the User Guides and help files for the peripherals or software.
-  You need to plug in the phone line and configure your modem for use before using the communication features described in this manual.

Troubleshooting

This section describes how to solve common problems you might encounter when using your notebook. Many problems have simple solutions. Please, try these suggestions before contacting VAIO-Link.

About the computer and software

My computer does not start

- ❑ Check that the computer is plugged into a power source and that it is turned on.
- ❑ Check that the power indicator on the front panel of the computer indicates that the power is on.
- ❑ Check that the battery packs are inserted properly and that they are charged.
- ❑ Make sure there is no diskette in the floppy disk drive.
- ❑ Confirm that the power cord and all cables are connected firmly.
- ❑ If you have plugged the computer into a UPS (Uninterruptible Power Supply), make sure the UPS is turned on and works.

- ❑ If you are using an external display, check that it is plugged into a power source and turned on. Check that you have switched to the external display and that the brightness and contrast controls are adjusted correctly.
- ❑ Moisture condensation may have occurred. Do not use the computer for at least one hour and then turn it on.
- ❑ When the internal backup battery is low on power, it may not be able to start your system properly.

The message Press <F1> to resume, <F2> to setup appears at startup

If the floppy disk drive is empty, proceed as follows to initialize the BIOS:

- 1 Turn off the computer.
- 2 Remove any peripheral devices connected to the computer.
- 3 Turn on the computer and press **<F2>** when the Sony logo appears.
The BIOS setup menu screen appears.
- 4 Set the date (month/day/year).
- 5 Press **<Enter>**.
- 6 Press the arrow keys to select **System Time**.
- 7 Set the time (hour:minute:second).
- 8 Press **<Enter>**.
- 9 Press the arrow keys to select the **Exit** menu.
- 10 Press the arrow keys to select **Get Default Values** and then press **<Enter>**. The message **Load default configuration now?** appears.
- 11 Make sure that **Yes** is selected and then press **<Enter>**.
- 12 Press the arrow keys to select **Exit** (save changes) and then press **<Enter>**.
The **Save configuration changes and exit now?** message appears.
- 13 Make sure that **Yes** is selected and then press **<Enter>**.

My computer does not shut down

You are recommended to shut down your computer using the **Turn Off** command on the Windows® **Start** menu. Using other methods, including those listed here, may result in loss of unsaved data. If the **Turn Off** command does not work properly, proceed as follows:

- ❑ Press **<Ctrl>+<Alt>+<Delete>**. If you have not changed the default settings, you will enter the **Task Manager**, where you can close any application that cannot close normally, and restart your system.
- ❑ If this does not work, press **<Alt>+<F4>** to get to the **Turn off computer** screen, from where you can shut down or restart your computer.
- ❑ If this does not work, press the power button and hold it for at least four seconds. This turns off the power.
- ❑ Unplug the computer from the AC adapter and remove the battery pack from your computer.

My computer locks up

- ❑ If you suspect one application is locking your system, you can try to stop it. To do this, press **<Ctrl>+<Alt>+<Delete>** simultaneously. If you have not changed the default settings, you will enter the **Task Manager**. Select the application or process that is locking your system, and then click **End Task**.
- ❑ If the above method does not work or you do not know which application is locking your system, restart the computer. On the Windows® taskbar, click the **Start** button, click **Turn Off Computer**, and then select **Turn Off**.
- ❑ If the above method does not work, press the power button and hold it for at least four seconds. This turns off the power.
- ❑ If your computer locks up while playing a CD-ROM, stop the CD-ROM, and shut down the computer by pressing **<Alt>+<F4>** and clicking **Turn Off** in the **Turn off computer** screen.

My software program locks up or crashes

Contact the software publisher or designated provider for technical support.

My touchpad interprets a single tap as a double-click

Open the **Mouse** icon in the **Control Panel** and change the button assignments in the **Mouse Properties** dialog box. One of the buttons is assigned to the double-click action.

My mouse does not work

- ❑ Check that the USB mouse is plugged into the USB connector.
- ❑ If you are using an optional Sony USB mouse, check that the appropriate driver and mouseware are properly installed.

About the display

My LCD does not display anything

- ❑ Check that the computer is plugged into a power source and that it is turned on.
- ❑ Check that the power indicator on the front panel of the computer is on.
- ❑ Check that the battery packs are inserted properly and that they are charged.
- ❑ Adjust the brightness of the LCD.
- ❑ The computer may be in LCD (video) standby mode. Press any key to activate the display.
- ❑ The display mode may be set to external display mode. Press and hold the **<Fn>** key while pressing **<F7>** several times.

The screen image on my external display is not centered or sized properly

Use the controls on your external display to adjust the image.

The window I have just closed continues to appear on my LCD

Press the **<Windows[®]>** key and **<D>** key twice to refresh the screen.

About CD-ROMs and diskettes

My CD-ROM drive tray does not open

- ❑ Make sure the computer is turned on.
- ❑ Press the **eject** button on the optical device drive.
- ❑ If the **eject** button does not work, you can open the tray by inserting a sharp, pointed object into the hole to the right of the **eject** button.

I cannot play a CD-ROM disk

- ❑ After inserting the CD, wait for a few seconds for the system to detect it before you try to access it.
- ❑ Make sure the label of the disc is facing up.
- ❑ If the disc requires software, make sure the software is installed according to the instructions of the program.
- ❑ Check the volume of your speakers.
- ❑ Clean the disc with an appropriate cleaner.
- ❑ Moisture condensation may have occurred. Do not use the computer for at least 1 hour before turning it on.

I cannot play a DVD-ROM

- ❑ If a region code warning appears when you are using the DVD player, it could be that the DVD-ROM you are trying to play is incompatible with the DVD-ROM drive on your notebook. The region code is listed on the packaging of the disc.
- ❑ If you hear sound but cannot see a picture, your computer's video resolution may be set too high. For best results, change the resolution in the Windows® **Control Panel - Display - Settings** to 800 x 600 using 8-bit colour.
- ❑ If you see a picture but cannot hear any sound, check all of the following:

- ❑ Make sure the mute setting is off on your DVD player.
 - ❑ Check the master volume setting of the **Audio Mixer**. If you have connected speakers externally, check the volume settings of your computer speakers and check the connections between your speakers and the computer.
 - ❑ In the **Device Manager**, check that the correct drivers are installed properly. To display the **Device Manager**, click **Start**, and select **Control Panel**. Double-click the **System** icon. On the **Hardware** tab, click the **Device Manager** button.
 - ❑ A dirty or damaged disc may cause the computer to 'hang' while it tries to read the disc. If necessary, reboot the computer, remove the disc and then check that it is not dirty or damaged.
-  On your computer, the default DVD region code is 2. Do not change this setting using the Region Code Change function in Windows[®], or using any other software applications. System malfunctions originating from the user changing the DVD region code, are beyond the scope of your warranty and will result in service charges for repair.

Why does my CD-RW drive not record at the highest speed?

You must use 8x CD-R or 4x CD-RW media or higher to achieve optimum performance.

If you want to use other media and are having difficulty formatting non-4x CD-RW discs, change the writing speed from 4x to a lower setting.

To change the writing speed from the default to a lower speed, proceed as follows:

- 1 Go to **My Computer** from the **Start** menu.
- 2 Right-click the disc drive icon.
- 3 Select **Properties**.
- 4 Select the **Settings** tab.
- 5 Change the **Current Write Speed** field to 2x.
- 6 Click **OK**.

 The VAIO notebook has a maximum recording rate of 8x for CD-R and 4x for CD-RW discs.

When I double-click an application icon a message such as 'You must insert the application CD into your CD-ROM drive' appears and the software does not start.

- ❑ Some titles require specific files that are located on the application CD-ROM. Insert the disc and try starting the program again.
- ❑ Make sure you place the disc in the tray with the label side facing up.

The disc tray does not eject even when the eject button is pressed

- ❑ Check that the notebook is turned on.
- ❑ The CD-writing application software may be stopping the disk from being ejected.

The disc tray ejects even when it has been locked into place

- ❑ Ensure that the disc is placed with the label side facing up.
- ❑ The disc may be scratched. Place another disc to see if that is the reason.
- ❑ There may be condensation in the drive. Remove the disc and leave the drive open for approximately one hour.

My floppy disk drive cannot write to a diskette

- ❑ The diskette is write-protected. Disable the write-protect feature or use a diskette that is not write-protected.
- ❑ Check that the diskette is properly inserted into the floppy disk drive.
- ❑ Your diskette may be corrupt. Try to insert another diskette.

The optional PCGA-UFD5 (USB) floppy disk drive is not recognized as drive A

To set the UFD5 to A, proceed as follows :

- 1 Turn the system power off and remove the docking station.
- 2 Turn the system power on.
- 3 Connect the UFD5
- 4 Select **Control Panel** from the **Start** menu.
- 5 Double-click **System**.
- 6 Select the **Hardware** tab, then click **Device Manager**.
- 7 Select **Universal Serial Bus controllers**, then **Y-E Data USB Floppy**.
- 8 Select **Operation**, then **Delete**.
- 9 Keep clicking **OK** until the **Confirmation of deletion of device** message appears.
- 10 Perform the **Scan to change hardware** from **Operation**.
The UFD5 is recognized as drive A.

The floppy disk drive in the optional docking station connected to the notebook is not recognized as drive A

To set the docking station floppy disk drive to A, proceed as follows :

- 1 Turn the system power off and disconnect all peripherals.
- 2 Connect the docking station, then turn the system power on.
- 3 Select **Control Panel** from the **Start** menu.
- 4 Double-click **System**.
- 5 Select the **Hardware** tab, then click **Device Manager**.
- 6 Select **Floppy disk controllers**, then **Standard floppy disk controller**.
- 7 Select **Operation**, then **Delete**.

- 8 Keep clicking **OK** until the **Confirmation of deletion of device** message appears.
- 9 Perform the **Scan to change hardware** from **Operation**.
The docking station floppy disk drive is recognized as drive A.

About sound

My speakers are not producing sound

- ❑ The built-in speakers may be turned off. Press **<Fn>+<F3>** to turn on the speakers.
- ❑ The speaker volume may be turned to the minimum. Press **<Fn>+<F4>**, and then press **↑** or **➡** to increase the volume.
- ❑ If your computer is powered by battery, check that the battery is inserted properly and that it is charged.
- ❑ If you are using an application that has its own volume control, check that the volume is turned up.
- ❑ Check the volume controls in Windows®.
- ❑ If you use external speakers, check that the speakers are properly connected and the volume is turned up. If the speakers have a mute button, make sure it is off. If batteries power the speakers, check that the batteries are inserted properly and that they are charged.
- ❑ If you have connected an audio cable or a set of headphones to the headphone connector, disconnect the cable.

My microphone does not work

If you are using an external microphone, check that the microphone is plugged into the microphone connector correctly.

About the docking station

I cannot operate the CD-RW/DVD-ROM drive or the DVD-ROM drive in the docking station connected to the notebook

To switch on the i.LINK™ network switch, proceed as follows :

- 1 Disconnect your notebook from the docking station.
- 2 Disconnect the AC adapter and all cables from the docking station if necessary.
- 3 Set the i.LINK™ network switch on the bottom of the docking station to the unmarked side with a thin pen tip.
- 4 Connect the docking station to your notebook.
- 5 Turn on your notebook.

You can now operate the CD-RW/DVD-ROM drive or the DVD-ROM drive.

 Do not set the i.LINK™ network switch when the notebook is on. It causes malfunction.

Set the i.LINK™ network switch after removing all cables connected to the docking station.

I cannot operate the CD-RW/DVD-ROM drive or the DVD-ROM in the docking station connected to the notebook when the notebook is connected to another computer by means of an i.LINK™ cable

Set the i.LINK™ network switch on the bottom of the docking station to the **On** position.

I cannot remove the disk inserted in the drive

You cannot remove disks when the computer is in a power saving mode. Return to normal mode and then press the eject button.

The disk tray does not eject even when the eject button is pressed

Open the tray by inserting a sharp, pointed object in the manual eject hole.

When I disconnect the docking station, a warning message appears

Close all open applications and disconnect the peripheral devices, then disconnect the docking station by following the procedure in **Disconnecting your computer from the docking station (page 51)**.

About the modem

My internal modem does not work

- Check that the phone line is plugged into your computer.
- Check that the phone line is working. You can check the line by plugging in an ordinary phone and listening for a dial tone.
- Check that the phone number the program is dialing, is correct.
- In the **Phone and Modem Options** dialog box (**Control Panel / Phone and Modem Options**), check that your modem is listed on the **Modems** tab, and that the location information is correct on the **Dialing Rules** tab.
- Each time you use your modem while travelling, make sure that the country of the active location defined in the **Phone and Modem Options** dialog box matches the country you are dialing from.

My modem cannot establish a connection

The modem dialing mode may be incompatible with your telephone line.

My modem connection is slow

Many factors influence modem connection speed, including telephone line noise or compatibility with telephone equipment (such as fax machines or other modems). If you think your modem is not connecting properly to other PC-based modems, fax machines, or your Internet Service Provider, check the following:

- Have your phone company check that your phone line is free from any line noise.

- ❑ If your problem is fax-related, check that there are no problems with the fax machine you are calling and that it is compatible with fax modems.
- ❑ If you are having a problem connecting with your Internet Service Provider, check that the ISP is not experiencing technical problems.
- ❑ If you have a second phone line available, try connecting the modem to that line.

About peripherals

I cannot use DV devices. The message 'DV equipment seems to be disconnected or turned off' appears

- ❑ Check that the DV device is turned on and that the cables are properly connected.
- ❑ If you are using multiple i.LINK™ devices, the combination of the connected devices may cause unstable operation. In this case, turn off the power of all connected devices and disconnect unused devices. Check the connection and then turn on the power again.
- ❑ Use manual import/export in DVGate motion if problems occur with third party cameras.
- ❑ You are strongly advised to use only Sony i.LINK™ cables, as using other brands may cause problems with the i.LINK™ devices.

I cannot print

- ❑ Check that the printer cables are correctly connected.
- ❑ Check that your printer is correctly configured and that you have up-to-date drivers. If needed, contact your dealer.
- ❑ The default setting for the printer port mode is correct for most printers. If you cannot print, try changing the printer port mode. In **Sony Notebook Setup**, select the **Printer** tab. If the printer port mode is set to **ECP**, change it to **bi-directional**. If the printer port mode is set to **bi-directional**, change it to **ECP**.
- ❑ Check the cable to see if you do not have missing of bend pins.

- ❑ Try a printer self test (if available) to see if the printer itself is still functioning properly. For more information, please consult the manual supplied with your printer.
- ❑ Some printers have a specific installation procedure. Please check the manual supplied with your printer.

About digital video captures and DVgate

While I am recording images to a digital video device using DVgate, my system displays the message 'Recording to DV device failed. Check the power and cable connections to the DV device and try the operation again...'

- ❑ Close all open applications and restart your computer. Frequent recording of images to a digital video device while using DVgate sometimes causes this error.
- ❑ Your DV device will need to have DV In/Out in order to be able to transfer your files to the DV device.

About i.LINK™ devices

I cannot establish an i.LINK™ connection between two VAIO computers

- ❑ Disconnect then reconnect the i.LINK™ cable.
- ❑ If you still have no connection after waiting for a while, restart both computers.
- ❑ If either computer has just returned from a power saving mode, the connection may be affected. In this case, make sure you perform a full restart before connecting them.

Precautions

This section describes safety guidelines and precautions to help you protect your computer from potential damage.

Your notebook and memory modules use high precision components and electronic connectors technology. To avoid the invalidation of your guarantee by mishandling, it is recommended that:

- ❑ You contact your dealer to install a new memory module.
- ❑ You do not install it yourself, if you are not familiar with upgrading memory on a notebook.
- ❑ You do not touch the connectors or open the memory panel.

Please contact VAIO-Link if you need assistance.

Adding and removing memory

In the future you may want to install memory modules to expand the functionality of your computer. You can increase the memory by installing optional memory modules.

Be careful when adding memory. Mistakes on installation or removal of the memory module may cause a malfunction.

For memory upgrades, use only PC100 (CL2) SDRAM SO-DIMM (gold leaf contacts).

Electrostatic discharge can damage electronic components. Before touching a memory expansion board, ensure the following:

- ❑ Handle the memory module gently.
 - ❑ The procedures described in this document assume familiarity with the general terminology associated with personal computers and with the safety practices and regulatory compliance required for using and modifying electronic equipment.
 - ❑ Disconnect the system from its power source and from any telecommunication links, networks, or modems before you open the system. Failure to do so may result in personal injury or equipment damage.
 - ❑ Electrostatic Discharge (ESD) can damage memory modules and other components. Install the memory Module only at an ESD workstation. If such a station is not available, do not work in a carpeted area, and do not handle materials that produce or hold static electricity (cellophane wrappers, for example). Ground yourself by maintaining contact with an unpainted metal portion of the chassis while performing the procedure.
 - ❑ Do not open the memory module package until you are ready to install the module. The package protects the module from ESD.
- ! Use the special bag delivered with the memory module or wrap the module in aluminium foil to protect it from electrostatic discharge.
- ! Do not place the memory module in places subject to:
- Heat sources such as radiators or air ducts,
 - Direct sunlight,
 - Excessive dust,

- Mechanical vibration or shock,
- Strong magnets or speakers that are not magnetically shielded,
- Ambient temperature of more than +35°C or less than +5°C,
- High humidity.

! Be careful when adding memory. Mistakes on installation or removal of the memory module may cause a malfunction.

Removing a memory module

To remove a memory module, proceed as follows:

- 1 Shut down your computer and disconnect all peripheral devices.
- 2 Unplug the computer and remove the battery pack.
- 3 Wait until the computer cools down.
- 4 Unscrew the two screws at the bottom of your computer.

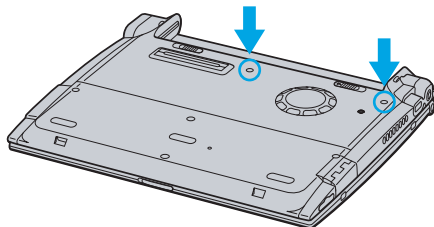

- 5 Slide the LCD lock lever and lift the cover.
- 6 Slide the keyboard toward the LCD display, then lift it away slightly.
- 7 Lift the keyboard from the LCD display side.
- 8 Gently turn it over the touchpad. Be careful not to detach the cable when lifting the keyboard.
- 9 Touch a metal object (such as the connector panel on the back of your computer) to discharge static electricity.

10 Remove the memory module:

- ❑ Pull the tabs in the direction of the arrows.
The memory module is released.
- ❑ Pull the memory module in the direction of the arrow.

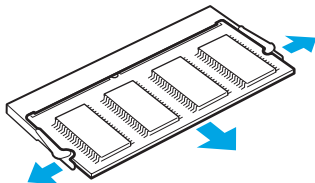

- 11** Gently replace the keyboard, then press it into your computer. Be careful not to detach the cable when lifting the keyboard.
- 12** Close the computer cover, then tighten the screws on the bottom of the computer.

Adding a memory module

To add a memory module, proceed as follows:

- 1 Shut down your computer and disconnect all peripheral devices.
- 2 Unplug the computer and remove the battery packs.
- 3 Wait until the computer cools down.
- 4 Unscrew the two screws at the bottom of your computer.

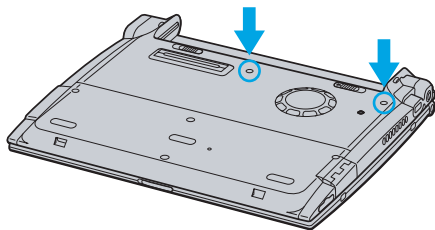

- 5 Slide the LCD lock lever and lift the cover.
- 6 Slide the keyboard toward the LCD display, then lift it away slightly.

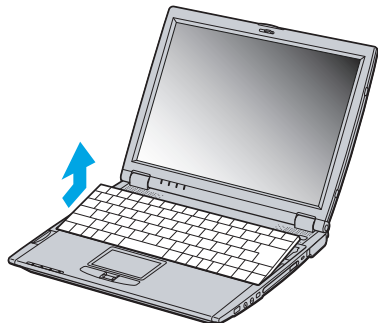

- 7 Lift the keyboard from the LCD display side, then gently turn it over the touchpad. Be careful not to detach the cable (1) when lifting the keyboard.

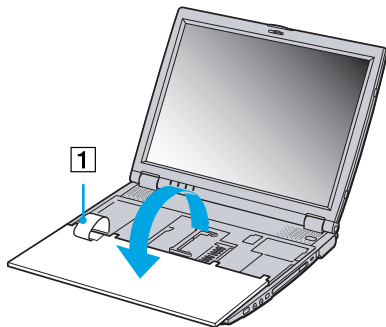

- 8 Remove the existing memory module.
- 9 Remove the new memory module from its packaging.
- 10 Install the memory module. Be careful not to touch the other components on the motherboard.
 - Slide the memory module into the slot.
 - Snap the connectors into place when the board is correctly seated.

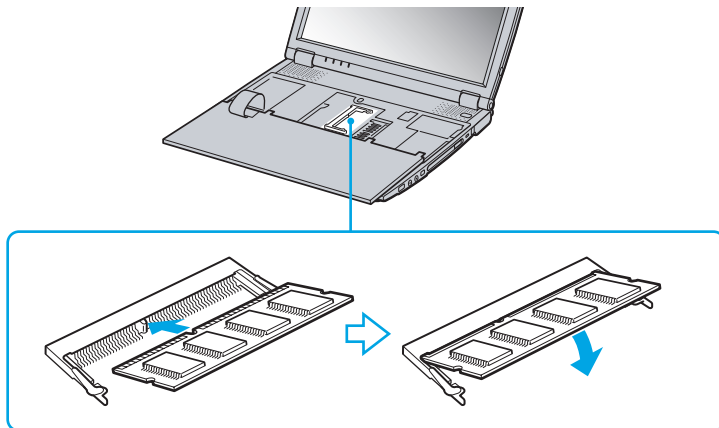

- 11 Gently replace the keyboard, then press it into your computer. Be careful not to detach the cable when lifting the keyboard.

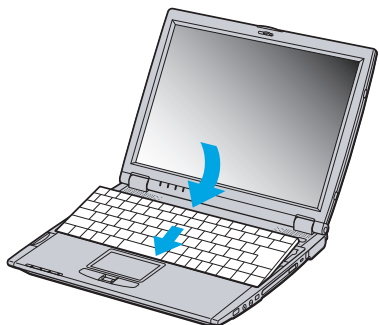

- 12 Close the computer cover, then tighten the screws on the bottom of the computer.

Viewing the amount of memory

To view the amount of memory, proceed as follows:

- 1 Turn on the computer.
- 2 Go to **Sony Notebook Setup** via the **Start** menu.
The **Sony Notebook Setup** dialog box appears.
- 3 In the **About this Computer** tab you can view the amount of system memory. If the additional memory does not appear, repeat the whole procedure and restart the notebook.

Other precautions

On handling the hard disk

The hard disk has a high storage density and reads or writes data in a short time. On the other hand, it may be easily damaged by mechanical vibration, shock or dust.

Although the hard disk has the safety device in itself to prevent losing data due to mechanical vibration, shock or dust, you should be careful when handling your computer.

To avoid damaging your hard disk:

- Do not give a shock to your computer.
- Keep away from magnets.
- Do not place your computer in a location subject to mechanical vibration or in unstable situation.
- Do not move your computer while the power is on.
- Do not turn off the power or restart the computer while reading or writing data.
- Do not use your computer in a place subject to extreme change of temperature.

 If the hard disk is damaged, the data cannot be restored.

On handling the LCD screen

- ❑ Do not leave the LCD facing the sun as it can damage the LCD. Be careful when using the computer near a window.
- ❑ Do not scratch the LCD or exert pressure on it. This could cause malfunction.
- ❑ Using the computer in low temperature conditions may produce a residual image on the screen. This is not a malfunction. When the computer returns to normal temperature, the screen returns to normal.
- ❑ A residual image may appear on the screen if the same image is displayed for a lengthy period of time. The residual image disappears in a while. You can use a screensaver to prevent residual images.
- ❑ The screen becomes warm during operation. This is normal and does not indicate a malfunction.
- ❑ The LCD is manufactured using high-precision technology. You may, however, see tiny black points and/or bright points (red, blue, or green) that continuously appear on the LCD. This is a normal result of the manufacturing process and does not indicate a malfunction.
- ❑ Avoid rubbing the LCD screen, as this can damage the screen. Use a soft, dry cloth to wipe the LCD screen.

On using power source

- ❑ Your computer operates on 100V-240V AC 50/60 Hz.
- ❑ Do not share the AC outlet with other power-consuming equipment, such as a photocopier or shredder.
- ❑ You can purchase a power strip with a surge protector. This device prevents damage to your computer caused by sudden power surges such as those that may occur during an electrical storm.
- ❑ Do not place heavy objects on the power cord.
- ❑ To disconnect the cord, pull it out by the plug. Never pull the cord itself.
- ❑ Unplug your computer from the wall outlet, if you will not be using the computer for a long time.
- ❑ When the AC adapter is not used, unplug it from the AC outlet.
- ❑ Use only the supplied AC adapter. Do not use any other AC adapter.

On handling your notebook

- ❑ Clean the cabinet with a soft, dry cloth or a soft cloth lightly moistened with a mild detergent solution. Do not use any type of abrasive pad, scouring powder, or solvent such as alcohol or benzine, as these may damage the finish of your computer.
- ❑ Should any solid object or liquid fall into the computer, shut down your computer and then unplug it. You may want to have the computer checked by qualified personnel before operating it any further.
- ❑ Do not drop the computer or place heavy objects on top of the computer.
- ❑ Do not place your computer in a location subject to:
 - ❑ Heat sources, such as radiators or air ducts,
 - ❑ Direct sunlight,
 - ❑ Excessive dust,
 - ❑ Moisture or rain,
 - ❑ Mechanical vibration or shock,
 - ❑ Strong magnets or speakers that are not magnetically shielded,
 - ❑ Ambient temperature of more than 35°C or less than 10°C,
 - ❑ High humidity.
- ❑ Do not place electronic equipment near your computer. The electromagnetic field of your computer may cause a malfunction.
- ❑ Provide adequate air circulation to prevent that internal heat builds up. Do not place your computer on porous surfaces such as rugs or blankets, or near material such as curtains or draperies that may block its ventilation slots.
- ❑ The computer uses high-frequency radio signals and may cause interference to radio or TV reception. Should this occur, relocate the computer a suitable distance away from the set.
- ❑ Use only specified peripheral equipment and interface cables; otherwise, problems may result.

- ❑ Do not use cut or damaged connection cables.
- ❑ Your computer cannot be connected to a coin-operated telephone, and may not work with a private branch exchange (PBX).
- ❑ If the computer is brought directly from a cold location to a warm one, moisture may condense inside your computer. In this case, allow at least one hour before turning on your computer. If any problem occurs, unplug your computer and contact VAIO-Link.
- ❑ Make sure to disconnect the power cord before cleaning the computer.
- ❑ As you may lose important data once your computer is damaged, you should back up your data regularly. Restore the original application programs from the Product Recovery CD-ROM.

On handling diskettes

- ❑ Do not open the shutter manually and touch the surface of the diskette.
- ❑ Keep diskettes away from magnets.
- ❑ Keep diskettes away from direct sunlight and other heat sources.

On handling CD-ROMs

- ❑ Do not touch the surface of the disc.
- ❑ Do not drop or bend the disc.
- ❑ Fingerprints and dust on the surface of a disc may cause read errors. Always hold the disc by its edge and its central hole, as shown:

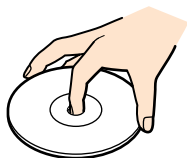

- ❑ Proper care of the disc is essential to its continuous reliability. Do not use solvents such as benzine, thinning agents, commercially available cleaners or anti-static spray, as they may cause damage to the disc.
- ❑ For normal cleaning, hold the disc by its edge and use a soft cloth to wipe the surface from the center out.
- ❑ If the disc is badly soiled, moisten a soft cloth with water, wring it out well, and use it to wipe the surface of the disc from the center out. Wipe off any remaining moisture with a dry soft cloth.

On using the battery pack

- ❑ Never leave the battery pack in temperatures above 60°C, such as in a car parked in the sun or under direct sunlight.
- ❑ Battery life is shorter in a cold environment. This is due to decreased battery efficiency at low temperatures.
- ❑ Charge the batteries at temperatures between 10°C to 30°C. Lower temperatures require a longer charging time.
- ❑ While the battery is in use or being discharged, the battery pack heats up. This is normal and is not cause for concern.
- ❑ Keep the battery pack away from all sources of heat.
- ❑ Keep the battery pack dry.
- ❑ Do not open or try to disassemble the battery pack.
- ❑ Do not expose the battery pack to any mechanical shock.
- ❑ If you are not using the computer for an extended period of time, remove the battery pack from the computer to prevent damage to the battery.
- ❑ If, after fully charging the battery pack, the battery power is still low, the battery pack may be reaching the end of its life and should be replaced.

- ❑ You do not need to discharge the battery before recharging.
- ❑ If you have not used the battery pack for a considerable amount of time, recharge the battery.

On using earphones

- ❑ **Road safety** – Do not use earphones while driving, cycling, or operating any motorized vehicle. It may create a traffic hazard and is illegal in some areas. It can also be potentially dangerous to play loud music while walking, especially at pedestrian crossings.
- ❑ **Preventing hearing damage** – Avoid using earphones at high volume. Hearing experts advise against continuous, loud and extended play. If you experience a ringing in your ears, reduce the volume or discontinue use.

On handling the Memory Stick™

- ❑ Do not touch the Memory Stick™ connector with your finger or metallic objects.
- ❑ Use only the label supplied with the Memory Stick™ as a label.
- ❑ Do not bend, drop, or apply strong shock to the Memory Stick™.
- ❑ Do not disassemble or modify Memory Sticks™.
- ❑ Do not let Memory Sticks™ get wet.
- ❑ Do not use or store Memory Sticks™ in a location subject to:
 - ❑ Extremely high temperatures, such as in a car parked in the sun,
 - ❑ Direct sunlight,
 - ❑ High humidity or near corrosive substances.
- ❑ Use the storage case supplied with the Memory Stick™.

Notebook specifications

<i>Product name</i>	PCG-R600MEP	PCG-R600HEPIHEPD
<i>Operating system</i>	Microsoft® Windows® XP Professional	
<i>Processor</i>	Mobile Intel® Celeron™ processor 750 MHz	Mobile Intel® Pentium® III processor 850 MHz
<i>Hard disk drive</i>	20 GB	
<i>Standard RAM</i>	128 MB SDRAM (on board)	
<i>Maximum RAM</i>	256 MB	
<i>LCD screen</i>	12.1" XGA TFT	
<i>L2 cache memory</i>	128 KB (on die)	256 KB (on die)
<i>MPEG</i>	MPEG 2 Digital Video Supports full-screen playback	
<i>Graphics</i>	Intel 815EM Chipset integrated graphic accelerator Video RAM: max 11MB (shared with main memory) with 3D accelerator	
<i>Sound capabilities</i>	16-bit CD-quality stereo sound	
<i>Internal modem</i>	Built-in modem V.90/K56Flex (56kbps) data/fax modem	
<i>Telecommunication capabilities</i>	Ethernet network, PSTN data connectivity	

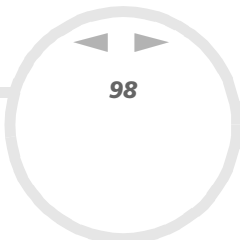

<i>Product name</i>	PCG-R600MEP	PCG-R600HEPIHEPD
<i>Expansion capabilities</i>	One PCMCIA type II Card and Cardbus support	
<i>Built-in capabilities</i>	Stereo speakers, touchpad, Jog Dial™, Memory Stick™	
<i>Special button</i>	Jog Dial™	
<i>Connection capabilities on notebook</i>	docking connector, VGA monitor, external speakers or headphone, microphone, 2xUSB, type II PC Cards, i.LINK™ (IEEE1394) S400, network (LAN), phone line	
<i>Supplied accessories</i>	rechargeable battery, AC adapter, AC cord, phone cable, phone plug.	
<i>Docking station (PCGA-DSM5 / PCGA-DSD5)</i>	Optional	Optional for PCG-R600HEP PCGA-DSM5 bundled with PCG-R600HEPD
<i>Service</i>	‡ 1 year free VAIO-Link Service	
<i>Power source</i>	19.5V DC/AC100-240V	
<i>Power management</i>	Energy Star compliant ACPI (Advanced Configuration & Power Interface)	
<i>Battery</i>	Lithium ion	
<i>Dimensions</i>		
<i>Width</i>	279.5 mm	
<i>Height</i>	23 mm to 29.3 mm	
<i>Depth</i>	239 mm	

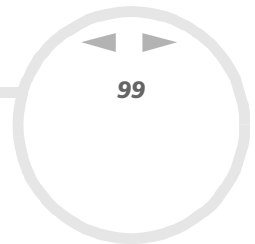

Product name **PCG-R600MEP** **PCG-R600HEPIHEPD**

<i>Weight</i> <i>With battery</i> <i>With battery & optional docking station</i>	1.7 kg 2.7 kg
<i>Operating temperature</i>	+5°C to +35°C (temperature gradient less than 10°C/hour)
<i>Storage temperature</i>	-20°C to +60°C (temperature gradient less than 10°C/hour)
<i>Operating humidity</i>	20% to 80% (not condensed), provided that humidity is less than 65% at +35°C (hygrometer reading of less than 29°C)
<i>Storage humidity</i>	10% to 90% (not condensed), provided that humidity is less than 20% at +60°C (hygrometer reading of less than 35°C)

‡ See our special Guarantee extension conditions.

Specifications are subject to change without notice.

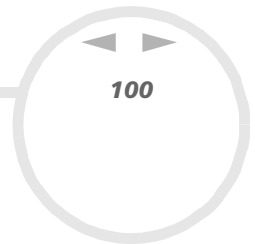

(optional) Docking station specifications

Product name

**CD-RW/DVD Docking station
(PCGA-DSM5)**

**DVD Docking station
(PCGA-DSD5)***

<i>Optical drive</i>	up to 24x max. CD-ROM reading speed up to 8x max. CD-R writing speed up to 4x max. CD-RW writing speed up to 8x max. DVD-ROM reading speed	up to 24x max. CD-ROM reading speed up to 8x max. DVD-ROM reading speed
<i>Floppy disk drive</i>	3.5" 1.44 MB/720 KB	
<i>Connectors</i>	i.LINK™ (IEEE1394) S400 connector, Ethernet (10BASE-T/100BASE-TX) network port, printer port, VGA monitor port, serial port, 2 USB ports, docking connector, DC In	
<i>Dimensions</i>	Approx. 279.5 mm (w) x 18.5 mm (h) (21.5 mm backside) x 235.0 mm(d) (The projecting parts are not included)	
<i>Weight</i>	1.080 g	

* PCG-DSD5 is bundled with PCG-R600HEPD.

Specifications are subject to change without notice.

Glossary

This section refers to terms used in this manual. These terms and definitions have been compiled to provide you with a better understanding of your VAIO computer.

Term	Definition
<i><F1> key</i>	The <F1> key gives you access to the online help of most software.
<i>10BASE-T/100BASE-TX</i>	Ethernet system providing data transfer rates of 10 Mbps (megabits per second) and 100 Mbps. The 100BASE-TX is a very direct derivative of 10BASE-T. Its 100 Mbps speed is achieved by simply sending the signal 10 times faster.
<i>ACPI</i>	Short for Advanced Configuration and Power Interface, a power management specification. ACPI enables the operating system to turn peripherals on and off and to control the amount of power given to each device attached to the computer. With ACPI, a CD-ROM player can be turned off by the operating system if it is not in use.
<i>Application recovery</i>	A recovery process that enables you to recover any of the applications initially available on the computer. Performing an application recovery is useful when an individual application does not run properly or to reinstall a driver when a device does not work properly.
<i>Application recovery CD-ROM</i>	CD-ROM that enables a VAIO computer user to recover all the applications that were available when the computer was purchased. The CD-ROM is supplied with the computer.
<i>BIOS</i>	An acronym for Basic Input/Output System. The BIOS is a program that enables the computer to start when you turn it on. It monitors the data stream between the operating system and the computer's hardware devices.
<i>CardBus</i>	CardBus is the commercial name for an advanced PC Card. The CardBus technology allows computer users to enjoy higher performances as far as data transfer and operating speed are concerned. See PCMCIA.

Term	Definition
<i>CD-ROM</i>	Abbreviation for Compact Disc Read-Only Memory. A high-capacity optical disc, usually 650 MB in size, capable of being read from but not written to.
<i>CD-RW</i>	Short for Compact Disc-ReWriteable. Compact Disc that can be used to write or rewrite data to it. A CD-RW can be written to several times, a CD-R can only be written to once.
<i>CPU</i>	The CPU (Central Processing Unit) is the brains of the computer; it processes the instructions of your system's programs. The CPU is also known as the processor or microprocessor and can be found on the motherboard of your computer.
<i>DC In</i>	The Direct Current interface to which you connect your computer's AC adapter.
<i>Docking station</i>	An additional device that you can connect to your notebook. The docking station contains slots for expansion boards, bays for storage devices and ports for additional peripherals (such as printers or monitors).
<i>Driver</i>	A driver is software enabling you to use hardware devices. For example, in order for you to be able to use a printer, you must first install its driver. Many drivers, such as the mouse driver, come with the operating system.
<i>DVD-ROM</i>	Short for Digital Video Disc. A type of read-only CD with a minimum capacity of 4.7 GB (maximum capacity can reach 17 GB). This high storage power makes it the ideal medium for storing films.
<i>Ethernet</i>	Ethernet is the most widely implemented local area network (LAN) technology. The Ethernet system called 10BASE-T provides data transfer rates of 10 Mbps (megabits per second). A more recent version of Ethernet, called 100BASE-T, provides data transfer rates of 100 Mbps. Gigabit Ethernet supports data rates of 1 gigabit (1,000 megabits) per second.

<i>Term</i>	<i>Definition</i>
<i>EULA</i>	EULA (End-User License Agreement) is the name given to a license governing the software on your computer. The EULA can be found in the Read this first section at the beginning of the software guide or directly on the VAIO desktop.
<i>i.LINK™</i>	i.LINK™ is Sony's version of the IEEE 1394 standard for high-speed digital serial interface. The standard is regarded in the audio/video and IT industries as the most suitable interface for connecting computers and digital audio/video devices (such as digital cameras etc.).
<i>ISP</i>	An ISP (Internet Service Provider) is a company which provides you with a user name, password and telephone number in order to connect to the Internet.
<i>L2 cache memory</i>	Cache memory is RAM-like memory that enables quick access to data that has already been read by the computer. L1 and L2 are levels of cache memory in a computer.
<i>LAN</i>	A LAN (Local Area Network) is a group of computers connected together within a limited geographical area. It enables users to share devices (such as printers) and information using one processor or server.
<i>LCD</i>	Short for Liquid Crystal Display. Flat notebook display technology using liquid crystals (and light polarisation) to provide sharp, flicker-free images on a screen comprised of millions of tiny cells. Color can be produced by two basic techniques. Passive matrix is the less expensive of the two technologies. The active matrix technology (or TFT) produces better quality but is also more expensive.
<i>LED</i>	Short for Light-Emitting Diode. A semiconductor device that lights up when electricity passes through it.
<i>Lithium-ion battery</i>	A lithium-ion battery uses lithium cobalt oxide and carbon as electrodes and ions move from one electrode to the other during charge and discharge. Lithium-ion batteries are the first choice for notebooks because of their light weight, high energy density and because they have no memory effect. In addition they do not use heavy metals like lead, mercury or cadmium.

Term	Definition
<i>MAPI</i>	Short for Messaging Application Program Interface. A Microsoft Windows interface enabling you to send e-mail messages. It allows e-mail access and distribution among applications. MAPI-compatible applications include a Send Mail or Send in the File menu of the application.
<i>maximum RAM</i>	The maximum amount of RAM that your computer can contain. Once this amount is reached, you can no longer add additional RAM to your computer.
<i>Motherboard</i>	The motherboard is the main circuit board inside your computer. It holds the CPU, the BIOS, the memory and so on.
<i>MPEG</i>	MPEG or Moving Pictures Experts Group is a standard for audio-visual compression of video sequences. MPEG achieves high compression rates by storing only the changes from one frame to another. The decrease in data is generally imperceptible to the human eye. MPEG-1 was developed for digital storage of video and audio data on CD-ROM. MPEG-2 achieves better image and audio quality and is more targeted to TV broadcasting and DVD.
<i>Operating system</i>	The operating system is software that manages all the other programs in a computer. It defines how the computer reads and writes information to its disks (and other hardware). Windows 2000, Windows Millennium Edition, Windows XP Professional and Windows XP Home Edition are examples of operating systems found on VAIOs.
<i>Partition</i>	A partition is a logical division of a computer's hard disk. A two-partition hard drive would typically contain C: and D: drives. Partitioning is particularly useful if you run more than one operating system or to clearly separate your data files from your installed software.
<i>PBX</i>	A PBX (Private Branch Exchange) is a private telephone network within an enterprise. Under this system, the calls between the enterprise members are local and the phone numbers are made up of 3 or 4 digits. Companies generally choose this phone system for internal communication because it is less expensive than the regular network. The users can still share a number of outside lines for making calls external to the PBX.

Term	Definition
<i>PC Card</i>	A PCMCIA card. The term PC Card is more widely used than PCMCIA. See PCMCIA.
<i>PCMCIA</i>	PCMCIA (Personal Computer Memory Card International Association) is the name of the group that produced the specification for the credit card-sized plug-in boards for laptop computers. The cards used to be called PCMCIA cards, but as this was rather unpronounceable, these cards are now termed PC cards. An example of a PC card is a credit card-sized modem.
<i>Pixel</i>	A pixel (Picture Element) is a part of your screen. Your screen is made up of thousands of pixels, enabling you to see colours and pictures on it. The more pixels, the higher the resolution and the better the image quality.
<i>Port replicator</i>	An additional device that you can connect to your notebook. The port replicator contains ports that enable you to connect additional peripherals (such as a printer or a monitor) to your VAIO. A port replicator is similar to a docking station, but does not include additional slots for adding expansion boards or storage devices.
<i>Processor</i>	The processor is the brains of the computer; it processes the instructions of your system's programs. The processor is also known as the CPU or microprocessor and can be found on the motherboard (see this word) of your computer.
<i>Product recovery CD-ROM</i>	The product recovery CD-ROMs include the application recovery CD-ROM and the system recovery CD-ROM(s)
<i>PS/2</i>	A type of mouse or keyboard port.
<i>PSTN</i>	PSTN (Public Switched Telephone Network) refers to the plain old telephone service, the national telecommunication networks implementing voice transmission by using analog signals.

Term	Definition
<i>RAM</i>	Short for Random Access Memory, the memory used to run programs and store data in current use. RAM is the fastest kind of memory to read from and write to. Information stored in RAM is lost when you turn off the computer. The higher the RAM capacity, the faster your current data can be processed.
<i>Resolution</i>	The degree of sharpness and clarity of an image. Resolution is expressed in pixels. Frequent computer screen resolutions are 640 x 480 pixels (VGA resolution; appropriate for a 14-inch screen), 800 x 600 (appropriate for a 15-inch screen), 1,024 by 768 (appropriate for a 17-inch screen), and 1,280 by 1,024. LCD displays usually use a higher resolution than a CRT of the same size.
<i>RGB signal cable</i>	RGB stands for Red, Green, Blue. A cable that requires separate transmission types for the three colours on the display.
<i>SDRAM</i>	Synchronous DRAM is a kind of dynamic random access memory running at a much higher clock speed than regular memory.
<i>SELV</i>	Short for Safety Extra Low Voltage. A secondary circuit which is so designed and protected that its voltages do not exceed a safe value under normal operating conditions.
<i>Standard RAM</i>	The amount of RAM that is available on your computer when you purchase it.
<i>System recovery</i>	A recovery process that enables you to recover the hard disk image initially available on the computer. Performing a system recovery is useful in the event of a serious system crash or if you want to modify the size of your partitions.
<i>System recovery CD-ROM</i>	CD-ROM that is supplied with your computer and that enables a VAIO computer user to recover the hard disk image that was available when the computer was purchased.

Term	Definition
<i>TFT</i>	Short for Thin Film Transistor. Top-of-the-range notebook display for excellent picture quality. The TFT technology offers the sharpest resolution for flat displays; each pixel is supported by one to four transistors.
<i>TNV</i>	Short for Telecommunications Network Voltage. A secondary circuit that, under normal operating conditions, carries telecommunication signals. A typical TNV-circuit is a PSTN (Public Switched Telephone Network) modem.
<i>UPS</i>	A UPS (Uninterruptible Power Supply) is a device including a battery that protects your computer from data loss in the event of a power failure. The battery takes over as soon as a power interruption is detected. If you are using the computer when the power failure occurs, you have time to save all unsaved data and to shut down your computer.
<i>USB</i>	USB (Universal Serial Bus) is a hardware interface for attaching devices (such as a keyboard, mouse, joystick, scanner or printer). You can connect up to 127 devices to a USB port. The USB standard is Hot Plug and Play.
<i>VAIO</i>	Short for Video Audio Integrated Operation. Brand name covering Sony's PC products, peripherals, accessories and software. VAIO-branded items are all designed to make the best use of Sony's Audio-Video (AV) and Information Technology (IT) skills.
<i>WAN</i>	WAN (Wide Area Network) is a computer network connected together and covering a relatively large geographical area. This is in contrast to LAN, where the network is usually set up within one building or small geographical area. The largest existing WAN is the Internet.
<i>XGA</i>	Short for Extended Graphic Array, a graphics standard. An XGA board can provide up to 1,024 x 768 pixels and supports up to 65 thousand colours.