

# LCD Digital Colour TV

## Operating Instructions

Setting Up

Watching TV

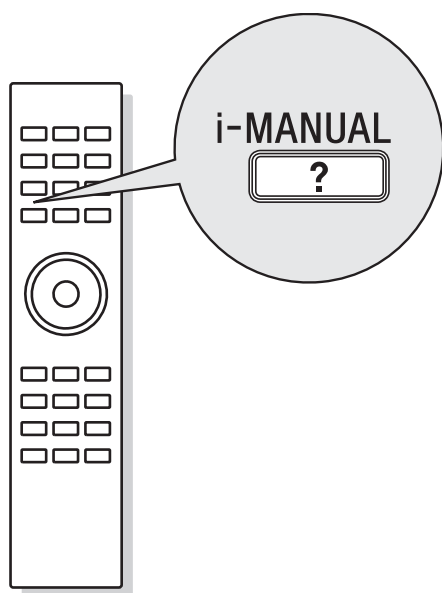

Additional Information



# BRAVIA

# NOTICE FOR CUSTOMERS IN THE UNITED KINGDOM

A moulded plug complying with BS1363 is fitted to this equipment for your safety and convenience.

Should the fuse in the plug supplied need to be replaced with the same rating of fuse approved by ASTA or BSI to BS 1362 (i.e., marked with  or ) must be used. When an alternative type of plug is used it should be fitted with the same rating of fuse, otherwise the circuit should be protected by a 10 AMP FUSE at the distribution board.

If the plug supplied with this equipment has a detachable fuse cover, be sure to attach the fuse cover after you change the fuse. Never use the plug without the fuse cover. If you should lose the fuse cover, please contact your nearest Sony service station.

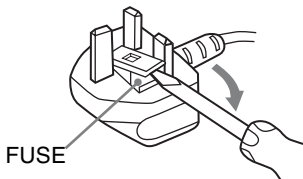
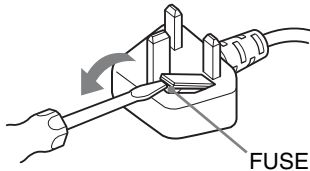

## How to replace the fuse

Open the fuse compartment with a blade screwdriver, and replace the fuse. Please refer to the illustration that actually equipped with the product.

## Introduction

Thank you for choosing this Sony product. Before operating the TV, please read this manual thoroughly and retain it for future reference.

The manufacturer of this product is Sony Corporation, 1-7-1 Konan Minato-ku Tokyo, 108-0075 Japan. The Authorized Representative for EMC and product safety is Sony Deutschland GmbH, Hedelfinger Strasse 61, 70327 Stuttgart, Germany. For any service or guarantee matters please refer to the addresses given in separate service or guarantee documents.

## Notes on Digital TV function

- Any functions related to Digital TV (DVB) will only work in countries or areas where DVB-T (MPEG-2 and H.264/MPEG-4 AVC) digital terrestrial signals are broadcast or where you have

access to a compatible DVB-C (MPEG-2 and H.264/MPEG-4 AVC) cable service. Please confirm with your local dealer if you can receive a DVB-T signal where you live or ask your cable provider if their DVB-C cable service is suitable for integrated operation with this TV.

- Your cable provider may charge a fee for their services, or require you to agree to its terms and conditions of business.
- This TV set complies with DVB-T and DVB-C specifications, but compatibility with future DVB-T digital terrestrial and DVB-C digital cable broadcasts are not guaranteed.
- Some Digital TV functions may not be available in some countries/areas and DVB-C cable may not operate correctly with some providers.

For a list of compatible cable providers, refer to the support web site:

<http://support.sony-europe.com/TV/DVBC/>



- Instructions about "Installing Wall Mount Bracket" are included within this TV's instructions manual.
- The illustrations used in this manual are of the KDL-40NX803 series unless otherwise state.

## Trademark information

DVB is a registered trademark of the DVB Project.

HDMI, the HDMI logo and High-Definition Multimedia Interface are trademarks or registered trademarks of HDMI Licensing LLC.

DLNA and DLNA CERTIFIED are trademarks and/or service marks of Digital Living Network Alliance.

Manufactured under license from Dolby Laboratories. Dolby and the double-D symbol are trademarks of Dolby Laboratories.

"BRAVIA" and BRAVIA are trademarks of Sony Corporation.

"XMB™" and "XrossMediaBar" are trademarks of Sony Corporation and Sony Computer Entertainment Inc.



## Notice for Wireless Signal

1. Hereby, Sony, declares that this unit is in compliance with the essential requirements and other relevant provisions of Directive 1999/5/EC.

To obtain the declaration of conformity (DoC) for R&TTE Directive, please access the following URL address.

<http://www.compliance.sony.de/>



2. TV wireless system can only be used in the following countries:

Austria, Belgium, Bulgaria, Cyprus, Czech Republic, Denmark, Estonia, Finland, France, Germany, Greece, Hungary, Iceland, Ireland, Italy, Latvia, Liechtenstein, Lithuania, Luxembourg, Malta, The Netherlands, Norway, Poland, Portugal, Slovak Republic, Romania, Slovenia, Spain, Sweden, Switzerland, Turkey, and The United Kingdom.

## TV Wireless System - Regulation Information

### For Customers in Italy

- with respect to private use, by the Legislative Decree of 1.8.2003, no. 259 ("Code of Electronic Communications"). In particular Article 104 indicates when the prior obtainment of a general authorization is required and Art. 105 indicates when free use is permitted;
- with respect to the supply to the public of the RLAN access to telecom networks and services (e.g. TV wireless system), by the Ministerial Decree 28.5.2003, as amended, and Art. 25 (general authorization for electronic communications networks and services) of the Code of electronic communications)
- with respect to private use, by the Ministerial Decree 12.07.2007

### For Customers in Norway

Use of this radio equipment is not allowed in the geographical area within a radius of 20 km from the centre of Ny-Ålesund, Svalbard.

### For Customers in Cyprus

The end user must register the RLAN (or WAS or WiFi) devices in the Department of Electronic Communications (P.I. 6/2006 and P.I. 6A/2006).

P.I. 6/2006 is the Radiocommunications (Categories of Stations Subject to General Authorization and Registration) Order of 2006.

P.I. 6A/2006 is the General Authorization for the use of Radiofrequencies by Radio Local area Networks and by Wireless Access Systems, including Radio Local Area Networks (WAS/RLAN)

### For Customers in France

The WLAN (WiFi) feature of this LCD Digital Colour TV shall exclusively be used inside buildings. Any use of the WLAN (WiFi) feature of this LCD Digital Colour TV outside of the buildings is prohibited on the French territory. Please make sure that the WLAN (WiFi) feature of this LCD Digital Colour TV is disabled before any use outside of the buildings. (ART Decision 2002-1009 as amended by ART Decision 03-908, relating to radio-frequencies use restrictions).

## Location of the identification label

Labels for Model No. and Power Supply rating (in accordance with applicable safety regulation) are located on the rear of the TV. For KDL-NX800 series models, they can be found by removing the bottom cover.

# Table of Contents

Checking the accessories .....	3
Inserting batteries into the remote .....	3
<b>Setting Up</b>	
Attaching the Table-Top Stand .....	4
Connecting an antenna (aerial)/Set Top Box/recorder (e.g. DVD recorder) .....	5
Preventing the TV from toppling over .....	5
Bundling the cables.....	6
Performing the initial set-up .....	6
Detaching the Table-Top Stand from the TV .....	7
<b>Watching TV</b>	
To watch programmes .....	8
To utilise the TV's features .....	8
To use i-Manual .....	9
<b>Additional Information</b>	
Troubleshooting .....	10
Specifications .....	11
Installing the Accessories (Wall-Mount Bracket).....	13
TV installation dimensions table .....	14
Safety Information.....	15
Precautions.....	16

- Operating instructions are built into your BRAVIA TV. Refer to “To use i-Manual” for operation (page 9).
- Before operating the TV, please read “Safety Information” (page 15). Retain this manual for future reference.

## Checking the accessories

AC power cord (mains lead) (1)

Cable holder (1)

Remote (1)

Size AAA batteries (R3 type) (2)

Black spacers (4)

(KDL-52/40NX803 only)

Stand rear cover (1)

Bottom cover (1)

(KDL-52/40NX803 only)

Table-Top Stand (1)\*

Fixing screws for stand (M5 × 16) (4)

Assembling screws for stand (M5 × 16) (4)

(KDL-40NX803 and KDL-40NX703 only)

\* Disassembled except for KDL-52NX803 and KDL-46NX703.

Refer to the supplied Table-Top Stand leaflet to assemble the stand.

## Inserting batteries into the remote

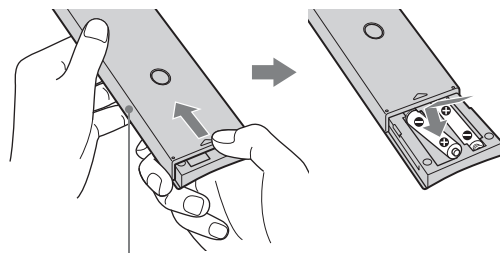

Slide the cover to open.

## Attaching the Table-Top Stand

- 1 Refer to the supplied Table-Top Stand leaflet for proper attachment for some TV models.
- 2 Place the TV set on the Table-Top Stand.

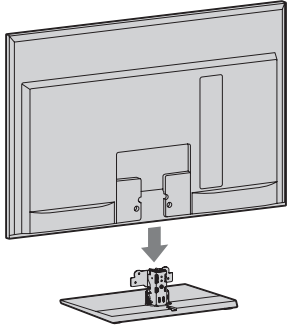

- 3 Fix the TV to the Table-Top Stand according to the arrow marks  that guide the screw holes using the supplied screws.

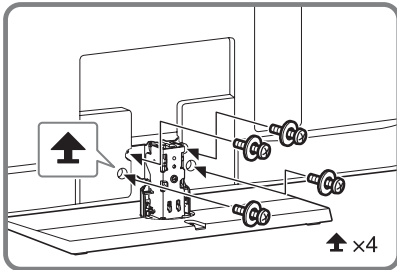

-  If using an electric screwdriver, set the tightening torque at approximately 1.5 N·m {15 kgf·cm}.

- 4 After all the screws are tightened, attach the supplied stand rear cover to the Table-Top Stand.

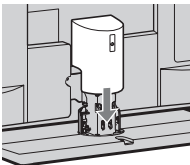

## Adjusting the viewing angle of the TV

This TV can be adjusted within the angles shown below.

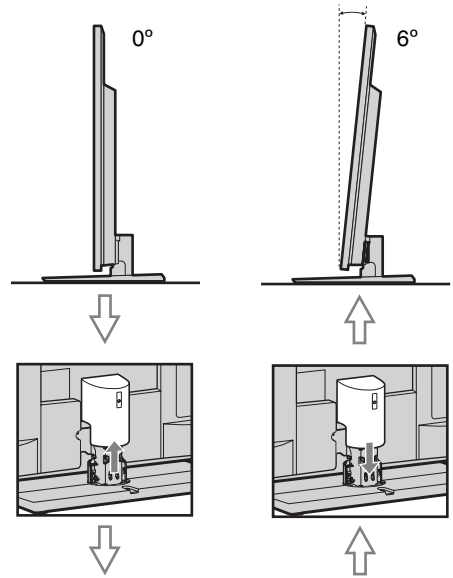

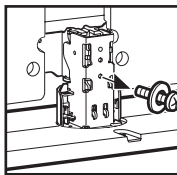
- 1   
Remove screw as shown.

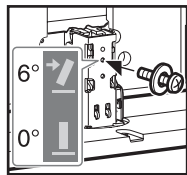
- 4   
Install screw into the top screw hole of the Table-Top Stand.

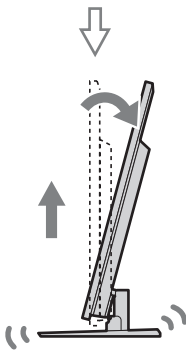
- 2   
Lift up and tilt.

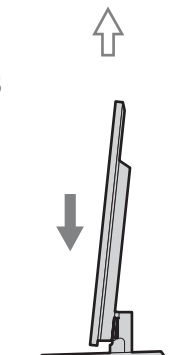
- 3   
Slide in.

-  To return to 0°, reverse the above procedure.

## Connecting an antenna (aerial)/Set Top Box/recorder (e.g. DVD recorder)

Connecting a Set Top Box/recorder (e.g. DVD recorder) with SCART

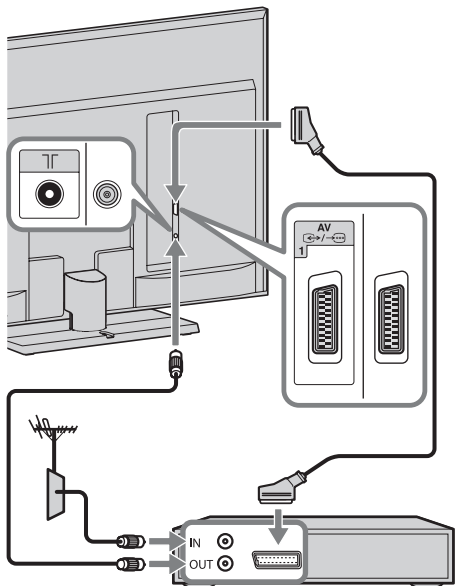

Set Top Box/recorder (e.g. DVD recorder)



- Right Angle Type Universal SCART Lead is recommended for this connection.

Connecting a Set Top Box/recorder (e.g. DVD recorder) with HDMI

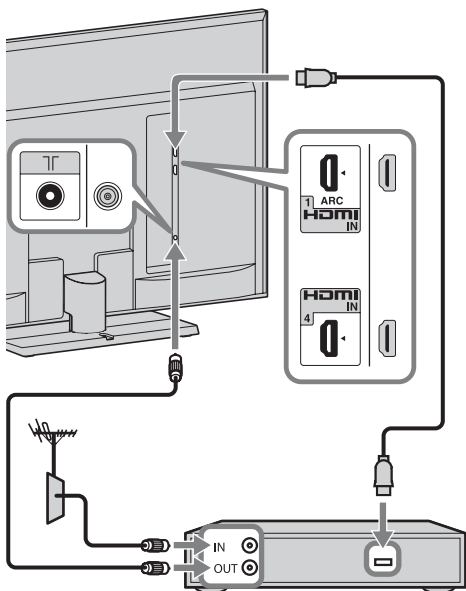

Set Top Box/recorder (e.g. DVD recorder)



- For KDL-52/40NX803, after connecting cables, install the bottom cover and stand rear cover.

## Preventing the TV from toppling over

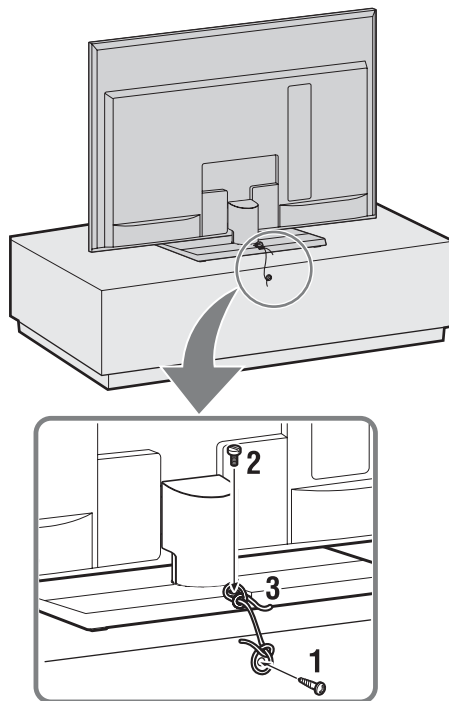

- 1 Install a wood screw (4 mm in diameter, not supplied) in the TV stand.
- 2 Install a machine screw (M4 × 16, not supplied) into the screw hole of the TV.
- 3 Tie the wood screw and the machine screw with a strong cord (not supplied).

## Bundling the cables

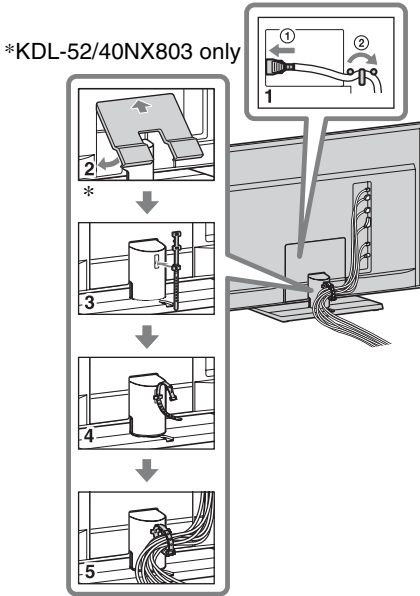

- Do not bundle the AC power cord (mains lead) together with other cables.

## Performing the initial set-up

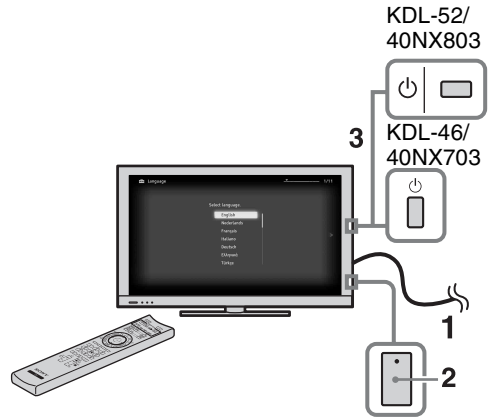

- 1 Connect the TV to your AC power outlet (mains socket).
- 2 Check the **ENERGY SAVING SWITCH** setting is on (●).
- 3 Press  on the TV.  
When you switch on the TV for the first time, the Language menu appears on the screen.

4

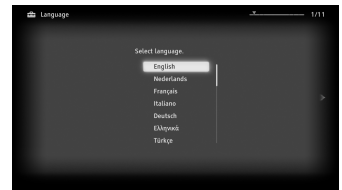

Follow the instructions on the screen.

**Digital Auto Tuning:** When you select “Cable”, we recommend that you select “Quick Scan” for quick tuning. Set “Frequency” and “Network ID” according to the information supplied from your cable provider. If no channel is found using “Quick Scan”, try “Full Scan” (though it may take some time).

For a list of compatible cable providers, refer to the support web site:

<http://support.sony-europe.com/TV/DVBC/>

**Programme Sorting:** Changes the order of analogue channels stored in the TV.

- 1 Press  $\uparrow/\downarrow$  to select the channel you want to move to a new position, then press  $\oplus$ .
- 2 Press  $\uparrow/\downarrow$  to select the new position for the channel, then press  $\oplus$ .



- You can also tune channels manually.

---

## Detaching the Table-Top Stand from the TV



- Remove the screws guided by the arrow marks  $\uparrow$  of the TV.
- Do not remove the Table-Top Stand for any reason other than to install corresponding accessories on the TV.

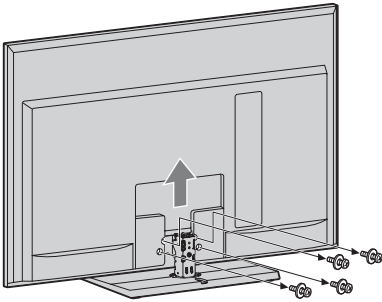

# Watching TV

## To watch programmes

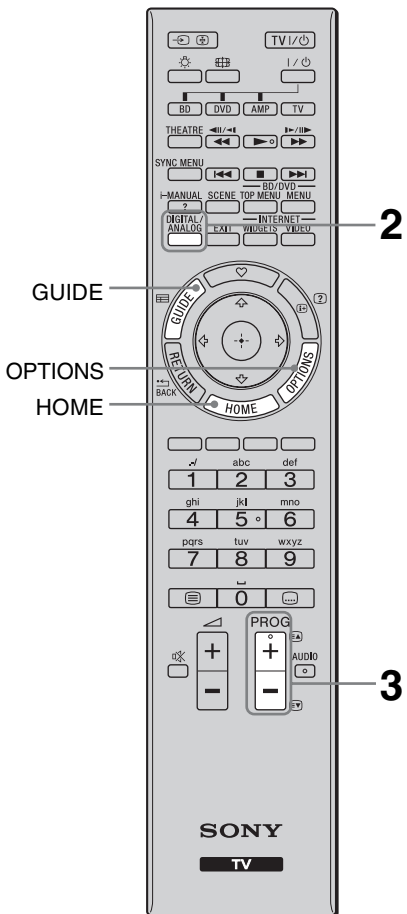

- The number 5, ►, **PROG +** and **AUDIO** buttons on the remote have a tactile dot. Use the tactile dots as a reference when operating the TV.

### 1 Turn on the TV.

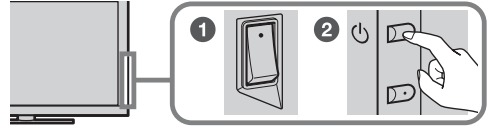

- 1 Switch **ENERGY SAVING SWITCH** on (●).
- 2 Press on the TV to turn on the TV.

### 2 Select a mode.



### 3 Select a TV channel.

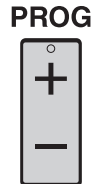

#### Using Digital Electronic Programme Guide

Press **GUIDE** in digital mode to display the programme guide.



## To utilise the TV's features

### HOME button

Press to display various operation and setting screens.

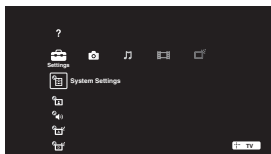

### OPTIONS button

Press to display convenient functions based on the current input or content.

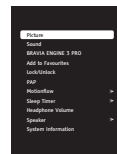



# To use i-Manual

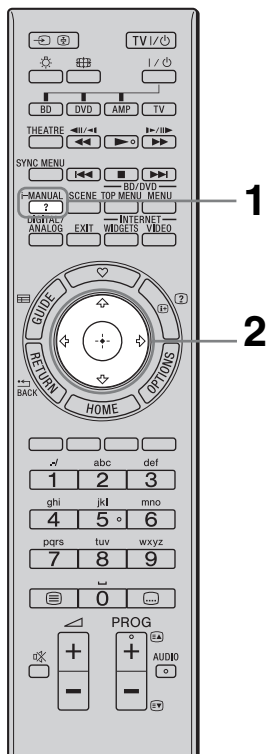

Operating instructions are built into your BRAVIA TV and can be displayed on the screen. You can browse your i-Manual anytime you need to find the varieties of convenient functions.

## 1 Press i-MANUAL.



## 2 Press $\leftarrow/\rightarrow/\uparrow/\downarrow/\oplus$ to select items.

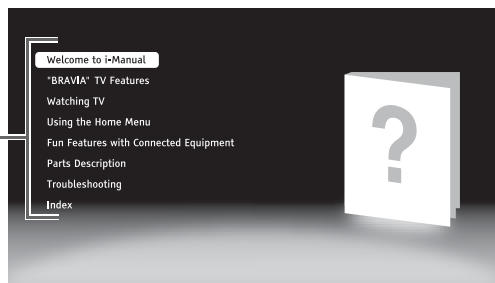
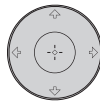

### ■ Welcome to i-Manual

### ■ “BRAVIA” TV Features

### ■ Watching TV

Introduces convenient features such as EPG Guide, Favourites, etc.

### ■ Using the HOME Menu

Customise your TV settings, etc.



- Images and illustrations may differ from what is displayed on the screen.

### ■ Fun Features with Connected Equipment

Introduces how to connect optional equipment.

### ■ Parts Description

### ■ Troubleshooting

Find solutions for your problem.



### ■ Index

# Troubleshooting

Check whether the  (standby) indicator is flashing in red.



## When the (standby) indicator is flashing

The self-diagnosis function is activated.







- 1 Count how many times the  (standby) indicator flashes between each three second break.  
For example, the indicator may flash three times, go off for three seconds, then flash again three times.
- 2 Press  on the TV to turn it off, disconnect the AC power cord (mains lead), and inform your dealer or Sony service centre of how the indicator flashes (number of flashes).

## When the (standby) indicator is not flashing

- 1 Check the items in the tables below. (Also refer to “Troubleshooting” in the i-Manual.)
- 2 If the problem persists, have your TV serviced by qualified service personnel.

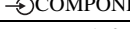
Condition	Explanation/Solution
<b>Picture</b>	
There is no picture (screen is dark) and no sound.	<ul style="list-style-type: none"><li>• Check the antenna (aerial)/cable connection.</li><li>• Connect the TV to the AC power (mains), and press  on the TV.</li><li>• If the  (standby) indicator lights up in red, press <b>TV I</b>/.</li></ul>
Tiny black points and/or bright points appear on the screen.	<ul style="list-style-type: none"><li>• The screen is composed of pixels. Tiny black points and/or bright points (pixels) on the screen do not indicate a malfunction.</li></ul>
<b>General</b>	
The TV's power cannot be turned on.	<ul style="list-style-type: none"><li>• Check if <b>ENERGY SAVING SWITCH</b> is on (●).</li></ul>
The TV turns off automatically (the TV enters standby mode).	<ul style="list-style-type: none"><li>• Check if the “Sleep Timer” is activated, or confirm the “Duration” setting of “On Timer”.</li><li>• Check if the “Idle TV Standby” is activated.</li></ul>
The remote does not function.	<ul style="list-style-type: none"><li>• Replace the batteries.</li><li>• Your TV may be in SYNC mode. Press <b>SYNC MENU</b>, select “TV Control” and then select “Home (Menu)” or “Options” to control the TV.</li></ul>
The “Parental Lock” password has been forgotten.	<ul style="list-style-type: none"><li>• Enter 9999 for the PIN code. (PIN code 9999 is always accepted.)</li></ul>
The TV surrounds become warm.	<ul style="list-style-type: none"><li>• When the TV is used for an extended period, the TV surrounds become warm. You may feel hot when touching there by the hand.</li></ul>

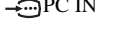
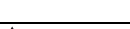
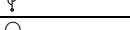
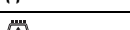
# Specifications

System	
Panel system	LCD (Liquid Crystal Display) Panel
TV system	Analogue: Depending on your country/area selection: B/G/H, D/K, L, I Digital: DVB-T2/DVB-T/DVB-C
Colour/video system	Analogue: PAL, PAL60 (only video input), SECAM, NTSC3.58, NTSC4.43 (only video input) Digital: MPEG-2 MP@ML/HL, H.264/MPEG-4 AVC MP/HP@L4
Channel coverage	Analogue: VHF: E2–E12/UHF: E21–E69/CATV: S1–S20/HYPER: S21–S41 D/K: R1–R12, R21–R69/L: F2–F10, B–Q, F21–F69/I: UHF B21–B69 Digital: VHF/UHF
Sound output	10 W + 10 W
Input/Output jacks	
Aerial/Antenna cable	75 ohm external terminal for VHF/UHF
 AV1	21-pin scart connector (CENELEC standard) including audio/video input, RGB input and TV audio/video output.
 COMPONENT IN	Supported formats: 1080p, 1080i, 720p, 576p, 576i, 480p, 480i
 COMPONENT IN	Audio input (phono jacks)
HDMI IN1, 2, 3, 4	Video: 1080/24p, 1080p, 1080i, 720p, 576p, 576i, 480p, 480i Audio: Two channel linear PCM: 32, 44.1 and 48 kHz, 16, 20 and 24 bits, Dolby Digital Analogue audio input (minijack) (HDMI IN2 only) PC Input
 AV2	Video input (phono jack)
 DIGITAL AUDIO OUT (OPTICAL)	Digital optical jack (Two channel linear PCM, Dolby Digital)
 PC IN	PC Input (Mini D-sub 15-pin)  PC audio input (minijack)
	USB port
	Headphones jack
	CAM (Conditional Access Module) slot
 LAN	10BASE-T/100BASE-TX connector (Depending on the operating environment of the network, connection speed may differ. 10BASE-T/100BASE-TX communication rate and communication quality are not guaranteed for this TV.) * For LAN connections, use a Category 7 10BASE-T/100BASE-TX cable (not supplied).

Model name KDL-	52NX803	46NX703	40NX803	40NX703	
Power and others					
Power requirements	220 V – 240 V AC, 50 Hz				
Screen size (measured diagonally)	52 inches/ Approx. 132.2 cm	46 inches/ Approx. 116.8 cm	40 inches/Approx. 101.6 cm		
Display resolution	1,920 dots (horizontal) × 1,080 lines (vertical)				
Power consumption	in “Home”/ “Standard” mode	125 W	96 W	104 W	81 W
	in “Shop”/ “Vivid” mode	169 W	129 W	133 W	109 W
Standby power consumption*1	0.23 W (18 W when “Quick Start” is set to “On”)		0.2 W (18 W when “Quick Start” is set to “On”)		
Average annual energy consumption*2	183 kWh	140 kWh	152 kWh	118 kWh	
Dimensions (Approx.) (w × h × d)					
with Table-Top Stand	126.1 × 81.9 × 40.0 cm	112.7 × 74.8 × 32.0 cm	99.4 × 66.9 × 29.0 cm	99.4 × 67.3 × 29.0 cm	
without Table-Top Stand	126.1 × 78.7 × 6.4 cm	112.7 × 71.6 × 6.4 cm	99.4 × 63.5 × 6.4 cm	99.4 × 64.1 × 6.4 cm	
Mass (Approx.)					
with Table-Top Stand	36.1 kg	27.8 kg	23.8 kg	22.6 kg	
without Table-Top Stand	30.1 kg	24.0 kg	20.1 kg	19.2 kg	
Supplied accessories	See “Checking the accessories” (page 3).				

Model name KDL-	52NX803	46NX703	40NX803	40NX703
Optional accessories	Wall-Mount Bracket: SU-WL700 TV stand: SU-52NX1 (KDL-52NX803) SU-46NX1 (KDL-46NX703) SU-40NX1 (KDL-40NX803/40NX703)			

\*<sup>1</sup> Specified standby power is reached after the TV finishes necessary internal processes.

\*<sup>2</sup> 4 hours a days and 365 days a year



- To save power consumption
  - when you reduce backlight setting (the brightness of the screen), the power consumption reduce.
  - the “Eco” settings (e.g. “Power Saving”, “Idle TV Standby” ) help you to reduce the power consumption and thus save money by reducing electricity bills.
  - when you switch off the TV using the **ENERGY SAVING SWITCH** (only certain models), power consumption will be almost zero.

Design and specifications are subject to change without notice.

## Installing the Accessories (Wall-Mount Bracket)

### To Customers:

For product protection and safety reasons, Sony strongly recommends that installing of your TV be performed by Sony dealers or licensed contractors. Do not attempt to install it yourself.

### To Sony Dealers and Contractors:

Provide full attention to safety during the installation, periodic maintenance and examination of this product.

Your TV can be installed using the SU-WL700 Wall-Mount Bracket (sold separately).

- Refer to the Instructions supplied with the Wall-Mount Bracket to properly carry out the installation.
- Refer to “Detaching the Table-Top Stand from the TV” (page 7).



- Remove the bottom cover and terminal cover when installing on a wall (KDL-52/40NX803 only).
- Be sure to use the black spacers supplied with the TV when installing on a wall (KDL-52/40NX803 only).

Sufficient expertise is required for installing this product, especially to determine the strength of the wall for withstanding the TV's weight. Be sure to entrust the attachment of this product to the wall to Sony dealers or licensed contractors and pay adequate attention to safety during the installation. Sony is not liable for any damage or injury caused by mishandling or improper installation.

### Precautions

Be sure to install the Wall-Mount Bracket securely to the wall following the instructions in this as well as the manual provided with the Wall-Mount Bracket. The numbers given in the parentheses indicate the installation steps described in the instruction manual provided with Wall-Mount Bracket.

#### 1 Check the parts supplied with the Wall-Mount Bracket (1).

Refer to the instruction manual provided with the Wall-Mount Bracket.

#### 2 Decide on the installation location. (2-1)

Refer to the following “TV installation dimensions table”. Allow for suitable clearance between the TV, the ceiling and protruding parts of the wall as instructed.

#### 3 Install the Base Bracket on the wall. (2-2 through 3)

Decide the positions of the screw on the wall and install the Base Bracket. Refer to the instruction manual provided with the Wall-Mount Bracket for details.

#### 4 Detach the Table-Top Stand from the TV, if necessary. (4-1)

- Remove the bottom cover and terminal cover first before detaching the Table-Top Stand (KDL-52/40NX803 only).

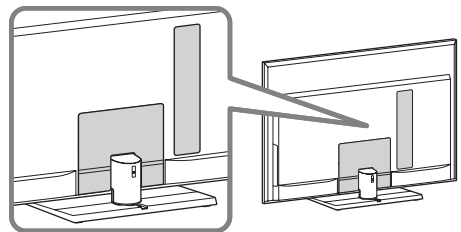

- See “Detaching the Table-Top Stand from the TV” (page 7) for details.

#### 5 Connect the supplied AC power cord (mains lead). (5-1)

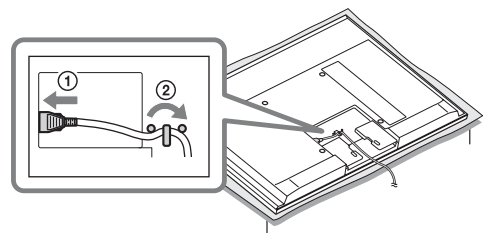

- Do not attach the bottom cover.

**6** Place the spacers (KDL-52/40NX803 only).

- ① Remove the four screws, and be sure to store them in a safe place, keeping them away from children.

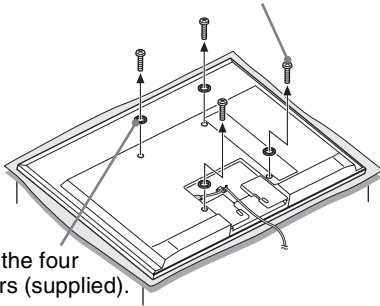

② Place the four spacers (supplied).



- When attaching the Table-Top Stand again, be sure to fasten the four screws (previously removed) to the original holes on the rear of the TV (KDL-52/40NX803 only).

**7** Attach the Mounting Bracket and the Lock Bracket. (4-3 through 4-7)

Refer to the instruction manual provided with the Wall-Mount Bracket.

**8** Prepare the paper template. (5-2)

1. Refer to the following “TV installation dimensions table” and mark the TV outline on the template.

2. Tape the template to the wall as instructed in the manual provided with the Wall-Mount Bracket.

Follow the instruction manual provided with the Wall-Mount Bracket to complete the installation. (5-3 through 6)

## TV installation dimensions table

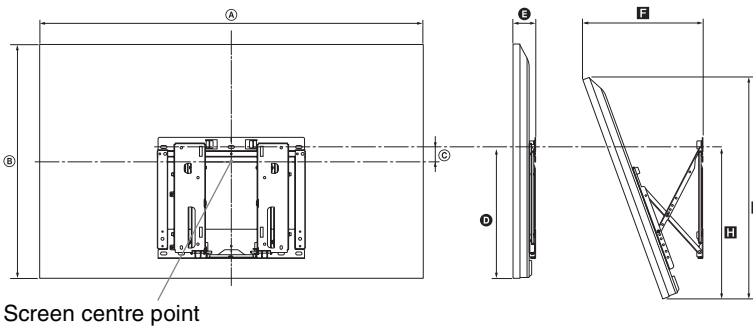

Screen centre point

Unit: cm

Model Name KDL-	Display dimensions		Screen centre dimension	Length for each mounting angle				
				Angle (0°)		Angle (20°)		
	A	B	C	D	E	F	G	H
52NX803	126.1	78.7	1.3	42.1	7.5	38.9	74.5	48.8
46NX703	112.7	71.6	5.2	42.7	7.5	36.2	67.9	49.3
40NX803	99.4	63.5	8.9	42.1	7.5	33.7	60.2	48.8
40NX703	99.4	64.1	8.9	42.7	7.5	33.7	60.8	49.3

Figures in the above table may differ slightly depending on the installation.

### WARNING

The wall that the TV will be installed on should be capable of supporting a weight of at least four times that of the TV. Refer to “Specifications” (page 11) for its weight.

# Safety Information

## Installation/Set-up

Install and use the TV set in accordance with the instructions below in order to avoid any risk of fire, electrical shock or damage and/or injuries.

### Installation

- The TV set should be installed near an easily accessible mains socket.
- Place the TV set on a stable, level surface.
- Only qualified service personnel should carry out wall installations.
- For safety reasons, it is strongly recommended that you use Sony accessories, including:
  - Wall-mount bracket SU-WL700
  - TV stand:
    - SU-52NX1 (KDL-52NX803)
    - SU-46NX1 (KDL-46NX703)
    - SU-40NX1 (KDL-40NX803/40NX703)
- Be sure to use the screws supplied with the Wall-mount bracket when attaching the mounting hooks to the TV set. The supplied screws are designed so that they are 8 mm to 12 mm in length when measured from the attaching surface of the mounting hook. The diameter and length of the screws differ depending on the Wall-mount bracket model. Use of screws other than those supplied may result in internal damage to the TV set or cause it to fall, etc.

8 mm - 12 mm

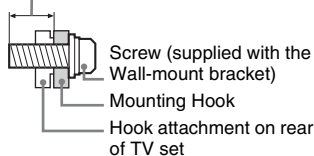

### Transporting

- Before transporting the TV set, disconnect all cables.
- Two or three people are needed to transport a large TV set.
- When transporting the TV set by hand, hold it as shown on the right. Do not put stress on the LCD panel and the frame around the screen.
- When lifting or moving the TV set, hold it firmly from the bottom.
- When transporting the TV set, do not subject it to jolts or excessive vibration.
- When transporting the TV set for repairs or when moving, pack it using the original carton and packing material.

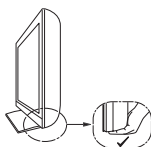

### Ventilation

- Never cover the ventilation holes or insert anything in the cabinet.
- Leave space around the TV set as shown below.
- It is strongly recommended that you use a Sony wall-mount bracket in order to provide adequate air-circulation.

#### Installed on the wall

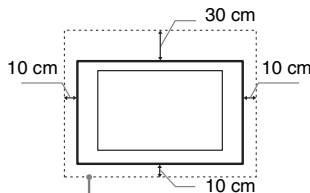

Leave at least this space around the set.

#### Installed with stand

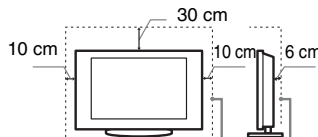

Leave at least this space around the set.

- To ensure proper ventilation and prevent the collection of dirt or dust:
  - Do not lay the TV set flat, install upside down, backwards, or sideways.
  - Do not place the TV set on a shelf, rug, bed or in a closet.
  - Do not cover the TV set with a cloth, such as curtains, or items such as newspapers, etc.
  - Do not install the TV set as shown below.

Air circulation is blocked.

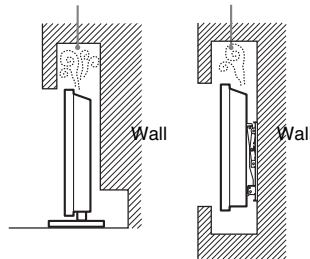

### Mains lead

Handle the mains lead and socket as follows in order to avoid any risk of fire, electrical shock or damage and/or injuries:

- Use only mains leads supplied by Sony, not other suppliers.
- Insert the plug fully into the mains socket.
- Operate the TV set on a 220-240 V AC supply only.
- When wiring cables, be sure to unplug the mains lead for your safety and take care not to catch your feet on the cables.
- Disconnect the mains lead from the mains socket before working on or moving the TV set.
- Keep the mains lead away from heat sources.

- Unplug the mains plug and clean it regularly. If the plug is covered with dust and it picks up moisture, its insulation may deteriorate, which could result in a fire.

### Notes

- Do not use the supplied mains lead on any other equipment.
- Do not pinch, bend, or twist the mains lead excessively. The core conductors may be exposed or broken.
- Do not modify the mains lead.
- Do not put anything heavy on the mains lead.
- Do not pull on the mains lead itself when disconnecting the mains lead.
- Do not connect too many appliances to the same mains socket.
- Do not use a poor fitting mains socket.

### Prohibited Usage

Do not install/use the TV set in locations, environments or situations such as those listed below, or the TV set may malfunction and cause a fire, electrical shock, damage and/or injuries.

#### Location:

Outdoors (in direct sunlight), at the seashore, on a ship or other vessel, inside a vehicle, in medical institutions, unstable locations, near water, rain, moisture or smoke.

#### Environment:

Places that are hot, humid, or excessively dusty; where insects may enter; where it might be exposed to mechanical vibration, near flammable objects (candles, etc). The TV set shall not be exposed to dripping or splashing and no objects filled with liquids, such as vases, shall be placed on the TV.

#### Situation:

Do not use when your hands are wet, with the cabinet removed, or with attachments not recommended by the manufacturer. Disconnect the TV set from mains socket and aerial during lightning storms.

### Broken pieces:

- Do not throw anything at the TV set. The screen glass may break by the impact and cause serious injury.
- If the surface of the TV set cracks, do not touch it until you have unplugged the mains lead. Otherwise electric shock may result.

### When not in use

- If you will not be using the TV set for several days, the TV set should be disconnected from the mains for environmental and safety reasons.
- As the TV set is not disconnected from the mains when the TV set is just turned off, pull the plug from the mains to disconnect the TV set completely.
- However, some TV sets may have features that require the TV set to be left in standby to work correctly.

## For children

- Do not allow children to climb on the TV set.
- Keep small accessories out of the reach of children, so that they are not mistakenly swallowed.

## If the following problems occur...

**Turn off** the TV set and unplug the mains lead immediately if any of the following problems occur.

Ask your dealer or Sony service centre to have it checked by qualified service personnel.

### When:

- Mains lead is damaged.
- Poor fitting of mains socket.
- TV set is damaged by being dropped, hit or having something thrown at it.
- Any liquid or solid object falls through openings in the cabinet.

### Warning

To prevent the spread of fire, keep candles or other open flames away from this product at all time.



## Precautions

### Viewing the TV

- View the TV in moderate light, as viewing the TV in poor light or during long period of time, strains your eyes.
- When using headphones, adjust the volume so as to avoid excessive levels, as hearing damage may result.

### LCD Screen

- Although the LCD screen is made with high-precision technology and 99.99% or more of the pixels are effective, black dots may appear or bright points of light (red, blue, or green) may appear constantly on the LCD screen. This is a structural property of the LCD screen and is not a malfunction.
- Do not push or scratch the front filter, or place objects on top of this TV set. The image may be uneven or the LCD screen may be damaged.
- If this TV set is used in a cold place, a smear may occur in the picture or the picture may become dark. This does not indicate a failure. These phenomena disappear as the temperature rises.
- Ghosting may occur when still pictures are displayed continuously. It may disappear after a few moments.
- The screen and cabinet get warm when this TV set is in use. This is not a malfunction.
- The LCD screen contains a small amount of liquid crystal. Some fluorescent tubes used in this TV set also contain mercury. Follow your local ordinances and regulations for disposal.

## Handling and cleaning the screen surface/cabinet of the TV set

Be sure to unplug the mains lead connected to the TV set from mains socket before cleaning.

To avoid material degradation or screen coating degradation, observe the following precautions.

- To remove dust from the screen surface/cabinet, wipe gently with a soft cloth. If dust is persistent, wipe with a soft cloth slightly moistened with a diluted mild detergent solution.
- Do not spray water or detergent directly on the TV set. It may drip to the bottom of the screen or exterior parts, and may cause a malfunction.
- Never use any type of abrasive pad, alkaline/acid cleaner, scouring powder, or volatile solvent, such as alcohol, benzene, thinner or insecticide. Using such materials or maintaining prolonged contact with rubber or vinyl materials may result in damage to the screen surface and cabinet material.
- Periodic vacuuming of the ventilation openings is recommended to ensure to proper ventilation.
- When adjusting the angle of the TV set, move it slowly so as to prevent the TV set from moving or slipping off from its table stand.

### Optional Equipment

- Keep optional components or any equipment emitting electromagnetic radiation away from the TV set. Otherwise picture distortion and/or noisy sound may occur.
- This equipment has been tested and found to comply with the limits set out in the EMC Directive using a connection signal cable shorter than 3 meters.

### Batteries

- Observe the correct polarity when inserting batteries.
- Do not use different types of batteries together or mix old and new batteries.
- Dispose of batteries in an environmentally friendly way. Certain regions may regulate the disposal of batteries. Please consult your local authority.
- Handle the remote with care. Do not drop or step on it, or spill liquid of any kind onto it.
- Do not place the remote in a location near a heat source, a place subject to direct sunlight, or a damp room.

### Wireless Function of the unit

- Do not operate this unit near medical equipment (pacemaker, etc.), as malfunction of the medical equipment may result.
- Although this unit transmits/receives scrambled signals, be careful of unauthorised interception. We cannot be responsible for any trouble as a result.

### Disposal of the TV set



**Disposal of Old Electrical & Electronic Equipment (Applicable in the European**

## Union and other European countries with separate collection systems)

This symbol on the product or on its packaging indicates that this product shall not be treated as household waste. Instead it shall be handed over to the applicable collection point for the recycling of electrical and electronic equipment. By ensuring this product is disposed of correctly, you will help prevent potential negative consequences for the environment and human health, which could otherwise be caused by inappropriate waste handling of this product. The recycling of materials will help to conserve natural resources. For more detailed information about recycling of this product, please contact your local Civic Office, your household waste disposal service or the shop where you purchased the product.



**Disposal of waste batteries (applicable in the European Union and other European countries with separate collection systems)**

This symbol on the battery or on the packaging indicates that the battery provided with this product shall not be treated as household waste. On certain batteries this symbol might be used in combination with a chemical symbol. The chemical symbols for mercury (Hg) or lead (Pb) are added if the battery contains more than 0.0005% mercury or 0.004% lead. By ensuring these batteries are disposed of correctly, you will help prevent potentially negative consequences for the environment and human health which could otherwise be caused by inappropriate waste handling of the battery. The recycling of the materials will help to conserve natural resources. In case of products that for safety, performance or data integrity reasons require a permanent connection with an incorporated battery, this battery should be replaced by qualified service staff only. To ensure that the battery will be treated properly, hand over the product at end-of-life to the applicable collection point for the recycling of electrical and electronic equipment. For all other batteries, please view the section on how to remove the battery from the product safely. Hand the battery over to the applicable collection point for the recycling of waste batteries. For more detailed information about recycling of this product or battery, please contact your local Civic Office, your household waste disposal service or the shop where you purchased the product.



# Keep this important information about how to re-tune your TV during the digital TV switchover

Keep this Instruction manual safe you'll need it

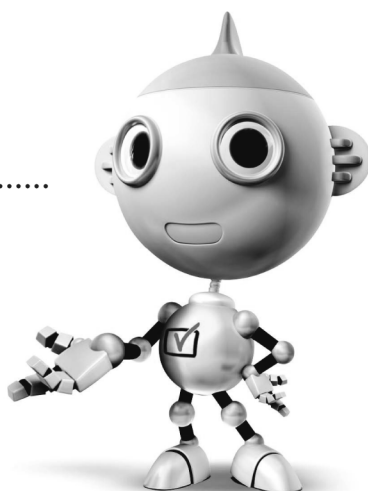

Television in the UK is going digital, bringing us all more.

Please see overleaf to find out when your area switches to digital.

Digital UK is the independent, non-profit organisation leading the process of digital TV switchover in the UK. Digital UK provides impartial information on what people need to do to prepare for the move to digital, and when they need to do it.

## **How the switchover affects your TV equipment:**

Your new TV has a digital tuner built in, which means it is ready to receive the Freeview signal by simply plugging it into your aerial socket (check if you can get digital TV through your aerial now, or whether you'll have to wait until switchover, at [www.digitaluk.co.uk](http://www.digitaluk.co.uk)).

When the TV switchover happens in your area, there are at least two occasions when you will need to re-tune your TV in order to continue receiving your existing TV channels, and also to pick up new ones. Digital UK, the body leading the digital TV switchover, will advise you when you need to re-tune during the switchover.

## How to re-tune:

- 1 Press **"HOME"** on the remote
- 2 Press ⇐/⇒ to select "Settings"
- 3 Press ⇐/⇒ to select "Digital Set-up", then press ⊕
- 4 Press ⊕ to select "Digital Auto Tuning"
- 5 Press ⇐ to select "Yes" then press ⊕ to start "Digital Auto Tuning"
- 6 Follow the on screen instructions.

If you are missing any channels, it may be that they are not available in your area, or that your aerial needs upgrading.

If you have any questions, please contact Sony on **08705 111 999** or call Digital UK on **0845 6 50 50 50** or visit **www.digitaluk.co.uk**

## When does switchover happen?

\*Copeland switches on October 17, 2007

The exact date you switch depends on the transmitter you are served by. To check when you switch, go to Digital UK's postcode checker on [www.digitaluk.co.uk](http://www.digitaluk.co.uk)

Check your ITV news service or look at Teletext page 106 to see what TV region you're in.



Visit us at [digitaluk.co.uk](http://digitaluk.co.uk) call us on **0845 6 50 50 50†**

†Calls charged at BT rate of 3p per minute daytime and 1p per minute evenings and weekends. Rates may vary for calls from non-BT lines.





For useful information about Sony products

<http://www.sony-europe.com/myproduct/>



4180179131

4-180-179-13(1)

<http://www.sony.net/>

© 2010 Sony Corporation