

# *Sony Notebook User Guide*

**PCG-C1VFK/PCG-C1VFLK**

The WAVIO logo is rendered in a blue, stylized font. The 'W' is composed of three rounded, connected shapes. The 'A' is a simple circle with a dot below it. The 'I' is a vertical bar with a pointed top. The 'O' is a thick, rounded circle.

## Read this first

### Notice

© 2001 Sony Corporation. All rights reserved.

This manual and the software described herein, in whole or in part, may not be reproduced, translated, or reduced to any machine-readable form without prior written approval.

Sony Corporation provides no warranty with regard to this manual, the software, or other information contained herein and hereby expressly disclaims any implied warranties or merchantability or fitness for any particular purpose with regard to this manual, the software or such other information. In no event shall Sony Corporation be liable for any incidental, consequential, or special damages, whether based on tort, contract, or otherwise, arising out of or in connection with this manual, the software, or other information contained herein or the use thereof.

Macrovision: This product incorporates copyright protection technology that is protected by method claims of certain U.S. patents and other intellectual property rights owned by Macrovision Corporation and other rights owners. Use of this copyright protection technology must be authorized by Macrovision Corporation, and is intended for home and other limited viewing uses only unless otherwise authorized by Macrovision Corporation. Reverse engineering or disassembly is prohibited.

Sony Corporation reserves the right to make any modification to this manual or the information contained herein at any time without notice. The software described herein is governed by the terms of a separate user license agreement.

Sony, DVgate, i.LINK™ and the i.LINK logo, JogDial™, PictureGear, Memory Stick and the Memory Stick logo, VAIO and the VAIO logo are trademarks of Sony Corporation. i.LINK™ is the name for the IEEE 1394-1995 standards and their revisions.

Microsoft, Windows and the Windows logo, Windows Media and Outlook are trademarks or registered trademarks of U.S. Microsoft Corporation in the U.S. and other countries.

Adobe®, Adobe® Acrobat® Reader, Adobe® Premiere® are trademarks of Adobe Systems Incorporated.

QuickTime and the QuickTime logo are trademarks used under license. QuickTime is registered in the U.S. and other countries.

RealPlayer is a trademark or registered trademark of RealNetworks, inc. in the U.S. and other countries.

PowerPanel is a trademark of U.S. Phoenix Technologies Corporation.

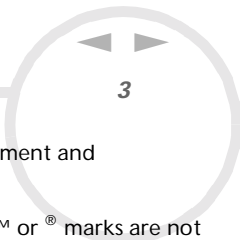

Transmeta, the Transmeta logo, Crusoe, the Crusoe logo, Code Morphing™ Software, LongRun™ Power Management and combinations thereof are trademarks of Transmeta Corporation in the USA and other countries.

All other names of systems, products and services are trademarks of their respective owners. In the manual, the ™ or ® marks are not specified.

Specifications are subject to change without notice.

As an ENERGY STAR Partner, Sony has determined that this product meets the ENERGY STAR guidelines for energy efficiency.

The International ENERGY STAR Office Equipment Program is an international program that promotes energy saving through the use of computers and their office equipment. The program backs the development and dissemination of products with functions that effectively reduce energy consumption. It is an open system in which business proprietors can participate voluntarily. The targeted products are office equipment such as computers, displays, printers, facsimiles and copiers. Their standards and logos are uniform among participating nations.

ENERGY STAR is a U.S. registered mark.



## Safety information

### Owner's record

The model number and serial number are located on the bottom of your Sony notebook. Record the serial number in the space provided here. Refer to the model and serial number when you call VAIO-Link.

Serial number: \_\_\_\_\_

Model number:

**PCG-161M/PCG-163M**

### Warnings

#### General

- Opening the unit, for whatever reason, could lead to damages that are not covered by the guarantee.
- To avoid electrical shock, do not open the cabinet. Refer servicing to qualified personnel only.
- To prevent fire or shock hazard, do not expose your VAIO notebook to rain or moisture.
- Avoid using the modem during a storm.
- Do not use the modem or a telephone to report a gas leak in the vicinity of the leak.

#### Audio/video

- Audio and picture distortion may occur if this equipment is positioned in close proximity to any equipment emitting electromagnetic radiation.

### *Connectivity*

- Never install modem or telephone wiring during a storm.
- Never install telephone jacks in wet locations unless the jack is specifically designed for wet locations.
- Use caution when installing or modifying telephone lines.
- Use your notebook only with the supplied AC adapter. To disconnect your notebook completely from mains voltage, unplug the AC adapter.
- Please make sure that the socket outlet is easily accessible.
- Never touch uninsulated telephone wire or terminals unless the telephone line has been disconnected at the network interface.

### *Hard disk drive*

The magnetic properties of some objects can have serious consequences for your hard disk drive. They can erase the data on the hard drive and cause the computer to malfunction. Do not place your computer near or on any objects which emit magnetic fields, mainly:

- TV sets,
- Speakers,
- Magnets,
- Magnetic bracelets.



## Regulatory information

This product conforms to the following European Directives:

73/23/EEC (Low Voltage Directive)

89/336/EEC, 92/31/EEC (EMC Directives)

93/68/EEC (CE Marking Directive)

1999/5/EC (radio equipment and telecommunications terminal equipment Directive)

This product complies with EN 55022 Class B and EN 55024 for use in following areas: residential, commercial and light-industrial.

This product has been tested and found compliant with the limits set out in the EMC Directive for using connection cables shorter than 3 metres (9.8 feet).



## *Disposing of lithium ion batteries*

Do not handle damaged or leaking lithium ion batteries. Dispose of promptly and properly at end-of-life.

Danger of explosion if the battery is incorrectly replaced. Replace only with the same or equivalent type recommended by the manufacturer. Discard used batteries according to the manufacturer's instructions.

The battery pack used in this device may present a fire or chemical burn hazard if mistreated. Do not disassemble, heat above 60°C (140°C) or incinerate.

Keep away from children.

Your notebook is equipped with an internal backup memory battery. For changing this battery, please contact VAIO-Link:

<http://www.vaio-link.com>

In some areas the disposal of lithium ion batteries in household or business waste may be prohibited.

Use the public collection system.

## Welcome

Congratulations on purchasing a Sony VAIO notebook. Sony has combined leading-edge technology in audio, video, computing and communications to provide you with state-of-the-art personal computing.

Here are just some of the features your VAIO notebook has to offer.

- ❑ **Exceptional performance** - Your PC includes a fast processor.
- ❑ **Portability** - The rechargeable battery pack provides hours of use without AC power.
- ❑ **Sony audio and video quality** - A high-resolution LCD screen enables you to take advantage of today's advanced multimedia applications, games, and entertainment software.
- ❑ **Multimedia features** - Enjoy the speakers to listen to audio and video CDs.
- ❑ **Interconnectivity** - Your computer has Memory Stick™ and i.LINK™ functionalities. Memory Stick is Sony's new universal storage medium. i.LINK is a bidirectional digital interface for exchanging data.
- ❑ **Windows®** - Your system includes the latest operating system from Microsoft.
- ❑ **Communications** - Access popular online services, send and receive e-mails, browse the Internet...
- ❑ **Excellent customer support** - If you are experiencing any problems with your computer, please check the VAIO-Link website for a possible solution:

<http://www.vaio-link.com>

Before contacting VAIO-Link, you may try to solve the problem by reading the User Guide or the manuals and help files for the peripherals or software.



## Documentation pack

### Printed documentation

- ❑ A **Getting Started** brochure, where you find a brief description of the items in your box and some specifications of your notebook. This also offers a quick guide to setting up your computer.
- ❑ A **Customer Guide**, where you find all the basic information to start using your notebook.
- ❑ Your **Sony Guarantee conditions**.
- ❑ A **Safety Regulations Guide** for your information.

### Online documentation

- 1 The Sony Notebook User Guide:
  - ❑ **Using Your Sony Notebook** shows you how to use the standard components of your system.
  - ❑ **Connecting Peripheral Devices** explains how you can add functionality by connecting various peripherals.
  - ❑ **Getting Help** explains the support options available to you, and offers basic troubleshooting tips.
  - ❑ **Precautions** provides facts and advice about using your notebook.
  - ❑ **Specifications** provides details on your computer, drivers and accessories.
- 2 Refer to your **Software Guide** for information on the bundled software and the Sony applications.
  - ❑ **About the Software** is a short description of the features of the software pre-installed on your system.
  - ❑ **Customizing your notebook** explains how to set your system and power management.
  - ❑ **Using the Product Recovery CD-ROMs** explains how to perform a system and application recovery.
- 3 Consult the **Online Help** files of the software you are using for detailed information on features and troubleshooting.

4 Refer to the Microsoft **Quick Start** manual for more information on Windows.

### Your notebook and its accessories

Remove the following hardware items from the box :

1



2

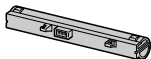

3

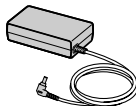

4



5



6



7



8



9



1	main unit	6	documentation pack
2	rechargeable battery pack	7	display adapter
3	AC adapter	8	AV cable
4	power cord	9	pointing stick covers
5	product recovery CD-ROMs		

## Ergonomic considerations

- ❑ You will be using your notebook as a portable device in a variety of environments. Whenever possible, you should attempt to take account of the following ergonomic considerations to both stationary and portable environments:

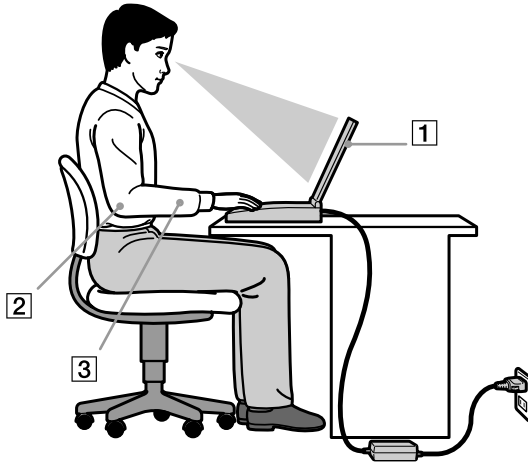

- ❑ **Position of your computer** – Place the computer directly in front of you (1). Keep your forearms horizontal (2), with your wrists in a neutral, comfortable position (3) while using the keyboard, touchpad, or external mouse. Let your upper arms hang naturally at your sides. Have breaks during sessions with your computer. Excessive use of the computer may strain muscles or tendons.
- ❑ **Furniture and posture** – Sit in a chair with good back support. Adjust the level of the chair so your feet are flat on the floor. A footrest may make you more comfortable. Sit in a relaxed, upright posture and avoid slouching forward or leaning far backwards.

- ❑ **Viewing angle of the computer's display** – Use the display's tilting feature to find the best position. You can reduce eye strain and muscle fatigue by adjusting the tilt of the display to the proper position. Adjust the brightness setting of the display as well.
- ❑ **Lighting** – Choose a location where windows and lights do not create glare and reflection on the display. Use indirect lighting to avoid bright spots on the display. You can also purchase accessories for your display that help reduce glare. Proper lighting adds to your comfort and work effectiveness.
- ❑ **Placement of an external display** – When using an external display, set the display at a comfortable viewing distance. Make sure the display screen is at eye level or slightly lower when you are sitting in front of the display.

## Using your notebook

This section describes how to start using your computer and how to use your computer's internal and external devices.

### Locating controls and connectors Right

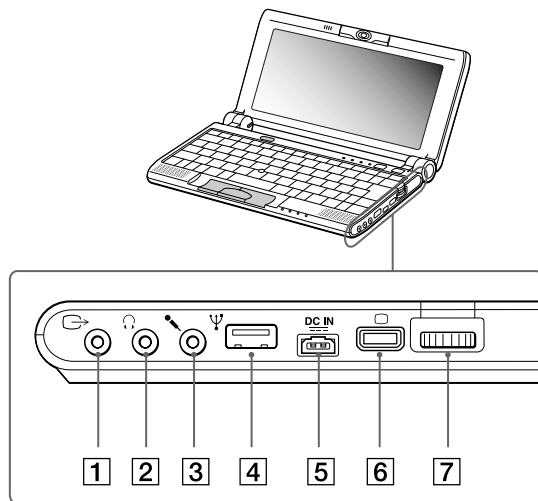

1	AV out connector	<a href="#">(page 49)</a>	5	DC In	<a href="#">(page 17)</a>
2	headphone connector	<a href="#">(page 51)</a>	6	Mini VGA out connector	<a href="#">(page 47)</a>
3	microphone connector	<a href="#">(page 52)</a>	7	Jog Dial	<a href="#">(page 31)</a>
4	USB connector	<a href="#">(page 53)</a>			

 AC adapter mains connector and power cord: hazardous voltage, according to EN 60950.  
All connectors for this notebook are selv (Safety Extra Low Voltage), according to EN 60950.

## Left

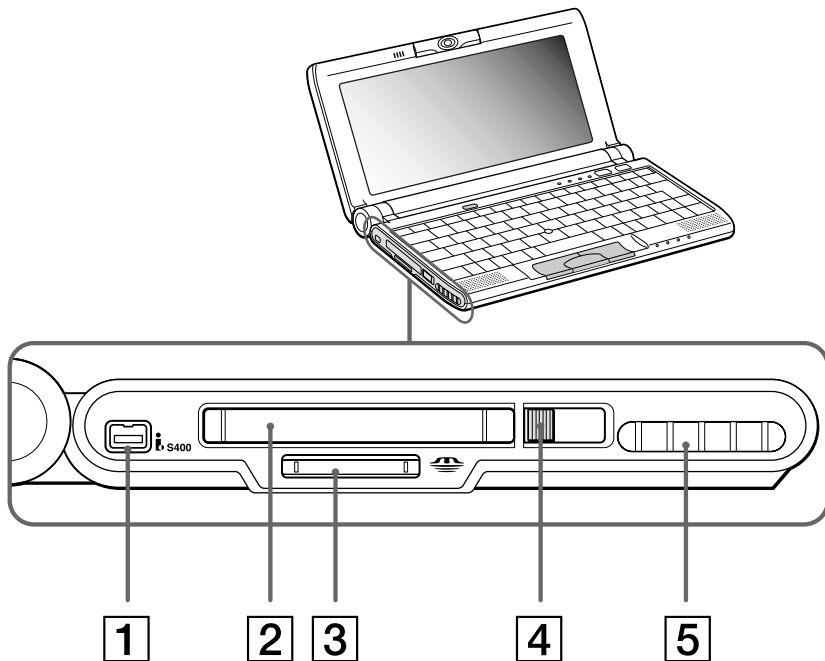

1	S400 i.LINK™ connector	<a href="#">(page 61)</a>	4	RELEASE button	<a href="#">(page 36)</a>
2	PC Card slot	<a href="#">(page 35)</a>	5	ventilation slot	
3	MagicGate Memory Stick™ slot	<a href="#">(page 37)</a>			



There is a ventilation slot located near the PC Card slot. Do not cover the ventilation slot when the notebook is in use.

## Front

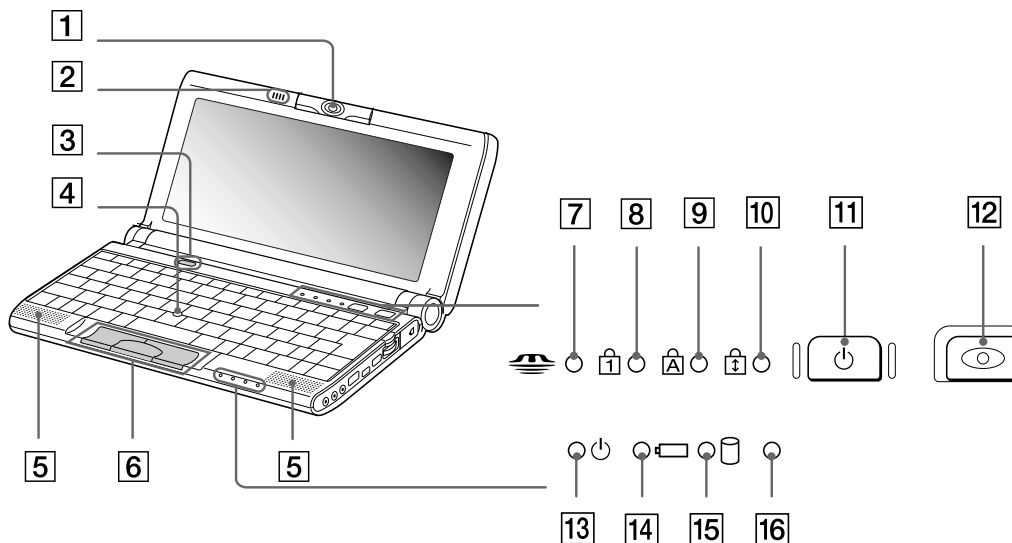

1	built-in camera (Motion Eye)	<a href="#">(page 42)</a>	9	Caps Lock indicator	<a href="#">(page 27)</a>
2	microphone	<a href="#">(page 52)</a>	10	Scroll Lock indicator	<a href="#">(page 27)</a>
3	Bluetooth™ power button*	<a href="#">(page 59)</a>	11	power button	<a href="#">(page 21)</a>
4	pointing device	<a href="#">(page 29)</a>	12	capture button	<a href="#">(page 42)</a>
5	speaker	<a href="#">(page 26)</a>	13	power indicator	<a href="#">(page 27)</a>
6	left/center/right buttons	<a href="#">(page 29)</a>	14	battery indicator	<a href="#">(page 27)</a>
7	MagicGate Memory Stick™ indicator	<a href="#">(page 37)</a>	15	hard disk drive indicator	<a href="#">(page 27)</a>
8	Num Lock indicator	<a href="#">(page 27)</a>	16	Bluetooth™ indicator*	<a href="#">(page 27)</a>

\* The Bluetooth™ availability depends on the model and your country of residence.

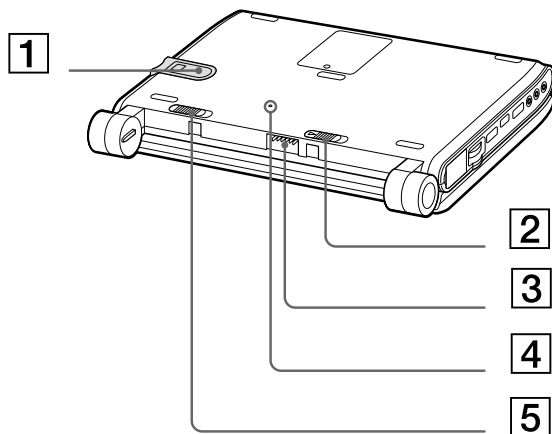
*Bottom*

1	MagicGate Memory Stick™ slot window	<a href="#">(page 37)</a>
2	battery release lever	<a href="#">(page 18)</a>
3	reset switch	
4	battery connector	<a href="#">(page 18)</a>
5	battery lock lever	<a href="#">(page 18)</a>



## Connecting a power source

You can use either an AC adapter or a rechargeable battery pack as a power source.

### Using the AC adapter

To use the AC adapter, proceed as follows:

- 1 Plug the cable attached to the AC adapter (1) into the DC In connector (2) on the computer.
- 2 Plug one end of the power cord (3) into the AC adapter.
- 3 Plug the other end of the power cord into an AC outlet.

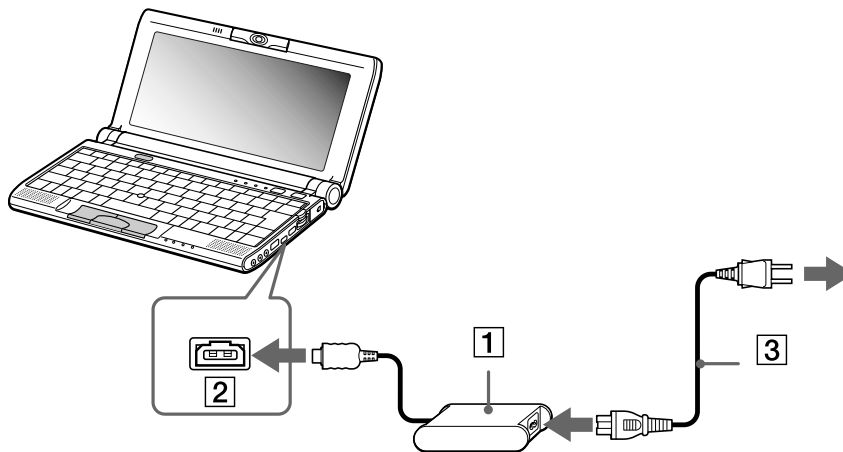

 Use your notebook only with the supplied AC adapter.

To disconnect your notebook completely from mains voltage, unplug the AC adapter.

Make sure that the socket outlet is easily accessible.

## Using the battery pack

You can use a battery pack as a source of power. The battery pack supplied with your computer is not fully charged at the time of purchase.

### Inserting the battery pack

To insert the battery, proceed as follows:

- 1 Move the lock lever (1) on the bottom of the computer to the **Unlock** position.
- 2 Align the grooves (2) and tabs on the battery (3) with the tabs and notches on the back of the computer, and then slide the battery towards the computer until it clicks into place.
- 3 Slide the lock lever into the **Lock** position to secure the battery on the computer.

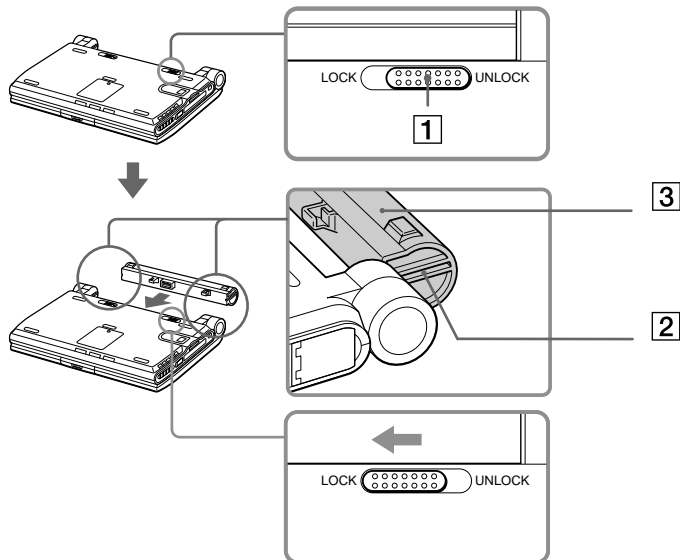

 When the computer is directly connected to AC power and has a battery pack inserted in the battery bay, it uses power from the AC outlet.

**!** Make sure the cover is closed before inserting the battery pack.

### Charging the battery pack

To charge the battery pack, proceed as follows:

- 1 Connect the AC adapter to the computer.
- 2 Insert the battery pack.

The computer automatically charges the battery (1) (the battery indicator (2) light flashes in a double blink pattern as the battery charges). When the battery is 85% full, the battery indicator light turns off. This process takes approximately one and a half hours. To charge the battery completely, continue charging for an additional hour.

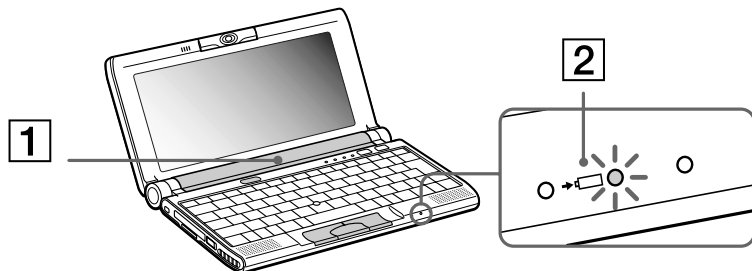

#### *battery indicator light status*      *meaning*

on	The computer is using battery power.
single blink	The battery is running out of power.
double blink	The battery is charging.
off	The computer is using AC power.



When the battery is running out of power, both the battery and power indicators blink.

Keep the battery pack in the computer while it is directly connected to AC power. The battery pack continues to charge while you are using the computer.

If the battery level falls to below 10%, you should either attach the AC adapter to recharge the battery or shut down your computer and insert a fully charged battery.

You can extend battery life by changing the power management modes in the PowerPanel utility.

The battery pack supplied with your computer is a lithium ion battery and can be recharged any time. Charging a partially discharged battery does not affect battery life.

The battery indicator light is on while you use the battery pack as a power source. When the battery life is nearly depleted, the battery indicator starts flashing.

### Removing the battery pack

To remove the battery pack, proceed as follows:

- 1 Turn off the computer.
- 2 Slide the release lever (1) to the **Unlock** position and slide the battery away from the computer.

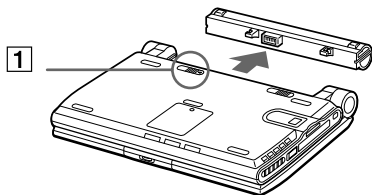

 You may lose data if you remove the battery pack while the computer is on and not connected to the AC adapter or if you remove the battery while the computer is in **Standby** mode.

## Starting your notebook

To start your computer, proceed as follows:

- 1 Hold the bottom of the computer firmly and open the cover.

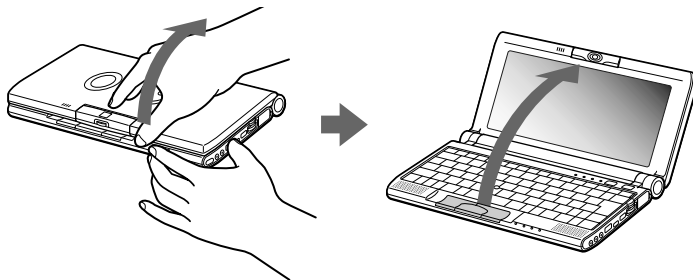

- 2 Press the power button (1) of the computer until the green power indicator light (2) turns on.

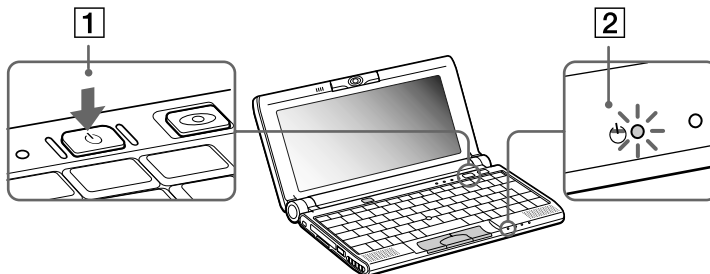

- 3 If necessary, press **<Fn>+<F5>** to adjust the brightness controls for the LCD display. To increase the brightness, use the up or right arrow keys. To decrease, use the down or left arrow keys.

 If you hold the power switch in the on position for more than four seconds, the computer will turn off.

Do not grab the camera lens when opening the cover, you may break the camera.

## Shutting down your notebook

It is important that you shut down your computer properly in order not to lose unsaved data.

To shut down your computer, proceed as follows:

- 1 Click the **Start** button on the Windows<sup>®</sup> taskbar.
- 2 Click **Shut Down**.  
The **Shut Down** dialog box appears.
- 3 Select **Shut down**.
- 4 Click **OK**.
- 5 Wait for your computer to turn off automatically.  
The power indicator turns off.
- 6 Turn off any peripheral connected to your computer.
- 7 To close your computer, make sure that the tabs on both sides of the display panel click into the grabs.

 Respond to any prompts warning you to save documents.

If you are unable to shut down your computer:

- close all software in use,
- remove the PC Cards if inserted,
- disconnect any USB devices,
- Then press the <Ctrl>+<Alt>+<Delete> keys at the same time; the Task Manager appears, allowing you to close open applications and to shut down the computer. If this does not work, you can press the power switch and hold for four seconds. This will shut down the computer. This operation may result in data loss.

Do not close the cover when the built-in camera is turned to the outside.

During a period of inactivity, you can conserve battery life by using **Standby** mode.

## Registering your notebook

You can take advantage of Sony's commitment to quality customer support and receive the following benefits by registering your computer:

- ❑ **VAIO-Link** – If you are experiencing any problems with your computer, you can check the VAIO-Link web site for a possible solution:  
<http://www.vaio-link.com>
- ❑ **Guarantee** – Protect your investment. See the Guarantee sheet for the terms and conditions and refer to your Customer Service Guide for more information.

To register your Sony Notebook, proceed as follows:

- 1 Click on the **Welcome** button on your desktop,
- 2 Click **Next**,
- 3 Click **Internet**,
- 4 Fill in your Registration card fields,
- 5 Scroll down to the bottom of the form and click **Send**,
- 6 Click **OK**.

 You must connect your phone line before using any online services, including the online registration service.

To access the online Registration web page, you must have a connection to the Internet.

## Using the keyboard

Your keyboard is very similar to a desktop computer's, but the keyboard has additional keys that perform specific notebook-related tasks.

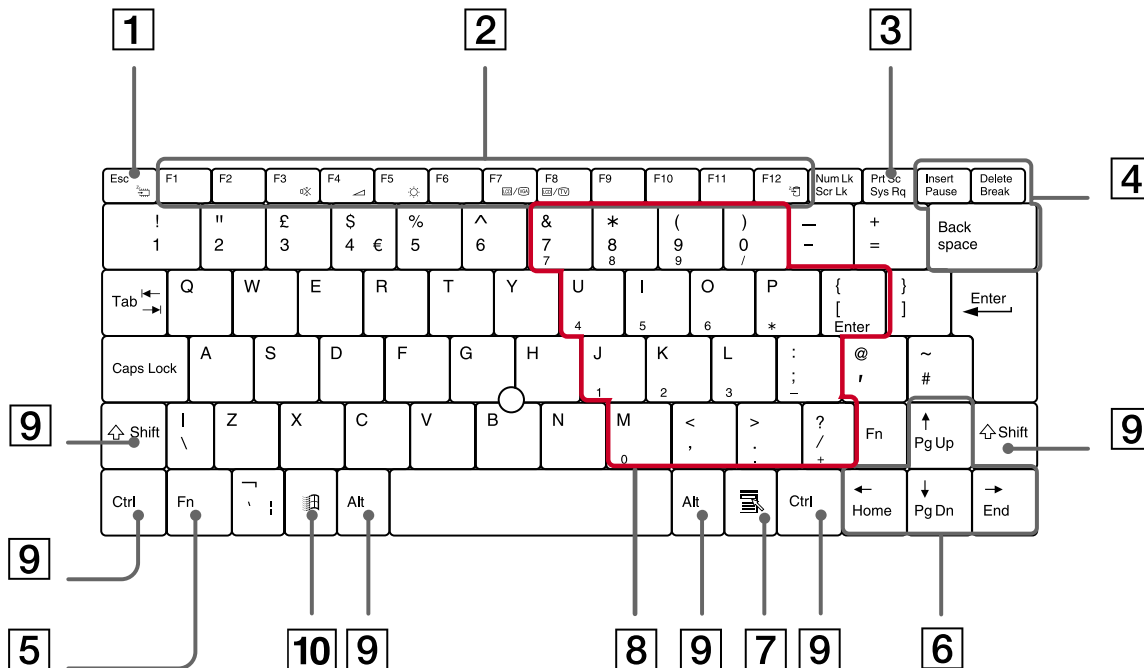



### Keys

### Descriptions

Escape key (1)

The **<Esc>** (Escape) key is used to cancel commands.





<i>Keys</i>	<i>Descriptions</i>
Function keys (2)	The twelve function keys along the top of the keyboard are used to perform designated tasks. For example, in many applications, <b>&lt;F1&gt;</b> is the <b>Help</b> key. The task associated with each function key may vary from one application to the next.
Print Screen key (3)	The <b>&lt;Print Screen&gt;</b> key takes an electronic snapshot of the screen and moves it to the Windows Clipboard. You can then paste the screenshot into a document and print it.
Correction keys (4)	The <b>&lt;Insert&gt;</b> , <b>&lt;Back Space&gt;</b> and <b>&lt;Delete&gt;</b> keys enable you to make corrections.
Fn key (5)	The <b>&lt;Fn&gt;</b> key is used in combination with other keys to execute commands.
Navigation keys (6)	These keys enable you to move the cursor on the screen.
 Application key (7)	The Application key displays a shortcut menu; pressing this key is equivalent to clicking the right mouse button.
Numeric keypad area (8)	Contains the keys found on a typical calculator. Use the numeric keypad area to type numbers or to perform mathematical calculations such as addition and subtraction. Note that you must press the <b>&lt;Num Lock&gt;</b> key to activate the numeric keypad. When you do so, the <b>&lt;Num Lock&gt;</b> indicator illuminates.
Operator keys (9)	Several keys are always used with at least one other key: <b>&lt;Ctrl&gt;</b> , <b>&lt;Alt&gt;</b> , and <b>&lt;Shift&gt;</b> . When held down with another key, the <b>&lt;Ctrl&gt;</b> (Control) and <b>&lt;Alt&gt;</b> (Alternate) keys offer another way to execute commands. For example, in many applications, instead of choosing the <b>Save</b> command from a menu, you can hold down <b>&lt;Ctrl&gt;</b> and press <b>S</b> (referred to as <b>&lt;Ctrl&gt;+&lt;S&gt;</b> ). The <b>&lt;Shift&gt;</b> key is used to produce capital letters or special symbols such as @ and \$.
 Windows <sup>®</sup> key (10)	The key with the <b>Windows<sup>®</sup></b> logo displays the Windows <sup>®</sup> Start menu; it is equivalent to clicking the <b>Start</b> button on the taskbar.





## Combinations and functions with the Windows key

<i>Combinations</i>	<i>Functions</i>
Windows + F1	Displays <b>Windows</b> Help.
Windows + Tab	Switches the selected button on the taskbar.
Windows + E	Displays <b>Windows Explorer</b> .
Windows + F	Displays the <b>Search Results</b> window to find a file or folder. This is equivalent to selecting <b>Search</b> and then <b>For files or Folders</b> from the <b>Start</b> menu.
Windows + Ctrl + F	Displays the <b>Search Results - Computer</b> window where you can locate other computers.
Windows + M	Minimizes all displayed windows.
Shift + Windows + M	Returns all minimized windows to their previous size.
Windows + R	Displays the <b>Run</b> window. This is equivalent to selecting <b>Run</b> from the <b>Start</b> menu.
Windows + Insert	Displays the <b>System Properties</b> window. This is equivalent to double-clicking the <b>System</b> icon in the <b>Control Panel</b> .

















## Indicators

Indicator	Functions
 power	Power on: lights green. <b>Standby</b> mode: flashes amber.
 battery	Indicates the status of the battery inserted in the computer.
 hard disk	Turns on when data is read from or written to the hard drive.
Bluetooth™*	Turns on when the Bluetooth™ function is in use.

\*The Bluetooth™ availability depends on the model and your country of residence.

Light	On	Off
 MagicGate Memory Stick™	Data is read from or written to the Memory Stick. Do not enter <b>Standby</b> mode or turn off the computer when this indicator light is on.	The Memory Stick is not being accessed.
 Num Lock	Turns on when the number keys in the numeric keypad are active.	Turns off when the alphanumeric character keys in the keypad area are active.
 Caps Lock	Turns on when the letters appear in uppercase as you type. The <b>&lt;Shift&gt;</b> key lowers the case of typed letters when <b>Caps Lock</b> is on.	Turns off when the letters appear in lowercase as you type (unless you hold down the <b>&lt;Shift&gt;</b> key).
 Scroll Lock	Turns on when the screen scrolls differently (depends on the application, no effect in many applications.)	Turns off when the information moves across the display normally.

## Combinations and functions with the Fn key

Combinations/ Feature	Functions
Fn +  (ESC) Standby mode	Puts the system into <b>Standby</b> mode, a power management state. To return the system to the active state, press any key.
Fn +  (F3) speaker switch	Toggles the built-in speaker on and off.
Fn +  (F4) speaker volume	Adjusts the built-in speaker volume. To increase volume, press <Fn>+<F4> and then  or  To decrease volume, press <Fn>+<F4> and then  or 
Fn +  (F5) brightness control	Adjusts the brightness of the LCD. To increase light intensity, press <Fn>+<F5> and then  or  To decrease light intensity, press <Fn>+<F5> and then  or 
Fn +  /  (F7) switch to the external display	Toggles between the LCD, external display (connected to the Monitor connector) and both LCD and external display.
Fn +  /  (F8) switch to the external display	Toggles between the LCD and both LCD and TV.
Fn +  (F12) Hibernate mode	Provides for the lowest level of power consumption. When you execute this command, the states of the system and of the peripheral devices are written to the hard disk and the system power is turned off. To return the system to its original state, use the power switch to turn on the power.
<Fn>+<B> : Bass Boost	Toggles the Bass Boost function off and on. This feature is available with headphones only.

 Some functions are not available until Windows is launched.

## Using the pointing device

The stick on the keyboard is a cursor-pointing device. You can point to, select, drag, and scroll objects on the screen using the stick.

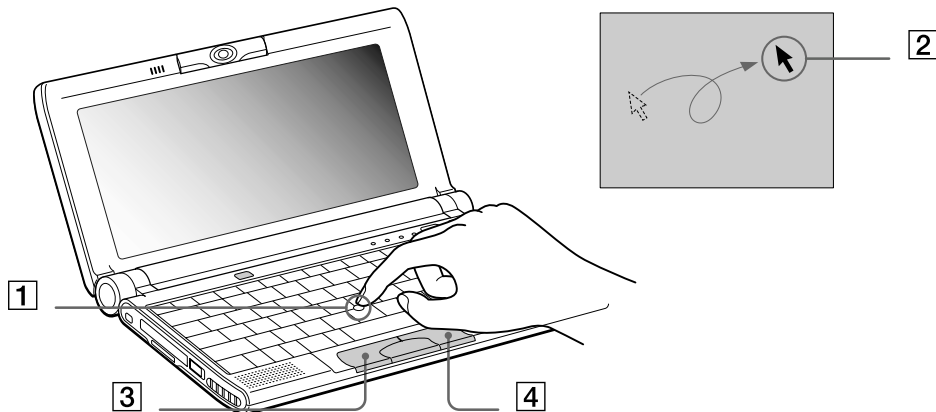

### Action Description

point	Press the stick (1) in the appropriate direction to position the pointer (2) on an item or object.
click	Press the left button (3) once.
double-click	Press the left button twice.
right-click	Press the right button (4) once. In many applications, this action displays a shortcut menu.
drag	Press the stick in the appropriate direction to position the pointer on an item or object. While holding the left button, press the stick, then let it go where needed.
scroll	Press the stick while pressing the center button.



The scroll function is available only with applications that support a scroll-pointing feature.

### *Replacing the pointing stick cover*

You can remove the cover (1) and replace it with an additional stick cover supplied with your computer.

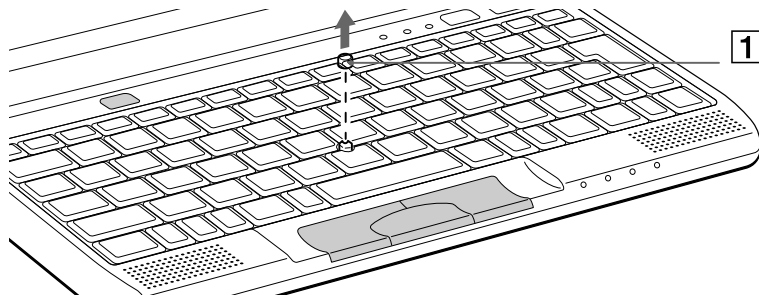

## Using Jog Dial

Your computer is equipped with a **Jog Dial** (1) on the right side of your computer. You can turn (2) and / or press (3) the Jog Dial to scroll the window, select a software, adjust the internal speaker volume, etc.

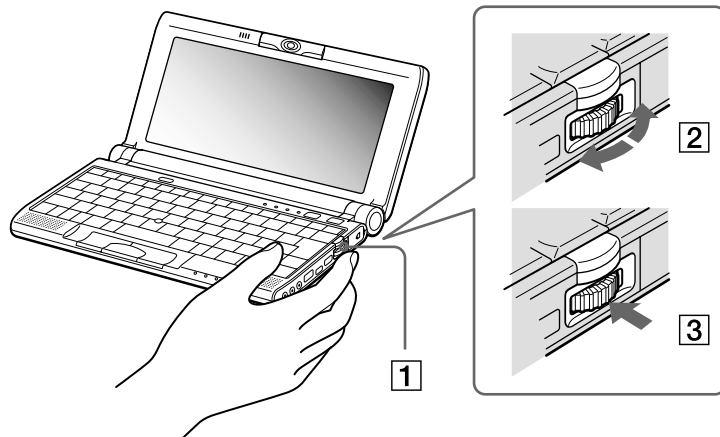

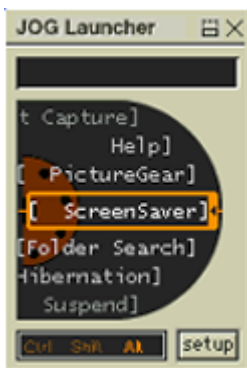

The Jog Dial window is always displayed on the screen. This window has two modes: Launcher mode or Guide mode.



The Jog Dial window is in Launcher mode until you start an application or the Jog Dial window becomes active. When an arrow appears next to an item in the Jog Dial window, you can display a submenu for that item by selecting it and pressing the Jog Dial.



The Jog Dial window switches to Guide mode when you start an application and its window becomes active. Depending on the application, the Jog Dial window displays different commands that you can select or execute by rotating or pressing the Jog Dial.

 You can adjust the size of the Jog Dial window or close it. To display the Jog Dial window, double-click  or  on the taskbar.



To use the Jog Dial in Launcher mode, proceed as follows:

- 1 Click the **Jog Dial** window or press the **Jog Dial** while pressing the <Ctrl> key to switch to Launcher mode.
- 2 Turn the **Jog Dial** to select an item, then press the **Jog Dial**.  
The **Jog Dial** window switches to Guide mode, and shows the **Jog Dial** function.



- 3 Turn or press the Jog Dial to use the Jog Dial function.
- 4 To select another item, switch to Launcher mode and repeat this procedure.

### *Software supporting Jog Dial*

If the Sony software supporting the **Jog Dial** is active, you can use **Jog Dial** functions allocated to each software.

### *Software not supporting Jog Dial*

If the software in use does not support the **Jog Dial**, you can scroll the window or adjust the window size as described below:

<i>Action</i>	<i>Description</i>
Turn the Jog Dial	Scrolls the window vertically. When several windows are displayed, the last selected window will be scrolled.
Press the Jog Dial	Maximizes the size of the active window. Press again to return to its normal size.
Press <b>&lt;Alt&gt;</b> and the Jog Dial	Minimizes the size of the active window. Press both <b>&lt;Alt&gt;</b> and the Jog Dial again to return to its normal size.
Press <b>&lt;Shift&gt;</b> and the Jog Dial	Ends software or programs in use.

## Using PC Cards

Your computer includes a PC Card slot. PC Cards allow you to connect portable external devices.

### Inserting a PC Card

To insert a PC Card, proceed as follows:

- 1 Insert the PC Card into the PC Card slot, front label facing up (1).

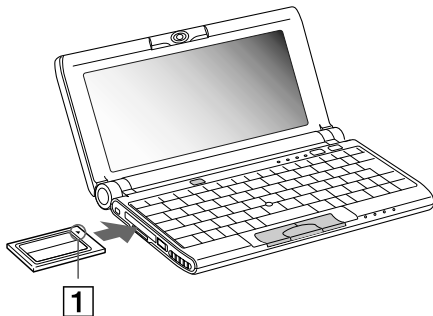

- 2 Gently push the card into the slot until the card is fixed into the connector.

 Some PC Cards may require you to disable idle devices when using the PC Card. You can use **Sony Notebook Setup** to disable devices. Be sure to use the most recent software driver provided by the PC Card manufacturer.

If an "!" mark appears on the **Device Manager** tab in the **System Properties** dialog, remove the software driver and then reinstall it.

You do not need to shut down the computer before inserting or removing a PC Card.

Do not force a card into the slot. It may damage the connector pins. If you have difficulty inserting a card, check that you are inserting the card in the correct direction. See the manual supplied with your PC Card for more information on use.

For some PC Cards, if you alternate between normal power operation and the **Standby** or **Hibernate** power management modes while the card is inserted, you may find that a device connected to your system is not recognized. Reboot your system to correct the problem.

Do not put your notebook in a bag or a case with a PC Card inserted in the slot. Pressure or shock to the PC Card may damage your notebook.

## Removing a PC Card

If you unplug this device from the computer when turned on, your system might crash and you might lose data that you did not save before.

If your computer is turned off, you do not have to follow these instructions.

To remove a PC Card, proceed as follows:

- 1 Double-click  in the taskbar.  
The **Unplug or Eject Hardware** window appears.
- 2 Select the hardware you want to unplug and click **Stop**.  
The **Stop a Hardware device** dialog box appears.
- 3 Confirm the device to stop and click **OK**.  
A **Safe to Remove Hardware** window appears, confirming the device can be safely removed from the system.
- 4 Click **OK**.
- 5 Click **Close** to close the **Unplug or Eject Hardware** dialog box.
- 6 Eject the PC Card release button (1) and then press it to eject the card.
- 7 Gently press the card and pull it out.

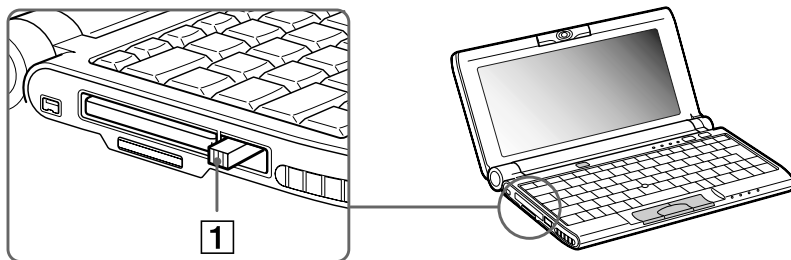

 While the card is inserted, your computer may not enter the **Hibernate** power management mode. It may enter **Standby** mode. It is recommended to remove the card when your computer enters the **Hibernate** mode by pressing <Fn> + <F12> keys or by using the **PowerPanel** utility, and when it is set to enter **Hibernate** automatically while using a battery as the source of power.

You may not be able to use some PC Cards or some functions within the PC Card with this computer.

Close all the applications that use the PC Card before removing the card. Otherwise, data may be lost.

## Using Memory Stick™

This compact, portable, and versatile recording medium has a data capacity exceeding that of a floppy disk. The Memory Stick™ is specially designed for exchanging and sharing digital data with compatible products. Because it is removable, it can be used for external data storage.

 When the Memory Stick™ erasure prevention switch is set to LOCK, data cannot be recorded or erased.

You can enjoy images that you have recorded with a Memory Stick™ compatible video camera recorder or a digital still camera.

Before using Memory Sticks™, you should back up important data.

Only the MagicGate Memory Stick™ can be used with copyright protected data like music.

To avoid damaging data:

- Do not remove a Memory Stick™ or turn off the power while the access light is on.
- Do not use Memory Sticks™ in locations that are subject to static electricity or electrical noise.
- Do not touch the Memory Stick™ connector with your finger or metallic objects.
- Do not attach labels other than the supplied label to a Memory Stick™.
- Do not bend, drop, or apply strong shock to Memory Sticks™.
- Do not disassemble or modify Memory Sticks™.
- Do not allow Memory Sticks™ to get wet.
- Do not use or store Memory Sticks™ in a location that is subject to:
  - Extremely high temperatures, such as in a car parked in the sun
  - Direct sunlight

To prolong the life of Memory Sticks™, use the supplied storage case.

## Types of Memory Stick™ media

Two types of **Memory Stick™** are available. The first type, **MagicGate Memory Stick™** (hereafter referred to as **MG Memory Stick**), is provided with copyright protection. The second type, simply referred to as **Memory Stick™**, does not have the same copyright protection as MagicGate.

You can use both types with your notebook.

For music, which requires copyright protection, you can only use **MG Memory Stick** with your notebook. You can also use MagicGate-compatible devices to record and playback music when they are connected to your computer.

You can store mixed data on the **MG Memory Stick**. For example, you can copy an image on to an **MG Memory Stick** that already contains music.

## What is MagicGate?

MagicGate is copyright protection that consists of authentication and encryption technology. Authentication technology ensures that protected content is only transferred between compliant devices and media. Protected content is recorded and transferred in an encrypted format to prevent unauthorized duplication or playback.



An MG Memory Stick can be recognized from its  mark.

Copyright protected music data cannot be checked out to a Memory Stick™ other than an MG Memory Stick.

The recorded music is limited to private use only. The use of music for any purpose other than the intended use requires the permission of the copyright holders.

Sony is not responsible for music files that are not saved on your computer due to unsuccessful recording from CDs or unsuccessful downloading of music.

## Inserting a Memory Stick™

To insert a Memory Stick™, proceed as follows:

- 1 Gently insert your Memory Stick™ (1), front label facing down, until it clicks into place.

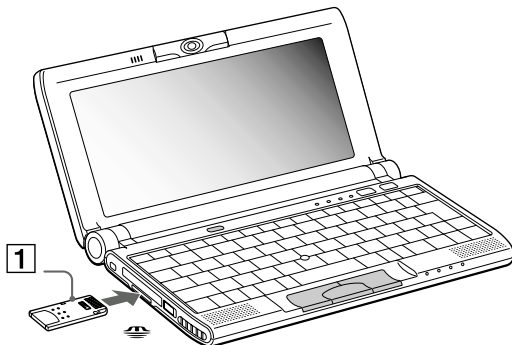

When the Memory Stick™ is connected properly, you can see the contents of the card by clicking the Removable Disk (S:) icon.

If you cannot find the Removable Disk (S:) icon in My Computer on the desktop, proceed as follows:

- 1 Go to **Control Panel**.
- 2 Double-click the **System** icon.
- 3 Click **Hardware**, then **Device Manager**.
- 4 Select the device.
- 5 Click **Action** and then **Scan for hardware changes**.

! Hold the Memory Stick™ with the arrow pointing in the correct direction and turn the label side down when you insert it into the slot. To avoid damaging the computer or the Memory Stick™, do not force the Memory Stick™ into the slot if it does not insert smoothly.

! If your computer is in **Ultimate Battery Life** mode, Memory Stick™ cannot be used. Select another mode.

## Removing a Memory Stick™

To remove a Memory Stick™, proceed as follows:

- 1 Make sure the access light is off and gently press the Memory Stick™ inwards.
- 2 When it comes out, pull it out.  
The **Memory Stick™** window closes automatically when you remove the Memory Stick™.

 Always remove the Memory Stick™ gently, or it may pop out unexpectedly.

It is recommended to remove the Memory Stick™ before shutting down the computer.

- ! To prevent the possible loss of data, do not remove a Memory Stick™ when the Memory Stick™ access light is on. Large image files require more time to store on a Memory Stick™, so always check the Memory Stick™ access indicator and make sure that it is off before you remove the Memory Stick™.

## Write-protecting a Memory Stick™

**Memory Sticks™** are designed with an erasure prevention switch to protect valuable data from accidental erasure or overwriting.

To write-protect a Memory Stick™, proceed as follows:

Move the tab to the right or left to set or release write-protection.

When the erasure prevention switch is off, data can be saved on the Memory Stick™. When the erasure prevention switch is on, data can be read from but not saved on the Memory Stick™.

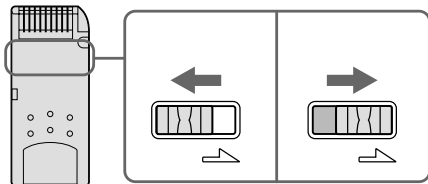



## Formatting a Memory Stick™

Memory Sticks™ are formatted for immediate use when you purchase them. If you need to reformat a Memory Stick, use the **Memory Stick Formatter** software provided with your notebook. For more details about using Memory Stick Formatter, refer to the help files.

To format a Memory Stick™, proceed as follows:

- 1 Insert the Memory Stick™ into the notebook.
  - 2 Click the **Start** button, point to **Programs**, click **Memory Stick Utility** and then click **Memory Stick Formatter**.
  - 3 Click **Start Formatter**.  
**Memory Stick Formatter** starts.
- ! If you format a Memory Stick™ that already contains data, all the data (including music data) will be erased. Confirm that the Memory Stick™ does not contain files that you want to keep.

## Using the MOTION EYE built-in camera

Your computer includes a built-in MOTION EYE camera. You can use the camera to shoot still images and record video clips.

### Capturing still images

To capture a still image, proceed as follows:

- 1 Press the **Capture** button (1).  
The **Smart Capture** application starts.

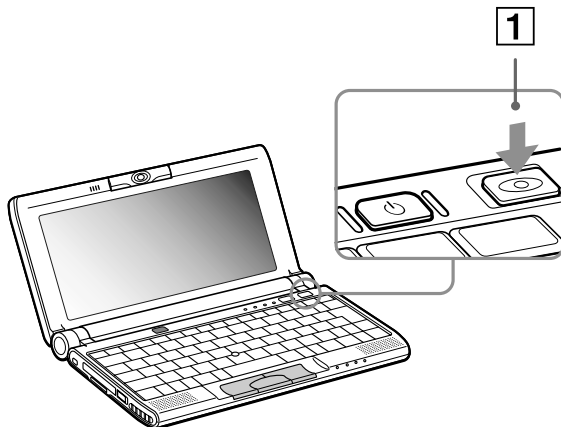

- 2 Select **Still Viewer/Movie Player** from the application list.
- 3 Select **STILL** with the **Capture mode** button.  
The **Finder** window appears.

- 4 Turn the **Motion Eye** lens towards the subject.

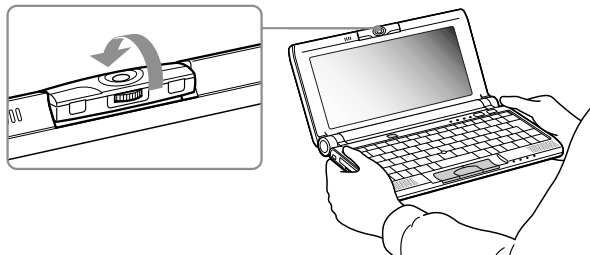

- 5 Adjust the focus ring.

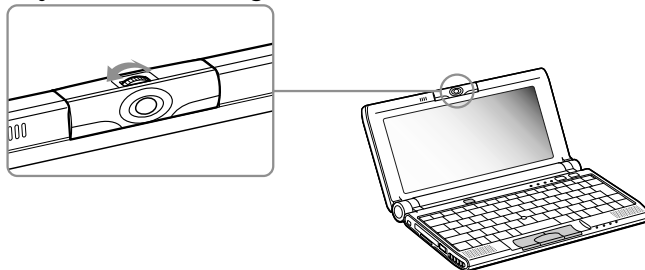

- 6 Click the **Capture** button on the computer.  
The **Still Viewer** window appears and displays the captured image.



Do not touch the camera lens.

Do not point the camera towards the sun.

If you turn the lens inwards, **Smart Capture** goes into mirror mode. You can use the mirror mode to take a still image of yourself. A mirror image appears in the finder window of the display while shooting. However, after capturing, a normal image appears.

You can capture the following still images sizes: 640 x 480, 320 x 240, 160 x 120 and 80 x 60.

You cannot detach the camera.

**Smart Capture** is not available while another software that uses the built-in camera is in use. Close this software before using **Smart Capture**.

You cannot transfer still images or video clips from the built-in camera while you are transferring files using i.LINK™ devices via the i.LINK™ cable.

## Using power saving modes

When you use a battery as the source of power for your computer, you can take advantage of power management settings to conserve battery life. In addition to the normal operating mode, which allows you to turn off specific devices, your computer has two distinct power saving modes: **Standby** mode and **Hibernate** mode.

When using battery power, you should be aware that the computer automatically enters **Hibernate** mode when the remaining battery charge drops below 7 percent, regardless of the power management setting you select.



If the battery level falls to below 10 percent, you should either attach the AC adapter to recharge the battery or shut down your computer and insert a fully charged battery.

## Using Normal mode

This is the normal state of your computer when it is in use. The green power indicator light is on in this mode. To save power, you can turn off a specific device such as the LCD or the hard disk.

## Using Standby mode

The computer saves the current state of the system in RAM and switches off power to the CPU. The amber power light flashes in this mode.

To activate **Standby** mode, proceed as follows:

Use the PowerPanel utility.

To return to **Normal** mode, proceed as follows:

Press any key.

## Using Hibernate mode

The state of the system is saved on the hard disk and power is turned off. The power indicator light is off in this mode.

To activate **Hibernate** mode, proceed as follows:

Press **<Fn>+<F12>**.

Or,

Use the **PowerPanel** utility.

To return to **Normal** mode, proceed as follows:

Turn on the computer by pressing the power button.

The computer returns to its previous state.

 When the computer is in **Hibernate** mode, you cannot insert a disk.

**Hibernate** mode requires more time than **Standby** mode to be activated.

It takes more time to return to **Normal** mode from **Hibernate** mode than from **Standby** mode.

**Hibernate** mode uses less power than **Standby** mode.

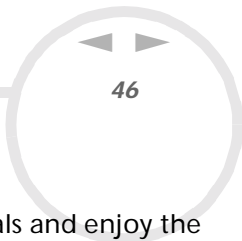

## Connecting peripheral devices

You can add functionality to your computer by connecting or using any of these peripherals and enjoy the software described in the About the software on your Sony Notebook user guide:

Connecting an external display ([page 47](#))

Connecting external speakers ([page 51](#))

Connecting an external microphone ([page 52](#))

Connecting a Universal Serial Bus (USB) device ([page 53](#))

Using a CD-ROM drive ([page 57](#))

Connecting a printer ([page 58](#))

Connecting a Bluetooth™ device to your notebook\* ([page 59](#))

Connecting an i.LINK™ device ([page 61](#))

\* The Bluetooth™ availability depends on the model and your country of residence.

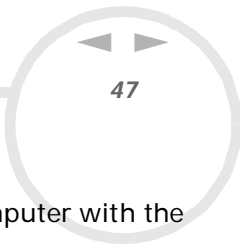

## *Connecting an external display*

You can connect an external display to your notebook. For example, you can use your computer with the following devices:

- Computer display;
- TV;
- Projector.

## Connecting a computer display

To connect a computer display, proceed as follows:

- 1 Plug the supplied display adapter (1) into the notebook's mini VGA Out connector and the display cable to the VGA Out connector of the display adapter.
- 2 If necessary, plug one end of the display power cord (2) into the display, and the other end (3) into an AC outlet.

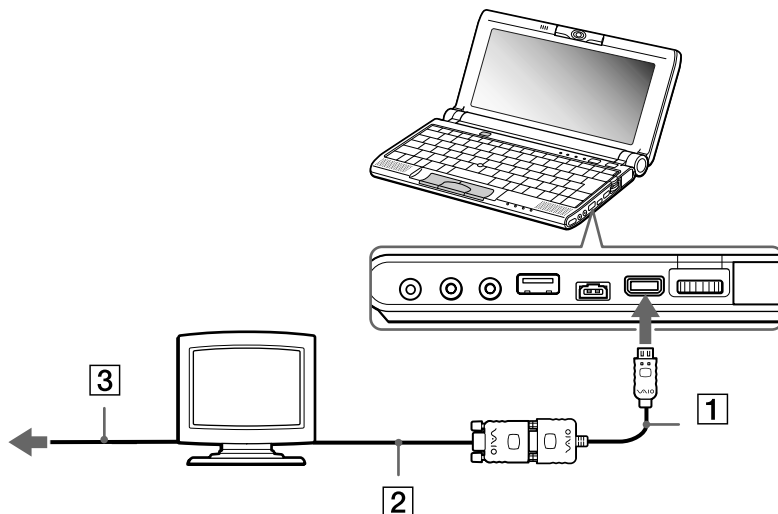

-  Before you connect peripherals, turn off the computer and all peripherals.  
Connect the power cord only after connecting all cables.  
Turn on the computer only after turning on all peripherals.



## Connecting a TV

To connect a TV to your notebook, proceed as follows:

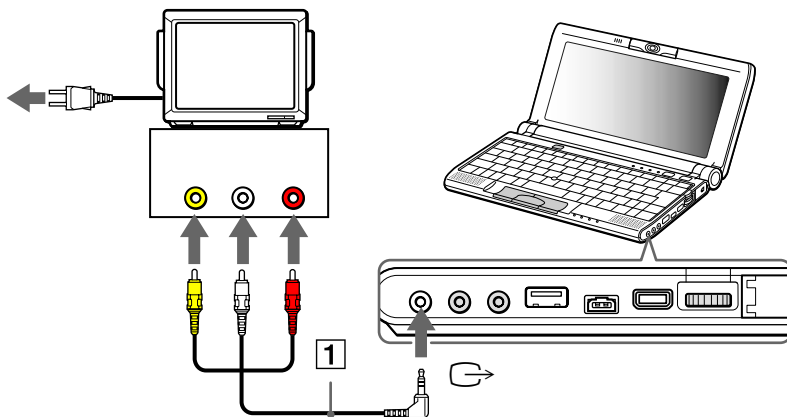

- 1 Plug the supplied AV cable (1) into the computer's AV out connector (yellow).
- 2 Plug the three-pin jack of the AV cable to the TV as shown below.



 640x480 dots of your computer screen will be displayed on TV. The rest can be seen by scrolling.

## Connecting a projector

To connect a projector, proceed as follows:

- 1 Plug the display adapter (1) into the computer's mini VGA Out connector and the display signal cable (2) to the VGA Out connector of the display adapter.
- 2 Plug the speaker audio cable (3) into the earphone connector identified by the  symbol.
- 3 Plug the microphone cable into the microphone connector identified by the  symbol.

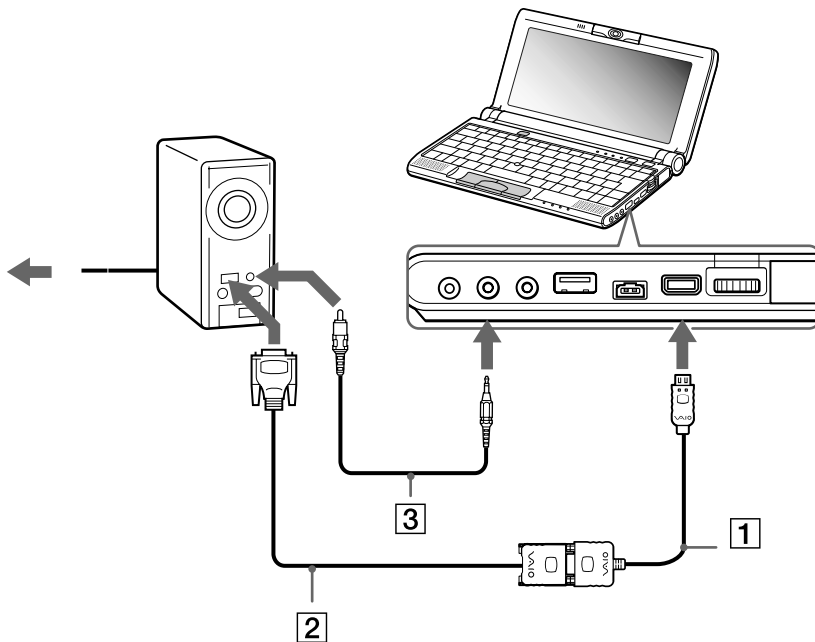

## Connecting external speakers

You can enhance the sound quality of your computer by connecting external speakers.

To connect external speakers, proceed as follows:

- 1 Plug the speaker cable (1) into the earphone connector (2).
- 2 Plug the other end of the speaker cable into the external speaker.
- 3 Turn down the volume of the speakers before you turn them on.

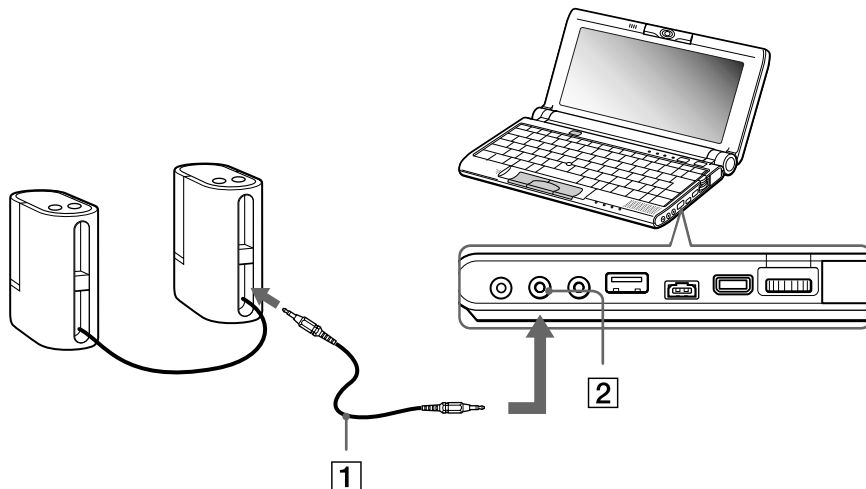

 Make sure your speakers are designed for computer use.

Do not place diskettes on the speakers; their magnetic field may damage the data on the diskettes.

## Connecting an external microphone

Your VAIO notebook contains an internal microphone. If you need to use a sound input device, for example to chat on the Internet, you can also plug in an external microphone.

To connect an external microphone, proceed as follows:

Plug the microphone cable (1) into the microphone connector (2) identified by the  symbol. .

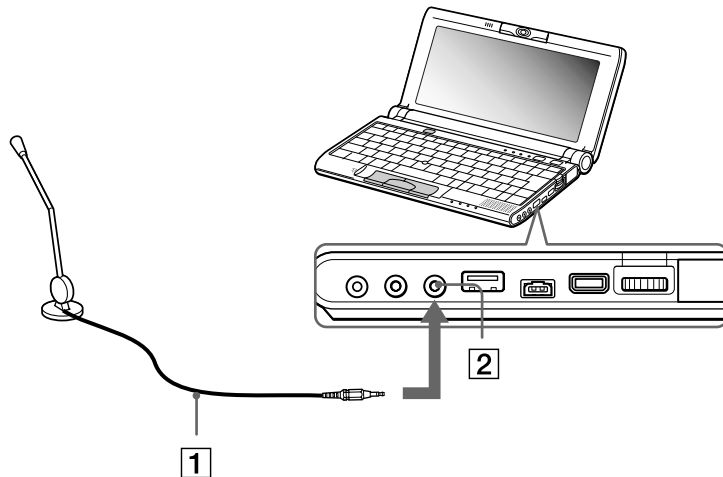

 Make sure your microphone is designed for computer use.

## Connecting a Universal Serial Bus (USB) device

You can connect a USB device (e.g. mouse, floppy disk drive...) to your computer. You do not need to shut down the computer before connecting or disconnecting a USB peripheral. When you start your notebook with a USB hub connected to it, make sure that a device is connected to the USB hub. If you encounter problems booting when a USB hub is connected to your notebook, unplug the hub and reboot.

### Connecting a USB mouse

To connect a USB mouse, proceed as follows:

Plug the USB cable (1) into the USB connector (2) identified by the  symbol.

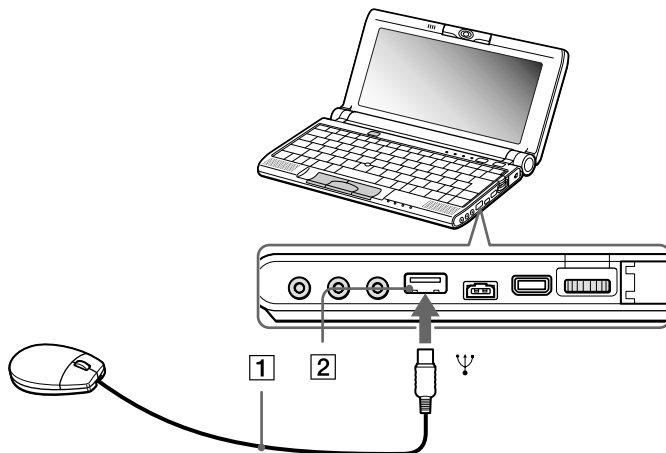

 You can connect the optional Sony USB mouse (PCGA-UMS1 series). As the driver for this mouse is preinstalled on your computer, you can use the mouse by just connecting it.

Your computer does not include any Serial or PS/2 connectors.

## Using a USB floppy disk drive

You can connect a floppy disk drive to the USB connector on your computer.

### Connecting the floppy disk drive

To connect the floppy disk drive, proceed as follows:

Plug the floppy disk drive cable (1) into the USB connector (2) identified by the  symbol. The VAIO logo on the disk drive should be facing up.

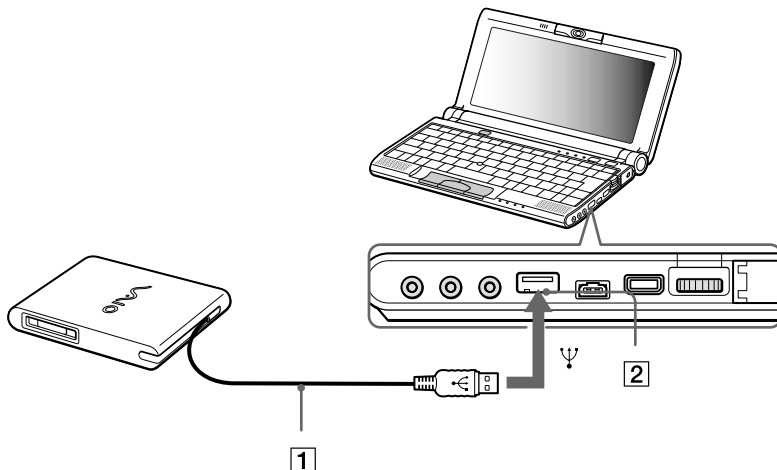

### Inserting a diskette

To insert a diskette, proceed as follows:

- 1 Hold the diskette (2) with the label side facing up.
- 2 Gently push the diskette into the drive (1) until it clicks into place.

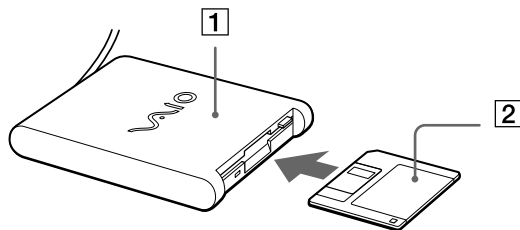

### Removing a diskette

To remove a diskette, proceed as follows:

When you finish using the diskette, wait until the LED indicator (2) turns off and then press the Eject button (1) to remove the diskette.

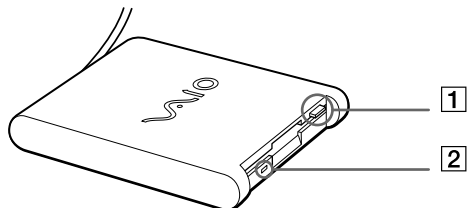

 Before pressing the Eject button, make sure that the LED indicator is turned off.

If the diskette does not come out by pressing the Eject button, disconnect the floppy disk drive from the computer.

**!** Do not press the Eject button while the LED indicator is on. It may damage the diskette.

### *Removing the floppy disk drive*

To remove the floppy disk drive, proceed as follows:

- ❑ If your computer is on, wait until the LED indicator turns off and then unplug the USB cable from the computer. If the floppy disk drive is not removed properly, your system may crash and you may lose data that you did not save before.
- ❑ If your computer is off, you can directly unplug the USB cable from the computer.
-  To carry your floppy disk drive when you have finished using it, fold the floppy disk cable into the compartment on the side of the floppy disk drive.



## Using a CD-ROM drive

You can connect a CD-ROM drive to your notebook to read CD-ROMs, Audio-CDs and CD Extras.

### Connecting the CD-ROM drive

To connect the CD-ROM drive, proceed as follows:

- 1 Insert the CD-ROM card into the PC Card slot with the SONY logo facing up.
- 2 If this is not the case, try to reinsert the CD-ROM card.

 You cannot insert a disk when the computer is in **Standby** or **Hibernate** mode.

### Removing the CD-ROM drive

If you unplug the CD-ROM drive from the computer when turned on, your system might crash and you might lose data that you did not save before. If your computer is turned off, you do not have to follow these instructions.

To remove the CD-ROM drive, proceed as follows:

- 1 Double-click  in the taskbar.  
The **Unplug or Eject Hardware** window appears.
- 2 Select the hardware you want to unplug and click **Stop**.  
The **Stop a Hardware device** dialog box appears.
- 3 Confirm the device to stop and click **OK**.  
The **Safe to Remove Hardware** window appears, confirming the device can be safely removed from the system.
- 4 Click **OK**.
- 5 Click **Close** to close the **Unplug or Eject Hardware** dialog box.
- 6 Remove the device safely.

## Connecting a printer

You can connect a Windows-compatible printer to your computer to print documents.

### Connecting a printer using the USB connector

You can connect a USB printer compatible with your version of Windows to your computer.

To connect a printer using the USB connector, proceed as follows:

Plug an optional USB printer cable (1) into the USB connector (2) identified by the  symbol on your computer and printer.

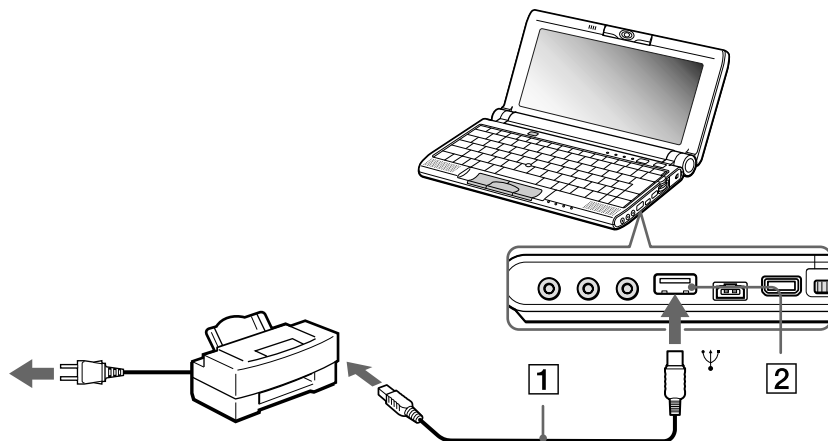



-  Before using the printer, you may need to change the Printer settings in the **Sony Notebook Setup** software. Turn off your computer and the printer, unplug the AC adapter and the power cord before connecting the printer.

## Connecting a Bluetooth™ device to your notebook\*

The Bluetooth™ wireless technology\* enables you to establish a wireless communication between your notebook and other Bluetooth™ devices such as a notebook, a mobile phone or a modem station without any cable within a 10 to 100 metres range in open space.

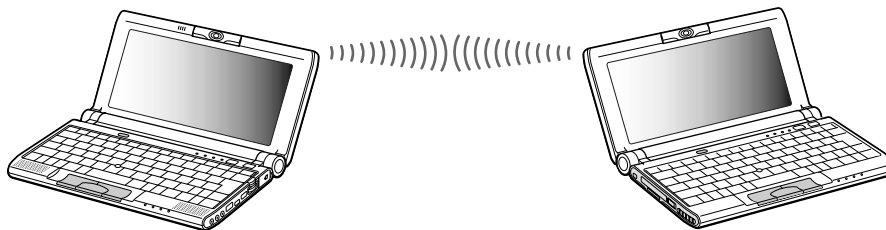
All Bluetooth™ communications are made in conjunction with the **BlueSpace** software.



 The 2.4 GHz band which Bluetooth™ devices or wireless LAN devices use is used by various devices. Bluetooth™ devices use the technology to minimize the interference from other devices that use the same wavelength. However communication speed and distances can be inferior. Interference from other devices may also stop communications.

! The Bluetooth™ functions may not work depending on the devices or the software version used.

! When you purchase Bluetooth™ devices, check their operating conditions.

\* The Bluetooth™ availability depends on the model and your country of residence.

### *Bluetooth™ security\**

The Bluetooth™ wireless technology has an authentication function which allows you to make sure with whom you communicate. With the authentication function, you can avoid any anonymous Bluetooth™ device to access your notebook.

The first time two Bluetooth™ devices communicate, a common Passkey should be determined for both devices to be registered. Once a device is registered, there is no need to reenter the Passkey.

You can change your settings in order not to be discovered by other Bluetooth™ devices or you can set a limit. For more information, see the **BlueSpace** online help.

\* The Bluetooth™ availability depends on the model and your country of residence.

## Connecting an i.LINK™ device

Your computer includes an i.LINK™ (IEEE1394) connector, which you can use to connect to an i.LINK™ device such as a digital video camera recorder or to connect two VAIO notebooks in order to copy, delete or edit files.

The i.LINK™ connector of your notebook does not supply power to external devices generally powered by i.LINK™ connectors.

The i.LINK™ connector supports transfer rates up to 400 Mbps; however, the actual transfer rate depends on the transfer rate of the external device.

i.LINK™ cables compatible with your VAIO notebook include cables with the following part numbers: VMC-IL4415A (a 1.5 meter cable with a 4-pin connector at each end), VMC-IL4408Series (a 0.8 meter cable with a 4-pin connector at each end).

 An i.LINK™ connection with other compatible devices is not fully guaranteed.

The i.LINK™ connection varies depending on the software applications, operating system and i.LINK™-compatible devices you use. Refer to the documentation that came with your software for more information.

Check the working conditions and OS compatibility of i.LINK™-compatible PC peripherals (HDD, CD-RW drive etc.) before you connect them to your notebook.

## Connecting a digital video camera recorder

To connect a digital video camera recorder, proceed as follows:

- 1 Plug one end of the i.LINK™ cable (1) into the i.LINK™ connector (2) of the computer and the other end into the DV Out connector (3) on the digital video camera recorder.

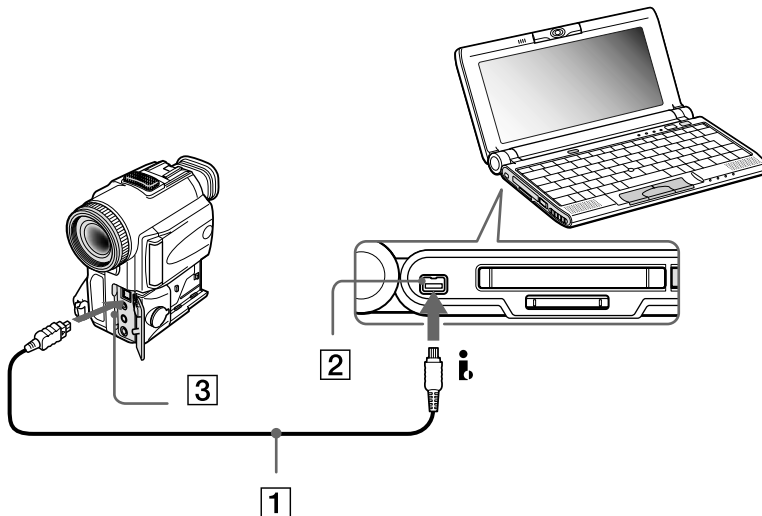

- 2 Launch the DVgate application.

 On Sony digital video cameras, connectors labeled **DV Out**, **DV In/Out** or **i.LINK™** are i.LINK™-compatible.

The Sony digital video camera recorder is an example; your digital video camera recorder may need to be connected differently.

If your digital video camera recorder includes a Memory Stick™ slot, you can copy images from it to your computer via a Memory Stick™. To do so, simply copy images on the Memory Stick™, then insert it into the Memory Stick™ slot of your computer.

### Connecting two VAIO notebooks

With **Smart Connect** you can copy, edit or delete files on another VAIO computer (equipped with **Smart Connect**) connected to your computer with an i.LINK™ cable (1) (not supplied).

You can also print a document on a printer connected to another VAIO computer.

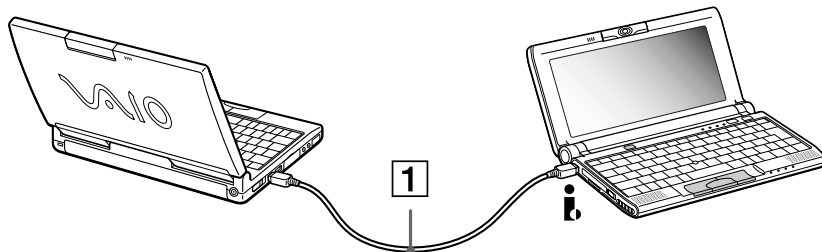

- When you use **Smart Connect** to connect two VAIO computers, you must assign each computer a unique name by which it can be identified when the two computers are networked.

## Getting help

This section describes how to get help and support from Sony, as well as troubleshooting tips for your computer.

### *Sony support options*

Sony provides several support options for your computer.

#### *Printed documentation supplied with your notebook*

- ❑ The **Customer Guide** explains how to start your computer and use the basic functions. This guide gives you the information to access VAIO-Link.
- ❑ The **Getting Started** gives you a list of the items you find in the box and a summary of the bundled applications.

#### *Online user guides on your computer's hard drive*

- ❑ The **Hardware guide** explains how to use your computer, connect peripheral devices. It gives you a packing list and the list of specifications of your computer and accessories.
- ❑ The **Software guide** lists the pre-installed software titles and explains how to use the utility programs and perform basic computer tasks.
- ❑ The **Customer Service Guide** gives you complete information on the VAIO-Link Services.

#### *Other sources of information*

- ❑ The **online help files** that accompany your pre-installed software contain instructions on using the software.



- ❑ **VAIO-Link website:** if you have any problem with your computer, you can access the VAIO-Link web site. Go to:  
<http://www.vaio-link.com>
- ❑ **VAIO-Link Response Centre:** Before contacting VAIO-Link Response Centre, try to solve the problem by reading the User Guides and help files for the peripherals or software.

 You need to plug in the phone line and configure your modem for use before using the communication features described in this manual.

## Troubleshooting

This section describes how to solve common problems you might encounter when using your notebook. Many problems have simple solutions. Please, try these suggestions before contacting VAIO-Link.

About the computer and software ([page 66](#))

About Bluetooth™\* ([page 69](#))

About the display ([page 71](#))

About CD-ROMs and diskettes ([page 72](#))

About the MOTION EYE camera ([page 73](#))

About sound ([page 74](#))

About peripherals ([page 75](#))

About digital video captures and DVgate ([page 76](#))

\* The Bluetooth™ availability depends on the model and your country of residence.

## About the computer and software

### *My computer does not start*

- ❑ Check that the computer is plugged into a power source and that it is turned on.
- ❑ Check that the power indicator on the front panel of the computer indicates that the power is on.
- ❑ Check that the battery packs are inserted properly and that they are charged.
- ❑ Make sure there is no diskette in the floppy disk drive.
- ❑ Confirm that the power cord and all cables are connected firmly.
- ❑ If you have plugged the computer into a UPS, make sure the UPS is turned on and works.
- ❑ If you are using an external display, check that it is plugged into a power source and turned on. Check that you have switched to the external display and that the brightness and contrast controls are adjusted correctly.
- ❑ Moisture condensation may have occurred. Do not use the computer for at least one hour and then turn it on.
- ❑ When the internal backup battery is low on power, it may not be able to start your system properly.

### *The message Press <F1> to resume, <F2> to setup appears at startup*

If the floppy disk drive is empty, proceed as follows to initialize the BIOS:

- 1 Turn off the computer.
- 2 Remove any peripheral devices connected to the computer.
- 3 Turn on the computer and press **<F2>** when the Sony logo appears. The BIOS setup menu screen appears.
- 4 Press the arrow keys to select the **Exit** menu.

- 5 Press the arrow keys to select **Get Default Values** and then press **<Enter>**. The message **Load default configuration now?** appears.
- 6 Make sure that **[Yes]** is selected and then press **<Enter>**.
- 7 Press the arrow keys to select **Exit** (save changes) and then press **<Enter>**. The message **Save configuration changes and exit now?** appears.
- 8 Make sure that **[Yes]** is selected and then press **<Enter>**.
- 9 Restart the computer by pressing **<Ctrl> + <Alt> + <Delete>** and by choosing **Shut Down**.

### *My computer does not shut down*

It is recommended to shut down your computer using the **Shut Down** command on the Windows® **Start** menu. Using other methods, including those listed here, may result in loss of unsaved data. If the **Shut Down** command does not work properly, proceed as follows:

- Restart the computer by pressing **<Ctrl> + <Alt> + <Delete>** and by choosing **Shut Down**.
- If this does not work, press the power switch and hold it for at least four seconds, this turns off the power.
- Unplug the computer from the AC adapter and remove the battery pack from your computer.

### *My computer locks up*

- If you suspect one application is locking your system, you can try to stop it. To do this, press **<Ctrl>+<Alt>+<Delete>** once, click **Task Manager**, select the application or the process that is locking your system, and then click **End Task**.
- If the above method does not work or you do not know which application is locking your system, restart the computer. On the Windows® taskbar, click the **Start** button, click **Shut Down**, and then select **Shut Down** in the list and click **OK**.
- If the above method does not work, press the power switch and hold it for at least four seconds. This turns off the power.

- ❑ If your computer locks up while playing a CD-ROM, stop the CD-ROM, and shut down the computer by pressing <Ctrl>+<Alt>+<Delete>, and then click **Shut Down**.

#### *My software program locks up or crashes*

Contact the software publisher or designated provider for technical support.

#### *The pointer in the display moves on its own*

A « drift » has occurred. However, this is not a malfunction. The pointer will stabilize if you do not touch the stick for a few seconds.

#### *My mouse does not work*

- ❑ Check that the mouse is plugged into the USB connector.
- ❑ If you are using an optional Sony USB mouse, check that the appropriate driver and mouseware are properly installed.

#### *The key top comes off*

Put it back where it was and press it until it clicks.

If you take off the key top intentionally or press it excessively when you replace it, it may cause a malfunction. Handle it with care.

## About Bluetooth™ \*

\* The Bluetooth™ availability depends on the model and your country of residence.

### *I cannot use the Bluetooth™ function*

- ❑ If the Bluetooth™ LED is off, press the Bluetooth™ power button for two seconds to turn the LED on.
- ❑ You cannot use the Bluetooth™ function when the computer is in a power saving mode. Return to normal mode and then press the Bluetooth™ power button.
- ❑ You may not be able to use the Bluetooth™ function if you choose the **minimum CPU performance feature** in **PowerPanel**. Select another mode. See the **PowerPanel** online help for more details.
- ❑ You may not be able to use the Bluetooth™ function if you choose Ultimate Battery Life in **PowerPanel**. Select another mode. See the **PowerPanel** online help for more details.

### *The Bluetooth™ device with which I want to communicate cannot be found*

- ❑ Check that the Bluetooth™ function of the device with which you want to communicate is on. See the other device's manual for more details.
- ❑ If the device with which you want to communicate is already communicating with another Bluetooth™ device, it may not be found or it may not be able to communicate with your notebook.

### *The data transfer rate is slow*

The data transfer speed depends on the obstacles and/or the distance between the two devices, but also on the radio wave quality, the operating system or the software used. Try to move your notebook or try to place the two devices closer.

*I cannot communicate with the other device although the distance between both devices is within 100 metres*

- ❑ The data transfer distance can be shorter than 100 metres depending on existing obstacles between the two devices, on radio wave quality, on the operating system or the software used. Try to move your notebook or to place both devices closer.
- ❑ If the device with which you want to communicate is already communicating with another Bluetooth™ device, it may not be found or it may not be able to communicate with your notebook.
- ❑ Check that the Bluetooth™ function of the device with which you want to communicate is on. See the other device's manual for more details.

*I cannot stop the Bluetooth™ function*

- ❑ Press the Bluetooth™ power button for at least four seconds and make sure that the Bluetooth™ LED turns off.
- ❑ If the above method does not work, press the power switch and hold it for at least four seconds. This turns off the power.

*I cannot connect to another Bluetooth™ device using services provided by another Bluetooth™ device*

You can connect to another Bluetooth™ device only by using the services provided by your notebook. See BlueSpace help and the other Bluetooth™ device's manual for details.

## About the display

### *My LCD does not display anything*

- ❑ Check that the computer is plugged into a power source and that it is turned on.
- ❑ Check that the power indicator on the front panel of the computer is on.
- ❑ Check that the battery packs are inserted properly and that they are charged.
- ❑ Adjust the brightness of the LCD.
- ❑ The computer may be in LCD (video) standby mode. Press any key to activate the display.
- ❑ The display mode may be set to external display mode. Press and hold the <Fn> key while pressing <F7> several times.

### *The screen image on my external display is not centered or sized properly*

Use the controls on your external display to adjust the image.

### *The window I have just closed continues to appear on my LCD*

Press the <Windows<sup>®</sup>> key and the <D> key twice to refresh the screen.

### *The video image on my screen is too dark*

If an external display is connected to the monitor connector, disconnect the display.

### *I cannot display MOTION EYE movies, DVD videos or finder images simultaneously on my notebook LCD display and on an external display*

You cannot display those images on both displays. Please select just one display.

## About CD-ROMs and diskettes

### *My CD-ROM drive tray does not open*

- Make sure the computer is turned on.
- Press the **Eject** button on the optical device drive.
- If the **Eject** button does not work, you can open the tray by inserting a sharp, pointed object into the hole to the right of the **Eject** button.

### *I cannot play a CD-ROM disc*

- Make sure the label of the CD is facing up.
- If the CD requires software, make sure the software is installed according to the instructions of the program.
- Check the volume of your speakers.
- Clean the CD.
- Moisture condensation may have occurred. Leave the computer for at least one hour while it is turned on.

### *My floppy disk drive cannot write to a diskette*

- The diskette is write-protected. Disable the write-protect feature or use a diskette that is not write-protected.
- Check that the diskette is properly inserted into the floppy disk drive.



*When I double-click an application icon, a message such as 'You must insert the application CD into your CD-ROM drive' appears and the software does not start.*

- ❑ Some titles require specific files that are located on the application CD-ROM. Insert the CD and try starting the program again.
- ❑ Make sure you place the disk in the tray with the label side facing up.

*When I remove the Memory Stick™, an error message appears*

Insert the Memory Stick™ in the slot again and press **<Enter>**. Wait until the active application finishes, then remove the Memory Stick™. If the message confirms eject of the Memory Stick™, click **OK**.

*About the MOTION EYE camera*

*There is a vertical line when shooting a bright subject with a dark background using MOTION EYE*

This is a phenomenon called "smear". It is not a malfunction.

*The image in the view finder of Smart Capture is rough*

If you are shooting a subject in rapid movement, there may be a gap. However, this is not a malfunction.

*The images captured with MOTION EYE are not clear*

- ❑ Shooting under fluorescent light may result in reflections.
- ❑ Red or green noises may occur if the captured images include dark parts.
- ❑ Check that the lens of the MOTION EYE is clean.
- ❑ Use the focus ring to focus adjustment.

*There are picture gaps and sound gaps when importing video images*

Gaps may occur based on the effect settings in **Smart Capture**.

*The MOTION EYE does not show any images*

- ❑ Check that other software such as **Smart Capture** does not use the MOTION EYE.
- ❑ Depending on monitor mode, color palette and other causes, the video memory is running out and the camera image is not displayed. Reduce the color palette or monitor resolution.
- ❑ Start the camera setting utility and select **Default**.
- ❑ If the above countermeasures do not work, restart the computer.

## *About sound*

*My speakers are not producing sound*

- ❑ The built-in speakers may be turned off. Press **<Fn>+<F3>** to turn on the speakers.
- ❑ The speaker volume may be turned to the minimum. Press **<Fn>+<F4>**, and then press **▶** or **▲** to increase the volume.
- ❑ If your computer is powered by battery, check that the battery is inserted properly and that it is charged.
- ❑ If you are using an application that has its own volume control, check that the volume is turned up.
- ❑ Check the volume controls in Windows<sup>®</sup>.
- ❑ If you use external speakers, check that the speakers are properly connected and the volume is turned up. If the speakers have a mute button, make sure it is off. If batteries power the speakers, check that the batteries are inserted properly and that they are charged.
- ❑ If you have connected an audio cable to the headphone connector, disconnect the cable.

### *My microphone does not work*

If you are using an external microphone, check that the microphone is plugged into the microphone connector.

### *An error message appears when using voice-related software programs*

- ❑ Double-click **Yamaha DS-XG Audio Config** in **Control Panel**. Open the **Echo** tab and deselect the **Enable** check box. Click **OK**.
- ❑ If you are using several voice-related software programs at the same time, close them.

### *About peripherals*

#### *I cannot use DV devices. The message DV equipment seems to be disconnected or turned off appears*

- ❑ Check that the DV device is turned on and that the cables are properly connected.
- ❑ If you are using multiple i.LINK™ devices, the combination of the connected devices may cause unstable operation. In this case, turn off the power of all connected devices and disconnect unused devices. Check the connection and then turn on the power again.

### *My PC Card is not working*

- ❑ Make sure the PC card is compatible with your version of Windows®.
- ❑ Use the **Sony Notebook Setup** utility to disable devices you are not currently using.
- ❑ If you are using two PC cards, use the **Sony Notebook Setup** utility to disable the devices you are not currently using.

### *I cannot print*

- ❑ Check that all the cables of the printer are correctly connected.
- ❑ Check that your printer is correctly configured and that you have up-to-date drivers. If needed, contact your dealer.

### *About digital video captures and DVgate*

*While I am recording images to a digital video device using DVgate, my system displays the message Recording to DV device failed. Check the power and cable connections to the DV device and try the operation again...*

Close all open applications and restart your computer. Frequent recording of images to a digital video device while using DVgate sometimes causes this error.

## Precautions

This section describes safety guidelines and precautions to help you protect your computer from potential damage.

Your notebook and memory modules use high precision components and electronic connectors technology. To avoid the invalidation of your guarantee by mishandling, it is recommended that:

- ❑ You contact your dealer to install a new memory module.
- ❑ You do not install it yourself, if you are not familiar with upgrading memory on a notebook.
- ❑ You do not touch the connectors or open the memory panel.

Please contact VAIO-Link if you need assistance.

## Placing a key top

If the enter or the space key comes off, replace the key top as shown below. If another key top comes off, put it where it was and push until it clicks into place.

To replace a key top, proceed as follows:

- 1 Remove the wire (1) under the key top if necessary.
- 2 Insert each side of the wire into one hook (2).
- 3 Make sure the center of the key top is aligned with the center underneath and press the key top until it fits.

Enter key:

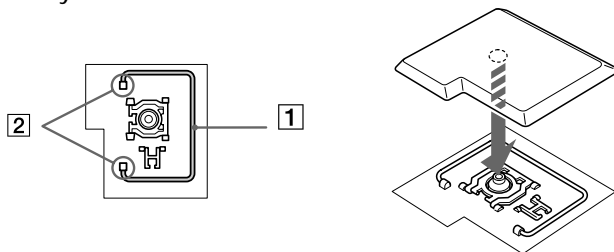

Space key:

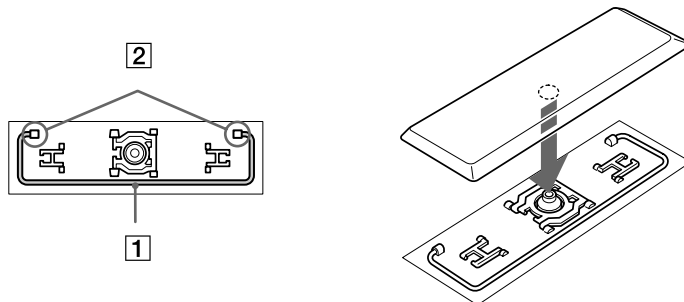

 Do not take off the key top intentionally. It may cause malfunction.

Handle the key top with care; your computer may be damaged if you press it to excess.

## *Other precautions*

### *On handling the LCD screen*

- ❑ Do not leave the LCD facing the sun as it can damage the LCD. Be careful when using the computer near a window.
- ❑ Do not scratch the LCD or exert pressure on it. This could cause malfunction.
- ❑ Using the computer in low temperature conditions may produce a residual image on the screen. This is not a malfunction. When the computer returns to normal temperature, the screen returns to normal.
- ❑ A residual image may appear on the screen if the same image is displayed for a lengthy period of time. The residual image disappears in a while. You can use a screensaver to prevent residual images.
- ❑ The screen becomes warm during operation. This is normal and does not indicate a malfunction.
- ❑ The LCD is manufactured using high-precision technology. You may, however, see tiny black points and/or bright points (red, blue, or green) that continuously appear on the LCD. This is a normal result of the manufacturing process and does not indicate a malfunction.
- ❑ Avoid rubbing the LCD screen, as this can damage the screen. Use a soft, dry cloth to wipe the LCD screen.

### *On using power source*

- ❑ Your computer operates on 100V-240V AC 50/60 Hz.
- ❑ Do not share the AC outlet with other power-consuming equipment, such as a photocopier or shredder.
- ❑ You can purchase a power strip with a surge protector. This device prevents damage to your computer caused by sudden power surges such as those that may occur during an electrical storm.
- ❑ Do not place heavy objects on the power cord.
- ❑ To disconnect the cord, pull it out by the plug. Never pull the cord itself.
- ❑ Unplug your computer from the wall outlet, if you will not be using the computer for a long time.

- ❑ When the AC adapter is not used, unplug it from the AC outlet.
- ❑ Use only the supplied AC adapter. Do not use any other AC adapter.

### *On handling your notebook*

- ❑ Clean the cabinet with a soft, dry cloth or a soft cloth lightly moistened with a mild detergent solution. Do not use any type of abrasive pad, scouring powder, or solvent such as alcohol or benzene, as these may damage the finish of your computer.
- ❑ Should any solid object or liquid fall into the computer, shut down your computer and then unplug it. You may want to have the computer checked by qualified personnel before operating it any further.
- ❑ Do not drop the computer or place heavy objects on top of the computer.
- ❑ Do not place your computer in a location subject to:
  - ❑ Heat sources, such as radiators or air ducts,
  - ❑ Direct sunlight,
  - ❑ Excessive dust,
  - ❑ Moisture or rain,
  - ❑ Mechanical vibration or shock,
  - ❑ Strong magnets or speakers that are not magnetically shielded,
  - ❑ Ambient temperature of more than 35°C or less than 10°C,
  - ❑ High humidity.
- ❑ Do not place electronic equipment near your computer. The electromagnetic field of your computer may cause a malfunction.
- ❑ Provide adequate air circulation to prevent that internal heat builds up. Do not place your computer on porous surfaces such as rugs or blankets, or near material such as curtains or draperies that may block its ventilation slots.



- ❑ The computer uses high-frequency radio signals and may cause interference to radio or TV reception. Should this occur, relocate the computer a suitable distance away from the set.
- ❑ Use only specified peripheral equipment and interface cables; otherwise, problems may result.
- ❑ Do not use cut or damaged connection cables.
- ❑ Your computer cannot be connected to a coin-operated telephone, and may not work with a private branch exchange (PBX).
- ❑ If the computer is brought directly from a cold location to a warm one, moisture may condense inside your computer. In this case, allow at least one hour before turning on your computer. If any problem occurs, unplug your computer and contact VAIO-Link.
- ❑ Make sure to disconnect the power cord before cleaning the computer.

### *On handling diskettes*

- ❑ Do not open the shutter manually and touch the surface of the diskette.
- ❑ Keep diskettes away from magnets.
- ❑ Keep diskettes away from direct sunlight and other heat sources.

### *On handling CD-ROM discs*

- ❑ Do not touch the surface of the disc.
- ❑ Do not drop or bend the disc.
- ❑ Fingerprints and dust on the surface of a disk may cause read errors. Proper care of the disc is essential to maintain its reliability. Do not use solvents such as benzine, thinner, commercially available cleaners or anti-static spray, as they may cause damage to the disc.
- ❑ For normal cleaning, hold the disc by its edge and use a soft cloth to wipe the surface from the center out.

- ❑ If the disc is badly soiled, moisten a soft cloth with water, wring it out well, and use it to wipe the surface of the disc from the center out. Wipe off any remaining moisture with a dry soft cloth.

### *On using the battery pack*

- ❑ Never leave the battery pack in temperatures above 60°C, such as in a car parked in the sun or under direct sunlight.
- ❑ Battery life is shorter in a cold environment. This is due to decreased battery efficiency at low temperatures.
- ❑ Charge the batteries at temperatures between 10°C to 30°C. Lower temperatures require a longer charging time.
- ❑ While the battery is in use or being discharged, the battery pack heats up. This is normal and is not cause for concern.
- ❑ Keep the battery pack away from all sources of heat.
- ❑ Keep the battery pack dry.
- ❑ Do not open or try to disassemble the battery pack.
- ❑ Do not expose the battery pack to any mechanical shock.
- ❑ If you are not using the computer for an extended period of time, remove the battery pack from the computer to prevent damage to the battery.
- ❑ If, after fully charging the battery pack, the battery power is still low, the battery pack may be reaching the end of its life and should be replaced.
- ❑ You do not need to discharge the battery before recharging.
- ❑ If you have not used the battery pack for a considerable amount of time, recharge the battery.

### *On using earphones*

- ❑ **Road safety** – Do not use earphones while driving, cycling, or operating any motorized vehicle. It may create a traffic hazard and is illegal in some areas. It can also be potentially dangerous to play loud music while walking, especially at pedestrian crossings.
- ❑ **Preventing hearing damage** – Avoid using earphones at high volume. Hearing experts advise against continuous, loud and extended play. If you experience a ringing in your ears, reduce the volume or discontinue use.

### *On handling Memory Stick™*

- ❑ Do not touch the connector with your finger or metallic objects.
- ❑ Use only the label supplied with the Memory Stick™ as a label.
- ❑ Do not bend, drop, or apply strong shock to the Memory Stick™.
- ❑ Do not disassemble or modify Memory Sticks™.
- ❑ Do not let cards get wet.
- ❑ Do not use or store Memory Sticks™ in a location subject to:
  - ❑ Extremely high temperatures, such as in a car parked in the sun,
  - ❑ Direct sunlight,
  - ❑ High humidity or near corrosive substances.
- ❑ Use the storage case supplied with the Memory Stick™.

## PCG-C1VFK specifications

### Product name

### PCG-C1VFK

<i>Operating system</i>	Microsoft® Windows® 2000 Professional
<i>Processor</i>	Crusoe™ Processor TM5600 667 MHz
<i>Hard disk drive</i>	15 GB
<i>Standard RAM</i>	128 MB SDRAM
<i>Maximum RAM</i>	192 MB
<i>LCD screen</i>	8.95" TFT display Ultra Wide XGA
<i>L2 cache memory</i>	512 KB (CPU integration)
<i>MPEG</i>	MPEG 2 Digital Video Supports full-screen playback
<i>Graphics</i>	ATI Rage Chipset with 8 MB Video RAM and 3D acclerator
<i>Sound capabilities</i>	16-bit CD-quality stereo sound
<i>Expansion capabilities</i>	One PCMCIA type II Card and Cardbus support
<i>Built-in capabilities</i>	Microphone, stereo speakers, MOTION EYE camera, pointing device, Jog Dial, MagicGate Memory Stick™
<i>Special buttons</i>	Jog Dial, Capture, Bluetooth™
<i>Connection capabilities on notebook</i>	VGA monitor, projector or television, MagicGate Memory Stick™ or Memory Stick™, external speakers, microphone, USB, Type II PC Cards, i.LINK™ (IEEE1394) S400

**Product name****PCG-C1VFK**

<i>Supplied accessories</i>	rechargeable battery, AC adapter, power cord, display adapter, spare stick covers, AV cable
<i>Service</i>	‡ 1 year free VAIO-Link Service
<i>Guarantee</i>	‡ 1 year guarantee (parts and labour)
<i>Power source</i>	16 V DC/AC 100-240V
<i>Power management</i>	Energy Star compliant ACPI (Advanced Configuration & Power Interface)
<i>Battery</i>	Lithium ion
<i>Dimensions</i>	
<i>Width</i>	248 mm
<i>Height</i>	27 mm
<i>Depth</i>	152 mm
<i>Weight</i>	
<i>With battery</i>	990 g
<i>Operating temperature</i>	+5°C to +35°C (temperature gradient less than 10°C/hour)
<i>Storage temperature</i>	-20°C to +60°C (temperature gradient less than 10°C/hour)
<i>Operating humidity</i>	20% to 80% (not condensed), provided that humidity is less than 65% at +35°C (hygrometer reading of less than 29°C)
<i>Storage humidity</i>	10% to 90% (not condensed), provided that humidity is less than 20% at +60°C (hygrometer reading of less than 35°C)

**Product name****PCG-C1VFK**

<i>Wireless communication: Method of communication</i>	Bluetooth™ standard Ver. 1.0B
<i>Maximum communication speed</i>	Approx. 723 kbps
<i>Output</i>	Bluetooth™ standard Power Class1
<i>Communication distance</i>	Approx. 100 – 10 m (open space)
<i>Compatible Bluetooth profile</i>	Generic Access Profile Service Discovery Application Profile Serial Port Profile Dial-up Networking Profile
<i>Usable frequency band</i>	2.4 GHz band (2.400 GHz – 2.4835 GHz)
<i>Bundled software</i>	BlueSpace, VisualShare
<i>MOTION EYE camera</i>	350,000 pixels (square pixels)
<i>Image device</i>	1/6 inch, progressive scan 350,000 pixels CCD
<i>Lens</i>	Focus distance: f = 2.8 mm, F = 2.8 mm (f = 39 mm translated to a 35 mm camera)
<i>White balance</i>	Automatic/Indoor/Outdoor/Hold
<i>Shutter speed</i>	Auto/1/50/Hold
<i>Video capture format size</i>	YUY2/24 bit RGB Motion JPEG/JPEG / size:VGA hVGA qVGA
<i>Displayed frames</i>	30 frames/s. max (overlay)

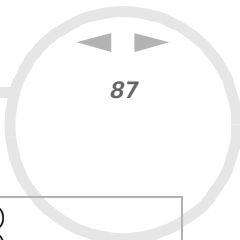

**Product name**

**PCG-C1VFK**

*Captured frames*

30 frames/s. max. (320 x 240 motion JPEG)  
15 frames/s. max. (640 x 480 motion JPEG)

† See our special Guarantee extension conditions.

Specifications are subject to change without notice.

## PCG-C1VFLK specifications

### Product name

### PCG-C1VFLK

<i>Operating system</i>	Microsoft® Windows® 2000 Professional
<i>Processor</i>	Crusoe™ Processor TM5600 667 MHz
<i>Hard disk drive</i>	15 GB
<i>Standard RAM</i>	128 MB SDRAM
<i>Maximum RAM</i>	192 MB
<i>LCD screen</i>	8.95" TFT display Ultra Wide XGA
<i>L2 cache memory</i>	512 KB (CPU integration)
<i>MPEG</i>	MPEG 2 Digital Video Supports full-screen playback
<i>Graphics</i>	ATI Rage Chipset with 8 MB Video RAM and 3D acclerator
<i>Sound capabilities</i>	16-bit CD-quality stereo sound
<i>Expansion capabilities</i>	One PCMCIA type II Card and Cardbus support
<i>Built-in capabilities</i>	Microphone, stereo speakers, MOTION EYE camera, pointing device, Jog Dial, MagicGate Memory Stick™
<i>Special buttons</i>	Jog Dial, Capture



**Product name****PCG-C1VFLK**

<i>Connection capabilities on notebook</i>	VGA monitor, projector or television, MagicGate Memory Stick™ or Memory Stick™, external speakers, microphone, USB, Type II PC Cards, i.LINK™ (IEEE1394) S400
<i>Supplied accessories</i>	rechargeable battery, AC adapter, power cord, display adapter, spare stick covers, AV cable
<i>Service</i>	‡ 1 year free VAIO-Link Service
<i>Guarantee</i>	‡ 1 year guarantee (parts and labour)
<i>Power source</i>	16 V DC/AC 100-240V
<i>Power management</i>	Energy Star compliant ACPI (Advanced Configuration & Power Interface)
<i>Battery</i>	Lithium ion
<i>Dimensions</i>	
<i>Width</i>	248 mm
<i>Height</i>	27 mm
<i>Depth</i>	152 mm
<i>Weight</i>	
<i>With battery</i>	980 g
<i>Operating temperature</i>	+5°C to +35°C (temperature gradient less than 10°C/hour)
<i>Storage temperature</i>	-20°C to +60°C (temperature gradient less than 10°C/hour)
<i>Operating humidity</i>	20% to 80% (not condensed), provided that humidity is less than 65% at +35°C (hygrometer reading of less than 29°C)

**Product name****PCG-C1VFLK**

<i>Storage humidity</i>	10% to 90% (not condensed), provided that humidity is less than 20% at +60°C (hygrometer reading of less than 35°C)
<i>MOTION EYE camera</i>	350,000 pixels (square pixels)
<i>Image device</i>	1/6 inch, progressive scan 350,000 pixels CCD
<i>Lens</i>	Focus distance: f = 2.8 mm, F = 2.8 mm (f = 39 mm translated to a 35 mm camera)
<i>White balance</i>	Automatic/Indoor/Outdoor/Hold
<i>Shutter speed</i>	Auto/1/50/Hold
<i>Video capture format size</i>	YUY2/24 bit RGB Motion JPEG/JPEG / size:VGA hVGA qVGA
<i>Displayed frames</i>	30 frames/s. max (overlay)
<i>Captured frames</i>	30 frames/s. max. (320 x 240 motion JPEG) 15 frames/s. max. (640 x 480 motion JPEG)

‡ See our special Guarantee extension conditions.

Specifications are subject to change without notice.

# INDEX

## A

- AC adapter 5, 17
- air circulation 80
- Alt key 25
- application key 25
- AV out connector 13

## B

- Bass Boost 28
- battery
  - charging the 19
  - inserting the 18
- battery charging status 19
- battery connector 16
- battery indicator 15, 19, 27
- battery lock lever 16
- battery release lever 16
- Bluetooth™ indicator 15
- Bluetooth™ power button 15
- brightness control 28
- built-in camera 15
- button
  - capture 15
  - power 15

- RELEASE 14
- buttons
  - left/center/right 15

## C

- cable
  - i.LINK 62
  - microphone 52
  - printer 58
  - speaker 51
- camera 62
  - built-in 15
- Caps Lock indicator 15, 27
- capture button 15
- CD-ROM drive 57
- charging status 19
- combination controls 26, 28
- connector
  - AV out 13
  - battery 16
  - DC In 17
  - earphone 51
  - headphone 13
  - i.LINK 14
  - microphone 13, 52
  - mini VGA out 13
  - USB 13
- copyright 2

- correction keys 25
- Ctrl key 25
- Customer Guide 64
- Customer Service Guide 64

## D

- DC In 13, 17
- digital video camera 62
- diskette
  - inserting a 55
  - removing a 55
- display 47
  - computer 47
- DVgate 62

## E

- earphone connector 51
- Energy Star guidelines 3
- ergonomic considerations 11
- Escape key 24
- external
  - microphone 52
  - speaker 51

## F

- floppy disk drive
  - connecting a USB 54
  - removing a USB 56
- Fn key 25, 28
- function keys 25

## G

- guarantee 4, 23

## H

- hard disk drive indicator 15, 27
- headphone connector 13
- help 64
- Hibernate mode 28, 45

## I

- i.LINK cable 62
- i.LINK connector 14
- indicator
  - battery 15, 19, 27
  - Bluetooth™ 15
  - Caps Lock 15, 27
  - hard disk drive 15, 27
  - MagicGate Memory Stick™ 27

- Num Lock 15, 27
- power 15, 27
- Scroll Lock 15, 27
- Insert key 25

## J

- Jog Dial 13, 31

## K

- key
  - Alt 25
  - application 25
  - Ctrl 25
  - Escape 24
  - Fn 25, 28
  - Insert 25
  - Print Screen 25
  - Shift 25
  - Windows 25, 26
- keyboard 24

## L

- left/center/right buttons 15
- lever
  - battery lock 16

- battery release 16
- lithium ion battery 7

## M

- Macrovision 2
- MagicGate Memory Stick slot window 16
- MagicGate Memory Stick™ 14
- MagicGate Memory Stick™ indicator 15, 27
- Memory Stick 37
  - inserting a 39
  - removing a 40
- Memory Stick™
  - MagicGate 14
- microphone 15, 52
  - cable 52
  - connector 52
- microphone connector 13, 52
- mini VGA out connector 13
- modem 4, 5
- moisture condensation 81
- monitor 47
- mouse 53

## N

- navigation keys 25

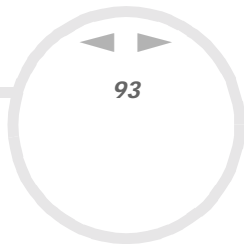

Normal mode 44  
Num Lock 25  
Num Lock indicator 15, 27  
numeric keypad 25

## O

operator keys 25

## P

PC Card  
    removing a 36  
PC Card slot 14, 35  
peripherals 46  
pointing device 15  
power button 15  
power indicator 15, 27  
power saving modes 44  
precautions 77  
Print Screen key 25  
printer 58  
printer cable 58  
projector 47

## R

registration 23

regulatory information 6  
RELEASE button 14  
reset switch 16

## S

safety information 4  
Scroll Lock indicator 15, 27  
Shift key 25  
slot  
    PC Card 14, 35  
    ventilation 14  
slot window  
    MagicGate Memory Stick 16  
Smart Connect 63  
Software guide 64  
speaker 15, 51  
    cable 51  
speaker switch 28  
speaker volume 28  
specifications 84, 88  
Standby mode 28, 44  
switch  
    reset 16  
    speaker 28

## T

technical specifications 84, 88

troubleshooting 65  
TV 47

## U

USB 53  
USB connector 13  
USB floppy disk drive 54  
USB mouse 53

## V

VAIO-Link 65  
VAIO-Link Response Centre 65  
ventilation 80  
ventilation slot 14  
video camera 62

## W

warnings 4  
Windows key 25, 26