



Sony Notebook Computer User Guide

PCG-SR1K



Notice to Users

© 2000 Sony Corporation. All rights reserved. This manual and the software described herein, in whole or in part, may not be reproduced, translated, or reduced to any machine-readable form without prior written approval.

Sony Corporation provides no warranty with regard to this manual, the software, or other information contained herein and hereby expressly disclaims any implied warranties or merchantability or fitness for any particular purpose with regard to this manual, the software or such other information. In no event shall Sony Corporation be liable for any incidental, consequential, or special damages, whether based on tort, contract, or otherwise, arising out of or in connection with this manual, the software, or other information contained herein or to use thereof.

Sony Corporation reserves the right to make any modification to this manual or the information contained herein at any time without notice. The software described herein is governed by the terms of a separate user license agreement.

Sony, DVgate, i.LINK™, Mavica, PictureGear, Memory Stick and the Memory Stick logo, VAIO and the VAIO logo are trademarks of Sony Corporation. Windows, the Windows 98 and the Windows 2000 logos are registered trademarks of Microsoft Corporation.

Intel, MMX, Celeron and Pentium are trademarks of Intel Corporation.

All other trademarks are trademarks of their respective owners.

Specifications are subject to change without notice.

Safety Information

Owner's Record

The model number and serial number are located on the bottom of your Sony notebook computer. Record the serial number in the space provided here. Refer to the model and serial number when you call VAIO-Link.

Serial number: _____

Model number:

PCG-3192

WARNING

- Opening the unit, for whatever reason, could lead to damages that are not covered by the guarantee.
- To avoid electrical shock, do not open the cabinet. Refer servicing to qualified personnel only.
- Audio and picture distortion may occur if this equipment is positioned in close proximity to any equipment emitting electromagnetic radiation.
- To prevent fire or shock hazard, do not expose your VAIO notebook computer to rain or moisture.
- Never install modem or telephone wiring during a lightning storm.
- Never install telephone jacks in wet locations unless the jack is specifically designed for wet locations
- Never touch uninsulated telephone wire or terminals unless the telephone line has been disconnected at the network interface.
- Use caution when installing or modifying telephone lines.
- Avoid using the modem during an electrical storm.
- Do not use the modem or a telephone to report a gas leak in the vicinity of the leak.
- Use your notebook only with the supplied AC adapter. To disconnect your notebook completely from mains voltage, unplug the AC adapter.
- Please make sure that the socket outlet is easily accessible.

Regulatory Information

This product conforms to the following European Directives:

73/23/EEC (Low Voltage Directive)

89/336/EEC, 92/31/EEC (EMC Directives)

93/68/EEC (CE Marking Directive)

This product complies with EN 55022 Class B and EN 50082-1 for use in following areas: residential, commercial and light-industrial.

This product has been tested and found compliant with the limits set out in the EMC Directive for using connection cables shorter than 3 metres (9.8 feet)



As an ENERGY STAR Partner, Sony has determined that this product meets the ENERGY STAR guidelines for energy efficiency.

The International ENERGY STAR Office Equipment Program is an international program that promotes energy saving through the use of computers and their office equipment. The program backs the development and dissemination of products with functions that effectively reduce energy consumption. It is an open system in which business proprietors can participate voluntarily. The targeted products are office equipment such as computers, displays, printers, facsimiles and copiers. Their standards and logos are uniform among participating nations.

ENERGY STAR is an U.S. registered mark.

 **Disposal of Lithium ion batteries**

Dispose of properly at end-of-life. In some areas the disposal of lithium ion batteries in household or business waste may be prohibited. Please use the public collection system.

DISPOSAL OF LITHIUM ION BATTERY

- ! Do not handle damaged or leaking Lithium ion batteries. Dispose of promptly and properly.
- ! Danger of explosion if battery is incorrectly replaced. Replace only with the same or equivalent type recommended by the manufacturer. Discard used batteries according to the manufacturer's instructions (see below).
- ! The battery pack used in this device may present a fire or chemical burn hazard if mistreated. Do not disassemble, heat above 100°C (212°F) or incinerate. Dispose of used battery promptly.
- ! Keep away from children.
- ! Your notebook is equipped with an internal backup memory battery. For changing this battery, please contact VAIO-Link.

Welcome

Congratulations on purchasing a Sony VAIO notebook computer. Sony has combined leading-edge technology in audio, video, computing and communications to provide you with state-of-the-art personal computing.

Here are just some of the features your VAIO notebook computer has to offer (read the details in the Specifications chapter of this guide).

- ❑ **Exceptional performance** - Your PC includes a fast Intel® processor, a fast CD-ROM drive and a PC card modem (depending on the model).
- ❑ **Portability** - The rechargeable battery pack provides hours of use without AC power.
- ❑ **Sony audio and video quality** - A high-resolution LCD screen enables you to take advantage of today's advanced multimedia applications, games, and entertainment software.
- ❑ **Windows®** - Your system includes the latest operating system from Microsoft.
- ❑ **Communications** - Access popular online services, send and receive e-mails, browse the Internet...
- ❑ **Excellent customer support** - If you have any problem with your computer, you can contact VAIO-Link by Internet and e-mail (see your Customer Service Guide for addresses). Before contacting VAIO-Link, you may try to solve the problem by reading your User Guide (troubleshooting chapter) or the manuals and Help files for the peripherals or software.



About the User Guides

Your Documentation Pack contains paper and on-line user guides on a Documentation CD-ROM:

Printed Documentation:

- ❑ A **Setting Up** poster in colour and a **Getting Started** brochure; a **Customer Guide**, where you will find all the basic information to start using your notebook computer;
- ❑ A complete Regulatory and safety information poster;
- ❑ Your Sony Guarantee conditions.

On-line Documentation:

- 1 This User Guide:
 - ❑ **Using Your Sony Notebook Computer** shows you how to use the standard components of your system.
 - ❑ **Connecting Peripheral Devices** explains how you can add functionality by connecting various peripherals.
 - ❑ **Getting Help** explains the support options available to you, and offers basic troubleshooting tips.
 - ❑ **Notes on Use** provides facts and advice about using your notebook computer.
 - ❑ **Specifications** provides details on your computer, drivers and accessories.
- 2 Refer to your **Software Guide** for information on the bundled software and the Sony applications.



- ❑ **About the Software** is a short description of the features of the software pre-installed on your system.
- ❑ **Customizing your notebook** explains how to set your system and power management with Sony Notebook Setup, VAIO Action Setup, PowerPanel, BatteryScope, etc.
Learn how to set your display with NeoMagic[®] and enjoy the Dual Screen Display option (Windows[®] 98 only).
- 3 Consult the **On-line Help** files of the software you're using for detailed information on features and troubleshooting.



Unpacking Your Notebook Computer

Remove the following hardware items from the box:

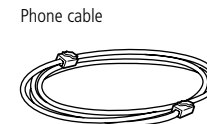
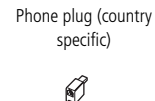
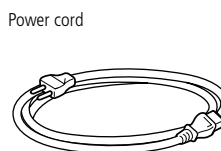
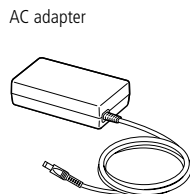
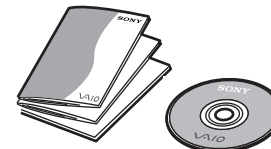
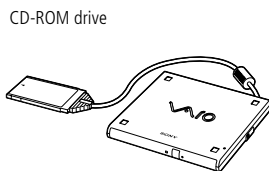
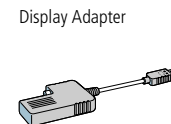
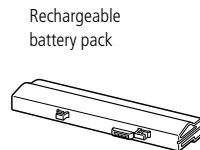
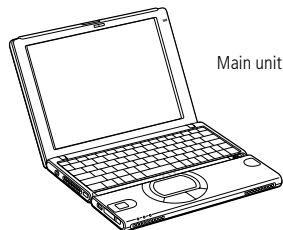

Ergonomic Considerations

You will be using your notebook computer as a portable device in a variety of environments. Whenever possible, you should attempt to take account of the following ergonomic considerations to both stationary and portable environments:

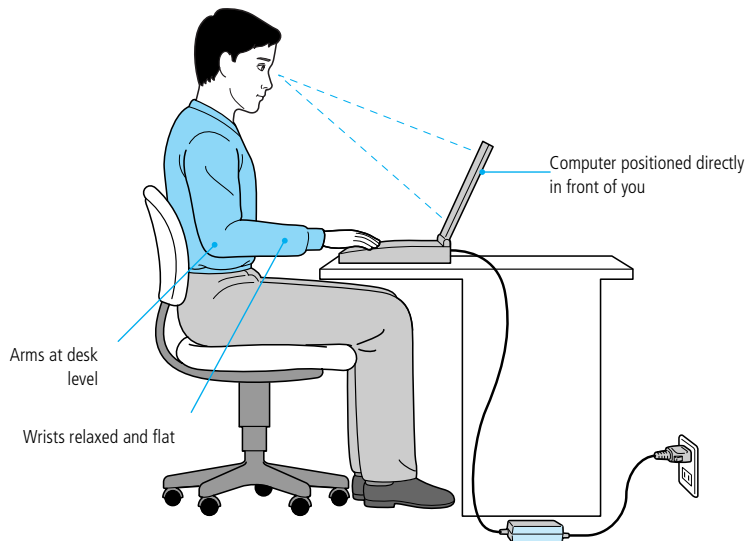

- ❑ **Position of your computer** – Place the computer directly in front of you as you work. Keep your forearms horizontal, with your wrists in a neutral, comfortable position while using the keyboard, touchpad, or external mouse. Let your upper arms hang naturally at your sides. Take breaks during sessions with your computer. Excessive use of the computer may strain muscles or tendons.

- ❑ **Furniture and posture** – Sit in a chair with good back support. Adjust the level of the chair so your feet are flat on the floor. A footrest may make you more comfortable. Sit in a relaxed, upright posture and avoid slouching forward or leaning far backwards.
- ❑ **Viewing angle of the computer's display** – Use the display's tilting feature to find the best position. You can reduce eye strain and muscle fatigue by adjusting the tilt of the display to the proper position. Adjust the brightness setting of the display as well.
- ❑ **Lighting** – Choose a location where windows and lights do not create glare and reflection on the display. Use indirect lighting to avoid bright spots on the display. You can also purchase accessories for your display that help reduce glare. Proper lighting adds to your comfort and work effectiveness.
- ❑ **Placement of an external display** – When using an external display, set the display at a comfortable viewing distance. Make sure the display screen is at eye level or slightly lower when you are sitting in front of the monitor.



✎ Phone cable and connectors are TNV (Telecommunication Network Voltage), according to EN60950.

Using Your Notebook Computer

This section describes how to start using your computer and how to use your computer's internal devices, such as the touchpad, the disk drives and the battery...

Locating the Controls and Connectors

Right

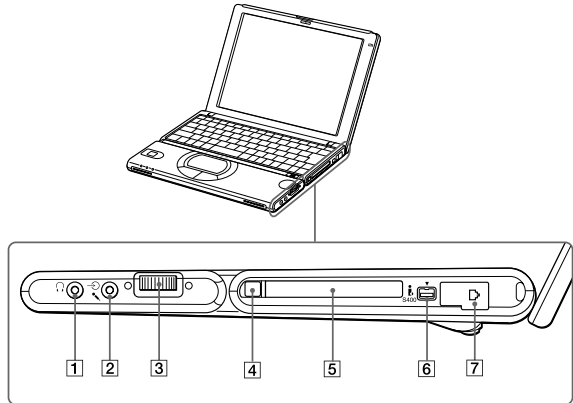

- | | | |
|--|---|------------------------------------|
| 1 Headphone connector (page 59) | 4 PC Card eject button (page 42) | 7 Phone Line jack (page 48) |
| 2 Line in/mic connector (page 60) | 5 PC card slot (page 42) | |
| 3 Jog Dial (page 31) | 6 S400 i.LINK™ connector (page 57) | |

Locating the Controls and Connectors



⚠ AC adapter mains connector and power cord: hazardous voltage, according to EN 60950.

All other connectors for this notebook are SELV (Safety Extra Low Voltage), according to EN 60950.

⚠ There is a ventilation slot located near the DC In connector. Do not cover the ventilation slot when your computer is on.

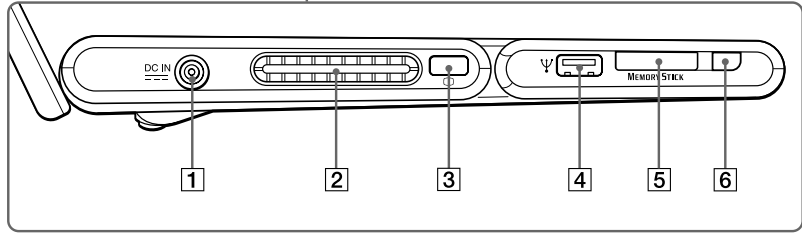
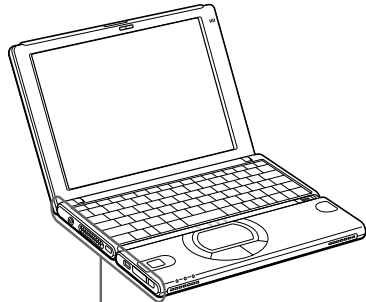
Left



- | | |
|--|--|
| 1  DC In (page 16) | 4  USB connector (page 49) |
| 2 Ventilation slot | 5 Memory Stick™ slot (page 38) |
| 3 Monitor connector (page 54) | 6 Memory Stick™ eject button (page 39) |

Front

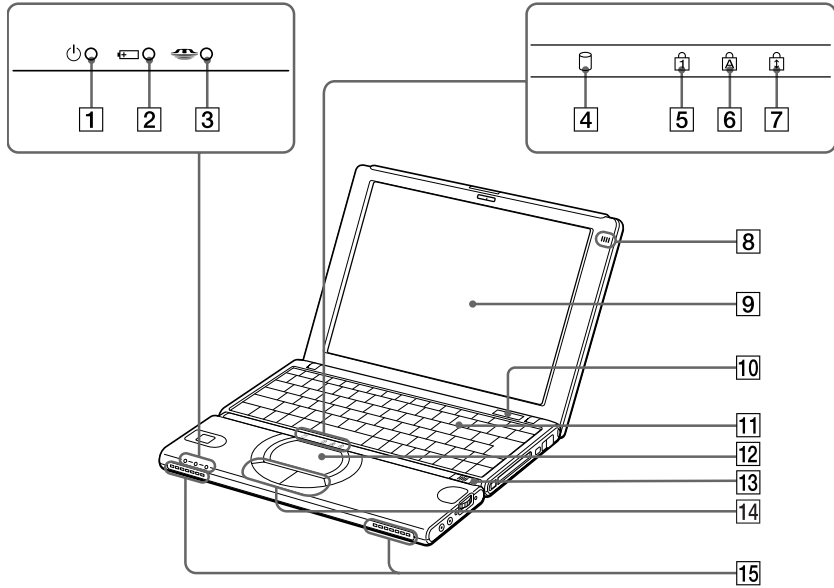

- | | | | | | |
|------------------------------------|-----------|--------------------------------|-----------|------------------------------|-----------|
| 1 Power indicator | (page 27) | 6 Caps Lock indicator | (page 27) | 11 Keyboard | (page 24) |
| 2 Battery indicator | (page 27) | 7 Scroll Lock indicator | (page 27) | 12 Touchpad | (page 36) |
| 3 Memory Stick™ indicator | (page 38) | 8 Internal microphone | | 13 ⏻ Power switch | (page 21) |
| 4 Hard disk drive indicator | (page 27) | 9 LCD screen | (page 29) | 14 Left/right buttons | (page 36) |
| 5 Num Lock indicator | (page 27) | 10 ID Label | | 15 Speakers | |

Back

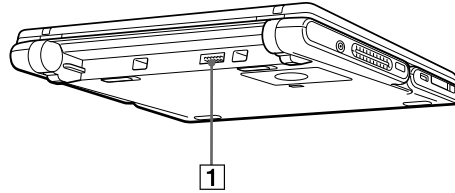

1 Battery connector (page 17)

Bottom

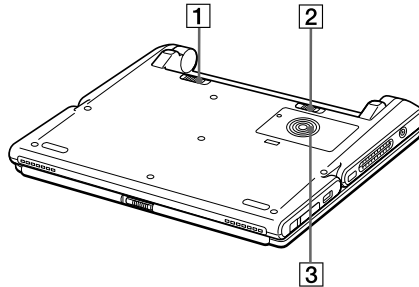

1 Battery lock lever (page 17) **2** Battery release lever (page 17) **3** Ventilation slot

✎ Use your notebook only with the supplied AC adapter.

To disconnect your notebook completely from mains voltage, unplug the AC adapter.

Please make sure that the socket outlet is easily accessible.

Connecting a Power Source

You can use either AC power or a rechargeable battery pack as a power source.

Using the AC Adapter

- 1 Plug the cable attached to the AC adapter into the DC In connector on the computer.
- 2 Plug one end of the power cord into the AC adapter.
- 3 Plug the other end of the power cord into an AC outlet.

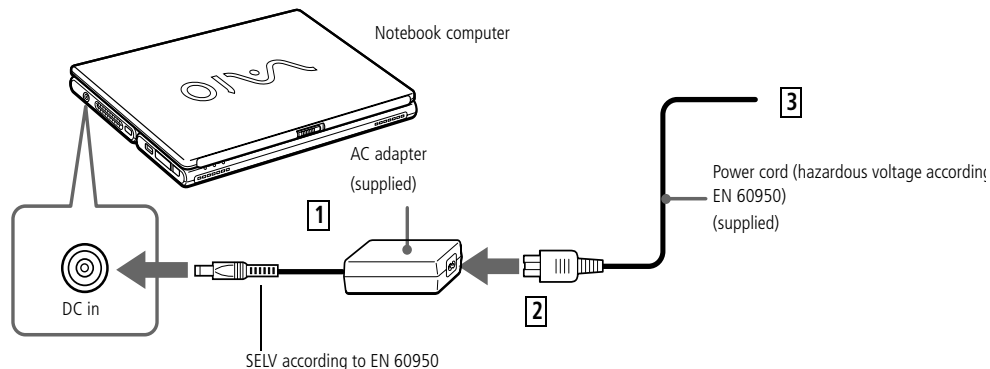

! You may lose data if you remove the battery pack while the computer is on and not connected to the AC adapter or if you remove the battery while the computer is in system suspend mode.

🔧 You can remove the battery pack without turning off the computer when it is connected to the mains voltage (AC adapter).

Before you remove/insert the battery pack, close the cover.

Using Battery Power

You can use a battery pack as a source of power.

The battery pack supplied with your computer is not fully charged at the time of purchase. Follow the steps below to insert and charge the battery pack.

To insert the battery pack

- 1 Move the lock lever on the bottom of the computer to the UNLOCK position.

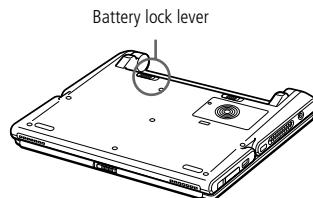

- 2 Align the grooves and tabs on the battery with the tabs and notches on the back of the computer, and then slide the battery towards the computer until it clicks into place.

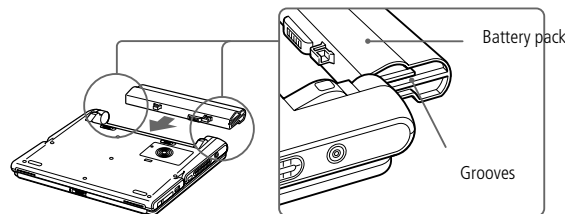

- 3 Slide the lock lever into the LOCK position to secure the battery on the computer.

To charge the battery pack

- 1 Connect the AC adapter to the computer.
- 2 Insert the battery pack.

The computer automatically charges the battery (the battery indicator light flashes in a double blink pattern as the battery charges). When the battery is 85% full, the battery indicator light turns off. This process takes about 2 hours when power is off. It takes 5.5 hours when power is on. To charge the battery completely, continue charging for additional 3 hours.

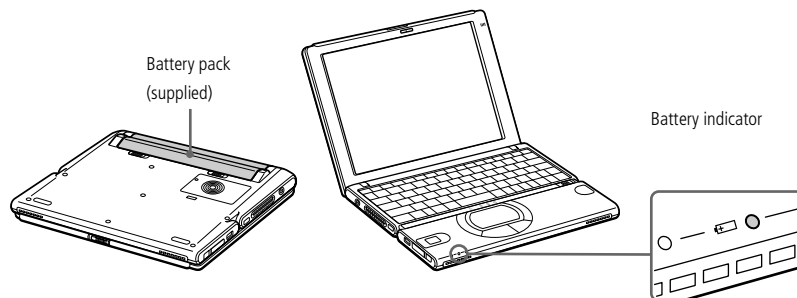

<i>Battery Indicator Light Status</i>	<i>Meaning</i>
On	The computer is using battery power.
Single blink	The battery is running out of power.
Double blink	The battery is charging.
Off	The computer is using AC power.

 For some software applications and some peripheral devices, your computer may not enter system hibernation mode when battery life is low. To avoid loss of data when using battery power, you should save your data frequently and manually activate a power management mode, such as system suspend or system hibernation.

When the battery is running out of power, both the battery and power indicators blink. To determine the time the battery lasts, please refer to "Displaying Battery information" in your Software Guide.

Keep the battery pack in the computer while it is directly connected to AC power. The battery pack continues to charge while you are using the computer.

If the battery level falls to below 10%, you should either attach the AC adapter to recharge the battery or shut down your computer and insert a fully charged battery.

You can extend battery life by changing the power management modes in the PowerPanel utility. See your Software guide, in "Controlling Power Management".

The battery pack supplied with your computer is a lithium ion battery and can be recharged at any time. Charging a partially discharged battery does not affect battery life.

The battery indicator light is on while you use the battery pack as a power source. When battery life is nearly depleted, the battery indicator starts flashing.

When the computer is directly connected to AC power and has a battery pack inserted in the battery bay, it uses power from the AC outlet.



Connecting a Power Source

 You can remove the battery pack without turning off the computer when it is connected to the mains voltage (AC adapter).

Before you remove/insert the battery pack, close the cover.

To remove the battery pack

- 1 Turn off the computer and close the cover.
- 2 Slide the lock lever to the UNLOCK position.
- 3 Slide the release lever to the UNLOCK position and slide the battery away from the computer.

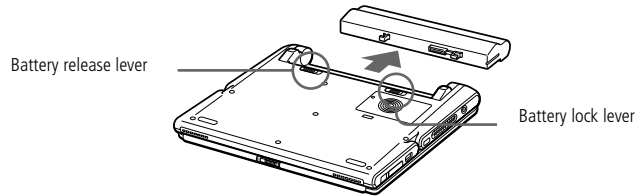

Starting Your Computer

- 1 Slide the LCD lock lever in the direction of the arrow, and lift the cover.

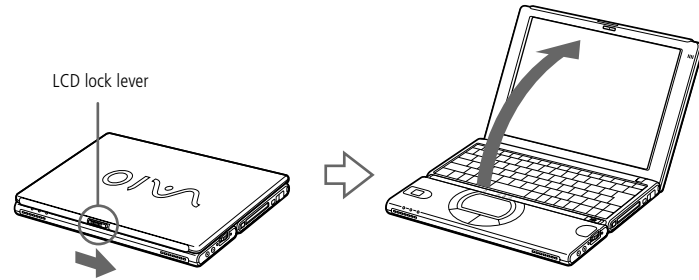

 If you hold the power switch in the on position for more than four seconds, the computer will turn off.

- 2 Slide the power switch of the computer until the green power indicator light turns on.

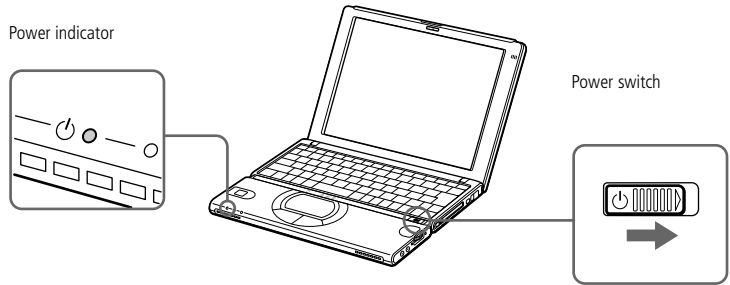

- 3 If necessary, adjust the brightness controls for the LCD display with Fn+F5. To increase the brightness, use the up or right arrow keys. To decrease use the down or left arrow keys.

! To avoid potential loss of data, follow these steps to shut down your computer.

📌 Respond to any prompts warning you to save documents.

Shutting Down Your Computer

- 1 Click Shut Down at the bottom of the Start menu to display the Shut Down Windows dialog box.
- 2 Select Shut down.
- 3 Click on OK.
- 4 Wait for your computer to turn off automatically. The power indicator will turn off.
- 5 Turn off any peripheral connected to your computer.

📌 If you are unable to shut down your computer using the steps described above,
-close all software in use,
-remove the PC cards if inserted,
-disconnect any USB devices,
then shut down the computer.

If the previous steps do not work, see the Troubleshooting section of this User Guide.

During a period of inactivity, you can conserve battery life by using System Suspend mode. See "Controlling Power Management" in your Software Guide for further details.

 You must connect your phone line before using any online services, including the online registration service. Please refer to "Connecting to a phone line".

To access the on-line Registration web page, you must have a connection to the internet.

Registering Your Computer

You can take advantage of Sony's commitment to quality customer support and receive the following benefits by registering your computer with Sony:

- ❑ **VAIO-Link** – You can contact VAIO-Link by Internet or e-mail (see your Customer Service Guide for addresses).
- ❑ **Guarantee** – Protect your investment. See the Guarantee sheet for the terms and conditions and please refer to your Customer Service Guide for more information.

Follow these steps to use the Sony Notebook Computer's online registration service:

- 1 Click on the Welcome button on your Desktop,
- 2 Click Next,
- 3 Click Internet,
- 4 Fill in your Registration card fields,
- 5 Scroll down to the bottom of the form and click Send,
- 6 Click OK.

Using the Keyboard

Your keyboard is very similar to a desktop computer's, but the keyboard has additional keys that perform specific notebook computer-related tasks.

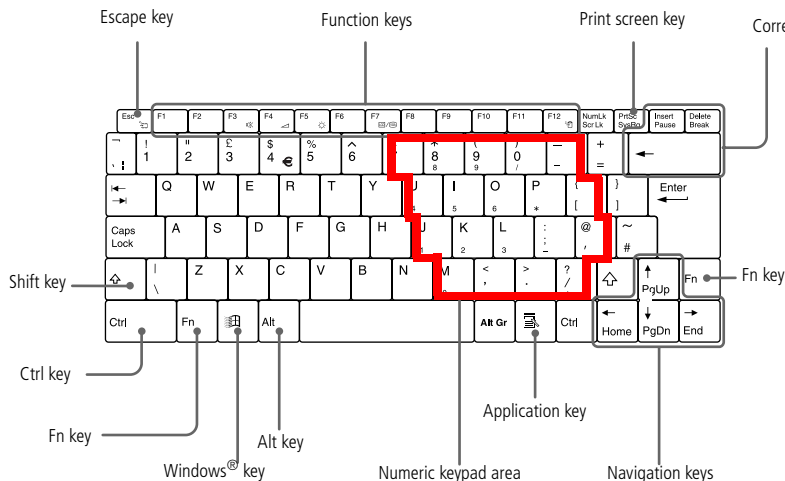

Keys



Descriptions

Numeric keypad area

Contains the keys found on a typical calculator. Use the numeric keypad area to type numbers or to perform mathematical calculations such as addition and subtraction. Note that you must press the Num Lock key to activate the numeric keypad. (When you do so, the Num Lock light will illuminate.)

Correction keys





The Insert, Back Space, and Delete keys enable you to make corrections in your documents.

<i>Keys</i>	<i>Descriptions</i>
Navigation keys	Several keys are devoted to moving the cursor on the screen.
Function keys	The twelve function keys along the top of the keyboard are used to perform designated tasks. For example, in many applications, F1 is the Help key. The task associated with each function key may vary from one application to the next.
Escape key	The Esc (Escape) key is used to cancel commands.
Print Screen key	The Print Screen key takes an electronic snapshot of the screen and places it in the Windows Clipboard. You can then paste the screen shot into a document and print it.
Operator keys	Several keys are always used with at least one other key: Ctrl, Alt, and Shift. When held down with another key, the Ctrl (Control) and Alt (Alternate) keys offer another way to give commands. For example, in many applications, instead of choosing the Save command from a menu, you can hold down Ctrl and press S (referred to as Ctrl+S). The Shift key is used to produce capital letters or special symbols such as @ and \$.
Windows [®] key 	The key with the Windows [®] logo displays the Windows [®] Start menu; it's the equivalent of clicking the Start button on the task bar. See "Combinations and functions with the Windows [®] key" for further details.
Fn key	The Fn key is used in combination with other keys to issue commands. See "Combinations and functions with the Fn key".
Applications key 	The Applications key displays a shortcut menu of context-sensitive choices; pressing this key is the equivalent of clicking the right mouse button.

Combinations and Functions with the Windows® Key

<i>Combinations</i>	<i>Functions</i>
⊞ + F1	Displays Windows Help
⊞ + Tab	Switches the selected button on the taskbar.
⊞ + E	Displays Windows Explorer.
⊞ + F	Displays the Windows Search to find a file or folder. This is the equivalent of selecting Search and then Files or Folders from the Start menu.
⊞ + Ctrl + F	Displays the Windows Search for Computers window where you can locate other computers.
⊞ + M	Minimizes all displayed windows.
Shift + ⊞ + M	Returns all minimized windows to their previous size.
⊞ + R	Displays the Run window. This is the equivalent of selecting Run from the Start menu.

Indicators

<i>Indicator</i>	<i>Functions</i>	
Power 	Power on: lights green. System Idle mode: lights amber. System suspend mode: flashes amber.	
Battery 	Indicates the status of the battery inserted in the computer.	
<i>Light</i>	<i>On</i>	<i>Off</i>
 Hard disk	Data is read from or written to the hard drive. Do not enter System Suspend mode or turn off the computer when this indicator light is on.	The hard drive is not being accessed.
 Num Lock	Turns on when the number keys area in the numeric keypad are active.	Turns off when the alphanumeric character keys in the keypad area are active.
 Caps Lock	Turns on when the letters appear in uppercase as you type. The Shift key lowers the case of typed letters when Caps Lock is on.	Turns off when letters appear in lower case as you type (unless if you hold down the Shift key).

 Scroll Lock















Turns on when the screen scrolls differently. (depends on the application. No effect in many applications.)

Turns off when information moves across the display normally.

 Some functions are not available until Windows launches.

 *You can carry out these functions using the Jog Dial. See your Software Guide in "Setting up Jog Dial" for more information.

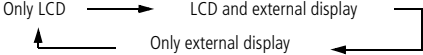
Combinations and Functions with the Fn Key

Combinations/ Feature	Functions
Fn+  (ESC) System Suspend	Puts the system into System Suspend mode, a power management state. To return the system to the active state, press any key.
Fn+  (F3)* Speaker switch	Toggles the built-in speaker on and off.
Fn+  (F4)* Speaker volume	Adjusts the built-in speakers' volume. To increase volume, press Fn+F4 and then  or  To decrease volume, press Fn+F4 and then  or 
Fn+  (F5) * Brightness control	Adjusts the brightness of the LCD. To increase light intensity, press Fn+F5 and then  or  To decrease light intensity, press Fn+F5 and then  or 
Fn+  (F7) Switch to the external display	Toggles between the LCD, external display (connected to the Monitor connector) and both LCD and external display. 
Fn+  (F12) System Hibernation	Provides for the lowest level of power consumption. When you execute this command, the states of the system and of the peripheral devices are written to the hard disk and the system power is turned off. To return the system to its original state, use the power switch to turn on the power.

<i>Combinations/ Feature</i>	<i>Functions</i>
Fn+B Bass Boost	Toggles the Bass Boost function off and on. This feature is available with headphones only.
Fn+D Video standby	Darkens the LCD in order to save power.
Fn+F Change Display size	Zooms the display size in or out when the display is set to a low resolution.
Fn+S System Idle	Puts the system into Idle mode, a power management state. To return to the active state, press any key.



Using the Jog Dial™

Your computer is equipped with a Jog Dial on the right side of your computer. You can turn or/and press the Jog Dial to scroll the window, select a software, adjust the internal speaker volume etc.

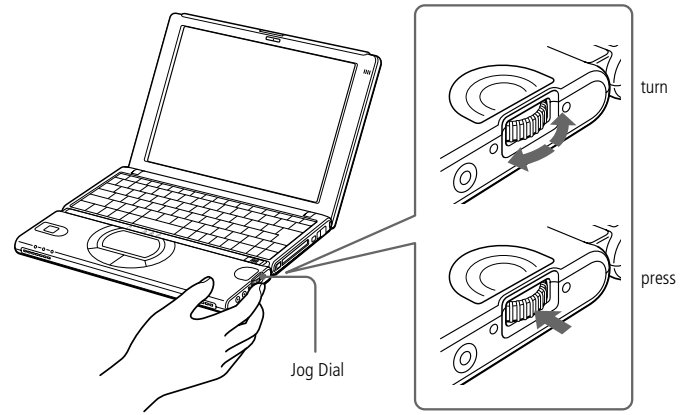

The Jog Dial window always appears in the display. The Jog Dial window is either in launcher mode or in guide mode.

Launcher mode

The Jog Dial window switches to the launcher mode if no software, program is in use, or when the Jog Dial window is active.

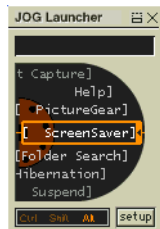



Jog Dial window in the launcher mode

Guide mode

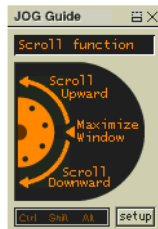
The Jog Dial is in the guide mode if a software or a program is in use and the window is active. Depending on the software, you can select an item from the selection list that is stratified by the List View mode, using the Jog Dial.



Jog Dial window in the guide mode

✎ You can adjust the size of the Jog Dial window or close it. To display the Jog Dial window, double-click  or  on the task tray.

To Use the Jog Dial

Launcher mode

Click the Jog Dial window or the on-screen display, or press the Jog Dial while pressing the Ctrl key to switch to the launcher mode.

- 1 Turn the Jog Dial to select an item, then press the Jog Dial. The Jog Dial window switches to the guide mode, and shows the Jog Dial's function.

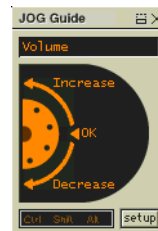
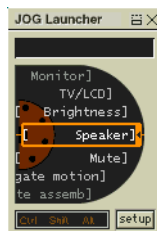

Jog Dial in the guide mode when "Speaker" is selected.

- 2 Turn or press the Jog Dial to use the Jog Dial's function.
- 3 To select another item, switch to the launcher mode and repeat from step 1.

See your Software guide in "Setting up Jog Dial" for more information.

Setup the Jog Dial settings

You can select the rotation direction, allocate functions to software that do not support the Jog Dial, or select the sound effects while using the Jog Dial, etc.

- 1 Click Setup in the Jog Dial window to display the Jog Dial Setup window.
- 2 Click the Configuration tab to display the Setup window.
To select the rotation direction: select "Upward" or "Downward" in the Spinning direction of the Jog Dial. The default setting is "Upward".
To allocate functions to software that do not support the Jog Dial: select the function you want to allocate to the software in "Software which are not compatible with the Jog Dial". The default setting is "Scroll function".
To select the display mode of the Jog Dial window: Check "Place the Jog Dial window above all" if you want to have the Jog Dial always displayed forward. If you remove the check, the Jog Dial window may hide behind other windows, but you can use it.
- 3 Click the Sound Setting tab to set the sound effect when using the Jog Dial. You can choose a WAVE file as sound effect. Click Browse to select the WAVE file. You can also set voice files you recorded as WAVE files.
To cancel the sound effect, remove the check in "Spin" and "Push".
- 4 Click OK.

Software that support the Jog Dial

If the Sony software supporting the Jog Dial is active, you can use the Jog Dial's functions allocated to each software.

See "Information on Using the Jog Dial" in your Software Guide.

Software that do not support the Jog Dial

If the software in use does not support the Jog Dial, you can scroll the window or adjust the window size as described below:

<i>Action</i>	<i>Description</i>
Turn the Jog Dial	Scrolls the window vertically. When several windows are displayed in the on-screen display, the last selected window will be scrolled.
Press the Jog Dial	Maximizes the size of the active window. Press again to return to its normal size.
Press Alt key and the Jog Dial	Minimizes the size of the active window. Press both Alt and the Jog Dial again to return to its normal size.
Press Shift key and the Jog Dial	Ends software or programs in use.



See Mouse Help for information on touchpad features, such as clicking both buttons simultaneously, adjusting touchpad speed, Web Assist, Tap Off, and Easy Launcher functions. To access Mouse Help, press the Start button, select Settings, and then select Control Panel. Click the Mouse icon in the Control Panel and click the Help button.

Using the Touchpad

The keyboard contains a cursor-pointing device called a touchpad. You can point to, select, drag, and scroll objects on the screen using the built-in touchpad.

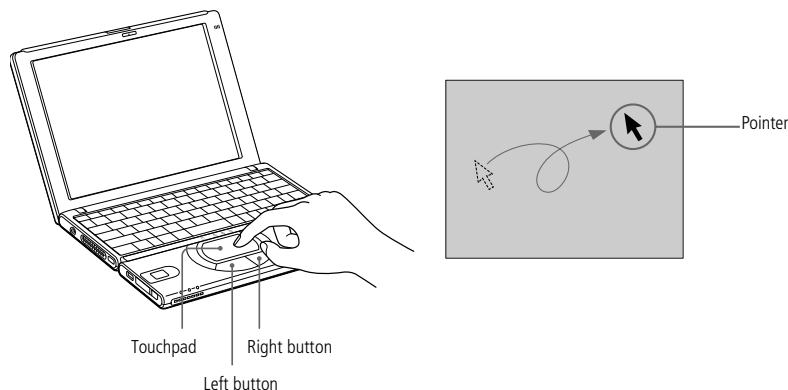

<i>Action</i>	<i>Description</i>
Point	Slide one finger on the touchpad to place the pointer on an item or object.
Click	Press the left button once.
Double-click	Press the left button twice.
Right-click	Press the right button once. In many applications, this action displays a shortcut menu of context-sensitive choices.
Drag	Slide one finger while pressing the left button.

Scroll	Move your finger along the right edge of the touchpad to scroll vertically. Move your finger along the bottom to scroll horizontally. (The scroll function is available only with applications that support a touchpad scroll feature.)
--------	---



! When copying data from one Memory Stick media to another Memory Stick media, use the drag and drop method to copy data. Do not use the Copy Disk function of Windows® as it may result in a malfunction of Memory Stick.

! Hold the Memory Stick media with the arrow pointing in the correct direction when you insert it into the slot. To avoid damaging the computer or the Memory Stick media, do not force the Memory Stick media into the slot if it does not insert smoothly.

📎 You can enjoy video clips that you have recorded with **Memory Stick**-compatible video camera recorders. For details, see your Software Guide.

Using Memory Stick™

This new compact, portable, and versatile IC recording medium has a data capacity exceeding that of a floppy disk. The Memory Stick™ is specially designed for exchanging and sharing digital data with compatible products. Because it is removable, it can be used for external data storage.

To insert a Memory Stick™

Insert it into the slot until the Memory Stick™ is fixed into the connector.

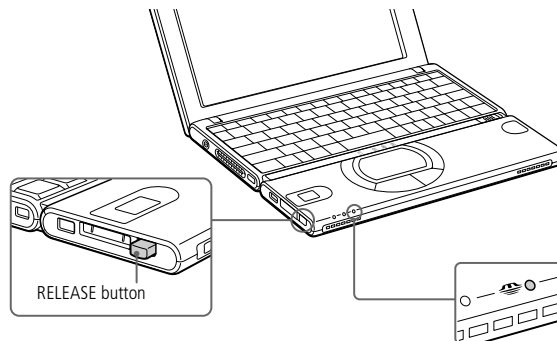

To confirm that the Memory Stick media is inserted correctly, check the Removable Disk (S:) drive.

- 1 On the desktop, double-click My Computer icon.
- 2 Make sure that the Removable Disk (S:) icon is displayed in the window.
- 3 Double-click the Removable Disk (S:) to display the contents of the Memory Stick media.

To remove a Memory Stick

- 1 Make sure that the Memory Stick media access indicator is off.
- 2 Push the Memory Stick media eject button.
- 3 When the button comes out, push the eject button again and remove the Memory Stick media.

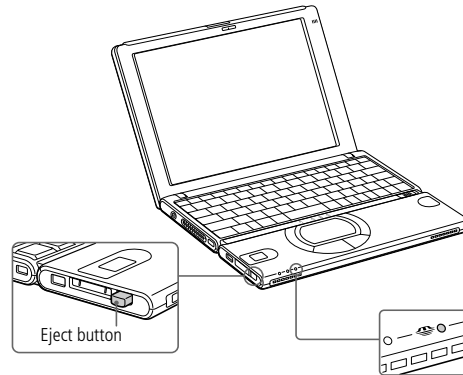

! To prevent the possible loss of data, do not remove a Memory Stick media when the Memory Stick media access light is on. Large image files require more time to store on a Memory Stick media, so always check the Memory Stick media access indicator and make sure that it is off before you remove the Memory Stick media.

 When the Memory Stick's™ erasure prevention switch is set to LOCK, data cannot be recorded or erased.

Before using Memory Sticks™, you should back up important data.

 To avoid damaging data:

Do not remove a Memory Stick™ or turn off the power while the access light is on.

Do not use Memory Sticks™ in locations that are subject to static electricity or electrical noise.

Do not touch the Memory Stick™ connector with your finger or metallic objects.

Do not attach labels other than the supplied label to a Memory Stick™.

Do not bend, drop, or apply strong shock to Memory Sticks™.

Do not disassemble or modify Memory Sticks™.

Do not allow Memory Sticks™ to get wet.

Do not use or store Memory Sticks™ in a location that is subject to:

- Extremely high temperatures, such as in a car parked in the sun
- Direct sunlight
- High humidity or places with corrosive substances

To prolong the life of Memory Sticks™, use the supplied storage case.

See the instructions that come with your Memory Stick™ for more information on use.

 When the computer is in System Suspend or System Hibernation mode, you cannot insert a disc.

The procedures for connecting the CD-ROM drive may vary, depending on the CD-ROM drive.

See the manual supplied with your CD-ROM drive for more information on use.

As no specific guarantee is supplied, your peripheral is covered by the guarantee of your notebook computer.

Contrarily to what is mentioned in the user guides, this configuration doesn't support Video CD.

CD-ROM Drive

You can use the CD-ROM drive supplied* with your notebook computer to read CD-ROMs, Audio CDs, CD Extras and Video CDs.

* Depending on the model, could be optional.

To remove the device

If you unplug this device from the computer when turned on, your system might crash and you might lose data that you didn't save before.

If your computer is turned off, you do not have to follow these instructions.

- 1 Double-click  in the task tray.
- 2 The window Unplug or Eject Hardware will appear.
- 3 Select the hardware you want to unplug, and click. Stop.
- 4 In the Stop a Hardware device dialog box, confirm the device to stop and click OK.
- 5 A Safe To Remove Hardware window will appear, confirming the device can be safely removed from the system. Click OK.
- 6 Click Close to close the Unplug or Eject Hardware window.
- 7 Remove the device safely.

 Some PC cards may require you to disable idle devices when using the PC card. You can use Sony Notebook Setup to disable devices. Please refer to "Sony Notebook Setup" in your Software Guide for details.

Be sure to use the most recent software driver provided by the PC card manufacturer.

If an "!" mark appears on the Device Manager tab in the System Properties dialog, remove the software driver and then reinstall it.

You may not be able to use some PC cards or some functions within the PC card with this computer.

You do not need to shut down the computer before inserting or removing a PC card.

Using PC Cards

Your computer includes a PC card slot. PC cards allow you to connect portable external devices.

Insert the PC card into the PC card slot, front label facing up. Gently push the card into the slot until the card is fixed into the connector.

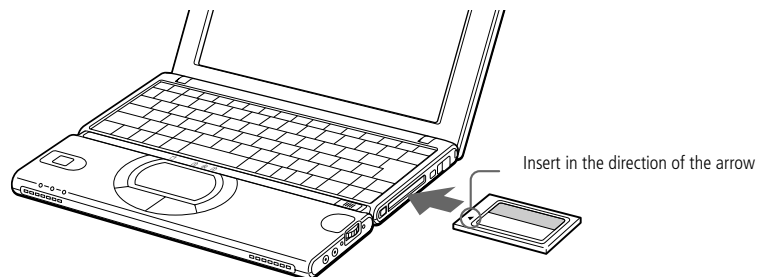

 Do not force a card into the slot. It may damage the connector pins. If you have difficulty inserting a card, check that you are inserting the card with the correct orientation. See the manual supplied with your PC card for more information on use.

For some PC cards, if you alternate between normal power operation and the system suspend or system hibernation power management modes while the card is inserted, you may find that a device connected to your system is not recognized. Reboot your system to correct the problem.

While the card is inserted, your computer may not enter the System Hibernation power management mode. It may enter the System Suspend mode. It is recommended to remove the card when your computer enters the System Hibernation mode by pressing Fn + F12 keys or by using the PowerPanel utility, and when it is set to enter the System Hibernation mode automatically while using a battery as the source of power.

Some devices may not function properly if you repeat Returning to Normal Mode from System Suspend Mode or System Hibernation mode. The computer will return to its original state if you restart it.

To remove the device

If you unplug this device from the computer when turned on, your system might crash and you might lose data that you didn't save before.

If your computer is turned off, you do not have to follow these instructions.

- 1 Double-click  in the task tray.
- 2 The window Unplug or Eject Hardware will appear.
- 3 Select the hardware you want to unplug, and click. Stop.
- 4 In the Stop a Hardware device dialog box, confirm the device to stop and click OK.
- 5 A Safe To Remove Hardware window will appear, confirming the device can be safely removed from the system. Click OK.
- 6 Click Close to close the Unplug or Eject Hardware window.
- 7 Eject the PC card release button and then press it to eject the card.
- 8 Gently grasp the card and pull it out.

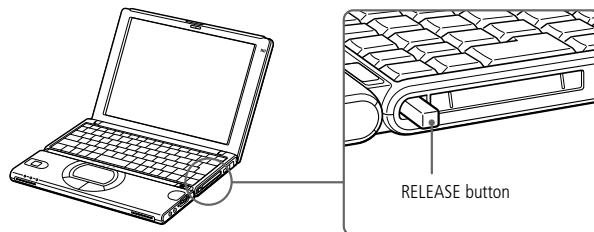

When you use Smart Connect to connect two VAIO computers, you must assign each computer a unique name by which it can be identified when the two computers are networked.

i.LINK cables compatible with your VAIO notebook include cables with the following part numbers: VMC-IL4415 (a 1.5 meter cable with a 4-pin connector at each end), VMC-IL4408A (a 0.8 meter cable with a 4-pin connector at each end).

Using Smart Connect and Smart Connect Monitor

With Smart Connect you can copy, edit or delete files on another VAIO computer (equipped with Smart Connect) connected to your computer with an i.LINK™ cable.

You can also print a document on a printer connected to another VAIO computer.

See the online documentation of Smart Connect and Smart Connect Monitor for more information.

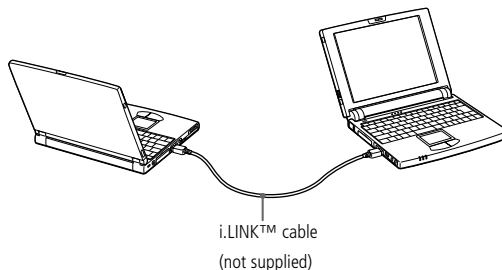

! When you connect for the first time two VAIO computers with the i.LINK™ cable, a dialog box appears and asks you for the location of the file SonyDev.dll.

To find this file and to copy it in the appropriate folder, do the following:

- 1- Type C:\WINNT\inf in the Copy files from box and click OK.
 - 2- The Files needed box still displays.
 - 3- Type C:\WINNT\inf again in the Copy files from box and click OK.
- Smart Connect will now work properly.

You can also find the solution on the VAIO Link website: <http://www.vaio-link.com>.

Click on the SR series, then click consecutively on Software / Troubleshooting / Smart Connect.

Using Power Saving Modes

When you use a battery as the source of power for your computer, you can take advantage of power management settings to conserve battery life. In addition to the normal operating mode, which allows you to turn off specific devices, your computer has three distinct power saving modes: System Idle, System Suspend and System Hibernation.

When using battery power, you should be aware that the computer automatically enters System Hibernation mode when the remaining battery charge drops below 7 percent, regardless of the power management setting you select. See your Software guide, in "Controlling Power Management" for more information.

 If the battery level falls to below 10 percent, you should either attach the AC adapter to recharge the battery or shut down your computer and insert a fully charged battery.

Normal Mode

This is the normal state of your computer when it is in use. The green power indicator light is on in this mode. To save power, you can turn off a specific device such as the LCD or the hard disk.

System Idle Mode

This mode is convenient if you don't need to use your computer for a short period. The hard disk and the video display enter a low power state and the CPU stops. The power indicator light is amber in this mode.

To activate System Idle mode

Press Fn+S. You can also enter system Idle mode by using the PowerPanel utility.

To return to normal mode

Press any key.

System Suspend Mode

The computer saves the current state of the system in RAM and switches off power to the CPU. The amber power light flashes in this mode.

To activate System Suspend mode

Press Fn+Esc, or slide the power switch quickly. You can also use the PowerPanel utility to enter System Suspend mode.

To return to normal mode

Press any key.

System Hibernation Mode

The state of the system is saved on the hard disk and power is turned off. The power indicator light is off in this mode.

To activate System Hibernation mode

Press Fn+F12. You can also use the PowerPanel utility to enter System Hibernation mode.

To return to normal mode

Turn on the computer by sliding the power switch. The computer returns to its previous state.

- ❑ Steps to return to normal mode:
System hibernation ▶ System suspend ▶ System Idle
System suspend requires less time than System hibernation.
- ❑ Power consumption:
System idle ▶ System suspend ▶ System hibernation
System idle uses more power than System hibernation.

🔑 If you slide the power switch and hold for more than four seconds, the computer will switch off automatically.

🔑 When returning from System Hibernation mode, the system status stored on the hard disk is erased and the computer starts normally if you slide the power switch and hold for more than four seconds.

Connecting peripheral devices

You can add functionality to your computer by connecting or using any of these peripherals and enjoy the software described in the “About the Software” user guide:

- ❑ Connecting a Phone Line (page 48)
- ❑ Universal Serial Bus (USB) Device (page 49)
- ❑ Floppy Disk Drive (page 50)
- ❑ Printer (page 53)
- ❑ External Display (page 54)
- ❑ i.LINK™ device (page 57)
- ❑ External Speakers (page 59)
- ❑ External Microphone (page 60)

 Your computer cannot be connected to a coin-operated telephone, and may not work with multiple phone lines or a private branch exchange (PBX). Some of these connections may result in excess electrical current and could cause a malfunction in the internal modem.

Phone cable and connectors are TNV (Telecommunications Network Voltage), according to EN60950.

If you connect the modem to a parallel connected phone line, the modem or the other connected device may not function properly.

* A country-specific phone plug is supplied with your VAIO notebook computer, allowing you to plug the phone line into the wall jack.

Using the Modem

Your notebook computer is equipped with an internal modem. For further details on setting up the modem for use, see "Configuring the Modem" in your Software Guide.

Connecting a Phone Line

You need to connect a phone line to take advantage of online services and the Internet, to register your computer and software online, and to contact VAIO-Link.

- 1 Plug one end of the phone cable into the phone line jack on the computer.

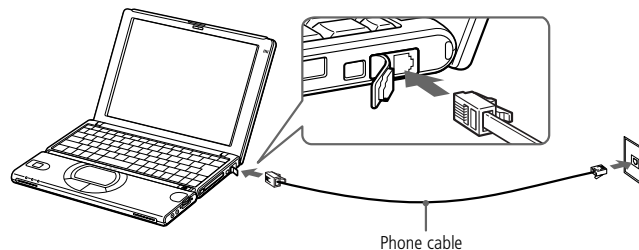

- 2 Plug the other end into the wall jack. *

See the manual supplied with your peripheral for more information on installation and use.

When you start your notebook computer with a USB hub connected to it, make sure that a device is connected to the USB hub. If you encounter problems booting when a USB hub is connected to your notebook computer, please unplug the hub and reboot.

Universal Serial Bus (USB) Device

You can connect a USB device to your computer.

To connect a USB device

- Use the  symbol to locate the USB connector. Plug one end of the USB cable into this port and the other end into the USB device.

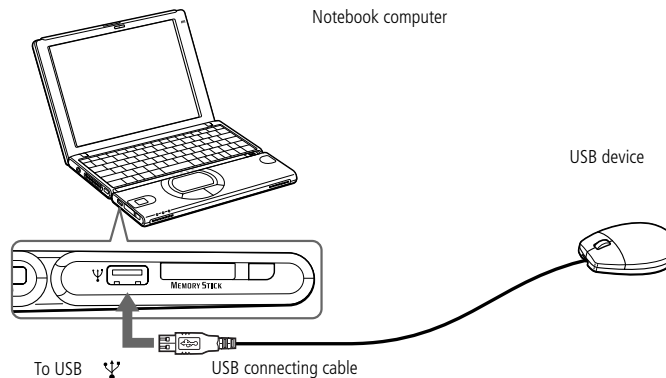

Floppy Disk Drive

You can connect an optional USB floppy disk drive to the USB connector on your computer:

To connect the floppy disk drive

Plug the USB cable into the USB connector. The VAIO logo on the disk drive should be facing up.

You do not need to shut down the computer before connecting or disconnecting a USB peripheral.

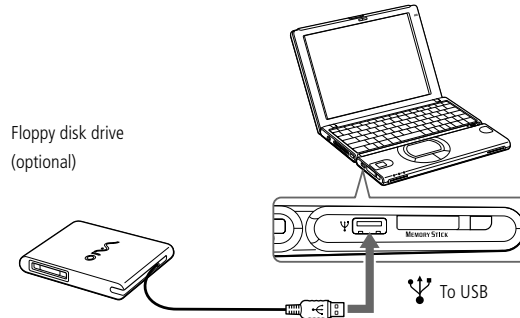

Floppy disk drive
(optional)



Floppy Disk Drive

To insert a diskette

- 1 Hold the diskette with the label side facing up.
- 2 Gently push the diskette into the drive until it clicks into place.

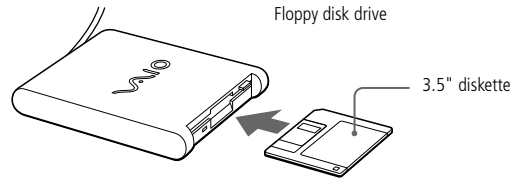
*To remove a diskette*

When you finish using the diskette, wait until the LED indicator turns off and then press the Eject button to remove the diskette.

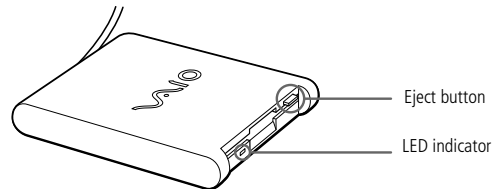
*To remove the device*

If you unplug this device from the computer when turned on, your system might crash and you might lose data that you didn't save before.

If your computer is turned off, you do not have to follow these instructions.

- 1 Double-click  in the task tray.

 Do not press the Eject button while the LED indicator is on. It may damage the diskette.

If the diskette does not come out by pressing the Eject button, disconnect the floppy disk drive from the computer.

- 2 The window Unplug or Eject Hardware will appear.
- 3 Select the hardware you want to unplug, and click Stop.
- 4 In the Stop a Hardware device dialog box, confirm the device to stop and click OK.
- 5 A Safe To Remove Hardware window will appear, confirming the device can be safely removed from the system. Click OK.
- 6 Click Close to close the Unplug or Eject Hardware window.
- 7 Remove the device safely.

To carry the floppy disk drive

Fold the floppy disk cable into the compartment on the side of the floppy disk drive.



See the manual supplied with your peripheral for more information on installation and use.

Printer

You can connect a Windows-compatible printer to your computer to print documents.

To connect a printer using the USB connector

You can connect a USB printer compatible with your version of Windows® to your computer.

- ❑ Use the  symbol to locate the USB port on your computer and printer.
- ❑ Plug an optional USB printer cable into the USB connector.

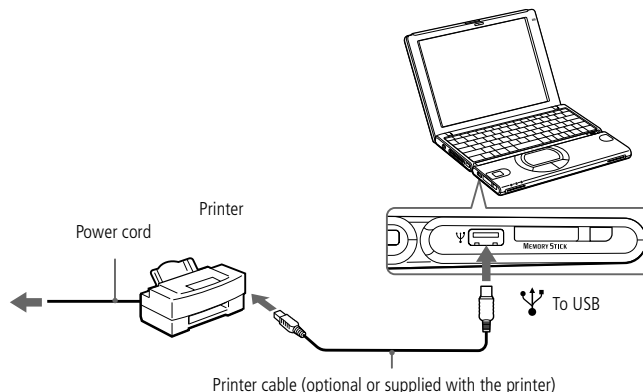

Turn off your computer and the peripherals, unplug the AC adapter and the power cord before connecting the external display.

Connect the power cord after connecting all other cables.

Turn on the peripherals, then turn on your computer.

Some computer displays or projectors may not be used as a monitor with the LCD on your computer display at the same time.

See the manual supplied with your computer display for more information on installation and use.

External Display

You can connect an external display to your notebook computer. For example, you can use the computer with any of the following:

- ❑ Computer display (monitor)
- ❑ Projector.

To connect a computer display

Use the supplied Display Adapter to connect your external display to the computer.

- 1 Plug the supplied Display Adapter into the computer's Monitor connector and the display cable to the Display Adapter.
- 2 If necessary, plug one end of the display power cord into the display, and the other end into an AC outlet.

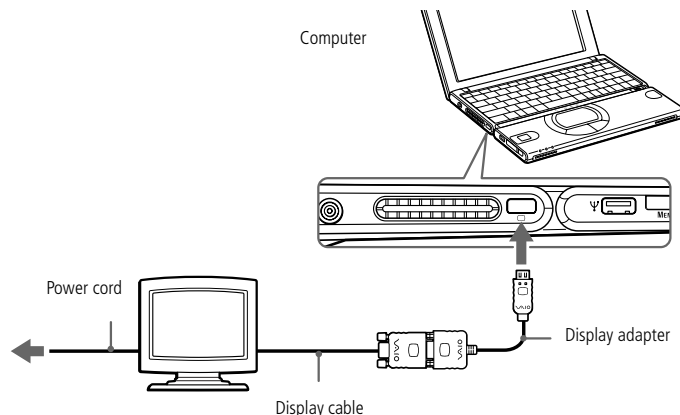

External Display

See the manual supplied with your projector for more information on installation and use.

You may not be able to display the computer's LCD and the external display together, depending on the types of computer display and projector used.

To connect a projector

You can use a projector as an external display, such as the Sony LCD Projector.

You can connect a projector using the supplied Display Adapter.

- 1 Plug the Display Adapter into the computer's Monitor connector and the display signal cable to the Display Adapter.
- 2 Use the  symbol to locate the Earphone connector. Plug the speaker audio cable into this connector.

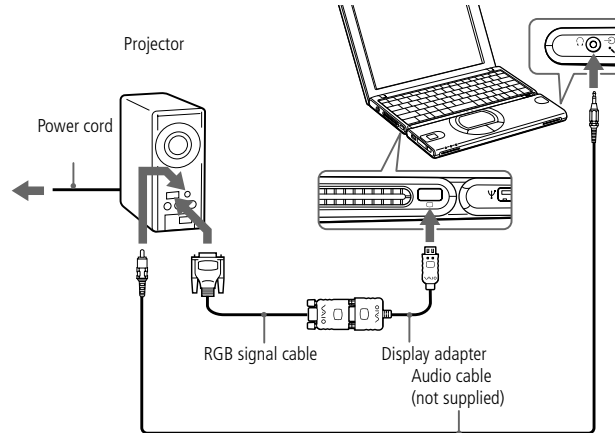

To remove the display adapter

Press both sides of the display adapter connector and unplug it from the computer.

External Display

To select a display

When you connect an external display to the monitor connector, you can press Fn+F7 to toggle the output between the Liquid Crystal Display (LCD), the external monitor, or both devices.

See your Software guide in “Selecting the Display Mode” for more information.



i.LINK™ device

✎ The software limits the use of more than one digital video camera recorder or i.LINK™ device at the same time.

On Sony digital video cameras, connectors labeled "DV Out", "DV In/Out" or "i.LINK™" are i.LINK™-compatible.

The i.LINK™ connector of your notebook computer does not supply power to external devices generally powered by i.LINK™ connectors.

The i.LINK™ connector supports transfer rates up to 400 Mbps; however, the actual transfer rate depends on the transfer rate of the external device.

The i.LINK™ features available may vary depending on the software applications you use. Please refer to the documentation that came with your software for more information.

i.LINK™ device

Your computer includes an i.LINK (IEEE1394) connector, which you can use to connect to an i.LINK™ device such as a digital video camera recorder.

To connect a digital video camera recorder

- 1 Plug one end of the i.LINK™ cable into the i.LINK™ connector of the computer and the other end into the DV Out connector on the digital video camera recorder.

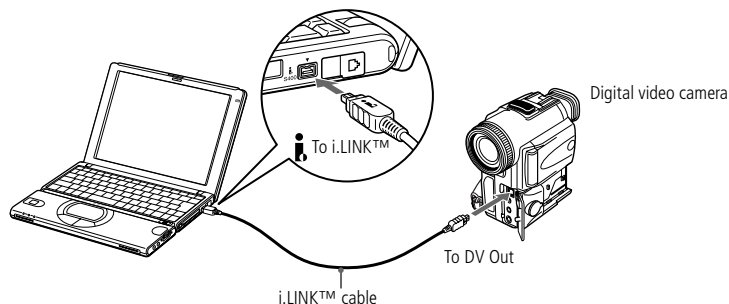

- 2 Launch the DVgate application. Please refer to "DVgate" in your Software Guide for further details.

✎ The Sony digital video camera recorder is taken as example; your digital video camera recorder may need to be connected differently.

See the manual supplied with your digital video camera recorder for more information on installation and use.

Do not connect more than one digital video camera at a time. The software supplied with your computer will not recognize multiple cameras.

For a list of i.LINK™ cables compatible with your computer, please contact your dealer.

Memory Sticks™

If your digital video camera recorder includes a Memory Stick™ slot, you can copy images from it to your computer via a Memory Stick™.

Copy images on the Memory Stick™ and insert the card into the Memory Stick™ slot.

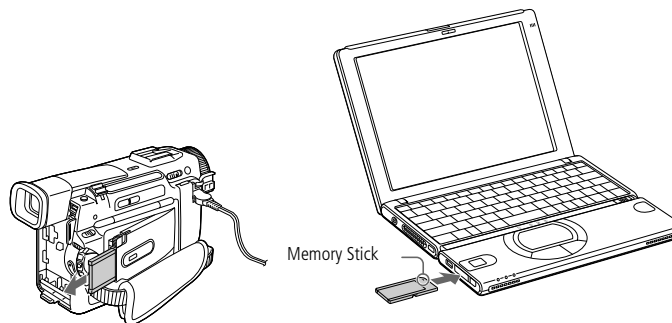

See "Using Memory Stick™" on page 38.

Make sure your speakers are designed for computer use.

Turn down the volume of the speakers before you turn them on.

Do not place diskettes on the speakers; the speaker's magnetic field may damage the data on the diskettes.

See the manual supplied with your speakers for more information on installation and use.

External Speakers

You can enhance the sound quality of your computer by connecting external speakers.

To connect external speakers

- Use the  symbol to locate the Headphone connector. Plug the speaker cable into this connector.

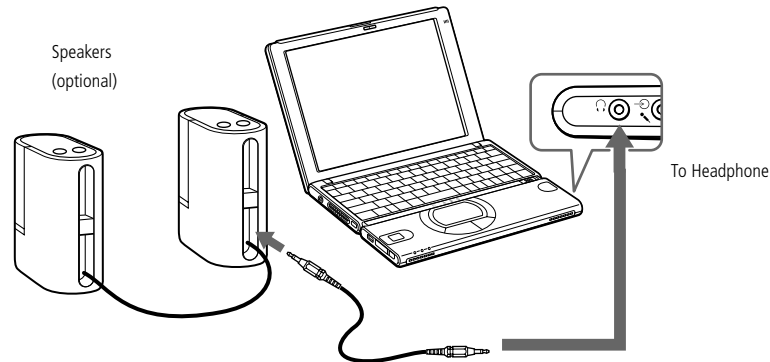

External Microphone

Make sure your microphone is designed for computer use.

See the manual supplied with your peripheral for more information on installation and use.

External Microphone

You can enhance the quality of sound input by using an external microphone.

To connect an external microphone

- Use the  to locate the Line-in connector. Plug the microphone cable into this connector.

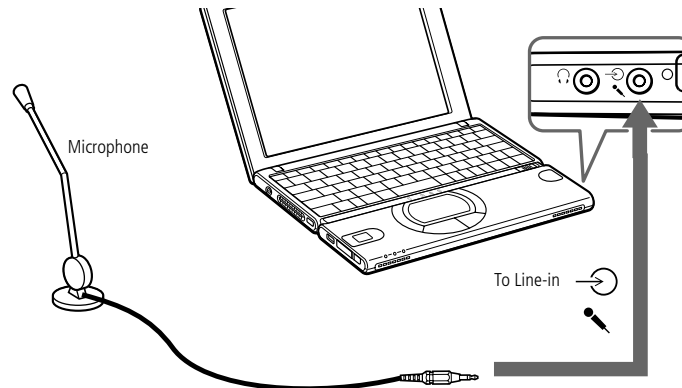

Getting Help

This section describes how to get help and support from Sony, as well as troubleshooting tips for your computer.

See also the on-line FAQ provided on your Documentation CD-ROM.

About Sony's Support Options

Sony provides several support options for your computer. When you have questions about your computer and the pre-installed software, check these places for answers:

Printed documentation supplied with your computer

- ❑ The Customer Guide explains how to start your computer and use the basic functions. This guide gives you the information to access VAIO-Link.
- ❑ The Setting Up Poster gives you a list of the contents you find in the box, a summary of the bundled applications and the list of specifications of your computer and accessories.

On-line user guides supplied with your Documentation CD-ROM

- ❑ This guide explains how to use your computer, connect peripheral devices. It gives you a packing list and the list of specifications of your computer and accessories.
 - ❑ The Software guide lists the pre-installed software titles and explains how to use the utility programs and perform basic computer tasks.
 - ❑ The Customer Service Guide gives you complete information on communicating with VAIO-Link Response Centre.
-

 You need to plug in the Modem and the phone line to use the communication features described in this manual.

Other sources of information

- The online help files that accompany your pre-installed software contain instructions on using the software.
- VAIO-Link: if you have any problem with your computer, you can access the VAIO-Link web site (see your Customer Service Guide for addresses). Before contacting VAIO-Link, try to solve the problem by reading your User Guide (troubleshooting chapter) or the manuals and helpfiles for the peripherals or software.
- The Sony e-mail support service answers your questions by electronic mail. Just send your question in an e-mail message and a Customer Service Analyst will send you a reply with the answer.
To send a question to Sony e-mail support, please refer to the instructions in your Customer Service Guide.



✎ When you reconnect devices (other than USB devices), be sure to turn off the computer as described in "Shutting down your computer".
If you turn off the computer in other ways, it may result in data loss.

Troubleshooting

This section describes how to solve common problems you may encounter when using your computer. Many problems have simple solutions, so try these suggestions before you contact VAIO-Link.

Table of troubleshooting methods

- About the computer and software, see page 63
- About Digital Video Captures and DVgate, see page 66
- About the display, see page 67
- About sound, see page 67
- About the modem, see page 68
- About CD-ROMs and diskettes, see page 70
- About peripherals, see page 71

See also the on-line FAQ provided on your Documentation CD-ROM.

About the computer and software

My computer does not start

- Check that the computer is plugged into a power source and that it is turned on. Check that the power indicator on the front panel of the computer indicates that the power is on.
- Check that the battery packs are inserted properly and that they are charged.
- Make sure there is no diskette in the floppy disk drive.
- Confirm that the power cord and all cables are connected firmly.

- ❑ If you have plugged the computer into an UPS, make sure the UPS is turned on and working.
- ❑ If you are using an external display, check that it is plugged into a power source and turned on. Check that you have switched to the external display and that the brightness and contrast controls are adjusted correctly. Please refer to the manual supplied with your display for details.
- ❑ Moisture condensation may have occurred. Do not use the computer for at least one hour and then turn it on.
- ❑ When the internal backup battery is low on power, it may not be able to start your system properly.
The message “Press <F1> to resume, <F2> to setup” would appear at the bottom of the display. Should this happen, you need to initialize the BIOS. Follow the steps in “The message “Press <F1> to resume, <F2> to setup” appears at startup”.

The message “Press <F1> to resume, <F2> to setup” appears at startup

- ❑ If the floppy disk drive is empty, follow the steps below to initialize the BIOS:
 - 1 Remove any peripheral devices connected to the computer.
 - 2 Turn the computer off and then turn it on again.
 - 3 Turn on the computer and press the F2 key when the Sony logo appears. The BIOS setup menu screen appears.
 - 4 Press the arrow keys to select the Exit menu.
 - 5 Press the arrow keys to select Get Default Values and then press the Enter key. The message “Load default configuration now?” appears.
 - 6 Check that [Yes] is selected and then press the Enter key.
-

7 Press the arrow keys to select Exit (Save Changes) and then press Enter.

The message “Save configuration changes and exit now?” appears.

8 Check that [Yes] is selected, then press the Enter key. The computer will restart.

My computer does not shut down

It is best to shut down your computer using the Shut Down command on the Windows® Start menu. Using other methods, including those listed here, may result in loss of unsaved data. If the Shut Down command does not work properly, follow these steps:

- ❑ Restart the computer by pressing Ctrl + Alt + Delete and by choosing Shut Down in the Task Manager.
- ❑ If this does not work, slide the power switch forward and hold it for at least four seconds, this turns off the power.
- ❑ Unplug the computer from the AC adapter and remove the battery pack from your computer.

My computer “locks up”

- ❑ Try restarting the computer. On the Windows® taskbar, click the Start button, click Shut Down, and then select Restart.
- ❑ If you cannot restart as described in the preceding step, you can restart the computer by pressing Ctrl+Alt+Delete once and then clicking Shut Down in the Windows Task manager.
- ❑ If the previous step does not work, slide the power switch toward the front and hold it for at least four seconds. This turns off the power.

- ❑ If your computer locks up while playing a DVD-ROM/ CD-ROM, stop the DVD-ROM/ CD-ROM, and restart the computer by pressing Ctrl+Alt+Delete as described above.

My software program "locks up" or crashes

Contact the software publisher or designated provider for technical support. Please refer to your Software guide for information on how to contact them.

My mouse doesn't work

- ❑ Check that the mouse is plugged into the USB connector.
- ❑ If you are using an optional Sony USB mouse, check that the appropriate driver and mouseware are properly installed.

My touchpad interprets a single tap as a double-click

Open the Mouse icon in the Control Panel and change the button assignments in the Mouse Properties dialog box. One of the buttons is assigned to the double-click action.

About Digital Video Captures and DVgate

While I'm recording images to a digital video device using DVgate, my system displays the message "Failed to record to DV deck, Please check deck's power status, cable connection..."

Close all open applications and restart your computer. Frequent recording of images to a digital video device while using DVgate sometimes causes this to occur. For more information on DVgate, see the DVgate online help.

About the display

My LCD does not display anything

- ❑ Check that the computer is plugged into a power source and that it is turned on. Check that the power indicator on the front panel of the computer is on.
- ❑ Check that the battery packs are inserted properly and that they are charged.
- ❑ Adjust the brightness of the LCD.
- ❑ The computer may be in LCD (video) standby mode. Press any key to activate the display.

The screen image on my external display is not centered or sized properly

Use the controls on your external display to adjust the image. Please refer to the manual supplied with your display for more information.

About sound

My speakers are not producing sound

- ❑ The built-in speakers may be turned off. Press Fn+F3 to turn on the speakers.
 - ❑ The speaker volume may be turned to the minimum. Press Fn+F4, and then press ▲ or ► to increase the volume.
 - ❑ If your computer is powered by battery, check that the battery is inserted properly and that it is charged.
 - ❑ If you are using an application that has its own volume control, check that the volume is turned up.
 - ❑ Check the volume controls in Windows®.
-

- ❑ If you use external speakers, check that the speakers are properly connected and the volume is turned up. If the speakers have a mute button, make sure it is off. If batteries power the speakers, check that the batteries are inserted properly and that they are charged.
- ❑ If you have connected an audio cable to the Headphone connector, disconnect the cable.

My microphone doesn't work

If you are using an external microphone, check that the microphone is plugged into the Microphone connector.

About the modem

My internal modem doesn't work

- ❑ Check that the phone line is plugged into your computer.
- ❑ Check that the phone line is working. You can check the line by plugging in an ordinary phone and listening for a dial tone.
- ❑ Check that the phone number the program is dialing is correct.
- ❑ In the Phone and Modem Options dialog (Control Panel / Phone and Modem Options), check that your modem is listed on the Modems tab, and that the location information is correct on the Dialing Rules tab.

My Modem Cannot Establish a Connection

The modem dialing mode may be incompatible with your telephone line.

To verify the modem settings, see "Configuring the modem for use" in your Software Guide.

My modem connection is slow

Many factors influence modem connection speed, including telephone line noise or compatibility with telephone equipment (such as fax machines or other modems). If you think your modem is not connecting properly to other PC-based modems, fax machines, or your Internet Service Provider, check the following:

- ❑ Have your phone company check that your phone line is free from any line noise.
- ❑ If your problem is fax-related, check that there are no problems with the fax machine you are calling and that it is compatible with fax modems.
- ❑ If you are having a problem connecting with your Internet Service Provider, check that the ISP is not experiencing technical problems.
- ❑ If you have a second phone line available, try connecting the modem to that line.



About CD-ROMs and diskettes

My CD-ROM drive tray does not open

- ❑ Make sure the computer is turned on.
- ❑ Press the Eject button on the CD-ROM drive.
- ❑ If the Eject button does not work, you can open the tray by inserting a sharp, pointed object into the hole to the right of the Eject button.

I can't play a CD-ROM disc

- ❑ Make sure the label of the CD-ROM is facing up.
- ❑ If the CD-ROM disc requires software, make sure the software is installed according to the program's instructions.
- ❑ Check the volume of your speakers.
- ❑ Clean the CD-ROM disc.
- ❑ Moisture condensation may have occurred. Leave the computer for at least 1 hour while it is turned on.

When I double-click an application icon a message such as "You must insert the application CD into your CD-ROM drive" appears and the software does not start

- ❑ Some titles require specific files that are located on the application's CD-ROM disc. Insert the disc and try starting the program again.
- ❑ Make sure you place the disc in the tray with the label side facing up.

My floppy disk drive can't write to a diskette

- ❑ The diskette is write-protected. Disable the write-protect feature or use a diskette that is not write-protected.
- ❑ Check that the diskette is properly inserted into the floppy disk drive.

When I remove the Memory Stick, an error message appears.

- ❑ Insert the Memory Stick™ into the slot again and press the Enter key. Wait until the active application finishes, then remove the Memory Stick™. If the message confirms eject of the Memory Stick™, click OK.

About peripherals

I cannot use DV devices. The message "DV equipment seems to be disconnected or turned off" appears.

- ❑ Check that the DV device is turned on and that the cables are properly connected.
- ❑ If you are using multiple i.LINK™ devices, the combination of the connected devices may cause unstable operation. In this case, turn off the power to all connected devices and disconnect unused devices. Check the connection and then turn on the power again.

My PC card is not working

- ❑ Make sure the PC card is compatible with your version of Windows®.

I cannot print.

- ❑ Check that all the cables of the printer are correctly connected.
- ❑ Check that your printer is correctly configured and that you have up to date drivers. If needed, contact your dealer.

The i.LINK device, which is connected to the computer, is not recognized. Or a message appears.

Disconnect the i.LINK device once, then connect it again.

Notes on Use

This section describes safety guidelines and precautions to help protect your computer from potential damage.

On Upgrading the System

Your notebook computer and memory modules use high precision components and electronic connectors' technology. To avoid the invalidation of your Guarantee by mishandling, it is recommended that:

- ❑ you contact your dealer to install a new memory module,
- ❑ you do not install it yourself, if you are not familiar with upgrading memory on a notebook computer,
- ❑ you do not touch the connectors or open the memory panel.

Please call VAIO-Link if you need assistance.



Adding Memory

In the future you may want to install memory modules to expand the functionality of your computer. You can increase the memory by installing optional memory modules.

Precautions

On handling

Be careful when adding memory. Mistakes on installation or removal of the memory module may cause a malfunction.

Electrostatic discharge can damage electronic components. Before touching a memory expansion board, ensure the following:

- ❑ Handle the Memory Module gently.
- ❑ The procedures described in this instruction manual assume familiarity with the general terminology associated with personal computers and with the safety practices and regulatory compliance required for using and modifying electronic equipment.
- ❑ Disconnect the system from its power source and from any telecommunications links, networks, or modems before you open the system or do any of the procedures described in “Installing the memory Module”. Failure to do so may result in personal injury or equipment damage.
- ❑ Electrostatic Discharge (ESD) can damage Memory Modules and other components. Perform the procedures described in “Installing the memory Module” only at an ESD workstation. If such a station is not available, do not work in a carpeted area, and do not handle materials that produce or hold static electricity (cellophane wrappers, for example). Ground yourself by maintaining

contact with an unpainted metal portion of the chassis while performing the procedure.

- ❑ Do not open the memory module package until you are ready to install the module. The package protects the module from ESD.

On keeping

Use the special bag delivered with the memory module or wrap the module in aluminium foil to protect it from electrostatic discharge.

Do not place the memory module in places subject to:

- ❑ Heat sources such as radiators or air ducts
- ❑ Direct sunlight
- ❑ Excessive dust
- ❑ Mechanical vibration or shock
- ❑ Strong magnets or speakers that are not magnetically shielded
- ❑ Ambient temperature of more than +35°C or less than +5°C
- ❑ High humidity



When you turn the palm rest over, gently perform the action in order to avoid breaking the attached cable.

To avoid damaging the computer, do not remove or loosen any other screws.

To install a memory module

- 1 Shut down your computer and disconnect all peripheral devices.
- 2 Unplug the computer and remove the battery packs.
- 3 Wait until the computer cools down. The interior of the notebook becomes extremely hot during operation. Wait at least one hour for the computer to cool down before you remove the screws.
- 4 Use a precision Phillips screwdriver that matches the size of the screw heads to remove the 6 screws from the bottom of the computer.

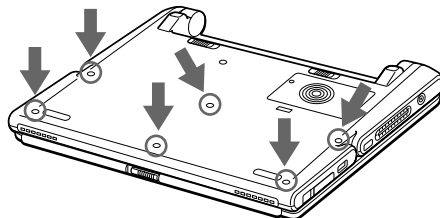

- 5 Slide the LCD lock lever and lift the cover, raise the palm rest toward you, turn it over, and then set it gently on the keyboard.

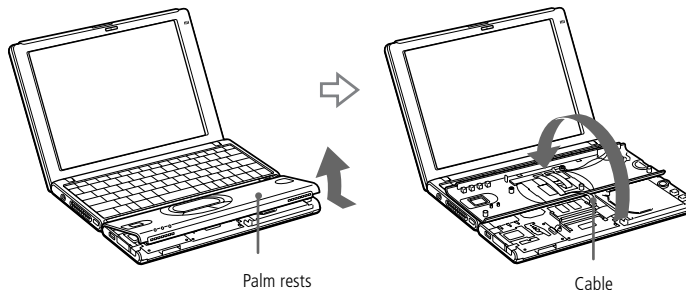

Adding Memory

! Do not touch any part of the motherboard or the other components inside the computer.

- 6 Before you remove the module from its package, touch a metal part of the computer to discharge any static electricity accumulated on your body. Remove the module from its protective package.
- 7 Install the memory module by holding the module edge connector pointing down and the notch on the right, and then insert it diagonally into an empty slot.
- 8 Lower the memory module until it clicks into place on both ends.

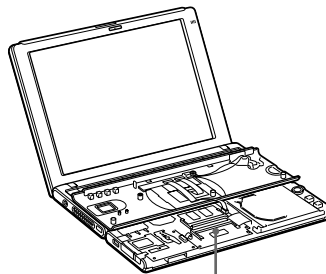

- ① Slide the memory module into the slot.
- ② Snap the connectors into place when the board is correctly seated.

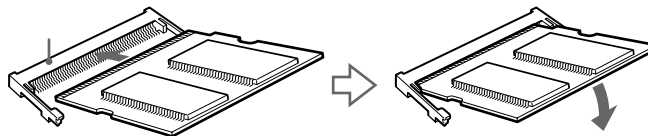

- 9 Return the palm rest to its original position by aligning it with the notch on the keyboard and then setting it on the keyboard. Handle the palm rest gently to avoid breaking the attached cable.

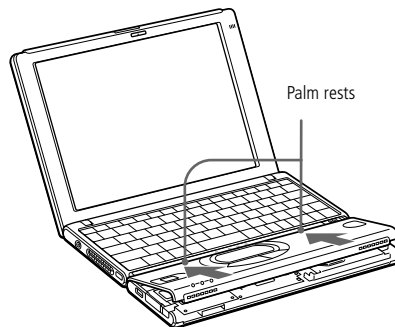

- 10 Close the display panel and replace the six screws on the bottom of the computer. Use the Phillips (+) screwdriver to tighten all six screws at the locations shown below.

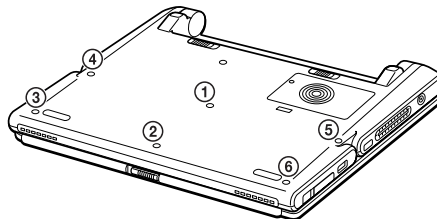

To remove a memory module

- 1 Turn off the computer and all peripheral devices. Disconnect the power cord and all cables from the computer, and then remove the battery packs.
- 2 Perform the steps 2 and 3 of "Installing a Memory Module".
The computer interior becomes extremely hot during operation. Wait about one hour for the computer to cool down before you remove the screws.
- 3 Remove the memory module.
Before you handle the memory module, touch a metal part of the computer to discharge any static electricity accumulated on your body.

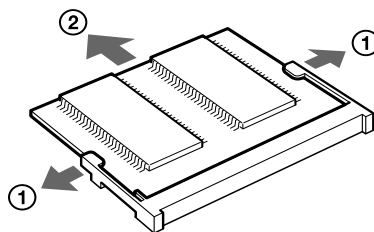

- ① Carefully press down on the release tabs on either end of the memory module at the same time.
- ② Pull out the memory module in the direction of the arrow.

- 4 Perform the steps 6 and 7 of "Installing a Memory Module".

To view the amount of memory

- 1 Turn on the computer.
- 2 Click the Start button, point to VAIO, and click "Sony Notebook Setup".
- 3 The Sony Notebook Setup screen appears.
- 4 Click the "About This Computer" tab to view the amount of system memory. If the additional memory does not appear, repeat the steps 1-9.



Other precautions

On Handling the LCD Screen

- ❑ Do not leave the LCD facing the sun as it can damage the LCD. Be careful when using the computer near a window.
- ❑ Do not scratch the LCD or exert pressure on it. This could cause malfunction.
- ❑ Using the computer in low temperature conditions may produce a residual image on the screen. This is not a malfunction. When the computer returns to normal temperature, the screen returns to normal.
- ❑ A residual image may appear on the screen if the same image is displayed for a lengthy period of time. The residual image disappears in a while. You can use a screen saver to prevent residual images.
- ❑ The screen becomes warm during operation. This is normal and does not indicate a malfunction.
- ❑ The LCD is manufactured using high-precision technology. You may, however, see tiny black points and/or bright points (red, blue, or green) that continuously appear on the LCD. This is a normal result of the manufacturing process and does not indicate a malfunction.

On the Power Source

- ❑ Your computer operates on 100V-240V AC 50/60 Hz.
 - ❑ Do not share the AC outlet with other power-consuming equipment, such as a copying machine or shredder.
 - ❑ You can purchase a power strip with a surge protector. This device prevents damage to your computer caused by sudden power surges such as those that may occur during an electrical storm.
-

Other precautions

- ❑ Do not place heavy objects on the power cord.
- ❑ To disconnect the cord, pull it out by the plug. Never pull the cord itself.
- ❑ Unplug your computer from the wall outlet if you will not be using the computer for a long time.
- ❑ When the AC adapter is not used, unplug it from the AC outlet.
- ❑ Use only the AC adapter supplied. Do not use any other AC adapter.

On Handling

- ❑ Clean the cabinet with a soft, dry cloth or a soft cloth lightly moistened with a mild detergent solution. Do not use any type of abrasive pad, scouring powder, or solvent such as alcohol or benzene, as these may damage the finish of your computer.
- ❑ Should any solid object or liquid fall into the computer, shut down your computer and then unplug it. You may want to have the computer checked by qualified personnel before operating it any further.
- ❑ Do not drop the computer or place heavy objects on top of the computer.



On Installation

- ❑ Do not place your computer in a location subject to:
 - ❑ Heat sources, such as radiators or air ducts
 - ❑ Direct sunlight
 - ❑ Excessive dust
 - ❑ Moisture or rain
 - ❑ Mechanical vibration or shock
 - ❑ Strong magnets or speakers that are not magnetically shielded
 - ❑ Ambient temperature of more than 35° C or less than 10° C
 - ❑ High humidity.
- ❑ Do not place electronic equipment near your computer. The computer's electromagnetic field may cause a malfunction.
- ❑ Provide adequate air circulation to prevent internal heat build-up. Do not place your computer on porous surfaces such as rugs or blankets, or near material such as curtains or draperies that may block its ventilation slots
- ❑ The computer uses high-frequency radio signals and may cause interference to radio or TV reception. Should this occur, relocate the computer a suitable distance away from the set.
- ❑ Use only specified peripheral equipment and interface cables; otherwise, problems may result.
- ❑ Do not use cut or damaged connection cables.
- ❑ Your computer cannot be connected to a coin-operated telephone, and may not work with a private branch exchange (PBX).

On Moisture Condensation

If the computer is brought directly from a cold location to a warm one, moisture may condense inside your computer. In this case, allow at least an hour before turning on your computer. If any problem occurs, unplug your computer and contact VAIO-Link.

On Handling Diskettes

- ❑ Do not open the shutter manually and touch the surface of the diskette.
- ❑ Keep diskettes away from magnets.
- ❑ Keep diskettes away from direct sunlight and other heat sources.

On Handling CD-ROM Discs

- ❑ Do not touch the surface of the disc.
- ❑ Do not drop or bend the disc.

On Cleaning CD-ROM Discs

- ❑ Fingerprints and dust on the surface of a disc may cause read errors. Proper care of the disc is essential to maintain its reliability. Do not use solvents such as benzine, thinner, commercially available cleaners or anti-static spray, as they may cause damage to the disc.
- ❑ For normal cleaning, hold the disc by its edge and use a soft cloth to wipe the surface from the center out.
- ❑ If the disc is badly soiled, moisten a soft cloth with water, wring it out well, and use it to wipe the surface of the disc from the center out. Wipe off any remaining moisture with a dry soft cloth.

On Handling Memory Stick™

- ❑ Do not touch the connector with your finger or metallic objects.
- ❑ Use only the label supplied with the Memory Stick as a label.
- ❑ Do not bend, drop, or apply strong shock to the Memory Stick.
- ❑ Do not disassemble or modify Memory Sticks.
- ❑ Do not let cards get wet.
- ❑ Do not use or store Memory Sticks in a location subject to:
 - Extremely high temperatures, such as in a car parked in the sun
 - Direct sunlight
 - High humidity or near corrosive substances
- ❑ Use the storage case supplied with the Memory Stick.

On Using Batteries

- ❑ Never leave the battery pack in temperatures above 60° C, such as in a car parked in the sun or under direct sunlight.
 - ❑ Battery life is shorter in a cold environment. This is due to decreased battery efficiency at low temperatures.
 - ❑ Charge the batteries at temperatures between 10° C to 30° C. Lower temperatures require a longer charging time.
 - ❑ While the battery is in use or being discharged, the battery pack heats up. This is normal and is not cause for concern.
 - ❑ Keep the battery pack away from all sources of heat.
 - ❑ Keep the battery pack dry.
 - ❑ Do not open or try to disassemble the battery pack.
 - ❑ Do not expose the battery pack to any mechanical shock.
-

Other precautions

- ❑ If you are not using the computer for an extended period of time, remove the battery pack from the computer to prevent damage to the battery.
- ❑ If, after fully charging the battery pack, the battery power is still low, the battery pack may be reaching the end of its life and should be replaced.
- ❑ You do not need to discharge the battery before recharging.
- ❑ If you have not used the battery pack for a considerable amount of time, recharge the battery.

On Using earphones

- ❑ Road safety – Do not use earphones while driving, cycling, or operating any motorized vehicle. It may create a traffic hazard and is illegal in some areas. It can also be potentially dangerous to play your earphones at high volume while walking, especially at pedestrian crossings. You should exercise extreme caution or discontinue use in potentially hazardous situations.
- ❑ Preventing hearing damage – Avoid using earphones at high volume. Hearing experts advise against continuous, loud and extended play. If you experience a ringing in your ears, reduce the volume or discontinue use.

On Maintenance

- ❑ Make sure to disconnect the power cord before cleaning the computer.
 - ❑ Avoid rubbing the LCD screen, as this can damage the screen. Use a soft, dry cloth to wipe the LCD screen.
 - ❑ Clean the computer with a soft cloth lightly moistened with a mild detergent solution. Do not use any type of abrasive pad, scouring powder or solvent such as alcohol or benzine.
-

Specifications

<i>Model Number</i>	<i>PCG-SR1K</i>
<i>Processor</i>	Mobile Intel® Pentium® III processor 500 MHz
<i>Hard Disk Drive</i>	9.0 GB
<i>Standard RAM</i>	64 MB SDRAM micro DIMM
<i>Maximum RAM</i>	256 MB
<i>LCD Screen</i>	10.4" XGA TFT poly-Si
<i>L2 Cache Memory</i>	256 KB (CPU integration)
<i>MPEG</i>	MPEG 1 Digital Video Supports full-screen playback
<i>Graphics</i>	128-bit accelerator with 3 MB Video RAM
<i>Sound Capabilities</i>	16-bit CD-quality stereo sound
<i>CD-ROM Drive</i>	CD-ROM 16x Laser Diode properties: Wave Length : 795 nm Laser Output: 16.5 μW
<i>Internal modem</i>	V.90/ K56 Flex (56 kbps) data / fax
<i>Telecommunication Capabilities</i>	PSTN data connectivity

<i>Model Number</i>	<i>PCG-SR1K</i>
<i>Expansion Capabilities</i>	One PCMCIA type II Card and Cardbus support.
<i>Built-In Capabilities</i>	Microphone, Stereo speakers, Touchpad, Jog Dial
<i>Special Button</i>	Jog Dial
<i>Connection Capabilities on Notebook</i>	External speakers, Headphone, Mic, USB, Type II PC Cards, i.LINK™ (IEEE1394) S400
<i>Supplied Accessories</i>	CD-ROM drive, rechargeable battery, AC adapter, AC cord, phone cable, phone plug, Display adapter.
<i>Service</i>	1 year free VAIO-Link Service ‡
<i>Guarantee</i>	1 year guarantee (parts and labour) ‡
<i>Power Requirement</i>	65 watts maximum (16V DC / AC100-240V)
<i>Power Management</i>	Energy Star compliant ACPI (Advanced Configuration and Power Interface).
<i>Battery</i>	6 cells Lithium ion
<i>Dimensions</i>	
<i>Width</i>	259 mm
<i>Height</i>	23.7 to 32.1 mm
<i>Depth</i>	209 mm

<i>Model Number</i>	<i>PCG-SR1K</i>
<i>Weight without AC adapter</i>	1.36 kg
<i>with AC adapter</i>	1.62 kg
<i>Operating Temperature</i>	+5°C → +35°C (temperature gradient less than 10°C/hour)
<i>Storage Temperature</i>	-20°C → +60°C (Temperature gradient less than 10°C/hour)
<i>Operating Humidity</i>	20% → 80% (Not condensed), provided that humidity is less than 65% at +35°C (hygrometer reading of less than 29°C)
<i>Storage Humidity</i>	10% → 90% (Not condensed), provided that humidity is less than 20% at +60°C (hygrometer reading of less than 35°C)

‡ See our special Guarantee extension conditions.

Specifications are subject to change without notice.

Index

A

- AC adapter **16**
- AC power **16**
- adding
 - hardware **47**
 - peripherals **47**
 - printers **53**
- air circulation **82**
- Alt key **25**
- Applications key **25**

B

- battery pack
 - charging **18**
 - connector **15**
 - inserting **17**
 - loading **17**
 - removing **20**
- battery packs **84**
 - charging **18**
 - indicator lights **14, 27**
 - inserting **17**
 - inserting into battery bay **17**
 - loading **17**
 - rechargeable **16**
- brightness
 - adjusting **21**
- buttons

- left **14**
- right **14**
- Start (Windows®) **22**

C

- cables
 - power cord **16**
- cameras
 - digital video recorder **57**
- canceling commands **25**
- Caps Lock **14**
 - indicator light **27**
- CD drive tray
 - troubleshooting **70**
- CD-ROM discs
 - cleaning **83**
 - handling **83**
 - troubleshooting **70**
- CD-ROM drive
 - connecting **42**
 - troubleshooting **70**
- charging battery pack **18**
- charging battery packs **18**
- choosing
 - power source **17**
- cleaning computer **81**
- computer
 - cleaning **81**
 - condensation **83**
 - lithium ion battery **5**
 - starting **21**

- troubleshooting **63, 65, 66**
- connecting
 - CD-ROM drive **42**
 - digital video recorder **57**
 - external speakers **59**
 - floppy disk drive **50**
 - microphone **60**
 - monitor **54**
 - network **42**
 - power source **16**
 - printer **53**
 - USB device **49**
- connectors
 - battery **15**
 - DC In **13, 16**
 - i.LINK **12**
 - keyboard **14**
 - microphone **12**
 - printer **53**
 - USB **13**
- Correction keys **24**
- correction keys **25**
- Ctrl key **25**
- cursor-movement keys **25**
- Customer Service Guide **61**
- customer support **62**
 - See also VAIO-Link **6**

D

- DC In **13, 16**
- digital video camera **57**

- diskettes
 - ejecting **51**
 - handling **83**
 - inserting into drive **51**
 - troubleshooting **70**
- drives
 - floppy disk **50**
- DV In/Out **12, 57**

E

- earphone **55**
- earphones
 - precautions **85**
- Eject button **51**
- ejecting
 - diskettes **51**
- ergonomic considerations **10, 11**
- Escape key **25**
- external devices
 - display **11**
 - See also monitor **54**
 - speakers **59**

F

- floppy disk drive
 - connecting **50**
 - troubleshooting **70**
- Fn key **25**
 - combination commands **29**
- Function keys **25**
- function keys **25**

G

- Guarantee **23**
- Guarantee card **23**

H

- handling
 - audio CDs **83**
 - CD-ROM discs **83**
 - diskettes **83**
- hard drives
 - indicator light **14**
- Help
 - Mouseware **36**
 - online **62**

I

- i.LINK **12, 57**
- IEEE1394 **12, 57**
- Indicator lights **27**
- indicator lights
 - battery **14, 27**
 - Caps Lock **14, 27**
 - hard drive **14**
 - Num Lock **14, 27**
 - power **14**
 - Scroll Lock **14, 28**
- Insert key **25**
- inserting
 - battery pack **17**
 - diskettes into drive **51**
- installing

- hardware **47**
- memory **42**
- peripherals **47**
- interference **82**

K

- keyboard **25**
 - connector **14**

L

- LCD **80**
 - lock lever **21**
 - troubleshooting **67**
- left button **14**
- lever
 - LCD **21**
- lithium ion battery
 - disposal **5**
 - safety precautions **5**
- loading
 - battery pack **17**

M

- maintenance **82, 85**
- Memory Stick **13, 38, 71**
- Memory Stick slot **38**
- microphone **12**
 - connecting **60**
 - troubleshooting **68**
- modem
 - troubleshooting **68**

moisture condensation **83**
monitor
 connecting **54**
 connector **55**
mouse
 troubleshooting **66**
Mouse Properties screen **36**

N

Navigation keys **25**
navigation keys **25**
network
 connecting **42**
Num Lock **14**
 indicator light **27**
numeric keypad area **24**

O

online help **62**
operator keys **25**
output devices
 adding **53**

P

packing list **61**
PC card **71**
 slots **12, 42**
 troubleshooting **71**
power **27**
 cord **16**
 indicator light **14**

 switch **21**
power saving modes **45**
 System Hibernation **29, 46**
 System Suspend **46**
 Video Standby **30**
power sources **17, 80**
 connecting **16**
precautions **82**
pre-installed software **61**
Print Screen key **25**
printer
 connecting **53**
 port **53**

R

radio interference **82**
rechargeable battery packs **16**
recharging battery pack **18**
recharging battery packs **18**
registering
 your computer **23**
Registering Your Computer **23, 24**
regulatory information **4**
removing
 battery pack **20**
 diskettes **51**
right button **14**

S

Scroll Lock **14**
 indicator light **28**

- selecting
 - power source **17**
- Shift key **25**
- Shut Down Windows dialog box **22**
- Smart Connect **44**
- Software guide **61**
- Sony e-mail support service **62**
- Speakers
 - volume **29**
- speakers
 - external **59**
 - troubleshooting **67**
- starting
 - computer **21**
- startup problems **22**
- System Hibernation mode **29, 46**
- System Suspend mode **29, 46**

T

- technical specifications **61**
- technical support **61, 62**
- Touchpad
 - accessing **36**
 - features **36**
- touchpad **14, 36, 66**
- troubleshooting **63**
 - startup **22, 63**
- turning on
 - computer **21**
- TV
 - interference **82**

U

- USB
 - connecting **49**
 - connector **13, 49**

V

- VAIO-Link **62**
 - response center **62**
 - software **62**
- ventilation **82**
- video camera **57**
- Video Standby mode **30**

W

- Windows
 - taskbar **65**
- Windows®
 - key **25**
 - key combinations **26**
 - Start button **22**