



User Guide

Personal Computer
VGN-A series/VGN-FS series

Contents

Before Use	6
Notice	6
ENERGY STAR	7
Documentation	8
Ergonomic Considerations	11
Getting Started	13
About the Indicator Lights	14
Connecting a Power Source	15
Using the Battery Pack.....	16
Shutting Down Your Computer Safely	23
Using Your VAIO Computer	24
Using the Keyboard.....	25
Using the Touch Pad.....	27
Using Special-function Buttons	28
Using the Optical Disc Drive	30
Using the TV Function (on Selected Models Only)	38
Using PC Cards	39
Using the Memory Stick Media	43
Using the Internet.....	47
Using Wireless LAN (WLAN)	48
Using the Bluetooth Functionality (on Selected Models Only)	57

Using Peripheral Devices	63
Connecting a Port Replicator	64
Using the Mouse (on Selected Models Only)	77
Connecting External Speakers	81
Using the Remote Commander	86
Connecting an External Display	89
Selecting Display Modes	97
Using the Multiple Monitors Function	100
Connecting an External Microphone	104
Connecting a Universal Serial Bus (USB) Device	105
Connecting a Printer	108
Connecting an i.LINK Device	110
Connecting to a Network (LAN)	112
Customizing Your VAIO Computer	114
Setting the Password	115
Setting Up Your Computer with VAIO Control Center	120
Using the Power Saving Modes	122
Managing Power with VAIO Power Management	127
Setting Up Your Language with Windows XP Professional	131
Configuring Your Modem	134
Setting a Sony Wallpaper	137
Installing and Upgrading Applications	138
Managing Drivers	143

Upgrading Your VAIO Computer.....	154
Adding and Removing Memory.....	155
Precautions	169
On Handling the LCD Screen.....	170
On Using the Power Source.....	171
On Handling Your Computer.....	172
On Handling Floppy Disks.....	174
On Handling Discs	175
On Using the Battery Pack.....	176
On Using Headphones.....	177
On Handling Memory Stick Media.....	177
On Handling the Hard Disk	178

Troubleshooting	179
Troubleshooting the optical disc drive.....	180
Troubleshooting PC Cards.....	184
Troubleshooting the modem	184
Troubleshooting the Bluetooth functionality	186
Troubleshooting Wireless LAN.....	189
Troubleshooting Power Management	192
Troubleshooting External Displays.....	193
Troubleshooting Sound (Speaker)	195
Troubleshooting Sound (Microphone).....	196
Troubleshooting Floppy Disks	198
Troubleshooting Printers.....	199
Troubleshooting i.LINK Devices.....	201
Support Options	202
Sony Support Information	202
e-Support	203
Trademarks.....	205

Before Use

Congratulations on your purchase of this Sony VAIO® computer, and welcome to the on-screen User Guide. Sony has combined leading-edge technology in audio, video, computing, and communications to provide state-of-the-art personal computing.

Notice

© 2005 Sony Corporation. All rights reserved.

This manual and the software described herein, in whole or in part, may not be reproduced, translated, or reduced to any machine-readable form without prior written approval.

Sony Corporation provides no warranty with regard to this manual, the software, or other information contained herein and hereby expressly disclaims any implied warranties or merchantability or fitness for any particular purpose with regard to this manual, the software or such other information. In no event shall Sony Corporation be liable for any incidental, consequential, or special damages, whether based on tort, contract, or otherwise, arising out of or in connection with this manual, the software, or other information contained herein or the use thereof.

Macrovision: This product incorporates copyright protection technology that is protected by U.S. patents and other intellectual property rights. Use of this copyright protection technology must be authorized by Macrovision, and is intended for home and other limited viewing uses only unless otherwise authorized by Macrovision. Reverse engineering or disassembly is prohibited.

In the manual, the ™ or ® marks are not specified.

Sony Corporation reserves the right to make any modification to this manual or the information contained herein at any time without notice. The software described herein is governed by the terms of a separate user license agreement.

Please note that the illustrations in this manual may not necessarily apply to your model. Please see the printed Specifications sheet for the specific configuration of your VAIO computer.

ENERGY STAR

As an ENERGY STAR Partner, Sony has determined that this product meets the ENERGY STAR guidelines for energy efficiency.

The International ENERGY STAR Office Equipment Program is an international program that promotes energy saving through the use of computers and their office equipment. The program backs the development and dissemination of products with functions that effectively reduce energy consumption. It is an open system in which business proprietors can participate voluntarily. The targeted products are office equipment such as computers, displays, printers, facsimiles and copiers. Their standards and logos are uniform among participating nations.

ENERGY STAR is a U.S. registered mark.



Documentation

Your Documentation contains printed information and user guides to read on your computer.

Guides are provided in PDF format, which you can easily browse through and print out.

The **My Club VAIO** portal is a perfect starting point to using your VAIO computer — a comprehensive collection of everything you need to get the most from your computer.

The user guides are collected under **Documentation**, which can be shown as follows:

- 1 Click **Start** and then the **My Club VAIO** icon .
- 2 Click **Documentation**.
- 3 Select the guide you want to read.



You can manually browse to the user guides by going to **My Computer > VAIO (C:) (your C drive) > Documentation > Documentation** and opening the folder for your language.

You may have a separate disc for the documentation of bundled accessories.

Printed Documentation

- ❑ **Specifications** sheet — Contains a table of specifications, a list of bundled software, an overview of all controls and ports and, on the reverse side, a guide to setting up your VAIO computer.
- ❑ **Troubleshooting Guide** — Contains solutions to common problems.
- ❑ **Recovery Guide** — Contains an explanation of how to recover your computer's system if you need to.
- ❑ Booklets containing the following information: **Sony Guarantee** conditions, **Safety Regulations**, **Modem Regulations** and **Wireless LAN Regulations**.

Non-printed Documentation

My Club VAIO

In **My Club VAIO** you can find:

Documentation, which gives you:

- ❑ Access to the **User Guide**. This manual explains the features of your VAIO in detail, how to use these features confidently and safely, connect peripheral devices and more.
- ❑ Access to **Help and Training**. This is the portal of **VAIO Help and Support Center**.
- ❑ Important information about your computer, in the form of notices and announcements.

In **My Club VAIO** you can also find:

- ❑ **Accessories**
Want to expand the capabilities of your VAIO? Click on this icon and have a look at your compatible accessories.
- ❑ **Software**
Feeling creative? Click this icon for an overview of your software and check out our upgrade options.
- ❑ **Wallpapers**
Click this icon and check out our most popular Sony and Club VAIO wallpapers.
- ❑ **Links**
Click this icon and check out our most popular Sony and Club VAIO web sites.

Help and Support Center

Help and Support Center is a comprehensive resource for practical advice, tutorials, and demonstrations to help you learn to use Microsoft Windows XP and your VAIO.

Use the Search feature, Index, or table of contents to view all Windows Help resources, including those that are on the Internet.

To access **Help and Support Center**, click **Start** and then **Help and Support**.

Further Sources

- ❑ Consult the **Online Help** files of the software you are using for detailed information on features and troubleshooting.
- ❑ Go to www.club-vaio.com to find online tutorials about your favorite VAIO software.

Ergonomic Considerations

You will be using your computer as a portable device in a variety of environments. Whenever possible, you should attempt to take account of the following ergonomic considerations to both stationary and portable environments:

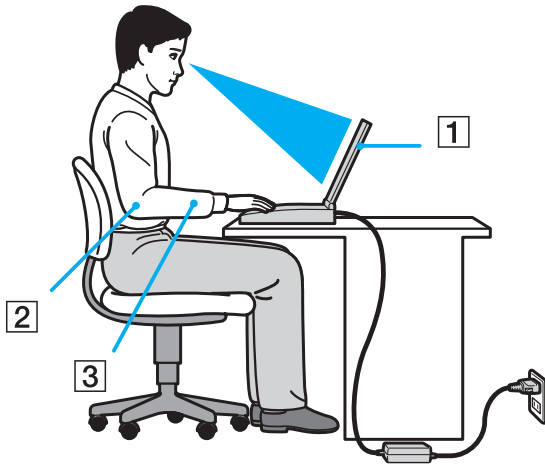

- ❑ **Position of your computer** – Place the computer directly in front of you (1). Keep your forearms horizontal (2), with your wrists in a neutral, comfortable position (3) while using the keyboard, touch pad, or external mouse. Let your upper arms hang naturally at your sides. Have breaks during sessions with your computer. Excessive use of the computer may strain muscles or tendons.
- ❑ **Furniture and posture** – Sit in a chair with good back support. Adjust the level of the chair so your feet are flat on the floor. A footrest may make you more comfortable. Sit in a relaxed, upright posture and avoid slouching forward or leaning far backwards.











- ❑ **Viewing angle of the computer's display** – Use the display's tilting feature to find the best position. You can reduce eye strain and muscle fatigue by adjusting the tilt of the display to the proper position. Adjust the brightness setting of the display as well.
- ❑ **Lighting** – Choose a location where windows and lights do not create glare and reflection on the display. Use indirect lighting to avoid bright spots on the display. You can also purchase accessories for your display that help reduce glare. Proper lighting adds to your comfort and work effectiveness.
- ❑ **Positioning an external display** – When using an external display, set the display at a comfortable viewing distance. Make sure the display screen is at eye level or slightly lower when you are sitting in front of the monitor.

Getting Started

This section describes how to get started with using your VAIO computer.

- ❑ **About the Indicator Lights** ([page 14](#))
- ❑ **Connecting a Power Source** ([page 15](#))
- ❑ **Using the Battery Pack** ([page 16](#))
- ❑ **Shutting Down Your Computer Safely** ([page 23](#))

About the Indicator Lights

Indicator	Functions
Power 	Illuminates when the power of the computer is on, blinks in Standby mode, and turns off when the computer is in Hibernate mode or off.
Battery 	Illuminates when the computer is using battery power, blinks when the battery is running out of power, and double-blinks when the battery is charging.
Memory Stick Pro/Duo 	Illuminates when data is read from or written to the Memory Stick media. (Do not enter Standby mode or turn off the computer when this indicator is on.) When the indicator is off, the Memory Stick media is not being used.
Optical disc drive  (VGN-A series only)	Illuminates when data is read from or written to the optical disc. When the indicator is off, the optical disc is not being used.
Mute  (VGN-A series only)	Illuminates when the volume is turned off.
Brightness  (VGN-A series only)	Illuminates when the screen is on maximum brightness intensity.
Hard disk 	Illuminates when data is read from or written to the hard disk. Do not enter Standby mode or turn off the computer when this indicator is on.
Num Lock 	Press the Num LK key to activate the numeric keypad. Press it a second time to deactivate the numeric keypad. The numeric keypad is not active when the indicator is off.
Caps Lock 	Press the Caps Lock key to type letters in uppercase. Letters appear in lowercase if you press the Shift key while the indicator is on. Press the key a second time to turn off the indicator. Normal typing resumes when the Caps Lock indicator is off.
Scroll Lock 	Press the Scroll Lock key to change how you scroll the display. Normal scrolling resumes when the Scroll Lock indicator is off. The Scroll Lock key functions differently depending on the program you are using and does not work with all programs.
Bluetooth	Illuminates when the WIRELESS switch is set to ON and Bluetooth technology is enabled.
WIRELESS LAN	Illuminates when the wireless LAN function is running.

Connecting a Power Source

You can use either an AC adapter or a rechargeable battery pack as a power source.

Using the AC Adapter

To use the AC adapter

- 1 Plug one end of the power cord (1) into the AC adapter.
- 2 Plug the other end of the power cord into an AC outlet (2).
- 3 Plug the cable attached to the AC adapter (3) into the DC In port (4) on the computer.

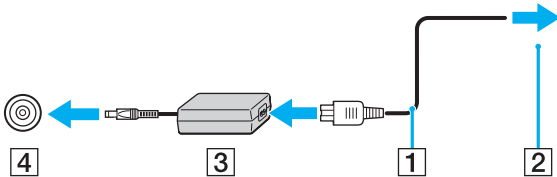

! The shape of the DC In plug varies depending on the AC adapter.



Use your computer only with the supplied AC adapter.

To disconnect your computer completely from AC power, unplug the AC adapter.

Make sure that the AC outlet is easily accessible.

If you do not use the AC adapter for a long period of time, put your computer into **Hibernate** mode. See **Using Hibernate Mode (page 125)**. This power saving mode saves you the time of shutting down in the normal way.

Using the Battery Pack

The battery pack supplied with your computer is not fully charged at the time of purchase.

Installing the Battery Pack

To install the battery pack

VGN-A series models

- 1 Turn off your computer and close the LCD screen lid.
- 2 Slide the **LOCK/UNLOCK** switch (1) on the bottom of the computer to the **UNLOCK** position.
- 3 Slide the **RELEASE** switch (2) on the bottom of the computer to the **RELEASE** position.

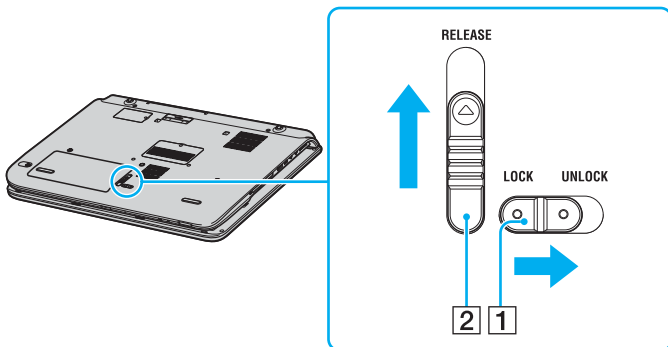

- 4 Remove the battery compartment cover.
- 5 Slide the battery in the battery compartment cover.

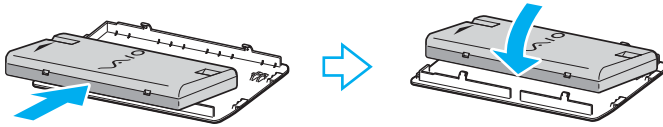

- 6 Turn over the battery attached to the battery compartment cover.
- 7 Insert the tab on the battery compartment cover into the notch, and push the battery down into the compartment until it clicks into place.
- 8 Slide the **LOCK/UNLOCK** switch to the **LOCK** position to secure the battery on the computer.

VGN-FS series models

- 1 Turn off your computer and close the LCD screen lid.
- 2 Slide the lock switch (1) to the **UNLOCK** position.

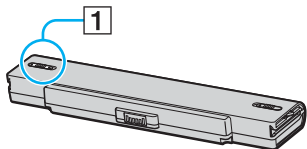

- 3 Slide the battery into the battery compartment until it clicks into place.

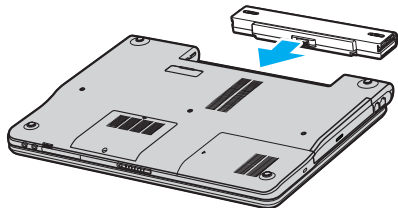

- 4 Slide the lock switch (1) to the **LOCK** position to secure the battery on the computer.

 When the computer is directly connected to AC power and has a battery pack installed, it uses power from the AC outlet.

Charging the Battery Pack

The battery pack supplied with your computer is not fully charged at the time of purchase.

To charge the battery pack

- 1 Install the battery pack.
- 2 Connect the AC adapter to the computer.
The computer automatically charges the battery (the battery indicator light flashes in a double blink pattern as the battery charges).

<i>Battery indicator light status</i>	<i>Meaning</i>
On	The computer is using battery power.
Blinks	The battery is running out of power.
Double blinks	The battery is charging.
Off	The computer is using AC power.



When the battery is running out of power, both the battery and power indicator lights blink.

Keep the battery pack in the computer while it is directly connected to AC power. The battery pack continues to charge while you are using the computer.

If the battery level falls below 10%, you should either attach the AC adapter to recharge the battery or shut down your computer and install a fully charged battery.

The battery pack supplied with your computer is a lithium ion battery and can be recharged any time. Charging a partially discharged battery does not affect battery life.

The battery indicator light is on while you use the battery pack as a power source. When the battery life is nearly depleted, both the battery and power indicator lights start flashing.

For some software applications and some peripheral devices, your computer may not enter **Hibernate** mode even when battery life is low. To avoid loss of data when using battery power, you should save your data frequently and manually activate a power management mode, such as **Standby** or **Hibernate**. If the battery wears out when your computer enters **Standby** mode, you will lose any unsaved data. Going back to the previous work state is impossible. To avoid loss of data, you should save your data frequently.

When the computer is directly connected to AC power and has a battery pack installed, it uses power from the AC outlet.

Removing the Battery Pack

To remove the battery pack

VGN-A series models

- 1 Turn off your computer and close the LCD screen lid.
- 2 Slide the **LOCK/UNLOCK** switch (1) on the bottom of the computer to the **UNLOCK** position.
- 3 Slide the **RELEASE** switch (2) on the bottom of the computer to the **RELEASE** position.
The right edge of the battery compartment cover is pushed up.

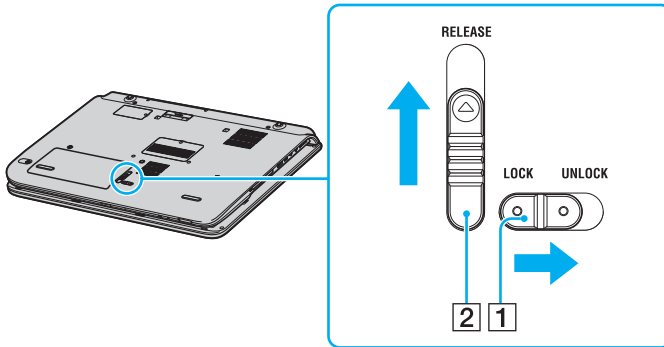

- 4 Raise the edge to remove the battery compartment cover.
- 5 Open the tabs on the battery compartment cover to release the battery and remove it from the battery compartment cover.
- 6 Insert the two tabs on the battery compartment cover diagonally into the notches and push the cover into the compartment until it clicks into place.

VGN-FS series models

- 1 Turn off your computer and close the LCD screen lid.
- 2 Slide the lock switch (1) to the **UNLOCK** position.

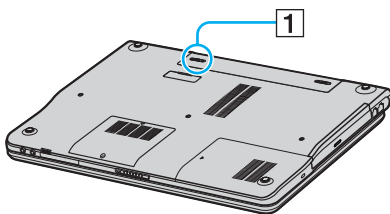

- 3 Slide and hold the release latch (2) and slide the battery away from the computer.

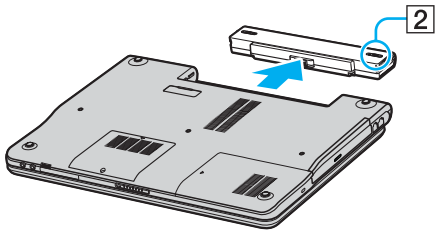

You may lose data if you remove the battery pack while the computer is on and not connected to the AC adapter or if you remove the battery while the computer is in **Standby** mode.

Shutting Down Your Computer Safely

To avoid losing unsaved data, be sure to shut down your computer properly, as described below.

To shut down your computer

- 1 Turn off any peripherals connected to your computer.
- 2 Click **Start** and then **Turn Off Computer**.
The **Turn off computer** window appears.
- 3 Click **Turn Off**.
- 4 Respond to any prompts warning you to save documents or to consider other users and wait for your computer to turn off automatically.
The power indicator light turns off.



See the printed **Troubleshooting Guide** if you have problems shutting down your computer.

Using Your VAIO Computer

Once you have read and followed the information in the printed **Specifications** sheet, you can start using your computer safely and confidently.

Read on to get the most out of using your VAIO computer.

- ❑ **Using the Keyboard** ([page 25](#))
- ❑ **Using the Touch Pad** ([page 27](#))
- ❑ **Using Special-function Buttons** ([page 28](#))
- ❑ **Using the Optical Disc Drive** ([page 30](#))
- ❑ **Using the TV Function (on Selected Models Only)** ([page 38](#))
- ❑ **Using PC Cards** ([page 39](#))
- ❑ **Using the Memory Stick Media** ([page 43](#))
- ❑ **Using the Internet** ([page 47](#))
- ❑ **Using Wireless LAN (WLAN)** ([page 48](#))
- ❑ **Using the Bluetooth Functionality (on Selected Models Only)** ([page 57](#))













Using the Keyboard



Your keyboard is very similar to a desktop computer's, but has additional keys that perform model-specific tasks.

For more information on the standard keys, see Windows **Help and Support Centre** and click on the **Customizing your computer** link.

The VAIO-Link web site (www.vaio-link.com) also contains glossary information to help you use the keyboard.

Combinations and Functions with the Fn Key

<i>Combinations/Feature</i>	<i>Functions</i>
Fn +  (F2): speaker switch (VGN-FS series only)	Turns on and off the built-in speakers and the headphones.
Fn +  (F3/F4): speaker volume (VGN-FS series only)	Adjusts the built-in speaker volume. To increase volume, press Fn+F4 and then  or  , or keep pressing Fn+F4 . To decrease volume, press Fn+F3 and then  or  , or keep pressing Fn+F3 .
Fn +  (F5/F6): brightness control	Adjusts the brightness of the LCD. To increase lightness intensity, press Fn+F6 and then  or  , or keep pressing Fn+F6 . To decrease lightness intensity, press Fn+F5 and then  or  , or keep pressing Fn+F5 .
Fn +  /  (F7): switch to the external display	Toggles between the LCD, external device (e.g. monitor) and both LCD and external device.

<i>Combinations/Feature</i>	<i>Functions</i>
Fn +  (F10): zoom (VGN-FS series only)	<p>Changes the screen resolution to magnify/restore the screen view.</p> <p> The default resolutions of the standard view and the magnified view are as follow: Standard view: 1280 x 800 pixels Magnified view: 1024 x 600 pixels</p> <p>The magnified view is not as clear as the standard view, as it is implemented by applying a lower resolution to the LCD screen with a higher resolution.</p> <p>This key combination is disabled during video playback. Make sure to quit such software before pressing the key combination.</p> <p>This key combination may not work with graphic images as it magnifies the screen view by changing the resolution.</p> <p>The location and size of software windows may change when the screen view is magnified or the standard view is restored because pressing this key combination changes the resolution.</p> <p>When the LCD screen view is magnified, switching the view to the external display disables the function and restores the standard view.</p>
Fn +  (F12): Hibernate	<p>Provides for the lowest level of power consumption. When you execute this command, the states of the system and of the peripheral devices are written to the hard disk and the system power is turned off. To return the system to its original state, use the power switch to turn on the power.</p> <p>For details on power management, see the section Using the Power Saving Modes (page 122).</p>



Some functions are not available until Windows is launched.

Using the Touch Pad

The keyboard contains a cursor-pointing device, your touch pad (1). You can point to, select, drag, and scroll objects on the screen using the touch pad.

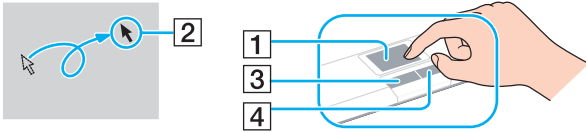





<i>Action</i>	<i>Description</i>
Point	Slide one finger on the touch pad to place the pointer (2) on an item or object.
Click	Press the left button (3) once.
Double-click	Press the left button twice.
Right-click	Press the right button (4) once. In many applications, this action displays a shortcut menu.
Drag	Slide one finger while pressing the left button.
Scroll	Move your finger along the right edge of the touch pad to scroll vertically. Move your finger along the bottom to scroll horizontally (the scroll function is available only with applications that support a touch pad scroll feature).

Using Special-function Buttons

Your VAIO computer is provided with special buttons to help you use specific functions of the computer.

VGN-A series models

Special-function button	Functions
Mute button 	Turns on and off the volume. The LED turns on when the volume is turned off.
Volume buttons  (Volume down and Volume up)	Increase and decrease the volume.
Brightness button 	You can increase and decrease the brightness intensity. When the screen is on maximum brightness intensity, the LED turns on. Auto luminance sensor: By default, the light sensor senses the brightness from outside and the display brightness is adjusted accordingly. This setting applies only when the display is set to automatic brightness mode. Press the brightness button to set the display to automatic brightness mode. You can adjust the general level of the automatic brightness mode in Setting Up Your Computer with VAIO Control Center (page 120).
Magnify screen button (Zoom) 	Changes the image resolution in all applications, except in those that use the DVD player. The default resolutions of the standard view and the magnified view depend on the model as listed below. For the type of LCD screen equipped with your computer, see LCD screen in the printed Specifications sheet. <input type="checkbox"/> Models with the WUXGA LCD screen Standard view: 1920 x 1200 pixels Magnified view: 1280 x 768 pixels <input type="checkbox"/> Models with the WXGA+ LCD screen Standard view: 1440 x 900 pixels Magnified view: 1024 x 600 pixels
S1 button 	The S1 button, by default, launches the VAIO Zone software. You also can link to this shortcut button another action that you execute often. See Setting Up Your Computer with VAIO Control Center (page 120).



When an external display is connected to your computer, the **Magnify screen** button is disabled.

The magnified view is not as clear as the standard view.



Pressing the **Magnify screen** button changes the resolution, thus may cause a defect to any running software that does not support change in resolution. Make sure to quit such software before pressing the **Magnify screen** button.

The **Magnify screen** button may not work with graphic images as it magnifies the screen view by changing the resolution.

The location and size of software windows may change when the screen view is magnified or when the standard view is restored.

When the LCD screen view is magnified, switching the view to the external display disables the function and restores the standard view.

VGN-FS series models

<i>Special-function button</i>	<i>Functions</i>
S1/S2 buttons  	By default, the S1 button turns on and off the volume and the S2 button toggles the display output between the LCD and external device. You can also link to these shortcut buttons another action that you execute often. See Setting Up Your Computer with VAIO Control Center (page 120).

Using the Optical Disc Drive

Your computer is equipped with an optical disc drive.

To insert a disc

- 1 Turn on the computer.
- 2 Press the drive eject button (1) to open the drive.
The tray slides out.
- 3 Place a disc in the middle of the tray with the label side facing up until the disc clicks into place.

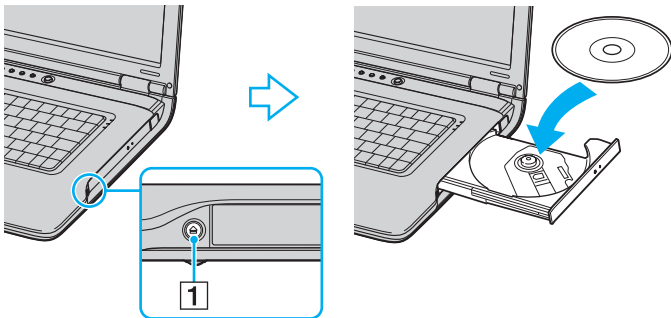

- 4 Close the tray by pushing it in gently.



Do not remove the optical disc when the computer is in a power saving mode (**Standby** or **Hibernate**). Doing so may cause the computer to malfunction.



If you plan to use an external optical disc drive, connect the drive before you launch any preinstalled CD/DVD program.



See the printed **Troubleshooting Guide** if you have problems using discs.

The location of the drive eject button depends on the model your purchased. See the printed **Specifications** sheet for details on your model.

Reading and Writing CDs and DVDs

Your computer plays and records CDs and DVDs, depending on the model you purchased. Check your specifications for the type of optical disc drive installed on your computer. Use the table below to see which types of media your optical disc drive supports.

<i>Optical disc drive</i>	<i>Plays</i>	<i>Records to</i>
CD-ROM	CD, CD-R, and CD-RW	—
DVD-ROM	DVD and most DVD-R, DVD-RW, DVD+R, DVD+RW and DVD+R DL (Double Layer)*	—
CD-RW	CD, CD-R, and CD-RW	CD-R and CD-RW
CD-RW/DVD-ROM	CD, CD-R, CD-RW, DVD, most DVD-R, DVD-RW, DVD+R, DVD+R DL (Double Layer)* and DVD+RW	CD-R and CD-RW
DVD-RW	CD, CD-R, CD-RW, DVD, DVD-R, DVD-RW, DVD+R, DVD+R DL (Double Layer)* and DVD+RW	CD-R, CD-RW, DVD-R and DVD-RW
DVD±RW	CD, CD-R, CD-RW, DVD, DVD-R, DVD-RW, DVD+R, DVD+R DL (Double Layer)* and DVD+RW	CD-R, CD-RW, DVD, DVD-R, DVD-RW, DVD+R, DVD+R DL (Double Layer)* and DVD+RW

* On selected models only.

! This product is designed to playback discs that conform to the Compact Disc Digital Audio standard specifications (CD Standard). A DualDisc is a two sided disc product which mates DVD recorded material on one side with digital audio material on the other side. Please be aware that the audio side (non-DVD side) of a DualDisc may not play on this product because it does not conform to the CD Standard.

! Due to the multiple formats of discs now available, when buying pre-recorded or blank discs for use with a Sony VAIO computer, be sure to read the notices on the disc packaging carefully to check both playback and recording compatibility with your computer's optical disc drives. Sony does NOT guarantee the compatibility of VAIO CD drives with discs that not compliant with the official "CD" format standard (or "DVD" standard in relation to DVD drives). **USING NON-COMPLIANT DISCS CAN CAUSE FATAL DAMAGE TO YOUR VAIO PC OR CREATE SOFTWARE CONFLICTS AND CAUSE SYSTEM HANGING.** For inquiries about disc formats, contact the individual publisher of the pre-recorded disc or the manufacturer of the recordable disc.

Notes on writing data onto a disc

- ❑ To make the data on a disc readable on an optical disc drive, you need to close the session when you eject it. To complete this process, follow the instructions included with your software.
- ❑ Only use circular discs. Do not use discs in any other shape (star, heart, card, etc.), as this may damage the optical disc drive.
- ❑ Do not strike or shake the computer while writing data onto a disc.
- ❑ Deactivate the screen saver and exit anti-virus software before writing data onto a disc.
- ❑ Do not use memory-resident utility software while writing data to a disc. This may cause the computer to malfunction.
- ❑ When using your software application to burn discs, make sure you exit and close all other applications.
- ❑ Never touch the surface of the disc. Fingerprints and dust on the surface of a disc may cause writing errors.
- ❑ Do not switch power modes while using the pre-installed software and while using the CD burning software.
- ❑ Never put stickers on discs. This will affect the use of the disc irreparably.
- ❑ Connect and use the AC adapter to power your computer or make sure your battery is at least 50 percent charged.
- ❑ Some DVD players and computer's DVD drives may not be able to play DVDs created by the **VAIO Zone** software.



Ultra-speed CD-RW is supported on VGN-A series models but not on VGN-FS series models.

Supports writing to DVD-RW discs compliant with DVD-RW version 1.1/1.2.

Supports 8cm disc reading, but does not support 8cm disc writing.

Because the maximum writing speed to DVD+R DL (Double Layer) discs is 2.4x speed, it may take a while to finish writing to such discs. See the printed **Specifications** sheet for more information on the optical disc drive.

Notes on playing DVDs

To achieve optimum performance when playing DVDs, you should follow these recommendations.

- ❑ You can play DVDs using the optical disc drive and the **VAIO Zone** software. See the help file on the **VAIO Zone** software for details.
- ❑ Close all open applications before playing a DVD movie.
- ❑ Do not use memory-resident utility software to speed up disc access when playing a DVD. This may cause the computer to malfunction.
- ❑ Deactivate the screen saver and exit anti-virus software before playing a disc.
- ❑ Some discs recorded at 20 or 24 bits may produce noise while playing. If you have audio devices connected, this may damage your hearing and the speakers. Reduce the volume before playing a DVD.
- ❑ Do not switch power saving modes while the computer is playing a DVD.
- ❑ Region codes indicators are labeled on the DVDs to indicate in which region and on what type of player you can play the disc. Unless a "2" (Europe belongs to region "2") or "all" (this means that you can play this DVD in most regions of the world) is labeled on your DVD disc or on the packaging, you cannot play the disc on this player.

!

If you change the DVD region code while the **WinDVD** software is running, restart the software or eject the disc and re-insert it to make the new setting effective.

- ❑ Do not try to change the region code settings of the DVD drive. Any difficulties caused by changing the region code settings of the DVD drive are out of warranty.
- ❑ If your computer has Wireless LAN and Wireless LAN is activated, playing DVDs may cause some interruptions in audio and video.
- ❑ When you are playing a DVD (video or audio) and you want to remove a USB device, such as USB-compatible speakers, make sure you stop the DVD first. Removing a USB-compatible device during DVD (video or audio) playback may cause a malfunction.

Playing CDs

To play an audio CD

- 1 Insert the disc into the optical disc drive.
- 2 If nothing appears on the desktop once you insert an audio CD disc, then click **Start**, point to **All Programs**, and click to open a CD program, such as the **SonicStage** software.
If the **Audio CD** window appears, click to select an option.

Copying Files to CDs

To determine which type of CD your computer supports, see **Reading and Writing CDs and DVDs** ([page 32](#)).

To copy files to a CD-RW or CD-R

- 1 Insert a blank CD-R or CD-RW disc into the optical disc drive.
If the **CD Drive** window appears, click **Take no action**.
- 2 Open Windows Explorer by pressing the **Windows** key and the **E** key simultaneously.
- 3 In the **Folders** panel on the left, locate the file(s) or folder(s) you want to copy and either:
 - Right-click the file(s) or folder(s), point to **Send To**, and click the optical disc drive* name.
 - Drag the file(s) or folder(s) onto the optical disc drive icon in the **Files Stored on This Computer** panel.
- 4 Close Windows Explorer.
- 5 Click **Start** and then **My Computer**.
- 6 Click the optical disc drive icon under **Devices with Removable Storage**. A new window appears with the file(s) or folder(s) you want to copy listed under **Files Ready to Be Written to the CD**.
- 7 In the **CD Writing Tasks** box, click **Write these files to CD**.
- 8 Follow the instructions in the **CD Writing Wizard**.

* The read/write drive letter designation may vary, depending on your system's hardware configuration.

!
Do not strike or shake the computer while writing data onto a disc.

Playing DVDs

To play a DVD

- 1 Close all open programs.
- 2 Insert the DVD into the optical disc drive.
- 3 Click **Start** and point to **All Programs**.
- 4 Select a DVD software program to play the DVD.

For instructions on how to use a program, see the help guide included with the DVD software program.

Copying Files to DVDs

To copy files to a DVD-R or DVD-RW

- 1 Connect the AC adapter to the computer.
- 2 Insert the disc into the optical disc drive.
- 3 Click **Start** and point to **All Programs**.
- 4 Select a DVD software program you want to use from the submenu.

For instructions on how to use a program, see the help guide included with the DVD software program.

Using the TV Function (on Selected Models Only)

If an A/V port replicator is delivered with the model you purchased, your computer is equipped with a TV tuner. In combination with Sony's **VAIO Zone** software, the TV tuner board allows you to:

- Watch, record and play back analog broadcasted cable and terrestrial TV programs, all by remote control.
- Digitize analog video and audio using the S-video or composite and audio inputs.
- Manage your video units (capsules), preview them and create multiple folders.
- Set up a timer to record channels at a repeated time.
- Suspend viewing TV (time-shifting).
- Stream your recorded TV contents via Ethernet (or WLAN) to connected PCs.



Sony cannot guarantee the streaming of recorded content if it is beyond a certain level of high quality.

For details on using the **VAIO Zone** software and the remote control, please see the dedicated guide. Otherwise read the help files within the software itself.

tvTV takes your VAIO's TV functions to a new level. Never miss your favorite TV program again, by remote-recording it via the Internet onto your TV tuner-equipped VAIO. The tvTV Interactive Programme Guide gives you a comprehensive overview of what's on when and automatically synchronizes it with your VAIO, wherever you happen to be at the time. For more information, read the **Welcome to TVTV** HTML files on your computer.

To connect terrestrial or cable TV to your computer

- 1 Plug one end of your antenna cable/cable-TV cable (supplied with selected models only^{*}) into the VHF/UHF port on the A/V port replicator.
- 2 Plug the other end into the TV wall socket.

^{*} See the printed **Specifications** sheet for the accessories delivered with your model.

Using PC Cards

PC Cards allow you to connect portable external devices.

Inserting a PC Card

To insert a PC Card

- 1 Insert the PC Card into the PC Card slot with the front label facing up.
- 2 Gently push the PC Card into the slot.
The PC Card is automatically detected by your system.
The **Safely Remove Hardware** icon appears on the taskbar.

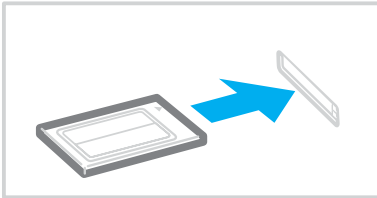



Some devices may not function properly if you repeat returning to **Normal** mode from **Standby** mode or **Hibernate** mode. For some PC Cards, if you alternate between **Normal** mode and **Standby** or **Hibernate** mode while the card is inserted, you may find that a device connected to your system is not recognized. Restart your system to correct the problem. Restarting will restore the original state of the computer.

While the card is inserted, your computer may not enter **Hibernate** power management mode. It may enter **Standby** mode. It is recommended that you remove the card before your computer enters **Hibernate** mode.

Some PC Cards or their functions may not be compatible with your computer.

If your computer has two PC Card slots:

- They can accommodate (at the same time) two Type I, two Type II or one Type III PC Card. These slots are compatible with CardBus ports.
- Use the lower slot for Type III PC Cards.
- Always use the same slot for a PC Card. Switching slots can cause problems with some PC Cards.

Make sure you use the most recent software driver provided by the PC Card manufacturer.

If an "!" mark appears on the **Device Manager** tab in the **System Properties** window, remove the software driver and then reinstall it.

Do not force a PC Card into the slot. It may damage the connector pins. If you have difficulty inserting a PC Card, check that you are inserting the PC Card in the correct direction. See the manual supplied with your PC Card for more information on use.

Do not carry your computer while touching the head of a PC Card, as pressure or shock may damage the connector pins.

You do not need to shut down your computer before inserting or removing a PC Card.

Removing a PC Card

Follow the steps below to remove the PC Card while your computer is on. If it is not removed properly, your system may not work properly.

To remove a PC Card



To remove a PC Card when your computer is off, skip steps 1 to 7.

- 1 Double-click the **Safely Remove Hardware** icon on the taskbar.
The **Safely Remove Hardware** window appears.
- 2 Select the hardware you want to unplug.
- 3 Click **Stop**.
The **Stop a Hardware Device** window appears.
- 4 Confirm that the device can be safely removed from the system.
- 5 Click **OK**.
A window appears, explaining that it is safe to remove the device.
- 6 Click **OK**.
- 7 Click **Close**.
- 8 Push the PC Card release button so that the release button pops out.
- 9 Push the PC Card release button a second time so that the PC Card pops out.
- 10 Gently take hold of the Card and pull it out of the slot.
- 11 If the PC Card release button is still out, push it back in.



If you remove the PC Card from the computer when it is still turned on, your system might crash and you might lose any unsaved data.

Before you remove the PC Card, click the PC Card icon on the taskbar and close the card. Close any applications that use the PC Card before removing the card. Otherwise, data may be lost.

Using the Memory Stick Media

Your VAIO computer supports the Memory Stick media. Memory Stick media is a compact, portable, and versatile device especially designed for exchanging and sharing digital data with compatible products, such as digital cameras, mobile phones and other devices. Because it is removable, it can be used for external data storage.

See the printed **Specifications** sheet to see which Memory Stick media types are compatible with your computer and if there are any limitations.

- You can purchase Memory Stick media from the Sony Style website (www.sonystyle-europe.com), or from your local Sony dealer.
- Detailed information about which VAIO computers are compatible with which Memory Stick media can be found at www.vaio-link.com.

Write-protecting a Memory Stick Media

Some versions of Memory Stick media are designed with an erasure prevention switch to protect valuable data from accidental erasure or overwriting.

Move the tab horizontally or vertically* to set or release write-protection. When the erasure prevention switch is off, data can be saved on the Memory Stick media. When the erasure prevention switch is on, data can be read from but not saved on the Memory Stick media.

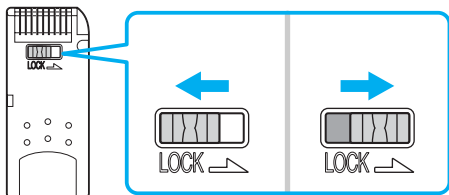

* Some versions of Memory Stick media do not have an erasure prevention switch.

Inserting a Memory Stick Media

There are two ways you can insert a Memory Stick media into your computer:

- ❑ Using the Memory Stick media slot;
- ❑ Using a PC Card slot. To do this, you need an optional PC Card adapter.

You can only insert one Memory Stick media at a time.

To insert a Memory Stick media using the Memory Stick media slot

- 1 Insert the Memory Stick media with the arrow facing up and toward the Memory Stick media slot.
- 2 If your computer is equipped with the Memory Stick media slot cover, lift the slot cover.
- 3 Carefully slide the Memory Stick media into the slot until it clicks in place.

The Memory Stick media is automatically detected by your system and appears in your **My Computer** window as a local drive, under the appropriate letter (depending on the configuration of your computer).

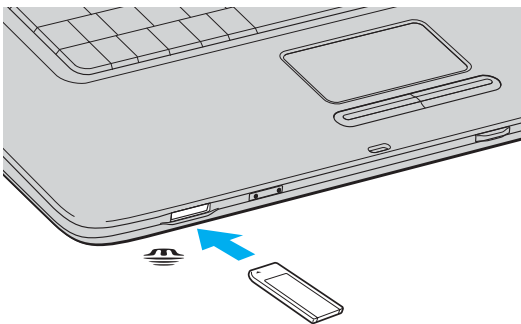



The location of the Memory Stick media slot depends on the model you purchased. See the printed **Specifications** sheet for details on your model.



Be sure to hold the Memory Stick media with the arrow pointing in the correct direction as you insert it into the slot. To avoid damaging the computer or the Memory Stick media, do not force the Memory Stick media into the slot if it does not insert smoothly.

Do not insert more than one Memory Stick media into the Memory Stick media slot. Inserting the media improperly may damage the computer.



Your computer supports Memory Stick Duo media. For more information on Memory Stick Duo media, visit the Memory Stick web site at <http://www.memorystick.com/en/>.

Viewing the Contents

Depending on the model you purchased, the **Memory Stick** window may appear when you insert a Memory Stick media. From this window, you can choose to view, print, copy or organize your images or data stored on the Memory Stick media. If the **Memory Stick** window does not appear when you insert the Memory Stick media, follow these steps:

To view the contents

- 1 Click **Start** and then **My Computer**.
The **My Computer** window appears.
- 2 Click **Memory Stick**.
The **Memory Stick** window appears, displaying the contents stored on the Memory Stick media.

Formatting a Memory Stick Media

Memory Stick media is formatted for immediate use when you purchase it. If you need to reformat Memory Stick media, use the **Memory Stick Formatter** software that is provided with the media. For more information about using Memory Stick Formatter, see the help file of **Memory Stick Formatter**.



Formatting Memory Stick media erases all data previously saved to it. Before you reformat Memory Stick media, confirm that the media does not contain files you want to keep. Back up important data before formatting the media.

To format a Memory Stick media

- 1 Click **Start**, point to **All Programs, Memory Stick Utility**, and click **Memory Stick Formatter**. The **Memory Stick Formatter** window appears.
- 2 Click **Start Format**, and follow the on-screen instructions.
- 3 After formatting, click **Exit**.

Removing a Memory Stick Media

To remove a Memory Stick media using the Memory Stick media slot

- 1 Check that the Memory Stick media indicator is off.
- 2 Push the Memory Stick media in toward the computer. The Memory Stick media ejects.
- 3 Pull the Memory Stick media out of the slot.



Always remove the Memory Stick media gently, or it may pop out unexpectedly.

Do not remove the Memory Stick media while the Memory Stick media indicator is turned on. If you do, you may lose data. Large volumes of data may take time to load, so be sure the indicator is off before removing the Memory Stick media.

Using the Internet

Setting Up a Dial-up Internet Connection

Before you can connect to the Internet, you need to connect your computer to a telephone line via a telephone cable (not supplied). Once you set up your telephone cable, you're ready to connect to the Internet.

To connect a telephone cable

- 1 Plug one end of the phone cable (1) into the modem port  on the computer.
- 2 Plug the other end into the wall jack (2).

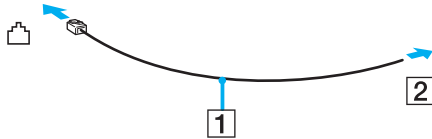

Your computer does not work with party lines, cannot be connected to a coin-operated telephone, and may not work with multiple telephone lines or a private branch exchange (PBX). Some of these connections may result in excess electrical current and could cause a malfunction in the internal modem.

If you connect a telephone cable coming through a splitter, the modem or connected device may not work properly.

To set up a dial-up connection to the Internet

- 1 Click **Start**, point to **All Programs, Accessories, Communications**, and click **New Connection Wizard**. The **New Connection Wizard** appears.
- 2 Click **Next**. If the **Location Information** window appears, follow the on-screen instructions.
- 3 If it is not already selected, click to select **Connect to the Internet**, and click **Next**.
- 4 Follow the on-screen instructions.

Using Wireless LAN (WLAN)

Using the Sony Wireless LAN (WLAN), all your digital devices with built-in WLAN functionality communicate freely with each other through a powerful network. A WLAN is a network in which a user can connect to a local area network (LAN) through a wireless (radio) connection. So there is no need anymore to pull cables or wires through walls and ceilings.

The Sony WLAN supports all normal Ethernet activities, but with the added benefits of mobility and roaming. You can still access information, internet/intranet and network resources, even in the middle of a meeting, or as you move from one place to another.

You can communicate without an Access Point, which means that you can communicate between a limited number of computers (**ad-hoc**). Or you can communicate through an Access Point, which allows you to create a full infrastructure network (**infrastructure**).



In some countries, using WLAN products may be restricted by the local regulations (e.g. limited number of channels). Therefore, before activating the WLAN functionality, read the **Wireless LAN Regulation** carefully. Channel selection is explained further in this manual (see **Wireless LAN Channel Selection (page 55)**).

WLAN uses the IEEE802.11b/g standard, which specifies the used technology. The standard includes the encryption method: **Wired Equivalent Privacy** (WEP), which is a security protocol and **WiFi Protected Access** (WPA - Proposed jointly by the IEEE and Wi-Fi Alliance, WiFi Protected Access is a specification of standards based, interoperable security enhancements that increase the level of data protection and access control for existing WiFi networks. WPA has been designed to be forward compatible with the IEEE802.11i specification. It utilizes the enhanced data encryption TKIP (Temporal Key Integrity Protocol) in addition to user authentication using 802.1X and EAP (Extensible Authentication Protocol)). Data encryption protects the vulnerable wireless link between clients and Access Points. Besides that, there are other typical LAN security mechanisms to ensure privacy, such as: password protection, end-to-end encryption, virtual private networks, and authentication.

Wireless LAN devices using the IEEE802.11a standard and the ones using the IEEE802.11b or g standard cannot communicate because the frequencies are different.

IEEE802.11b: The standard speed is 11 Mbps, or about 30 to 100 times faster than a standard dial up.

IEEE802.11a/g: The standard speed is 54 Mbps, or about 5 times faster than a Wireless LAN device using the IEEE802.11b standard.

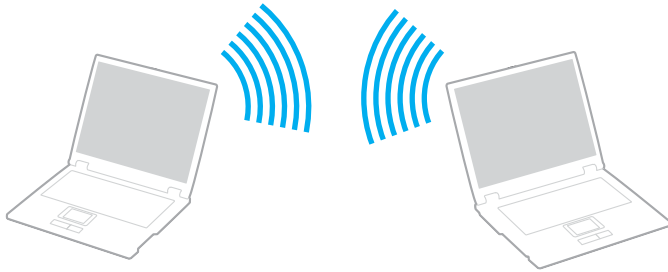

Communicating without an Access Point (Ad-hoc)

An ad-hoc network is a network in which a local network is created only by the wireless devices themselves, with no other central controller or Access Point. Each device communicates directly with other devices in the network. You can set up an ad-hoc network easily at home.



To communicate without an Access Point (ad-hoc)

- 1 Turn on the **WIRELESS** (on models with the Bluetooth functionality^{*1}) or **WIRELESS LAN** (on models without the Bluetooth functionality) switch.

On models with the Bluetooth functionality, double-click  ( / ) on the taskbar to display the **Wireless Device Switch** window. Select the **Enable 2.4 GHz Wireless LAN** check box and click **OK**.

- 2 Click **Start** and then **Control Panel**.
- 3 Click **Network and Internet Connections**.
- 4 Click **Network Connections**.
The **Network Connections** window appears.
- 5 Right-click **Wireless Network Connection**, then click **Properties**.
The **Wireless Network Connection Properties** window appears.
- 6 Select the **Wireless Networks** tab.
- 7 Click the **Add...** button.
The **Wireless network properties** window appears.
- 8 Enter a **Network name (SSID)**^{*2}.
You can choose a **32-digit** alphanumeric name.
- 9 Select **Open** from the **Network Authentication** drop-down box.
- 10 Select **WEP** from the **Data Encryption** drop-down box.
- 11 Deselect the **The key is provided for me automatically** option button.
Some information becomes visible.
- 12 Enter the **Network key**^{*2}.

The network key should be **5 or 13 alphanumeric characters** or **10 or 26 hexadecimal**^{*3} **characters** long. You can choose whatever you want.

- 13 Enter exactly the same **Network key** again, for confirmation.
- 14 Select the check box **This is a computer-to-computer (ad hoc) network; wireless access points are not used** at the bottom of the screen.
- 15 Click **OK**.
Your **Network name** appears in the **Preferred networks**.
- 16 Click **Advanced**.
The **Advanced** window appears.
- 17 Select the **Computer-to-computer (ad hoc) networks only** option button.
- 18 Click **Close**.
- 19 Click **OK**.
Your computer is ready to communicate with another computer.

*1 See the printed **Specifications** sheet to see whether your model is equipped with the Bluetooth functionality.

*2 If you want to communicate between two or more computers, you need to configure all these computers the exact same way. This means that you need to enter the same **Network name** and the same **Network key** on all computers as on the first computer you configure.

*3 **Hexadecimal**: A number representation using the digits 0-9, with their usual meaning, plus the letters A-F (or a-f) to represent hexadecimal digits with values of (decimal) 10 to 15.



An ad-hoc network does not support WPA.



In France, only certain channels are legally allowed when using WLAN outdoors. For more information, see the **Wireless LAN Regulations**.

To disconnect from a computer-to-computer (ad-hoc) network

- 1 Click **Start** and then **Control Panel**.
- 2 Click **Network and Internet Connections**.
- 3 Click **Network Connections**.
The **Network Connections** window appears.
- 4 In the right panel under **LAN or High-Speed Internet**, double-click **Wireless Network Connection**.
The **Wireless Network Connection Status** window appears.
- 5 Click **Properties**.
The **Wireless Network Connection Properties** window appears.
- 6 On the **Wireless Networks** tab, click **Advanced**.
The **Advanced** window appears.
- 7 Click to select **Any available network (access point preferred)**, and click **Close**.
- 8 Click **OK**.
- 9 Click **Close**.
- 10 Turn off the **WIRELESS** or **WIRELESS LAN** switch.

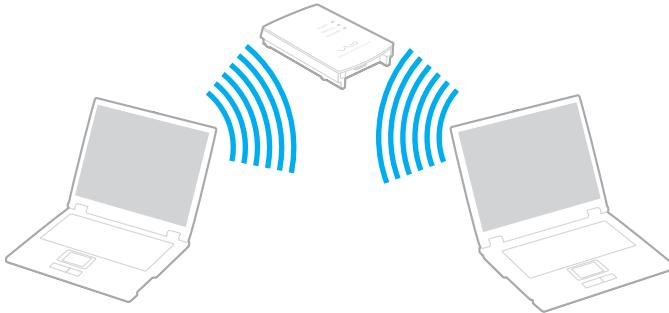

Communicating with an Access Point (Infrastructure)

An infrastructure network is a network that extends an existing wired local network to wireless devices by providing an Access Point, for example the **Sony Access Point**. The Access Point bridges the wireless and wired LAN and acts as a central controller for the Wireless LAN. The Access Point coordinates transmission and reception from multiple wireless devices within a specific range.



To connect to a wireless network

- 1 Turn on the **WIRELESS** (on models with the Bluetooth functionality*) or **WIRELESS LAN** (on models without the Bluetooth functionality) switch.

On models with the Bluetooth functionality, double-click  ( / ) on the taskbar to display the **Wireless Device Switch** window. Select the **Enable 2.4 GHz Wireless LAN** check box and click **OK**.

- 2 Click **Start** and then **Control Panel**.
- 3 Click **Network and Internet Connections**.
- 4 Click **Network Connections**.
The **Network Connections** window appears.
- 5 In the right panel under **LAN or High-Speed Internet**, double-click **Wireless Network Connection**.
The **Wireless Network Connection** window appears.
- 6 Select the network you want to use.
- 7 Enter the **Network Key**.
- 8 Click **Connect**.
After 30 seconds, the connection is established.

* See the printed **Specifications** sheet to see whether your model is equipped with the Bluetooth functionality.

For more information about setting up an access point, see the documentation supplied with your **Access Point**.



The WPA key needs to contain at least 8 characters.

Wireless LAN Channel Selection

In an 802.11b/g configuration, channel 1 to 13 can be used.

(a) With an Access Point ("Infrastructure")

- ❑ The channel used will be the channel selected by the Access Point.

! For details on how to select the channel that will be used by the Access Point, see the access point manual.

(b) Without an Access Point ("ad-hoc")

- ❑ If the Wireless connection is initiated by the VAIO computer, channel 11 will be selected.

! In France, only certain channels are legally allowed when using WLAN outdoors. For more information, see the **Wireless LAN Regulations**.

- ❑ If the Wireless connection is initiated by a peer Wireless LAN equipment, the Wireless LAN communication will make use of the channel selected by the peer Wireless LAN equipment.



The 2.4 GHz bandwidth used by wireless LAN compatible devices is also used by other various devices. Although technologies to minimize interference from other devices that uses the same bandwidth are employed on wireless LAN compatible devices, such interference may cause lower communication speed, narrower communication range, or broken wireless connections.

The communication speed varies depending on the distance between communication devices, existence of obstacles between such devices, the device configuration, the radio conditions, and the software in use. In addition, communications may be cut off depending on the radio conditions.

The communication range varies depending on the actual distance between communication devices, existence of obstacles between such devices, the radio conditions, the ambient environment that includes existence of walls and materials of such walls, and the software in use.

Deploying IEEE802.11b and IEEE802.11g products on the same wireless network may reduce the communication speed due to radio interference. Taking this into consideration, the IEEE802.11g products are designed to reduce the communication speed to ensure communications with IEEE802.11b products. When the communication speed is not as fast as expected, changing the wireless channel on the access point may increase the communication speed.



In France, only certain channels are legally allowed when using WLAN outdoors. For more information, see the **Wireless LAN Regulations**.

Using the Bluetooth Functionality (on Selected Models Only)

You can establish wireless communication between your computer and other Bluetooth devices such as another computer or a mobile phone. You can transfer data between these devices without cables and up to 10 meters range in open space.

See the printed **Specifications** sheet to see whether your model is equipped with the Bluetooth functionality.

To connect to a Bluetooth device

- 1 Turn on the **WIRELESS** switch.
- 2 Double-click  on the taskbar to display the **Wireless Device Switch** window.
- 3 Select the **Bluetooth** option.
- 4 Click **OK**.

Notes on using the Bluetooth functionality

- ❑ The data transfer rate varies, depending on the following conditions:
 - ❑ Obstacles, such as walls, located between devices
 - ❑ Distance between devices
 - ❑ Material used in walls
 - ❑ Proximity to microwaves and cordless telephones
 - ❑ Radio frequency interference and other environmental conditions
 - ❑ Device configuration
 - ❑ Type of software application
 - ❑ Type of operating system
 - ❑ Use of both Wireless LAN and Bluetooth functionalities at the same time on the computer
 - ❑ Size of file being exchanged
- ❑ Note that due to limitations of the Bluetooth standard, large files may occasionally be corrupted during continuous transfer due to electromagnetic interference from the environment.
- ❑ All Bluetooth devices must be certified to make sure that the applicable standard requirements are maintained. Even if standards are met, individual device performance, specifications, and operation procedures can vary. Data exchange may not be possible in all situations.

- ❑ The 2.4 GHz band with which Bluetooth devices or wireless LAN devices work, is used by various devices. Bluetooth devices use the technology to minimize the interference from other devices that use the same wave length. Communication speed and distances can be inferior to the standard values. Interference from other devices may also stop communications. Do not simultaneously use the Bluetooth functionality and wireless communication devices which use the 2.4 GHz band, such as a wireless LAN PC Card.



Read the **Regulations Guide** before using the Bluetooth functionality.

- ❑ The Bluetooth functionality may not work depending on the third party devices or the software version used by third party companies.

Bluetooth Security

The Bluetooth wireless technology has an authentication function, which allows you to determine whom you choose to communicate. With the authentication function, you can avoid any anonymous Bluetooth device to access your computer.

The first time two Bluetooth devices communicate, a common **Passkey** (a password required for authentication) should be determined for both devices to be registered. Once a device is registered, there is no need to re-enter the **Passkey**.

To avoid being detected by other Bluetooth devices, you can change the Bluetooth settings, as described on the following pages.

Communicating with Another Bluetooth Device

You can connect your computer to a Bluetooth device such as another computer or a mobile phone without the use of any cables.

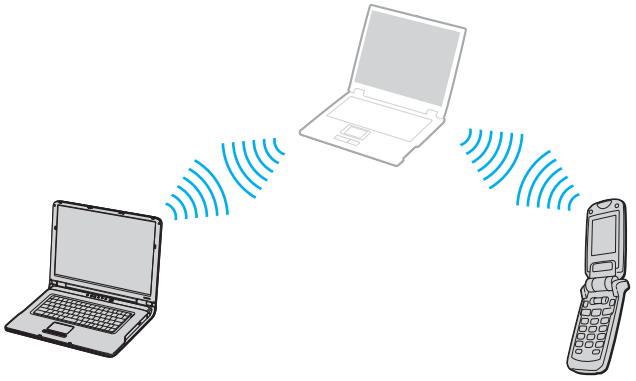

To communicate with another Bluetooth device

- 1 Turn on the **WIRELESS** switch.
- 2 Click **Start** and then **Control Panel**.
- 3 Click **Network and Internet Connections**.
- 4 Click **Bluetooth Devices**.
The **Bluetooth Device** window appears.
- 5 Click **Add**.
The **Add Bluetooth Device Wizard** window appears.
- 6 Select **My device is set up and ready to be found** and then click **Next**.
- 7 Select the remote device to which you want to connect. If necessary, scroll up and down in the **Bluetooth Device List** to make your selection. Then click **Next**.
- 8 Choose one of the following options:
 - If you want Windows to provide you with a password, select **Choose a Passkey for me**.
 - If the documentation of the other Bluetooth device contains a password, click **Use the passkey found in the documentation** and enter the passkey.
 - If you want to create your own passkey, click **Let me use my own passkey** and enter a passkey.
 - If your device does not use a passkey, click **Don't use a passkey**.
- 9 Click **Next** to continue.
- 10 Once the remote device has been successfully authenticated, click **Finish**.



The passkey can be different each time, but must be the same at both ends.

For certain devices, such as a mouse, no passkey can be entered.

To transfer data from or to another Bluetooth device

- 1 Choose **Start**, point to **All Programs, Accessories, Communications**, and then click **Bluetooth File Transfer Wizard**. The **Bluetooth File Transfer Wizard** window appears.
- 2 Click **Next** to continue.
- 3 Follow the on-line instructions.

To connect to a network with Bluetooth device

With Bluetooth connections, you can join a personal area network (PAN), which is an Internet Protocol (IP)-based network.

- 1 Turn on the **WIRELESS** switch.
- 2 Click **Start** and then **Control Panel**.
- 3 Click **Network and Internet Connections**.
- 4 Click **Network Connection**.
- 5 Click **Bluetooth Network Connection**.
The **Bluetooth Personal Area Network Device** window appears.
 - If you wish to connect to a Bluetooth device that is not displayed, click **Add**.
 - If you wish to connect to a displayed Bluetooth device, select the device's icon and click **Connect**.
- 6 Follow the on-screen instructions.

Stopping the Bluetooth Connection

To stop the Bluetooth connection, turn off the **WIRELESS** switch. The Bluetooth indicator turns off.

Using Peripheral Devices

You can add functionality to your computer by using the various ports on your unit.

- ❑ **Connecting a Port Replicator** ([page 64](#))
- ❑ **Using the Mouse (on Selected Models Only)** ([page 77](#))
- ❑ **Connecting External Speakers** ([page 81](#))
- ❑ **Using the Remote Commander** ([page 86](#))
- ❑ **Connecting an External Display** ([page 89](#))
- ❑ **Selecting Display Modes** ([page 97](#))
- ❑ **Using the Multiple Monitors Function** ([page 100](#))
- ❑ **Connecting an External Microphone** ([page 104](#))
- ❑ **Connecting a Universal Serial Bus (USB) Device** ([page 105](#))
- ❑ **Connecting a Printer** ([page 108](#))
- ❑ **Connecting an i.LINK Device** ([page 110](#))
- ❑ **Connecting to a Network (LAN)** ([page 112](#))

Connecting a Port Replicator

Attaching a port replicator enables you to connect additional peripherals to your computer, such as a printer and an external display.

A port replicator may be delivered with your computer, depending on the model you purchased. If not, you can additionally purchase an optional port replicator.

See the printed **Specifications** sheet to see whether your model comes with a port replicator.

Locating Ports on the Port Replicator

A/V port replicator for VGN-A series models

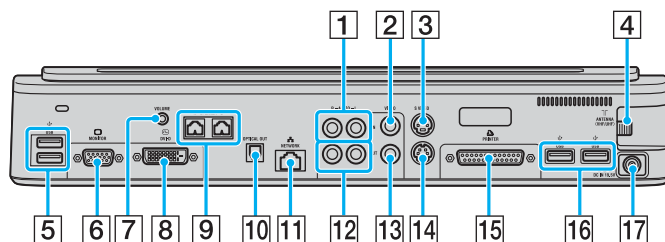

- 1 Composite Audio In jacks (page 66)
- 2 Composite Video In jack (page 66)
- 3 S Video In port (page 66)
- 4 VHF/UHF port*¹ (page 38)
- 5 Hi-Speed USB (USB 2.0) ports*² (page 105)
- 6 Monitor (VGA) port (page 90)
- 7 Volume jack (page 83)
- 8 DVI-D port (page 90)
- 9 Speaker jacks (right and left) (page 83)
- 10 Optical Out port (Output frequency 96 kHz/48 kHz/44 kHz/Variable)
- 11 Network (Ethernet) port (1000BASE-T / 100BASE-TX / 10BASE-T) (page 112)
- 12 Composite Audio Out jacks (page 95)
- 13 Composite Video Out jack (page 95)
- 14 S Video Out port (page 95)
- 15 Printer port (page 108)
- 16 Hi-Speed USB (USB 2.0) ports*² (page 105)
- 17 DC In port (page 15)

*¹ The shape of the VHF/UHF port varies depending on the country or area of your residency.

*² Supports high-/full-/low- speeds.



The printer port on this port replicator is intended for printer connections only.



To the A/V port replicator, you can connect an external video/audio source such as a video camera, VCR or DVD player. Connect your video/audio device's video cable to the S Video In or Composite Video In jack and the audio cable to the Composite Audio In Jacks.

Business port replicator for VGN-A series models

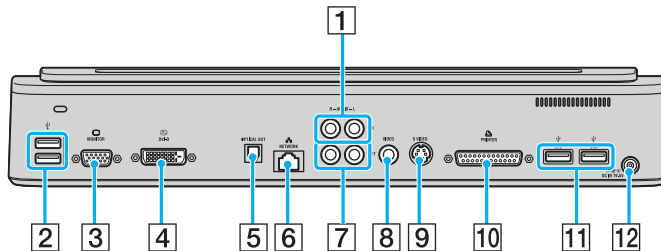

- 1 Composite Audio In jacks ([page 66](#))
- 2 Hi-Speed USB (USB 2.0) ports* ([page 105](#))
- 3 Monitor (VGA) port ([page 90](#))
- 4 DVI-D port ([page 90](#))
- 5 Optical Out port (Output frequency 96 kHz/48 kHz/44 kHz/ Variable)
- 6 Network (Ethernet) port (1000BASE-T / 100BASE-TX / 10BASE-T) ([page 112](#))
- 7 Composite Audio Out jacks ([page 95](#))
- 8 Composite Video Out jack ([page 95](#))
- 9 S Video Out port ([page 95](#))
- 10 Printer port ([page 108](#))
- 11 Hi-Speed USB (USB 2.0) ports* ([page 105](#))
- 12 DC In port ([page 15](#))

* Supports high-/full-/low- speeds.



To the business port replicator, you can connect an external audio device such as a CD player. Connect your audio device's audio cable to the Composite Audio In jack.



When a video cable is connected to each of the S Video Out and Composite Video Out jacks, the Composite Video Out jack is disabled.

A/V port replicator for VGN-FS series models

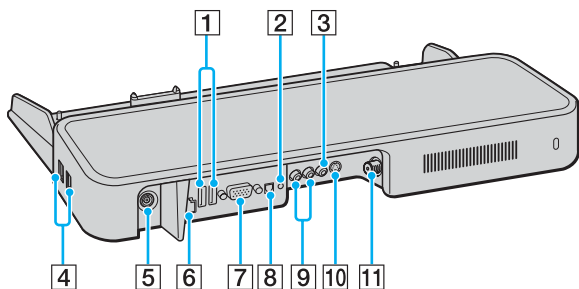

- 1 Hi-Speed USB (USB 2.0) ports^{*1} ([page 105](#))
- 2 Headphones/Speakers jack ([page 81](#))
- 3 Composite Video In jack ([page 67](#))
- 4 Hi-Speed USB (USB 2.0) ports^{*1} ([page 105](#))
- 5 DC In port ([page 15](#))
- 6 Network (Ethernet) port (100BASE-TX / 10BASE-T) ([page 112](#))
- 7 Monitor (VGA) port ([page 90](#))
- 8 Optical Out port (Output frequency 96 kHz/48 kHz/44 kHz/ Variable)
- 9 Composite Audio In jacks ([page 67](#))
- 10 S Video In port ([page 67](#))
- 11 VHF/UHF port^{*2} ([page 38](#))

^{*1} Supports high-/full-/low- speeds.

^{*2} The shape of the VHF/UHF port varies depending on the country or area of your residency.



To the A/V port replicator, you can connect an external video/audio source such as a video camera, VCR or DVD player. Connect your video/audio device's video cable to the S Video In or Composite Video In jack and the audio cable to the Composite Audio In Jacks.

Business port replicator for VGN-FS series models

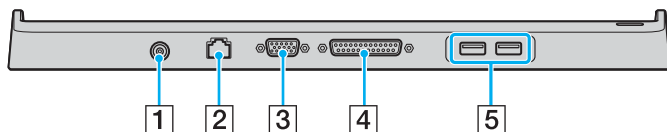

- 1 DC In port ([page 15](#))
- 2 Network (Ethernet) port (100BASE-TX / 10BASE-T) ([page 112](#))
- 3 Monitor (VGA) port ([page 90](#))
- 4 Printer port ([page 108](#))
- 5 Hi-Speed USB (USB 2.0) ports* ([page 105](#))

* Supports high-/full-/low- speeds.



The port replicator can be powered only through the AC adapter supplied with your computer. Do not unplug the AC adapter from the port replicator and the AC outlet while using the port replicator; this may cause data damage or hardware malfunctions.



The printer port on the port replicator is intended for printer connections only.

Attaching Your Computer to the Port Replicator

To attach your computer to the port replicator

VGN-A series models

- 1 Disconnect all peripherals from the computer.
- 2 Plug the power cord (1) into the AC adapter and an AC outlet.
- 3 Plug the cable attached to the AC adapter (2) into the DC In port (3) on the port replicator (4).

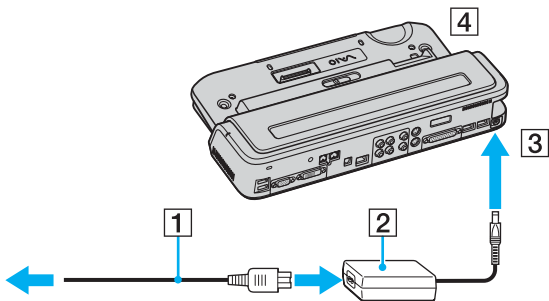

- 4 Open the port replicator connector cover.

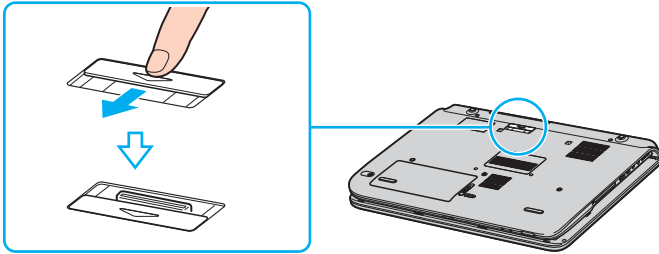

- 5 Align the bottom connector of the computer with the connector on the port replicator and push down until it clicks into place.

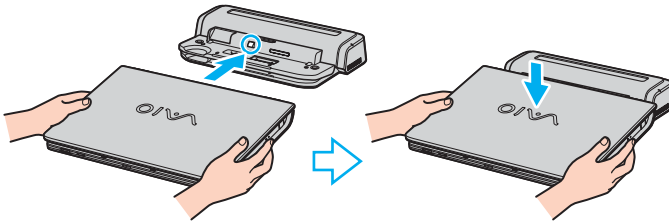

- 6 Slide the lock switch to **LOCK**.

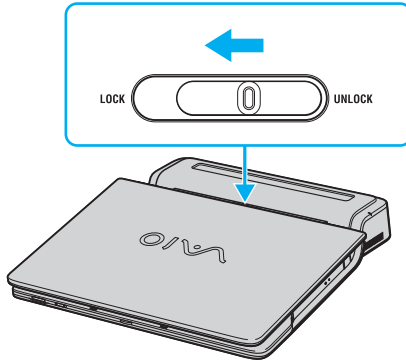

- 7 Turn on the computer.

VGN-FS series models

- 1 Disconnect all peripherals from the computer.
- 2 Plug the power cord (1) into the AC adapter and an AC outlet.
- 3 Plug the cable attached to the AC adapter (2) into the DC In port (3) on the port replicator (4).

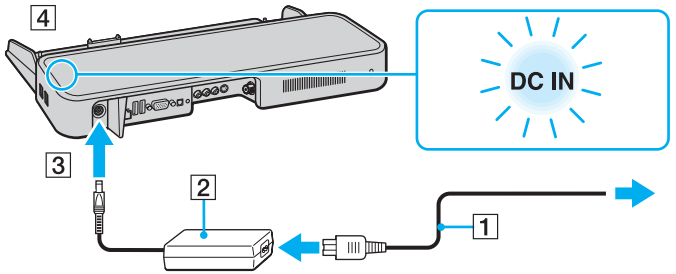

- 4 Open the port replicator connector cover.

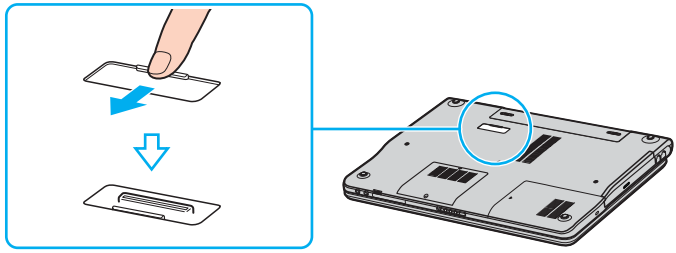

- 5 Align the bottom connector of the computer with the connector on the port replicator and push down until it clicks into place.

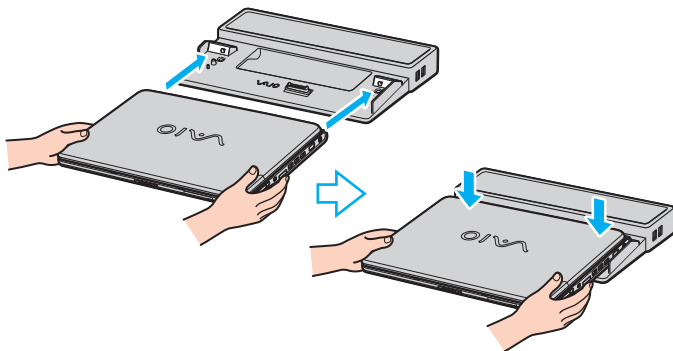

! When the A/V port replicator is attached to your computer, you cannot access the DC In port, the monitor (VGA) port, the third USB port from the front, and the network (Ethernet) connector on the computer.



Use the AC adapter that comes with your computer or the optional Sony adapter.

! Do not move your computer while attached to the port replicator; this may detach the port replicator and cause damage to the port replicator and the computer.

Disconnecting Your Computer from the Port Replicator

! To prevent loss of unsaved data, be sure to turn off your computer before disconnecting it from the port replicator.

To disconnect your computer from the port replicator

VGN-A series models

- 1 Turn off the computer and the connected peripherals.
- 2 Slide the lock switch to **UNLOCK**.

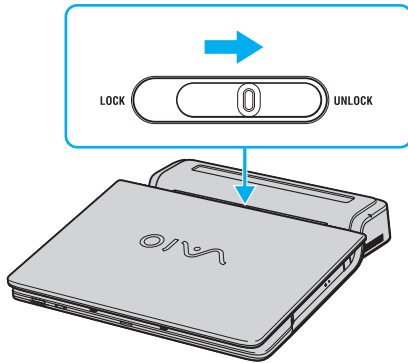

- 3 Lift the computer away from the port replicator.

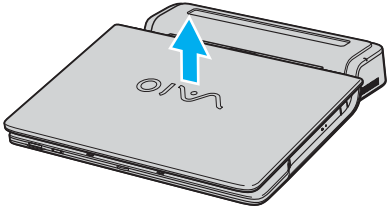

- 4 Close the port replicator connector cover on the bottom of your computer.

VGN-FS series models

- 1 Lift the computer away from the port replicator.

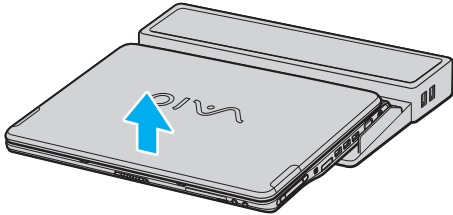

- 2 Close the port replicator connector cover on the bottom of your computer.



It is extremely important to close the port replicator connector cover after disconnecting your computer from the port replicator. If the cover is left open, dust may get inside and damage the computer.

To disconnect your port replicator completely from AC power, unplug the AC adapter.

Using the Mouse (on Selected Models Only)

Your computer includes a wireless optical mouse, which has no cables to plug in and uses a light-emitting diode (LED) instead of a ball. You can use the mouse anywhere you feel comfortable within a range of approximately 80 cm* of the main unit. Avoid using the mouse on a piece of glass or other transparent material; this can interfere with smooth cursor movement on the screen.

* Effective usage distance depends on the environment.

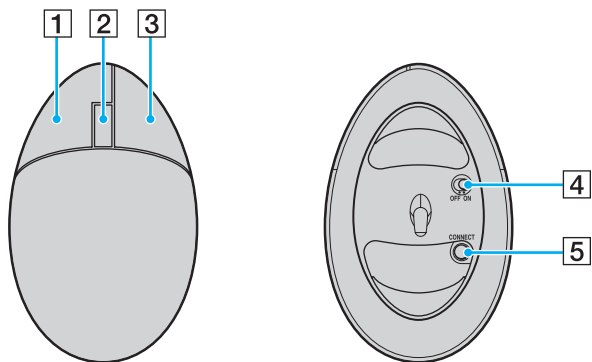

- 1** Left button
Click or double-click the left button to select items. To drag and drop items, hold the left button down while sliding the mouse, then release the button to drop the item.
- 2** Central wheel
Rotate the central wheel to scroll up or down a page. Press the wheel once to lock the scroll action and control the movement by moving the entire mouse (the scroll function is available only with applications that support it).
- 3** Right button
Press the right button once to display a context-sensitive shortcut menu (not always an active function).
- 4** Power switch
Slide the switch to turn the mouse on and off. This will help you save battery power.
- 5** **CONNECT** button
Press to enable communication between your VAIO computer and the wireless mouse.

Before You Use the Mouse

Before using the wireless mouse, you must enable communication between the computer and the mouse.

To connect the wireless mouse

- 1 Insert the two specific AA batteries into the wireless mouse as shown.

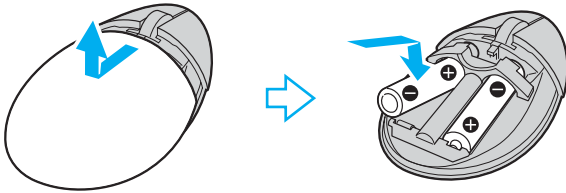

- 2 Turn on the computer.
- 3 Press the **CONNECT** button (1) on the computer.

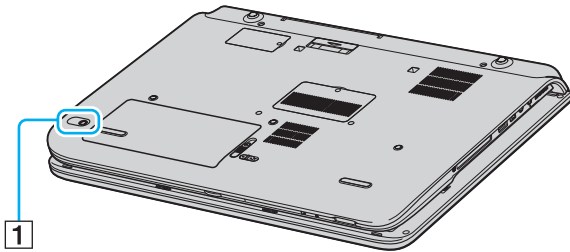

- 4 Turn over the wireless mouse, slide the power switch to the **ON** position, and press the **CONNECT** button. Communication between the wireless mouse and the computer is now active.

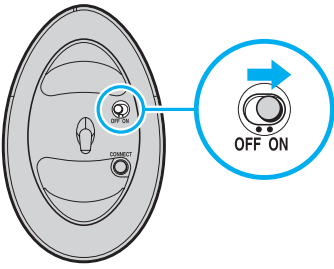

Step 3 and 4 must be completed within 10 seconds of each other.

Two AA batteries, specific for use in the wireless mouse, are supplied with your computer. They are identified by a sticker "For mouse" on the packaging.

If your wireless mouse does not operate properly, the batteries may need to be replaced. If your wireless mouse is not being used for an extended period of time, remove the batteries to avoid possible damage from battery leakage.

Adjusting the Mouse Functions

- 1 Click **Start** and then **Control Panel**.
- 2 Click **Printers and Other Hardware**.
- 3 Click the **Mouse**.
The **Mouse Properties** window appears.
- 4 Change the settings.

To set up your mouse for left-handed users

- 1 Click the **Buttons** tab on the **Mouse Properties** window.
- 2 Select the option button next to **Switch primary and secondary buttons**.
- 3 Click **OK**.
The new mouse settings are now active.

Connecting External Speakers

A pair of external speakers is delivered with your computer for extended use of the **VAIO Zone** software.

See the printed **Specifications** sheet to see whether your model comes with external speakers.

External speakers for VGN-A series models

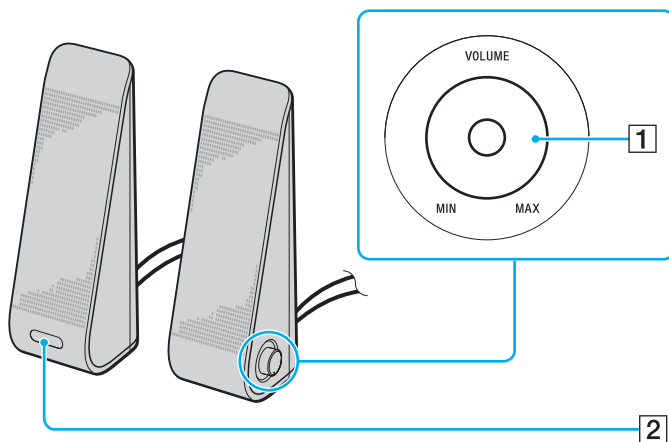

- 1** Volume control
The right speaker is equipped with the volume control. Turn this control clockwise or counterclockwise to adjust the speaker volume.
- 2** Infrared receiver for remote commander 
The left speaker is equipped with the infrared receiver for communications with the remote commander. Point your remote commander to this sensor for operations.

External speakers for VGN-FS series models

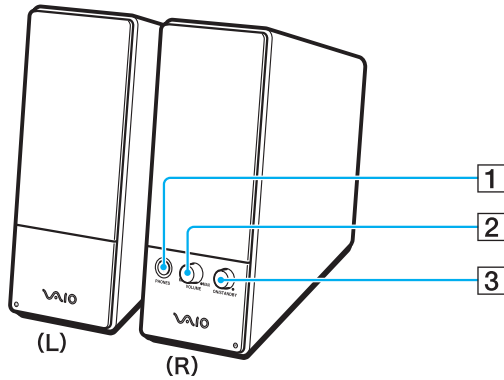

- 1** Headphones jack
- 2** Volume control
Turn clockwise or counterclockwise to adjust the speaker volume.
- 3** Power button
Turns on and off the speakers.

To connect the external speakers

External speakers for VGN-A series models

- 1 Attach your computer to an A/V port replicator.
- 2 Plug the volume cable (1) of the speaker to the Volume jack on the port replicator.
- 3 Plug the speaker cables (2) to the Speaker jacks.
- 4 Plug the USB cable (3) to one of the USB ports.

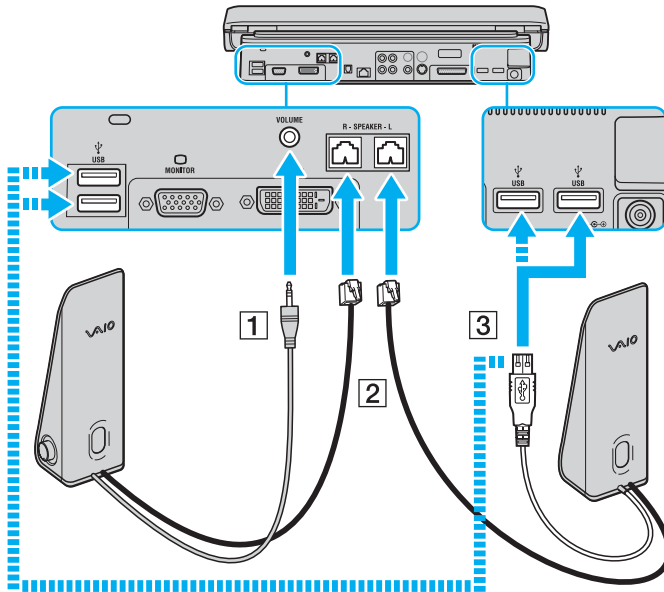

! To use a remote commander for volume control, make sure to connect the speaker's USB cable to the USB port.
Make sure to place the external speakers in a stable position.
Do not grasp the depression on the front of the speaker to take hold of it.

External speakers for VGN-FS series models

- 1 Attach your computer to an A/V port replicator.
- 2 Plug the power cord (1) to the AC adapter and a AC outlet.
- 3 Plug the cable attached to the AC adapter (2) to the right speaker (3).
- 4 Plug the cable from the left speaker (4) to the speaker L jack on the right speaker.
- 5 Plug the speaker cable (5) to the headphones jack on the port replicator.

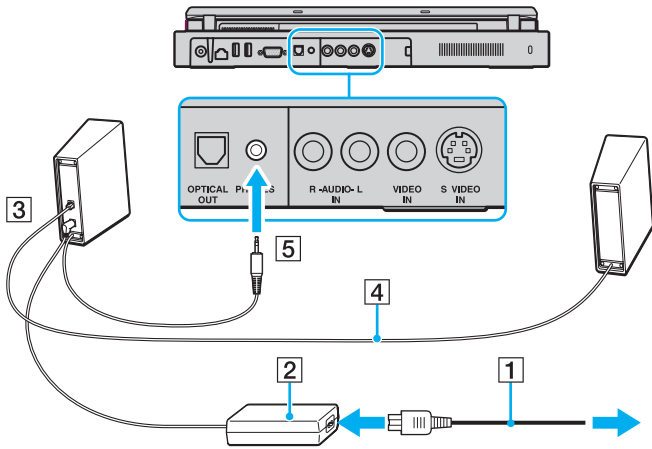

You can also enhance the sound quality of your computer by connecting other external speakers directly to your computer.

To connect external speakers

- 1 Plug the speaker cable (1) into the headphones jack (2) .
- 2 Plug the other end of the speaker cable to the external speaker (3).
- 3 Turn down the volume of the speakers before you turn them on.

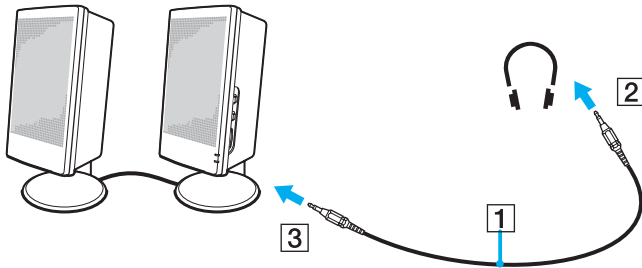

Make sure your speakers are designed for computer use.



Do not place floppy disks on the speakers; their magnetic field may damage the data on the disks.

Using the Remote Commander

A remote commander is delivered with your computer for extended use of the **VAIO Zone** software.

The infrared receiver for communications with the remote commander delivered with VGN-A series models is located on the supplied left external speaker. Make sure to attach your computer to the supplied A/V port replicator and connect the speakers to your computer before using the remote commander.

If your computer is one of VGN-FS series models, you need to connect the supplied external infrared receiver to your computer before using the remote commander.

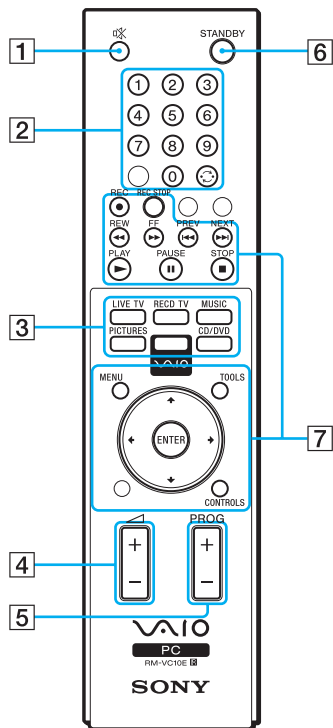

- 1** MUTING button
Turns off the external speakers. Press the MUTING button to turn on the speakers.
- 2** Channel buttons
Select the respective channels.
- 3** Direct buttons
Activate individual features of **VAIO Zone**.
- 4** Volume button
Increases* or decreases the speaker volume.
- 5** Channel control button
Switches the channel in the ascending or descending order.
- 6** STANDBY button
Puts the system into Standby mode.
- 7** Operation buttons
Use these buttons for **VAIO Zone** operations.

* With the remote commander, you can increase the volume only up to the level set by the volume control on the external speaker.

To connect the external infrared receiver to VGN-FS series models

- 1 Choose the USB port (1)  you prefer to use.
 - 2 Plug the external infrared receiver cable (2) into the USB port.
- You can now use your infrared receiver (3).

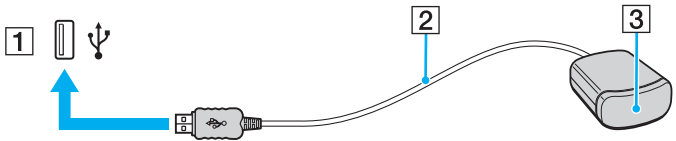

Connecting an External Display

You can connect an external display to your computer. For example, you can use your computer with a computer display or a projector.

- ❑ **Connecting a Computer Display** ([page 90](#))
- ❑ **Connecting a Multimedia Computer Display** ([page 92](#))
- ❑ **Connecting a TV** ([page 93](#))
- ❑ **Connecting a Projector** ([page 96](#))



Connect the power cord after connecting all other cables.

Connected external displays are used as second screens.

On Windows systems only, you can also use an external display to set up multiple monitors.

Connecting a Computer Display

You can connect a computer display (monitor) either directly to your computer or via the (optional) port replicator.

To connect a computer display

VGN-A series models

- 1 If necessary, plug one end of the display's power cord (1) into the display, and the other end into an AC outlet.
- 2 If you want to connect a VGA monitor, plug the display cable (2) (not supplied) into the monitor (VGA) port (3) on the computer or on the port replicator.
- 3 If you want to connect a TFT/DVI monitor, plug the display cable (not supplied) into the DVI-D port on the port replicator.

VGN-FS series models

- 1 If necessary, plug one end of the display's power cord (1) into the display, and the other end into an AC outlet.
- 2 Plug the display cable (2) (not supplied) into the monitor (VGA) port (3) on the computer.

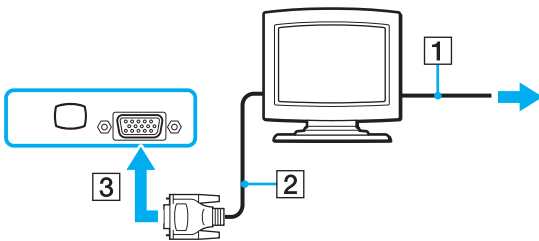



VGN-A series models are equipped with the DVI-D port.

DVI-D stands for **Digital Visual Interface - Digital**. It is a type of DVI connector that supports only digital video signals (no analog video signals). It has 24 pins.

A **DVI-I** connector (**Digital Visual Interface - Integrated**) supports digital video and analog video signals. It has 29 pins.





You can not connect a DVI-I to VGA cable to a DVI-D port!

Connecting a Multimedia Computer Display

You can connect the computer to a multimedia computer display that includes built-in speakers and a microphone.

To connect a multimedia computer display

- 1 Plug the power cord of the multimedia computer display (1) into an AC outlet.
- 2 Plug the display cable (2) (not supplied) into the monitor (VGA) port (3)  on the computer or on the (optional) port replicator.
- 3 Plug the speaker cable (4) into the headphones jack (5)  on the computer.
- 4 Plug the microphone cable (6) into the microphone jack (7)  on the computer.

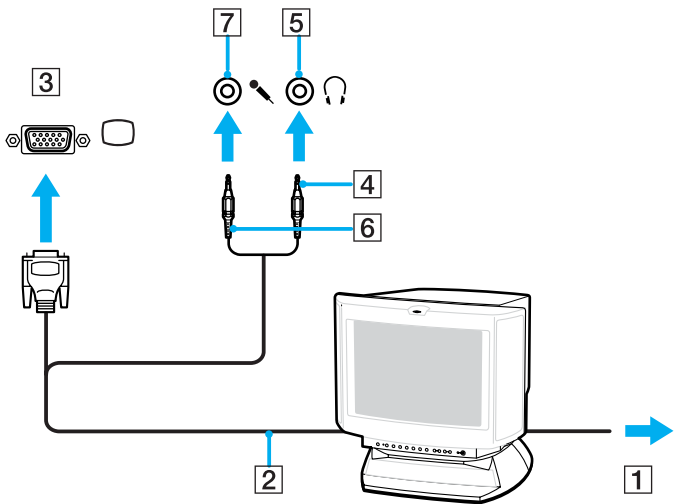

Connecting a TV

You can connect a TV to VGN-A series models or to the port replicator.

To connect a TV to the computer

- 1 Plug the power cord of the TV (1) into an AC outlet.
- 2 Plug one end of an audio/video cable (2) into the AV Out jack (3) ⇨ on the computer and the other to the TV.
- 3 Switch the input channel of the TV to external input.
- 4 Set up the TV configuration system.

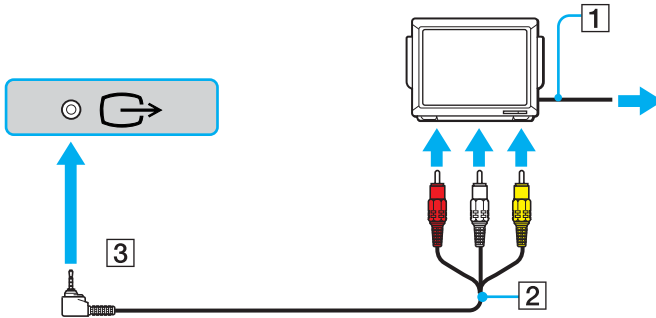

You need to use an AV cable that has a minijack connector on one end and 3 RCA (also called cinch) connectors on the other end. If your TV does not have RCA connectors, but it has a Scart connector, you need an RCA to Scart converter. If your computer has an S-video port, you can use this port as an alternative means of connection.

Please have a look at the **Knowledge Bases** on the VAIO-Link web site.



See the manual supplied with your peripheral for more information on installation and use.

If you insert a DVD in your DVD-ROM drive to watch a video on your TV, the **Fn+F7** key combination might not activate the function to toggle between your LCD and TV.

Solution:

- 1 Eject your DVD from your computer.
- 2 Once the DVD is ejected, toggle between your LCD and your TV with the **Fn+F7** key combination.

Your image appears now on both the LCD and the TV. Re-insert your DVD to launch your DVD software.

If the display resolution of your computer is more than 1024 x 768 pixels, a part of the image cannot be displayed on your TV. The hidden area on your TV can be seen by moving the cursor on your computer. If you want to display the full image, change the display resolution of your computer to **1024 x 768** pixels or lower.

To connect a TV to the port replicator

- 1 Attach the port replicator to your computer.
- 2 Plug one end of an audio/video cable (1) into the Composite Audio Out jacks and the Composite Video Out Jack (2) on the port replicator and the other into the Composite Audio and Video jacks on your TV.
If your TV has s-video input, you can have better visual quality by outputting image to s-video rather than composite video. In such a case, please plug one end of the S-Video cable (3) into the S Video Out jack (4) on the port replicator and the other end into the S Video jack on the TV. You will still need to connect Composite Audio Out jacks in order to hear sound through TV speakers.
- 3 Switch the input channel of the TV to external input.
- 4 Set up the TV configuration system.

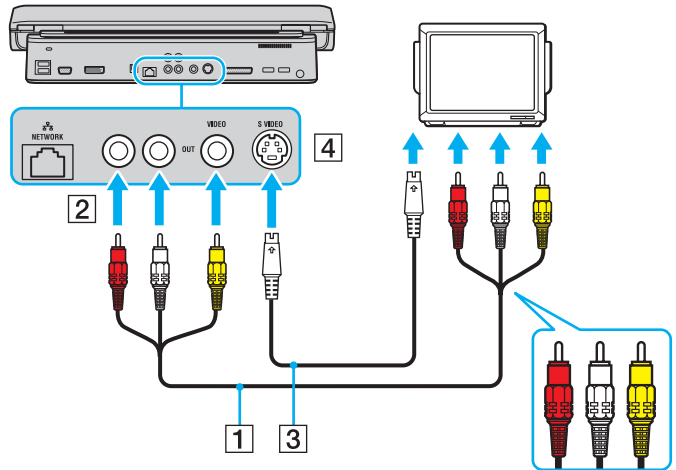

Connecting a Projector

You can connect a projector (such as the Sony LCD projector) directly to your computer or via the port replicator.

To connect a projector

- 1 Connect the power cord (1) of the projector into an AC outlet.
- 2 Plug the RGB signal cable (2) into the monitor (VGA) port (3) on the computer or on the (optional) port replicator.
- 3 Plug the audio cable (4) (not supplied) into the headphones jack (5).
- 4 Plug the RGB signal cable and the audio cable into the jack and port on the projector (6).

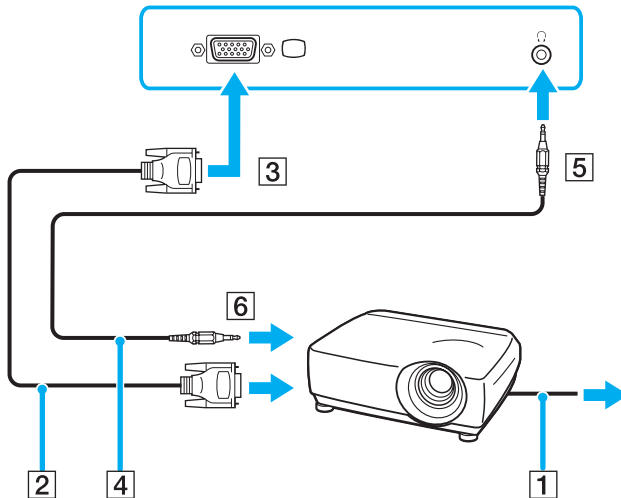

Selecting Display Modes

You can select which display to be used as the primary monitor when an external display (desktop monitor, etc.) is connected to the computer. The procedure for selecting a display, however, depends on the video controller used in your VAIO computer. See the printed **Specifications Sheet** for detailed information on the video controller.

If you want to work on your computer's LCD and the external display at the same time, see **Using the Multiple Monitors Function (page 100)** for more information.

To select a display

Models with the ATI video controller

- 1 Click **Start** and then **Control Panel**.
- 2 Click **Appearance and Themes**.
- 3 Click **Display**.
- 4 Click the **Settings** tab.
- 5 Click **Advanced**.
- 6 Click the **Displays** tab to select a display.
- 7 Click **Apply** and then **OK**.

Models with the Intel 915GM video controller

- 1 Click **Start** and then **Control Panel**.
- 2 Click **Appearance and Themes**.
- 3 Click **Display**.
- 4 Click the **Settings** tab.
- 5 Click **Advanced**.
- 6 Click the tab with its name beginning with **Intel(R)**.
- 7 Click **Graphic Properties**.
- 8 Click the **Devices** tab to select a display.
- 9 Click **OK**.



You may not be able to display on your computer's LCD and the external display or projector at the same time, depending on the type of your external display or projector.

Before turning on your computer, turn on the peripheral devices.

Models with the NVIDIA GeForce Go 6200 video controller

- 1 Click **Start** and then **Control Panel**.
- 2 Click **Appearance and Themes**.
- 3 Click **Display**.
- 4 Click the **Settings** tab.
- 5 Click **Advanced**.
- 6 Click the tab with its name beginning with **GeForce**.
- 7 Select **nView Display Settings** from the left menu.
To change the current display, select the desired display from the **Current display** drop-down list.
To display the output on your computer's LCD and the external display at the same time, select **Clone** from the **nView Display mode** drop-down list.
To specify displays, use the **Primary Display/Secondary Display** drop-down list.
- 8 Click **OK** and then **YES**.

Using the Multiple Monitors Function

The Multiple Monitors function allows you to distribute portions of your desktop across separate displays. For example, if you have an external display attached to the monitor (VGA) port, your computer's LCD and the external display can function as a single desktop.

You can move the cursor from one display to the other. This allows you to drag objects, such as an open application window or a toolbar, from one display to the other.

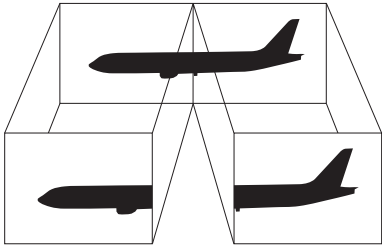

Your external display or TV may not support the Multiple Monitors function.

Certain software applications may not be compatible with Multiple Monitors settings.

Make sure that your computer does not enter **Standby** or **Hibernate** mode while you are using Multiple Monitors mode; otherwise your computer may not return to **Normal** mode.

If you set different colors on each display, do not divide one single window on two displays; otherwise your software may not work properly.

Set fewer colors or a lower resolution for each display.

To select the Multiple Monitors mode

! To find which video controller your computer includes, see the printed **Specifications** sheet.

Models with the ATI video controller

- 1 Click **Start** and then **Control Panel**.
- 2 Click **Appearance and Themes**.
- 3 Click **Display**.
- 4 Select the **Settings** tab.
- 5 Click the monitor icon marked **2**.
- 6 Select the **Extend my Windows desktop onto this monitor** option.
- 7 Click **Apply** and then **OK**.
If the **Monitor Settings** window appears, click **YES**.

Models with the NVIDIA video controller

- 1 Click **Start** and then **Control Panel**.
- 2 Click **Appearance and Themes**.
- 3 Click **Display**.
- 4 Select the **Settings** tab.
- 5 Click **Advanced**.
- 6 Click the tab with its name beginning with **GeForce**.
- 7 Select **nView Display Settings** from the left menu.
- 8 Select **Dualview** from the **nView Display Mode** drop-down list.
- 9 Select **Laptop Display** from the **Primary display** drop-down list.
- 10 Click **OK**.

Models with the Intel video controller

- 1 Right-click on the desktop to display the context menu.
- 2 Point to **Graphics Options** and click **Graphics Properties**.
- 3 Select the **Devices** tab.
- 4 Click **Extended Desktop**.
To change the primary and secondary device settings, use the **Primary Device** and **Secondary Device** drop-down lists under **Extended Desktop Settings**.
- 5 Click **OK**.
If the **Monitor Settings** window appears, click **OK**.



To deactivate the Multiple Monitors mode, deselect the check box in Step 6.



On VGN-A series models, you can also select and deactivate the Multiple Monitors mode just by pressing the **S1** button if you have changed its assignment to **Multiple Monitors** with **VAIO Control Center**. For details on changing the button assignment, see **Setting Up Your Computer with VAIO Control Center (page 120)**.



Additionally, you can set the display colors and resolution for each display and customize the Multiple Monitors mode.

Connecting an External Microphone

If you need to use a sound input device (for example, to chat on the Internet) you need to plug in an external microphone.

To connect an external microphone

Plug the microphone cable (1) into the microphone jack (2) .

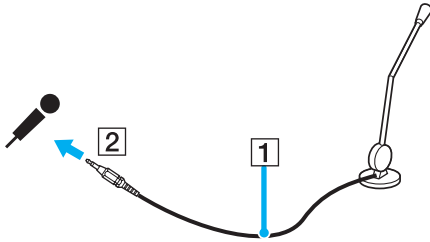

Make sure your microphone is designed for computer use.

Connecting a Universal Serial Bus (USB) Device

To prevent your computer and/or USB devices from damage, observe the following:

- ❑ When moving your computer with USB devices connected, avoid any shock or force to the USB ports.
- ❑ Do not put your computer into a bag or carrying case when it has USB devices connected.

Connecting a USB Mouse

To connect a USB mouse

- 1 Choose the USB port (1)  you prefer to use.
- 2 Plug the USB mouse cable (2) into the USB port.
You can now use your USB mouse (3).

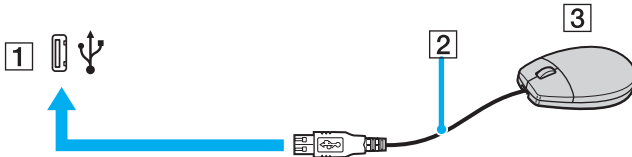

The VAIO USB mouse software driver is preinstalled on your computer. As a result, you only need to plug the USB mouse into the USB port and you can start working.

Connecting a USB Floppy Disk Drive

You can purchase a USB floppy disk drive and connect it to your computer.

To connect a USB floppy disk drive

- 1 Choose the USB port  you prefer to use.
- 2 Plug the USB floppy disk drive cable into the USB port. The VAIO logo on the disk drive should be facing up. Your USB floppy disk drive is now ready for use.

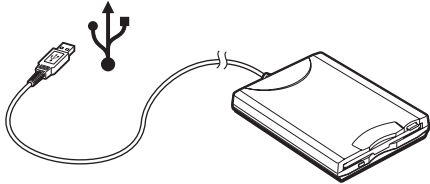

! When using a USB floppy disk drive, do not apply force on the USB port. This may cause a malfunction.

Disconnecting a USB floppy disk drive

You can disconnect a USB floppy disk drive when the computer is on or off. Disconnecting the drive when the computer is in a power saving mode (**Standby** or **Hibernate**) may cause the computer to malfunction.

If your computer is off, you can unplug the USB cable directly from the computer.

To disconnect a USB floppy disk drive

- 1 Close all programs accessing the floppy disk drive.
- 2 Double-click the **Safely Remove Hardware** icon on the taskbar.
The **Safely Remove Hardware** window appears.
- 3 Select the floppy disk drive you want to unplug.
- 4 Click **Stop**.
The **Stop a Hardware device** window appears.
- 5 Make sure the floppy disk drive is selected, and click **OK**. A message appears stating it is now safe to remove the hardware device.
- 6 Remove the floppy disk drive from the computer.

Connecting a Printer

You can connect a Windows-compatible printer to your computer to print documents.

Connecting a Printer Using the USB Port

You can connect a USB printer compatible with your version of Windows to your computer.

To connect a printer using the USB port

- 1 Plug the printer power cord into an AC outlet (1).
- 2 Choose the USB port (3)  you prefer to use.
- 3 Plug one end of a USB printer cable (2) into the USB port and the other end to your printer.

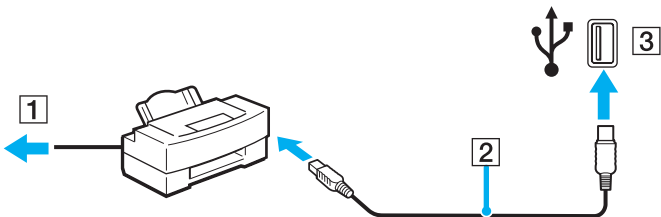

Connecting a Printer Using the Printer Port

To connect a printer using the printer port

- 1 Plug the printer power cord (1) into an AC outlet.
- 2 Plug the printer cable (2) supplied with your printer into the printer port (3)  on the computer or on the (optional) port replicator*.

* Depending on the model you purchased. See the printed **Specifications** sheet for details on your model.

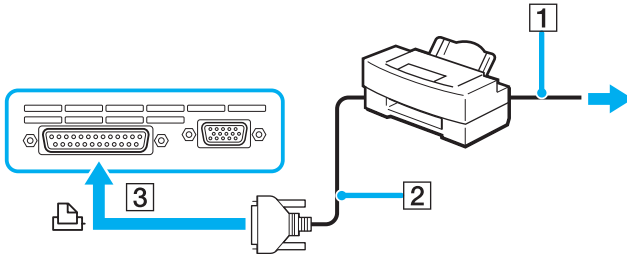

Before connecting the printer, turn off your computer and the printer, and unplug the AC adapter and the power cord.

Connecting an i.LINK Device

Notes on connecting i.LINK devices

- ❑ Your computer includes an i.LINK (IEEE1394) port, which you can use to connect to an i.LINK device such as a digital video camera recorder or to connect two VAIO computers in order to copy, delete or edit files.
- ❑ The i.LINK port of your computer does not supply power to external devices generally powered by i.LINK ports.
- ❑ The i.LINK port supports transfer rates up to 400 Mbps; however, the actual transfer rate depends on the transfer rate of the external device.
- ❑ i.LINK cables compatible with your VAIO computer include cables with the following part numbers:
VMC-IL4415 (a 1.5 meter cable with a 4-pin connector at each end), VMC-IL4408 Series (a 0.8 meter cable with a 4-pin connector at each end).
- ❑ An i.LINK connection with other compatible devices is not fully guaranteed.
- ❑ The i.LINK connection varies depending on the software applications, operating system and i.LINK compatible devices you use. Refer to the manual that came with your software for more information.
- ❑ Check the working conditions and OS compatibility of i.LINK-compatible PC peripherals (HDD, CD-RW drive etc.) before you connect them to your computer.

Connecting a Digital Video Camera Recorder

To connect a digital video camera recorder

- 1 Plug one end of the i.LINK cable (1) into the i.LINK port (2) on the computer and the other end into the DV In/Out ports (3) on the digital video camera recorder.
- 2 Launch the **DVgate Plus** software.

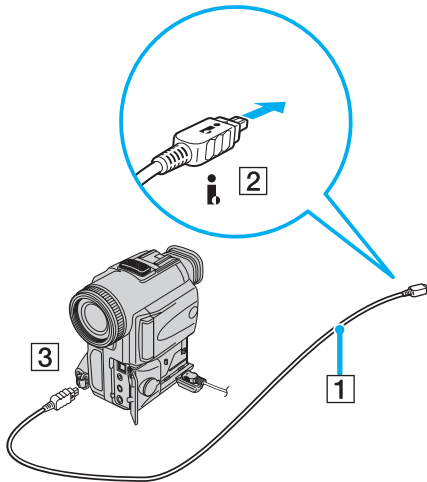

On Sony digital video cameras, ports labeled **DV Out**, **DV In/Out** or **i.LINK** are i.LINK-compatible.

The Sony digital video camera recorder shown here is an example; your digital video camera recorder may need to be connected differently.

You cannot access the pictures stored on a Memory Stick media when using an i.LINK connection.

Connecting to a Network (LAN)

You can connect your computer to 1000BASE-T/100BASE-TX/10BASE-T-type networks* via an Ethernet network cable. Connect one end of an optional network cable to the Network (Ethernet) port on the bottom panel of your computer and the other end to your network. For detailed settings and devices needed to connect to the network, see your Network Administrator.

* Depending on the model you purchased. See the printed **Specifications** sheet to see whether your model supports a 1000BASE-TX connection.

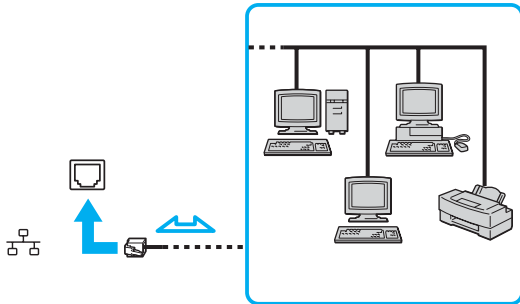

Your computer can be connected to the network with the default settings.

If the main unit is docked, you can only use the Network (Ethernet) port on the port replicator.

! Network and telephone lines cannot be connected to the Network (Ethernet) port on your computer. If the following connectors are connected to the telephone lines mentioned below, high electric current to the connectors may cause damage, overheating or fire.

- Home (intercom speakerphone) or business-use telephone lines (multi-line business telephone)
- Network lines such as 1000BASE-T, 100BASE-TX, and 10BASE-T lines (depending on the model you purchased)
- Public telephone subscriber line
- PBX (private branch exchange)
- Lines other than those mentioned above

! Do not plug a phone cable into your computer network port.

Customizing Your VAIO Computer

This section briefly describes how to change the main settings of your computer. Among other things, you will learn how to prepare your modem for use, how to use and customize the look of your Sony software and utilities, etc.

- ❑ **Setting the Password** ([page 115](#))
- ❑ **Setting Up Your Computer with VAIO Control Center** ([page 120](#))
- ❑ **Using the Power Saving Modes** ([page 122](#))
- ❑ **Managing Power with VAIO Power Management** ([page 127](#))
- ❑ **Setting Up Your Language with Windows XP Professional** ([page 131](#))
- ❑ **Configuring Your Modem** ([page 134](#))
- ❑ **Setting a Sony Wallpaper** ([page 137](#))
- ❑ **Installing and Upgrading Applications** ([page 138](#))
- ❑ **Managing Drivers** ([page 143](#))

Setting the Password

Use one of the BIOS functions to set the password.

Once you have set the password, you will have to enter the password after the VAIO logo appears. In this way, you can protect your computer from unauthorized access.

! You cannot start your computer without entering the password. Make sure not to forget the password.

If you forget the password and need assistance to cancel it, a cancellation fee will be charged.

Adding the Password

To add the password

VGN-A series models

- 1 Turn on your computer.
- 2 Press the **F2** key when the **VAIO** logo appears.
The BIOS setup screen appears. If not, press the **F2** key several times.
- 3 Use the **←** or **→** key to select **Security** and press the **Enter** key.
The password entry screen appears.
- 4 Enter the password **twice** and press the **Enter** key.
The password should be **up to 7 alphanumeric characters** long.
- 5 When **Password installed** appears, press the **Enter** key.



The following is to configure your computer to prompt password entry when you turn on your computer or display the BIOS setup screen.

- 6 Select **Password when Power ON** under **Security**.
Press the **Enter** key, use the **↑** or **↓** key to select **Enabled**, and then press the **Enter** key.
- 7 Use the **←** or **→** key to select **Exit** and then **Exit (Save Changes)**; and press the **Enter** key.
On the **Save configuration changes and exit setup?** screen, confirm that **OK** is selected and then press the **Enter** key.

VGN-FS series models

- 1 Turn on your computer.
- 2 Press the **F2** key when the **VAIO** logo appears.
The BIOS setup screen appears.
- 3 Use the **←** or **→** key to select **Security** to display another screen, select **Set Machine Password**, and then press the **Enter** key.
- 4 On the password entry screen, enter the password **twice** and press the **Enter** key.
The password should be **up to 7 alphanumeric characters** long.



The following is to configure your computer to prompt password entry when you turn on your computer or display the BIOS setup screen.

- 5 Select **Password When Power ON** under **Security**.
Press the space bar to change the setting from **Disabled** to **Enabled**.
- 6 Use the **←** or **→** key to select **Exit** and then **Exit (Save Changes)**; and press the **Enter** key.
On the **Setup Confirmation** screen, confirm that **Yes** is selected and then press the **Enter** key.

Changing/Removing the Password

To change or remove the password

VGN-A series models

- 1 Turn on your computer.
- 2 Press the **F2** key when the **VAIO** logo appears.
The BIOS setup screen appears. If not, press the **F2** key several times.
- 3 Enter the current password for **Enter CURRENT Password**:
- 4 Use the **←** or **→** key to select **Security** to display another screen, select **Set Machine Password**, and then press the **Enter** key.
The password entry screen appears.
- 5 Enter a new password **twice** and press the **Enter** key.
Enter a new password both for **Enter New Password** and **Confirm New Password**.
When **Password installed** appears, press the **Enter** key.
To remove the password, leave **Enter New Password** blank and press the **Enter** key.
- 6 Use the **←** or **→** key to select **Exit** and then **Exit (Save Changes)**; and press the **Enter** key.
On the **Save configuration changes and exit setup?** screen, confirm that **OK** is selected and then press the **Enter** key.

VGN-FS series models

- 1 Turn on your computer.
- 2 Press the **F2** key when the **VAIO** logo appears.
The BIOS setup screen appears. If not, press the **F2** key several times.
- 3 Enter the current password for **Enter Password**:
- 4 Use the **←** or **→** key to select **Security** to display another screen, select **Set Machine Password**, and then press the **Enter** key.
- 5 On the password entry screen, enter the **current password once** and then a **new password twice**; and press the **Enter** key.
To remove the password, leave **Enter New Password** and **Confirm New Password** blank and press **Enter**.
- 6 Use the **←** or **→** key to select **Exit** and then **Exit (Save Changes)**; and press the **Enter** key.
On the **Setup Confirmation** screen, confirm that **Yes** is selected and then press the **Enter** key.

Setting Up Your Computer with VAIO Control Center

The **VAIO Control Center** utility allows you to consult system information and specify preferences for system behavior.

To use VAIO Control Center

- 1 Click **Start**, point to **All Programs**, and click **VAIO Control Center**.
The **VAIO Control Center** window appears.

<i>Control item</i>	<i>Description</i>
System Information	Displays the information about your operating system and the hardware configuration.
Initial Setting	You can specify the order in which the system checks for devices containing a bootable system when it starts.
Built-in Pointing Device	You can enable or disable the built-in pointing device.
S Button	You can change the functions assigned to the computer's S buttons. Available pre-defined assignments are as follows. For VGN-A series models: Stand by, Hibernate, External Display, Launch Application, VAIO Zone^{*1}, Multiple Monitors For VGN-FS series models: Muting^{*1}, Stand by, Hibernate, Max Brightness, External Display^{*2}, Launch Application, VAIO Zone, SSMS Audio Filter, Multiple Monitors
Screen Resolution (VGN-A series/ VGN-FS series only ^{*3})	Specify settings for the screen resolution when an external display is connected to your computer.
Plug and Display	You can specify settings for automatic output to the external display.
Automatic Brightness (VGN-A series only)	You can specify settings for the auto luminance sensor. The auto luminance sensor senses the brightness from outside then the display brightness is adjusted accordingly.
Station and Port replicator	You can specify the behavior when station or port replicator is connected to your computer.

*1 Default S1 button assignment

*2 Default S2 button assignment

*3 On models with the Intel 915GM video controller only. See the printed **Specifications** sheet for the video controller used in your computer.

- 2 Select the desired control item and change the settings.
- 3 Once finished, click **OK**.
The setting of the desired item has been changed.



For more information about each option, click **Help** on the **VAIO Control Center** window to display the help file.

Some of the control items will not be visible if you open **VAIO Control Center** as a limited user.

Using the Power Saving Modes

When you use a battery as the power source for your computer, you can take advantage of power management settings to conserve battery life. In addition to the normal operating mode, which allows you to turn off specific devices, your computer has two distinct power saving modes: **Standby** and **Hibernate**. When using battery power, you should be aware that the computer automatically enters **Hibernate** mode when the remaining battery charge becomes short, regardless of the power management setting you select.



If the battery level falls below 10 percent, you should either attach the AC adapter to recharge the battery or shut down your computer and install a fully charged battery.

Using Normal Mode

This is the normal state of your computer when it is in use. The green power indicator light is on in this mode. To save power while not working, you can turn off a specific device such as the LCD or the hard disk.

Using Standby Mode

Standby mode turns off the LCD screen and sets the hard disk and the CPU to a low power consumption mode. The amber power light flashes in this mode.

To activate Standby mode

- 1 Click **Start** and then **Turn Off Computer**.
- 2 Click **Stand By**.

To return to Normal mode

Press any key.



If you press the power button for more than four seconds, the computer will switch off automatically. You will lose any unsaved data.

When the computer is in **Standby** mode, you cannot insert a disc.

The computer comes out of **Standby** mode quicker than out of **Hibernate** mode.

Standby mode uses more power than **Hibernate** mode.

If the battery runs down when your computer enters **Standby** mode, you will lose any unsaved data. Going back to the previous work state is impossible.

To avoid loss of data, you should save your data frequently.

If the computer is not used for 25 minutes, it will enter **Standby** mode. To avoid this, you can change the **Standby** mode settings.

To change the Standby mode settings

- 1 Right-click the **power status** icon on the taskbar.
- 2 Select **Adjust Power Properties**.
The **Power Options Properties** window appears.
- 3 Select the **Power Schemes** tab.
- 4 Change the settings in **Settings for VAIO optimized power scheme**.

Using Hibernate Mode

In **Hibernate** mode, the state of the system is saved on the hard disk and power is turned off. Even when the battery runs down, no data will be lost. The power indicator light is off in this mode.

To activate **Hibernate** mode

Press the **Fn+F12** keys.

The **Hibernating** screen appears and the computer enters **Hibernate** mode.

Alternatively,

- 1 Click **Start** and then **Turn Off Computer**.
- 2 Hold down the **Shift** key and click **Hibernate**.

To return to Normal mode

Turn on the computer by pressing the power button.

The computer returns to its previous state.



If you press the power button for more than four seconds, the computer will switch off automatically.

If you do not use the AC adapter for a long period of time, put your computer into **Hibernate** mode. This power saving mode saves you the time of shutting down in the normal way.

When the computer is in **Hibernate** mode, you cannot insert a disc.

Hibernate mode requires more time than **Standby** mode to be activated.

It takes more time to return to **Normal** mode from **Hibernate** mode than from **Standby** mode.

Hibernate mode uses less power than **Standby** mode.

Do not move the computer until its power indicator turns off.

Managing Power with VAIO Power Management

Power management helps you to set up power schemes for running on AC power or batteries to suit your requirements for power consumption.

VAIO Power Management is a software application developed exclusively for VAIO computers. With this software application, you can enhance the Windows power management functions to ensure better operations of your computer and for longer battery life.

Activating VAIO Power Management

When you start the computer, a **power status** icon appears on the taskbar. This icon indicates what kind of power source you are using at that time, for example, AC power. If you double-click this icon, the **Power Meter** window appears showing you the power status.

VAIO Power Management functionalities are added to the Windows **Power Options Properties**.

To activate VAIO Power Management

- 1 Right-click the **power status** icon on the taskbar.
- 2 Select **Adjust Power Properties**.
The **Power Options Properties** window appears.
- 3 Select the **VAIO Power Management** tab.

To restore the default settings

- 1 On the **VAIO Power Management** tab, click **Advanced**.
The **VAIO Power Management** window appears.
- 2 Click **Reset by default**.
The **Confirm** window appears.
- 3 Select **Restore all power schemes to the original factory default settings**.
- 4 Click **OK**.
The default settings are restored for all the power scheme options.

Activating VAIO Power Management Power Schemes

VAIO Power Management provides several predefined **power schemes**. Each power scheme consists of a group of power management settings that are designed to meet specific power management goals, ranging from maximum power management to no power management.

To activate a VAIO Power Management power scheme

- 1 Right-click the **power status** icon on the taskbar.
- 2 Select **Adjust Power Properties**.
The **Power Options Properties** window appears.
- 3 Select the **Power Schemes** tab.
- 4 Select a power scheme from the **Power schemes** drop-down list.
- 5 If you now select the **VAIO Power Management** tab, you see that the selected power scheme appears to the right of **Power Scheme**.
- 6 If necessary, you can change the items in the list, for example, the brightness of the LCD.
- 7 Click **OK**.
The power scheme has been activated.



You must have computer administrator rights on your computer to set up a power scheme.

For more information on **VAIO Power Management** and **Power Schemes**, see the help guide of the **VAIO Power Management** software.

<i>Power Scheme</i>	<i>Description</i>
Power Management Off	Turns off all power management features such as Standby and Hibernate modes.
VAIO Optimized	The default power management state for either power source.
VAIO Maximum Battery	Provides power saving features to provide maximum battery life and good performance when battery power is in use. It reduces the brightness of the display and puts the system into Standby mode after a specified time period.
VAIO Ultimate Battery	Extends the VAIO Maximum Battery by completely disabling the optical disc drive.



If you have a mobile computer, a CPU control icon may appear on the taskbar. The CPU control icon indicates the CPU control status (Performance, Adaptive, Battery Life, Degrade). To display the icon, click the **Advanced** button on the **VAIO Power Management** tab. Select the **Show CPU status icon in the taskbar** box and then click **OK**.

For more details on the CPU control icon, see the online help file (**Other Information - Icons on the Notification Area**).

Setting Up Your Language with Windows XP Professional

Windows XP Professional computers are equipped with the **Multilingual User Interface (MUI)** feature. It allows you to change the English operating system, some software applications and the keyboard layout into the language of your choice: **French, German, Japanese, Dutch, Italian, Spanish, Czech, Finnish, Greek, Portuguese** and **Swedish**.

It is important that you select the correct keyboard settings during the Windows Setup.

To select the correct keyboard settings during Windows Setup

- 1 At first boot, click **Next**, then **Next** again in the **Windows XP Setup Wizard** window. The **Select Your System Settings** window appears.
- 2 Fill in these three questions:
 - I live the closest to this region.
 - I type mostly in this language.
 - I use this type of keyboard.
- 3 In the **End User License Agreement**, accept the License Agreement and click **Next**.
- 4 Continue your Windows setup until it is finished.

You can also change the country and language settings into your language as soon as Windows has been restarted.

To change the country and language settings

- 1 Click **Start** and then **Control Panel**.
- 2 In the **Control Panel** window, double-click the **Regional and Language Options** icon. If you do not see this icon, click **Switch to Classic View** on the left side.
- 3 In the **Regional Options** tab of the **Regional and Language Options** window, select **your language** from the **Standards and formats** drop-down menu.
- 4 In the **Advanced** tab of the **Regional and Language Options** window, select **your language** from the **Language for non-Unicode programs** drop-down menu.
- 5 To change the language of the Windows menus, windows and online help files provided by Microsoft Windows, select the **Languages** tab of the **Regional and Language Options** window.



Non-Microsoft Windows applications stay in English, even if you change these settings.

- 6 Select your language from the drop-down list.
- 7 Click **Apply** to apply the changes. You are prompted to log off and log on again. Only then, the changes to the new language will take effect.
- 8 Click **Start**, and select **Log Off**.
- 9 Click **Log Off** in the **Log Off Windows** window. If necessary, enter your password to log on again. All the menus, help files and icons are then displayed in your selected language. However, some parts may remain in English.

To change the keyboard layout

- 1 Click **Start** and then **Control Panel**.
- 2 In the **Control Panel** window, double-click the **Regional and Language Options** icon.
If you do not see this icon, click **Switch to Classic View** on the left side.
- 3 In the **Languages** tab of the **Regional and Language Options** window, click the **Details** button.
The **Text Services and Input Languages** window appears.
- 4 In the **Settings** tab of the **Text Services and Input Languages** window, select your keyboard from the **Default input language** drop-down menu.
- 5 If your keyboard is not available, click the **Add** button.
The **Add Input Language** window appears.
- 6 Select the input language and keyboard from the drop-down menu.
- 7 Click the **OK** button to close the **Add Input Language** window.
- 8 Click the **OK** button to close the **Regional and Language Options** window.

Configuring Your Modem

Before you can start using your internal modem (not all modems are built-in), or each time you use your modem while traveling, make sure that the country of the active location defined in the **Phone and Modem Options** dialog box matches the country you are dialing from.

You may notice a **Country Selector** tab under your current modem driver options. As the **Country Selector** tab is not a constant feature, do not use this tab to change the country settings. Only the following procedure is reliable.

To change your modem country settings

- 1 Click **Start** and then **Control Panel**.
- 2 Double-click **Phone and Modem Options**.
The **Phone and Modem Options** window appears.
If you do not see the **Phone and Modem Options** window, click **Switch to Classic View** on the left side.
- 3 Select your location on the **Dialing Rules** tab.
- 4 Click the **Edit** button to change the current configuration.
The **Edit Location** window appears.
Or
Click the **New** button to configure your modem.
The **New Location** window appears.
- 5 Check the country/region settings, and make sure it matches the place you are dialing from.



Pulse dial may not be supported in some counties and/or regions.

- 6 If you modified your location settings, click **Apply**, and then **OK**.
The **Phone and Modem Options** window appears.
- 7 Check that your modem is listed in the **Modems** tab.
If your modem is not listed, click **Add** and follow the wizard.
- 8 Click **Apply/OK**. Your modem is configured.



Before applying new country settings, please make sure your phone cable is disconnected from your computer.

Updating the Modem Driver

To update the modem driver

- 1 Click **Start** and then **Control Panel**.
- 2 Click **Printers and Other Hardware**.
- 3 Click **Phone and Modem Options**.
The **Phone and Modem Options** window appears.
- 4 Click the **Modems** tab and then click **Properties** to view the properties of your modem.
The **Modem Properties** window appears.
- 5 On the **Driver** tab, click **Update driver**.
The **Hardware Update Wizard** window appears.
Follow the on-screen instructions. You can perform a Windows search for the driver, or point to the driver's location yourself.

Setting a Sony Wallpaper

Your Sony VAIO computer offers you, among many other features, a choice of wallpapers. You can change the wallpaper, the background of your desktop, as many times as you like. There are several VAIO-specific wallpapers to choose from.

To set another VAIO wallpaper

- 1 Click **Start** and then **Control Panel**.
- 2 Click **Appearance and Themes**.
- 3 Click **Display**.
- 4 Click the **Desktop** tab.
A list of Windows and VAIO wallpapers is displayed.
- 5 Select a wallpaper from the **Background** list.
You can see a preview of this wallpaper in the monitor above the **Background** list.
- 6 Adjust the position of the wallpaper with the **Position** drop-down list.
- 7 Click **Apply** when you have found the appropriate wallpaper.
- 8 Click **OK**.
The wallpaper is applied to your computer.



A higher screen resolution reduces the size of items on your screen and increases the relative space on your desktop.

You may not be able to increase the screen resolution above a certain level. Your monitor and video adapters, for example, determine to which extent you can change the resolution.

Installing and Upgrading Applications

This section explains how to install, run or uninstall software.

Furthermore, you will learn how to download the latest updates from our web site.

- ❑ **Installing Software** ([page 139](#))
- ❑ **Changing or Removing Software** ([page 140](#))
- ❑ **Caution** ([page 141](#))
- ❑ **Downloading Software** ([page 142](#))

Installing Software

To install bundled software from the supplied **Recovery Disc** or your hard disk drive, see the printed **Recovery Guide** for details. For software bundled with accessories, check first the installation procedure that comes with the accessory.

To install other software, use the following procedure.

Before installing the applications:

- Install and connect a hardware device, if necessary (see the **Managing Drivers (page 143)** section);
- Close all open applications.

To install an application

- 1 Click **Start** and then **Control Panel**.
- 2 Click **Add or Remove Programs**.
- 3 Click **Add New Programs**, and then click **CD or Floppy**.
The **Install Program From Floppy Disk or CD-ROM** window appears.
- 4 Insert the first installation floppy disk or CD-ROM and click **Next**.
The **Run Installation Program** appears.
- 5 For the rest of the procedure, follow the on-screen instructions.



When using **Add or Remove Programs**, you can only install programs that were written for Windows operating systems.

Changing or Removing Software

You can remove or change a software application any time you like. Before proceeding, close the application you want to change/remove.

To change or remove software

- 1 Click **Start** and then **Control Panel**.
- 2 Click **Add or Remove Programs**.
- 3 Select the software you want to change or remove.
 - To change a program, click **Change/Remove** or **Change** and follow the on-screen instructions.
 - To uninstall a program, click **Change/Remove** or **Remove**, then click **Next** followed by **OK**.
If the **Locked file detected** window appears, click **Reboot**. The computer restarts once uninstallation is completed and all previously used files are deleted.
If the **Shared file detected** window appears, it is recommended that you click **No** to keep shared files.
Click **Close**.
The software is uninstalled.

! When you click **Change or Remove**, some programs may be removed without any further warning. **Make sure you are certain you want to remove it beforehand.**



You can sort programs by selecting different options in **Sort by**.

Add or Remove Programs will only remove programs that were written for Windows operating systems. For other programs, check the documentation to see if other files (such as .ini files) should be removed.

Caution

Windows File Protection

Installing a program might overwrite shared system files such as **dynamic-link libraries** (DLL files)* and executable files (EXE files). When system files are overwritten, system performance becomes unpredictable, programs behave erratically, and the operating system can fail.

Never delete files with the following extensions: SYS, DLL, OCX, TTF, or FON.

In Windows XP, **Windows File Protection** prevents the replacement of protected system files such as SYS, DLL, OCX, TTF, FON, and EXE files. **Windows File Protection** runs in the background and protects all files installed by the **Windows Setup** program.

Windows File Protection detects attempts by other programs to replace or move a protected system file. It also checks the file's digital signature.

* This is an operating system feature that allows executable routines (generally serving a specific function or set of functions) to be stored separately as files with DLL extensions. These routines are loaded only when needed by the program that calls them.

File Signature Verification

When you install a new application on your computer, you might overwrite system files and device driver files with unsigned or incompatible versions, which provokes system instability.

The system files and device driver files provided with Windows XP have a Microsoft digital signature, which indicates that the files are original, unaltered system files or that they have been approved by Microsoft for use with Windows.

Downloading Software

Please note it is possible to download the latest upgrades of software for your computer from our web site.

To download the latest upgrades

- 1 Go to www.vaio-link.com and choose your language.
- 2 Select **Drivers and Updates** and follow the procedure.



To install your application, see **Installing Software (page 139)**.

Managing Drivers

A driver is software enabling you to use hardware devices. For example, in order for you to be able to use a printer, you must first install its driver. Many drivers, such as the mouse driver, come with the operating system.

This section explains how to install, check, update or uninstall a driver.

The Windows XP Rollback feature is also explained.

Finally, you will learn how to download the latest drivers from our site.

- ❑ **Installing a Driver** ([page 144](#))
- ❑ **Checking the Driver's Installation** ([page 146](#))
- ❑ **Updating a Driver** ([page 148](#))
- ❑ **Uninstalling a Driver** ([page 149](#))
- ❑ **Restoring a Driver** ([page 151](#))
- ❑ **Downloading Drivers** ([page 153](#))

Installing a Driver

For more information on (re)installing drivers, see the printed **Recovery Guide** for details.

To install a driver that is stored on the C: drive

- 1 Go to the folder **C:\Drivers**.
- 2 Select the correct folder.
If you need to update a modem driver, for example, select the **Modem** folder.
- 3 If there is an .exe file, double-click the .exe file and follow the online procedure.
If there is no .exe file, you need to go through the **Device Manager** to update the driver (see the second option in the **Updating a Driver (page 148)** chapter).

If the driver comes on a CD-ROM or disc accompanying an accessory and the driver does not come with a specific installation procedure, proceed as follows to install it:

- 1 Insert the installation CD-ROM or disc accompanying the device into the optical disc drive.
- 2 Connect the device that needs a driver, to your computer.
The **Found New Hardware Wizard** window appears.
- 3 Select **Specify a location**, then click **Next**.
- 4 When installing a driver from the provided CD-ROM (or disc) by using a CD-ROM (or disc) drive connected to the computer, select the **Drivers** folder on the optical disc drive.
- 5 When installing a driver after having copied the contents of the provided CD-ROM (or disc) to your hard disk, browse to the appropriate subdirectory containing the driver. The subdirectory should be found in the folder you copied from the CD-ROM (or disc).
- 6 Click **OK** to begin the search procedure.
- 7 Click **Next** to install the driver.
A new window appears when the driver has been installed.
- 8 Click **Finish**.
You may be asked to restart your machine.
- 9 Click **Yes**.
The driver is installed.



To install your device driver, you must log on to your computer as a user with administrator rights.

Checking the Driver's Installation

When the computer restarts, check that the device is working properly.

To check the driver's installation

- 1 Click **Start** and then **Control Panel**.
- 2 Click **Performance and Maintenance**.
- 3 Click **System**.
- 4 Click the **Hardware** tab, then click **Device Manager**.
- 5 Double-click the option corresponding to the device you installed, then double-click your device. The **Properties** dialog box appears.
- 6 Make sure that the **This device is working properly** message is displayed under **Device status**.
- 7 Click **OK**.
Close all the opened windows, your device is ready for use.

The device is not working properly in the following cases:

- Your device is shown in **Device Manager** with a yellow question or exclamation mark.
Right-click your device and click **Uninstall**. Then repeat from step 2 in **Installing a Driver (page 144)**.
- Double-clicking the category of your device in the device manager list does not display your device.
You have to remove your device. See **Uninstalling a Driver (page 149)** to remove it. Then repeat from step 2 in **Installing a Driver (page 144)**.
- Double-clicking **Other devices** displays your device.
You have to right-click your device, then click **Uninstall**. Repeat from step 2 in **Installing a Driver (page 144)**.

- ❑ If the **This device is working properly** message is not displayed, the device is not working properly. Click **OK** to close the **Properties** window, then reinstall the driver. To reinstall the driver, right-click **Uninstall** and click **OK** when the **Confirm Device Removal** window appears. When a message window asking you to confirm restart, click **Yes** and wait until your computer restarts. Then, repeat from step 2 in **Installing a Driver (page 144)**.
- ❑ If your device is not displayed in the **Properties** window, the device is not working properly. Repeat steps 1 through 4 in the previous sections to check the driver's installation. Click your device, then click **Uninstall** to remove the driver. Click **Yes** to restart the computer. When the computer restarts, repeat from step 2 in **Uninstalling a Driver (page 149)**.

Updating a Driver

To update the driver

- 1 Click **Start** and then **Control Panel**.
- 2 Click **Printers and Other Hardware**.
- 3 Click the device you want to revert.
- 4 On the **Hardware** tab, click **Properties**.
- 5 On the **Driver** tab, click **Update Driver**.
- 6 Follow the on-screen instructions. You can have Windows search for the driver, or point to the driver's location yourself.

Or:

- 1 Click **Start** and then **My Computer**.
- 2 Click **View system information** on the left of the window.
- 3 Click the **Hardware** tab, then click **Device Manager**.
- 4 Double-click the option corresponding to the device you installed, then double-click your device. The **Properties** window appears.
- 5 Click the **Driver** tab.
- 6 Click **Update driver**.
The driver is updated.



To install your device driver, you must log on to your computer as a user with administrator rights.

Uninstalling a Driver

Leave the device connected to your computer while uninstalling the driver.

To uninstall the driver

- 1 Click **Start** and then **Control Panel**.
 - 2 Click **Printers and Other Hardware**.
 - 3 Click the device you want to revert.
 - 4 On the **Hardware** tab, click **Properties**.
 - 5 On the **Driver** tab, click **Uninstall**.
 - 6 When the **Confirm Device Removal** window appears, click **OK**.
 - 7 If you are prompted to restart your computer, click **Yes**.
- The **Uninstall** button is unavailable if removing the driver would make your device unusable.

Or:

- 1 Click **Start** and then **My Computer**.
- 2 Click **View system information** on the left of the window.
- 3 Click the **Hardware** tab, then click **Device Manager**.
- 4 Double-click the option corresponding to the device you installed, then double-click your device. The **Properties** window appears.
- 5 Click the **Driver** tab.
- 6 Click **Uninstall**.
- 7 When the **Confirm Device Removal** window appears, click **OK**. The driver is uninstalled.



To uninstall your device driver, you must be logged on to your computer with administrator rights.

Restoring a Driver

System Restore is a feature of Microsoft Windows XP that restores your computer to a previous state, if a problem occurs, without losing your personal data files.

System Restore monitors changes to the system, and it automatically creates easily identified restore points. These restore points allow you to revert the system to a previous time. They are created daily and at the time of significant system events (such as when an application or driver is installed).

To revert to your previous driver

- 1 Click **Start** and then **Control Panel**.
- 2 Click **Printers and Other Hardware**.
- 3 Click the device you want to revert.
- 4 On the **Hardware** tab, click **Properties**.
- 5 Click the **Driver** tab.
- 6 On the **Driver** tab, click **Roll Back Driver**.

Or:

- 1 Click **Start** and then **My Computer**.
- 2 Click **View system information** on the left of the window.
- 3 Click the **Hardware** tab, then click **Device Manager**.
- 4 Double-click the option corresponding to the device you installed, then double-click your device. The **Properties** window appears.
- 5 Click the **Driver** tab.
- 6 On the **Driver** tab, click **Roll Back Driver**.
You have your previous driver back.



You must be logged on to your computer with administrator rights in order to complete this procedure.

Restoring your computer does not affect or change your personal data files.

For more information about System Restore, see the Windows **Help and Support Centre**.

Downloading Drivers

Note that it is possible to download the latest versions of drivers for your computer on our web site.

To download the latest drivers

- 1 Go to www.vaio-link.com and choose your language.
- 2 Select **Drivers and Updates** and follow the procedure.

For more information, follow the instructions you received with the device, or see the printed **Recovery Guide**.



Downloading or installing drivers not provided by VAIO-Link might cause compatibility issues.

Upgrading Your VAIO Computer

Your computer and memory modules use high precision components and electronic connectors technology. To avoid the invalidation of your guarantee due to mishandling, we recommend that:

- You contact your dealer to install a new memory module.
- You do not install it yourself, if you are not familiar with upgrading memory on a computer.
- You do not touch the connectors or open the memory panel.

For the type of module and amount of memory installed on your computer, refer to the printed **Specifications** sheet.

Contact VAIO-Link if you need assistance.

Adding and Removing Memory

If you want to expand the functionality of your computer, you can increase the memory by installing optional memory modules. Before you upgrade your computer's memory, read the notes and procedures in the following pages. The number of available slots depends on the configuration of your computer.

Notes on adding/removing memory modules

- ❑ Be careful when changing memory. Improper installation of memory modules may cause damage to your system. This damage may void your manufacturer's warranty.
- ❑ Only use memory modules that are compatible with your computer. If a memory module is not detected by your computer or Windows becomes unstable, contact your sales dealer or the manufacturer of your memory module.
- ❑ Electrostatic discharge can damage electronic components. Before touching a memory module, ensure the following:
 - ❑ The procedures described in this document assume familiarity with the general terminology associated with personal computers and with the safety practices and regulatory compliance required for using and modifying electronic equipment.
 - ❑ Turn off the computer and disconnect the system from its power source (that is, battery or AC adapter) and from any telecommunication links, networks, or modems before you open the computer. Failure to do so may result in personal injury or equipment damage.
 - ❑ Electrostatic Discharge (ESD) can damage memory modules and other components. Install the memory module only at an ESD workstation. If such a station is not available, do not work in a carpeted area, and do not handle materials that produce or hold static electricity (cellophane wrappers, for example). Ground yourself by maintaining contact with an unpainted metal portion of the chassis while performing the procedure.
 - ❑ Do not open the memory module package until you are ready to change the module. The package protects the module from ESD.
- ❑ Use the special bag delivered with the memory module or wrap the module in aluminum foil to protect it from electrostatic discharge.

- Introducing any liquids or any foreign substances or objects into the memory slots, or other internal components of the computer, will result in damage to the computer and any repair costs will not be covered by the warranty.
- Do not place the memory module in places subject to:
 - Heat sources such as radiators or air ducts
 - Direct sunlight
 - Excessive dust
 - Mechanical vibration or shock
 - Strong magnets or speakers that are not magnetically shielded
 - Ambient temperature of more than 35°C or less than 5°C
 - High humidity
- Handle the memory module with care. To avoid injuries to your hands and fingers, do not touch the edges of the components and circuit boards inside your computer.

Removing and Installing a Memory Module

VGN-A series models

To change or add a memory module to the memory module slot on the bottom of the computer

- 1 Shut down your computer and disconnect all peripheral devices.
- 2 Unplug the computer and remove the battery.
- 3 Wait until the computer cools down.
- 4 Unscrew the central screw on the bottom of the computer and remove the memory module compartment cover.

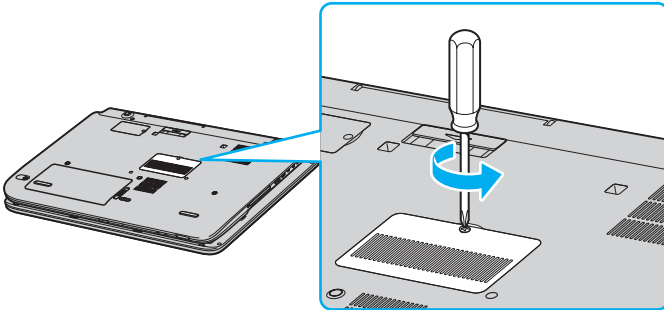

5 Touch a metal object (such as the connector panel on the back of the computer) to discharge static electricity.

6 Remove the memory module:

- ❑ Pull the tabs in the direction of the arrows (1).
The memory module is released.

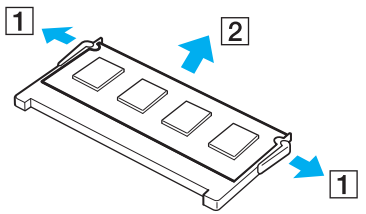

- ❑ Make sure that the memory module tilts up and then pull it out in the direction of the arrow (2).

7 Remove the new memory module from its packaging.

8 Install the memory module.

- Slide the memory module into the slot.

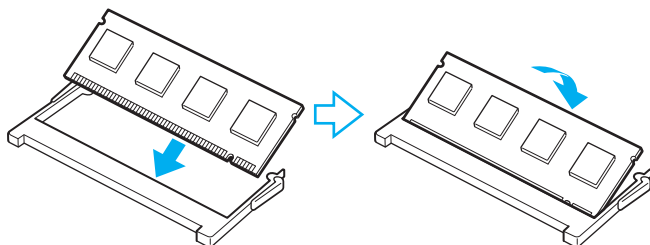

- Push in the memory module until it clicks into place.

!

Do not touch any other components on the motherboard.

9 Close the memory module compartment cover and then tighten the screws on the bottom of the computer.**10** Reinstall the battery pack and turn on the computer.

To change or add a memory module to the memory module underneath the keyboard

- 1 Shut down your computer and disconnect all peripheral devices.
- 2 Unplug the computer and remove the battery pack.
- 3 Wait until the computer cools down.
- 4 Unscrew the two screws next to the memory slot.

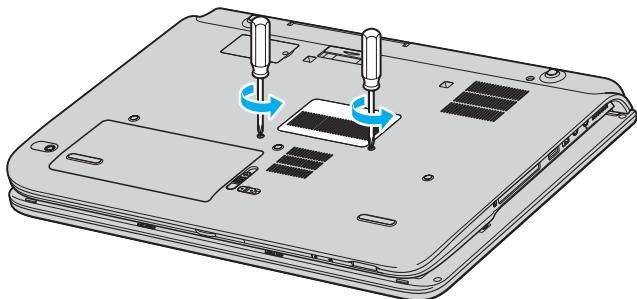

- 5 Turn over the computer upside down and open the LCD screen lid.
- 6 Introduce a sharp object (such as a fine screwdriver) between the keys indicated on the picture (1) and push gently upwards.

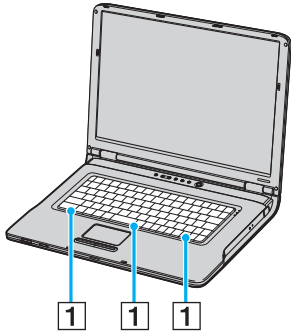

- 7 Lift the keyboard from the touch pad side, turn it over the indicators, and gently prop it up against the LCD display. Be careful not to detach the cable when lifting the keyboard.

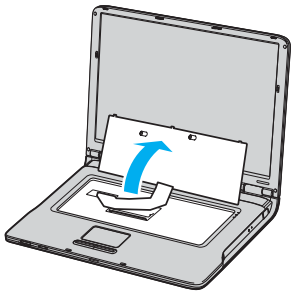

- 8 Touch a metal object (such as the connector panel on the back of the computer) to discharge static electricity.
- 9 Remove the memory module:
 - ❑ Pull the tabs in the direction of the arrows (1).
The memory module is released.

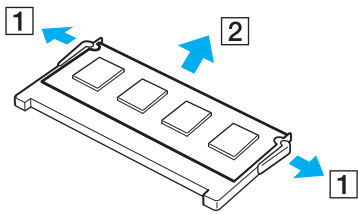

- ❑ Make sure that the memory module tilts up and then pull it out in the direction of the arrow (2).
- 10 Remove the new memory module from its packaging.

11 Install the memory module.

- ❑ Slide the memory module into the slot.

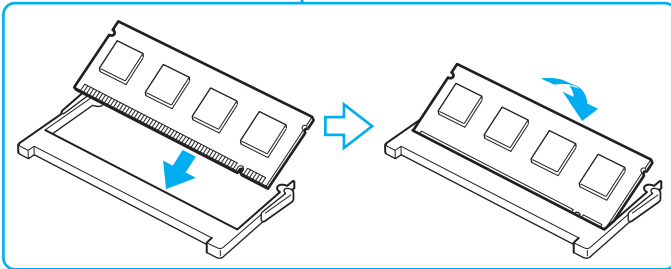
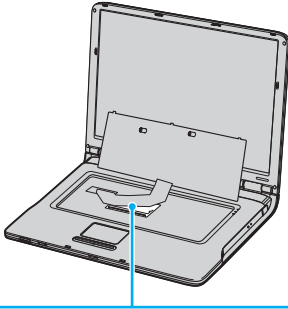

- ❑ Push in the memory module until it clicks into place.

! Do not touch any other components on the motherboard.

12 Gently replace the keyboard and then press it into the computer.

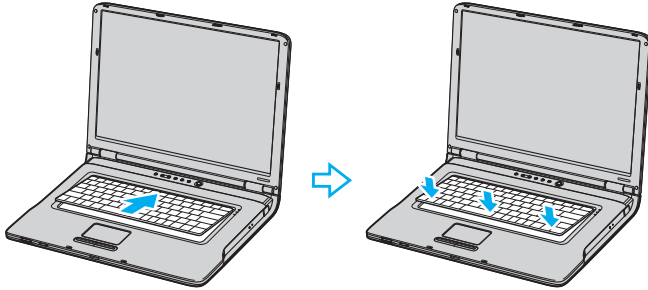

13 Close the LCD screen lid and turn over the computer upside down.

14 Close the memory module compartment cover and then tighten the screws on the bottom of the computer.

15 Reinstall the battery and turn on the computer.

VGN-FS series models

To change or add a memory module

- 1 Shut down your computer and disconnect all peripheral devices.
- 2 Unplug the computer and remove the battery pack.
- 3 Wait until the computer cools down.
- 4 Unscrew the screw (indicated by the arrow below) on the bottom of the computer and remove the memory module compartment cover.

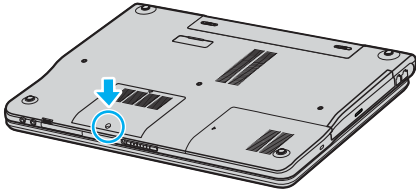

- 5 Touch a metal object (such as the connector panel on the back of the computer) to discharge static electricity.

6 Remove the memory module:

- Pull the tabs in the direction of the arrows (1).
The memory module is released.

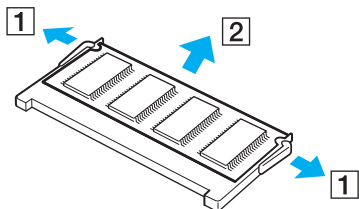

- Make sure that the memory module tilts up and then pull it out in the direction of the arrow (2).

7 Remove the new memory module from its packaging.

- 8 Slide the memory module into the memory module slot and push it in until it clicks into place.

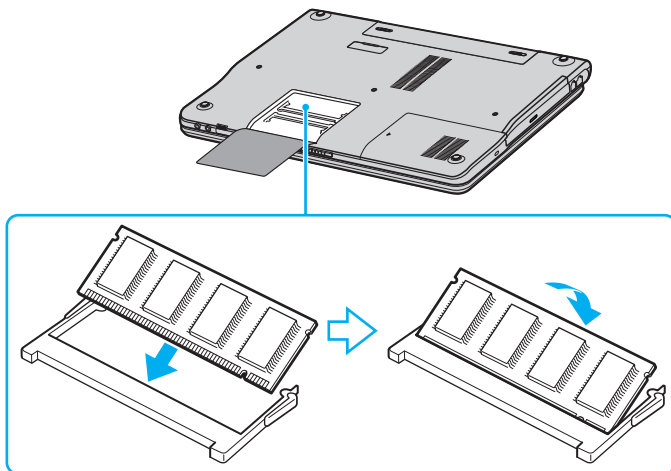

!
Do not touch any other components on the motherboard.
Do not damage the inner film cover equipped for module protection.

- 9 Replace the memory module compartment cover.
- 10 Tighten the screw on the bottom of the computer.
- 11 Reinstall the battery and turn on the computer.

Viewing the Amount of Memory

To view the amount of memory

- 1 Turn on the computer.
- 2 Click **Start**, point to **All Programs**, and click **VAIO Control Center**.
- 3 Double-click the **System Information** folder in the **VAIO Control Center** window.
- 4 Double-click the **System Information** icon in the **System Information** folder.
You can view the amount of system memory. If the additional memory does not appear, repeat the whole procedure and restart the computer.

Precautions

This section describes safety guidelines and precautions to help you protect your computer from potential damage.

- ❑ **On Handling the LCD Screen** ([page 170](#))
- ❑ **On Using the Power Source** ([page 171](#))
- ❑ **On Handling Your Computer** ([page 172](#))
- ❑ **On Handling Floppy Disks** ([page 174](#))
- ❑ **On Handling Discs** ([page 175](#))
- ❑ **On Using the Battery Pack** ([page 176](#))
- ❑ **On Using Headphones** ([page 177](#))
- ❑ **On Handling Memory Stick Media** ([page 177](#))
- ❑ **On Handling the Hard Disk** ([page 178](#))

On Handling the LCD Screen

- ❑ Do not leave the LCD facing the sun. This could damage the LCD. Be careful when using the computer near a window.
- ❑ Do not scratch the LCD or exert pressure on it. This could cause a malfunction.
- ❑ Using the computer in low temperature conditions may produce a residual image on the screen. This is not a malfunction. When the computer returns to normal temperature, the screen returns to normal.
- ❑ A residual image may appear on the screen if the same image is displayed for a lengthy period of time. The residual image disappears in a while. You can use a screen saver to prevent residual images.
- ❑ The screen becomes warm during operation. This is normal and does not indicate a malfunction.
- ❑ The LCD is manufactured using high-precision technology. You may, however, see tiny black points and/or bright points (red, blue, or green) that continuously appear on the LCD. This is a normal result of the manufacturing process and does not indicate a malfunction.
- ❑ Avoid rubbing the LCD screen. This could damage the screen. Use a soft, dry cloth to wipe the LCD screen.

On Using the Power Source

- ❑ See the printed **Specifications** sheet to check the power operation of your computer.
- ❑ Do not share the AC outlet with other power-consuming equipment, such as a photocopier or shredder.
- ❑ You can purchase a power strip with a surge protector. This device prevents damage to your computer caused by sudden power surges, in an electrical storm, for example.
- ❑ Do not place heavy objects on the power cord.
- ❑ To disconnect the cord, pull it out by the plug. Never pull the cord itself.
- ❑ Unplug your computer from the AC outlet if you are planning to not use the computer for a long time.
- ❑ Make sure that the AC outlet is easily accessible.
- ❑ When the AC adapter is not used, unplug it from the AC outlet.
- ❑ Use the AC adapter that comes with your computer or genuine Sony products. Do not use any other AC adapter as it may cause a malfunction.

On Handling Your Computer

- ❑ Clean the cabinet with a soft cloth, which is dry or lightly moistened with a mild detergent solution. Do not use any type of abrasive pad, scouring powder, or solvent such as alcohol or benzine, as these may damage the finish of your computer.
- ❑ If you drop a solid object or any liquid onto the computer, shut down your computer and then unplug it. You may want to have the computer checked by qualified personnel before operating it again.
- ❑ Do not drop the computer or place heavy objects on top of the computer.
- ❑ Do not place your computer in a location subject to:
 - ❑ Heat sources, such as radiators or air ducts
 - ❑ Direct sunlight
 - ❑ Excessive dust
 - ❑ Moisture or rain
 - ❑ Mechanical vibration or shock
 - ❑ Strong magnets or speakers that are not magnetically shielded
 - ❑ Ambient temperature of more than 35°C or less than 5°C
 - ❑ High humidity
- ❑ Do not place electronic equipment near your computer. The electromagnetic field of your computer may cause a malfunction.
- ❑ Provide adequate air circulation to prevent internal heat from building up. Do not place your computer on porous surfaces such as rugs or blankets, or near material such as curtains or draperies that may block its ventilation slots.
- ❑ The computer uses high-frequency radio signals and may cause interference to radio or TV reception. If this occurs, relocate the computer a suitable distance away from the set.
- ❑ Use only specified peripheral equipment and interface cables; otherwise, problems may occur.
- ❑ Do not use cut or damaged connection cables.

- ❑ If the computer is brought directly from a cold location to a warm one, moisture may condense inside your computer. In this case, allow at least one hour before turning on your computer. If any problems occur, unplug your computer and contact VAIO-Link.
- ❑ Make sure you disconnect the power cord before cleaning the computer.
- ❑ To avoid losing data if your computer is damaged, back up your data regularly.

On Handling Floppy Disks

- ❑ Do not open the shutter manually or touch the surface of the floppy disk.
- ❑ Keep floppy disks away from magnets.
- ❑ Keep floppy disks away from direct sunlight and other sources of heat.
- ❑ Keep the floppy disk away from any liquid. Do not let the floppy disk get wet. When you are not using the floppy disk, always remove it from the floppy disk drive and use a storage case.
- ❑ If the floppy disk comes with a label, make sure that the label is properly attached. If the edge of the label is curled up, the label may stick to the inside of the floppy disk drive and cause a malfunction or damage your floppy disk.

On Handling Discs

- ❑ Do not touch the surface of the disc.
- ❑ Do not drop or bend the disc.
- ❑ Fingerprints and dust on the surface of a disc may cause read errors. Always hold the disc by its edges and central hole, as shown below:

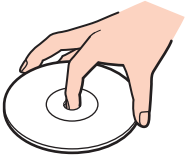

- ❑ Proper care of the disc is essential to its continuous reliability. Do not use solvents (such as benzine, thinner, alcohol, commercially available cleaners, or anti-static spray) which may cause damage to the disc.
- ❑ For normal cleaning, hold the disc by its edge and use a soft cloth to wipe the surface from the center out.
- ❑ If the disc is badly soiled, moisten a soft cloth with water, wring it out well, and use it to wipe the surface of the disc from the center out. Wipe off any remaining moisture with a dry soft cloth.
- ❑ Never put stickers on discs. This will affect the use of the disc irreparably.

On Using the Battery Pack

- ❑ Do not leave the battery pack in temperatures above 60°C, such as in a car parked in the sun or under direct sunlight.
- ❑ Battery life is shorter in a cold environment. This is due to decreased battery efficiency at low temperatures.
- ❑ Charge the batteries at temperatures between 10°C to 30°C. Lower temperatures require a longer charging time.
- ❑ While the battery is in use or being charged, the battery pack heats up. This is normal and is not cause for concern.
- ❑ Keep the battery pack away from all sources of heat.
- ❑ Keep the battery pack dry.
- ❑ Do not open or try to disassemble the battery pack.
- ❑ Do not expose the battery pack to any mechanical shock.
- ❑ If you are not using the computer for an extended period of time, remove the battery pack from the computer to prevent damage to the battery.
- ❑ If, after fully charging the battery pack, the battery power is still low, the battery pack may be reaching the end of its life and should be replaced.
- ❑ You do not need to discharge the battery before recharging.
- ❑ If you have not used the battery pack for a considerable amount of time, recharge the battery.

On Using Headphones

- ❑ **Road safety** – Do not use headphones while driving, cycling, or operating any motorized vehicle. It may create a traffic hazard and is illegal in some areas. It can also be potentially dangerous to play loud music while walking, especially at pedestrian crossings.
- ❑ **Preventing hearing damage** – Avoid using headphones at high volume. Hearing experts advise against continuous, loud and extended play. If you experience a ringing in your ears, reduce the volume or discontinue use.

On Handling Memory Stick Media

- ❑ Do not use the media in locations that are subject to static electricity or electrical noise.
- ❑ Do not touch the Memory Stick media connector with your finger or metallic objects.
- ❑ Use only the label supplied with the Memory Stick media as a label.
- ❑ Do not bend, drop, or apply strong shock to the Memory Stick media.
- ❑ Do not disassemble or modify Memory Stick media.
- ❑ Do not let Memory Stick media get wet.
- ❑ Do not use or store Memory Stick media in a location subject to:
 - ❑ Extremely high temperatures, such as in a car parked in the sun
 - ❑ Direct sunlight
 - ❑ High humidity or
 - ❑ Corrosive substances
- ❑ Use the storage case supplied with the Memory Stick media.

On Handling the Hard Disk

The hard disk has a high storage density and reads or writes data in a short time. However, it can be easily damaged by mechanical vibration, shock or dust.

Although the hard disk has the internal safety device to prevent losing data due to mechanical vibration, shock or dust, you should be careful when handling your computer.

To avoid damaging your hard disk

- Do not subject your computer to sudden movements.
- Keep the computer away from magnets.
- Do not place your computer in a location subject to mechanical vibration or in an unstable position.
- Do not move your computer while the power is on.
- Do not turn off the power or restart the computer while reading or writing data to disk.
- Do not use your computer in a place subject to extreme changes in temperature.



If the hard disk is damaged, the data cannot be restored.

Troubleshooting

This section describes how to solve common problems you might encounter when using your VAIO computer. Many problems have simple solutions. Try these suggestions before contacting VAIO-Link.

- ❑ **Troubleshooting the optical disc drive** ([page 180](#))
- ❑ **Troubleshooting PC Cards** ([page 184](#))
- ❑ **Troubleshooting the modem** ([page 184](#))
- ❑ **Troubleshooting the Bluetooth functionality** ([page 186](#))
- ❑ **Troubleshooting Wireless LAN** ([page 189](#))
- ❑ **Troubleshooting Power Management** ([page 192](#))
- ❑ **Troubleshooting External Displays** ([page 193](#))
- ❑ **Troubleshooting Sound (Speaker)** ([page 195](#))
- ❑ **Troubleshooting Sound (Microphone)** ([page 196](#))
- ❑ **Troubleshooting Floppy Disks** ([page 198](#))
- ❑ **Troubleshooting Printers** ([page 199](#))
- ❑ **Troubleshooting i.LINK Devices** ([page 201](#))

Troubleshooting the optical disc drive

I cannot switch from LCD display to TV and vice versa

If a DVD disc is inserted in the optical disc drive, remove the disc.

My optical disc drive tray does not open

- ❑ Make sure the computer is turned on and press the disc eject button*.



Try first the disc eject button*. If this button does not work, then press the substitute disc eject button* on the optical disc drive. The disc eject button is disabled until you start your computer and log on to Windows.

- ❑ Click **Start** and then **My Computer**. Right-click the optical disc drive and select **Eject**.
- ❑ Make sure the computer is not in **Standby** or **Hibernate** mode.
- ❑ If this does not work, try the following:
Turn off the computer and insert a sharp, pointed object (for example a paperclip) into the manual eject hole* on the optical disc drive to slide out the tray.

* The location of the eject button and hole depends on the model of your computer. See the printed **Specifications** sheet for details on your model.

I cannot play a disc

- ❑ After inserting the disc, wait for a few seconds for the system to detect it before you try to access it.
- ❑ Make sure the label of the disc is facing up.
- ❑ If the disc requires software, make sure the software is installed according to the instructions of the program.
- ❑ Check the volume of your speakers.
- ❑ Clean the disc with an appropriate cleaner.
- ❑ Make sure your computer is running on AC power supply only and try the disc again.
- ❑ There may be condensation in the drive. Remove the disc and leave the drive open for approximately one hour. Remove the battery while you wait for the condensation to disappear.

I cannot play a DVD

- ❑ If a region code warning appears when you are using your DVD player, it could be that the DVD you are trying to play is incompatible with the optical disc drive on your computer. The region code is listed on the packaging of the disc.
- ❑ Change the resolution under **Control Panel - Display** to a lower resolution.
- ❑ If you see video but cannot hear sound, check all of the following:
 - ❑ Make sure the mute setting is off on your DVD player.
 - ❑ Check the **Master Volume** settings of the **Sounds and Audio Device Properties**.
 - ❑ If you have connected speakers externally, check the volume settings of your computer speakers and check the connections between your speakers and the computer.
 - ❑ In the **Device Manager**, check that the correct drivers are installed properly. To display the **Device Manager**, click **Start, Control Panel**, and **Performance and Maintenance**. Click the **System** icon and then the **Device Manager** button on the **Hardware** tab.
- ❑ A dirty or damaged disc may cause the computer to "hang" while it tries to read the disc. If necessary, reboot the computer, remove the disc and then check that it is not dirty or damaged.
- ❑ Check your PG settings (Parental Guidance) in the DVD software as they might be preventing you from playing certain DVDs when they are activated.



On your computer, the default DVD region code is 2. Do not change this setting using the **Region Code Change** function in Windows, or using any other software applications. System malfunctions originating from the user changing the DVD region code are beyond the scope of your warranty and will result in service charges for repair.

If you do not immediately see the **Display** icon after clicking **Control Panel**, click **Switch to Classic View** on the left.

I cannot play a DVD when using two screens

- You will not have a problem in the following situations:
 - When you use a CRT or an LCD display on its own.
 - When you play MPEG files which are recorded on the hard disk drive with **Windows Media Player 10** or **VAIO Zone**.

The reading speed of CD/DVD-RWs is very slow

Generally, the reading speed of a CD/DVD-RW is slower than that of a -ROM or -R. The reading speed can also vary depending on the type of format.

The disc tray does not eject even when the eject button is pressed

- Check that the computer is turned on.
- The CD-writing application software may be stopping the disc from being ejected.
- Make sure the computer is not in **Standby** or **Hibernate** mode.

The disc tray ejects even when it has been locked into place

- Ensure that the disc is placed with the label side facing up.
- Clean the disc and the optical disc drive lens with an appropriate cleaner.
- The disc may be scratched. Place another disc to see if that is the reason.
- There may be condensation in the drive. Remove the disc and leave the drive open for approximately one hour. Remove the battery while you wait for the condensation to disappear.

Troubleshooting PC Cards

My PC Card is not working

Make sure the PC Card is compatible with your version of Windows.

Troubleshooting the modem

My modem does not work or cannot establish a connection

- Check that the phone line is plugged into your computer.
- Make sure that the modem is the only device connected to your phone line.
- Check that the phone line is working. You can check the line by plugging in an ordinary phone and listening for a dial tone.
- Check that the phone number the program is dialling is correct. The modem dialling mode may be incompatible with your telephone line.
- The modem may not work properly if you are with a Private Automatic Branch eXchange (PABX).
- In the **Phone and Modem Options** dialog box (**Control Panel / Printers and Other Hardware / Phone and Modem Options**), check that your modem is listed on the **Modems** tab, and that the location information is correct on the **Dialing Rules** tab.
If you do not see the **Phone and Modem Options** icon, click **Switch to Classic View** on the left side.
- We recommend you use country-specific phone plug to plug the phone line into the wall jack, because use of any other phone plug can decrease the connection quality.
- Your computer cannot be connected to a coin-operated telephone, and may not work with multiple phone lines or a private branch exchange (PBX). If you connect the modem to a parallel connected phone line, the modem or the other connected device may not function properly. Some of these connections may result in excess electrical current and could cause a malfunction in the internal modem.

- ❑ Only DTMF (Dual Tone Multi Frequency) signalling (tone dialling) is supported.
- ❑ The internal modem is intended to be used for data and fax communications using DTMF (Dual Tone Multi Frequency) signalling (tone dialing) on the PSTN (Public Switched Telephone Network) networks in the following countries: Austria, Belgium, Czech Republic, Denmark, Finland, France, Greece, Germany, Iceland, Ireland, Italy, Luxembourg, Norway, Portugal, Spain, Sweden, Switzerland, the Netherlands and the United Kingdom.
- ❑ If your computer is equipped with the flexible modem connector cover, do not pull it too forcefully.

My modem connection is slow

Many factors influence modem connection speed, including telephone line noise or compatibility with telephone equipment (such as fax machines or other modems). If you think your modem is not connecting properly to other PC-based modems, fax machines, or your Internet Service Provider, check the following:

- ❑ Have your phone company check that your phone line is free from any line noise.
- ❑ If your problem is fax-related, check that there are no problems with the fax machine you are calling and that it is compatible with fax modems.
- ❑ If you are having a problem connecting with your Internet Service Provider, check that the ISP is not experiencing technical problems.
- ❑ If you have a second phone line available, try connecting the modem to that line.

Troubleshooting the Bluetooth functionality

I cannot use the Bluetooth functionality

- If the Bluetooth indicator is off, turn on the **WIRELESS** switch.
- You cannot use the Bluetooth functionality when the computer is in a power saving mode. Return to normal mode, then turn on the **WIRELESS** switch.

The connected device does not appear in the Bluetooth Device List

If the connected device is also connected to other devices, it may not appear on the **Devices** tab in the **Bluetooth Device** window or you may not be able to communicate with the device.

I cannot find the Bluetooth device with which I want to communicate

- Check that the Bluetooth functionality of the device with which you want to communicate is on. See the other device's manual for more details.
- If the device with which you want to communicate is already communicating with another Bluetooth device, it may not be found or it may not be able to communicate with your computer.
- To allow other Bluetooth devices to communicate with your computer, go to the **Options** tab in the **Bluetooth Device** window and select the check box **Allow Bluetooth devices to connect to this computer**.
For more information on the Bluetooth Device window, see **Communicating with Another Bluetooth Device** ([page 60](#)).

The data transfer speed is slow

The data transfer speed depends on the obstacles and/or the distance between the two devices, but also on the radio wave quality, the operating system or the software used. Try to move your computer or try to place the two devices closer.

I cannot communicate with the other device although the distance between both devices is within 10 metres

- ❑ The data transfer distance can be shorter than 10 meters depending on existing obstacles between the two devices, on radio wave quality, on the operating system or the software used. Try to move your computer or to place both devices closer.
- ❑ If the device with which you want to communicate is already communicating with another Bluetooth device, it may not be found or it may not be able to communicate with your computer.
- ❑ Check that the Bluetooth functionality of the device with which you want to communicate is on. See the other device's manual for more details.

File transmission and reception fail.

When transmitting a file with the **Bluetooth File Forwarding Wizard**, the receiving device must be set beforehand to receive incoming transmissions.

To set a device to receive incoming transmissions

- 1 Start the computer and turn on the Bluetooth device.
- 2 Click **Start**, point to **All programs**, **Accessories**, and **Communications**, then click **Bluetooth File Forwarding Wizard**.
- 3 Click **Next**, select the check box next to **Receive files**, and click **Next** again.

The message The Bluetooth device requires authentication appears on the taskbar.

The target Bluetooth enabled device is requesting connection authentication. Mutual authentication is required to enable Bluetooth communications with this device.

Cannot connect to service supported by target Bluetooth device.

Connection is only possible for services also supported by the computer equipped with the Bluetooth functionality. For more details, refer to the **Bluetooth Device** Help in Windows XP and/or the operating instructions or electronic manual for the targeted Bluetooth device.

Unable to exchange business card data with a cellular phone.

The business card exchange function is not supported.

Troubleshooting Wireless LAN

I cannot use the Wireless LAN functionality

Check if the **WIRELESS** (on models with the Bluetooth functionality^{*}) or **WIRELESS LAN** (on models without the Bluetooth functionality) switch is turned on and the WIRELESS LAN indicator is lit.

* See the printed **Specifications** sheet to see whether your model is equipped with the Bluetooth functionality.

The Wireless LAN Access Point and your computer cannot communicate

- Check if the **WIRELESS** (on models with the Bluetooth functionality^{*}) or **WIRELESS LAN** (on models without the Bluetooth functionality) switch is turned on and the WIRELESS LAN indicator is lit.
- Check if the power of the Access Point is turned on.
- Check if the Access Point is displayed in the **Available networks** window.
 - To check this, click Start and then **Control Panel**.
 - Click **Network and Internet Connections**.
 - Click the **Network Connections** icon.
 - Right-click the **Wireless Network Connection** icon and select **Properties**.
 - Select the **Wireless Networks** tab.
 - Check if the Access Point is displayed in **Available networks**.
 - Connection availability is affected by distance and obstructions. You may need to move your computer away from obstructions or neared to any Access Point you may be using.

* See the printed **Specifications** sheet to see whether your model is equipped with the Bluetooth functionality.

The data transfer speed is slow

- ❑ The maximum communication speed can vary depending on the obstacles or the distance between the communication devices, the radio waves, the operating system or the software you use. Remove the obstacle or make the distance between the Access Point and your machine smaller.
- ❑ It is possible that your Access Point communicates at the same time with another Access Point. Read the manual of the Access Point.
- ❑ If several computers communicate with the same Access Point, the concentration may be too high. Wait a few minutes and try to access again.
- ❑ If a Wireless LAN device using the IEEE802.11g standard communicates with a device using the IEEE802.11b standard, then it is normal that the speed reduces. Devices using the IEEE802.11g standard are 5 times faster than the ones using the IEEE802.11b standard.

I cannot access the Internet

- ❑ Check the settings of the Access Point. See the manual of the Access Point.
- ❑ Check if your computer and the Access Point are communicating.
- ❑ Make the distance between the Access Point and your machine smaller.

I cannot use a Wireless LAN network

Check if the **Wireless Zero Configuration** service is active.

To check the status of the Wireless Zero Configuration service

- 1 Click **Start** and then **Control Panel**.
The **Control Panel** window appears.
- 2 Click the **Performance and Maintenance** icon.
- 3 Click the **Administrative Tools** icon.
- 4 Double-click the **Services** icon.
The **Services** window appears.
- 5 Check **Status** and **Startup Type** for **Wireless Zero Configuration**.
When **Started** and **Automatic** are shown under **Status** and **Startup Type**, respectively, the **Wireless Zero Configuration** service is active.

To activate the Wireless Zero Configuration service

- 1 On the **Services** window, right-click **Wireless Zero Configuration** and click **Properties**.
The **Wireless Zero Configuration Properties** window appears.
- 2 Select **Automatic** for **Startup type** and click **Apply**.
- 3 Click **Start** under **Service status**.
- 4 Click **OK** to close the window.

Troubleshooting Power Management

The power management setting is not responding

Your computer's operating system may become unstable if a lower power state, such as **Hibernate** is initiated, and then changed before the computer completely enters the lower power state.

To restore the computer to its normal operating stability

- 1 Close all open applications.
- 2 Press the **Ctrl+Alt+Delete** keys simultaneously and select **Restart** from the shut down menu drop-down list.
The computer restarts.
- 3 If the procedure does not work, press and hold the power button for four seconds or longer to shut down the computer.

Troubleshooting External Displays

I cannot use the Plug and Display function

Depending on the external display or the way it is connected, the Plug and Display function may not be available. Use the **Fn+F7** keys to select the output destination.

I cannot display contents on two or more displays at the same time

You cannot display contents on multiple external displays at the same time. Select one of the external displays.

The external display with the DVI-D port does not display properly (VGN-A series)

See the printed **Troubleshooting Guide** first to solve your problems. If the problem persists, proceed as follows:

- 1 Click **Start** and then **Control Panel**.
The **Control Panel** window appears.
- 2 Click the **Appearance and Themes** icon.
- 3 Click the **Display** icon.
The **Display Properties** window appears.
- 4 Click the **Settings** tab.
- 5 Click **Advanced**.
The properties window appears.
- 6 Click **Options**.
- 7 Confirm that the button for **Alternate DVI operational mode** is selected. If not, click to check the button.
- 8 Click to check the button for **Reduce DVI frequency on high-resolution displays**.
The warning message window appears.
- 9 Click **Yes**.
- 10 Click **Yes** once again.

! Click to check the above button only if the external display with the DVI-D port does not display properly with the default settings.

The external display with the DVI-D port does not display the boot-up screen and the BIOS setup screen at startup. To change the BIOS settings, use your computer's screen.

Troubleshooting Sound (Speaker)

My speakers are not producing sound

❑ **VGN-A series**

- ❑ The built-in speakers may be turned off (the Mute \times indicator is on). Press the **Mute** button to turn on the speakers.
- ❑ The speaker volume may be turned to the minimum. Press the **Volume up** button to increase the volume.

❑ **VGN-FS series**

- ❑ The built-in speakers may be turned off. Press the **Fn+F2** keys or the **S1** button (default assignment) to turn on the speakers.
- ❑ The speaker volume may be turned to the minimum. Press the **Fn+F4** keys and then the \uparrow or \rightarrow key, or keep pressing the **Fn+F4** keys to increase the volume.
- ❑ If you use external speakers, check that the speakers are properly connected and the volume is turned up. If the speakers have a mute button, make sure it is off. If batteries power the speakers, check that the batteries are inserted properly and that they are charged.
- ❑ If you have connected an audio cable to the headphones jack, disconnect the cable.
- ❑ If your computer is powered by battery, check that the battery pack is properly installed and charged.
- ❑ If you are using an application that has its own volume control, check that the volume is turned up.
- ❑ Check the volume controls in Windows.

Troubleshooting Sound (Microphone)

My microphone does not work

If you are using an external microphone, check that the microphone is plugged into the microphone jack correctly.

My microphone volume is too high or too low

Proceed as follows to adjust the volume.

- 1 Click **Start** and then **Control Panel**.
The **Control Panel** window appears.
- 2 Click **Sounds, Speech, and Audio Devices** and then **Sounds and Audio Devices**.
- 3 Click **Volume** under **Sound recording** on the **Audio** tab.
- 4 See if the **Select** check box for **Microphone Balance** is selected. If not, click the check box.
- 5 Move the slider up or down to adjust the volume.
- 6 If the volume is still too high or too low, select **Advanced Controls** from the **Options** menu.
The **Advanced** button appears for **Microphone Balance**.
- 7 Click the **Advanced** button and select/deselect **Microphone Boost** or **+20db Gain** under **Other Controls** to adjust the volume.

Only left-channel audio is recorded with a monaural microphone (VGN-A series)

Proceed as follows to change the audio channel setting.

- 1 Click **Start** and then **Control Panel**.
The **Control Panel** window appears.
- 2 Click **Sounds, Speech, and Audio Devices** and then **Sounds and Audio Devices**.
- 3 Click **Volume** under **Sound recording** on the **Audio** tab.
- 4 Select **Advanced Controls** from the **Options** menu.
The **Advanced** button appears for **Microphone Balance**.
- 5 Click the **Advanced** button and select the **Mono Mic** check box under **Other Controls**.



This audio channel setting is only applied to sound recording with a microphone.

Stereo sound is not recorded with a stereo microphone (VGN-A series)

Proceed as follows to change the audio channel setting.

- 1 Click **Start** and then **Control Panel**.
The **Control Panel** window appears.
- 2 Click **Sounds, Speech, and Audio Devices** and then **Sounds and Audio Devices**.
- 3 Click **Volume** under **Sound recording** on the **Audio** tab.
- 4 Select **Advanced Controls** from the **Options** menu.
The **Advanced** button appears for **Microphone Balance**.
- 5 Click the **Advanced** button and deselect the **Mono Mic** check box under **Other Controls**.

Troubleshooting Floppy Disks

My USB floppy disk drive cannot write to a floppy disk

- The floppy disk is write-protected. Disable the write-protect feature or use a floppy disk that is not write-protected.
- Check that the disk is properly inserted into the floppy disk drive.
- Your disk may be corrupt. Try to insert another floppy disk.

The optional USB floppy disk drive is not recognized as drive A

To set the floppy disk drive to A

- 1 Turn the system power on.
- 2 Connect the floppy disk drive.
- 3 Select **Control Panel** from the **Start** menu.
- 4 Click **Performance and Maintenance**.
- 5 Click **System**.
- 6 Select the **Hardware** tab, then click **Device Manager**.
- 7 Select **Universal Serial Bus controllers**, then **Y-E Data USB Floppy**.
- 8 From the Action menu, click **Uninstall**.
- 9 Keep clicking **OK** until the **Confirmation of deletion of device** message appears.
- 10 Select **Scan for hardware changes** from the **Action** menu.
The floppy disk drive is recognized as drive A.

Troubleshooting Printers

- ❑ Make sure that the printer driver supports Windows XP.
Ask the manufacturer of your printer for the driver that supports Windows XP.
- ❑ The printer port  on the port replicator is internally connected to the USB. If your printer is connected to the printer port on the port replicator, proceed as follows to check the printer port settings.
 - 1 Click **Start** and then **Control Panel**.
 - 2 Click the **Printers and Other Hardware** icon.
 - 3 Click the **Printers and Faxes** icon.
 - 4 Right-click the printer to select **Properties**.
 - 5 Click the **Ports** tab.
 - 6 Check if the check box for **USB001** is selected. If another check box is selected, click the box for **USB001**.
 - 7 Click **OK**.

If the above procedure does not work, right-click the printer and selected "Delete" on the window in step 3 above to delete the printer. Then, install the printer driver once again.

- ❑ If the bidirectional communication functions are provided with your printer, disabling the functions on your computer may enable printing. Proceed as follows:

- 1 Click **Start** and then **Control Panel**.
- 2 Click the **Printers and Other Hardware** icon.
- 3 Click the **Printers and Faxes** icon.
- 4 Right-click the printer to select **Properties**.
- 5 Click the **Ports** tab.
- 6 Click the check box for **Enable bidirectional support** to deselect it.
- 7 Click **OK**.



This change to the settings will disable the bidirectional communication functions of your printer, such as data transfer, status monitoring, and remote panel.

- ❑ Check the physical connections between your computer and printer, the AC adapter and the power cord, and the power cord and an AC outlet, and then restart your computer.

Troubleshooting i.LINK Devices

I cannot establish an i.LINK connection between two VAIO computers

- ❑ You must have administrator rights on your computer to be able to link the two.
- ❑ Disconnect then reconnect the i.LINK cable.
- ❑ If you still have no connection after waiting for a while, restart both computers.
- ❑ If either computer has just returned from a power saving mode, the connection may be affected. In this case, make sure you perform a full restart before connecting them.

When I record images to a digital video device using DVgate Plus, I see an error message

- ❑ Close all open applications and restart your computer. Frequent recording of images to a digital video device while using **DVgate Plus** sometimes causes this error.
- ❑ Your DV device will need to have DV In/Out in order to be able to transfer your files to the DV device.

I cannot use digital devices

- ❑ Check that the DV device is turned on and that the cables are properly connected.
- ❑ If you are using multiple i.LINK devices, the combination of the connected devices may cause unstable operation. If this is the case, turn off all connected devices and disconnect unused devices. Check the connection and then turn on the power again.
- ❑ You are strongly advised to use only Sony i.LINK cables, as using other brands may cause problems with the i.LINK devices.

Support Options

The section contains information on where to go for answers to questions about your VAIO computer.

Sony Support Information

See the following sources for answers in the sequence listed below.

See **Documentation (page 8)** for details on the printed and online documentation delivered with your computer, as well as further sources of reference.

- Go to the online **help files** that accompany your software for instructions on using the software.
- Use the search functionality in **Help and Support Center** by pressing the **F1** key.
- VAIO-Link web site:** if you have any problem with your computer, you can access the VAIO-Link web site for troubleshooting. Go to <http://www.vaio-link.com>.
- e- Support:** This interactive part of our web site <http://www.vaio-link.com> allows you to get in contact with our dedicated support team over the internet. Using a personalized account, you can log your technical queries with ease.
- VAIO-Link help lines:** Before contacting VAIO-Link by telephone, try to solve the problem by reading the online and printed documentation.
- Visit the other Sony web sites:
 - www.club-vaio.com if you want to know more about VAIO and become part of the growing VAIO community.
 - www.sonymstyle-europe.com for online purchases.
 - www.sony.net for other Sony products.



You need to set up an Internet connection before you can access the online features described here.

e-Support

What is e-Support?

You have searched our user guides and web site (www.vaio-link.com) but have not found an answer to your question/issue? e-Support is the ideal solution for you!

Our e-Support Web Portal is an interactive web site on which you can submit any technical query you may have regarding your VAIO computer and receive answers from our dedicated support team.

Every submitted query will result in a unique 'case number' to ensure smooth communication between yourself and the e-Support Team.

Who can use e-Support?

All registered VAIO customers are entitled to unlimited access to the VAIO-Link e-Support Web Portal.

How can I access the e-Support portal?

When you register your VAIO computer online at Club-VAIO (www.club-vaio.com), you will automatically receive an email with the link to the e-Support Web Portal, your Customer ID and some basic explanation a few hours later.

All you need to do is activate your account by clicking on the provided link in the email.

You are now ready to create your first case!

You can access the e-Support Web Portal from any computer with an active Internet connection.

A complete help file is available on the e-Support Web Portal to help you use our e-Support Service.

Can I submit questions in my native language?

Since you are interacting with our e-Support Team through a portal, which connects you directly to our central database, e-Support will only accept and deal with queries submitted in English.

Can I submit my questions at any time?

Yes, you can submit your questions 24/7, but please keep in mind that our e-Support Team can only treat your queries from Monday till Friday between 8am and 6pm.

Is there a cost involved for using e-Support?

No, this is a complete free of charge service offered to all registered VAIO customers!

How do I know when the e-Support Team has handled my query/case?

As soon as your case has been dealt with by our e-Support Team, you will receive an email, notifying you that your case has been updated.

Trademarks

Sony, Battery Checker, Click to DVD, DVgate Plus, HotKey Utility, Keyboard Utility, Memory Stick Formatter, PictureGear Studio, Prepare your VAIO, SonicStage, SonicStage Mastering Studio, VAIO Control Center, VAIO Edit Components, VAIO Launcher, VAIO Media, VAIO Power Management, Image Converter, VAIO Zone, VAIO Update, Memory Stick, the Memory Stick logo, VAIO and the VAIO logo are trademarks of Sony Corporation.

Intel, Pentium, and Intel SpeedStep are trademarks or registered trademarks of Intel Corporation.

Microsoft, Internet Explorer, Windows Movie Maker, Windows Media Player, Windows XP Professional, Windows XP Home Edition, MS Works 8.0, Microsoft Office 2003 SBE Trial version and the Windows logo are trademarks or registered trademarks of Microsoft Corporation in the U.S. and other countries.

i.LINK is a trademark of Sony used only to designate that a product contains an IEEE1394 connection.

Adobe, Adobe Acrobat Elements, Adobe Acrobat Professional, Adobe Photoshop Album, Adobe Reader, Adobe Premiere Standard and Adobe Photoshop Elements are trademarks of Adobe Systems Incorporated.

MoodLogic is a trademark of MoodLogic, Inc.

Norton Internet Security 2005 and Norton Password Manager 2004 are trademarks or registered trademarks of Symantec Corporation.

RecordNow! is a trademark of Sonic.

WinDVD for VAIO is a trademark of InterVideo, Inc.

Sun Java VM is a trademark of Sun Microsystems, Inc.

Google Toolbar is a trademark of Google.

Yahoo! Messenger is a trademark of Yahoo!.

SafeGuard PrivateDisk is a trademark of Utimaco Software.

My Club VAIO uses Macromedia Flash™ Player software by Macromedia, Inc., Copyright © 1995-2003 Macromedia, Inc. All rights reserved. Macromedia and Flash are trademarks of Macromedia, Inc.

The Bluetooth word mark and logos are owned by the Bluetooth SIG, Inc. and any use of such marks by Sony Corporation is under license. Other trademarks and trade names are those of their respective owners.

All other names of systems, products and services are trademarks of their respective owners. In the manual, the ™ or ® marks are not specified.

Specifications are subject to change without notice. All other trademarks are trademarks of their respective owners.

Please see the printed Specifications sheet to see what software is available for your model.