

Network Speaker

Operating Instructions

Getting Started

Network Connections

Listening to Audio Content
Over Your Home Network

Using Internet music
streaming (Music Service)

Using AirPlay

Using Music Throw

Others

Troubleshooting

WARNING

To reduce the risk of fire or electric shock, do not expose this apparatus to rain or moisture.

To reduce the risk of fire, do not cover the ventilation opening of the apparatus with newspapers, tablecloths, curtains, etc.

Do not place the naked flame sources such as lighted candles on the apparatus.

Do not install the appliance in a confined space, such as a bookcase or built-in cabinet.

To reduce the risk of fire or electric shock, do not expose this apparatus to dripping or splashing, and do not place objects filled with liquids, such as vases, on the apparatus.

As the main plug is used to disconnect the unit from the mains, connect the unit to an easily accessible AC outlet. Should you notice an abnormality in the unit, disconnect the main plug from the AC outlet immediately.

Do not expose batteries or apparatus with battery-installed to excessive heat such as sunshine, fire or the like.

The unit is not disconnected from the mains as long as it is connected to the AC outlet, even if the unit itself has been turned off.

The dating code and the nameplate are located on the bottom exterior. (For USA and Canada)

The nameplate is located on the bottom exterior. (For Europe)

On the battery for the remote control

CAUTION

Danger of explosion if battery is incorrectly replaced. Replace only with the same or equivalent type.

Replace the battery with a Sony CR2025 lithium battery.

Use of another battery may present a risk of fire or explosion.

For customers in the United States and Canada

Owner's Record

The model and serial numbers are located on the bottom of the unit. Record these numbers in the space provided below. Refer to them whenever you call upon your Sony dealer regarding this product.

Model No. _____ Serial No. _____

For customers in the United States

Important Safety Instructions

- 1) Read these instructions.
- 2) Keep these instructions.
- 3) Heed all warnings.
- 4) Follow all instructions.
- 5) Do not use this apparatus near water.
- 6) Clean only with dry cloth.
- 7) Do not block any ventilation openings. Install in accordance with the manufacturer's instructions.
- 8) Do not install near any heat sources such as radiators, heat registers, stoves, or other apparatus (including amplifiers) that produce heat.
- 9) Do not defeat the safety purpose of the polarized or grounding-type plug. A polarized plug has two blades with one wider than the other. A grounding type plug has two blades and a third grounding prong. The wide blade or the third prong are provided for your safety. If the provided plug does not fit into your outlet, consult an electrician for replacement of the obsolete outlet.
- 10) Protect the power cord from being walked on or pinched particularly at plugs, convenience receptacles, and the point where they exit from the apparatus.
- 11) Only use attachments/accessories specified by the manufacturer.
- 12) Use only with the cart, stand, tripod, bracket, or table specified by the manufacturer, or sold with the apparatus. When a cart is used, use caution when moving the cart/apparatus combination to avoid injury from tip-over.
- 13) Unplug this apparatus during lightning storms or when unused for long periods of time.



14) Refer all servicing to qualified service personnel. Servicing is required when the apparatus has been damaged in any way, such as power-supply cord or plug is damaged, liquid has been spilled or objects have fallen into the apparatus, the apparatus has been exposed to rain or moisture, does not operate normally, or has been dropped.

The following FCC statement applies only to the version of this model manufactured for sale in the U.S.A. Other versions may not comply with FCC technical regulations.

NOTE:

This equipment has been tested and found to comply with the limits for a Class B digital device, pursuant to Part 15 of the FCC Rules. These limits are designed to provide reasonable protection against harmful interference in a residential installation.

This equipment generates, uses and can radiate radio frequency energy and, if not installed and used in accordance with the instructions, may cause harmful interference to radio communications. However, there is no guarantee that interference will not occur in a particular installation. If this equipment does cause harmful interference to radio or television reception, which can be determined by turning the equipment off and on, the user is encouraged to try to correct the interference by one or more of the following measures:

- Reorient or relocate the receiving antenna.
- Increase the separation between the equipment and receiver.
- Connect the equipment into an outlet on a circuit different from that to which the receiver is connected.
- Consult the dealer or an experienced radio/TV technician for help.

CAUTION

You are cautioned that any changes or modifications not expressly approved in this manual could void your authority to operate this equipment.

Properly shielded and grounded cables and connectors must be used for connection to host computers and / or peripherals in order to meet FCC emission limits.

This device complies with Part 15 of the FCC Rules. Operation is subject to the following two conditions: (1) this device may not cause harmful interference, and (2) this device must accept any interference received, including interference that may cause undesired operation.

This equipment must not be co-located or operated in conjunction with any other antenna or transmitter.

This equipment complies with FCC radiation exposure limits set forth for an uncontrolled environment and meets the FCC radio frequency (RF) Exposure Guidelines in Supplement C to OET65.

This equipment should be installed and operated keeping the radiator at least 20 cm or more away from person's body (excluding extremities: hands, wrists, feet and ankles).

For the State of California, USA only

Perchlorate Material - special handling may apply,
See

www.dtsc.ca.gov/hazardouswaste/perchlorate
Perchlorate Material: Lithium battery contains
perchlorate.

For customers in Canada

Properly shielded and grounded cables and
connectors must be used for connection to host
computers and / or peripherals.

Operation is subject to the following two conditions:
(1) this device may not cause interference, and (2)
this device must accept any interference, including
interference that may cause undesired operation of
this device.

This equipment complies with IC radiation exposure
limits set forth for an uncontrolled environment and
meets RSS-102 of the IC radio frequency (RF)
Exposure rules.

This equipment should be installed and operated
keeping the radiator at least 20 cm or more away
from person's body (excluding extremities: hands,
wrists, feet and ankles).

For customers in Europe



Notice for customers: the following information is
only applicable to equipment sold in countries
applying EU directives.

The manufacturer of this product is Sony
Corporation, 1-7-1 Konan Minato-ku Tokyo,
108-0075 Japan.

The Authorized Representative for EMC and
product safety is Sony Deutschland GmbH,
Hedelfinger Strasse 61, 70327 Stuttgart, Germany.
For any service or guarantee matters please refer to
the addresses given in separate service or guarantee
documents.

This equipment has been tested and found to comply
with the limits set out in the EMC Directive using a
connection cable shorter than 3 meters.

Hereby, Sony Corp., declares that this equipment is
in compliance with the essential requirements and
other relevant provisions of Directive 1999/5/EC.

For details, please access the following URL:
<http://www.compliance.sony.de/>

This product is intended to be used in the following
countries.

AT,BE,DK,FI,FR,DE,IS,IT,LU,NL,NO,ES,SE,CH,
GB,PL

Notice for the customers in France

The **WLAN** feature of this Network Speaker shall
exclusively be used inside buildings.

Any use of the **WLAN** feature of this Network
Speaker outside of the buildings is prohibited on the
French territory. Please make sure that the **WLAN**
feature of this Network Speaker is disabled before
any use outside of the buildings.(ART Decision
2002-1009 as amended by ART Decision 03-908,
relating to radio-frequencies use restrictions).

Notice for the customers in Italy

Use of the RLAN network is governed:

- with respect to private use, by the Legislative Decree of 1.8.2003, no. 259 (“Code of Electronic Communications”). In particular Article 104 indicates when the prior obtainment of a general authorization is required and Art. 105 indicates when free use is permitted;
- with respect to the supply to the public of the RLAN access to telecom networks and services, by the Ministerial Decree 28.5.2003, as amended, and Art. 25 (general authorization for electronic communications networks and services) of the Code of electronic communications.

Notice for the customers in Norway

Use of this radio equipment is not allowed in the geographical area within a radius of 20 km from the centre of Ny-Ålesund, Svalbard.



Disposal of Old Electrical & Electronic Equipment (Applicable in the European Union and other European countries with separate collection systems)

This symbol on the product or on its packaging indicates that this product shall not be treated as household waste. Instead it shall be handed over to the applicable collection point for the recycling of electrical and electronic equipment. By ensuring this product is disposed of correctly, you will help prevent potential negative consequences for the environment and human health, which could otherwise be caused by inappropriate waste handling of this product. The recycling of materials will help to conserve natural resources. For more detailed information about recycling of this product, please contact your local Civic Office, your household waste disposal service or the shop where you purchased the product.



Disposal of waste batteries (applicable in the European Union and other European countries with separate collection systems)

This symbol on the battery or on the packaging indicates that the battery provided with this product shall not be treated as household waste.

On certain batteries this symbol might be used in combination with a chemical symbol. The chemical symbols for mercury (Hg) or lead (Pb) are added if the battery contains more than 0.0005% mercury or 0.004% lead.

By ensuring these batteries are disposed of correctly, you will help prevent potentially negative consequences for the environment and human health which could otherwise be caused by inappropriate waste handling of the battery. The recycling of the materials will help to conserve natural resources.

In case of products that for safety, performance or data integrity reasons require a permanent connection with an incorporated battery, this battery should be replaced by qualified service staff only. To ensure that the battery will be treated properly, hand over the product at end-of-life to the applicable collection point for the recycling of electrical and electronic equipment.

For all other batteries, please view the section on how to remove the battery from the product safely. Hand the battery over to the applicable collection point for the recycling of waste batteries.

For more detailed information about recycling of this product or battery, please contact your local Civic Office, your household waste disposal service or the shop where you purchased the product.

For customers in Australia and New Zealand

This equipment should be installed and operated with at least 20 cm and more between the radiator and person's body (excluding extremities: hands, wrists, feet and ankles).

On the illustrations in this manual

The illustrations and screen shots used in this manual are of the SA-NS310 unless noted otherwise.

Table of Contents

Features of this unit	8
Setting up your home network	9

Getting Started

Guide to Parts and Controls	10
Main unit of SA-NS410	10
Main unit of SA-NS310	13
Remote control	16
Checking the Supplied Accessories	17
Preparing the Unit and the Remote	
Control	17
Connecting to an AC power source	17
Preparing the remote control	18
Turning the Unit On	18

Network Connections

How to Connect Your Network	20
Setting Up for a Wireless Network	20
Option 1: Method for using a supplied CD-ROM and Windows PC	20
Option 2: Method for using an application for smartphones or Tablets (Android device/iPhone/iPod touch/iPad)	21
Option 3: Manual setting method using an Access Point Scan (for PC/Mac)	22
Option 4: Method for using a WPS push button at the access point supporting WPS	23
Setting Up Wired Networks	24
Option 5: DHCP method	24

Listening to Audio Content Over Your Home Network

Using DLNA (Digital Living Network Alliance)	25
Listening to audio content on a computer with Windows 7	25
Listening to audio content on a computer with Windows Vista/Windows XP	27

Using Internet music streaming (Music Service)

Using Internet music streaming	29
Preparing your mobile device instead of the remote control	29
Enjoying Internet music streaming	30

Using AirPlay

Using AirPlay	32
---------------------	----

Using Music Throw

Using Music Throw on a Sony Tablet	34
--	----

Others

Using the PARTY STREAMING	35
Starting a PARTY	35
Joining a PARTY	35
Updating software	36
Setting Screen on the Browser	37
Using the setting screen on the browser	37
Starting the browser with Windows XP	38
Specifications	39
Precautions	41

Troubleshooting

Troubleshooting	42
Indicator information	47

Features of this unit

You can enjoy music from anywhere in your home by connecting this DLNA (Digital Living Network Alliance)-compliant unit to a network. For example, you can listen to audio content stored on the computer in the bedroom, through this unit in the living room (page 25).

Internet music streaming

You can enjoy Internet music streaming, using “Network Audio Remote^{*}” application without a PC. This application allows your Android phone/Sony Tablet/iPhone/iPod touch/iPad to be used as a music controller (page 29).

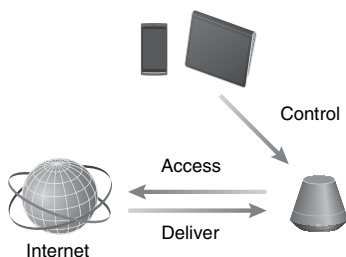

Music on your PC

You can play audio on a Mac or Windows PC with iTunes (page 32) or Windows Media Player (page 25).

AirPlay

You can play audio on an iPhone, iPod touch or iPad. You can also control audio content from anywhere in your home (page 32).

Music Throw by Sony Tablet

You can stream your music to the network speaker directly, using the built-in music player of a Sony Tablet (page 34).

PARTY STREAMING

PARTY STREAMING allows you to play back the same audio content through speakers having the PARTY STREAMING function at the same time (page 35).

Analog input supported

You can use this unit as a general active speaker without connecting to a network.

Listening to the music from a server

You can enjoy your favorite music content from your DLNA-compliant server (computer, etc.) by controlling the server using “Network Audio Remote” application. For details, see page 25.

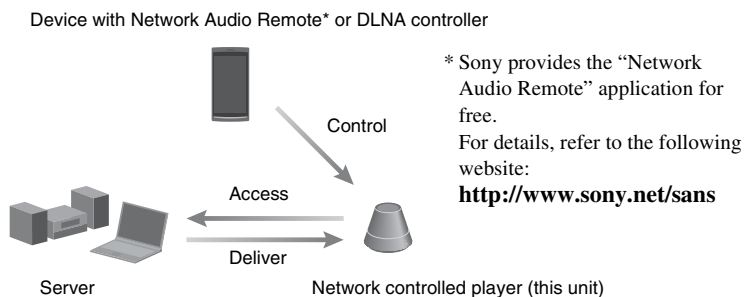

You can listen to audio content through only this unit by using a computer as both server and controller. Windows 7 has to be installed on your computer to use this function. For details, see page 25.

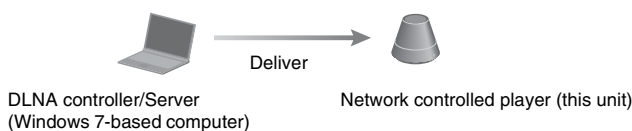

Setting up your home network

Refer to the following pages according to your network environment.

Wireless networks

➔ Set up your network, using the supplied CD-ROM or an application for smartphones. Refer to the leaflet “Quick Start Guide” for details. When you set up your network manually, see page 20.

WPS* compliant wireless networks

➔ Page 23

Wired networks

➔ Page 24

* WPS is a standard for easy and secure establishment of a wireless home network. Many new wireless LAN router/access point come with this feature.

Guide to Parts and Controls

Main unit of SA-NS410

Front

For details on each indicator, see “Indicator information” (page 47).

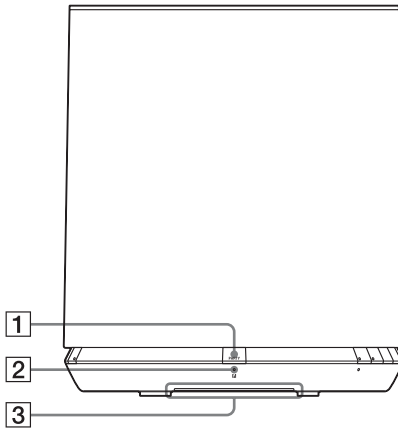

1 PARTY button

Press to use the PARTY STREAMING function (page 35).

Tip

This button also receives signals from a remote control.

Aim the remote control at this point.

The remote signal reception of this unit may not work correctly when the surface of this button is dirty.

2 PARTY STREAMING indicator

Indicates the PARTY STREAMING status (page 35).

Green: The unit is having a PARTY as PARTY host.

Amber: The unit has joined a PARTY as PARTY guest.

Red: An error has occurred.

3 Illumination indicator

Indicates the playback status of audio content.

Blue (lit): The unit has stopped playing back audio content.

White (lit): The unit is in playback mode.

White (flashing): The unit is in preparation for playback.

An error has occurred in the playback if it is flashing quickly.

Note

This indicator flashes during start up. It may take for a while.

Side

For details on each indicator, see “Indicator information” (page 47).

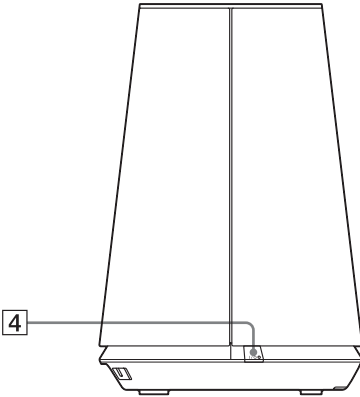

4 I/O (ON/Standby) button, indicator

Press to switch between power on and the standby mode (page 18).

Indicates the power status of the unit (page 18).

Green: The unit is turned on.

Amber: The unit is in the network standby mode.

Red: The unit is in the standby mode.

5 AUDIO IN button, indicator¹⁾

Press to switch the audio input on or off.

Lights in green when the audio input is on.

6 UPDATE button, indicator

Press to start updating the software of the unit (page 36).

Indicates the update status of the unit.

Green (lit): The unit can be updated.

Green (flashing): The unit is updating.

Red (flashing): An error has occurred.

Not lit: The unit does not need updating.

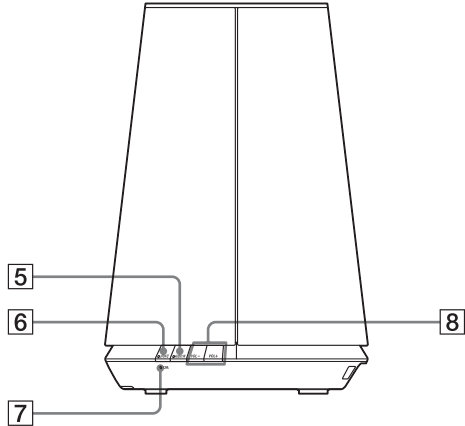

7 LINK indicator

Indicates the connection status of the wired/wireless LAN.

Green: Wireless connection (page 20).

Amber: Wired connection (page 24).

Red: The following status have occurred.

- This unit cannot find the wireless LAN access point.
- The security method/password selected for the access point is wrong.
- An error has occurred.

Not lit: The wireless network setting process is not finished.

8 VOL +²⁾/– buttons

Use to adjust the volume. The illumination indicator flashes rapidly when the volume level is set to either minimum or maximum.

¹⁾Home network/AirPlay/Internet music streaming is selected automatically when the AUDIO IN indicator is off.

²⁾The VOL+ button has a tactile dot. Use it as a reference point for operations.

Back

For details on each indicator, see “Indicator information” (page 47).

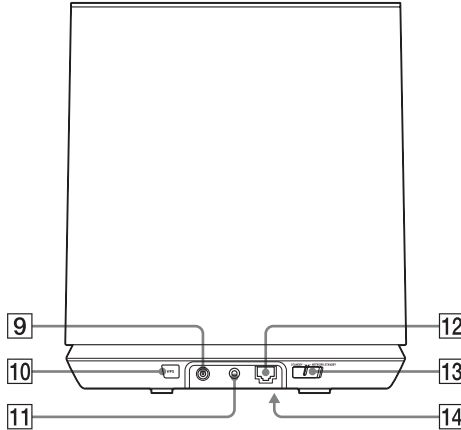

9 DC IN terminal

Use to connect the supplied AC adaptor (page 17).
Rated output voltage of an AC adaptor: DC 18 V, 2.6 A

Note

The supplied AC adaptor and AC power cord are exclusive for this unit. Do not use an AC adaptor not supplied with this unit.

10 WPS button

Use to make the network settings for the WPS push button configuration (page 23).

11 AUDIO IN terminal

Use to connect the audio output jack of an external component.

12 LAN port

Use to connect the network (LAN) cable (not supplied).

13 NETWORK STANDBY / STANDBY switch

Switch between the network standby mode and the standby mode (page 19).

14 ALL RESET button (Bottom)

Press and hold until all indicators light while the unit is being turned on and reset to its factory default settings.
Use a thin object, such as a small pin.
The previously registered settings or information will be reset.

Note

Network settings are also reset when you press ALL RESET button.

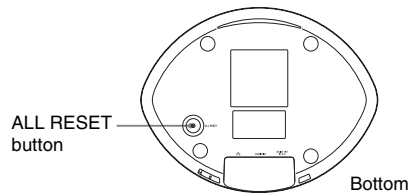

Front

For details on each indicator, see “Indicator information” (page 47).

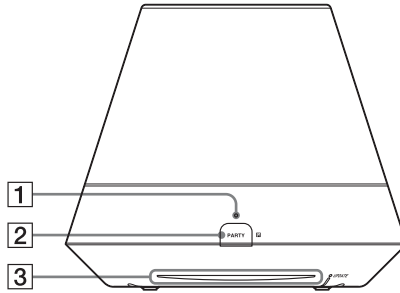

1 PARTY STREAMING indicator

Indicates the PARTY STREAMING status (page 35).

Green: The unit is having a PARTY as PARTY host.

Amber: The unit has joined a PARTY as PARTY guest.

Red: An error has occurred.

2 PARTY button

Press to use the PARTY STREAMING function (page 35).

Tip

This button also receives signals from a remote control.

Aim the remote control at this point.

The remote signal reception of this unit may not work correctly when the surface of this button is dirty.

3 Illumination indicator

Indicates the playback status of audio content.

Blue (lit): The unit has stopped playing back audio content.

White (lit): The unit is in playback mode.

White (flashing): The unit is in preparation for playback.

An error has occurred in the playback if it is flashing quickly.

Note

This indicator flashes during start up. It may take for a while.

Side

For details on each indicator, see “Indicator information” (page 47).

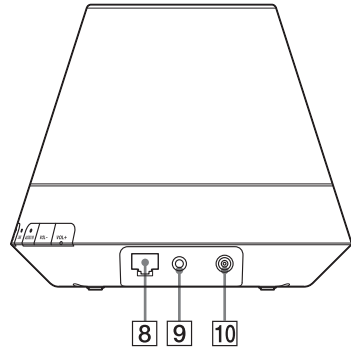
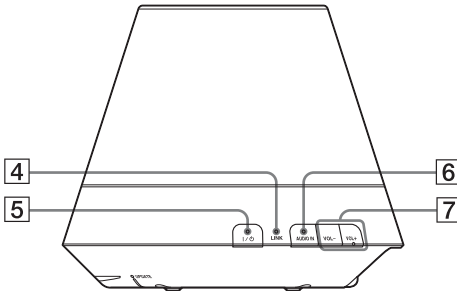

4 LINK indicator

Indicates the connection status of the wired/wireless LAN.

Green: Wireless connection (page 20).

Amber: Wired connection (page 24).

Red: The following status have occurred.

- This unit cannot find the wireless LAN access point.
- The security method/password selected for the access point is wrong.
- An error has occurred.

Not lit: The wireless network setting process is not finished.

5 I/ON (ON/Standby) button, indicator

Press to switch between power on and the standby mode (page 18).

Indicates the power status of the unit (page 18).

Green: The unit is turned on.

Amber: The unit is in the network standby mode.

Red: The unit is in the standby mode.

6 AUDIO IN button, indicator¹⁾

Press to switch the audio input on or off.

Lights in green when the audio input is on.

7 VOL +²⁾/- buttons

Use to adjust the volume. The illumination indicator flashes rapidly when the volume level is set to either minimum or maximum.

8 LAN port

Use to connect the network (LAN) cable (not supplied).

9 AUDIO IN terminal

Use to connect the audio output jack of an external component.

10 DC IN terminal

Use to connect the supplied AC adaptor (page 17).

Rated output voltage of an AC adaptor: DC 13 V, 2 A

Note

The supplied AC adaptor and AC power cord are exclusive for this unit. Do not use an AC adaptor not supplied with this unit.

¹⁾Home network/AirPlay/Internet music streaming is selected automatically when the AUDIO IN indicator is off.

²⁾The VOL+ button has a tactile dot. Use it as a reference point for operations.

Bottom

For details on each indicator, see “Indicator information” (page 47).

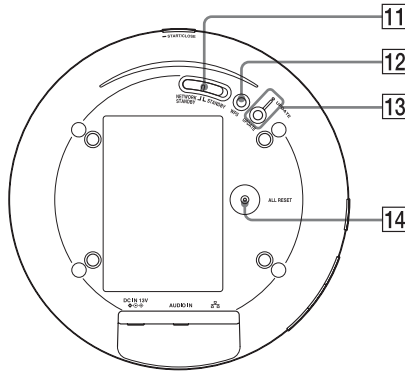

11 NETWORK STANDBY / STANDBY switch

Switch between the network standby mode and the standby mode (page 19).

12 WPS button

Use to make the network settings for the WPS push button configuration (page 23).

13 UPDATE button, indicator

Press to start updating the software of the unit (page 36).

Indicates the update status of the unit.
Green (lit): The unit can be updated.
Green (flashing): The unit is updating.
Red (flashing): An error has occurred.
Not lit: The unit does not need updating.

14 ALL RESET button

Press and hold until all indicators light while the unit is being turned on and reset to its factory default settings.

Use a thin object, such as a small pin.
The previously registered settings or information will be reset.

Note

Network settings are also reset when you press ALL RESET button.

Remote control

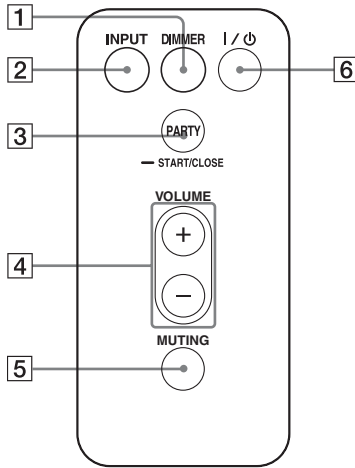

1 DIMMER button

Press to change the brightness of the illumination indicator (normal/dark).

2 INPUT button

Press to switch the audio input on or off.

3 PARTY button

Press to use the PARTY STREAMING function (page 35).

4 VOLUME +/- buttons

Press to adjust the volume.

5 MUTING button

Press to turn the sound off temporarily.
The illumination indicator blinks in blue during muting.

6 I/⏻ (ON/Standby) button

Press to switch between power on and the standby mode (page 18).

Checking the Supplied Accessories

Make sure that the following items are included in the package along with the speaker.

- Remote control (1)
- AC adaptor (1)
- AC power cord (1)
- CD-ROM (“NS Setup”) (1)
- Operating Instructions (this manual)
- Quick Start Guide (Leaflet)

Preparing the Unit and the Remote Control

Connecting to an AC power source

- 1** Connect the AC power cord to the AC adaptor.

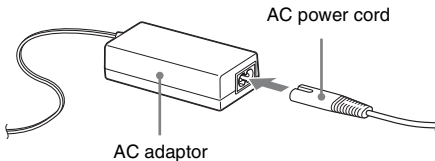

- 2** Plug the connector of the AC adaptor into the DC IN terminal on the unit.

SA-NS410

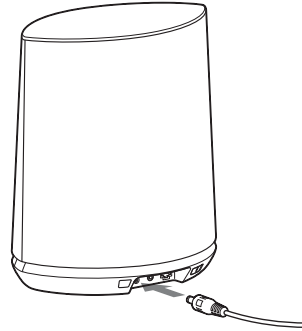

SA-NS310

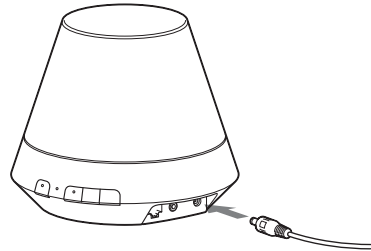

- 3** Plug the AC power cord to a wall outlet (the mains).

Preparing the remote control

The supplied lithium battery (CR2025) has already been inserted into the remote control. Pull out the protective sheet before use.

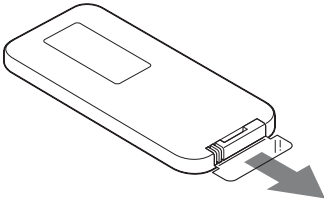

Replacing the battery of the remote control

If the remote control stops working, replace the battery (CR2025) with a new one.

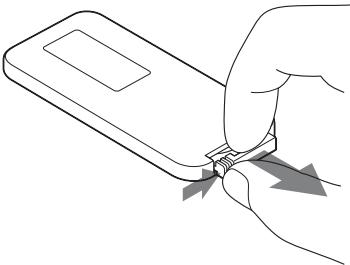

- 1 Pull out the battery holder.
- 2 Remove the old battery from the battery holder then insert a new battery so that “+” is facing upward.
- 3 Reinsert the battery holder into the remote control.

Turning the Unit On

Make sure the unit is connected to an AC power source (page 17).

The I/⏻ (ON/Standby) indicator flashes in green and the illumination indicator lights. You can operate this unit when the I/⏻ (ON/Standby) indicator lights in green and the illumination indicator lights. It may take a while.

SA-NS410

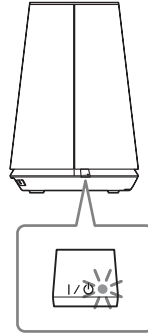

SA-NS310

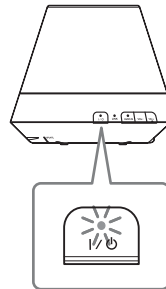

To set the network standby mode

SA-NS410

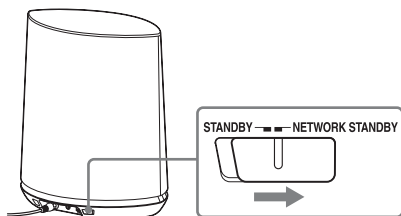

SA-NS310

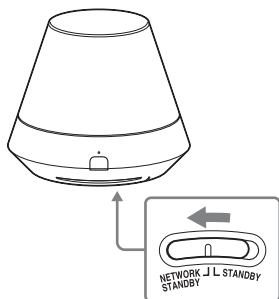

- 1 Set the NETWORK STANDBY/STANDBY switch to NETWORK STANDBY.
- 2 Press the I/⏻ (ON/Standby) button. The I/⏻ (ON/Standby) indicator lights up in amber.

Note

Keep this unit in the network standby mode so it can be controlled from a controller on the network even when you are not currently operating this unit.

Tips

- The NETWORK STANDBY/STANDBY switch is set to STANDBY in the factory default settings.
- The unit can be controlled from the controller on your network, etc., when the unit is in the network standby mode. The unit turns on automatically when the controller delivers audio content to this unit.

To set the standby mode

SA-NS410

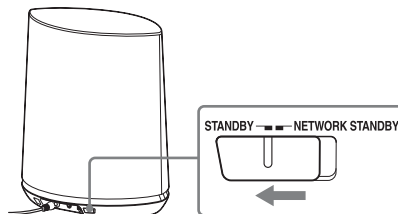

SA-NS310

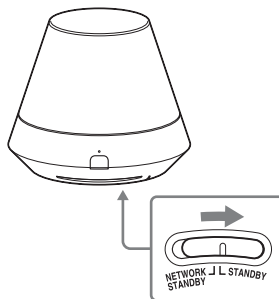

- 1 Set the NETWORK STANDBY/STANDBY switch to STANDBY.
- 2 Press the I/⏻ (ON/Standby) button. The I/⏻ (ON/Standby) indicator lights up in red.

Note

You cannot operate this unit via a home network when the unit is in the standby mode. Set the unit to the network standby mode when you want to operate the unit via a home network.

To resume power from the network standby mode or the standby mode

Press the I/⏻ (ON/Standby) button. The I/⏻ (ON/Standby) indicator lights up in green and the illumination indicator lights up.

To turn the unit off

Disconnect the AC power cord when you need to turn the unit off, such as when you not use it for a long time.

How to Connect Your Network

Set up the network after checking your network environment. Refer to the following descriptions.

For details, refer to the following website:
<http://www.sony.net/sans>

Setting Up for a Wireless Network

Select the suitable method and start to make the network settings.

- Option 1: Method for using a supplied CD-ROM and Windows PC (page 20)
- Option 2: Method for using an application for smartphones or Tablets (Android device/iPhone/iPod touch/iPad) (page 21)
- Option 3: Manual setting method using an Access Point Scan (for PC/Mac) (page 22)
- Option 4: Method for using a WPS push button at the access point supporting WPS (page 23)

Setting Up for a Wired Network

- Option 5: DHCP method (page 24)

Tip

About connecting the fixed IP address and setting of the proxy server, display the Setting Screen on a browser and set these referring to "Option 3:Manual setting method using an Access Point Scan (for PC/Mac)" (page 22).

When a problem occurs while you are making the network settings

Press ALL RESET button on the bottom of the unit with a pointed object (such as a small pin) (page 12 for SA-NS410/page 15 for SA-NS310).

Setting Up for a Wireless Network

Note

When setting up a wireless network, SSID (Wireless Network Name) and Security Key (WEP or WPA key) may be required. Security key (or network key) is an encryption key used to limit the devices with which communication can occur. It is used to provide higher security for devices communicating via a wireless LAN router/access point.

Option 1: Method for using a supplied CD-ROM and Windows PC

Note

Make sure your PC is wirelessly connected to a LAN.

- 1 Have your wireless network name (SSID) and Security Key (if applicable) available for reference.**

SSID (Wireless Network Name)

Security Key (WEP or WPA key)

Refer to the operating instructions of the wireless LAN router/access point.

- 2 Connect the AC adaptor to the unit.**

Check that the I/⏻ (ON/Standby) indicator changes from flashing in green to lit in green.

- 3 Load the supplied CD-ROM into the CD-ROM drive of your PC.**

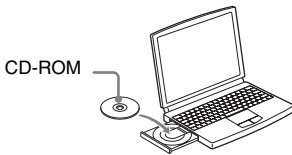

If the program does not start automatically, double-click on “NS_Setup.exe” on the CD-ROM.

4 Perform setup, following step 1 to 4 of the on-screen instructions.

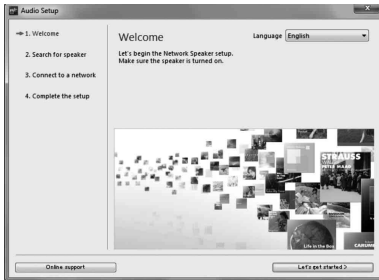

When setup is completed, press the “Play test sound” button to confirm operation of the speaker by playing the test sound.

Option 2: Method for using an application for smartphones or Tablets (Android device/iPhone/iPod touch/iPad)

Notes

- Before starting this procedure, be aware that your Wi-Fi network will not be protected until the setting is complete. After the setting is complete, your Wi-Fi network will be protected again when you set wireless LAN security.
- The following procedure must be completed within 30 minutes. If you cannot complete it, turn off the unit and start over from step 1.

1 Have your wireless network name (SSID) and Security Key (if applicable) available for reference.

SSID (Wireless Network Name)

Security Key (WEP or WPA key)

Refer to the operating instructions of the wireless LAN router/access point.

2 Turn the unit on.

Check that the I/⏻ (ON/Standby) indicator changes from flashing in green to lit in green.

Notes

- If you have set this already with any of “Option 1” to “Option 4,” setup may not be performed completely. Be sure to perform all-reset for the unit. Press and hold the ALL RESET button until all indicators light (page 12 for SA-NS410/page 15 for SA-NS310).
- Do not connect the network (LAN) cable.

3 Download the “NS Setup” application and launch it.



You can download the free application from “Google Play” for Android devices or “App Store” for iPhone/iPod touch/iPad on the website.

You can search the application easily if you type “NS Setup” into the search screen.

When setting up with an iPhone/iPod touch/iPad

Go to [Settings] - [Wi-Fi] and select “Sony_Wireless_Audio_Setup”.

If “Sony_Wireless_Audio_Setup” does not appear, wait until the speaker finishes turning on.

4 Perform setup, following the on-screen instructions.

When setup is completed, press the “Play test sound” button to confirm operation of the speaker by playing the test sound.

Option 3: Manual setting method using an Access Point Scan (for PC/Mac)

Note

Before starting this procedure, be aware that your Wi-Fi network will not be protected until the setting is complete. After the setting is complete, your Wi-Fi network will be protected again when you set a wireless LAN security.

1 Have your wireless network name (SSID) and Security Key (if applicable) available for reference.

SSID (Wireless Network Name)

Security Key (WEP or WPA key)

Refer to the operating instructions of the wireless LAN router/access point.

2 Turn the unit on.

3 Press and hold the ALL RESET button on the bottom of the unit with a thin object such as a small pin until the I/⏻ indicator starts flashing.

4 Check that the I/⏻ (ON/Standby) indicator changes from flashing in green to lit in green.

5 Connect the unit and a Mac or PC.

For Mac OS X

Turn on Mac.

Click  icon on the top of the screen. Turn on the Wi-Fi or AirPort. Then select [Open Network Preferences...]. Select [Sony_Wireless_Audio_Setup] from the network list.

For Windows 7

Turn on PC.

Click  icon on the bottom of the screen.

Select [Sony_Wireless_Audio_Setup] from the network list.

For Windows Vista

Turn on PC.

Click  icon on the bottom of the screen.

Click [Connect to a network].

Select [Sony_Wireless_Audio_Setup] from the network list.

6 Access the [Sony Network Device Setting] screen.

For Mac

Start Safari and select [Bonjour] under [Bookmarks], then select [SA-NS410] or [SA-NS310].

For PC

Start the browser and input either of the following URLs into the browser's address bar.



7 Select the desired language when the [Language Setup] screen appears.

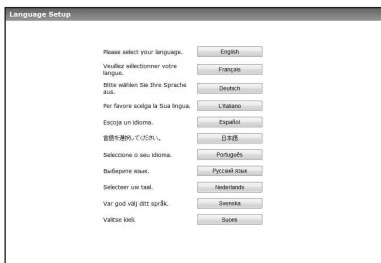

8 Select [Network Settings] from the menu.

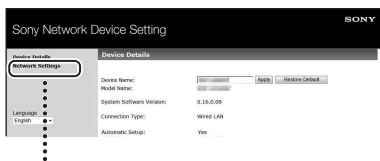

Network Settings

9 Select the SSID of the wireless LAN router/access point, then input the Security Key (if applicable).

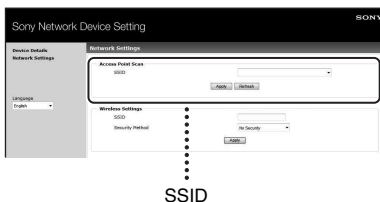

SSID

10 Select [Apply].

11 Click [OK] in the displayed window.

The unit restarts automatically, then the LINK indicator lights up green when the connection is established.

12 Reconnect the Mac or PC to your network.

Note

This procedure needs to be completed within 30 minutes. If you cannot complete, start over from step 3.

Option 4: Method for using a WPS push button at the access point supporting WPS

1 Check whether the network (LAN) cable (not supplied) is disconnected.

Disconnect the network (LAN) cable while the AC power is disconnected if the network (LAN) cable is connected.

2 Turn the unit on.

You can operate this unit when the I/⏻ (ON/Standby) indicator lights up in green and the illumination indicator lights up. It may take a while.

Note

Make sure the AUDIO IN indicator is not lit.

3 Press the WPS button on the access point.

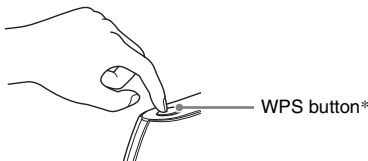

* The position and the shape of the WPS button are different depending on the model of the access point.

Tip

Refer to the operating instructions of your wireless LAN router/access point for details on the WPS button.

4 Press the WPS button on the unit for three seconds.

The LINK indicator lights up in green when the connection is made.

Setting Up Wired Networks

Option 5: DHCP method

Usually, the DHCP setting is set to ON when you connect your computer to the network. Try the following method if you are using a wired network.

Set the DHCP setting of your computer to ON in advance.

- 1 Check whether your computer and router are turned on.**
- 2 Connect the unit and the router using a network (LAN) cable (not supplied).**
- 3 Connect the router and your computer using a second network (LAN) cable (not supplied).**

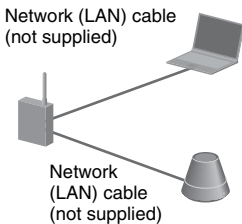

- 4 Turn the unit on.**

The LINK indicator lights up in amber when the connection is made.

Listening to Audio Content Over Your Home Network

Using DLNA (Digital Living Network Alliance)

You can play back audio content on DLNA-compliant servers such as your computer, or network audio, etc., on this unit by controlling the server using “Network Audio Remote” application. A DLNA-compliant controller device (a remote control device, etc.) is needed for the operation.

You can use Windows 7 as both server and controller.

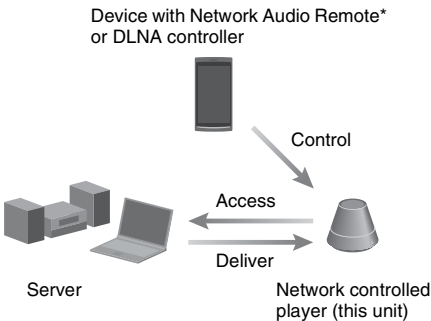

* Sony provides the “Network Audio Remote” application for free.
For details, refer to the following website:
<http://www.sony.net/sans>

The unit can play audio content stored on the server in MP3, Linear PCM, WMA and AAC* formats. Audio content with DRM (Digital Rights Management) copyright protection cannot be played on this unit.

* The unit can play AAC files with the extension of “.m4a,” “.mp4,” or “.3gp” only.

Notes

- Generally, it may take a while to recognize each DLNA-compliant device currently used when you enjoy audio content via a home network.
- This unit cannot playback files in WMA format with DRM copyright protection. If a WMA file cannot be played back on this unit, check the

property of that file on your computer, and see whether the file is DRM-copyrighted.

Open a folder or a volume where the WMA file is stored, and right-click the file to display the [Property] window. When there is the [Licence] tab, the file is DRM-copyrighted and cannot be played back on this unit.

- You may not be able to play back some content with DLNA CERTIFIED products.

Listening to audio content on a computer with Windows 7

Windows 7 supports DLNA1.5. Windows 7 can be used as both server and controller. You can listen to audio content on the server easily using the [Play To] function of Windows 7.

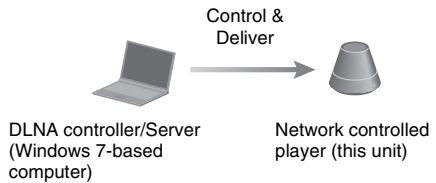

Note

The items displayed on the computer may be different from the ones shown in this section, depending on the version of the operating system or the computer environment. For details, refer to the help of your operating system.

Setting up a computer with Windows 7

- 1 Go to [Start] - [Control Panel] and select [View network status and tasks] under [Network and Internet].

The [Network and Sharing Center] window appears.

Tip

If the desired item does not appear in the display, try to change the display type of the Control Panel.

- 2 Select [Public network] under [View your active networks]. If the display shows other than [Public network], go to step 5.

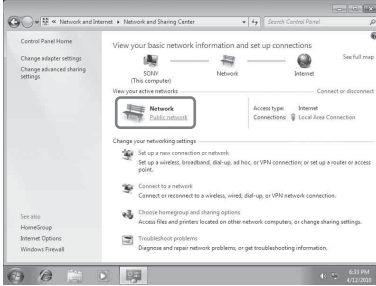

The [Set Network Location] window appears.

- 3 Select [Home network] or [Work network] according to the environment in which the speaker is used.
- 4 Follow the instructions that appear on the display according to the environment in which the speaker is used. When the change is completed, confirm that the item under [View your active networks] has been changed to [Home network] or [Work network] in the [Network and Sharing Center] window.
- 5 Select [Change advanced sharing settings].

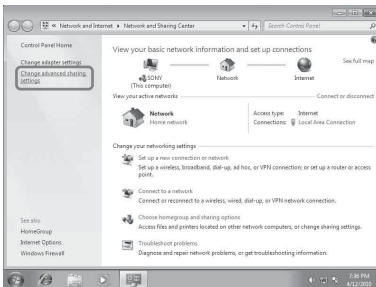

- 6 Select [Choose media streaming options...] from [Media streaming].

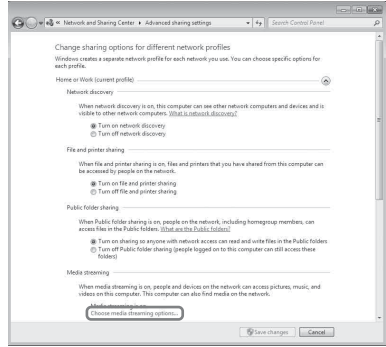

- 7 If [Media streaming is not turned on] appears in the Media streaming options window, select [Turn on media streaming].
- 8 Select [Allow All].

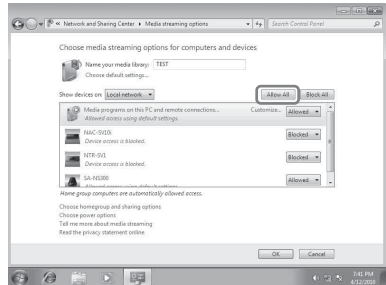

The [Allow All Media Devices] window opens. If all the devices in the local network are [Allowed] to access your network, select [OK] and close the window.

- 9 Select [Allow all computers and media devices].
- 10 Select [OK] to close the window.

Listening to audio content stored on a computer with Windows 7

- 1 Start [Windows Media Player] of Windows 7.
- 2 Turn on media streaming.
- 3 Select the desired audio content, then click the right mouse button.

4 Select [Play To] from the menu.

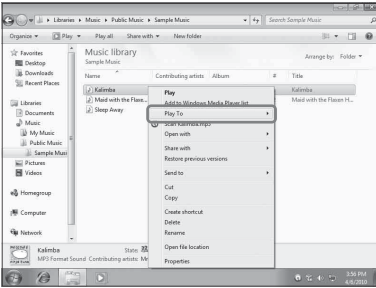

The device list appears.

5 Select [SA-NS410] or [SA-NS310].

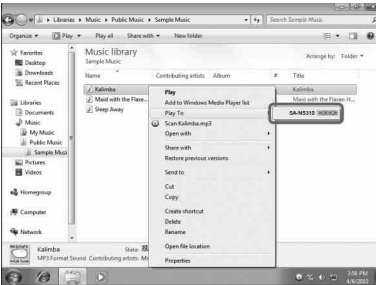

The audio content is played back from this speaker.

Listening to audio content on a computer with Windows Vista/ Windows XP

You need to set up Windows Media Player 11 to listen to the music using the Windows Vista/ Windows XP* as a server.

* Windows Media Player 11 is not manufacturer-installed on Windows XP. Access the Microsoft website, download the installer, and then install Windows Media Player 11 on your computer. Update the software version of your computer to XP Service Pack 2 or later, then install Windows Media Player 11. You cannot install Windows Media Player 11 on versions of XP prior to Service Pack 2.

Note

The items displayed on the computer may be different from the ones shown in this section,

depending on the version of the operating system or the computer environment. For details, refer to the help of your operating system.

Setting up a computer with Windows Vista/ Windows XP

1 Go to [Start] - [All Programs] and select [Windows Media Player].

Windows Media Player 11 starts up.

2 Select [Media Sharing...] from the [Library] menu.

If you are using Windows XP, go to step 8.

3 When  is displayed, select [Networking...].

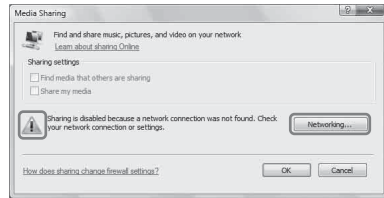

The [Network and Sharing Center] window appears.

4 Select [Customize].

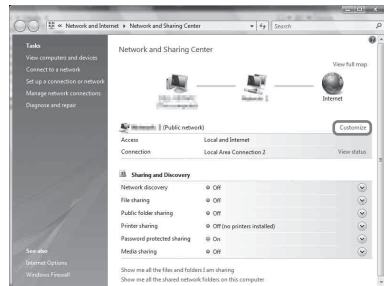

The [Set Network Location] window appears.

- 5 Add a check next to [Private] and select [Next].

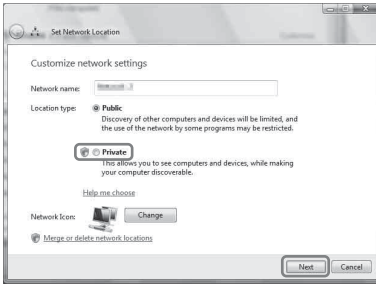

- 6 Confirm that the [Location type] has been changed to [Private] and select [Close].
- 7 Confirm that [(Private network)] is displayed in the [Network and Sharing Center] window and close the window.
- 8 If a check is not added next to [Share my media] in the [Media Sharing] window that is displayed in step 2, add a check next to [Share my media], then select [OK].



A list of connectable devices is displayed.

- 9 Select [Settings...] that appears beside [Share my media to:].
- 10 Add a check next to [Allow new devices and computers automatically] and select [OK].

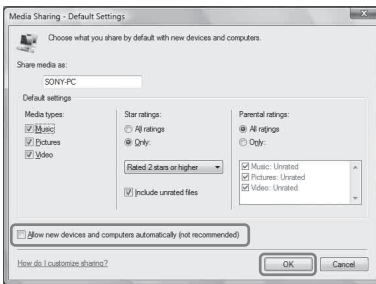

Note

Uncheck this item after you confirm that the unit can connect to the computer and play audio data on the computer.

Listening to audio content stored on a computer with Windows Vista/ Windows XP

You can play back audio content, using the DLNA controller (page 25).

Using Internet music streaming (Music Service)

Using Internet music streaming

You can listen to various Internet music streaming offered on the Internet, using “Network Audio Remote” without a PC.

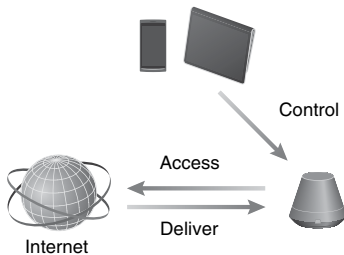

Preparing your mobile device instead of the remote control

Notes

- Before using Internet music streaming, check the following:
 - Check that all devices are connected to your home network and set up correctly.
 - Check that the unit is turned on or in network standby mode.
 - Check that the unit and the controller are allowed to access the server.
 - Check that the unit and the server have been recognized and registered with the controller.
- You may have to register your system depending on the service provider. For details on registration, visit the customer support site of the service provider. For details, refer to the following website:
<http://www.sony.net/sans>
- If you need the latest support information on Internet music streaming and Registration code, refer to the following website:
<http://www.sony.net/sans>

1 Download the application “Network Audio Remote” and launch it.



You can download the free application from “Google Play” for an Android device or “App Store” for iPhone/iPod touch/iPad on the website.

You can search the application easily if you enter “Network Audio Remote” into the search screen.

2 Select the desired Internet music streaming.

e.g. Music Unlimited
[Music Services] - [Music Unlimited] - [Genre]

Enjoying Internet music streaming

Tip

The screens used in the following section are of the iPad. The screens of Android devices or iPhone/iPod touch differ.

1 Tap/click on the  icon on the screen of the Android device or iPhone/iPod touch/iPad.

2 Select your unit (SA-NS310 xxxxxx or SA-NS410 xxxxxx) from the speaker list.

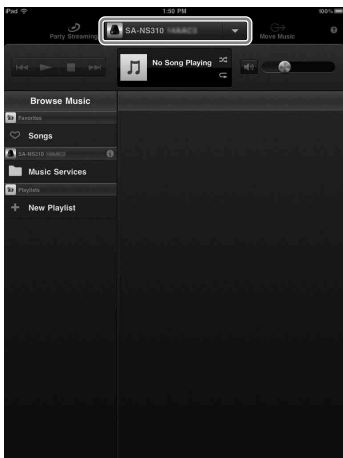

Browse Music list

3 Select the “Music Service” from the Browse Music list.

A list of service providers to which the unit can be connected appears.

4 Select the service provider you want.

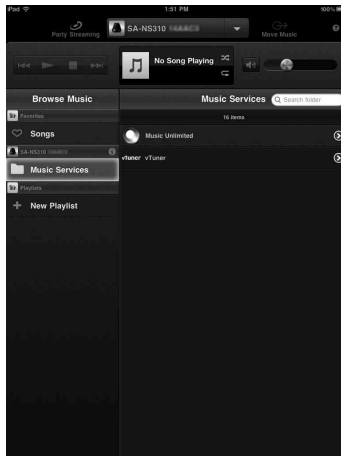

5 Select the desired playable content and start playback.

Tip

If playback does not start, perform the process again from step 1.

To confirm/edit the device name

You can confirm and edit the device name of this unit, using the setting screen on the browser.

See “Device Details screen” (page 37) for details.

To control Internet music streaming with the unit or remote control

You can use the VOL (VOLUME) +/- and MUTING buttons. Operation from the unit and the remote control is active only when the unit is selected as the device for output.

Tips

- Very loud sound may output from this unit when you set the volume too high using an Android device or iPhone/iPod touch/iPad.
- For details on the use of the Android OS or iOS, refer to Help of each OS.
- The volume level of a the Android device or iPhone/iPod touch/iPad may not be able to be linked with the volume level of this unit.
- For details on the use of “Network Audio Remote,” tap/click on the Help icon or Option icon of it.

Using AirPlay

Using AirPlay

You can play audio from iPhone, iPod touch or iPad, and Mac or PC with iTunes.

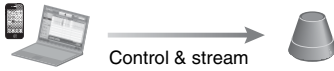

Compatible iPhone/iPod touch/iPad models

iPhone 4S, iPhone 4, iPhone 3GS, iPod touch (3rd or 4th generation), iPad, iPad2 with iOS 4.3.3 or later, and Mac or PC with iTunes 10.2.2 or later.

Notes

- See “Compatible iPhone/iPod touch/iPad models” on this page for details on the supported versions of iOS or iTunes.
- Update iOS or iTunes to the latest version before using with this unit.
- Refer to the operating manual of your device for details on operating iPhone, iPod touch, iPad, iTunes or AirPlay.
- You cannot use this unit as a PARTY host during the AirPlay playback.

- 1** Launch the music application of your iPhone, iPod touch, iPad, or iTunes.
- 2** Tap/click on the  icon at bottom right of the iPhone, iPod touch or iPad screen or iTunes window.

iPhone, iPod touch or iPad

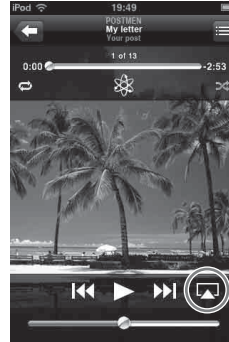

iTunes

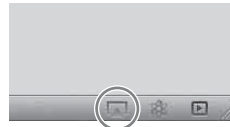

- 3** Select “SA-NS410” or “SA-NS310” on the AirPlay menu of iTunes or your iPhone, iPod touch or iPad.

iPhone, iPod touch or iPad

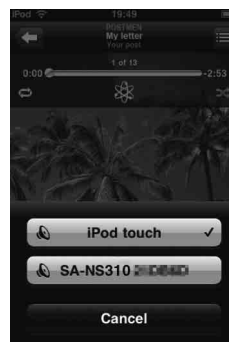

iTunes

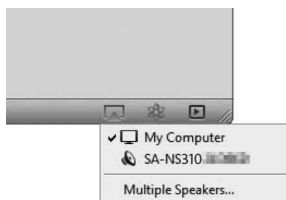

4 Start playing back audio content on an iPhone, iPod touch, iPad or iTunes.

Tip

If the playback does not start, perform the process again from step 1.

To confirm/edit the device name

You can confirm and edit the device name of this unit using the setting screen on the browser.

See “Device Details screen” (page 37) for details.

To control AirPlay playback

You can use the VOL (VOLUME) +/- and MUTING buttons. Operation from the unit and the remote control is active only when the unit is selected as the device for output.

For using iTunes, set it to accept control from the remote control if you want to use the remote control to operate iTunes.

Tips

- Very loud sound may output from this unit when you set the volume too high using iPhone, iPod touch, iPad or iTunes.
- For details on the use of iTunes, refer to Help of iTunes.
- The volume level of iPhone, iPod touch, iPad or iTunes may not be able to be linked with the volume level of this unit.

Using Music Throw

Using Music Throw on a Sony Tablet

You can play audio from a Sony Tablet.

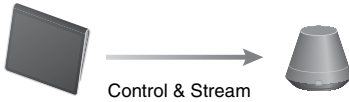

Notes

- Update the Android OS to the latest version before using it with this unit.
- Refer to the operating manual of your Sony Tablet for details.
- You cannot use this unit as a PARTY host during the Music Throw playback.
- Music player will be available on Xperia smartphones from Sony Mobile Communications in autumn of 2012. For details about upgrading, check the Sony Mobile Communications website.

1 Launch the “Music player” application on the Sony Tablet.



2 Tap/click on the icon at top center of the Sony Tablet.

3 Select “SA-NS410” or “SA-NS310” on the Music Throw menu of Sony Tablet.

Sony Tablet



4 Start playing back audio content on the Sony Tablet.

Tip

If playback does not start, perform the process again from step 1.

To confirm/edit the device name

You can confirm and edit the device name of this unit, using the setting screen on the browser.

See “Device Details screen” (page 37) for details.

To control Music Throw playback

You can use the VOL (VOLUME) +/- and MUTING buttons. Operation from the unit and the remote control is active only when the unit is selected as the device for output.

Tips

- Very loud sound may output from this unit when you set the volume too high using a Sony Tablet.
- For details on the use of the Android OS, refer to Help of Android OS.
- The volume level of a Sony Tablet may not be able to be linked with the volume level of this unit.

Using the PARTY STREAMING

You can play back audio content that is being played back on this unit or on another device that has a PARTY STREAMING function at the same time, via your home network. While using the PARTY STREAMING function, the device that starts a PARTY and streams the audio content is called the “PARTY host,” and the device that joins a PARTY and plays the audio content streamed from the PARTY host is called a “PARTY guest.”



You can enjoy the PARTY STREAMING function with other devices that have this PARTY STREAMING logo.

Notes on using the PARTY STREAMING

Depending on your device or environment, sound may skip or the unit cannot connect to the network. In this case, try following:

- Perform firmware updates for your router to the latest version. For details on the firmware updates, refer to the operating manual of your device.
- Perform firmware updates for your speaker to the latest version (page 36).
- If you are connecting to the network using wireless connection, change to using wired connection.
- For more detail information, refer to the following web site:
<http://www.sony.net/sans>

Starting a PARTY

You can start a PARTY so that other devices which support the PARTY STREAMING function can play the same music even though they are in different rooms.

- 1 Make sure the PARTY guest devices are turned on and are in a status which allows them to join a PARTY.**
- 2 Play back audio content using the AUDIO IN terminal or audio content stored on the server on your network on this unit.**
- 3 Press and hold PARTY for a few seconds.**

The unit starts PARTY STREAMING and the PARTY STREAMING indicator lights up in green.

To close a PARTY

Press and hold PARTY for a few seconds. The PARTY STREAMING indicator goes off.

Notes

- An error has occurred when the PARTY STREAMING indicator lights up in red. Perform the process from step 1 again.
- You cannot start a PARTY while you are currently participating in a PARTY.
- If the PARTY button is pressed on another device that complies with the PARTY STREAMING function while the unit is playing a track, the unit will start a PARTY as a PARTY host and the other device will join a PARTY as a PARTY guest.

Joining a PARTY

The unit can join a PARTY which has been started by another device so that you can enjoy the same audio content as that being played in a different room.

When another device (PARTY host) is having a PARTY, press PARTY.

The unit joins the PARTY as a PARTY guest and the PARTY STREAMING indicator lights up in amber.

To leave a PARTY

Press PARTY.

The PARTY STREAMING indicator goes off.

Notes

- An error has occurred when the PARTY STREAMING indicator lights up in red. Perform the process from step 1 again.
- The PARTY STREAMING indicator lights up in amber when other devices utilizing the PARTY STREAMING function invite this unit to a PARTY. When you want to leave that PARTY, press PARTY.
- You cannot join a PARTY in the following cases:
 - you have a PARTY on this unit
 - you have already joined in another PARTY
- If you press PARTY when no PARTY is being held, but a device that complies with the PARTY STREAMING function is playing, the device will be the PARTY host and the unit will join the PARTY as a PARTY guest.

To use the PARTY STREAMING function with a Network Audio Remote

You can use a Network Audio Remote that supports the PARTY STREAMING function to use the unit to start a PARTY that is being held by other devices.

Updating software

When a new update is available, the UPDATE indicator lights up in green while the unit is connected to the Internet.

Check the following customer support website about the update:

<http://www.sony.net/sans>

Notes

- Perform the following operations after confirm the message and also read and agree the “END-USER LICENSE AGREEMENT FOR SONY SOFTWARE” (page 49).
- Make sure you do not attempt any of the following operations while the update is in progress.
 - Turning the unit off
 - Connecting or disconnecting the network (LAN) cable (not supplied)
 - Disconnecting the AC adaptor
- About connecting the fixed IP address and setting of the proxy server, display the Setting Screen on a browser and set these referring to “Option 3:Manual setting method using an Access Point Scan (for PC/Mac)” (page 22).

1 Quit all operations before updating.

Tip

If you do not quit those, the unit will quit or stop all operations automatically.

2 Press and hold the UPDATE button on the side of SA-NS410 or the bottom of SA-NS310 until the illumination is turned off.

The update starts.

The UPDATE indicator flashes during the update.

SA-NS410

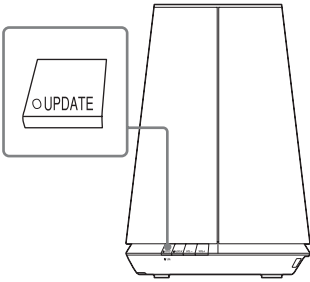

SA-NS310

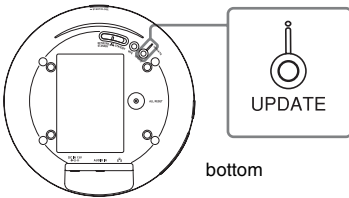

Notes

- It takes a while to finish updating.
- You cannot operate the unit until updating has completed.
- It may take several minutes to update the software of the unit. The time required depends on the size of the update content and type of Internet connection you are using.

Setting Screen on the Browser

To display the [Setting Screen] in your browser, refer to Option 2 “Method for using an application for smartphones or Tablets (Android device/ iPhone/iPod touch/iPad)” (page 21) or Option 3 “Manual setting method using an Access Point Scan (for PC/Mac)” (page 22).

Using the setting screen on the browser

You can make the various settings of this unit using the setting screen on the browser.

Device Details screen

You can check the information on this unit.

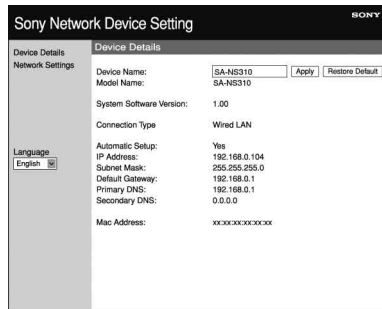

Network Settings screen

You can make the network settings using this screen.

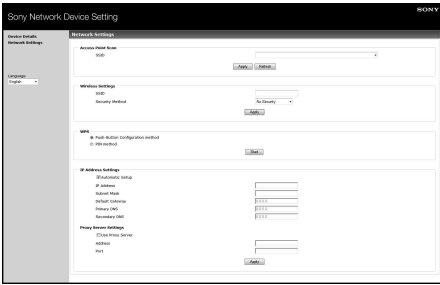

2 Click [Add/Remove Windows Components].

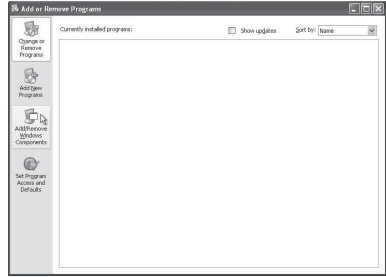

The Windows Components Wizard appears.

3 Click [Networking Services] → [Details...].

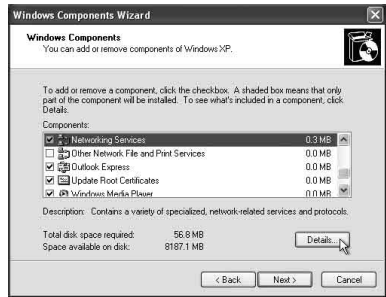

Starting the browser with Windows XP

You have to install the UPnP service for browsing.

Note

The items displayed on the computer may be different from the ones shown in this section, depending on the version of the operating system or the computer environment. For details, refer to the help of your operating system.

1 Click [Control Panel] → [Add or Remove Programs].



4 Put a check the check box beside [UPnP User Interface], then click [OK].

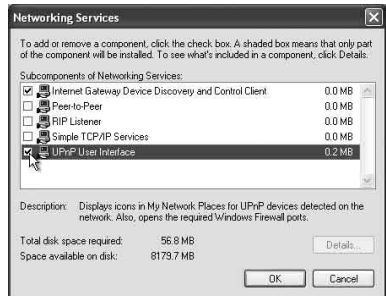

5 Click [Next].

The [Completing the Windows Components Wizard] window appears.

6 Click [Finish].



Specifications

AUDIO POWER SPECIFICATIONS

POWER OUTPUT AND TOTAL HARMONIC DISTORTION:

[SA-NS410]

Tweeter L+R

With 5 ohms loads, both channels driven, from 500 - 20 kHz; rated 10 watts per channels minimum RMS power, with no more than 1 % total harmonic distortion from 100 milliwatts to rated output.

[SA-NS310]

With 4 ohms loads, driven from 80 - 20 kHz; rated 6 watts minimum RMS power, with no more than 1 % total harmonic distortion from 100 milliwatts to rated output.

Power Output (reference):

[SA-NS410]

Tweeter L+R 15 W + 15 W (5 ohms, 1 kHz, THD 10%)

Woofer 15 W (6 ohms, 100 Hz, THD 10%)

[SA-NS310]

10 W (4 ohms, 1 kHz, THD 10%)

Wireless LAN section

Compatible standards:

IEEE 802.11 b/g

(WEP 64 bit, WEP 128 bit,
WPA/WPA2-PSK (AES),
WPA/WPA2-PSK (TKIP))

Frequency and Channel:

2.4 GHz

USA, Canada: CH 1 - CH 11

Others: CH 1 - CH 13

Inputs/Outputs

Speakers

[SA-NS410]

Tweeter: Approx. 30 mm (1 3/16 in) diameter
× 4

Woofer: Approx. 110 mm (4 3/8 in) diameter
× 1

[SA-NS310]

Approx. 50 mm (2 in) diameter × 1

AUDIO IN jack:

Stereo mini jack

Voltage: 1.0 V

Network port:

10BASE-T/100BASE-TX (Auto Polarity)

General

Power requirements:

[SA-NS410]

AC adaptor

Input: 120 V-240 V AC, 50/60 Hz

Output: DC 18 V 2.6 A

[SA-NS310]

AC adaptor

Input: 100 V-240 V AC, 50/60 Hz

Output: DC 13 V 2 A

Power consumption:

[SA-NS410]

When the unit is on: DC 18 V, 0.9 A

When the unit in standby mode: 0.5 W or below

When the unit in network standby mode:

3.5 W or below

[SA-NS310]

When the unit is on: DC 13 V, 0.4 A

When the unit in standby mode: 0.5 W or below

When the unit in network standby mode:

3.5 W or below

Dimensions (w/h/d) (including projecting parts and controls):

[SA-NS410]

Approx. 240 mm × 273 mm × 185 mm

(Approx. 9 1/2 in × 10 3/4 in × 7 3/8 in)

[SA-NS310]

Approx. 162 mm × 136 mm × 162 mm

(Approx. 6 3/8 in × 5 3/8 in × 6 3/8 in)

Mass

[SA-NS410]

Approx. 3.8 kg (8.4 lb)

[SA-NS310]

Approx. 1.1 kg (2.4 lb)

Supplied accessories:

[SA-NS410]

See page 17.

[SA-NS310]

See page 17.

Design and specifications are subject to change without notice.

Precautions

On safety

- Before operating the system, be sure that the operating voltage of the system is identical with that of your local power supply.

Where purchased	Operating voltage
North America	120 V AC, 60 Hz
All other regions	100 V-240 V AC, 50/60 Hz (SA-NS310) 120 V-240 V AC, 50/60 Hz (SA-NS410)

- Use only the supplied AC adaptor and AC power cord.
- When carrying the unit, be sure to hold it by the bottom of the unit. Do not hold it by the cloth, as the unit may slip out.

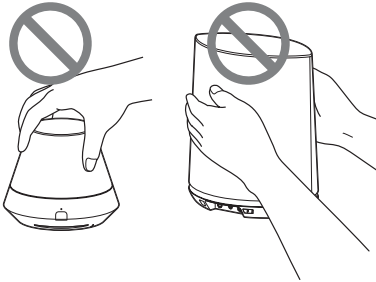

On operation

- Do not open the cabinet. Refer servicing to qualified personnel only.
- Should any solid object or liquid fall into the system, have the system checked by qualified personnel before operating it any further.
- This system is not magnetically shielded, do not leave recorded tapes, watches, personal credit cards, or floppy disks with magnetic coding in front of the system for an extended period of time.
- Do not put anything on top of the unit.

On placement

- Do not set the unit in an inclined position.
- Do not leave the unit in a location near heat sources, or in a place subject to direct sunlight, excessive dust, moisture, rain or mechanical shock.
- Do not place metal objects in front of the front panel. They may limit reception of radio waves.
- Do not place the system in a place where medical equipment is in use. It may cause a malfunction of medical equipment.
- If you use a pacemaker or other medical device, consult your physician or the manufacturer of your medical device before using the wireless LAN function.

On cleaning

- Wipe the unit using a soft cloth such as the cloths used for cleaning eye glasses, etc.
- Do not use alcohol, benzene, or thinner to clean the cabinet.

If the TV picture or monitor display is magnetically distorted

This speaker system is not magnetically shielded, and the picture on nearby TV sets may become magnetically distorted. In this situation, turn off the TV, wait 15 to 30 minutes, and turn it back on. If there is no improvement, move the speakers far away from the TV.

Troubleshooting

If a problem occurs while operating the unit, follow the steps described below before consulting your nearest Sony dealer. If an error message appears, it is recommended that you make a note of its contents for reference.

1 Check to see if the problem is listed in this “Troubleshooting” section.

2 Check the following customer support site.

<http://www.sony.net/sans>

You will find the latest support information and a FAQ at this website.

3 If, after steps 1 and 2, you still cannot solve the problem, consult your nearest Sony dealer.

If the problem persists after doing all of the above, consult your nearest Sony dealer.

When bringing the product in for repairs, be sure to bring in the entire system (main unit, remote control, AC adaptor, and AC power cord).

This product is a system product, and so the entire system is needed to determine the section requiring repair.

Power

The unit does not turn on.

- Make sure the AC adaptor and AC power cord are connected correctly.
- Be sure to press the I/⏻ (ON/Standby) button to set the unit to on.
- Press the I/⏻ (ON/Standby) button to set standby mode then press to set it back to on.

The network does not work after you press the I/⏻ (ON/Standby) button to set the unit to on.

- It takes about 40 seconds for the unit to turn on.

The unit remains warm after the power is turned off.

- When the unit is in the network standby mode, some parts of the internal system remain active. Press the I/⏻ (ON/Standby) button after setting the NETWORK STANDBY/STANDBY switch to STANDBY to minimize the power consumption. However, the unit cannot be operated using a controller on your network with this setting.

The unit turns on and starts playback automatically.

- The unit can be controlled by a controller on your network. If the unit receives an order to play the audio content on the server while it is in network standby mode, it turns on and starts playback automatically. To enter network standby mode again, press the I/⏻ (ON/Standby) button on the remote control. To prevent the unit from automatically turning on, set the NETWORK STANDBY/STANDBY switch to STANDBY.

The unit turns off automatically.

- The unit enters the selected standby mode after being idle for 30 minutes.

Sound output

There is no sound.

- Press the VOL (VOLUME) + button to turn up the volume. The unit may have been set to silence the sound by a controller on your network. If the sound is output for a moment and then is silenced again, the unit may have received a command to silence the sound. Confirm the setting of the controller and release deleting the sound.
- When the PARTY STREAMING indicator lights in amber, confirm the audio format of the audio content that is being played by the PARTY host. The unit stops playback when the PARTY host attempts to play audio content of an audio format that cannot be played on the unit.
- Sound is not output when the unit is muted by your having pressed the MUTING button. The illumination indicator on the front of the unit flashes in blue during muting. In this case, press MUTING or VOL +/- button on the remote control when you wish to release muting.

The sound skips.

- The sound may skip, depending on the network environment, etc., when you use a wireless network. In this case, try changing the security method to “WPA/WPA2-PSK (AES).” This may improve the transfer speed and streaming playback.
- The servers are overloaded. Close all other applications you are currently using.
- Perform firmware updates for your access point (wireless LAN router) to the latest version.

There is severe humming, noise, or sound distortion from the speakers.

- Connect the unit and other devices correctly (page 12 for SA-NS410/page 14 for SA-NS310).

Network

The unit cannot connect to the network. (The unit cannot be found or recognized by other devices that are on the home network.)

- If you use the unit in a network environment without a router, it may take about a minute for the unit to obtain its IP address after you turn on the power.
- The IP address may be in use by another device when you use a fixed IP address. Use a different IP address in such a case.

The unit cannot connect to the network via a wireless LAN connection.

- Make sure a network (LAN) cable is not connected to the unit. The unit automatically tries to connect to the network over a wired LAN connection when a network (LAN) cable is connected to the unit.
- Confirm that the access point (wireless LAN router) setting is correct. When SSID of the access point is hidden, set the SSID stealth mode switch for the access point to OFF. For details on the access point setting, refer to the operating instructions of the access point.

The unit cannot be connected via the wireless LAN connection using the WPS.

- You cannot connect to a network using WPS when your access point is set to WEP. Set up your network after searching the access point using the access point scan.

The wireless LAN transfer speed becomes noticeably slow.

- With some IEEE802.11n-compatible wireless LAN routers/access points, the wireless LAN transfer speed is decreased when “WEP” or “WPA/WPA2-PSK (TKIP)” is selected for the security method. Configurations of encryption (security)

vary depending on the model; please refer to the operating instructions supplied with your router/access point.

Browser

The browser screen does not appear.

- Check the setup of the firewall of the security software. Refer to the customer support website (page 42) for details.
- Check the proxy setting of the browser. This unit does not support proxies. Change the browser setting to one connecting this unit without a proxy.

Home Network

The unit cannot be found from a controller. (The controller cannot browse the unit.)

- See “Browser” – “The browser screen does not appear.” (page 44)
- Make sure the LINK indicator lights in green or amber. If the LINK indicator goes dark, flashes, or lights in red, see “Network” – “The unit cannot connect to the network. (The unit cannot be found or recognized by other devices that are on the home network.)” (page 43).
- Make sure the controller is connected to your home network.

Audio content has started automatically.

- The unit may be under the control of another device. If you want to reject these requests, set the NETWORK STANDBY/STANDBY switch to STANDBY.

The sound skips.

- See “Sound output” – “The sound skips.” (page 43).

This unit cannot play back with this error indicated (illumination indicator [white] continues flashing quickly).

- Make sure that the audio content is not corrupted and has not been deleted from the server. Refer to the operating instructions of the server.
- The server is trying to play back an unsupported audio format on this unit. Check the format information, using the server.
- Deactivate the multicast control of your wireless LAN router/access point if it is activated. Refer to the operating manual of your wireless LAN router/access point for details.

This unit cannot play back with this indicated (illumination indicator [white] continues flashing).

- It may take several minutes before sound is output. Wait until the indicator stops flashing.
- The server may not permit access from this unit. Change the settings of the server to permit access from this unit. Refer to the operating instructions of the server.

The pause function does not work.

- This unit does not have a pause function.

AirPlay

The unit cannot be found from an iPhone, iPod touch, or iPad.

- See “Browser” – “The browser screen does not appear.” (page 44).
- Make sure the LINK indicator lights in green or amber. If the LINK indicator goes dark, flashes, or lights in red, see “Network” – “The unit cannot connect to the network. (The unit cannot be found or recognized by other devices that are on the home network.)” (page 43).
- Make sure an iOS device or a PC with iTunes is connected to your home network.

- Update iOS or iTunes to the latest version before using it with this unit (page 32).

Audio content automatically started.

- See “Home Network” – “Audio content has started automatically.” (page 44).

The sound skips.

- See “Sound output” – “The sound skips.” (page 43).

This unit cannot be operated.

- Update the software version of the iPhone, iPod touch, or iPad to the latest version (page 32).
- Make sure another device is not streaming to the AirPlay compatible device at the same time.

PARTY STREAMING

- See “Home Network” (page 44) if the problem does not apply to one of the following cases:

During a PARTY

This unit cannot join a PARTY.

- Make sure the LINK indicator lights in green or amber. If the LINK indicator goes dark, flashes, or lights up in red, see “Network” – “The unit cannot connect to the network. (The unit cannot be found or recognized by other devices that are on the home network.)” (page 43).
- Make sure of the statuses of other PARTY guests. The unit cannot join a PARTY if other PARTY devices have all left the PARTY. Play back via another PARTY device when you join the PARTY as a PARTY guest. If you want to start a PARTY as a PARTY host, press and hold the PARTY button for two seconds or more.
- See “Home Network” – “This unit cannot play back with this error indicated (illumination indicator [white] continues flashing quickly).” (page 44).

The unit takes a few minutes to connect to the PARTY host.

- Check the status of the PARTY STREAMING indicator. The PARTY has already closed if the PARTY STREAMING indicator goes dark. This unit is the PARTY host if the PARTY STREAMING indicator lights in green. Play back the audio content.

The sound skips.

- See “Sound output” – “The sound skips.” (page 43).

The wireless LAN transfer speed becomes noticeably slow.

- See “The wireless LAN transfer speed becomes noticeably slow.” (page 43).

Using this unit as a PARTY host

This unit cannot start a PARTY.

- Make sure the LINK indicator lights in green or amber. If the LINK indicator goes dark, flashes, or lights in red, see “Network” – “The unit cannot connect to the network. (The unit cannot be found or recognized by other devices that are on the home network.)” (page 43)

This unit cannot leave the PARTY.

- You cannot leave the PARTY while using this unit as a PARTY host.

Another device cannot join the PARTY that is being held on this unit.

- The number of PARTY guest exceeds the maximum number when the PARTY STREAMING indicator flashes in green and red alternately. Remove one of the PARTY guests.

Internet music streaming (Music Services)

You cannot connect the system to a service.

- Make sure that the wireless LAN router/access point is turned on.
- Check the LINK indicator to confirm the network status. If the LINK indicator is not lit in green or amber, make the wireless network settings again (page 20).
- If the system is connected through a wireless network, move the unit and the wireless LAN router/access point closer to each other and do the setup again.
- If your contract with your Internet provider limits Internet connection to one device at a time, this device will not be able to access the Internet when another device is already connected. Consult your carrier or service provider.
- Relaunch the Network Audio Remote application after turning your mobile device (Android phone/Sony Tablet/iPhone/iPod touch/iPad) off then back on.

The sound skips.

- The bandwidth of your wireless LAN may be too low. Move the unit and the wireless LAN router/access point closer to each other, without any obstacles between.

Others

This unit does not work correctly.

- This unit is affected by static electricity, etc. Reset this unit if the unit does not work correctly. Disconnect and reconnect the AC cord of the unit.

This unit does not operate if you press the buttons of this unit or those of the remote control.

- Buttons do not work during initializing or startup.

- Buttons do not work while you are updating the software.
- Buttons other than the I/⏻ (ON/Standby) button on the remote control do not work in network standby mode.

The remote control does not work.

- There are inverter fluorescent lights near the unit. Keep this unit away from inverter fluorescent lights.
- Make sure the battery is installed correctly.
- Check the remaining battery level of the remote control.
- Operate the remote control while aiming it at PARTY button (the remote sensor) on the unit.

The I/⏻ (ON/Standby) indicator flashes in red.

- The system is in protection mode. Disconnect the AC cord of the unit then reconnect it after a few seconds. Then turn the unit on. If the symptom recurs, consult your nearest Sony dealer.

The unit and AC adaptor are getting hot.

- This is not a malfunction.

Indicator information

Indicator	White	Blue	NON
Illumination	Lit: – In Playback mode – In selecting audio input Flashing: – During VOL buttons operation – During starting-up Cycle of flashing at 1 sec: In preparation for playback Cycle of flashing twice in 1 sec: In pause mode Cycle of flashing 4 times in 1 sec: An error has occurred	Lit: In stopped Playback mode Flashing: During VOL buttons operation Cycle of flashing at 1 sec: During muting Cycle of flashing twice in 1 sec: During transition to Standby mode	– In Standby mode – During updating
	Flashing in white and blue alternately: During starting-up		

Indicator	Green	Amber	Red	NON
I/⏻ (ON/Standby)	Lit: In operation Flashing: During starting-up	Lit: In network standby mode	Lit: In standby mode Flashing: See “The I/⏻ (ON/Standby) indicator flashes in red.” (page 46)	AC adaptor is not connected
PARTY STREAMING	Lit: Having a PARTY as PARTY host Cycle of flashing at 1 sec: Preparation for having a PARTY as PARTY host Cycle of flashing 4 times in 1 sec: Closes the PARTY	Lit: Joining a PARTY as PARTY guest Cycle of flashing at 1 sec: Preparation for joining a PARTY as PARTY guest Cycle of flashing 4 times in 1 sec: Leaves the PARTY	Cycle of flashing 4 times in 1 sec for 2 sec → goes dark: An error has occurred	No PARTY
LINK	Lit: During wireless connection Cycle of flashing for 2 sec and dark for 1 sec: Begins wireless connection	Lit: During wired connection Cycle of being lit for 2 sec and dark for 1 sec: Begins wired connection	Lit: An error has occurred (with the wireless LAN setting/ not connected) Cycle of flashing 4 times in 1 sec: A wireless LAN WPS error has occurred	A wireless network setting process is not finished
UPDATE	Lit: Updatable Flashing: During updating	–	Cycle of flashing 4 times in 1 sec for 4 sec → goes off: An updating error has occurred	No need for updating
AUDIO IN	Lit: In selecting audio input	–	–	In selecting network input

Trademarks, etc.

- PARTY STREAMING and the PARTY STREAMING logo are trademarks of Sony Corporation.
- Microsoft, Windows, Windows Vista, Windows 7™, Windows Media are trademarks or registered trademarks of Microsoft Corporation in the United States and/or other countries.
- This product is protected by certain intellectual property rights of Microsoft Corporation. Use or distribution of such technology outside of this product is prohibited without a license from Microsoft or an authorized Microsoft subsidiary.
- AirPlay, the AirPlay logo, iPhone, iPod touch, and iTunes are trademarks of Apple Inc., registered in the U.S. and other countries. iPad is a trademark of Apple Inc.
-  The Wi-Fi Logo is a certification mark of the Wi-Fi Alliance.
- Wi-Fi®, Wi-Fi Protected Access® and Wi-Fi Alliance® are registered marks of the Wi-Fi Alliance.
- Wi-Fi CERTIFIED™, WPA™, WPA2™ and Wi-Fi Protected Setup™ are marks of the Wi-Fi Alliance.
- DLNA®, the DLNA Logo and DLNA CERTIFIED™ are trademarks, service marks, or certification marks of the Digital Living Network Alliance.
- Windows Media is either a registered trademark or trademark of Microsoft Corporation in the United States and/or other countries.
This product is protected by certain intellectual property rights of Microsoft Corporation.
Use or distribution of such technology outside of this product is prohibited without a license from Microsoft or an authorized Microsoft subsidiary.
- MPEG Layer-3 audio coding technology and patents licensed from Fraunhofer IIS and Thomson.

WPA Supplicant

Copyright © 2003-2006, Jouni Malinen <jkmaline@cc.hut.fi> and contributors
All Rights Reserved.

Redistribution and use in source and binary forms, with or without modification, are permitted provided that the following conditions are met:

- 1 Redistributions of source code must retain the above copyright notice, this list of conditions and the following disclaimer.
- 2 Redistributions in binary form must reproduce the above copyright notice, this list of conditions and the following disclaimer in the documentation and/or other materials provided with the distribution.
- 3 Neither the name(s) of the above-listed copyright holder(s) nor the names of its contributors may be used to endorse or promote products derived from this software without specific prior written permission.

THIS SOFTWARE IS PROVIDED BY THE COPYRIGHT HOLDERS AND CONTRIBUTORS "AS IS" AND ANY EXPRESS OR IMPLIED WARRANTIES, INCLUDING, BUT NOT LIMITED TO, THE IMPLIED WARRANTIES OF MERCHANTABILITY AND FITNESS FOR A PARTICULAR PURPOSE ARE DISCLAIMED. IN NO EVENT SHALL THE COPYRIGHT OWNER OR CONTRIBUTORS BE LIABLE FOR ANY DIRECT, INDIRECT, INCIDENTAL, SPECIAL, EXEMPLARY, OR CONSEQUENTIAL DAMAGES (INCLUDING, BUT NOT LIMITED TO, PROCUREMENT OF SUBSTITUTE GOODS OR SERVICES; LOSS OF USE, DATA, OR PROFITS; OR BUSINESS INTERRUPTION) HOWEVER CAUSED AND ON ANY THEORY OF LIABILITY, WHETHER IN CONTRACT, STRICT LIABILITY, OR TORT (INCLUDING NEGLIGENCE OR OTHERWISE) ARISING IN ANY WAY OUT OF THE USE OF THIS SOFTWARE, EVEN IF ADVISED OF THE POSSIBILITY OF SUCH DAMAGE.

- The system names and product names indicated in this manual are generally the trademarks or registered trademarks of the manufacturer.
- In this manual, Microsoft Windows XP Home Edition, Microsoft Windows XP Professional and Microsoft Windows XP Media Center Edition are referred to as Windows XP.
- In this manual, Microsoft Windows Vista Home Basic, Microsoft Windows Vista Home Premium, Microsoft Windows Vista Business and Microsoft Windows Vista Ultimate are referred to as Windows Vista.
- In this manual, Microsoft Windows 7 Home Basic, Microsoft Windows 7 Home Premium, Microsoft Windows 7 Professional and Microsoft Windows 7 Ultimate are referred to as Windows 7.
- ™ and ® marks are omitted in this manual.

END-USER LICENSE AGREEMENT FOR SONY SOFTWARE

You should carefully read the following agreement before using the SONY SOFTWARE (defined below). Using the SONY SOFTWARE indicates your acceptance of the agreement. If you do not agree with it, you are not authorized to use the SONY SOFTWARE.

IMPORTANT - READ CAREFULLY: This End-User License Agreement (“EULA”) is a legal agreement between you and Sony Corporation (“SONY”), the manufacturer of your Sony hardware device (the “PRODUCT”) and the licensor of the SONY SOFTWARE. All Sony software and third party software (other than such software subject to its own separate license) included with your PRODUCT and any updates and upgrades thereto shall be referred to herein as the “SONY SOFTWARE”. You may use the SONY SOFTWARE only with the PRODUCT.

By using the SONY SOFTWARE, you agree to be bound by the terms of this EULA. If you do not agree to the terms of this EULA, SONY is unwilling to license the SONY SOFTWARE to you. In such event, you should not use the SONY SOFTWARE.

SONY SOFTWARE LICENSE

The SONY SOFTWARE is protected by copyright laws and international copyright treaties, as well as other intellectual property laws and treaties. The SONY SOFTWARE is licensed, not sold.

GRANT OF LICENSE

All title, copyright and other rights in and to the SONY SOFTWARE are owned by SONY or its licensors. This EULA grants you the right to use the SONY SOFTWARE for personal use only.

DESCRIPTION OF REQUIREMENTS, RESTRICTIONS, RIGHTS AND LIMITATIONS

Limitations. You may not copy, modify, reverse engineer, decompile or disassemble the SONY SOFTWARE in whole or in part.

Separation of Components. The SONY SOFTWARE is licensed as a single product. Its component parts may not be separated.

Use on Single PRODUCT. The SONY SOFTWARE may only be used with a single PRODUCT.

Rental. You may not rent or lease the SONY SOFTWARE.

Software Transfer. You may permanently transfer all of your rights under this EULA only when the SONY SOFTWARE is transferred together with and as part of the PRODUCT, provided that you retain no copies, transfer all of the SONY SOFTWARE (including but not limited to all copies, component parts, media, instruction manuals, other printed materials, electronic documents, recovery disks and this EULA) and the recipient agrees to the terms of this EULA.

Termination. Without prejudice to any other rights, SONY may terminate this EULA if you fail to comply with the terms of this EULA. In such event, when requested by SONY, you must send the PRODUCT to an address designated by SONY, and SONY will send back the PRODUCT to you as soon as practicable after the SONY SOFTWARE has been deleted from the PRODUCT.

Confidentiality. You agree to keep confidential information contained in SONY SOFTWARE which is not publicly known and not to disclose such information to others without SONY’s prior written approval.

HIGH RISK ACTIVITIES

The SONY SOFTWARE is not fault-tolerant and is not designed, manufactured or intended for use or resale as on-line control equipment in hazardous environments requiring fail-safe performance, such as in the operation of nuclear facilities, aircraft navigation or communication systems, air traffic control, direct life support machines or weapons systems, in which the failure of the SONY SOFTWARE could lead to death, personal injury or severe physical or environmental damage (“High Risk Activities”). SONY and its suppliers specifically disclaim any express or implied warranty of fitness for High Risk Activities.

EXCLUSION OF WARRANTY ON SONY SOFTWARE

You expressly acknowledge and agree that use of the SONY SOFTWARE is at your sole risk. The SONY SOFTWARE is provided "AS IS" and without warranty of any kind, and SONY, its vendors and SONY's licensors (for purposes of this SECTION only, collectively, "SONY") EXPRESSLY DISCLAIM ALL WARRANTIES, EXPRESS OR IMPLIED, INCLUDING BUT NOT LIMITED TO THE IMPLIED WARRANTIES OF MERCHANTABILITY AND FITNESS FOR A PARTICULAR PURPOSE. SONY DOES NOT WARRANT THAT THE FUNCTIONS CONTAINED IN THE SONY SOFTWARE ARE FREE FROM ERRORS OR BUGS OR WILL MEET YOUR REQUIREMENT, AND SONY DOES NOT WARRANT THAT THE OPERATION OF THE SONY SOFTWARE WILL BE CORRECTED. FURTHERMORE, SONY DOES NOT WARRANT OR MAKE ANY REPRESENTATIONS REGARDING THE USE OR THE RESULTS OF THE USE OF THE SONY SOFTWARE IN TERMS OF ITS CORRECTNESS, ACCURACY, RELIABILITY OR OTHERWISE. NO ORAL OR WRITTEN INFORMATION OR ADVICE GIVEN BY SONY OR A SONY AUTHORIZED REPRESENTATIVE SHALL CREATE A WARRANTY OR IN ANY WAY INCREASE THE SCOPE OF THIS WARRANTY. SOME JURISDICTIONS DO NOT ALLOW THE EXCLUSION OF IMPLIED WARRANTIES, IN WHICH CASE THE ABOVE EXCLUSION WOULD NOT APPLY TO YOU.

Without limiting any of the foregoing, it is specifically provided that the SONY SOFTWARE is not designed or intended for use on any product other than the PRODUCT. SONY provides no warranty that any product, software, content or data created by you or a third party will not be damaged by the SONY SOFTWARE.

LIMITATION OF LIABILITY

SONY, ITS SUPPLIERS AND SONY'S LICENSOR'S (for purposes of this SECTION ONLY, collectively, "SONY") SHALL NOT BE LIABLE FOR ANY INCIDENTAL OR CONSEQUENTIAL DAMAGES RELATING TO THE SONY SOFTWARE ARISING FROM OR BASED ON BREACH OF ANY EXPRESS OR IMPLIED WARRANTY, BREACH OF CONTRACT, NEGLIGENCE, STRICT LIABILITY OR ANY OTHER LEGAL THEORY. SUCH DAMAGES INCLUDE, BUT ARE NOT LIMITED TO, LOSS OF PROFITS, LOSS OF REVENUE, LOSS OF DATA, LOSS OF USE OF THE PRODUCT OR ANY ASSOCIATED EQUIPMENT, DOWN TIME AND USER'S TIME, REGARDLESS OF WHETHER SONY HAS BEEN ADVISED OF THE POSSIBILITY OF SUCH DAMAGES. IN ANY CASE, SONY'S ENTIRE LIABILITY TO YOU UNDER ANY PROVISION OF THIS EULA SHALL BE LIMITED TO THE AMOUNT ACTUALLY PAID ALLOCABLE TO THE SONY SOFTWARE.

EXPORTS

If you use or transfer the SONY SOFTWARE in or to a country other than your country of residence, you shall comply with applicable laws and regulations relating to exports, imports and customs.

GOVERNING LAW

This EULA shall be construed, governed, interpreted and applied in accordance with the laws of Japan, without regards to any conflict of laws provisions. Any dispute arising out of this EULA shall be subject to the exclusive venue and jurisdiction of the courts in Tokyo, Japan, and you and SONY hereby consent to the venue and jurisdiction of such courts. YOU AND SONY WAIVE THE RIGHT TO TRIAL BY JURY WITH RESPECT TO ANY MATTERS ARISING UNDER OR RELATING TO THIS EULA.

SEVERABILITY

If any part of this EULA is held invalid or unenforceable, other parts will remain valid.

Should you have any questions in connection with this EULA or the limited warranty provided hereunder, you may contact SONY by writing to SONY at the designated contact address mentioned in the warranty card included in the product package.

For customer in the U.S.A

END-USER LICENSE AGREEMENT FOR SONY SOFTWARE (for the application included in the supplied CD-ROM)

YOU SHOULD CAREFULLY READ THE FOLLOWING AGREEMENT BEFORE USING THIS SOFTWARE. USING THIS SOFTWARE INDICATES YOUR ACCEPTANCE OF THE AGREEMENT.

IMPORTANT-READ CAREFULLY: This End-User License Agreement (“LICENSE”) is a legal agreement between you and Sony Electronics Inc. (“SONY”) relating to the (i) software which is furnished on CD-ROM or DVD-ROM media and bundled with the hardware device sold by SONY or its affiliate (“PRODUCT”), and (ii) software which is made available for downloading and use from a website designated by SONY or its affiliate (“SONY SITE”), including software updates/upgrades, in connection with the use of the PRODUCT (such (i) and (ii) are collectively referred to as “SOFTWARE”, which shall include all associated media, printed materials and any online or electronic materials provided in connection therewith). Notwithstanding the foregoing, software having a separate end user license agreement shall be covered by such a separate end user license agreement and shall be expressly excluded from SOFTWARE. By installing, copying, downloading or otherwise using the SOFTWARE, you agree to be bound by the terms of this LICENSE. If you do not agree to the terms of this LICENSE, SONY is unwilling to license the SOFTWARE to you. In such event, you may not use or copy the SOFTWARE, and you should promptly contact SONY for instructions on return of the entire PRODUCT and included SOFTWARE for a refund of the purchase price of the PRODUCT.

SOFTWARE LICENSE

The SOFTWARE is protected by copyright laws and international copyright treaties, as well as other intellectual property laws and treaties. The SOFTWARE is licensed, not sold.

GRANT OF LICENSE

This LICENSE grants you the following non-exclusive rights:

Software. You may install and use one copy of the SOFTWARE on your computer. Unless otherwise specified in the documentation provided with the SOFTWARE or on the SONY SITE, you may install and use such SOFTWARE on only one computer at a time.

Personal Use. You may use the SOFTWARE for personal use only.

Back-up Copy. You may make one back-up copy of the SOFTWARE solely for recovery purposes.

DESCRIPTION OF OTHER RIGHTS AND LIMITATIONS

Limitation on Reverse Engineering, Decompilation and Disassembly. You may not modify, reverse engineer, decompile, or disassemble the SOFTWARE in whole or in part.

Separation of Components. The SOFTWARE is licensed as a single product. Its component parts may not be separated for use on more than one computer unless expressly authorized by Sony.

Storage/Network Use. You may not use the SOFTWARE over a network or distribute the SOFTWARE to other computers over a network except as specifically described in documentation provided with the SOFTWARE.

Non-Circumvention. You may not bypass, modify, defeat or circumvent any of the functions or protections of the SOFTWARE or any mechanisms operatively linked to the SOFTWARE.

Trademarks and Notices. You may not remove, alter, cover or deface any trademarks or notices on the SOFTWARE.

Data Files. The SOFTWARE may create data files automatically for use with the SOFTWARE. Any such data files will be deemed as part of the SOFTWARE.

Rental. You may not rent or lease the SOFTWARE.

SOFTWARE Transfer. You may permanently transfer all of your rights under this LICENSE only if you retain no copies, transfer all of the SOFTWARE (including all copies, component parts, the media and printed materials, all versions and any upgrades of the SOFTWARE and this LICENSE), and the recipient agrees to the terms of this LICENSE.

Dependent Software. The software, network services or other products other than SOFTWARE upon which the SOFTWARE's performance depends might be interrupted or discontinued at the discretion of the suppliers (software suppliers, service providers, or SONY). SONY and its suppliers do not warrant that the software, network services or other products will continue to be available, or will operate without interruption or modification.

Termination. Without prejudice to any other rights, SONY may terminate this LICENSE if you fail to comply with the terms and conditions of this LICENSE. In such event, you must destroy and/or erase all copies of the SOFTWARE and all of its component parts within two (2) weeks from such termination and provide SONY proof of such destruction and/or erasure.

SURVIVAL

In the event that this LICENSE is terminated, the following sections shall survive: Termination, COPYRIGHT, EXCLUSION OF WARRANTY ON SOFTWARE, LIMITATION OF LIABILITY, SOFTWARE DATA COLLECTION AND MONITORING, SEVERABILITY, and JURY WAIVER.

COPYRIGHT

All title and copyright in and to the SOFTWARE (including but not limited to any images, photographs, animation, video, audio, music, text and “applets”, incorporated into the SOFTWARE), and any copies of the SOFTWARE, are owned by SONY, SONY’s affiliates or their suppliers. All rights not specifically granted under this LICENSE are reserved by SONY.

USE OF SOFTWARE WITH COPYRIGHTED MATERIALS

The SOFTWARE may be capable of being used by you to store, process and use content created by you and third parties. Such content may be protected by copyright, other intellectual property laws, and/or agreements. You agree to use the SOFTWARE only in compliance with all such laws and agreements that apply to such content. You agree that SONY may take appropriate measures to protect copyright of content stored, processed or used by the SOFTWARE. Such measures include, but are not limited to, counting the frequency of your backup and restoration through certain SOFTWARE features, refusal to accept your request to enable restoration of data through certain SOFTWARE features and termination of this LICENSE in the event of your use of the SOFTWARE in violation of this LICENSE or applicable laws, rules or regulations.

HIGH RISK ACTIVITIES

The SOFTWARE is not fault-tolerant and is not designed, manufactured or intended for use or resale as on-line control equipment in hazardous environments requiring fail-safe performance, such as in the operation of nuclear facilities, aircraft navigation or communication systems, air traffic control, direct life support machines, or weapons systems, in which the failure of the SOFTWARE could lead to death, personal injury, or severe physical or environmental damage (“High Risk Activities”). SONY, SONY’s affiliates and each of their suppliers specifically disclaim any express or implied warranty of fitness for High Risk Activities.

LIMITED WARRANTY ON CD-ROM/DVD-ROM MEDIA

In situations where the SOFTWARE is furnished on CD-ROM/DVD-ROM media, SONY warrants, for a period of ninety (90) days from the date of its delivery to you, the CD-ROM/DVD-ROM media against defects in materials and workmanship under normal use. This limited warranty extends only to you as the original licensee. SONY’s entire liability and your exclusive remedy will be replacement of the CD-ROM/DVD-ROM media not meeting SONY’s limited warranty and which is returned to SONY with proof of purchase in the form of a bill of sale (which is evidence that the CD-ROM/DVD-ROM media is within the warranty period). SONY will have no responsibility to replace CD-ROM/DVD-ROM media damaged by accident, abuse or misapplication. ANY IMPLIED WARRANTIES ON THE CD-ROM/DVD-ROM MEDIA, INCLUDING THE IMPLIED WARRANTIES OF MERCHANTABILITY AND/OR FITNESS FOR A PARTICULAR PURPOSE, ARE LIMITED IN DURATION TO NINETY (90) DAYS FROM THE DATE OF DELIVERY. SOME JURISDICTIONS DO NOT ALLOW LIMITATIONS ON HOW LONG AN IMPLIED WARRANTY LASTS, SO THESE LIMITATIONS MAY NOT APPLY TO YOU. THIS WARRANTY GIVES YOU SPECIFIC LEGAL RIGHTS, AND YOU MAY ALSO HAVE OTHER RIGHTS WHICH VARY FROM JURISDICTION TO JURISDICTION.

EXCLUSION OF WARRANTY ON SOFTWARE

You expressly acknowledge and agree that use of the SOFTWARE is at your sole risk. The SOFTWARE is provided “AS IS” and without warranty of any kind and SONY, SONY’s affiliates and their licensors (in this section, SONY, its affiliates and their licensors shall be collectively referred to as “SONY”) EXPRESSLY DISCLAIM ALL WARRANTIES, EXPRESS OR IMPLIED, INCLUDING, BUT NOT LIMITED TO, THE IMPLIED WARRANTIES OF NON-INFRINGEMENT, MERCHANTABILITY AND FITNESS FOR A PARTICULAR PURPOSE. SONY DOES NOT WARRANT THAT THE FUNCTIONS CONTAINED IN THE SOFTWARE WILL MEET YOUR REQUIREMENTS, OR THAT THE OPERATION OF THE SOFTWARE WILL BE ERROR FREE. SONY DOES NOT WARRANT OR MAKE ANY REPRESENTATIONS REGARDING THE USE OR THE RESULTS OF THE USE OF THE SOFTWARE IN TERMS OF ITS CORRECTNESS, ACCURACY, RELIABILITY, OR OTHERWISE. NO ORAL OR WRITTEN INFORMATION OR ADVICE GIVEN BY SONY OR A SONY AUTHORIZED REPRESENTATIVE SHALL CREATE A WARRANTY OR IN ANY WAY INCREASE THE SCOPE OF THIS LIMITED WARRANTY. SHOULD THE SOFTWARE PROVE DEFECTIVE YOU (AND NOT SONY OR A SONY AUTHORIZED REPRESENTATIVE) ASSUME THE ENTIRE COST OF ALL NECESSARY SERVICING, REPAIR OR CORRECTION. SOME JURISDICTIONS DO NOT ALLOW THE EXCLUSION OF IMPLIED WARRANTIES, SO THE ABOVE EXCLUSION MAY NOT APPLY TO YOU.

Without limiting the foregoing, you expressly understand that any other computer hardware, software, or data could be damaged by installing or using the SOFTWARE on your computer and that SONY is not responsible for any such damage. You expressly acknowledge and agree that use of the SOFTWARE is at your sole risk and you are responsible for installation of the SOFTWARE and use of the SOFTWARE with your PRODUCT.

LIMITATION OF LIABILITY

SONY, (IN THIS SECTION, SONY, ITS AFFILIATES AND THEIR RESPECTIVE LICENSORS SHALL BE COLLECTIVELY REFERRED TO AS “SONY”) SHALL NOT BE LIABLE FOR ANY INCIDENTAL OR CONSEQUENTIAL DAMAGES FOR BREACH OF ANY EXPRESS OR IMPLIED WARRANTY, BREACH OF CONTRACT, NEGLIGENCE, STRICT LIABILITY OR ANY OTHER LEGAL THEORY RELATED TO THE SOFTWARE OR THE PRODUCT. SUCH DAMAGES INCLUDE, BUT ARE NOT LIMITED TO, LOSS OF PROFITS, LOSS OF REVENUE, LOSS OF DATA, LOSS OF USE OF THE SOFTWARE, PRODUCT OR ANY ASSOCIATED HARDWARE, DOWN TIME AND USER’S TIME, EVEN IF SONY HAS BEEN ADVISED OF THE POSSIBILITY OF SUCH DAMAGES. IN ANY CASE, SONY’S ENTIRE LIABILITY UNDER ANY PROVISION OF THIS LICENSE

SHALL BE LIMITED TO THE AMOUNT ACTUALLY PAID ALLOCABLE TO THE ASSOCIATED PRODUCT. SOME JURISDICTIONS DO NOT ALLOW THE EXCLUSION OR LIMITATION OF CONSEQUENTIAL OR INCIDENTAL DAMAGES, SO THE ABOVE EXCLUSION OR LIMITATION MAY NOT APPLY TO YOU.

SOFTWARE DATA COLLECTION AND MONITORING

The SOFTWARE contains features which may allow SONY and/or third parties to collect data from, control and/or monitor computers and devices running or interacting with the SOFTWARE. You hereby consent to such activities. SONY's current privacy policy is located at <http://products.sel.sony.com/SEL/legal/privacy.html>. Please contact applicable third-parties for privacy policies related to their software and services.

AUTOMATIC UPDATE FEATURE

From time to time, SONY or third parties may automatically update or otherwise modify the SOFTWARE, including, but not limited to, for purposes of enhancement of security functions, error correction and improvement of functions, at such time as you interact with SONY's or third parties' servers, or otherwise. Such updates or modifications may delete or change the nature of features or other aspects of the SOFTWARE, including functions you may rely upon. You hereby agree that such activities may occur at SONY's sole discretion and that SONY may condition continued use of the SOFTWARE upon your complete installation or acceptance of such update or modifications. Any updates/modifications shall be deemed to be, and shall constitute part of, the SOFTWARE for purposes of this LICENSE. By acceptance of this LICENSE, you consent to such updates/modifications.

MODIFICATION OF LICENSE

SONY reserves the right to amend the specific terms of this LICENSE at its sole discretion by notice to you at the email address you provided to SONY as part of your registration, by posting amended terms at the SONY SITE, or any other legally recognizable form of notice. If you do not agree to the amended terms, with notice to you by SONY before they take effect, you must stop using the SOFTWARE. Your continued use of the SOFTWARE after notice shall be deemed to be your agreement to be bound by such amendment.

PROHIBITION ON EXPORT

EXCEPT FOR EXPORT TO CANADA FOR USE IN CANADA BY CITIZENS OF THE UNITED STATES OR CANADA, THE SOFTWARE AND ANY UNDERLYING TECHNOLOGY MAY NOT BE EXPORTED OUTSIDE THE UNITED STATES OR TO ANY FOREIGN ENTITY OR "FOREIGN PERSON" AS DEFINED BY U.S. GOVERNMENT REGULATIONS, INCLUDING, WITHOUT LIMITATION, ANYONE WHO IS NOT A CITIZEN, NATIONAL, OR LAWFUL PERMANENT RESIDENT OF THE UNITED STATES. BY USING THE SOFTWARE, YOU ARE AGREEING TO THE FOREGOING AND YOU ARE WARRANTING THAT YOU ARE NOT A "FOREIGN PERSON" OR UNDER THE CONTROL OF A FOREIGN PERSON.

U.S. GOVERNMENT RESTRICTED RIGHTS

SOFTWARE is provided with RESTRICTED RIGHTS. Use, duplication, or disclosure by the United States Government is subject to restriction as set forth in subparagraph (c) (1) and (2) of the Commercial Computer Software-Restricted Rights at 48 CFR 52.227-19, as applicable. Manufacturer is Sony Electronics Inc., 16530 Via Esprillo, San Diego, CA 92127.

SEVERABILITY

If any part of this LICENSE is held invalid or unenforceable, the other parts will remain valid.

JURY WAIVER

This LICENSE shall be governed by the laws of the United States. THE PARTIES HEREBY WAIVE TRIAL BY JURY WITH RESPECT TO ANY MATTERS ARISING UNDER TO RELATING TO THIS LICENSE.

THIRD PARTY BENEFICIARY

For all purposes of this LICENSE, each of SONY's affiliates and third party licensors of any of the SOFTWARE shall be expressly deemed an intended third party beneficiary of this LICENSE and shall have the right to enforce the terms and conditions of this LICENSE.

Should you have any questions concerning this LICENSE or this limited warranty, you may contact SONY by writing to SONY at Sony Technical Response Center, 12451 Gateway Boulevard, Fort Myers, Florida 33913.

200904-03

For customers in Canada

END-USER LICENSE AGREEMENT FOR SONY SOFTWARE (for the application included in the supplied CD-ROM)

YOU SHOULD CAREFULLY READ THE FOLLOWING AGREEMENT BEFORE USING THIS SOFTWARE. USING THIS SOFTWARE INDICATES YOUR ACCEPTANCE OF THE AGREEMENT.

IMPORTANT-READ CAREFULLY: This End-User License Agreement ("EULA") is a legal agreement between you and Sony Electronics Inc. ("SONY") relating to the (i) software which is furnished on CD-ROM or DVD-ROM media and bundled with the hardware device sold by SONY or its affiliate ("PRODUCT"), and (ii) software which is made available for downloading and use from a website designated by SONY or its affiliate ("SONY SITE"), including software updates/ upgrades, in connection with the use of a PRODUCT (such (i) and (ii) are collectively referred to as "SOFTWARE", which term shall include all associated media, printed materials and any online or electronic materials provided in connection therewith). Notwithstanding the foregoing, software having a separate end user license agreement shall be covered by such a separate end user license agreement and shall be expressly excluded from SOFTWARE. By installing, copying, downloading or otherwise using the SOFTWARE, you agree to be bound by the terms of this EULA. If you do not agree to the terms of this EULA, SONY is unwilling to license the SOFTWARE to you. In such event, you may not use or copy the SOFTWARE, and you should promptly contact SONY for further instructions.

SOFTWARE LICENSE

The SOFTWARE is protected by copyright laws and international copyright treaties, as well as other intellectual property laws and treaties. The SOFTWARE is licensed, not sold.

GRANT OF LICENSE

This EULA grants you the following non-exclusive rights:

Software. You may install and use one copy of the SOFTWARE on your computer. Unless otherwise specified in the documentation provided with the SOFTWARE or on the SONY SITE, you may install and use such SOFTWARE on only one computer at a time.

Personal Use. You may use the SOFTWARE for personal use only.

Back-up Copy. You may make one back-up copy of the SOFTWARE solely for recovery purposes.

DESCRIPTION OF REQUIREMENTS, RESTRICTIONS, RIGHTS AND LIMITATIONS

Limitation on Reverse Engineering, Decompilation and Disassembly. You may not modify, reverse engineer, decompile, or disassemble the SOFTWARE in whole or in part.

Storage/Network Use. You may not use the SOFTWARE over a network or distribute the SOFTWARE to other computers over a network except as specifically described in documentation provided with the SOFTWARE.

Non-Circumvention. You may not bypass, modify, defeat or circumvent any of the functions or protections of the SOFTWARE or any mechanisms operatively linked to the SOFTWARE.

Separation of Components. The SOFTWARE is licensed as a single product. Its component parts may not be separated for use on more than one computer unless expressly authorized by Sony.

Data Files. The SOFTWARE may create data files automatically for use with the SOFTWARE. Any such data files will be deemed as part of the SOFTWARE.

Trademarks and Notices. You may not remove, alter, cover or deface any trademarks or notices on the SOFTWARE.

Rental. You may not rent or lease the SOFTWARE.

SOFTWARE Transfer. You may permanently transfer all of your rights under this EULA provided you retain no copies, transfer all of the SOFTWARE (including all copies, component parts, the media and printed materials, all versions and any upgrades of the SOFTWARE and this EULA), and the recipient agrees to the terms of this EULA.

Termination. Without prejudice to any other rights, SONY may terminate this EULA if you fail to comply with the terms and conditions of this EULA. In such event, you must destroy all copies of the SOFTWARE and all of its component parts within two (2) weeks from the termination and provide SONY proof of such destruction and/or erasure.

Dependent Software. The software, network services or other products other than SOFTWARE upon which the SOFTWARE's performance depends might be interrupted or discontinued at the discretion of the suppliers (software suppliers, service providers, or SONY). SONY and its suppliers do not warrant that those software, network services or other products will continue to be available, or will operate without interruption or modification.

SURVIVAL

In the event that this EULA is terminated, the following sections will survive: Termination, COPYRIGHT, EXCLUSION OF WARRANTY ON SOFTWARE, LIMITATION OF LIABILITY, SOFTWARE DATA COLLECTION AND MONITORING, SEVERABILITY, and GOVERNING LAW AND JURISDICTION.

COPYRIGHT

All title and copyright in and to the SOFTWARE (including but not limited to any images, photographs, animation, video, audio, music, text and "applets", incorporated into the SOFTWARE), and any copies of the SOFTWARE, are owned by

SONY, SONY's affiliates or their respective suppliers. All rights not specifically granted under this EULA are reserved by SONY.

USE OF SOFTWARE WITH COPYRIGHTED MATERIALS

The SOFTWARE may be capable of being used by you to store, process and use content created by you and third parties. Such content may be protected by copyright, other intellectual property laws, and/or agreements. You agree to use the SOFTWARE only in compliance with all such laws and agreements that apply to such content. You agree that SONY may take appropriate measures to protect copyright of content stored, processed or used by the SOFTWARE. Such measures include, but are not limited to, counting the frequency of your backup and restoration through certain SOFTWARE features, refusal to accept your request to enable restoration of data through certain SOFTWARE features and termination of this EULA in the event of your use of the SOFTWARE in violation of this EULA or applicable laws.

HIGH RISK ACTIVITIES

The SOFTWARE is not fault-tolerant and is not designed, manufactured or intended for use or resale as on-line control equipment in hazardous environments requiring fail-safe performance, such as in the operation of nuclear facilities, aircraft navigation or communication systems, air traffic control, direct life support machines, or weapons systems, in which the failure of the SOFTWARE could lead to death, personal injury, or severe physical or environmental damage ("High Risk Activities"). SONY, each of SONY's affiliates and their respective suppliers specifically disclaim any express or implied warranty of fitness for High Risk Activities.

LIMITED WARRANTY ON CD-ROM/DVD-ROM MEDIA

In situations where the SOFTWARE is furnished on CD-ROM/DVD-ROM media, SONY warrants that for a period of ninety (90) days from the date of its delivery to you the CD-ROM/DVD-ROM media on which the SOFTWARE is furnished to you will be free from defects in materials and workmanship under normal use. This limited warranty extends only to you as the original licensee. SONY's entire liability and your exclusive remedy will be replacement of the CD-ROM/DVD-ROM media not meeting SONY's limited warranty and which is returned to SONY with proof of purchase in the form of a bill of sale evidencing that the CD-ROM/DVD-ROM media is within the warranty period. SONY will have no responsibility to replace the CD-ROM/DVD-ROM media damaged by accident, abuse or misapplication. ANY IMPLIED WARRANTIES OR CONDITIONS ON THE CD-ROM/DVD-ROM MEDIA, INCLUDING THE IMPLIED WARRANTIES OR CONDITIONS OF MERCHANTABILITY AND/OR FITNESS FOR A PARTICULAR PURPOSE, ARE LIMITED IN DURATION TO NINETY (90) DAYS FROM THE DATE OF DELIVERY. SOME JURISDICTIONS DO NOT ALLOW LIMITATIONS ON HOW LONG AN IMPLIED WARRANTY OR CONDITION LASTS, SO THESE LIMITATIONS MAY NOT APPLY TO YOU. THIS WARRANTY GIVES YOU SPECIFIC LEGAL RIGHTS, AND YOU MAY ALSO HAVE OTHER RIGHTS WHICH VARY FROM JURISDICTION TO JURISDICTION.

EXCLUSION OF WARRANTY ON SOFTWARE

You expressly acknowledge and agree that use of the SOFTWARE is at your sole risk. The SOFTWARE is provided "AS IS" and without warranty or condition of any kind and SONY, SONY's affiliates and their respective licensors (in this Section, SONY, its affiliates and their respective licensors shall be collectively referred to as "SONY") EXPRESSLY DISCLAIM ALL WARRANTIES OR CONDITIONS, EXPRESS OR IMPLIED, INCLUDING, BUT NOT LIMITED TO, THE IMPLIED WARRANTIES OR CONDITIONS OF NON-INFRINGEMENT, MERCHANTABILITY AND/OR FITNESS FOR A PARTICULAR PURPOSE. SONY DOES NOT WARRANT OR MAKE ANY REPRESENTATION THAT THE FUNCTIONS CONTAINED IN THE SOFTWARE WILL MEET YOUR REQUIREMENTS, OR THAT THE OPERATION OF THE SOFTWARE WILL BE CORRECTED. FURTHERMORE, SONY DOES NOT WARRANT OR MAKE ANY REPRESENTATIONS REGARDING THE USE OR THE RESULTS OF THE USE OF THE SOFTWARE IN TERMS OF ITS CORRECTNESS, ACCURACY, RELIABILITY, OR OTHERWISE. NO ORAL OR WRITTEN INFORMATION OR ADVICE GIVEN BY SONY OR A SONY AUTHORIZED REPRESENTATIVE SHALL CREATE A WARRANTY OR CONDITION OR IN ANY WAY INCREASE THE SCOPE OF THIS LIMITED WARRANTY. SHOULD THE SOFTWARE PROVE DEFECTIVE YOU (AND NOT SONY OR A SONY AUTHORIZED REPRESENTATIVE) ASSUME THE ENTIRE COST OF ALL NECESSARY SERVICING, REPAIR OR CORRECTION. SOME JURISDICTIONS DO NOT ALLOW THE EXCLUSION OF IMPLIED WARRANTIES OR CONDITIONS, SO THE ABOVE EXCLUSION MAY NOT APPLY TO YOU.

Without limiting the foregoing, SONY does not warrant that any computer hardware and software will not be damaged by the SOFTWARE or any data you download using the SOFTWARE. You expressly acknowledge and agree that use of the SOFTWARE is at your sole risk and you are responsible for installation of the SOFTWARE and use of the SOFTWARE with your PRODUCT.

LIMITATION OF LIABILITY

SONY (IN THIS SECTION, SONY, ITS AFFILIATES AND THEIR RESPECTIVE LICENSORS SHALL BE COLLECTIVELY REFERRED TO AS "SONY") SHALL NOT BE LIABLE FOR ANY INCIDENTAL OR CONSEQUENTIAL DAMAGES FOR BREACH OF ANY EXPRESS OR IMPLIED WARRANTY OR CONDITION, BREACH OF CONTRACT, NEGLIGENCE, STRICT LIABILITY OR ANY OTHER LEGAL THEORY RELATED TO THE SOFTWARE OR THE PRODUCT. SUCH DAMAGES INCLUDE, BUT ARE NOT LIMITED TO, LOSS OF PROFITS, LOSS OF REVENUE, LOSS OF DATA, LOSS OF USE OF THE SOFTWARE, PRODUCT OR ANY ASSOCIATED HARDWARE, DOWN TIME AND USER'S TIME, EVEN IF SONY HAS BEEN ADVISED OF THE

POSSIBILITY OF SUCH DAMAGES. IN ANY CASE, SONY'S ENTIRE LIABILITY UNDER ANY PROVISION OF THIS EULA SHALL BE LIMITED TO THE AMOUNT ACTUALLY PAID ALLOCABLE TO THE PRODUCT. SOME JURISDICTIONS DO NOT ALLOW THE EXCLUSION OR LIMITATION OF CONSEQUENTIAL OR INCIDENTAL DAMAGES, SO THE ABOVE EXCLUSION OR LIMITATION MAY NOT APPLY TO YOU.

SOFTWARE DATA COLLECTION AND MONITORING

The SOFTWARE contains features which may allow SONY and/or third parties to collect data from, control and/or monitor computers and devices running or interacting with the SOFTWARE. You hereby consent to such activities. SONY's current privacy policy is located at <http://products.sel.sony.com/SEL/legal/privacy.html>. Please contact applicable third-parties for privacy policies related to their software and services.

AUTOMATIC UPDATE FEATURE

From time to time, SONY or third parties may automatically update or otherwise modify the SOFTWARE, including, but not limited to, for purposes of enhancement of security functions, error correction and improvement of functions, at such time as you interact with SONY's or third parties' servers, or otherwise. Such updates or modifications may delete or change the nature of features or other aspects of the SOFTWARE, including functions you may rely upon. You hereby agree that such activities may occur at SONY's sole discretion and that SONY may condition continued use of the SOFTWARE upon your complete installation or acceptance of such update or modifications. Any updates/modifications shall be deemed to be, and shall constitute part of, the SOFTWARE for purposes of this EULA. By acceptance of this EULA, you consent to such updates/modifications.

MODIFICATION OF LICENSE

SONY reserves the right to amend the specific terms of this EULA at its sole discretion by notice to you at the email address you provided to SONY as part of your registration, by posting amended terms at the SONY SITE, or any other legally recognizable form of notice. If you do not agree to the amended terms, with notice to you by SONY before they take effect, you must stop using the SOFTWARE. Your continued use of the SOFTWARE after notice shall be deemed to be your agreement to be bound by such amendment.

EXPORT

EXCEPT FOR EXPORT TO CANADA OR FOR USE IN CANADA BY CITIZENS OF THE UNITED STATES OR CANADA, THE SOFTWARE AND ANY UNDERLYING TECHNOLOGY MAY NOT BE EXPORTED OUTSIDE THE UNITED STATES OR TO ANY FOREIGN ENTITY OR "FOREIGN PERSON" AS DEFINED BY U.S. GOVERNMENT REGULATIONS, INCLUDING WITHOUT LIMITATION, ANYONE WHO IS NOT A CITIZEN, NATIONAL, OR LAWFUL PERMANENT RESIDENT OF THE UNITED STATES. BY USING THE SOFTWARE, YOU ARE AGREEING TO THE FOREGOING AND YOU ARE WARRANTING THAT YOU ARE NOT A "FOREIGN PERSON" OR UNDER THE CONTROL OF A FOREIGN PERSON.

You shall comply with all applicable export, import and customs laws and regulations if you use the SOFTWARE outside the country in which you reside.

U.S. GOVERNMENT RESTRICTED RIGHTS

SOFTWARE is provided with RESTRICTED RIGHTS. Use, duplication, or disclosure by the United States Government is subject to restriction as set forth in subparagraph (c)(1) and (2) of the Commercial Computer Software-Restricted Rights at 48 C.F.R. 52.2227-19, as applicable. Manufacturer is Sony Electronics Inc., 16530 Via Esprillo, San Diego, CA 92127.

SEVERABILITY

If any part of this EULA is held invalid or unenforceable, the other parts will remain valid.

GOVERNING LAW AND JURISDICTION

This LICENSE shall be governed by the laws of the state or province in which you reside, without regard to conflict of laws provisions. THE PARTIES HEREBY WAIVE TRIAL BY JURY WITH RESPECT TO ANY MATTERS ARISING UNDER TO RELATING TO THIS LICENSE.

THIRD PARTY BENEFICIARY

For all purposes of this EULA, each of SONY's affiliates and third party licensors of any of the SOFTWARE shall be expressly deemed an intended third party beneficiary of this EULA and shall have the right to enforce the terms and conditions of this EULA.

Should you have any questions concerning this EULA or this limited warranty, you may contact SONY by writing to SONY at Sony Technical Response Center, 12451 Gateway Boulevard, Fort Myers, Florida 33913.

For customers in countries/regions other than the U.S.A. and Canada

END-USER LICENSE AGREEMENT FOR SONY SOFTWARE

(for the application included in the supplied CD-ROM)

YOU SHOULD CAREFULLY READ THE FOLLOWING AGREEMENT BEFORE USING THIS SOFTWARE. USING THIS SOFTWARE INDICATES YOUR ACCEPTANCE OF THE AGREEMENT.

IMPORTANT-READ CAREFULLY: This End-User License Agreement ("EULA") is a legal agreement between you and Sony Corporation ("SONY") relating to the (i) software which is furnished on CD-ROM/DVD-ROM and bundled with the hardware device that is sold by SONY or its affiliates and (ii) software which is made available for downloading and use from the website designated by SONY or its affiliates ((i) and (ii) are collectively referred to as, "SOFTWARE"). Notwithstanding the foregoing, software having a separate end user license agreement shall be covered by such a separate end user license agreement and shall be expressly excluded from SOFTWARE. By installing, copying, downloading or otherwise using the SOFTWARE, you agree to be bound by the terms of this EULA. If you do not agree to the terms of this EULA, SONY is unwilling to license the SOFTWARE to you. In such event, you may not use or copy the SOFTWARE, and you should promptly contact SONY for instructions.

SOFTWARE LICENSE

The SOFTWARE is protected by copyright laws and international copyright treaties, as well as other intellectual property laws and treaties. The SOFTWARE is licensed, not sold.

GRANT OF LICENSE

This EULA grants you the following non-exclusive rights:

Software. You may install and use one copy of the SOFTWARE on the computer. Unless otherwise specified in the documentation provided with the SOFTWARE or on SONY- designated web site, you may install and use such SOFTWARE on one unit of computer at a time.

Personal Use. You may use the SOFTWARE for personal use only.

Back-up Copy. You may make one back-up copy of the SOFTWARE solely for recovery purposes.

DESCRIPTION OF REQUIREMENTS, RESTRICTIONS, RIGHTS AND LIMITATIONS

Limitation on Reverse Engineering, Decompilation and Disassembly. You may not modify, reverse engineer, decompile, or disassemble the SOFTWARE in whole or in part.

Separation of Components. The SOFTWARE is licensed as a single product. Its component parts may not be separated for use on more than one computer unless expressly authorized by Sony.

Data Files. The SOFTWARE may create data files automatically for use with the SOFTWARE. Any such data files will be deemed as part of the SOFTWARE.

Storage/Network Use. You may not use the SOFTWARE over a network or distribute the SOFTWARE to other computers over a network except as specifically described in documentation provided with the SOFTWARE.

Rental. You may not rent or lease the SOFTWARE.

SOFTWARE Transfer. You may permanently transfer all of your rights under this EULA, provided you retain no copies, transfer all of the SOFTWARE (including all copies, component parts, the media and printed materials, all versions and any upgrades of the SOFTWARE and this EULA), and the recipient agrees to the terms of this EULA.

Termination. Without prejudice to any other rights, SONY may terminate this EULA if you fail to comply with the terms and conditions of this EULA. In such event, you must destroy and/or erase all copies of the SOFTWARE and all of its component parts within two weeks and provide SONY with proof of such destruction and/or erasure. The provisions of the following captions shall survive any termination of this EULA;

Termination,

COPYRIGHTS

EXCLUSION OF WARRANTY ON SOFTWARE,

LIMITATION OF LIABILITY,

SOFTWARE DATA COLLECTION AND MONITORING,

SEVERABILITY, and

GOVERNING LAW AND JURISDICTION

Dependent Software. The software, network services or other products other than SOFTWARE upon which the SOFTWARE's performance depends might be interrupted or discontinued at the discretion of the suppliers (software suppliers, service providers, or SONY). SONY and its suppliers do not warrant that those software, network services or other products will continue to be available, or will operate without interruption or modification.

COPYRIGHT

All title and copyright in and to the SOFTWARE (including but not limited to any images, photographs, animation, video, audio, music, text and "applets", incorporated into the SOFTWARE), and any copies of the SOFTWARE, are owned by SONY or its suppliers. All rights not specifically granted under this EULA are reserved by SONY.

USE OF SOFTWARE WITH COPYRIGHTED MATERIALS

The SOFTWARE may be capable of being used by you to store, process and use content created by you and third parties. Such content may be protected by copyright, other intellectual property laws, and/or agreements. You agree to use the SOFTWARE only in compliance with all such laws and agreements that apply to such content. You agree that SONY may take appropriate measures to protect copyright of content stored, processed or used by the SOFTWARE. Such measures include, but are not limited to, counting the frequency of your backup and restoration through certain SOFTWARE features, refusal to accept your request to enable restoration of data through certain SOFTWARE features and termination of this EULA in the event of your illegitimate use of the SOFTWARE.

HIGH RISK ACTIVITIES

The SOFTWARE is not fault-tolerant and is not designed, manufactured or intended for use or resale as on-line control equipment in hazardous environments requiring fail-safe performance, such as in the operation of nuclear facilities, aircraft navigation or communication systems, air traffic control, direct life support machines, or weapons systems, in which the failure of the SOFTWARE could lead to death, personal injury, or severe physical or environmental damage ("High Risk Activities"). SONY and its suppliers specifically disclaim any express or implied warranty of fitness for High Risk Activities.

LIMITED WARRANTY ON CD-ROM/DVD-ROM MEDIA

In situations where the SOFTWARE is furnished on CD-ROM or DVD-ROM media, SONY warrants that for a period of ninety (90) days from the date of its delivery to you the CD-ROM or DVD-ROM media on which the SOFTWARE is furnished to you will be free from defects in materials and workmanship under normal use. This limited warranty extends only to you as the original licensee. SONY's entire liability and your exclusive remedy will be replacement of the CD-ROM or DVD-ROM media not meeting SONY's limited warranty and which is returned to SONY with proof of purchase in the form of a bill of sale (which is evidence that the CD-ROM or DVD-ROM media is within the warranty period). SONY will have no responsibility to replace a disk damaged by accident, abuse or misapplication. ANY IMPLIED WARRANTIES ON THE CD-ROM OR DVD-ROM MEDIA, INCLUDING THE IMPLIED WARRANTIES OF MERCHANTABILITY AND FITNESS FOR A PARTICULAR PURPOSE, ARE LIMITED IN DURATION TO NINETY (90) DAYS FROM THE DATE OF DELIVERY. SOME JURISDICTIONS DO NOT ALLOW LIMITATIONS ON HOW LONG AN IMPLIED WARRANTY LASTS, SO THESE LIMITATIONS MAY NOT APPLY TO YOU. THIS WARRANTY GIVES YOU SPECIFIC LEGAL RIGHTS, AND YOU MAY ALSO HAVE OTHER RIGHTS WHICH VARY FROM JURISDICTION TO JURISDICTION.

EXCLUSION OF WARRANTY ON SOFTWARE

You expressly acknowledge and agree that use of the SOFTWARE is at your sole risk. The SOFTWARE is provided "AS IS" and without warranty of any kind and SONY and SONY's licensors (hereinafter, SONY and SONY's licensor's shall be collectively referred to as "SONY") EXPRESSLY DISCLAIMS ALL WARRANTIES, EXPRESS OR IMPLIED, INCLUDING, BUT NOT LIMITED TO, THE IMPLIED WARRANTIES OF MERCHANTABILITY AND FITNESS FOR A PARTICULAR PURPOSE. SONY DOES NOT WARRANT THAT THE FUNCTIONS CONTAINED IN THE SOFTWARE WILL MEET YOUR REQUIREMENTS, OR THAT THE OPERATION OF THE SOFTWARE WILL BE CORRECTED. FURTHERMORE, SONY DOES NOT WARRANT OR MAKE ANY REPRESENTATIONS REGARDING THE USE OR THE RESULTS OF THE USE OF THE SOFTWARE IN TERMS OF ITS CORRECTNESS, ACCURACY, RELIABILITY, OR OTHERWISE. NO ORAL OR WRITTEN INFORMATION OR ADVICE GIVEN BY SONY OR A SONY AUTHORIZED REPRESENTATIVE SHALL CREATE A WARRANTY OR IN ANY WAY INCREASE THE SCOPE OF THIS WARRANTY. SHOULD THE SOFTWARE PROVE DEFECTIVE YOU (AND NOT SONY OR A SONY AUTHORIZED REPRESENTATIVE) ASSUME THE ENTIRE COST OF ALL NECESSARY SERVICING, REPAIR OR CORRECTION. SOME JURISDICTIONS DO NOT ALLOW THE EXCLUSION OF IMPLIED WARRANTIES, SO THE ABOVE EXCLUSION MAY NOT APPLY TO YOU.

SONY provides no warranty that any computer hardware and software will not be damaged by the SOFTWARE or any data you download using the SOFTWARE. You expressly acknowledge and agree that use of the SOFTWARE is at your sole risk and you are responsible for installation of the SOFTWARE and use of the SOFTWARE.

LIMITATION OF LIABILITY

HEREINAFTER, SONY, ITS AFFILIATES AND THEIR RESPECTIVE LICENSOR'S SHALL BE COLLECTIVELY REFERRED TO AS "SONY". SONY SHALL NOT BE LIABLE FOR ANY INCIDENTAL OR CONSEQUENTIAL DAMAGES FOR BREACH OF ANY EXPRESS OR IMPLIED WARRANTY, BREACH OF CONTRACT, NEGLIGENCE, STRICT LIABILITY OR ANY OTHER LEGAL THEORY RELATED TO THIS SOFTWARE. SUCH DAMAGES INCLUDE, BUT ARE NOT LIMITED TO, LOSS OF PROFITS, LOSS OF REVENUE, LOSS OF DATA, LOSS OF USE OF THE SOFTWARE OR ANY ASSOCIATED HARDWARE, DOWN TIME AND USER'S TIME, EVEN IF SONY HAS BEEN ADVISED OF THE POSSIBILITY OF SUCH DAMAGES. IN ANY CASE, SONY'S ENTIRE LIABILITY UNDER ANY PROVISION OF THIS EULA SHALL BE LIMITED TO THE AMOUNT ACTUALLY PAID ALLOCABLE TO THE ASSOCIATED SOFTWARE. SOME JURISDICTIONS DO NOT ALLOW THE EXCLUSION OR LIMITATION OF CONSEQUENTIAL OR INCIDENTAL DAMAGES, SO THE ABOVE EXCLUSION OR LIMITATION MAY NOT APPLY TO YOU.

SOFTWARE DATA COLLECTION AND MONITORING

The SOFTWARE contains features which may allow SONY and/or third parties to collect data from, control and/or monitor computers and devices running or interacting with the SOFTWARE. You hereby agree that such activities may occur. Please contact applicable contact address of each country for SONY's current privacy policy.

AUTOMATIC UPDATE FEATURE

From time to time, SONY or third parties may automatically update or otherwise modify the SOFTWARE, for example, but not limited to, for purposes of enhancement of security functions, error correction and improvement of functions, at such time as you interact with SONY's or third parties' servers, or otherwise. Such updates or modifications may delete or change the nature of features or other aspects of the SOFTWARE, including functions you may rely upon. You hereby agree that such activities may occur at SONY's sole discretion and that SONY may condition continued use of the SOFTWARE upon your complete installation or acceptance of such update or modifications. Any updates/modifications shall be deemed and shall constitute part of the SOFTWARE for purposes of this EULA. By acceptance of this EULA, you consent to such update/modification.

EXPORT

You shall comply with all applicable export, import and customs laws and regulations if you use the SOFTWARE outside the country in which you reside.

SEVERABILITY

If any part of this EULA is held invalid or unenforceable, the other parts will remain valid.

GOVERNING LAW AND JURISDICTION

This EULA shall be governed by the laws of Japan, without regards to conflict of laws provisions. The parties hereby consent to submit to the non-exclusive jurisdiction of the courts of Japan.

MODIFICATION

SONY RESERVES THE RIGHT TO AMEND THE SPECIFIC TERMS OF THE LICENSE REGARDING THE SOFTWARE AT ITS SOLE DISCRETION BY NOTICE TO YOU AT THE E-MAIL ADDRESS YOU HAVE PROVIDED TO SONY AS PART OF YOUR REGISTRATION, BY POSTING AMENDING TERMS AT SONY'S SITE, OR ANY OTHER LEGALLY RECOGNIZABLE FORM OF NOTICE. If you do not agree to the terms to be amended, which shall be notified to you by SONY before they take effect, you must stop using the SOFTWARE. Your continued use of the SOFTWARE after notice shall be deemed agreement to be bound by such amendment.

THIRD PARTY BENEFICIARY

For all purposes of this EULA, each of SONY's third party licensors of any of the SOFTWARE shall be expressly deemed an intended third party beneficiary of this EULA and shall have the right to enforce the terms and conditions of this EULA.

Should you have any questions concerning this EULA or this limited warranty, you may contact SONY by writing to SONY at applicable contact address of each country.

200904-02

<http://www.sony.net/sans>



* 4 4 2 5 6 7 2 1 1 * (1)