

SONY®

User Guide

Personal Computer
VPCW series



Contents

Before Use.....	4	Using Peripheral Devices.....	54
Finding More about Your VAIO Computer	5	Connecting an Optical Disc Drive	55
Ergonomic Considerations	7	Connecting External Speakers or Headphones	57
Getting Started.....	9	Connecting an External Display	58
Locating Controls and Ports.....	10	Selecting Display Modes	61
About the Indicator Lights	16	Using the Multiple Monitors Function	63
Connecting a Power Source	17	Connecting an External Microphone	66
Using the Battery Pack.....	18	Connecting a USB Device	67
Shutting Down Your Computer Safely	24	Customizing Your VAIO Computer.....	69
Updating Your Computer	25	Setting the Password.....	70
Using Your VAIO Computer.....	26	Using the VAIO Control Center	73
Using the Keyboard.....	27	Using the Power Saving Modes	74
Using the Touch Pad.....	28	Using the VAIO Power Management.....	79
Using the Built-in Camera	29		
Using the Memory Stick	30		
Using Other Modules / Memory Cards.....	35		
Using the Internet.....	39		
Using the Network (LAN)	40		
Using the Wireless LAN	41		
Using the Bluetooth Function	48		

Precautions.....	81	Troubleshooting	93
Handling the LCD Screen	82	Computer.....	94
Using the Power Source	83	System Security.....	100
Handling Your Computer.....	84	Battery	102
Handling the Built-in Camera	87	Built-in Camera.....	104
Handling Discs	88	Networking.....	106
Using the Battery Pack.....	89	Bluetooth Technology.....	109
Using Headphones.....	90	Display.....	112
Handling the Memory Stick	91	Printing	115
Handling the Built-in Storage Device	92	Microphone.....	116
		Speakers	117
		Touch Pad	118
		Keyboard	119
		Floppy Disks	120
		Audio/Video	121
		Memory Stick.....	122
		Peripherals	123
		Trademarks	124
		Notice	126

Before Use

Congratulations on your purchase of this Sony VAIO® computer, and welcome to the on-screen User Guide. Sony has combined leading-edge technology in audio, video, computing, and communications to provide state-of-the-art personal computing experience.

! External views illustrated in this manual may look slightly different from those of your computer.

How to find specifications

Some features, options, and supplied items may not be available on your computer.

To find out about the configuration of your computer, visit the VAIO Link web site at <http://www.vaio-link.com>.

Finding More about Your VAIO Computer

This section provides support information about your VAIO computer.

1. Printed Documentation

- ❑ **Quick Start Guide** — An overview of components connection, set-up information, etc.
- ❑ **Troubleshooting and Recovery Guide**
- ❑ **Regulations, Guarantee, EULA and Service Support**

2. On-screen Documentation

- ❑ **User Guide** (This manual) — Features of your computer and information about solving common problems.

To view this on-screen guide:

- 1 Double-click the **VAIO User Guide** icon on the desktop.
- 2 Open the folder for your language.
- 3 Select the guide you want to read.



You can manually browse to the user guides by going to **My Computer > VAIO (C:) (your C drive) > Documentation > Documentation** and opening the folder for your language.

- ❑ **Help and Support Center** — A comprehensive resource for practical advice, tutorials, and demonstrations to help you learn to use your computer.

To access **Help and Support Center**, click **Start** and **Help and Support**, or press and hold the Microsoft Windows key



and press the **F1** key.

3. Support Web Sites

If you have any problem with the computer, you can visit the VAIO-Link web site at <http://www.vaio-link.com> for troubleshooting.

Before contacting VAIO-Link by telephone, try to solve the problem by reading the supplied documentation and visiting other Sony web sites.

- ❑ For more about VAIO and becoming part of the growing VAIO community, visit the web site at <http://www.club-vaio.com>.
- ❑ For online purchases, visit the web site at <http://www.sonymstyle-europe.com>.
- ❑ For other Sony products, visit the web site at <http://www.sony.net>.

When you contact VAIO-Link by telephone, have the serial number of your VAIO computer ready at hand. The serial number is located on the bottom, the back panel, or inside the battery compartment of your VAIO computer.

Ergonomic Considerations

You will be using your computer as a portable device in a variety of environments. Whenever possible, you should attempt to take account of the following ergonomic considerations for both stationary and portable environments:

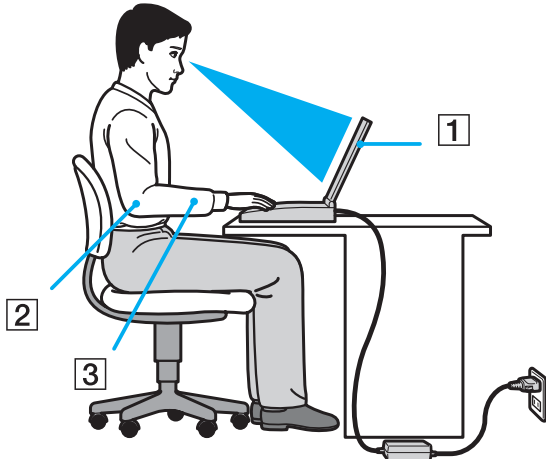

- ❑ **Position of your computer** – Place the computer directly in front of you (1). Keep your forearms horizontal (2), with your wrists in a neutral, comfortable position (3) while using the keyboard or the pointing device. Let your upper arms hang naturally at your sides. Take frequent breaks while using your computer. Excessive use of the computer may strain eyes, muscles, or tendons.
- ❑ **Furniture and posture** – Sit in a chair with good back support. Adjust the level of the chair so your feet are flat on the floor. A footrest may make you more comfortable. Sit in a relaxed, upright posture and avoid slouching forward or leaning far backwards.

- ❑ **Viewing angle of the computer's display** – Use the display's tilting feature to find the best position. You can reduce eye strain and muscle fatigue by adjusting the tilt of the display to the proper position. Adjust the brightness level of the display as well.
- ❑ **Lighting** – Choose a location where windows and lights do not cause glare and reflection on the display. Use indirect lighting to avoid bright spots on the display. Proper lighting adds to your comfort and work efficiency.
- ❑ **Positioning an external display** – When using an external display, set the display at a comfortable viewing distance. Make sure the display screen is at eye level or slightly lower when you are sitting in front of the monitor.

Getting Started

This section describes how to get started using your VAIO computer.

- ❑ **Locating Controls and Ports** ([page 10](#))
- ❑ **About the Indicator Lights** ([page 16](#))
- ❑ **Connecting a Power Source** ([page 17](#))
- ❑ **Using the Battery Pack** ([page 18](#))
- ❑ **Shutting Down Your Computer Safely** ([page 24](#))
- ❑ **Updating Your Computer** ([page 25](#))

Locating Controls and Ports

Take a moment to identify the controls and ports shown on the following pages.

Front

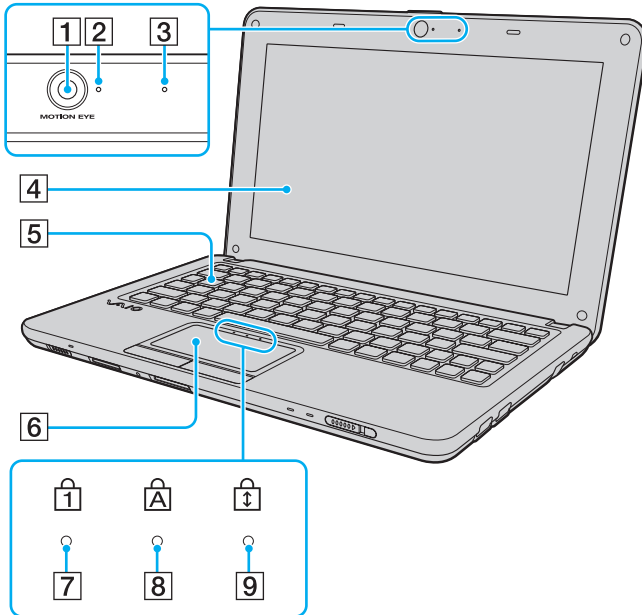

- 1 Built-in **MOTION EYE** camera ([page 29](#))
- 2 Built-in **MOTION EYE** camera indicator ([page 16](#))
- 3 Built-in microphone (monaural)
- 4 LCD screen ([page 82](#))
- 5 Keyboard ([page 27](#))
- 6 Touch pad ([page 28](#))
- 7 Num lock indicator ([page 16](#))
- 8 Caps lock indicator ([page 16](#))
- 9 Scroll lock indicator ([page 16](#))

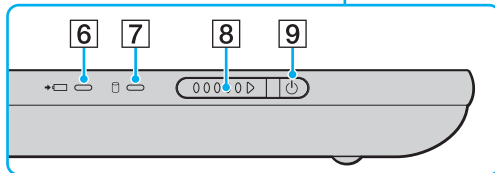
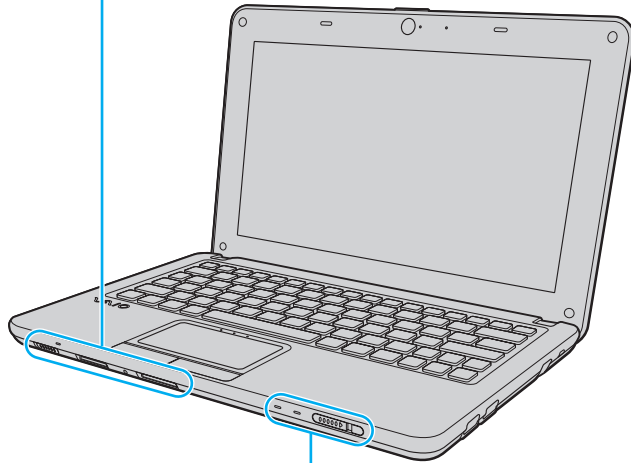
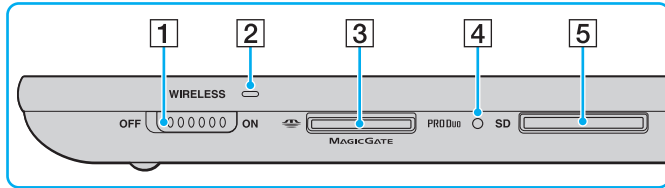

- 1 **WIRELESS** switch (page 41), (page 48)
- 2 **WIRELESS** indicator (page 16)
- 3 Memory Stick Duo slot* (page 30)
- 4 Media Access indicator (page 16)
- 5 **SD** memory card slot (page 35)
- 6 Charge indicator (page 16)
- 7 Disc drive indicator (page 16)
- 8 Power switch
- 9 Power indicator (page 16)

* Your computer supports only the Duo-size Memory Stick.

Back

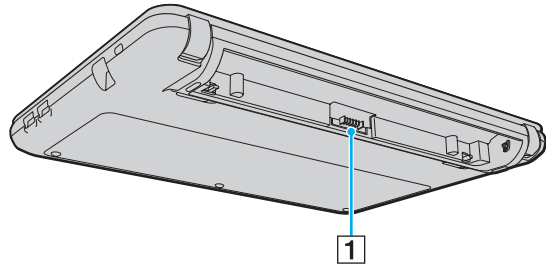

1 Battery connector ([page 18](#))

Right

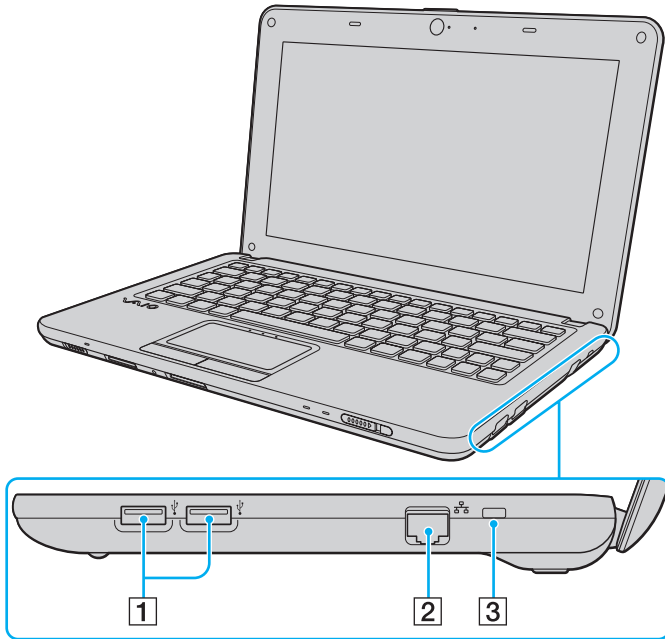

1 Hi-Speed USB (USB 2.0) ports* ([page 67](#))

2 Network (Ethernet) port ([page 40](#))

3 Security slot

* Support high-/full-/low- speeds.

Left

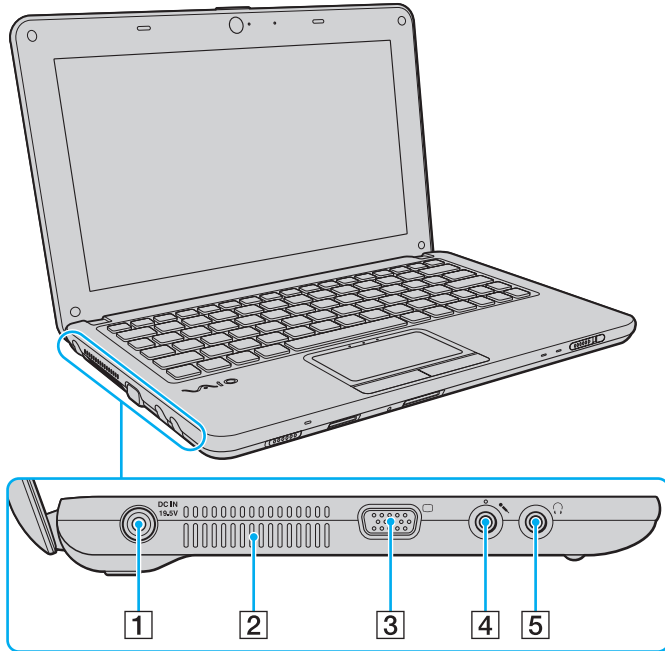

- 1 DC IN port ([page 17](#))
- 2 Air vent
- 3 Monitor port ([page 58](#))
- 4 Microphone jack ([page 66](#))
- 5 Headphones jack ([page 57](#))



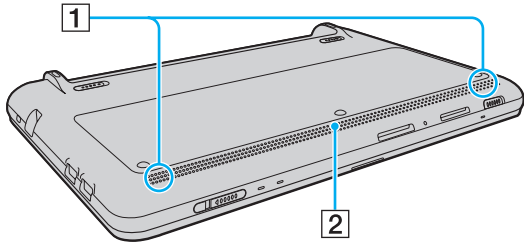



Bottom



- 1** Built-in speakers (stereo)
- 2** Air vent

About the Indicator Lights

Your computer is equipped with the following indicator lights:

Indicator	Functions
Power 	Illuminates in green when the computer is on, blinks slowly in orange while the computer is in Standby mode, and turns off when the computer is off or in Hibernate mode.
Charge 	Illuminates while the battery pack is charging. See Charging the Battery Pack (page 21) for more information.
Built-in MOTION EYE camera	Illuminates while the built-in camera is in use.
Media Access	Illuminates while data is being read from or written to a memory card, such as the Memory Stick and the SD memory card. (Do not place the computer into Standby mode or turn it off when this indicator is lit.) When the indicator is unlit, the memory card is not in use.
Disc drive 	Illuminates while the built-in storage device is running to read or write data. Do not place the computer into Standby mode or turn it off when this indicator is lit.
Num lock 	Press the Num Lk key to activate the numeric keypad. Press it a second time to deactivate the numeric keypad. The numeric keypad is not active when the indicator is unlit.
Caps lock 	Press the Caps Lock key to type letters in uppercase. Letters appear in lowercase if you press the Shift key while the indicator is lit. Press the key a second time to turn off the indicator. Normal typing resumes when the Caps lock indicator is unlit.
Scroll lock 	Press the Fn+Scr Lk keys to change how you scroll the display. Normal scrolling resumes when the Scroll lock indicator is unlit. The Scr Lk key functions differently depending on the program you are using and does not work with all programs.
WIRELESS	Illuminates when one or more wireless options are enabled.

Connecting a Power Source

You can use either an AC adapter or a rechargeable battery pack for supplying power to your computer.

Using the AC Adapter



Use only the supplied AC adapter for your computer.

To use the AC adapter

- 1 Plug one end of the power cord (1) into the AC adapter (3).
- 2 Plug the other end of the power cord into an AC outlet (2).
- 3 Plug the cable from the AC adapter (3) into the **DC IN** port (4) on the computer.

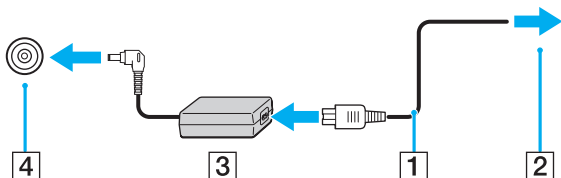

To disconnect your computer completely from AC power, unplug the AC adapter.

Make sure that the AC outlet is easily accessible.

If you do not intend to use your computer for a long period of time, place the computer into Hibernate mode. See **Using Hibernate Mode** (page 77).

Using the Battery Pack

The battery pack supplied with your computer is not fully charged at the time of delivery.

Installing the Battery Pack

To install the battery pack

- 1 Turn off the computer and close the LCD screen lid.
- 2 Slide the battery **LOCK** switch (1) outward.

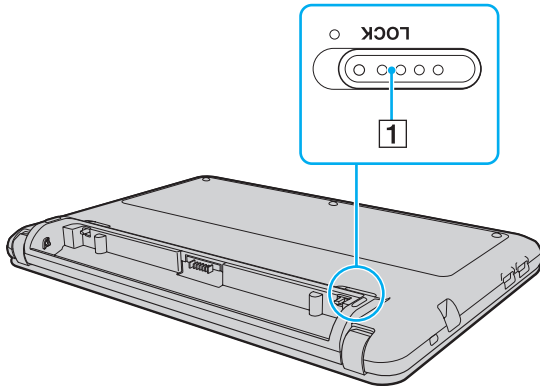

- 3 Slide the battery pack diagonally into the battery compartment until the projection (2) on either side of the battery compartment fits into the cut (3) on either side of the battery pack.

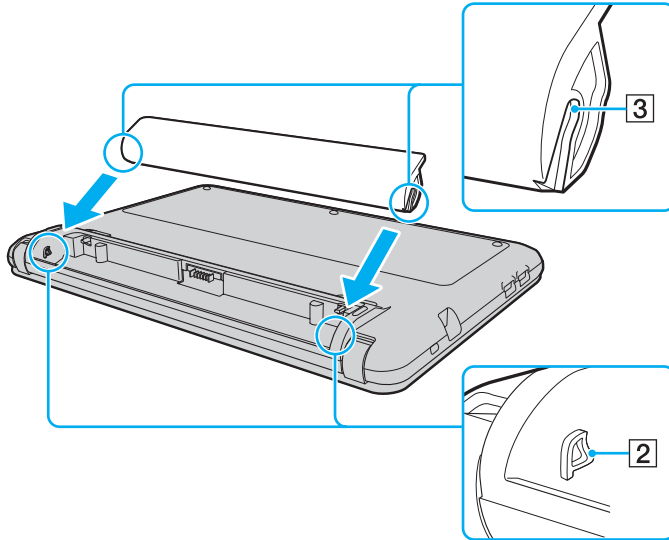

- 4 Push the battery pack down into the compartment until it clicks into place.

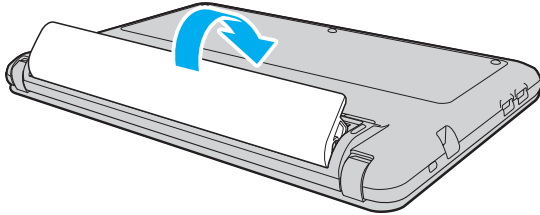

- 5 Slide the battery **LOCK** switch inward to secure the battery pack on the computer.



When your computer is directly connected to AC power and has a battery pack installed, it uses power from the AC outlet.



Certain rechargeable batteries do not meet Sony quality and safety standards. For safety reasons this computer only functions with genuine Sony battery packs designed for this model. If an unauthorized battery pack is installed, the battery will not be charged and the computer will not function.

Charging the Battery Pack

The battery pack supplied with your computer is not fully charged at the time of delivery.

To charge the battery pack

- 1 Install the battery pack.
- 2 Connect the computer to a power source with the AC adapter.
The charge indicator light turns on while the battery pack is charging. When the battery pack is about 85% charged, the battery indicator turns off.

Charge indicator status	Meaning
Lit in orange	The battery pack is charging.
Blinks along with the green power indicator	The battery pack is running out of power. (Normal mode)
Blinks along with the orange power indicator	The battery pack is running out of power. (Standby mode)
Blinks fast in orange	A battery error has occurred due to a failed battery pack or an unlocked battery pack.

! Charge the battery pack as described in this manual from your first battery charge.



Keep the battery pack in your computer while it is directly connected to AC power. The battery pack continues to charge while you are using the computer.

If the battery charge level falls below 10%, you should either connect the AC adapter to recharge the battery pack or shut down your computer and install a fully charged battery pack.

Your computer is supplied with a lithium ion battery pack and can be recharged any time. Charging a partially discharged battery pack does not affect the life of battery.

While some software applications or peripheral devices are in use, your computer may not enter Hibernate mode even when the remaining battery life is short. To avoid loss of data when using battery power, you should save your data frequently and manually activate a power management mode, such as Standby or Hibernate.

If the battery pack wears out when the computer enters Standby mode, you will lose all unsaved data. Going back to the previous work state is impossible. To avoid loss of data, you should save your data frequently.

When your computer is directly connected to AC power and has a battery pack installed, it uses power from the AC outlet.

Removing the Battery Pack

! You may lose data if you remove the battery pack while your computer is on and not connected to the AC adapter or if you remove the battery pack while the computer is in Standby mode.

To remove the battery pack

- 1 Turn off the computer and close the LCD screen lid.
- 2 Slide the battery **LOCK** switch (1) outward.
- 3 Slide the battery **RELEASE** latch (2) outward.
The battery pack is unlocked and its front-side edge is slightly raised.
- 4 Put your fingertip on the raised edge, lift the battery pack in the direction of the arrow, and slide it away from the computer.

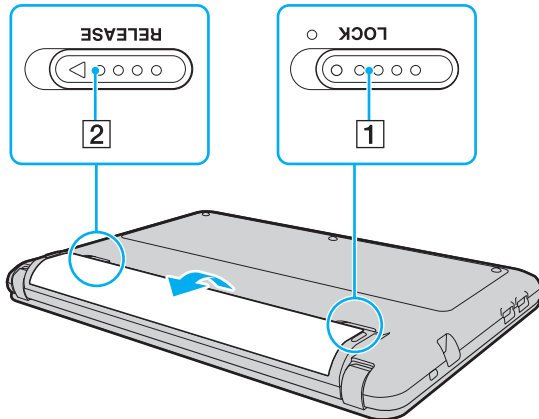

Shutting Down Your Computer Safely

To avoid losing unsaved data, be sure to shut down your computer properly, as described below.

To shut down your computer

- 1 Turn off any peripherals connected to the computer.
- 2 Click **Start** and then **Turn Off Computer**.
The **Turn off computer** window appears.
- 3 Click **Turn Off**.
- 4 Respond to any prompts warning you to save documents or to consider other users and wait for the computer to turn off automatically.
The power indicator light turns off.

Updating Your Computer

Be sure to install the latest updates on your computer with the following software applications so that the computer can run more efficiently.

❑ **Windows Update**

Click **Start**, point to **All Programs**, click **Windows Update**, and then follow the on-screen instructions.

❑ **VAIO Update 4**

Click **Start**, point to **All Programs** and **VAIO Update 4**, click **Go to VAIO Web Support**, and then follow the on-screen instructions.



Your computer must be connected to the Internet to download the updates.

Using Your VAIO Computer

This section describes how to get the most out of using your VAIO computer.

- ❑ **Using the Keyboard** ([page 27](#))
- ❑ **Using the Touch Pad** ([page 28](#))
- ❑ **Using the Built-in Camera** ([page 29](#))
- ❑ **Using the Memory Stick** ([page 30](#))
- ❑ **Using Other Modules / Memory Cards** ([page 35](#))
- ❑ **Using the Internet** ([page 39](#))
- ❑ **Using the Network (LAN)** ([page 40](#))
- ❑ **Using the Wireless LAN** ([page 41](#))
- ❑ **Using the Bluetooth Function** ([page 48](#))







Using the Keyboard

Your keyboard has additional keys that perform model-specific tasks.

Combinations and Functions with the Fn Key



Some keyboard functions can be used only after the operating system is finished launching.

Combinations/Feature	Functions
Fn +  (F2): muting	Turns on and off the built-in speakers or the headphones.
Fn +  (F3/F4): volume control	Changes the volume level. To increase the volume, keep pressing the Fn+F4 keys or press the Fn+F4 keys and then the ↑ or → key. To decrease the volume, keep pressing the Fn+F3 keys or press the Fn+F3 keys and then the ↓ or ← key.
Fn +  (F5/F6): brightness control	Changes the LCD brightness of your computer screen. To increase lighting intensity, keep pressing the Fn+F6 keys or press the Fn+F6 keys and then the ↑ or → key. To decrease lighting intensity, keep pressing the Fn+F5 keys or press the Fn+F5 keys and then the ↓ or ← key.
Fn +  /  (F7): display output	Switches the display output between your computer screen, an external display, and simultaneous output to both.
Fn +  (F12): hibernation	Provides the lowest level of power consumption. When you execute this command, the states of the system and the connected peripheral devices are saved to the built-in storage device and the system power is turned off. To return the system to its original state, use the power switch to turn on the power. For details on power management, see Using the Power Saving Modes (page 74) .

Using the Touch Pad

You can point to, select, drag, and scroll objects on the screen using the touch pad.

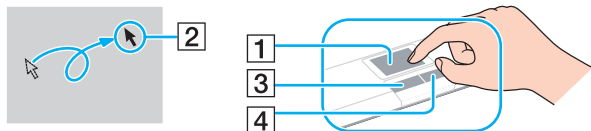

Action	Description
Point	Slide your finger on the touch pad (1) to place the pointer (2) on an item or object.
Click	Press the left button (3) once.
Double-click	Press the left button twice in a row.
Right-click	Press the right button (4) once. In many applications, this action displays a shortcut menu.
Drag	Slide your finger on the touch pad while pressing the left button.
Scroll	Slide your finger along the right edge of the touch pad to scroll vertically. Slide your finger along the bottom edge to scroll horizontally (the scroll function is available only with applications that support a touch pad scroll feature).



You can disable/enable the touch pad while a mouse is connected to your computer. To change the touch pad settings, use the **VAIO Control Center**.



Be sure to connect a mouse before disabling the touch pad. If you disable the touch pad before connecting a mouse, you will be able to use only the keyboard for pointer operations.

Using the Built-in Camera

Your computer is equipped with a built-in **MOTION EYE** camera.

With the preinstalled image capture software, you can perform the following operations:

- ❑ Capturing still images and movies
- ❑ Sensing and capturing object movements for monitoring purposes
- ❑ Editing captured data



Turning on the computer activates the built-in camera.

Video conference is possible with the appropriate software.



Launching or exiting your instant messaging or video editing software does not activate or deactivate the built-in camera.

Do not place your computer into Standby or Hibernate mode while you are using the built-in camera.

To use the preinstalled image capture software

- 1 Click **Start**, point to **All Programs** and **ArcSoft WebCam Companion 2**, and then click **WebCam Companion 2**.
- 2 Click the desired icon in the main window.
For detailed information on how to use the software, see the help file included with the software.



When capturing an image or a movie in a dark place, click the **Capture** icon or the **Record** icon in the main window, and then click the **WebCam Settings** icon and select the low light or low light compensation option in the properties window.

Using the Memory Stick

The Memory Stick is a compact, portable, and versatile IC recording media especially designed for exchanging and sharing digital data with compatible products, such as digital cameras, mobile phones, and other devices. Because it is removable, it can be used for external data storage.

Before You Use the Memory Stick

The Memory Stick slot on your computer can accommodate Duo-size media and supports Memory Stick PRO Duo and Memory Stick PRO-HG Duo with high-speed data transfer and large data capacity capabilities.

For the latest information about the Memory Stick, visit the Memory Stick web site at <http://www.memorystick.com/en/>.

Inserting and Removing a Memory Stick

To insert a Memory Stick

- 1 Locate the Memory Stick slot.
- 2 Hold the Memory Stick with the arrow facing upward and pointing toward the slot.
- 3 Carefully slide the Memory Stick into the slot until it clicks into place.



The Memory Stick is automatically detected by your system and the contents of the Memory Stick are displayed. If nothing appears on the desktop, click **Start** and **My Computer**, and double-click the Memory Stick icon.

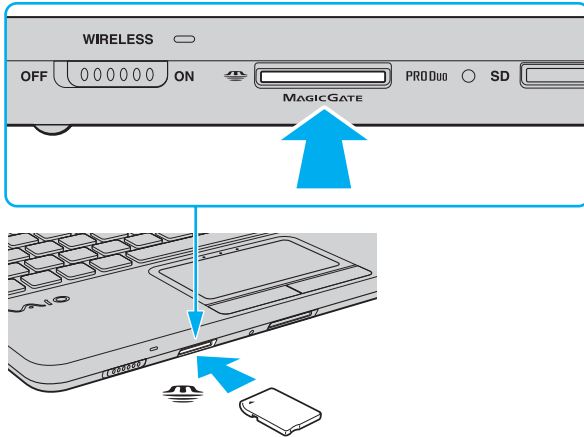

! Be sure to hold the Memory Stick with the arrow pointing in the correct direction as you insert it into the slot. To avoid damaging your computer or the media, do not force the Memory Stick into the slot if you cannot insert it smoothly.

Before using a Memory Stick Micro (M2), be sure to insert it into an M2 Duo adaptor. If you insert the media directly into the Memory Stick slot without the adaptor, you may not be able to remove it from the slot.

To remove a Memory Stick

! Do not remove the Memory Stick while the Media Access indicator light is lit. If you do, you may lose data. Large volumes of data may take time to load, so make sure the indicator is unlit before removing the Memory Stick.

- 1** Check that the Media Access indicator light is unlit.
- 2** Push in the Memory Stick toward the computer and release. The Memory Stick ejects.
- 3** Pull the Memory Stick out of the slot.

! Be sure to remove the Memory Stick gently, or it may pop out unexpectedly.

Formatting a Memory Stick

To format a Memory Stick

The Memory Stick has been formatted by default and is ready for use.

If you want to reformat the media with your computer, use the **Memory Stick Formatter** software. See the help file included with the **Memory Stick Formatter** software for details.

!
Be sure to use the device that is designed to format the media and supports the Memory Stick when formatting the media.

Formatting the Memory Stick erases the entire data stored on the media. Before formatting the media, make sure that it does not contain your valuable data.

Do not remove the Memory Stick from the slot while formatting. This could cause a malfunction.

Be sure to use the preinstalled **Memory Stick Formatter** software to format a Memory Stick. In case the Memory Stick is formatted by the formatting function of the Windows operating system, it cannot be recognized by other Memory Stick devices.

Notes on Using the Memory Stick

- ❑ Your computer has been tested and found compatible with Sony branded Memory Stick with capacity of up to 16 GB that are available as of January 2009. However, not all the Memory Stick that meet the same specifications as the compatible media are guaranteed of compatibility.
- ❑ Inserting a Memory Stick with multiple conversion adaptors is not guaranteed of compatibility.
- ❑ MagicGate is the general name of the copyright protection technology developed by Sony. Use a Memory Stick with the MagicGate logo to take advantage of this technology.
- ❑ Except for your personal use, it is against the copyright law to use any audio and/or image data you recorded without prior consent from the respective copyright holders. Accordingly, the Memory Stick with such copyrighted data can be used only within the law.
- ❑ The Memory Stick slot on your computer does not support 8-bit parallel data transfer (high-speed data transfer).
- ❑ Do not insert more than one Memory Stick into the slot. Improper insertion of the media may damage both your computer and the media.

Using Other Modules / Memory Cards

Using the SD Memory Card

Your computer is equipped with an **SD** memory card slot. You can use this slot to transfer data among digital cameras, camcorders, music players, and other audio/video devices.

Before you use the SD memory card

The **SD** memory card slot on your computer supports the following memory cards:

- SD memory card
- SDHC memory card
- MultiMediaCard (MMC)

For the latest information on compatible memory cards, see **Finding More about Your VAIO Computer (page 5)** to visit the appropriate support web site.

To insert an SD memory card

- 1 Locate the **SD** memory card slot.
- 2 Hold the SD memory card with the arrow facing upward and pointing toward the slot.
- 3 Carefully slide the SD memory card into the slot until it clicks into place.
Do not force the card into the slot.

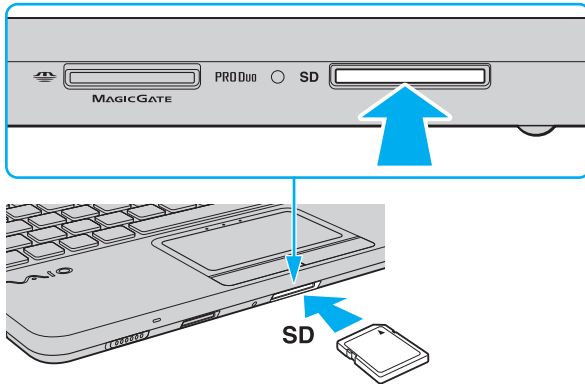

If the SD memory card does not go into the slot easily, remove it gently and verify you are inserting it in the proper direction.

To remove an SD memory card

- 1 Check that the Media Access indicator light is unlit.
- 2 Push in the SD memory card toward the computer and release.
The SD memory card ejects.
- 3 Pull the SD memory card out of the slot.

Notes on Using Memory Cards

General notes on using the memory card

- ❑ Be sure to use memory cards that are compliant with the standards supported by your computer.
- ❑ Be sure to hold the memory card with the arrow pointing in the correct direction as you insert it into the slot. To avoid damaging your computer or the media, do not force the memory card into the slot if you cannot insert it smoothly.
- ❑ Use care when inserting or removing the memory card from the slot. Do not force it in or out of the slot.
- ❑ Do not remove the memory card while the media access indicator light is lit. If you do, you may lose data.
- ❑ Do not attempt to insert a memory card or memory card adaptor of a different type into the memory card slot. An incompatible memory card or memory card adaptor may cause difficulty in removing from the slot and can cause damage to your computer.

Notes on using the SD memory card

- ❑ Your computer has been tested and found compatible only with major memory cards available as of January 2009. However, not all memory cards that meet the same specifications as the compatible media are guaranteed of compatibility.
- ❑ SD memory cards with capacity of up to 2 GB and SDHC memory cards with capacity of up to 32 GB have been tested and found compatible with your computer.
- ❑ The SD memory card slot on your computer does not support the copyright protection and high-speed data transfer features of the SD memory card and the SDHC memory card.

Using the Internet

Before using the Internet, you need to sign up with an Internet Service Provider (ISP) and set up devices required for connecting your computer to the Internet.

The following types of Internet connection services may be available from your ISP:

- Fiber to the Home (FTTH)
- Digital Subscriber Line (DSL)
- Cable modem
- Satellite
- Dial-up

For detailed information on devices required for Internet access and how to connect your computer to the Internet, ask your ISP.



To connect your computer to the Internet using the wireless LAN function, you need to set up the wireless LAN network. See **Using the Wireless LAN (page 41)** for more information.



When you connect your computer to the Internet, be sure to take appropriate security measures to protect the computer against online threats.

Depending on the service contract with your ISP, you may need to connect an external modem device, for example a USB telephone modem, a DSL modem, or a cable modem, to your computer to connect to the Internet. For the detailed instructions on connection setups and modem configuration, see the manual that came with your modem.

Using the Network (LAN)

You can connect your computer to 100BASE-TX/10BASE-T type networks with an Ethernet network cable. Connect one end of a network cable (not supplied) to the network (Ethernet) port on the computer and the other end to your network. For detailed settings and devices required for LAN access, ask your network administrator.

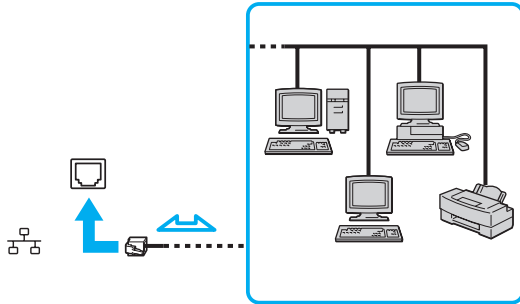

You can connect your computer to any network without changing the default settings.



Do not plug a telephone cable into the network (Ethernet) port on your computer.

If the network (Ethernet) port is connected to one of the telephone lines mentioned below, high electric current to the port may cause damage, overheating, or fire.

- Home (intercom speakerphone) or business-use telephone lines (multi-line business telephone)
- Public telephone subscriber line
- Private branch exchange (PBX)

Using the Wireless LAN

Using the Wireless LAN (WLAN), all your digital devices with the built-in WLAN function communicate freely with each other through a network. A WLAN is a network in which a user can connect to a Local Area Network (LAN) through a wireless (radio) connection.

The WLAN supports all normal Ethernet connectivity, but with the added benefits of mobility and roaming. You can still access information, Internet/intranet and network resources, even in the middle of a meeting, or as you move from one place to another.

You can communicate without an access point, which means that you can communicate with a limited number of computers (ad-hoc). Or you can communicate through an access point, which allows you to create a full infrastructure network.



In some countries, using WLAN products may be restricted by the local regulations (e.g. limited number of channels). Therefore, before activating the WLAN function, read the wireless LAN regulations guide carefully.

WLAN uses the IEEE 802.11a^{*}/b/g standard or the IEEE 802.11n^{*} draft standard, which specifies the type of technology used. The standard includes the encryption methods: Wired Equivalent Privacy (WEP), which is a security protocol, Wi-Fi Protected Access 2 (WPA2), and Wi-Fi Protected Access (WPA). Proposed jointly by the IEEE and Wi-Fi Alliance, both WPA2 and WPA are specifications of standards based on interoperable security enhancements that increase the level of data protection and access control for existing Wi-Fi networks. WPA is designed to be forward compatible with the IEEE 802.11i specification. It utilizes the enhanced data encryption Temporal Key Integrity Protocol (TKIP) in addition to user authentication using 802.1X and Extensible Authentication Protocol (EAP). Data encryption protects the vulnerable wireless link between clients and access points. Besides that, there are other typical LAN security mechanisms to ensure privacy, such as: password protection, end-to-end encryption, virtual private networks, and authentication. WPA2, the second generation of WPA, provides stronger data protection and network access control and is also designed to secure all versions of 802.11 devices, including 802.11b, 802.11a, 802.11g, and 802.11n draft standard, multi-band and multi-mode. In addition, based on the ratified IEEE 802.11i standard, WPA2 provides government grade security by implementing the National Institute of Standards and Technology (NIST) FIPS 140-2 compliant AES encryption algorithm and 802.1X-based authentication. WPA2 is backward compatible with WPA.

* See the specifications to find out about the configuration of your computer.

The IEEE 802.11b/g standard is a wireless LAN standard, using the 2.4 GHz band. The IEEE 802.11g standard provides higher-speed communications than the IEEE 802.11b standard.

The IEEE 802.11a standard is a wireless LAN standard, using the 5 GHz band.

The IEEE 802.11n draft standard is a wireless LAN standard, using the 2.4 GHz or 5 GHz band.

Wireless LAN devices using the 2.4 GHz band cannot communicate with devices using the 5 GHz band because the frequencies are different.

The 2.4 GHz band used by wireless LAN compatible devices is also used by other various devices. Although technologies to minimize interference from other devices that use the same band are employed on wireless LAN compatible devices, such interference may cause lower communication speed, narrower communication range, or broken wireless connections.

The communication speed varies depending on the distance between communication devices, existence of obstacles between such devices, the device configuration, the radio conditions, and the software in use. In addition, communications may be cut off depending on the radio conditions.

The communication range varies depending on the actual distance between communication devices, existence of obstacles between such devices, the radio conditions, the ambient environment that includes existence of walls and materials of such walls, and the software in use.

Actual communication speed may not be as fast as the one displayed on your computer.

Deploying IEEE 802.11b and IEEE 802.11g products on the same wireless network may reduce the communication speed due to radio interference. Taking this into consideration, the IEEE 802.11g products are designed to reduce the communication speed to ensure communications with IEEE 802.11b products. When the communication speed is not as fast as expected, changing the wireless channel on the access point may increase the communication speed.

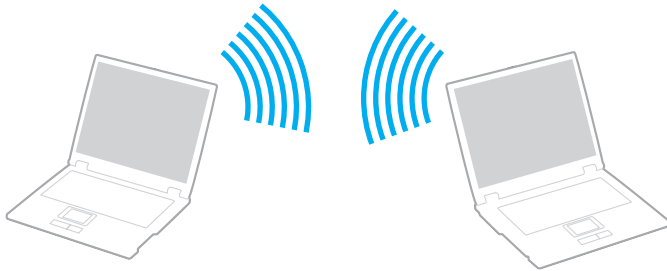

Communicating without an Access Point (Ad-hoc)

An ad-hoc network is a network in which a LAN is created only by wireless devices themselves, with no other central controller or access point. Each device communicates directly with other devices in the network. You can set up an ad-hoc network easily at home.



To communicate without an access point (ad-hoc)

! The IEEE 802.11a standard, using the 5 GHz band, and the IEEE 802.11n draft standard, using the 2.4 GHz or 5 GHz band, are not available on ad-hoc networks.

- 1 Turn on the **WIRELESS** switch.
The **WIRELESS** indicator light turns on.
- 2 Double-click  ( / ) on the taskbar to display the **Wireless Device Switch** window.
- 3 Select your desired wireless LAN option and click **OK**.
- 4 Click **Start** and then **Control Panel**.
- 5 Click **Network and Internet Connections**.
- 6 Click **Network Connections**.
The **Network Connections** window appears.
- 7 Right-click **Wireless Network Connection**, then click **Properties**.
The **Wireless Network Connection Properties** window appears.
- 8 Select the **Wireless Networks** tab.
- 9 Click the **Add...** button.
The **Wireless network properties** window appears.
- 10 Follow the on-screen instructions.

Communicating with an Access Point (Infrastructure)



An infrastructure network is a network that extends an existing wired local network to wireless devices by providing an access point (not supplied). The access point bridges the wireless and wired LAN and acts as a central controller for the wireless LAN network. The access point coordinates transmission and reception from multiple wireless devices within a specific range.

The access point will select which channel to use on an infrastructure network.

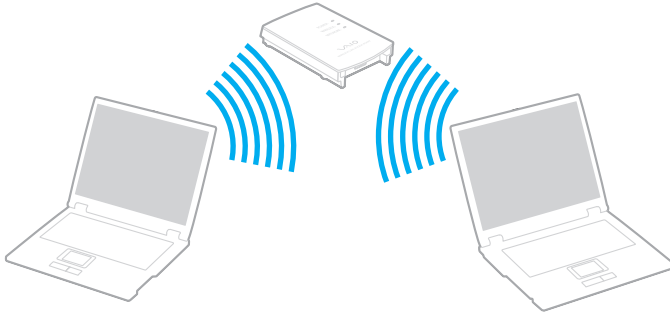
! For details on how to select the channel that will be used by the access point, see the manual that came with your access point.



To connect to a wireless network

- 1 Make sure an access point is set up.
See the manual that came with your access point for more information.
- 2 Turn on the **WIRELESS** switch.
The **WIRELESS** indicator light turns on.
- 3 Double-click  ( / ) on the taskbar to display the **Wireless Device Switch** window.
- 4 Select your desired wireless LAN option and click **OK**.
- 5 Click **Start** and then **Control Panel**.
- 6 Click **Network and Internet Connections**.
- 7 Click **Network Connections**.
- 8 In the right panel under **LAN or High-Speed Internet**, double-click **Wireless Network Connection**.
The **Wireless Network Connection** window appears.
- 9 Follow the on-screen instructions.



For WPA-PSK or WPA2-PSK authentication, you must enter a passphrase. The passphrase is case sensitive and must be a text string between 8 and 63 characters in length or a hexadecimal string of 64 characters.

Stopping Wireless LAN Communications

To stop wireless LAN communications

Turn off the **WIRELESS** switch.

! Turning off the wireless LAN function while accessing remote documents, files, or resources may result in data loss.

Using the Bluetooth Function

You can establish wireless communications between your computer and other Bluetooth® devices such as another computer or a mobile phone. You can transfer data between these devices without cables at a range of up to 10 meters in an open area.

Notes on using the Bluetooth function

- ❑ The data transfer rate varies, depending on the following conditions:
 - ❑ Obstacles, such as walls, located between devices
 - ❑ Distance between devices
 - ❑ Material used in walls
 - ❑ Proximity to microwaves and cordless telephones
 - ❑ Radio frequency interference and other environmental conditions
 - ❑ Device configuration
 - ❑ Type of software application
 - ❑ Type of operating system
 - ❑ Use of both wireless LAN and Bluetooth functions at the same time on your computer
 - ❑ Size of file being exchanged
- ❑ Large files may occasionally be corrupted during continuous transfer due to limitations of the Bluetooth standard and electromagnetic interference in the environment.
- ❑ All Bluetooth devices must be certified to make sure that the applicable standard requirements are maintained. Even if standards are met, individual device performance, specifications, and operation procedures can vary. Data exchange may not be possible in all situations.

- ❑ Video and audio may not be synchronized if you play videos on your computer with audio output from a connected Bluetooth device. This is a frequent occurrence with Bluetooth technology and is not a malfunction.
- ❑ The 2.4 GHz band, with which Bluetooth devices or wireless LAN devices work, is used by various devices. Bluetooth devices use the technology to minimize the interference from other devices that use the same wave length. Simultaneous use of the Bluetooth function and wireless communication devices, however, may cause radio interference and result in reduced communication speeds and distances than the standard values.



Read the Bluetooth regulations guide before using the Bluetooth function.

- ❑ The Bluetooth function may not work with other devices, depending on the manufacturer or the software version employed by the manufacturer.
- ❑ Connecting multiple Bluetooth devices to your computer may cause channel congestion, resulting in poor performance of the devices. This is normal with Bluetooth technology and is not a malfunction.

Bluetooth Security

The Bluetooth wireless technology has an authentication function, which allows you to determine with whom you choose to communicate. With the authentication function, you can prevent any anonymous Bluetooth devices from accessing your computer.

The first time two Bluetooth devices communicate, a common passkey (a password required for authentication) should be determined for both devices to be registered. Once a device is registered, there is no need to re-enter the passkey.



The passkey can be different each time, but must be the same at both ends.

For certain devices, such as a mouse, no passkey can be entered.

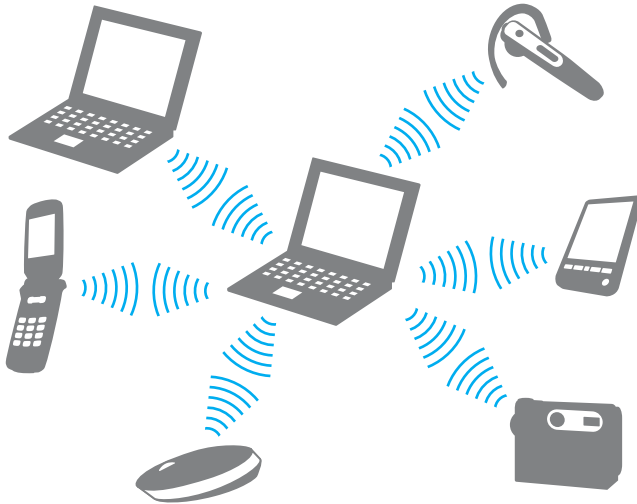

Communicating with Another Bluetooth Device

You can connect your computer to a Bluetooth device such as another computer, a mobile phone, a PDA, a headset, a mouse, or a digital camera without the use of any cables.



To communicate with another Bluetooth device

To communicate with another Bluetooth device, you first need to set up the Bluetooth function. For setting up and using the Bluetooth function, search **Help and Support Center** for Bluetooth information.

- 1 Turn on the **WIRELESS** switch.
 - 2 Double-click  ( / ) on the taskbar to display the **Wireless Device Switch** window.
 - 3 Select the Bluetooth option and click **OK**.
 - 4 Click **OK**.
- For more information, see the help file included with your software.

Stopping Bluetooth Communications

To stop Bluetooth communications

Turn off the **WIRELESS** switch. The **WIRELESS** indicator light turns off.

Using Peripheral Devices

You can add functionality to your VAIO computer by using the various ports on the computer.

- ❑ **Connecting an Optical Disc Drive** ([page 55](#))
- ❑ **Connecting External Speakers or Headphones** ([page 57](#))
- ❑ **Connecting an External Display** ([page 58](#))
- ❑ **Selecting Display Modes** ([page 61](#))
- ❑ **Using the Multiple Monitors Function** ([page 63](#))
- ❑ **Connecting an External Microphone** ([page 66](#))
- ❑ **Connecting a USB Device** ([page 67](#))

Connecting an Optical Disc Drive

To use optical disc media with your computer, connect an external optical disc drive (not supplied) to your computer.

Connecting an Optical Disc Drive

! Be sure to connect an external optical disc drive before you launch any preinstalled disc operation program.

To connect an optical disc drive

- 1 Plug the power cord (if any) of your external optical disc drive (not supplied) (1) into an AC outlet.
 - 2 Choose the USB port (2) you prefer to use.
 - 3 Plug one end of a USB cable (not supplied) (3) into the USB port, and the other end to the optical disc drive.
- See the manual that came with your external optical disc drive for the detailed instructions on connecting the USB cable to the drive.

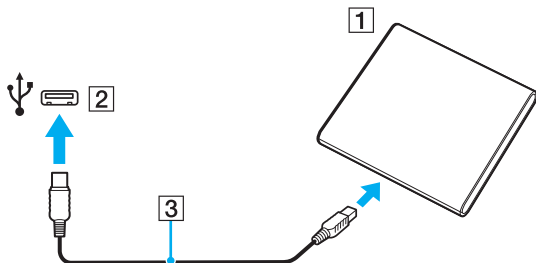

Disconnecting an Optical Disc Drive

You can disconnect an optical disc drive while your computer is either on or off. Disconnecting the drive while the computer is in a power saving mode (Standby or Hibernate), however, may cause the computer to malfunction.

To disconnect an optical disc drive



To disconnect an optical disc drive while your computer is off, skip steps 1 to 5.

- 1 Close all software applications accessing the optical disc drive.
- 2 Double-click the **Safely Remove Hardware** icon on the taskbar.
- 3 Select the optical disc drive you want to disconnect.
- 4 Click **Stop**.
- 5 Follow the on-screen instructions for disconnecting the optical disc drive.
- 6 Unplug the USB cable from the computer.

Connecting External Speakers or Headphones

You can connect external sound output devices (not supplied), such as speakers or headphones, to your computer.

To connect external speakers



Make sure your speakers are designed for computer use.



Turn down the volume of the speakers before you turn them on.

Connect external speakers (1) to the headphones jack (2) with a speaker cable (3) (not supplied).

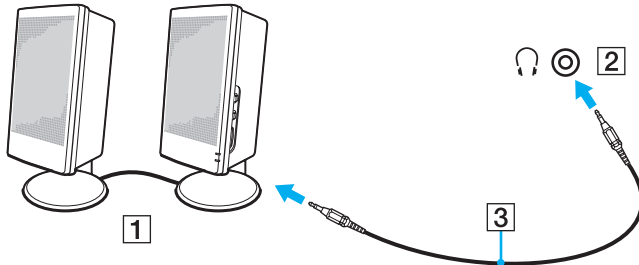

Connecting an External Display

You can connect an external display to your computer. For example, you can use the computer with a computer display or a projector.



Features and options in this section may not be available on your computer.



Connect the power cord of your external display after connecting all other cables.

Connecting a Computer Display

You can connect a computer display (monitor) to your computer.

To connect a computer display

- 1 If necessary, plug one end of the display's power cord (1) into your display, and the other end into an AC outlet.
- 2 Plug the display cable (2) into the monitor port (3) on the computer.

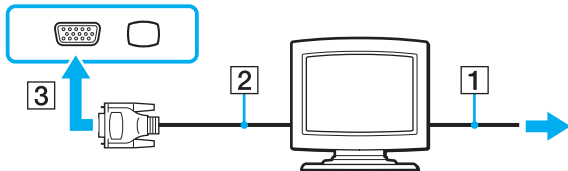

Connecting a Multimedia Computer Display

You can connect a multimedia computer display that includes built-in speakers and a microphone to your computer.

To connect a multimedia computer display

- 1 Plug the power cord of your multimedia computer display (1) into an AC outlet.
- 2 Plug the display cable (2) into the monitor port (3) □ on the computer.
- 3 Plug the speaker cable (4) into the headphones jack (5) 🎧 on the computer.
- 4 Plug the microphone cable (6) into the microphone jack (7) 🎤 on the computer.

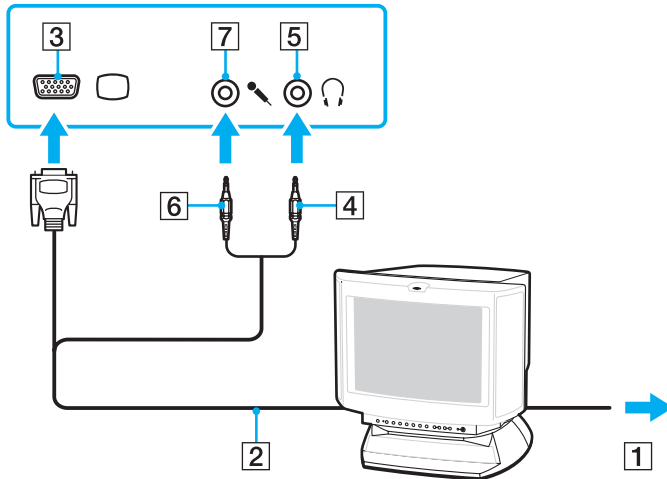

Connecting a Projector

You can connect a projector (for example, the Sony LCD projector) to your computer.

To connect a projector

- 1 Connect the power cord (1) of your projector into an AC outlet.
- 2 Plug a display cable (2) into the monitor port (3) □ on the computer.
- 3 Plug an audio cable (4) into the headphones jack (5) 🎧 on the computer.
- 4 Plug the display cable and the audio cable into the port and jack on the projector (6).

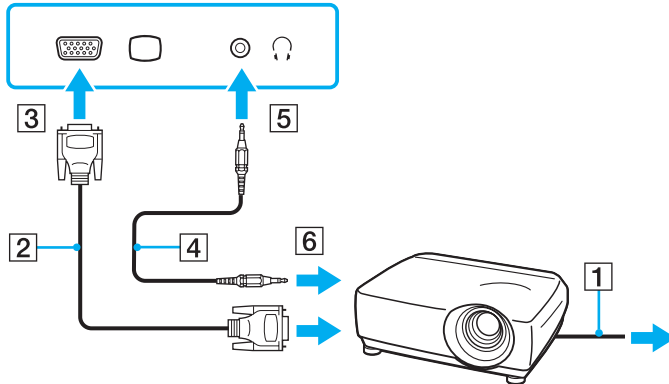

Selecting Display Modes

When an external display is connected, you can select either your computer screen or the connected display to use as the primary monitor.

If you want to work on your computer screen and the external display at the same time, see **Using the Multiple Monitors Function (page 63)** for more information.



The procedure for selecting a display depends on the video controller used in the computer.
See the specifications to find out about the configuration of your computer.

To select a display



You may not be able to display the same contents on your computer screen and the external display or projector at the same time, depending on the type of your external display or projector.

Turn on the external display before turning on your computer.

- ❑ On models with the Intel Graphics Media Accelerator
 - 1 Right-click on the desktop to display the context menu.
 - 2 Click the menu item for properties.
 - 3 Follow the on-screen instructions to change the settings.
- ❑ On models with the NVIDIA video controller
 - 1 Right-click on the desktop and select **NVIDIA Control Panel** from the menu.
 - 2 Click the **Display** icon.
 - 3 Click **Change Display Configuration**.
 - 4 Follow the on-screen instructions to change the settings.

- ❑ On models with the ATI video controller

When the computer has an external display connected, you can change the Main/Clone setting as follows:

- 1 Right-click on the desktop and select **ATI CATALYST® Control Center**.
- 2 Follow the on-screen instructions to change the settings.

Using the Multiple Monitors Function

The Multiple Monitors function allows you to distribute portions of your desktop across separate displays. For example, if you have an external display connected to the monitor port, your computer screen and the external display can function as a single desktop.



The procedure for using the Multiple Monitors function depends on the video controller used in the computer. See the specifications to find out about the configuration of your computer.

You can move the cursor from one display to the other. This allows you to drag objects, such as an open application window or a toolbar, from one display to the other.

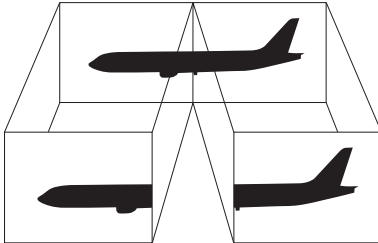

To use the Multiple Monitors function



Your external display may not support the Multiple Monitors function.

Certain software applications may not be compatible with Multiple Monitors settings.

Make sure that your computer does not enter Standby or Hibernate mode while you are using the Multiple Monitors function. Otherwise, the computer may not return to Normal mode.

If you set different colors on each display, do not expand a single window across two displays. Otherwise, your software may not work properly.

Set fewer colors or a lower resolution for each display.

- ❑ On models with the Intel Graphics Media Accelerator
 - 1 Right-click on the desktop to display the context menu.
 - 2 Click the menu item for properties.
 - 3 Follow the on-screen instructions to change the settings.
- ❑ On models with the NVIDIA video controller
 - 1 Right-click on the desktop and select **NVIDIA Control Panel** from the menu.
 - 2 Click the **Display** icon.
 - 3 Click **Change Display Configuration**.
 - 4 Follow the on-screen instructions to change the settings.
- ❑ On models with the ATI video controller
 - 1 Right-click on the desktop and select **ATI CATALYST® Control Center**.
 - 2 Follow the on-screen instructions to change the settings.



Additionally, you can set the display colors and resolution for each display and customize the Multiple Monitors function.

Connecting an External Microphone

You can connect an external microphone (not supplied) to your computer.

To connect an external microphone

Plug the microphone cable (1) into the microphone jack (2) .

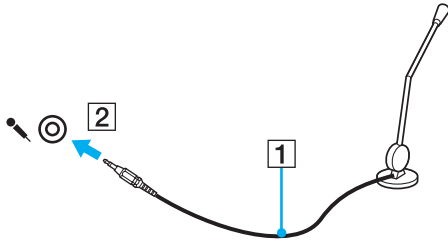

Make sure your microphone is designed for computer use.

Connecting a USB Device

You can connect a Universal Serial Bus (USB) device to your computer, such as a mouse, floppy disk drive, speaker, and printer.

To connect a USB device

- 1 Choose the USB port (1) you prefer to use.
- 2 Plug the USB device cable (2) into the USB port.

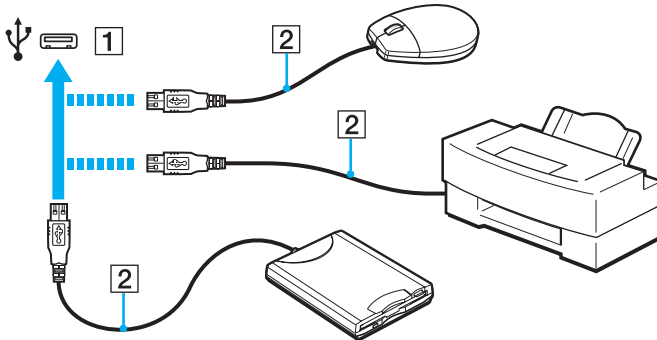

Notes on connecting a USB device

- ❑ You may need to install the driver software supplied with your USB device before use. See the manual that came with the USB device for more information.
- ❑ Be sure to use a USB printer compatible with your version of Windows to print documents.
- ❑ For information on how to remove a USB device, see the manual that came with the device.
- ❑ To protect your computer and/or USB devices from damage, observe the following:
 - ❑ When moving the computer with USB devices connected, avoid exposing the USB ports to shock or impact.
 - ❑ Do not put the computer into a bag or carrying case when it has USB devices connected.

Customizing Your VAIO Computer

This section briefly describes how to change the main settings of your VAIO computer. Among other things, you will learn how to use and customize the look of your Sony software and utilities.

- ❑ **Setting the Password** ([page 70](#))
- ❑ **Using the VAIO Control Center** ([page 73](#))
- ❑ **Using the Power Saving Modes** ([page 74](#))
- ❑ **Using the VAIO Power Management** ([page 79](#))

Setting the Password

Use one of the BIOS functions to set the password.

Once you have set the password, you will be prompted to enter the password after the VAIO logo appears to start your computer. The power-on password allows you to protect your computer from unauthorized access.

Adding the Power-on Password

The power-on password is provided to protect your computer from unauthorized access.

! Once you have set the power-on password, you cannot start your computer without entering the password. Be sure not to forget the password. Write down your password and keep it safe and private from other people.

If you forget the power-on password and need assistance to reset it, a password reset fee will be charged, and your computer may need to be sent in for service to reset the password.

To add the power-on password

- 1 Turn on the computer.
- 2 Press the **F2** key when the VAIO logo appears.
The BIOS setup screen appears. If not, restart the computer and press the **F2** key several times when the VAIO logo appears.
- 3 Press the **←** or **→** key to select **Security** to display the **Security** tab, select **Set Machine Password**, and then press the **Enter** key.
- 4 On the password entry screen, enter the password twice and press the **Enter** key.
The password can be up to 32 alphanumeric characters (including spaces) long.
- 5 At the confirmation prompt, press the **Enter** key.



The following is to configure your computer to prompt password entry when you turn it on or display the BIOS setup screen.

- 6 Select **Password when Power On** under **Security** and press the **Enter** key.
- 7 Change the setting from **Disabled** to **Enabled**.
- 8 Press the **←** or **→** key to select **Exit**, select **Exit (Save Changes)** or **Exit Setup**, and then press the **Enter** key.
At the confirmation prompt, press the **Enter** key.

Changing/Removing the Power-on Password

To change or remove the power-on password

- 1 Turn on the computer.
- 2 Press the **F2** key when the VAIO logo appears.
The BIOS setup screen appears. If not, restart the computer and press the **F2** key several times when the VAIO logo appears.
- 3 Enter the current password for **Enter Password** and press the **Enter** key.
- 4 Press the **←** or **→** key to select **Security** to display the **Security** tab, select **Set Machine Password**, and then press the **Enter** key.
- 5 On the password entry screen, enter the current password once and a new password twice, and then press the **Enter** key.
To remove the password, leave the **Enter New Password** and **Confirm New Password** fields blank and press the **Enter** key.
At the confirmation prompt, press the **Enter** key.
- 6 Press the **←** or **→** key to select **Exit**, select **Exit (Save Changes)** or **Exit Setup**, and then press the **Enter** key.
At the confirmation prompt, press the **Enter** key.

Using the VAIO Control Center

The **VAIO Control Center** utility allows you to access system information and to specify preferences for system behavior.

To use the VAIO Control Center

- 1 Click **Start**, point to **All Programs**, and click **VAIO Control Center**.
The **VAIO Control Center** window appears.
- 2 Select the desired control item and change the settings.
- 3 Once finished, click **OK**.
The setting of the desired item has been changed.



For more information about each option, see the help file included with the **VAIO Control Center**.

Some of the control items will not be visible if you open the **VAIO Control Center** as a standard user.

Using the Power Saving Modes

You can take advantage of the power management settings to conserve battery life. In addition to the normal operating mode, your computer has two distinct power saving modes: Standby and Hibernate. When using battery power, you should be aware that the computer will automatically enter Hibernate mode if the remaining battery life becomes short, regardless of the power management setting you select.

! If the battery charge level falls below 10%, you should either connect the AC adapter to recharge the battery pack or shut down your computer and install a fully charged battery pack.

Using Normal Mode

This is the normal state of your computer when it is in use. The green power indicator light is lit in this mode.

Using Standby Mode

Standby mode turns off the LCD screen and places the built-in storage device(s) and the CPU into a low power consumption mode. The orange power indicator light blinks slowly in this mode.

! If you do not intend to use your computer for a long period of time while it is disconnected from AC power, place the computer into Hibernate mode or turn it off.

To activate Standby mode

- 1 Click **Start** and then **Turn Off Computer**.
- 2 Click **Stand By**.



Your computer comes out of Standby mode quicker than out of Hibernate mode.

Standby mode uses more power than Hibernate mode.

! If the battery runs out of power while your computer is in Standby mode, you will lose all unsaved data. Going back to the previous work state is impossible. To avoid loss of data, you should save your data frequently.

To return to Normal mode

- ❑ Press any key.
- ❑ Slide the power switch (in the direction of ▷ on the switch).

! If you slide (in the direction of ▷ on the switch) and hold the power switch for more than four seconds, your computer will turn off automatically. You will lose all unsaved data.

 You can use the **VAIO Control Center** to configure your computer to return to Normal mode when you open the LCD screen lid. This power resuming preference will be lost if you remove both the AC adapter and the battery pack.

If the computer is not used for a certain period of time, it will enter Standby mode. To modify this, you can change the Standby mode settings.

To change the Standby mode settings

- 1 Click **Start** and then **Control Panel**.
- 2 Click **Performance and Maintenance**.
- 3 Click **Power Options**.
The **Power Options Properties** window appears.
- 4 Select the **Power Schemes** tab.
- 5 Change the **System Standby** settings.

Using Hibernate Mode

In Hibernate mode, the state of the system is saved on the built-in storage device(s) and power is turned off. Even when the battery runs out of power, no data will be lost. The power indicator light is unlit in this mode.



If you do not intend to use your computer for a long period of time, place the computer into Hibernate mode.

To activate Hibernate mode

Press the **Fn+F12** keys.

The computer enters Hibernate mode.

Alternatively, you can follow these steps to place the computer into Hibernate mode.

- 1 Click **Start** and then **Turn Off Computer**.
- 2 Click **Hibernate**.



Hibernate mode requires more time than Standby mode to be activated.

Hibernate mode uses less power than Standby mode.



Do not move your computer before its power indicator light turns off.

To return to Normal mode

Slide the power switch (in the direction of ▷ on the switch).

The computer returns to its normal state.



If you slide (in the direction of ▷ on the switch) and hold the power switch for more than four seconds, your computer will turn off automatically.



It takes more time to return to Normal mode from Hibernate mode than from Standby mode.

You can use the **VAIO Control Center** to configure your computer to return to Normal mode when you open the LCD screen lid. This power resuming preference will be lost if you remove both the AC adapter and the battery pack.

Using the VAIO Power Management

Power management helps you set up power plans for running on AC or battery power to suit your requirements for power consumption.

The **VAIO Power Management** is a software application developed exclusively for VAIO computers. With this software application, you can enhance the Windows power management functions to ensure better operation of your computer and longer battery life. See the help file included with the software for more information.

Activating the VAIO Power Management

The **VAIO Power Management** functions are added to the Windows **Power Options Properties**.

To activate the VAIO Power Management

- 1 Click **Start** and then **Control Panel**.
- 2 Click **Performance and Maintenance**.
- 3 Click **Power Options**.
The **Power Options Properties** window appears.
- 4 Select the **VAIO Power Management** tab.

To restore the default settings

- 1 On the **VAIO Power Management** tab, click **Advanced**.
The **VAIO Power Management** window appears.
- 2 Follow the on-screen instructions to change the settings.

Activating the VAIO Power Management Power Schemes

The **VAIO Power Management** provides several predefined power schemes. Each power scheme consists of a group of power management settings that are designed to meet specific power management needs, ranging from maximum power management to no power management.

To activate a VAIO Power Management power scheme

- 1 Click **Start** and then **Control Panel**.
- 2 Click **Performance and Maintenance**.
- 3 Click **Power Options**.
The **Power Options Properties** window appears.
- 4 Select the tab for power scheme settings.
- 5 Select a power scheme from the drop-down list.
- 6 If you now select the **VAIO Power Management** tab, you see that the selected power scheme appears on the tab.
- 7 If necessary, you can change the items in the list, for example, the LCD brightness of your computer screen.
- 8 Click **OK**.
The power scheme has been activated.



You must have administrator rights on your computer to set up a power scheme.

Precautions

This section describes safety guidelines and precautions to help you protect your VAIO computer from potential damage.

- ❑ **Handling the LCD Screen** ([page 82](#))
- ❑ **Using the Power Source** ([page 83](#))
- ❑ **Handling Your Computer** ([page 84](#))
- ❑ **Handling the Built-in Camera** ([page 87](#))
- ❑ **Handling Discs** ([page 88](#))
- ❑ **Using the Battery Pack** ([page 89](#))
- ❑ **Using Headphones** ([page 90](#))
- ❑ **Handling the Memory Stick** ([page 91](#))
- ❑ **Handling the Built-in Storage Device** ([page 92](#))

Handling the LCD Screen

- ❑ Do not leave the LCD screen facing the sun. This could damage the LCD screen. Be careful when using your computer near a window.
- ❑ Do not scratch the surface of the LCD screen or exert pressure on it. This could cause a malfunction.
- ❑ Using your computer in low temperature conditions may produce a residual image on the LCD screen. This is not a malfunction. When the computer returns to normal temperature, the screen returns to normal.
- ❑ A residual image may appear on the LCD screen if the same image is displayed for a long period of time. The residual image disappears after a while. You can use a screen saver to prevent residual images.
- ❑ The LCD screen becomes warm during operation. This is normal and does not indicate a malfunction.
- ❑ The LCD screen is manufactured using high-precision technology. You may, however, see tiny black points and/or bright points (red, blue, or green) that continuously appear on the LCD screen. This is a normal result of the manufacturing process and does not indicate a malfunction.
- ❑ Avoid rubbing the LCD screen. This could damage the screen. Use a soft, dry cloth to wipe the surface of the LCD screen.
- ❑ Do not exert pressure on the LCD screen lid with the lid closed as it may scratch the LCD screen or soil it.

Using the Power Source



See the specifications to find out about the configuration of your computer.

- Do not share the AC outlet with other power-consuming equipment, such as a photocopier or a shredder.
- You can purchase a power strip with a surge protector. This device helps prevent damage to your computer caused by sudden power surges, in an electrical storm, for example.
- Do not place heavy objects on the power cord.
- To disconnect the cord, pull it out by holding the plug. Never pull the cord itself.
- Unplug your computer from the AC outlet if you are not planning to use the computer for a long period of time.
- Make sure that the AC outlet is easily accessible.
- When the AC adapter is not used, unplug it from the AC outlet.
- Use the AC adapter supplied with your computer or genuine Sony products. Do not use any other AC adapter as it may cause a malfunction.

Handling Your Computer

- ❑ Clean the cabinet with a soft cloth, which is dry or lightly moistened with a mild detergent solution. Do not use any type of abrasive pad, scouring powder, or solvent such as alcohol or benzene, as these may damage the finish of your computer.
- ❑ If you drop a solid object or any liquid onto your computer, shut down the computer, unplug it, and remove the battery pack. You may want to have the computer checked by qualified personnel before operating it again.
- ❑ Do not drop your computer or place any objects on top of the computer.
- ❑ Do not place your computer in a location subject to:
 - ❑ Heat sources, such as radiators or air ducts
 - ❑ Direct sunlight
 - ❑ Excessive dust
 - ❑ Moisture or rain
 - ❑ Mechanical vibration or shock
 - ❑ Strong magnets or speakers that are not magnetically shielded
 - ❑ Ambient temperature of more than 35°C or less than 5°C
 - ❑ High humidity

- ❑ Do not place electronic equipment near your computer. The electromagnetic field of the equipment may cause the computer to malfunction.
- ❑ Use your computer on a solid, stable surface.
- ❑ We advise not to use your computer directly on your lap. The temperature of the bottom of the unit may rise during normal operation, and after an extended period of time, could cause discomfort or burns.
- ❑ Provide adequate air circulation to prevent internal overheating. Do not place your computer on porous surfaces such as rugs, blankets, couches, or beds, or near draperies that may block its air vents.
- ❑ Your computer uses high-frequency radio signals and may cause interference to radio or TV reception. If this occurs, relocate the computer a suitable distance away from the set.
- ❑ Use only specified peripheral equipment and interface cables. Otherwise, problems may occur.
- ❑ Do not use cut or damaged connection cables.
- ❑ If your computer is brought directly from a cold location to a warm one, moisture may condense inside the computer. In such a case, allow at least one hour before turning on the computer. If any problems occur, unplug the computer and contact VAIO-Link.
- ❑ Make sure you disconnect the AC adapter and remove the battery pack before cleaning your computer.
- ❑ To avoid losing data when your computer is damaged, back up your data regularly.

- ❑ Do not exert pressure on the LCD screen or its edges when opening the LCD screen lid or lifting your computer. The LCD screen may be sensitive to pressure or added stress, and exerting pressure may damage the screen or cause it to malfunction. To open the computer, hold the base with one hand and gently lift the LCD screen lid with the other. To carry the computer with the lid open, be sure to hold the computer with both hands.

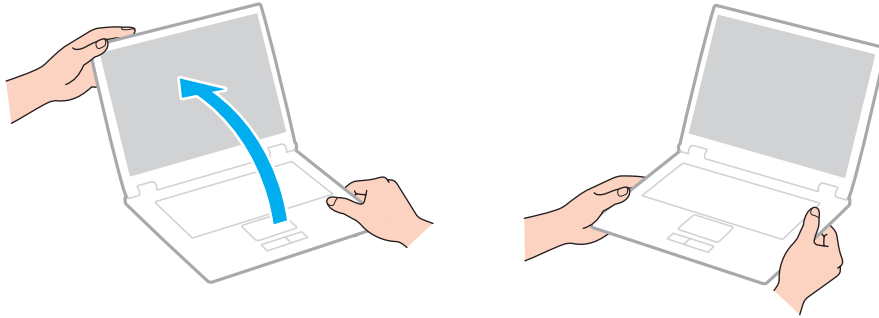

- ❑ Use a carrying case specially designed to carry your computer.

Handling the Built-in Camera

- ❑ Do not touch the lens protection cover of the built-in camera, as it may cause scratches on the cover and such scratches will appear on the captured images.
- ❑ Do not let the direct sunlight get into the lens of the built-in camera regardless of your computer's power state, as it may cause the camera to malfunction.
- ❑ Clean the lens protection cover of the built-in camera with a blower brush or a soft brush. If the cover is extremely dirty, wipe it off with a soft dry cloth. Do not rub the cover, as it is sensitive to pressure.

Handling Discs

- ❑ Fingerprints and dust on the surface of a disc may cause read errors. Be sure to hold the disc by its edges and central hole, as shown below:

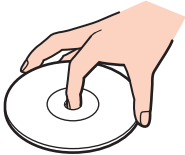

- ❑ Proper care of the disc is essential to its continuous reliability. Do not use solvents (such as benzine, thinner, alcohol, commercially available cleaners, or anti-static spray) which may cause damage to the disc.
- ❑ For normal cleaning, hold the disc by its edges and use a soft cloth to wipe the surface from the center out.
- ❑ If the disc is badly soiled, moisten a soft cloth with water, wring it out well, and use it to wipe the surface of the disc from the center out. Wipe off any remaining moisture with a dry soft cloth.
- ❑ Never affix an adhesive label to a disc. This will affect the use of the disc and may result in irreparable damage.

Using the Battery Pack

- ❑ Do not leave battery packs in temperatures above 60°C, such as in a car parked in the sun or under direct sunlight.
- ❑ Battery life is shorter in a cold environment. This is due to decreased battery efficiency at low temperatures.
- ❑ Charge battery packs at temperatures between 10°C to 30°C. Lower temperatures require longer charging time.
- ❑ Certain rechargeable battery packs do not meet Sony quality and safety standards. For safety reasons this computer only functions with genuine Sony battery packs designed for this model. If an unauthorized battery pack is installed, the battery pack will not be charged and the computer will not function.
- ❑ While the battery pack is in use or being charged, heat builds up in the battery pack. This is normal and is not cause for concern.
- ❑ Keep the battery pack away from all sources of heat.
- ❑ Keep the battery pack dry.
- ❑ Do not open or try to disassemble the battery pack.
- ❑ Do not expose the battery pack to any mechanical shock, such as dropping it on a hard surface.
- ❑ If you are not using your computer for a long period of time, remove the battery pack from the computer to prevent damage to the battery pack.
- ❑ If you have not used the battery pack for a considerable amount of time, the remaining battery life may become short. However, this is normal and does not indicate a malfunction, because the battery pack will gradually discharge over time even when not in use. Connect the AC adapter to your computer and recharge the battery pack before using the computer again.
- ❑ You do not need to discharge the battery pack before recharging.
- ❑ If the battery pack quickly runs out of power after being fully charged, it may be reaching the end of its life and should be replaced.

Using Headphones

- ❑ **Road safety** – Do not use headphones while driving, cycling, or operating any motorized vehicle. It may create a traffic hazard and is illegal in some areas. It can also be potentially dangerous to play loud music while walking, especially at pedestrian crossings.
- ❑ **Preventing hearing damage** – Avoid using headphones at high volume. Hearing experts advise against continuous, loud and extended play. If you experience a ringing in your ears, reduce the volume or discontinue use.

Handling the Memory Stick

- ❑ Do not touch the Memory Stick connector with your finger or metallic objects.
- ❑ Use only the adhesive label supplied with the Memory Stick as a label.
- ❑ Do not bend, drop, or expose the Memory Stick.
- ❑ Do not disassemble or modify the Memory Stick.
- ❑ Do not let the Memory Stick get wet.
- ❑ Do not use or store the Memory Stick in a location subject to:
 - ❑ Static electricity
 - ❑ Electrical noise
 - ❑ Extremely high temperatures, such as in a car parked in the sun
 - ❑ Direct sunlight
 - ❑ High humidity
 - ❑ Corrosive substances
- ❑ Use the storage case supplied with the Memory Stick.
- ❑ Be sure to make a backup copy of your valuable data.
- ❑ Keep the Memory Stick and the Memory Stick adaptors out of reach of children. There is a risk of swallowing them.
- ❑ When using the Memory Stick Duo, do not use a fine-tipped pen to write on the label adhered to the Memory Stick Duo. Exerting pressure on the media may damage internal components.

Handling the Built-in Storage Device

The built-in storage device (hard disk drive or solid state drive) has a high storage density and reads or writes data in a short time. However, it can be easily damaged if improperly used. If the built-in storage device is damaged, the data cannot be restored. To prevent losing data, you should be careful when handling your computer.



Features and options in this section may not be available on your computer.
See the specifications to find out about the configuration of your computer.

To avoid damaging your hard disk drive

- Do not subject your computer to sudden movements.
- Keep your computer away from magnets.
- Do not place your computer in a location subject to mechanical vibration or in an unstable position.
- Do not move your computer while the power is on.
- Do not turn off the power or restart your computer while reading or writing data to the hard disk drive.
- Do not use your computer in a place subject to extreme changes in temperature.
- Do not remove the hard disk drive from your computer.

To avoid damaging your solid state drive

- Do not turn off the power or restart your computer while reading or writing data to the solid state drive.
- Do not remove the solid state drive from your computer.

Troubleshooting

This section describes how to solve common problems you might encounter when using your VAIO computer. Many problems have simple solutions. Try these suggestions before contacting VAIO-Link.



Features and options in this section may not be available on your computer.

- Computer** ([page 94](#))
- System Security** ([page 100](#))
- Battery** ([page 102](#))
- Built-in Camera** ([page 104](#))
- Networking** ([page 106](#))
- Bluetooth Technology** ([page 109](#))
- Display** ([page 112](#))
- Printing** ([page 115](#))
- Microphone** ([page 116](#))
- Speakers** ([page 117](#))
- Touch Pad** ([page 118](#))
- Keyboard** ([page 119](#))
- Floppy Disks** ([page 120](#))
- Audio/Video** ([page 121](#))
- Memory Stick** ([page 122](#))
- Peripherals** ([page 123](#))

Computer

What should I do if my computer does not start?

- ❑ Make sure your computer is securely plugged into a power source and turned on and the power indicator light is lit.
- ❑ Make sure the battery pack is installed properly and charged.
- ❑ Disconnect all connected USB devices (if any), and then restart your computer.
- ❑ If your computer is plugged into a power strip or an uninterruptible power supply (UPS), make sure the power strip or UPS is plugged into a power source and turned on.
- ❑ If you are using an external display, make sure it is plugged into a power source and turned on. Make sure the brightness and contrast controls are adjusted correctly. See the manual that came with your display for more information.
- ❑ Unplug the AC adapter and remove the battery pack. Wait three to five minutes. Reinstall the battery pack, plug the AC adapter, and then slide the power switch (in the direction of ▷ on the switch) to turn on your computer.
- ❑ Condensation may cause your computer to malfunction. If this occurs, do not use the computer for at least one hour.
- ❑ Check that you are using the supplied Sony AC adapter. For your safety, use only the genuine Sony rechargeable battery pack and AC adapter, which are supplied by Sony for your VAIO computer.

What should I do if the green power indicator light turns on but my screen remains blank?

- ❑ Press the **Alt+F4** keys several times to close the application window. An application error may have occurred.
- ❑ If the **Alt+F4** keys do not work, click **Start, Turn Off Computer**, and then **Restart**.
- ❑ If your computer does not restart, press the **Ctrl+Alt+Delete** keys and select **Restart** from the **Shut Down** menu.
- ❑ If this procedure does not work, slide (in the direction of ▷ on the switch) and hold the power switch for more than four seconds to shut down your computer. Unplug the AC adapter and leave the computer for about five minutes. Then plug the AC adapter and turn on the computer again.

! Turning off your computer with the **Ctrl+Alt+Delete** keys or the power switch may cause loss of unsaved data.

What should I do if my computer or software stops responding?

- ❑ If your computer stops responding while a software application is running, press the **Alt+F4** keys to close the application window.
- ❑ If the **Alt+F4** keys do not work, click **Start, Turn Off Computer**, and then **Turn Off**.
- ❑ If your computer does not turn off, press the **Ctrl+Alt+Delete** keys and select **Turn Off** from the **Shut Down** menu.
- ❑ If this procedure does not work, slide (in the direction of ▷ on the switch) and hold the power switch until the computer turns off.

! Turning off your computer with the **Ctrl+Alt+Delete** keys or the power switch may cause loss of unsaved data.

- ❑ Unplug the AC adapter and remove the battery pack. Wait three to five minutes. Reinstall the battery pack, plug the AC adapter, and then slide the power switch (in the direction of ▷ on the switch) to turn on your computer.
- ❑ Try reinstalling the software.
- ❑ Contact the software publisher or designated provider for technical support.

Why doesn't my computer enter Standby or Hibernate mode?

Your computer may become unstable if the operating mode is changed before the computer completely enters Standby or Hibernate mode.

To restore your computer to Normal mode

- 1 Close all open programs.
- 2 Click **Start, Turn Off Computer**, and then **Restart**.
- 3 If your computer does not restart, press the **Ctrl+Alt+Delete** keys and select **Restart** from the **Shut Down** menu.
- 4 If this procedure does not work, slide (in the direction of ▶ on the switch) and hold the power switch until the computer turns off.

! Turning off your computer with the **Ctrl+Alt+Delete** keys or the power switch may cause loss of unsaved data.

What should I do if the charge indicator light is blinking fast and my computer does not start?

- ❑ This problem could be due to the battery pack not being installed properly. To resolve this problem, turn off your computer and remove the battery pack. Then reinstall the battery pack to the computer. For details, see **Installing the Battery Pack (page 18)**.
- ❑ If the problem persists after performing the above, it means the installed battery pack is not compatible. Remove the battery pack and contact VAIO-Link.

What should I do if a message appears notifying of either incompatibility or the improper installation of the battery pack and my computer then enters Hibernate mode?

- ❑ This problem could be due to the battery pack not being installed properly. To resolve this problem, turn off your computer and remove the battery pack. Then reinstall the battery pack to the computer. For details, see **Installing the Battery Pack (page 18)**.
- ❑ If the problem persists after performing the above, it means the installed battery pack is not compatible. Remove the battery pack and contact VAIO-Link.

Why does the System Properties window display a slower CPU speed than the maximum?

This is normal. Because your computer's CPU utilizes a type of CPU speed controlling technology for power conservation purposes, System Properties may display the current CPU speed instead of the maximum speed.

What should I do if my computer does not accept my password and returns a message, Enter Onetime Password?

If you enter a wrong power-on password three times consecutively, the **Enter Onetime Password** message appears and Windows will not start. Slide (in the direction of ▷ on the switch) and hold the power switch for more than four seconds to check that the power indicator light turns off. Wait for 10 or 15 seconds, then restart your computer and enter the correct password. When entering the password, check that the Num lock and Caps lock indicator lights are unlit. If both or either of the lights is lit, press the **Num Lk** (or **Num Lock**) key or the **Caps Lock** key to turn off the indicator light before entering the password.

What should I do if my game software does not work or it keeps crashing?

- ❑ Check the web site of the game if there are any patches or updates to download.
- ❑ Make sure you have installed the latest video driver software.
- ❑ On some VAIO models, the graphics memory is shared with the system. The optimal graphic performance in such a case is not guaranteed.

What should I do if I cannot remember the power-on password?

If you have forgotten the power-on password, contact VAIO-Link to reset it. A reset fee will be charged.

How can I change the boot device order?

You can use one of the BIOS functions to change the boot device order. Follow these steps:

- 1 Turn on your computer.
- 2 Press the **F2** key when the VAIO logo appears.
The BIOS setup screen appears. If not, restart the computer and press the **F2** key several times when the VAIO logo appears.
- 3 Press the **←** or **→** key to select **Boot**.
- 4 Press the **↑** or **↓** key to select the drive whose boot device order you want to change.
- 5 Press the **F5** or **F6** key to change the boot device order.
- 6 Press the **←** or **→** key to select **Exit**, select **Exit Setup**, and then press the **Enter** key.
At the confirmation prompt, press the **Enter** key.

Why doesn't my screen turn off after the automatic turn-off time has passed?

The VAIO original screen saver disables the timer setting, which you can select using the Windows power options, for your screen to turn off.

Select a screen saver other than the VAIO original screen saver.

What should I do if I cannot boot my computer from the external device connected to the computer?

To boot your computer from the external device, for example the USB floppy disk drive or the USB optical disc drive, you need to change the boot device.

Turn on your computer and press the **F11** key when the VAIO logo appears.

How do I check the volume of the recovery partition?

Your built-in storage device contains the recovery partition where the data for the system recovery is stored. To check the volume of the recovery partition, follow these steps:

- 1 Click **Start**, right-click **My Computer**, and select **Manage**.
The **Computer Management** window appears.
- 2 Click **Disk Management** under **Storage** in the left pane.
The volume of the recovery partition and the total volume of the C drive are displayed in the **Disk 0** row in the center pane.

System Security

How can I protect my computer against security threats, such as viruses?

The Microsoft Windows operating system is preinstalled on your computer. The best way to protect your computer against security threats, such as viruses, is to download and install the latest Windows updates regularly.

You can get important Windows updates by using the update feature or visiting the designated web site.

- ❑ The **Automatic Updates** feature — This feature automatically searches for and delivers updates directly to your computer whenever it is connected to the Internet.
- ❑ The Windows Updates web site — This site enables you to download computer updates without turning on the **Automatic Updates** feature.



Your computer must be connected to the Internet to download the updates.

To use the Automatic Updates feature

- 1 Connect to the Internet.
- 2 Click the **Automatic Updates** icon on the taskbar.
- 3 Follow the on-screen instructions to set up automatic or scheduled updates.

To visit the Windows Updates web site

- 1 Connect to the Internet.
- 2 Type <http://windowsupdate.microsoft.com/> in the address bar of your browser. The **Microsoft Windows Update** and **Security Warning** windows appear.
- 3 In the **Security Warning** window, start installation and run **Windows Update**.
- 4 In the **Microsoft Windows Update** window, select an installation type, and follow the on-screen instructions.

How do I keep my antivirus software updated?

You can keep the **McAfee** software program current with the latest updates from McAfee, Inc. To download and install the latest security updates, follow these steps:

! Your computer must be connected to the Internet to download the updates.

- 1 Click **Start**, point to **All Programs** and **McAfee**, and then click **McAfee SecurityCenter**.
- 2 Click the button located at the upper left corner of the window to update the software.
- 3 Follow the on-screen instructions to download updates.

See the help file included with your software program for more information.

Battery

How do I find the battery charging status?

You can check the charge indicator for the battery charging status. See **Charging the Battery Pack (page 21)** for more information.

When is my computer using AC power?

When your computer is connected to an AC outlet with the AC adapter, it uses AC power, even if the battery pack is installed.

When should I recharge the battery pack?

- When the battery charge level falls below 10%.
- When both the charge and power indicator lights blink.
- When you have not used the battery pack for a long period of time.

When should I replace the battery pack?

If the battery pack quickly runs out of power after fully charged, it may be reaching the end of its life and should be replaced.

Should I be concerned that the installed battery pack is warm?

No, it is normal for the battery pack to be warm when it is powering your computer.

Can my computer enter Hibernate mode while using battery power?

Your computer can enter Hibernate mode while using battery power, but some software programs and peripheral devices prevent the system from entering Hibernate mode. If you are using a program that prevents the system from entering Hibernate mode, save your data frequently to avoid losing data. See **Using Hibernate Mode (page 77)** for information on how you can manually activate Hibernate mode.

Why doesn't my computer enter Hibernate mode?

You may first need to enable Hibernate mode. Follow these steps:

- 1 Click **Start** and then **Control Panel**.
- 2 Click **Performance and Maintenance**.
- 3 Click **Power Options**.
The **Power Options Properties** window appears.
- 4 Select the **Hibernate** tab.
- 5 Click to select the check box next to **Enable hibernation**.

Built-in Camera

Why does the viewfinder show no images or poor-quality images?

- ❑ The built-in camera cannot be shared by more than one software application. Exit the current application before launching another.
- ❑ The viewfinder may show some noise, for example horizontal streaks, when you are viewing a rapid-moving object. This is normal and does not indicate a malfunction.
- ❑ If the problem persists, restart your computer.

Why are captured images poor in quality?

- ❑ The images captured under the fluorescent light may show reflections of light.
- ❑ A dark portion in captured images may appear as a noise.
- ❑ If the lens protection cover is dirty, you cannot take a clear shot. Clean the cover. See **Handling the Built-in Camera (page 87)**.

What should I do if captured images contain dropped frames and audio interruptions?

- ❑ The effect settings on your software application may cause dropped frames. See the help file included with your software application for more information.
- ❑ There may be more software applications running than your computer can handle. Exit the applications that you are not currently using.
- ❑ The power management function of your computer may be active. Check the CPU performance.

What should I do if movie playback shows dropped frames when my computer is running on the battery?

The battery pack is running out of power. Connect your computer to an AC outlet.

What should I do if captured images flicker?

This problem occurs when you use the camera under fluorescent lights due to a mismatch between the lighting output frequency and the shutter speed.

To reduce flicker noise, change the direction of the camera or the brightness of camera images. In some software applications, you can set an appropriate value to one of the camera properties (e.g. light source, flicker, etc.) to eliminate flicker noise.

Why is the video input from the built-in camera suspended for a few seconds?

The video input may be suspended for a few seconds if:

- a shortcut key with the **Fn** key is used.
- the CPU load increases.

This is normal and does not indicate a malfunction.

What should I do if my computer becomes unstable when it enters a power saving mode while the built-in camera is in use?

If your computer automatically enters Standby or Hibernate mode, change the corresponding power saving mode setting. To change the setting, see **Using the Power Saving Modes (page 74)**.

Networking

What should I do if my computer cannot connect to a wireless LAN access point?

- Connection capability is affected by distance and obstructions. You may need to move your computer away from obstructions or closer to any access point you may be using.
- Make sure the **WIRELESS** switch is on and the **WIRELESS** indicator light is lit on your computer.
- Make sure power to the access point is on.
- Follow these steps to check the settings:
 - 1 Click **Start** and then **Control Panel**.
 - 2 Click **Network and Internet Connections**.
 - 3 Click **Network Connections**.
 - 4 Right-click **Wireless Network Connection**.
 - 5 Click **Properties**.
 - 6 Click the **Wireless Networks** tab.
 - 7 Click **View Wireless Networks** to see that your access point is selected.
- Make sure the encryption key is correct.

What should I do if I cannot access the Internet?

- Check the access point settings. See the manual that came with your access point for more information.
- Make sure your computer and the access point are connected to one another.
- Move your computer away from obstacles or closer to any access point you may be using.
- Make sure your computer is properly configured for Internet access.

Why is the data transfer speed slow?

- ❑ The wireless LAN data transfer speed is affected by distance and obstructions between devices and access points. Other factors include device configurations, radio conditions, and software compatibility. To maximize the data transfer speed, move your computer away from obstacles or closer to any access point you may be using.
- ❑ If you are using a wireless LAN access point, the device may be temporarily overloaded depending on how many other devices are communicating via the access point.
- ❑ If your access point interferes with other access points, change the access point channel. See the manual that came with your access point for more information.

How do I avoid data transfer interruptions?

- ❑ When your computer is connected to an access point, data transfer interruptions may occur if a large file is exchanged or the computer is placed in close proximity to microwaves and cordless telephones.
- ❑ Move your computer closer to the access point.
- ❑ Make sure the access point connection is intact.
- ❑ Change the access point channel. See the manual that came with your access point for more information.

What are channels?

- ❑ Wireless LAN communication uses divided frequency bands known as channels. Third-party wireless LAN access point channels may be preset to different channels from Sony devices.
- ❑ If you are using a wireless LAN access point, see connectivity information contained in the manual that came with your access point.

Why does the network connection stop when I change the encryption key?

Two computers with the wireless LAN function may lose a peer-to-peer network connection if the encryption key is changed. You can either change the encryption key back to the original profile or re-enter the key on both computers so the key matches.

Bluetooth Technology

What should I do if other Bluetooth devices cannot find my computer?

- ❑ Make sure both devices have the Bluetooth function enabled.
- ❑ Make sure the **WIRELESS** switch is on and the **WIRELESS** indicator light is lit on your computer.
- ❑ You cannot use the Bluetooth function when your computer is in a power saving mode. Bring the computer back to Normal mode, then turn on the **WIRELESS** switch.
- ❑ Your computer and the device may be too far apart. Wireless Bluetooth technology works best when the devices are within 10 meters of each other.

What should I do if I cannot find the Bluetooth device I want to communicate with?

- ❑ Check that the Bluetooth function of the device you want to communicate with is on. See the other device's manual for more information.
- ❑ If the device you want to communicate with is already communicating with another Bluetooth device, it may not be found or it may not be able to communicate with your computer.
- ❑ To allow other Bluetooth devices to communicate with your computer, follow these steps:
 - 1 Right-click the Bluetooth icon  on the taskbar and select **Bluetooth Configuration** from the menu.
 - 2 Click to select the **Let other Bluetooth devices discover this computer** check box on the **Accessibility** page in the **Bluetooth Configuration** window.
 - 3 Click **OK**.

What should I do if other Bluetooth devices cannot connect to my computer?

- ❑ Check the suggestions in **What should I do if I cannot find the Bluetooth device I want to communicate with?** (page 109).
- ❑ Make sure the other devices are authenticated.
- ❑ The data transfer distance can be shorter than 10 meters depending on existing obstacles between the two devices, on radio wave quality, and on the operating system or the software in use. Move your computer and Bluetooth devices closer to each other.

Why is my Bluetooth connection slow?

- ❑ The data transfer speed depends on the obstructions and/or the distance between the two devices, on the radio wave quality, and on the operating system or the software in use. Move your computer and Bluetooth devices closer to each other.
- ❑ The 2.4 GHz radio frequency used by Bluetooth and wireless LAN devices is also used by other devices. Bluetooth devices incorporate technology that minimizes interference from other devices using the same wavelength, however, communication speed and connection range may be reduced. Interference from other devices may also stop communications altogether.
- ❑ Connection capability is affected by distance and obstructions. You may need to move your computer away from obstacles or closer to the device to which it is connected.
- ❑ Identify and remove obstacles between your computer and the device to which it is connected.

Why can't I use the services supported by the connected Bluetooth device?

Connection is only possible for services also supported by the computer with the Bluetooth function. For more details, search **Help and Support Center** for Bluetooth information.

Can I use a device with Bluetooth technology on airplanes?

With Bluetooth technology, your computer transmits a radio frequency of 2.4 GHz. Sensitive locations, such as hospitals and airplanes, may have restrictions on use of Bluetooth devices to avoid radio interference. Check with facility staff to see if use of the Bluetooth function on the computer is permitted.

Why can't I use the Bluetooth function when I log onto my computer as a user with a standard user account?

The Bluetooth function may not be available to a user with a standard user account on your computer. Log onto the computer as a user with administrative rights.

Why can't I use the Bluetooth devices when I switch users?

If you switch users without logging off your system, the Bluetooth devices will not work. Be sure to log off before switching users. To log off from your system, click **Start** and then **Log Off**.

Why can't I exchange business card data with a mobile phone?

The business card exchange function is not supported.

Display

Why did my screen go blank?

- ❑ Your computer screen may go blank if the computer loses power or enters a power saving mode (Standby or Hibernate). If the computer is in LCD (Video) Standby mode, press any key to bring the computer back into Normal mode. See **Using the Power Saving Modes (page 74)** for more information.
- ❑ Make sure your computer is securely plugged into a power source and turned on and the power indicator light is lit.
- ❑ If your computer is using battery power, make sure the battery pack is installed properly and is charged. See **Using the Battery Pack (page 18)** for more information.
- ❑ If the display output is directed to the external display, press the **Fn+F7** keys. See **Combinations and Functions with the Fn Key (page 27)** for more information.

What should I do if I do not see proper images or videos?

Do not change the display resolution or colors while using video/image software or playing DVDs, as it may cause unsuccessful playback/display or unstable system operations.

Additionally, it is recommended you disable your screen saver before starting DVD playback. If the screen saver is enabled, it may be activated during DVD playback and prevent the playback from running successfully. Some screen savers have been found to even change the display resolution and colors.

Why doesn't my screen display a video?

- ❑ If the display output is directed to the external display and the external display is disconnected, you cannot display a video on your computer screen. Stop video playback, change the display output to the computer screen, and then restart video playback. See **Selecting Display Modes (page 61)** for changing the display output. Alternatively, you can press the **Fn+F7** keys to change the display output. See **Combinations and Functions with the Fn Key (page 27)** for more information.
- ❑ The video memory of your computer may be insufficient for displaying high resolution videos. In such a case, lower the resolution of the LCD screen.

To change the screen resolution, follow these steps:

- 1 Right-click on the desktop to display the context menu.
- 2 Click the menu item for properties.
- 3 Click the **Settings** tab.
- 4 Move the slider under **Screen resolution** to the left to reduce or to the right to increase the screen resolution.



You can check the total amount of the graphics and video memory available. Right-click on the desktop, click the menu item for properties, the **Settings** tab, **Advanced**, and then the **Adaptor** tab. The displayed value may be different from the actual amount of memory on your computer.

What should I do if my screen is dark?

Press the **Fn+F6** keys to brighten your computer screen.

What should I do if the LCD brightness of my screen changes?

The LCD brightness setting, adjusted with the **Fn+F5/F6** keys, is temporary and may be restored to the original setting when your computer returns to Normal mode from Standby or Hibernate mode. To save your preference for the brightness, follow these steps:



To do the following procedure, you must have administrator rights on your computer.

- 1 Click **Start** and then **Control Panel**.
- 2 Click **Performance and Maintenance**.
- 3 Click **Power Options**.
- 4 Select the tab for power scheme settings.
- 5 Select the desired power scheme from the drop-down list.
- 6 On the **VAIO Power Management** tab, select **No change** for **LCD Brightness**.
- 7 Click **OK**.

The preference for the LCD brightness adjusted with the **Fn+F5/F6** keys is saved and the brightness of your computer screen remains unchanged regardless of operating conditions.

Printing

What should I do if I cannot print a document?

- ❑ Make sure your printer is on, and the printer cable is securely connected to the ports on the printer and your computer.
- ❑ Make sure your printer is compatible with the Windows operating system installed on your computer.
- ❑ You may need to install the printer driver software before you use your printer. See the manual that came with your printer for more information.
- ❑ If your printer is not functioning after your computer resumes from a power saving mode (Standby or Hibernate), then restart the computer.
- ❑ If the bidirectional communication functions are provided with your printer, disabling the functions on your computer may enable printing. Follow these steps:
 - 1 Click **Start** and then **Control Panel**.
 - 2 Click **Printers and Other Hardware**.
 - 3 Click **Printers and Faxes**.
 - 4 Right-click the printer icon and select **Properties**.
 - 5 Click the **Ports** tab.
 - 6 Click to cancel the **Enable bidirectional support** check box.
 - 7 Click **OK**.

This disables the bidirectional communication functions of the printer, such as data transfer, status monitoring, and remote panel.

Microphone

What should I do if my microphone does not work?

- If you are using an external microphone, make sure the microphone is turned on and is properly plugged into the microphone jack on your computer.
- Make sure that the appropriate device is selected as the default recording device.
- Check if your microphone volume is not turned off or minimized.

How can I prevent microphone feedback?

Microphone feedback occurs when the microphone receives the sound from a sound output device, such as a speaker.

To prevent this problem:

- Keep the microphone away from a sound output device.
- Turn down the volume of the speakers and the microphone.

Speakers

What should I do if I do not hear sound from the built-in speakers?

- If you are using a program that has its own volume control, make sure the volume control is properly set. See the program's help file for more information.
- The volume may have been turned off by the **Fn+F2** keys. Press them once again.
- The volume may have been minimized by the **Fn+F3** keys. Keep pressing the **Fn+F4** keys to turn up the volume loud enough to hear sound.
- Check the Windows volume controls by clicking the volume icon on the taskbar.
- Your sound output device may have been incorrectly configured. To change the sound output device, see **How do I change the sound output device? (page 121)**.

What should I do if my external speakers do not work?

- Check the suggestions in **What should I do if I do not hear sound from the built-in speakers? (page 117)**.
- Make sure your speakers are properly connected and the volume is turned up loud enough to hear sound.
- Make sure your speakers are designed for computer use.
- If your speakers have a muting button, set the button to off.
- If your speakers require external power, make sure the speakers are connected to a power source. See the manual that came with your speakers for more information.

Touch Pad

What should I do if the touch pad does not work?

- ❑ You may have disabled the touch pad before connecting a mouse to your computer. See **Using the Touch Pad (page 28)**.
- ❑ Make sure that a mouse is not connected to your computer.
- ❑ If the pointer does not move while a software application is running, press the **Alt+F4** keys to close the application window.
- ❑ If the **Alt+F4** keys do not work, click **Start, Turn Off Computer**, and then **Restart**.
- ❑ If your computer does not restart, press the **Ctrl+Alt+Delete** keys and select **Restart** from the **Shut Down** menu.
- ❑ If this procedure does not work, slide (in the direction of ► on the switch) and hold the power switch until the computer turns off.

! Turning off your computer with the **Ctrl+Alt+Delete** keys or the power switch may cause loss of unsaved data.

Keyboard

What should I do if the keyboard configuration is wrong?

The language layout of your computer's keyboard is labeled on the packaging box. If you choose a different regional keyboard when you complete the Windows setup, the key configuration will be mismatched.

To change the keyboard configuration, follow these steps:

- 1 Click **Start** and then **Control Panel**.
- 2 Click **Date, Time, Language and Regional Options**, and click **Regional and Language Options**.
- 3 Change the settings as desired.

What should I do if I cannot enter certain characters with the keyboard?

If you cannot enter **U, I, O, P, J, K, L, M**, and so on, the **Num Lk** key may be activated. Check that the Num lock indicator light is unlit. If the Num lock indicator is lit, press the **Num Lk** key to turn it off before entering these characters.

Floppy Disks

Why doesn't the Safely Remove Hardware icon appear on the taskbar when the drive is connected?

Your computer does not recognize the floppy disk drive. First, make sure the USB cable is properly connected to the USB port. If you need to secure the connection, wait a few moments for the computer to recognize the drive. If the icon still does not appear, follow these steps:

- 1 Close all programs that are accessing the floppy disk drive.
- 2 Wait until the indicator light on the floppy disk drive turns off.
- 3 Push the eject button to remove the disk, and unplug the USB floppy disk drive from your computer.
- 4 Reconnect the floppy disk drive by plugging the USB cable into the USB port.
- 5 Restart the computer by clicking **Start, Turn Off Computer**, and then **Restart**.

What should I do if I cannot write data to a floppy disk?

- Make sure the floppy disk is properly inserted in the drive.
- If the disk is inserted properly and you are still unable to write data to it, the disk may be full or write-protected. You can either use a floppy disk that is not write-protected or disable the write-protect feature.

Audio/Video

How do I change the sound output device?

If you do not hear sound from the device connected to a port, such as the USB port, HDMI output port, optical output port, or headphones jack, you need to change the device for sound output.

- 1 Close all open programs.
- 2 Click **Start** and **Control Panel**.
- 3 Click **Sounds, Speech, and Audio Devices**.
- 4 Click **Sounds and Audio Devices**.
- 5 On the **Audio** tab, select the desired device for sound playback from the list box.

What should I do if I do not hear the sound from the sound output device connected to the HDMI output port, optical output port, or headphones jack?

You need to change the sound output device if you want to hear sound from the device connected to a port, such as the HDMI output port, optical output port, or headphones jack. For the detailed procedure, see **How do I change the sound output device?** ([page 121](#)).

Why do sound interruptions and/or dropped frames occur when I play high-definition videos, such as those recorded with the AVCHD digital video camcorder?

Playing high-definition videos requires substantial hardware resources, such as CPU, GPU, or system memory performance on your computer. During the video playback, some operations and/or functions may become unavailable, and sound interruptions, dropped frames, and playback failure may occur depending on the configuration of your computer.

Memory Stick

What should I do if I cannot use a Memory Stick that was formatted on a VAIO computer on other devices?

You may need to reformat your Memory Stick.

Formatting a Memory Stick erases all data, including music data previously saved on it. Before you reformat a Memory Stick, back up important data and confirm that the Memory Stick does not contain files you want to keep.

- 1 Copy the data from the Memory Stick onto your built-in storage device to save data or images.
- 2 Format the Memory Stick by following the steps in **Formatting a Memory Stick (page 33)**.

Can I copy images from a digital camera using a Memory Stick?

Yes, and you can view video clips that you have recorded with Memory Stick-compatible digital cameras.

Why can't I write data to a Memory Stick?

Some versions of the Memory Stick are equipped with an erasure prevention switch to protect data from unintentional erasure or overwriting. Make sure the erasure prevention switch is off.

Peripherals

What should I do if I cannot connect a USB device?

- ❑ If applicable, check the USB device is turned on and using its own power supply. For example, if you are using a digital camera, check if the battery is charged. If you are using a printer, check if the power cable is connected properly to the AC outlet.
- ❑ Try using another USB port on your computer. The driver software could be installed to the specific port you used the first time you connected the device.
- ❑ See the manual that came with your USB device for more information. You may need to install software before you connect the device.
- ❑ Try connecting a simple, low-powered device such as a mouse to test if the port is working at all.
- ❑ USB hubs may prevent a device from working because of a power distribution failure. We recommend you connect the device directly to your computer without a hub.

Trademarks

Sony, VAIO, the VAIO logo, VAIO Control Center, VAIO Power Management, VAIO Power Management Viewer, VAIO Update, and "BRAVIA" are trademarks or registered trademarks of Sony Corporation.



and "Memory Stick," "Memory Stick Duo," "MagicGate," "OpenMG," "MagicGate Memory Stick," "Memory Stick PRO," "Memory Stick PRO-HG," "Memory Stick Micro," "M2," and the Memory Stick logo are trademarks or registered trademarks of Sony Corporation.

Walkman is a registered trademark of Sony Corporation.

Blu-ray Disc™ and the Blu-ray Disc logo are trademarks of the Blu-ray Disc Association.

Intel, Pentium, Intel SpeedStep, and Atom are trademarks or registered trademarks of Intel Corporation.

Microsoft Windows XP, Microsoft Windows Vista, the Windows logo, and BitLocker are trademarks or registered trademarks of Microsoft Corporation in the U.S. and other countries.

i.LINK is a trademark of Sony used only to designate that a product contains an IEEE 1394 connection.

Roxio Easy Media Creator is a trademark of Sonic Solutions.

WinDVD for VAIO and WinDVD BD for VAIO are trademarks of InterVideo, Inc.

ArcSoft and the ArcSoft logo are registered trademarks of ArcSoft, Inc. ArcSoft WebCam Companion is a trademark of ArcSoft, Inc.

ATI and ATI Catalyst are trademarks of Advanced Micro Devices, Inc.

The Bluetooth word mark and logos are registered trademarks owned by Bluetooth SIG, Inc. and any use of such marks by Sony Corporation is under license. Other trademarks and trade names are those of their respective owners.

The ExpressCard word mark and logos are owned by the PCMCIA and any use of such marks by Sony Corporation is under license. Other trademarks and trade names are those of their respective owners.

SD Logo is a trademark. 

SDHC Logo is a trademark. 

CompactFlash® is a trademark of SanDisk Corporation.

MultiMediaCard™ is a trademark of MultiMediaCard Association.

HDMI, the HDMI logo and High-Definition Multimedia Interface are trademarks or registered trademarks of HDMI Licensing LLC.

"PlaceEngine" is a registered trademark of Koozyt, Inc.

"PlaceEngine" was developed by Sony Computer Science Laboratories, Inc. and is licensed by Koozyt, Inc.

, "XMB," and "xross media bar" are trademarks of Sony Corporation and Sony Computer Entertainment Inc.

"AVCHD" is a trademark of Panasonic Corporation and Sony Corporation.

All other names of systems, products, and services are trademarks of their respective owners. In the manual, the ™ or ® marks are not specified.

Specifications are subject to change without notice. All other trademarks are trademarks of their respective owners.

Not all the software listed above may be delivered with your model.

See the online specifications to find out what software is available for your model.

Notice

© 2009 Sony Corporation. All rights reserved.

This manual and the software described herein, in whole or in part, may not be reproduced, translated, or reduced to any machine-readable form without prior written approval.

Sony Corporation provides no warranty with regard to this manual, the software, or other information contained herein and hereby expressly disclaims any implied warranties or merchantability or fitness for any particular purpose with regard to this manual, the software, or such other information. In no event shall Sony Corporation be liable for any incidental, consequential, or special damages, whether based on tort, contract, or otherwise, arising out of or in connection with this manual, the software, or other information contained herein or the use thereof.

In the manual, the ™ or ® marks are not specified.

Sony Corporation reserves the right to make any modification to this manual or the information contained herein at any time without notice. The software described herein is governed by the terms of a separate user license agreement.

Sony Corporation is not liable and will not compensate for any lost recordings made to your computer, external recording media, or recording devices or any relevant losses, including when recordings are not made due to reasons including your computer failure, or when the contents of a recording are lost or damaged as a result of your computer failure or repair undertaken to your computer. Sony Corporation will not restore, recover, or replicate the recorded contents made to your computer, external recording media, or recording devices under any circumstances.

