

SONY[®]

User Guide

Personal Computer
VPCL2 Series



Contents

Before Use.....	4	Using Other Modules / Memory Cards	72
Finding More about Your VAIO Computer	5	Using the Internet	76
Ergonomic Considerations	8	Using the Network (LAN).....	77
Getting Started.....	10	Using the Wireless LAN.....	78
Locating Controls and Ports.....	11	Using the BLUETOOTH Function.....	83
About the Indicator Lights	17	Using Peripheral Devices.....	88
Setting Up Your Computer	18	Connecting External Speakers or Headphones	89
Shutting Down Your Computer Safely	20	Connecting an External Display	90
Using the Power Saving Mode.....	21	Selecting Display Modes	97
Keeping Your Computer in Optimum Condition	24	Using the Multiple Monitors Function	98
Using Your VAIO Computer.....	27	Connecting an External Microphone	100
Using the Keyboard.....	28	Connecting a USB Device	101
Using the Mouse	35	Connecting an i.LINK Device.....	103
Using the Touch Screen.....	40	Customizing Your VAIO Computer.....	105
Using the Edge Access	44	Setting the Password.....	106
Using Special-function Buttons	45	Using the VAIO Control Center	112
Using the Quick Web Access Function	47	Upgrading Your VAIO Computer.....	115
Using the Built-in Camera	49	Adding and Removing Memory	116
Using the Optical Disc Drive	50		
Using the 3D Function.....	58		
Using the HDMI/VIDEO Input Function.....	60		
Using "Memory Stick"	65		

Precautions.....	122	Touch Screen	168
Safety Information.....	123	Keyboard	169
Care and Maintenance Information.....	125	Floppy Disks	170
Handling Your Computer.....	126	Audio/Video	171
Handling the LCD Screen/Touch Screen	128	HDMI/VIDEO Input Function	174
Using the Power Source	129	"Memory Stick"	175
Handling the Built-in Camera	130	Peripherals	176
Handling Discs	131	About the International ENERGY STAR(R) Program.....	177
Handling "Memory Stick".....	132	Trademarks	178
Handling the Built-in Storage Device	133	Notice	180
Troubleshooting	134		
Computer Operations.....	136		
System Update / Security.....	141		
Recovery / Recovery Media	142		
Partition	143		
Built-in Camera	144		
Networking (LAN/Wireless LAN)	146		
BLUETOOTH Technology.....	150		
Optical Discs	153		
Display	158		
Printing.....	162		
Microphone	163		
Mouse	164		
Speakers	166		

Before Use

Congratulations on your purchase of this VAIO® computer and welcome to the on-screen **User Guide**. Sony has combined leading-edge technology in audio, video, computing, and communications to provide you with a state-of-the-art computing experience.



External views illustrated in this manual may look slightly different from those of your computer.



How to find specifications

Some features, options, and supplied items may not be available on your computer.

To find out about the configuration of your computer, visit the VAIO Support web site at <http://support.vaio.sony.eu/>.

Finding More about Your VAIO Computer

This section provides support information about your VAIO computer.

1. Printed Documentation

- ❑ **Quick Start Guide** — An overview of components connection, set-up information, etc.
- ❑ **Recovery, Backup and Troubleshooting Guide**
- ❑ **Enjoying 3D: Information Guide** (On selected models only)
- ❑ **Safety Regulations and Support Information**



Before activating the wireless functions such as the wireless LAN and BLUETOOTH technology, read the **Safety Regulations and Support Information** carefully.

2. On-screen Documentation

- ❑ **VAIO User Guide** — General information of your VAIO computer including support and troubleshooting information.

To access **VAIO User Guide**, click **Start** , **All Programs**, and **VAIO Manual**.

- ❑ **Windows Help and Support** — A comprehensive resource for practical advice, tutorials, and demonstrations to help you learn to use your computer.

To access **Windows Help and Support**, click **Start** and **Help and Support**, or press and hold the Microsoft Windows key and press the **F1** key.

3. Support Web Sites

If you experience any problem with your VAIO computer, launch the **VAIO Care**, which offers you various options to help you solve most problems. For details, see **Using the VAIO Care (page 26)**.

If you need more assistance, visit the VAIO Support web site at <http://support.vaio.sony.eu/>.

When you contact VAIO Support, you will be asked for the serial number of the computer.

The serial number is a 15-digit number that can be found at the bottom of the **VAIO Care** window; on the bottom or the back panel of the computer; or inside the battery compartment.

Other sources for information about the VAIO computer are:

- ❑ The VAIO Forum at http://www.sony.eu/discussions/community/en/support/vaio_and_computing/, which enables you to interact with other VAIO users in VAIO social community.
- ❑ The VAIO web site at <http://www.vaio.eu/>, which offers product information
- ❑ Sony Store, Online at <http://www.sony.eu/store>

Ergonomic Considerations

Whenever possible, you should attempt to take account of the following ergonomic considerations:

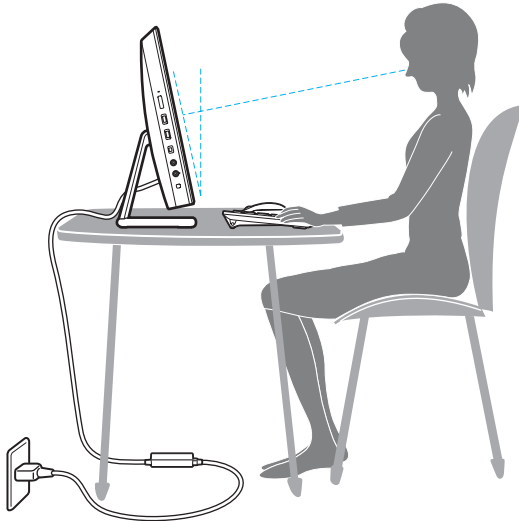

- ❑ **Position of your computer** – Place the display directly in front of you. Keep your forearms horizontal, with your wrists in a neutral, comfortable position while using the keyboard or the pointing device. Let your upper arms hang naturally at your sides. Take frequent breaks while using your computer. Excessive use of the computer may strain eyes, muscles, or tendons.
- ❑ **Furniture and posture** – Sit in a chair with good back support. Adjust the level of the chair so your feet are flat on the floor. A footrest may make you more comfortable. Sit in a relaxed, upright posture and avoid slouching forward or leaning far backwards.

- ❑ **Viewing angle of the computer display** – Use the display tilting feature to find the best position. You can reduce eye strain and muscle fatigue by adjusting the tilt of the display to the proper position. Adjust the brightness level of the display as well.

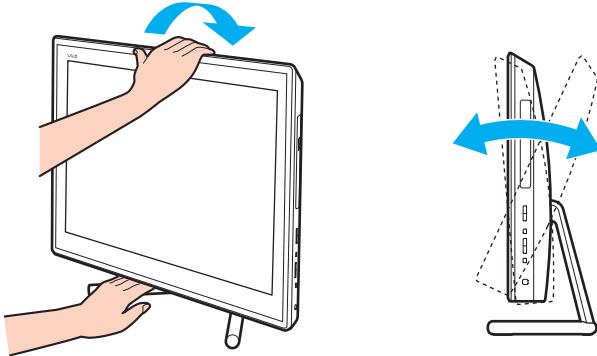

You can tilt the computer display within the range from about -5 to +25 degrees.

! While adjusting the viewing angle, do not exert excessive pressure on your computer to eliminate a risk of mechanical damage.

- ❑ **Lighting** – Choose a location where windows and lights do not cause glare and reflection on the display. Use indirect lighting to avoid bright spots on the display. Proper lighting adds to your comfort and work efficiency.
- ❑ **Ventilation** – Make sure you leave at least 10 cm of space behind and at least 20 cm of space on each side of the main unit.

Getting Started

This section describes how to get started using your VAIO computer.

! Before starting your computer for the first time, do not connect any other hardware that did not originally come with your computer. Upon completion, connect one device (for example, a printer, an external hard disk drive, a scanner, and so on) at a time, following the manufacturer's instructions.

- Locating Controls and Ports** ([page 11](#))
- About the Indicator Lights** ([page 17](#))
- Setting Up Your Computer** ([page 18](#))
- Shutting Down Your Computer Safely** ([page 20](#))
- Using the Power Saving Mode** ([page 21](#))
- Keeping Your Computer in Optimum Condition** ([page 24](#))

Locating Controls and Ports

Take a moment to identify the controls and ports shown on the following pages.

! The appearance of your computer may be different from those illustrated in this manual due to variations in specifications.

Front

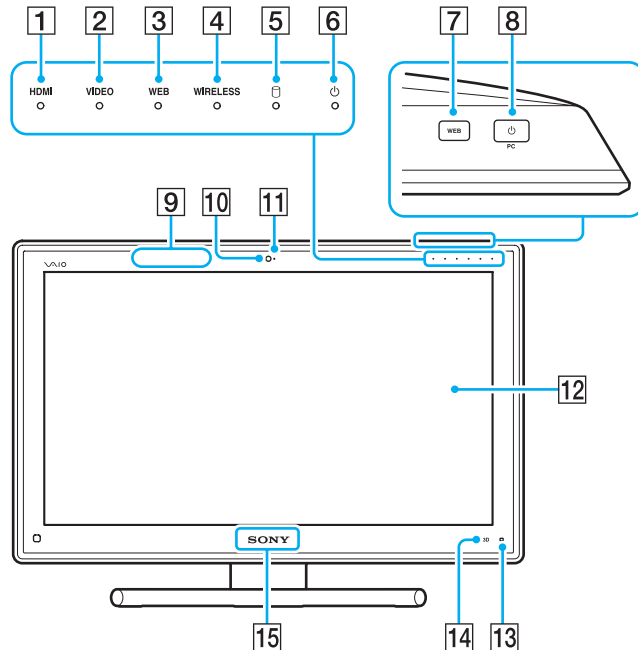

- 1 **HDMI** input indicator (page 17)
- 2 **VIDEO** input indicator (page 17)
- 3 **WEB** indicator (page 17)

4 **WIRELESS** indicator (page 17)

5 Disc drive indicator (page 17)

6 Power indicator (page 17)

7 **WEB** button (page 45)

8 Power button

While the HDMI input or the video input is selected as the audio/video input source, pressing this button switches the audio/video input source to the computer input or starts the Windows operating system in the background.

9 3D sync transmitter*

10 Built-in camera (page 49)

11 Built-in camera indicator (page 17)

12 LCD screen/touch screen (page 40)

!

Due to the mechanical design of the touch screen of your computer, some areas of the screen surface may become warm while you are using the computer for an extended period of time. This is normal and does not indicate a malfunction.

13  (Edge Access Operation Guide button) (page 44)

14 **3D** button* (page 45)

15 **SONY** logo lamp (page 114)

* On models equipped with a 3D-capable LCD screen only.

Back

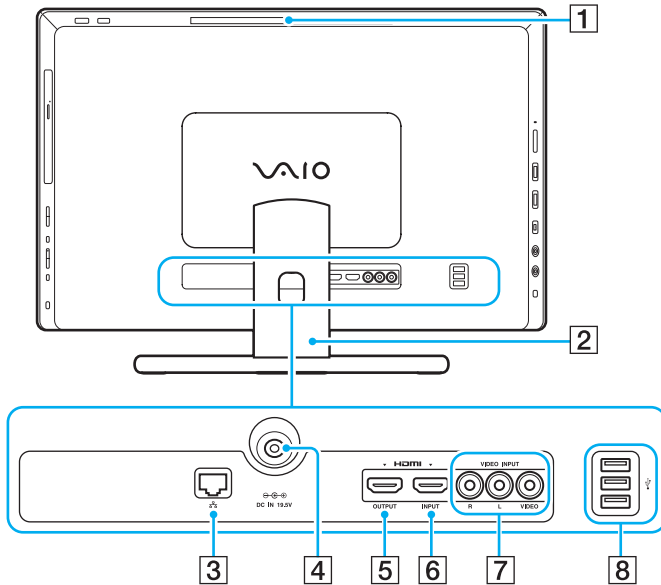

HDMI™
HIGH-DEFINITION MULTIMEDIA INTERFACE

- 1 Air exhaust vent
- 2 Foot stand (page 123)
- 3 LAN port (page 77)
- 4 DC IN port (page 18)
- 5 **HDMI OUTPUT** port*¹ (page 90)
- 6 **HDMI INPUT** port (page 60)
- 7 **VIDEO INPUT** jacks (page 60)
- 8 USB ports*² (page 101)

*¹ There may be no sound from an output device connected to the **HDMI OUTPUT** port for the first few seconds after playback starts. This is not a malfunction.

*² Compliant with the USB 2.0 standard.

! The area around the air exhaust vent (1) becomes extremely hot while your computer is on. Be sure to wait until the computer cools down before you touch it.

Right

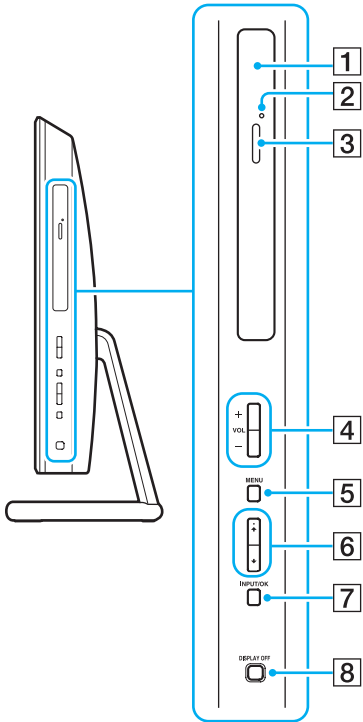

- 1 Optical disc drive (page 50)
- 2 Manual eject hole (page 153)
- 3 Drive eject button (page 50)
- 4 **VOL** (+/-) buttons (page 62)
- 5 **MENU** button (page 62)
- 6 **▲/▼** (Up/Down) buttons (page 62)
- 7 **INPUT/OK** button (page 62)
- 8 **DISPLAY OFF** button (page 45)

Left

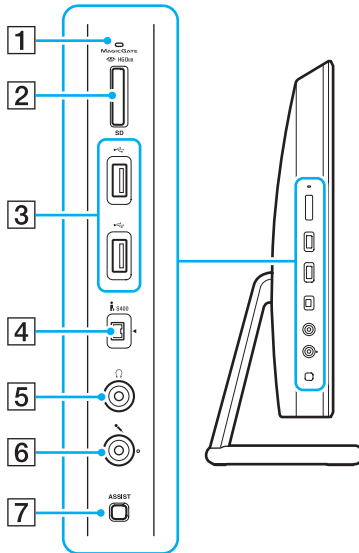

- 1 Media access indicator ([page 17](#))
- 2 "Memory Stick Duo"/SD memory card combined slot*¹ ([page 65](#)), ([page 72](#))
- 3 USB ports*² ([page 101](#))
- 4 i.LINK 4-pin (S400) port ([page 103](#))
- 5 Headphones jack ([page 89](#))
- 6 Microphone jack ([page 100](#))
- 7 **ASSIST** button ([page 45](#))

*1 Supports Duo-size "Memory Stick" and the SD memory card. However, they cannot be used simultaneously.

*2 Compliant with the USB 2.0/3.0 standards. USB ports that are compliant with the USB 3.0 standard are identifiable by their blue color.

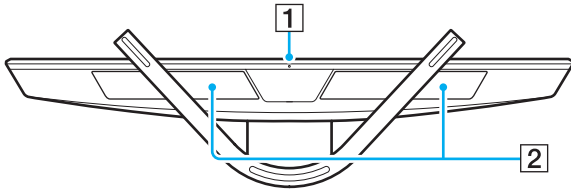

Bottom



- 1 Built-in microphone (monaural)
- 2 Built-in speakers (stereo)/Air intake vents

About the Indicator Lights

Your computer is equipped with the following indicator lights:

Indicator	Functions
Power 	Illuminates in green while the computer is in Normal mode, blinks slowly in orange while the computer is in Sleep mode, and turns off when the computer is turned off.
HDMI input	Illuminates in green while the HDMI input is selected as the audio/video input source.
VIDEO input	Illuminates in green while the video input is selected as the audio/video input source.
WEB	Illuminates in green while the Quick Web Access function is activated.
Built-in camera	Illuminates while the built-in camera is in use.
Media access	Illuminates while data access to a memory card, such as "Memory Stick" and an SD memory card, is in progress. (Do not place the computer into Sleep mode or turn it off while this indicator light is lit.) When the indicator light is unlit, the memory card is not in use.
Disc drive 	Illuminates while data access to the built-in storage device or the optical disc drive is in progress. Do not place the computer into Sleep mode or turn it off while this indicator light is lit.
WIRELESS	Illuminates while one or more wireless options are enabled.

Setting Up Your Computer

Connecting a Power Source

You need an AC adapter to connect your computer to an AC power source.



Use only the supplied AC adapter for your computer.

To connect the AC adapter

- 1 Plug one end of the power cord (1) into the AC adapter (2).
- 2 Plug the other end of the power cord into an AC outlet (3).

- 3 Route the AC adapter cable through the hole of the foot stand and plug it into the DC IN port (4).

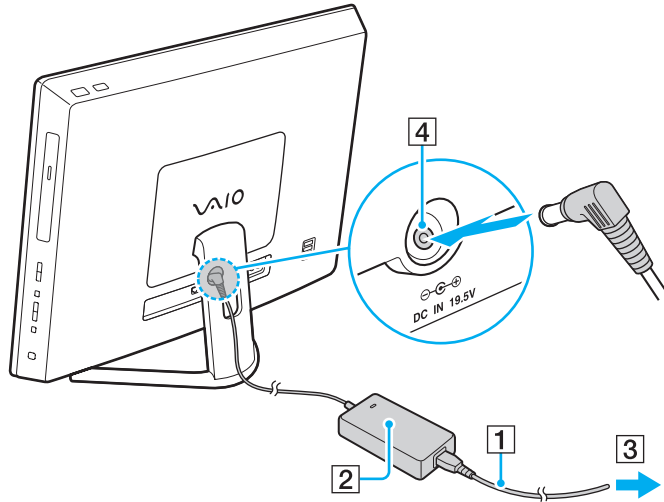

! The shape of the DC In plug varies depending on the AC adapter.

If you unplug the AC adapter from your computer while the computer is on, you will lose all unsaved data.



To disconnect your computer completely from an AC power source, turn off the computer and unplug the AC adapter.

Make sure that an AC outlet is easily accessible.

Shutting Down Your Computer Safely

To avoid losing unsaved data, be sure to shut down your computer properly, as described below.

To shut down your computer

- 1 Turn off any peripherals connected to the computer.
- 2 Save your data and close all running software applications.
- 3 Click **Start** and the **Shut down** button.
After a short time, the computer automatically turns off. Make sure the power indicator light turns off.

Using the Power Saving Mode

In addition to the normal operating mode, your computer has a distinct power saving mode called Sleep mode.

! Turn off your computer if you do not intend to use it for an extended period of time.

Mode	Description
Normal mode	This is the normal state of your computer while it is in use. The green power indicator light is lit while the computer is in this mode.
Sleep mode	Sleep mode turns off the LCD screen and places the built-in storage device(s) and the CPU into a low power consumption mode. The orange power indicator light blinks slowly while your computer is in this mode.

Using Sleep Mode

To activate Sleep mode

Click **Start**, the arrow  next to the **Shut down** button, and **Sleep**.



Alternatively, you can press the sleep button on the wireless keyboard to place your computer into Sleep mode.

To return to Normal mode

- Press any key on the wireless keyboard.
- Click the wireless mouse button.
- Move the wireless mouse.
- Press the power button on your computer.



We recommend that you turn off the power switch on the bottom of your wireless mouse when you place your computer into Sleep mode. This will prevent the computer from returning to Normal mode when the mouse is unintentionally moved.



Make sure that the battery of your wireless keyboard is properly installed and not running out of power.

If you press and hold the power button for more than four seconds, your computer will turn off automatically. You will lose all unsaved data.

If the computer is not used for a certain period of time, it will enter Sleep mode. To modify this, you can change the Sleep mode settings.

To change the Sleep mode settings

- 1 Click **Start, Control Panel, Hardware and Sound, and Power Options.**
- 2 Click **Change plan settings** under the current power plan.
- 3 Change the time to place the computer into Sleep mode and click **Save Changes.**

Keeping Your Computer in Optimum Condition

Updating Your Computer

Be sure to update your VAIO computer with the following software applications for enhancing your computer's efficiency, security, and functionality.

The **VAIO Update** automatically notifies you of new updates available on the Internet, and downloads and installs them on the computer.

Windows Update

Click **Start, All Programs, and Windows Update** and then follow the on-screen instructions.

VAIO Update 5

Click **Start, All Programs, and VAIO Update** and then follow the on-screen instructions.



Your computer must be connected to the Internet to download the updates.

Using the Antivirus Software for Your Computer

Protect your computer against computer viruses by using the antivirus software.

You can keep the antivirus software current with the latest updates by downloading and installing the updates from the web site of the manufacturer. To update the antivirus software, find the antivirus software installed on your computer from the following and follow the steps.



Your computer must be connected to the Internet to download the updates.

❑ **Trend Micro:**

- 1 Click **Start, All Programs, Trend Micro Titanium Maximum Security**, and **Trend Micro Titanium Maximum Security**.
- 2 Follow the on-screen instructions.

❑ **McAfee:**

- 1 Click **Start, All Programs, McAfee**, and **McAfee Internet Security** or **McAfee Total Protection**.
- 2 Follow the on-screen instructions.

❑ **Norton Internet Security:**

- 1 Click **Start, All Programs, Norton Internet Security**, and **LiveUpdate** or **Norton Internet Security**.
- 2 Follow the on-screen instructions.



See the help file included with your software program for more information.



The actual procedure may be different from the above depending on the version of the software installed on your computer. In such a case, follow the on-screen instructions.

Using the VAIO Care

With the **VAIO Care**, you can regularly conduct performance checks and tune-ups on your computer to keep it running at an optimum level. Launch the **VAIO Care** whenever a problem is found on your computer. The **VAIO Care** will provide appropriate measures to solve the problem.

To launch the VAIO Care

- ❑ On models with the **ASSIST** button
Press the **ASSIST** button while your computer is on.
- ❑ On models without the **ASSIST** button
Click **Start, All Programs,** and **VAIO Care.**



See the help file included with the **VAIO Care** for more information.

On models with the **ASSIST** button, pressing the **ASSIST** button while the computer is off launches the **VAIO Care Rescue**. The **VAIO Care Rescue** can be used to recover your computer in case of emergency, for example, when the Windows does not start.

Using Your VAIO Computer

This section describes how to get the most out of using your VAIO computer.

- ❑ **Using the Keyboard** ([page 28](#))
- ❑ **Using the Mouse** ([page 35](#))
- ❑ **Using the Touch Screen** ([page 40](#))
- ❑ **Using the Edge Access** ([page 44](#))
- ❑ **Using Special-function Buttons** ([page 45](#))
- ❑ **Using the Quick Web Access Function** ([page 47](#))
- ❑ **Using the Built-in Camera** ([page 49](#))
- ❑ **Using the Optical Disc Drive** ([page 50](#))
- ❑ **Using the 3D Function** ([page 58](#))
- ❑ **Using the HDMI/VIDEO Input Function** ([page 60](#))
- ❑ **Using "Memory Stick"** ([page 65](#))
- ❑ **Using Other Modules / Memory Cards** ([page 72](#))
- ❑ **Using the Internet** ([page 76](#))
- ❑ **Using the Network (LAN)** ([page 77](#))
- ❑ **Using the Wireless LAN** ([page 78](#))
- ❑ **Using the BLUETOOTH Function** ([page 83](#))

Using the Keyboard

A wireless keyboard is supplied with your computer.

The wireless keyboard uses a standard key arrangement with additional keys that perform specific functions.

! You cannot use the wireless keyboard in conjunction with the HDMI/VIDEO input function ([page 60](#)).

Using the Wireless Keyboard

One alkaline AA battery is supplied with your wireless keyboard. Before attempting to use the wireless keyboard, remove the battery compartment cover (1) from the bottom of the wireless keyboard and install the supplied AA battery (2) into the battery compartment.

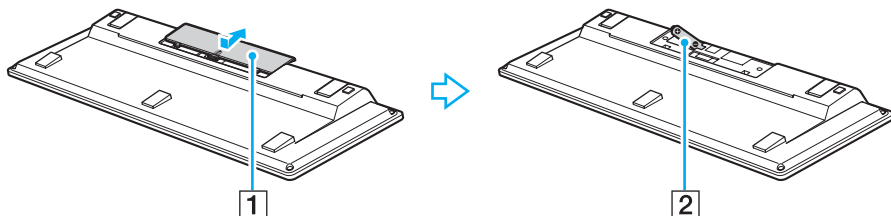

If the wireless keyboard does not operate properly, the battery may need to be replaced. If you do not intend to use the wireless keyboard for an extended period of time, remove the battery to avoid possible damage from battery leakage.

If the wireless keyboard is left unused for 20 minutes or longer, your computer enters Sleep mode. To bring it back into Normal mode, press any key on the wireless keyboard.



To maintain good communication, operate the wireless keyboard within the distance limitations of keyboard: approximately 10 m from your computer.

Avoid using any wireless devices that exchange radio signals on the 2.4 GHz band near your wireless keyboard. These devices may create radio interference, causing the keyboard to stop working properly.

Do not place metal furniture or objects near your computer or wireless keyboard, as this may create radio interference, causing the keyboard to stop working properly.



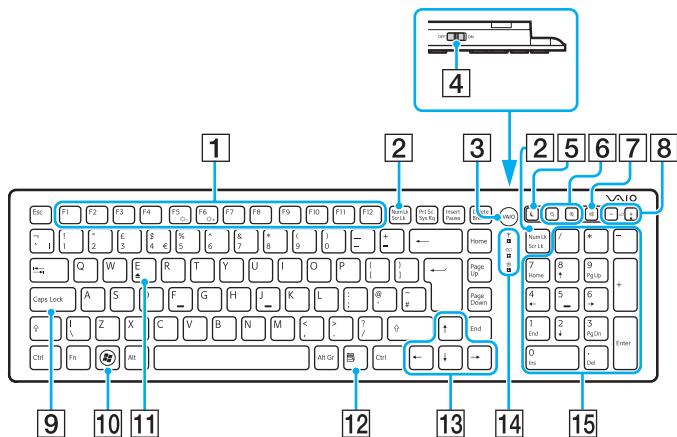

Be sure to use an alkaline battery. Using an incompatible battery can damage the wireless keyboard.



* Disabled while you are using the Quick Web Access function.



Illustrated above is the English keyboard as an example. The appearance of your wireless keyboard may be different from those illustrated in this manual due to variations in specifications.

- 1** Function keys*
Perform certain tasks. The task associated with each function key varies among software applications except the following combinations with the **Fn** key to change the LCD brightness of your computer screen.
Fn+F5: Decrease lighting intensity of the LCD screen.
Fn+F6: Increase lighting intensity of the LCD screen.
 - 2** Num Lk/Scr Lk* key
Activates/deactivates Num Lk mode. To activate/deactivate Scr Lk mode, use this key in conjunction with the **Fn** key. When Num Lk or Scr Lk mode is activated or deactivated, the  (Num lock) or  (Scroll lock) icon appears on the taskbar along with a pop-up message to indicate a mode change.
-  You can keep the Num lock and/or Scroll lock icon on the taskbar. To do so, right-click the  icon on the taskbar, click **Customize notification icons**, and then select **Show icon and notifications** for your desired icon.
- 3** VAIO button* (page 45)
 - 4** Power switch
Slide the switch to turn the wireless keyboard on and off.
 - 5** Sleep button*
Provides a lower level of power consumption. For details on power management, see **Using the Power Saving Mode** (page 21).

6 Zoom buttons*

Change the size of an image or a document displayed on some software.

Press  to make the view look smaller and further away (zoom out).

Press  to make the view look bigger and closer (zoom in).

See the help file included with the **VAIO Control Center** for more information.

7 Muting button

Turns the volume on and off.

8 Volume control buttons

Increase (+) or decrease (-) the volume.

9 **Caps Lock** key

Activates/deactivates Caps Lock mode where letters are all typed in upper case.

10 Windows key*

Displays the **Start** menu.

11 **E** key*

Ejects the optical disc drive tray when used in conjunction with the **Fn** key.

12 Applications key*

Displays a context-sensitive shortcut menu (if any).

13 Directional arrow keys

Move the pointer on the computer screen.

14 Indicator lights

 (Battery): Stays off while the AA battery for the wireless keyboard is sufficient and blinks when the battery is running out of power.

 (Caps lock): Turns on when Caps Lock mode is activated.

 (Connect): Stays off while the wireless keyboard is properly connected with your computer; and blinks for about 10 minutes when the connection is cut off, for example, when the computer is turned off or enters Sleep mode.

15 Numeric keypad

Use the numeric keypad to type numbers or to perform basic math calculations.

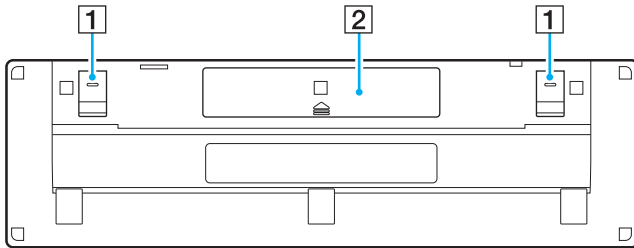

- 1** Keyboard feet
Flip open to put the wireless keyboard in a more 'ergonomic' position.
- 2** Battery compartment ([page 29](#))
Storage compartment for the AA battery.

To connect the wireless keyboard

When the supplied wireless keyboard does not seem to be working, use the supplied wireless mouse and follow these steps to reconnect the keyboard with your computer. You can perform the connection operations using an optional USB keyboard as well.



When the Windows password is set on your computer, you can use the on-screen keyboard ([page 44](#)) for password entry to start the computer. When the power-on password is set on the computer, however, the on-screen keyboard is not available for password entry and you need an optional USB keyboard.



Under normal circumstances, you do not need to perform the connection operations before using your wireless keyboard.

While your wireless keyboard is successfully working, do not perform the connection operations as this may cause a malfunction.

- 1 Make sure that the supplied battery is properly installed on your wireless keyboard, and then slide the power switch on the keyboard to the **OFF** position.
- 2 Turn on the computer.
- 3 If the computer has multiple user accounts, select the one with administrative rights.

If the Windows password is set on your computer, click  at the bottom left of the computer screen, select the **Type without the keyboard (On-Screen Keyboard)** check box, and click **OK**.

- 4 Enter the Windows password with the on-screen keyboard and click .



If the typed password does not appear in the password entry field, click the field to show a blinking cursor, and then enter the password once again.

- 5 Wait until the Windows starts, and then click **Start** and **Computer**.
- 6 Double-click **Local Disk (C:)**, **WConnectTool**, and **WConnect**.
If the **User Account Control** window appears, click **Yes**.
- 7 Wait until the utility window for re-connection appears, and then slide the power switch on the wireless keyboard to the **ON** position.



It may take a while before the utility window appears.

- 8 Wait until the utility window notifies that the wireless keyboard should now be working, and then close the utility window.

Using the Mouse

A wireless mouse is supplied with your computer.

The wireless mouse has no cables to plug in and uses a laser sensor instead of a ball.

Using the Wireless Mouse

One alkaline AA battery is supplied with your wireless mouse. Before attempting to use the wireless mouse, remove the battery compartment cover (1) from the bottom of the wireless mouse and install the supplied AA battery (2) into the battery compartment.

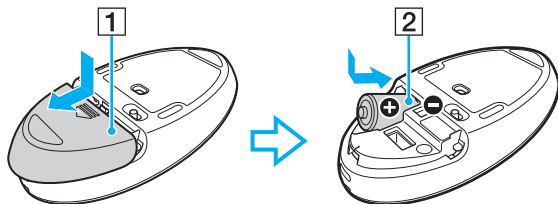

If the wireless mouse does not operate properly, the battery may need to be replaced. If you do not intend to use the wireless mouse for an extended period of time, remove the battery to avoid possible damage from battery leakage.



To maintain good communication, operate the wireless mouse within the distance limitations of mouse: approximately 10 m from your computer.

Avoid using any wireless devices that exchange radio signals on the 2.4 GHz band near your wireless mouse. These devices may create radio interference, causing the mouse to stop working properly.

Use surfaces such as plain paper, card stock, or fabric that have minimal repetitive patterns.

Avoid using the wireless mouse on surfaces such as mirrors, smooth glass, or magazines that have half-tone printing.

Do not place metal furniture or objects near your computer or wireless mouse, as this may create radio interference, causing the mouse to stop working properly.

Be sure to use an alkaline battery. Using an incompatible battery can damage the wireless mouse.

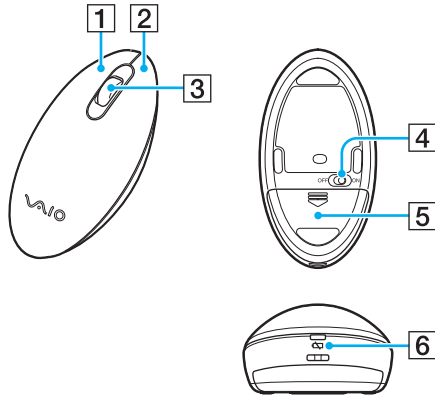

- 1** Left button
Click or double-click the left button to select items. To drag and drop items, hold the left button down while sliding the mouse, then release the button to drop the item.
- 2** Right button
Press the right button once to display a context-sensitive shortcut menu (if any).
- 3** Central wheel
Rotate the central wheel to scroll up or down a page. Press the wheel once to lock the scroll action and control the movement by moving the entire mouse (the scroll function is available only with applications that support it).
- 4** Power switch
Slide the switch to turn the mouse on and off.
- 5** Battery compartment [\(page 36\)](#)
Storage compartment for the AA battery.
- 6** Status light
Blinks in orange when the mouse battery is running out of power; and turns on in green for about 10 seconds when the wireless mouse is turned on or connected with your computer.

To connect the wireless mouse

When the supplied wireless mouse does not seem to be working, use the supplied wireless keyboard and follow these steps to reconnect the mouse with your computer. You can perform the connection operations using an optional USB mouse as well.

!
Under normal circumstances, you do not need to perform the connection operations before using your wireless mouse.

While your wireless mouse is successfully working, do not perform the connection operations as this may cause a malfunction.

- 1 Make sure that the supplied battery is properly installed on your wireless mouse, and then slide the power switch on the mouse to the **OFF** position.
- 2 Turn on the computer.
- 3 If the computer has multiple user accounts, press the **←** or **→** key to select the one with administrative rights and press the **Enter** key.
- 4 Wait until the Windows starts, and then press the Windows key on the wireless keyboard to display the **Start** menu.
- 5 Enter **wconnect** and press the **Enter** key.
If the **User Account Control** window appears, press the **←** or **→** key to select **Yes** and press the **Enter** key.
- 6 Wait until the utility window for re-connection appears, and then slide the power switch on the wireless mouse to the **ON** position.



It may take a while before the utility window appears.

- 7 Wait until the utility window notifies that the wireless mouse should now be working, and then close the utility window.

Adjusting the Mouse Functions

- 1 Click **Start** and **Control Panel**.
- 2 Click **Mouse** under **Hardware and Sound**.
The **Mouse Properties** window appears.
- 3 Change the settings.

Using the Touch Screen

Embedded infrared optical sensors of your computer's touch screen enable direct interaction with the computer using your finger(s). You can perform various gestures on the touch screen to compensate for mouse operations, such as selecting items and scrolling.



The touch screen function may be disabled depending on the software application you are using.

You cannot use some touch screen functions while the Quick Web Access function is activated.

Your computer is equipped with two optical sensors and supports multi-touch input of up to two points. When you rotate a picture on the touch screen, for example, a rotating gesture may not be successfully recognized by your computer, which, however, does not indicate a malfunction.

The touch screen function is disabled while you are using the HDMI/VIDEO input function. See [Using the HDMI/VIDEO Input Function \(page 60\)](#) for more information.

Gesture	Description
Tap	Tap on the touch screen once with a finger. This gesture is equivalent to a click with a mouse.
Double-tap	Tap on the touch screen twice in quick succession with a finger. This gesture is equivalent to a double-click with a mouse.
Press-and-hold	Touch and hold on the touch screen with a finger until a circling icon appears, and then lift the finger off the screen to display a context-sensitive shortcut menu (if any). This gesture is equivalent to a right-click with a mouse.
Press-and-tap	Touch and hold on the touch screen with a finger and tap with another finger to display a context-sensitive shortcut menu (if any). This gesture is equivalent to a right-click with a mouse.
Drag	Put a finger on the touch screen and slide it while keeping the finger in contact with the screen. Drag left or right for panning; up or down for scrolling.

Gesture	Description
Flick	<p>Put a finger on the touch screen and slide it linearly in quick motion. You can assign an individual task to up to eight flicks. There are four default flick assignments: you can flick left to move backward, flick right to move forward, flick up to scroll up, and flick down to scroll down. When a flick gesture is successfully recognized, an icon appears with a description of the assignment on the desktop. To add or change the flick assignments, click Start, Control Panel, Hardware and Sound, and Pen and Touch to access the Flick tab.</p>
Zoom	<p>With some software applications, you can pinch on the touch screen with two fingers for zooming. Pinch open to zoom in or pinch close to zoom out.</p>
Rotate	<p>With some software applications, such as photo viewer software, you can put two fingers on the touch screen and slide them in circles to rotate the underlying object.</p>

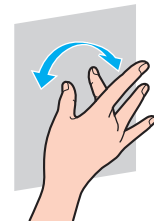
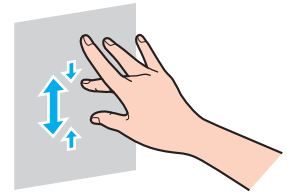
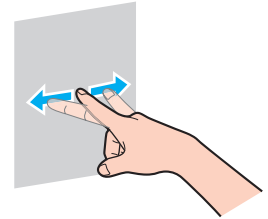

To enable or disable the touch screen function

Follow these steps to enable or disable the touch screen function.

- 1 Touch and hold  located at the lower right edge of the computer screen for more than two seconds. The touch function settings window appears.
- 2 Change the setting to enable or disable the touch screen and then click **OK**.



You can change the DPI to enlarge the view size of the touch screen for easier touch works. To do so, click **Start, Control Panel, Hardware and Sound, Display, and Set custom text size (DPI)**, and then specify your preference. Changing the DPI, however, may distort the screen view while you are using a non-compatible software application or viewing a non-compatible web site. Depending on the model you purchased, the text size may be set to **Larger** by default.

Notes on Using the Touch Screen

- ❑ To repeat tapping, be sure to lift your finger at least 4 mm off the touch screen after each tap.
- ❑ When tapping triggers an unintentional operation, make sure that no other parts of your body, including your clothes, are in contact with the touch screen. The touch screen may even respond to a touch made by an insect that happens to come in contact with the screen.
- ❑ Be sure to touch gently with your fingertip, not with the ball of your finger. If the area of contact with the touch screen is beyond specifications of the touch screen function, your computer may not recognize your touch.
- ❑ Depending on the spot you touch on the screen, the touch screen sensitivity varies. This is normal and does not indicate a malfunction.
- ❑ Gentle touches always work. The degree of pressing force does not count for operations as the touch screen employs optical technology.
- ❑ The front bezel is covered with the protective film at the time of delivery. Do not use the touch screen without removing the protective film, as it may cause lower touch sensitivity.

Using the Edge Access

The Edge Access provides you with instant access to various functions, such as skipping to the next chapter, zooming in or out text and photos, and displaying the on-screen keyboard. You can use such functions just by touching black glass sections around the edges of the computer screen.



The Edge Access is disabled at the time of delivery. You first need to press  (Edge Access Operation Guide button) and enable the Edge Access. The button is located at the lower right edge of the computer screen ([page 12](#)).

For detailed information on the Edge Access, see the Edge Access Operation Guide. To access the Edge Access Operation Guide, touch .

To enable or disable the Edge Access

Follow these steps to enable or disable the Edge Access.

- 1 Touch and hold  located at the lower right edge of the computer screen for more than two seconds. The touch function settings window appears.
- 2 Change the setting to enable or disable the Edge Access and then click **OK**.





The Edge Access is available only when the Windows operating system is running. It is not available with some functions, which work without running the Windows operating system, for example the Quick Web Access function or the HDMI/VIDEO input function.

Using Special-function Buttons

Your computer is equipped with special buttons to help you use specific functions of the computer.



Some features and options in this section may not be available on your computer.
See the specifications to find out about the configuration of your computer.

Special-function button	Functions
ASSIST button 	Launches the VAIO Care while the computer is on. While the computer is off, the ASSIST button launches the VAIO Care Rescue . The VAIO Care Rescue can be used to recover the computer in case of emergency, for example, when the Windows does not start. See Using the VAIO Care (page 26) for more information.
WEB button 	While the computer is in Normal mode, the WEB button launches the web browser assigned to the button by default. While the computer is off, the WEB button activates the Quick Web Access function and launches the web browser used with this function. See Using the Quick Web Access Function (page 47) for more information.
DISPLAY OFF button 	Illuminates in orange while the LCD backlight is off. While the computer is running, the DISPLAY OFF button turns off the LCD backlight. To turn on the LCD backlight, press this button once again. While the HDMI input or the video input is selected as the audio/video input source, the DISPLAY OFF button turns off both the LCD backlight and the volume. ! You cannot turn off only the LCD backlight while the HDMI input or the video input is selected as the audio/video input source.

Special-function button	Functions
3D button ^{*1}	<p>Activates or deactivates the 3D function and illuminates while you are playing 3D content on your computer. See Using the 3D Function (page 58) for information on the 3D function.</p> <p>!</p> <p>The 3D button does not work while:</p> <ul style="list-style-type: none">- The HDMI input or the video input is selected as the audio/video input source.- You are viewing 3D content on a 3D-capable display connected to your computer with an HDMI cable.
VAIO button ^{*2}	<p>Executes the task that is assigned to the button by default. You can change the default assignment with the VAIO Control Center.</p>

^{*1} On models equipped with a 3D-capable LCD screen only.

^{*2} Located on the wireless keyboard ([page 29](#)).

Using the Quick Web Access Function

The Quick Web Access function enables you immediately to access the Internet without launching the Windows operating system.

Activating the Quick Web Access Function

To activate the Quick Web Access function, your computer must be off.

To activate the Quick Web Access function

- 1 Press the **WEB** button on the computer.
- 2 Follow the instructions in the initial setup wizard.
Once you have completed the initial setup, the web browser used with the Quick Web Access function launches just by pressing the **WEB** button from the next time.

Exiting the Quick Web Access Function

! To launch the Windows operating system, you first need to exit the Quick Web Access function.

To exit the Quick Web Access function, do any of the following:

- Click the  icon located at the lower left corner of the screen.
- Press the **WEB** button.
- Press the power button on the computer.

For detailed information on how to use or restrictions on the Quick Web Access function, click the  icon located at the lower right corner of the screen.

Notes on Using the Quick Web Access Function

While the Quick Web Access function is activated, you cannot use:

- ❑ the **ASSIST** button.
- ❑ any function key, the **Scr Lk** key, and the **E** key in combination with the **Fn** key for shortcuts.
- ❑ the zoom buttons and the **VAIO** button on the wireless keyboard.
- ❑ any port and jack except the DC IN port, the LAN port, the USB ports, and the headphones jack.
- ❑ the "Memory Stick Duo" slot and the **SD** memory card slot.
- ❑ some touch screen functions.

Using the Built-in Camera

Your computer is equipped with a built-in camera.

With the communication software, such as **Windows Live Messenger**, you can make a video call through the Internet. For detailed information on how to use the software, see the help file included with the software.



Use the display tilting feature to adjust the viewing angle of the built-in camera ([page 9](#)).

The built-in camera indicator light illuminates while the built-in camera is in use.

The software installed on your computer varies depending on your computer's configurations.

To make a video call using Windows Live Messenger

- 1 Click **Start, All Programs, and Windows Live Messenger**.



You need to sign in to **Windows Live Messenger** to make a video call.

To display images from the built-in camera

- 1 Click **Start, All Programs, ArcSoft Webcam Suite, and WebCam Companion 4**.
- 2 Click **Capture**.



If you cannot capture images properly, for example captured images are not displayed smoothly, click the current resolution of the capturing image at the upper right of the main window and lower the resolution.

Using the Optical Disc Drive

Your computer is equipped with an optical disc drive.



Some features and options in this section may not be available on your computer.
See the specifications to find out about the configuration of your computer.

To insert a disc

- 1 Turn on the computer.
- 2 Press the drive eject button (1) or the **Fn+E** keys to open the drive.
The drive tray slides out.

- 3 Hold the back of the drive tray with one hand, place a disc in the middle of the drive tray with the label side facing toward you, and gently push it toward the drive tray until the disc clicks into place.

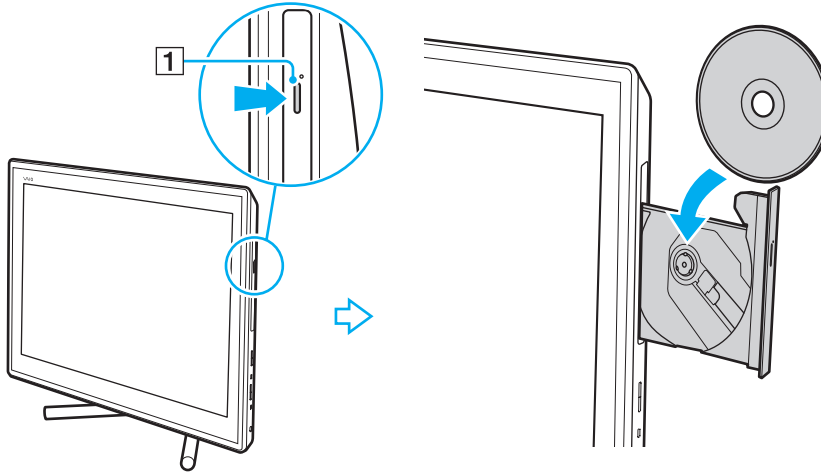

! Do not exert pressure on the drive tray. Be sure to hold the back of the drive tray when placing/removing a disc onto/from the drive tray.

- 4 Close the drive tray by pushing it in gently.

! Do not remove the optical disc while your computer is in Sleep mode. Be sure to bring the computer back into Normal mode before removing the disc.

Supported Discs

Your computer plays and records CDs, DVDs, and Blu-ray Disc™ media, depending on the model you purchased. See the reference chart below to find out which type of optical disc drive supports which types of media.

PR: playable and recordable
P: playable but not recordable
–: not playable or recordable

	CD-ROM	CD-R/RW	DVD-ROM	DVD-R/ RW	DVD+R/ RW	DVD+R DL (Double Layer)	DVD-R DL (Dual Layer)	DVD- RAM ^{*1 *2}	BD-ROM	BD-R/RE ^{*3 *4}
DVD SuperMulti Drive	P	PR ^{*6}	P	PR	PR	PR	PR	PR	–	–
Blu-ray Disc™ Drive with DVD SuperMulti	P	PR ^{*6}	P	PR	PR	PR	PR	PR	P	PR ^{*5}
Blu-ray Disc™ ROM Drive with DVD SuperMulti	P	PR ^{*6}	P	PR	PR	PR	PR	PR	P	P

^{*1} The DVD SuperMulti Drive on your computer does not support the DVD-RAM cartridge. Use non-cartridge discs or discs with a removable cartridge.

^{*2} Writing data to single-sided DVD-RAM discs (2.6 GB) compliant with DVD-RAM Version 1.0 is not supported.
DVD-RAM Version 2.2/12X-SPEED DVD-RAM Revision 5.0 disc is not supported.

^{*3} The Blu-ray Disc drive on your computer does not support BD-RE Disc media in Version 1.0 format and Blu-ray Disc media with a cartridge.

^{*4} BDXL™ Disc media is not supported.

^{*5} Supports writing data to BD-R Part1 Version 1.1/1.2/1.3 discs (single-layer discs with the capacity of 25 GB, dual-layer discs with the capacity of 50 GB) and BD-RE Part1 Version 2.1 discs (single-layer discs with the capacity of 25 GB, dual-layer discs with the capacity of 50 GB).

^{*6} Writing data to Ultra Speed CD-RW discs is not supported.

! This unit is designed to playback discs that conform to the Compact Disc (CD) standard. DualDiscs and some music discs encoded with copyright protection technologies do not conform to the Compact Disc (CD) standard. Therefore, these discs may not be compatible with this unit.

When you buy pre-recorded or blank discs for use with your VAIO computer, be sure to read the notices on the disc package carefully to check both playback and recording compatibility with your computer's optical disc drives. Sony does NOT guarantee the compatibility of VAIO optical disc drives with discs that are not compliant with the official "CD," "DVD," or "Blu-ray Disc" standard. USING NON-COMPLIANT DISCS CAN CAUSE FATAL DAMAGE TO YOUR VAIO COMPUTER OR CREATE SOFTWARE CONFLICTS AND CAUSE SYSTEM HANGING.

For inquiries about disc formats, contact the individual publisher of the pre-recorded disc or the manufacturer of the recordable disc.



8 cm disc writing is not supported.

! To play copyright protected Blu-ray Disc media continually, update the AACS key. The AACS key update requires Internet access.

As with other optical media devices, circumstances may limit compatibility or prevent Blu-ray Disc media playback. VAIO computers may not support movie playback on packaged media recorded in AVC or VC1 formats at high bit rates.

Region settings are required for some contents of DVD and BD-ROM Disc media. If the region setting on the optical disc drive does not match the region coding on the disc, playback is not possible.

Unless your external display is compliant with the High-bandwidth Digital Content Protection (HDCP) standard, you cannot play or view the contents of copyright protected Blu-ray Disc media.

Some content may restrict video output to standard definition or prohibit analog video output. When you output video signals through digital connections, such as an HDMI connection or a DVI connection, it is strongly recommended that a digital HDCP compliant environment be implemented for optimum compatibility and viewing quality.

Exit all memory-resident utility software before playing or writing a disc as it may cause the computer to malfunction.

Notes on Using the Optical Disc Drive

Notes on writing data to a disc

- ❑ Only use circular discs. Do not use discs in any other shape (star, heart, card, etc.), as this may damage the optical disc drive.
- ❑ Do not strike or shake your computer while the optical disc drive is writing data to a disc.
- ❑ Do not plug or unplug the power cord or the AC adapter while the optical disc drive is writing data to a disc.

Notes on playing discs

To achieve optimum performance of disc playback, you should follow these recommendations:

- ❑ Some CD players and computer optical disc drives may not be able to play audio CDs created with the CD-R or CD-RW media.
- ❑ Some DVD players and computer optical disc drives may not be able to play DVDs created with the DVD+R DL, DVD-R DL, DVD+R, DVD+RW, DVD-R, DVD-RW, or DVD-RAM media.
- ❑ When your computer is equipped with a Blu-ray Disc drive, Blu-ray Disc playback is available on your computer. However, the drive may not be able to play some Blu-ray Disc content, or the computer may become unstable during Blu-ray Disc playback. To play content normally, download and install the latest updates for Blu-ray Disc playback software using the **VAIO Update**.
For information on how to use the **VAIO Update**, see **Updating Your Computer (page 24)**.
- ❑ Depending on system environment, you may find sound interruptions and/or dropped frames during AVC HD playback.
- ❑ Do not place your computer into the power saving mode while your computer is playing a disc.

Notes on region codes

Region code indicators are labeled on the discs or packages to indicate in which region and on what type of player you can play the disc. If the region code indicates "all," you can play this disc in most regions of the world. If the region code for your residence area is different from the label, you cannot play the disc on your computer.

To find out the region code for your residence area, see the following table.

Residence area	Region code	Residence area	Region code	Residence area	Region code
Africa	5	Australia*	4	China	6
Europe	2	Hong Kong*	3	India*	5
Indonesia*	3	Japan*	2	Korea	3
Kuwait*	2	Malaysia*	3	New Zealand*	4
Philippines*	3	Russia	5	Saudi Arabia*	2
Singapore*	3	South Africa*	2	Taiwan	3
Thailand*	3	United Arab Emirates*	2	Vietnam	3

* A region code is not assigned to your computer's optical disc drive by default.

If it is your first time to play a DVD video on your computer, follow these steps before inserting the disc:

- 1 Click **Start** and **Computer**.
- 2 Right-click the optical disc drive icon and select **Properties**.
- 3 Click the **Hardware** tab.
- 4 Select your optical disc drive from the **All disk drives** list and click **Properties**.
- 5 Click the **DVD Region** tab.
- 6 Select an appropriate region from the list and click **OK**.

! You can change the region code only a limited number of times. When you have exceeded this number, the drive's region code is permanently assigned and you will not be able to change it again. Reconfiguring your computer does not reset this count. Any difficulties caused by changing the region code settings of the drive are not covered by the warranty.

Playing Discs

To play a disc

- 1 Insert a disc into the optical disc drive.

! Close all running software applications before playing a disc.

- 2 If nothing appears on the desktop, click **Start, All Programs**, and your desired software to play the disc.
For instructions on how to use the software, see the help file included with the software.

Copying Files to Discs

To copy files to a disc

- 1 Insert a recordable disc into the optical disc drive.

! Close all running software applications before copying files to a disc.

- 2 If nothing appears on the desktop, click **Start, All Programs**, and your desired disc burning software to copy files to the disc.
For instructions on how to use the software, see the help file included with the software.

Using the 3D Function

If your computer is equipped with a 3D-capable LCD screen, you can use the 3D function which enables you to view various types of 3D content on the computer screen or external 3D-capable displays, such as a 3D TV, using cutting-edge 3D technology.

The specially designed 3D glasses are supplied with the computer, so wear the supplied glasses and enjoy a new 3D experience.

For detailed information on how to play 3D content and use the 3D glasses, refer to the **Enjoying 3D: Information Guide**.



Some features and options in this section may not be available on your computer.
See the specifications to find out about the configuration of your computer.



If your computer is equipped with the Blu-ray Disc drive but not a 3D-capable LCD screen, you can view 3D content only on an external 3D-capable display connected to the computer with an HDMI cable. See **Playing Blu-ray 3D Disc media (page 94)** for more information.

What you can do with the 3D function

- ❑ On models equipped with a 3D-capable LCD screen
 - ❑ Playing Blu-ray 3D™ Disc media on the computer
 - ❑ Viewing 3D images on the computer screen by connecting a 3D-capable device to the **HDMI INPUT** port on the computer
 - ❑ Using the simulated 3D function (the 2D to 3D conversion function) while you are viewing 3D content on your computer screen
This function enables you to view 2D content (such as DVD media or videos) in simulated 3D.
- !
- ❑ On models equipped without a 3D-capable LCD screen
 - ❑ Viewing 3D images on a 3D TV connected to the computer with an HDMI cable ([page 95](#))
- ❑ On models equipped without a 3D-capable LCD screen
 - ❑ Viewing 3D images on a 3D TV connected to the computer with an HDMI cable ([page 95](#))

Using the HDMI/VIDEO Input Function

Your computer is equipped with an **HDMI INPUT** port and **VIDEO INPUT** jacks that enable you to connect an external audio/video device, such as an HDD video recorder and a video game player. With the HDMI/VIDEO input function, you can receive high-definition audio and video signals from the connected device and play the audio/video content on your computer without turning on the computer and starting Windows.



You cannot capture audio/video signals coming through the **HDMI INPUT** port or the **VIDEO INPUT** jacks and save them into a file on your computer.

When you change the audio/video input source to the HDMI input or the video input while viewing contents, such as Blu-ray Disc, DVD media, or recorded TV programs, on the computer screen, playback may automatically stop. If this occurs, change the input source back to the computer input and start playback again.

Connecting an External Audio/Video Device

To connect an external audio/video device to the **HDMI INPUT** port or the **VIDEO INPUT** jacks ([page 13](#)), you need an HDMI cable or an audio/video cable with triple RCA plugs.

! No HDMI cables or audio/video cables with triple RCA plugs are supplied with your computer. Be sure to have one ready beforehand.

Be sure to use an HDMI cable approved by HDMI Licensing, LLC.

To connect an external audio/video device to your computer

- 1 Plug one end of an HDMI cable or an audio/video cable with triple RCA plugs to an appropriate port or jacks on an external audio/video device.
- 2 Plug the other end to the **HDMI INPUT** port or the **VIDEO INPUT** jacks on the computer.
- 3 Turn on the connected device.

The **HDMI** input indicator light or the **VIDEO** input indicator light illuminates in green, depending on the audio/video input source. If not, press the **INPUT/OK** button ([page 62](#)) to switch the audio/video input source to the HDMI input or the video input.









You do not need to turn on your computer and start Windows to switch the audio/video input source.

Using the HDMI/VIDEO Input Control Buttons

The HDMI/VIDEO input control buttons are located on the right of your computer ([page 14](#)) for operations with the HDMI/VIDEO input function, including input source selections and On-Screen Display (OSD) menu operations.

The following table describes the task(s) assigned to each control button.

HDMI/VIDEO input control button	Assigned task
INPUT/OK button 	Displays the audio/video input selection window. Select the input among three sources (HDMI input, video input, and computer input) with the ▲/▼ buttons and press the INPUT/OK button. This button also executes your selection on the OSD menu.  While the HDMI input or the video input is selected, the corresponding indicator light illuminates in green (page 17).
MENU button 	Shows/hides the OSD menu on your computer screen.  The Touch screen function and the Edge Access are not available on the OSD menu.
VOL (+/-) buttons 	Increase (+) or decrease (-) the volume.  The volume control buttons, including the muting button, on the wireless keyboard work only on the Windows operating system while the operating system is running regardless of the current audio/video input source.
▲/▼ (Up/Down) buttons 	Navigate through options on the OSD menu.



Using the OSD Menu

The OSD menu is provided for customizing your computer to suit your preference.

Press the **MENU** button on the right of your computer to display the OSD menu and use the ▲/▼ buttons to navigate through options until you find your desired one.

Using the menu for the HDMI/VIDEO input function

The following lists some settings that you may find helpful for using the HDMI/VIDEO input function.

Selecting language mode of the OSD menu	<ol style="list-style-type: none">1 Select OPTION and LANGUAGE.2 Select the desired language.3 Press the INPUT/OK button.
SONY logo lamp	<p>To change the default SONY logo lamp activity for the HDMI input mode, follow these steps:</p> <ol style="list-style-type: none">1 Select OPTION and LANGUAGE.2 Select the desired language.3 Press the INPUT/OK button.  <p>To change the settings while the computer input is selected, see Changing the default SONY logo lamp activity (page 114) for the procedure.</p>
Selecting Input Sensing mode	<p>You can select one of the three Input Sensing modes: AUTO ON, AUTO OFF (Normal), and AUTO OFF (Power Save). In AUTO ON mode, connecting an external audio/video device to the HDMI INPUT port or the VIDEO INPUT jacks while your computer is off or in Sleep mode automatically switches the audio/video input source to the HDMI input or the video input, respectively. In AUTO OFF (Normal) or AUTO OFF (Power Save) mode, automatic input selection is not performed. By default, AUTO OFF (Normal) mode is selected.</p> <ol style="list-style-type: none">1 Select OPTION and INPUT SENSING.2 Select the desired mode.3 Press the INPUT/OK button.  <p>Selecting AUTO OFF (Power Save) reduces power consumption. To resume power, press the INPUT/OK button on the computer.</p>
Disabling the HDMI/VIDEO input function	<ol style="list-style-type: none">1 Select OPTION and DISABLE INPUT.2 Select the desired mode.3 Press the INPUT/OK button.

Using "Memory Stick"

"Memory Stick" is a compact, portable, and versatile IC recording media especially designed for exchanging and sharing digital data with compatible products, such as digital cameras, mobile phones, and other devices. Because it is removable, it can be used for external data storage.

Before You Use "Memory Stick"

The "Memory Stick Duo" slot on your computer can accommodate the following sizes and types of media:

- "Memory Stick Duo"
- "Memory Stick PRO Duo"
- "Memory Stick PRO-HG Duo"



Your computer supports only Duo-size "Memory stick", and does not support standard-size "Memory Stick".



The "Memory Stick Duo" slot also works as the **SD** memory card slot.

For the latest information about "Memory Stick", visit <http://www.sony.net/memorycard/>.

Inserting and Removing "Memory Stick"

To insert "Memory Stick"

- 1 Locate the "Memory Stick Duo" slot ([page 15](#)).
- 2 Hold "Memory Stick" with the arrow pointing toward the slot.
- 3 Carefully slide "Memory Stick" into the slot until it clicks into place.
Do not force the media into the slot.

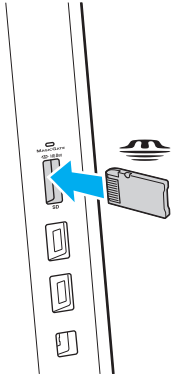



If "Memory Stick" does not go into the slot easily, remove it gently and verify you are inserting it in the proper direction.

When you insert "Memory Stick" into the slot for the first time, you may be prompted to install driver software. If prompted, follow the on-screen instructions to install the software.

"Memory Stick" is automatically detected by your system and the contents of "Memory Stick" are displayed. If nothing appears on the desktop, click **Start, Computer**, and double-click the "Memory Stick" icon.

The "Memory Stick" icon will appear in the **Computer** window after you insert "Memory Stick" into the slot.



Before using "Memory Stick Micro" ("M2"), be sure to insert it into an "M2" Duo adaptor. If you insert the media directly into the "Memory Stick Duo" slot without the adaptor, you may not be able to remove it from the slot.

To remove "Memory Stick"

! Do not remove "Memory Stick" while the media access indicator light is lit. If you do, you may lose data. Large volumes of data may take time to load, so make sure the indicator light is unlit before removing "Memory Stick".

- 1** Locate the "Memory Stick Duo" slot ([page 15](#)).
- 2** Check that the media access indicator light is unlit.
- 3** Push in "Memory Stick" toward the computer and release.
"Memory Stick" ejects.
- 4** Pull "Memory Stick" out of the slot.

! Be sure to remove "Memory Stick" gently, or it may pop out unexpectedly.

Formatting "Memory Stick"

To format "Memory Stick"

"Memory Stick" is formatted by default and is ready for use.

If you want to reformat the media with your computer, follow these steps.

! Be sure to use the device that is designed to format the media and supports "Memory Stick" when formatting the media.

Formatting "Memory Stick" erases the entire data stored on the media. Before formatting the media, make sure that it does not contain your valuable data.

Do not remove "Memory Stick" from the slot while formatting. This could cause a malfunction.

- 1 Locate the "Memory Stick Duo" slot ([page 15](#)).
- 2 Carefully slide "Memory Stick" into the slot until it clicks into place.
- 3 Click **Start** and **Computer**.
- 4 Right-click the "Memory Stick" icon and select **Format**.
- 5 Click **Restore device defaults**.

! The size of the allocation unit and file system may change.

Do not select **NTFS** from the **File system** drop-down list as it may cause a malfunction.



The formatting process will be completed more quickly if you select **Quick Format** in **Format options**.

- 6 Click **Start**.
- 7 Follow the on-screen instructions.



It may take time to format "Memory Stick" depending on the media type.

Notes on Using "Memory Stick"

- ❑ Your computer has been tested and found compatible with Sony branded "Memory Stick" with capacity of up to 32 GB that are available as of June 2011. However, not all "Memory Stick" are guaranteed of compatibility.
- ❑ Be sure to hold "Memory Stick" with the arrow pointing in the correct direction as you insert it into the slot. To avoid damaging your computer or the media, do not force "Memory Stick" into the slot if you cannot insert it smoothly.
- ❑ Use care when inserting or removing "Memory Stick" from the slot. Do not force it in or out of the slot.
- ❑ Inserting "Memory Stick" with multiple conversion adaptors is not guaranteed of compatibility.
- ❑ "MagicGate" is the general name of the copyright protection technology developed by Sony. Use "Memory Stick" with the "MagicGate" logo to take advantage of this technology.
- ❑ Except for your personal use, it is against the copyright law to use any audio and/or image data you recorded without prior consent from the respective copyright holders. Accordingly, "Memory Stick" with such copyrighted data can be used only within the law.
- ❑ Do not insert more than one memory card into the slot. Improper insertion of the media may damage both your computer and the media.

Using Other Modules / Memory Cards

Using the SD Memory Card

Your computer is equipped with an **SD** memory card slot. You can use this slot to transfer data among digital cameras, camcorders, music players, and other audio/video devices.

Before you use the SD memory card

The **SD** memory card slot on your computer can accommodate the following memory cards:

- SD memory card
- SDHC memory card
- SDXC memory card



The **SD** memory card slot also works as the "Memory Stick Duo" slot.

For the latest information on compatible memory cards, see **Finding More about Your VAIO Computer** ([page 5](#)) to visit the appropriate support web site.

To insert an SD memory card

- 1 Locate the **SD** memory card slot ([page 15](#)).
- 2 Hold the SD memory card with the arrow pointing toward the slot.
- 3 Carefully slide the SD memory card into the slot until it clicks into place.
Do not force the card into the slot.

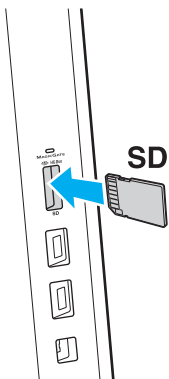

When you insert the SD memory card into the slot for the first time, you may be prompted to install driver software. If prompted, follow the on-screen instructions to install the software.

The SD memory card icon will appear in the **Computer** window after you insert the card into the slot.

To remove an SD memory card

- 1 Locate the **SD** memory card slot ([page 15](#)).
- 2 Check that the media access indicator light is unlit.
- 3 Push in the SD memory card toward the computer and release.
The SD memory card ejects.
- 4 Pull the SD memory card out of the slot.

Notes on Using Memory Cards

General notes on using the memory card

- ❑ Be sure to use memory cards that are compliant with the standards supported by your computer.
- ❑ Be sure to hold the memory card with the arrow pointing in the correct direction as you insert it into the slot. To avoid damaging your computer or the media, do not force the memory card into the slot if you cannot insert it smoothly.
- ❑ Use care when inserting or removing the memory card from the slot. Do not force it in or out of the slot.
- ❑ Do not remove the memory card while the media access indicator light is lit. If you do, you may lose data.
- ❑ Do not attempt to insert a memory card or memory card adaptor of a different type into the memory card slot. An incompatible memory card or memory card adaptor may cause difficulty in removing from the slot and can cause damage to your computer.
- ❑ Do not insert more than one memory card into the slot. Improper insertion of the media may damage both your computer and the media.

Notes on using the SD memory card

- ❑ Your computer has been tested and found compatible only with major memory cards available as of June 2011. However, not all memory cards are guaranteed of compatibility.
- ❑ SD memory cards (up to 2 GB), SDHC memory cards (up to 32 GB), and SDXC memory cards (up to 64 GB) have been tested and found compatible with your computer.
- ❑ Some types of SD memory cards, for example ones with the UHS (Ultra High Speed data transfer feature), may become extremely hot due to continuous access to the memory cards. In such a case, wait for a while before removing the memory card until it cools down.

Using the Internet

Before using the Internet, you need to sign up with an Internet Service Provider (ISP) and set up devices required for connecting your computer to the Internet.

The following types of Internet connection services may be available from your ISP:

- Fiber to the Home (FTTH)
- Digital Subscriber Line (DSL)
- Cable modem
- Satellite
- Dial-up

For detailed information on devices required for Internet access and how to connect your computer to the Internet, ask your ISP.



To connect your computer to the Internet using the wireless LAN function, you need to set up the wireless LAN network. See **Using the Wireless LAN (page 78)** for more information.



When you connect your computer to the Internet, be sure to take appropriate security measures to protect the computer against online threats.

Depending on the service contract with your ISP, you may need to connect an external modem device, for example a USB telephone modem, a DSL modem, or a cable modem, to your computer to connect to the Internet. For detailed instructions on connection setups and modem configuration, see the manual that came with your modem.

Using the Network (LAN)

You can connect your computer to 1000BASE-T/100BASE-TX/10BASE-T type networks with a LAN cable. Connect one end of a LAN cable (not supplied) to the LAN port on the back of the computer and the other end to your network. For detailed settings and devices required for LAN access, ask your network administrator.

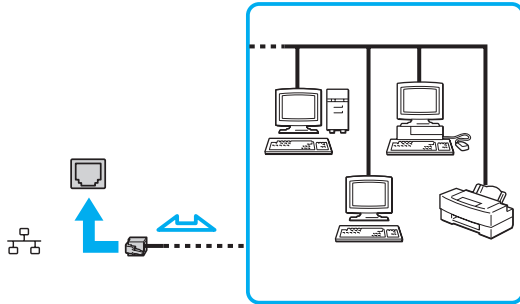

You can connect your computer to any network without changing the default settings.



Do not plug a telephone cable into the LAN port on your computer.

If the LAN port is connected to one of the telephone lines mentioned below, high electric current to the port may cause damage, overheating, or fire.

- Home (intercom speakerphone) or business-use telephone lines (multi-line business telephone)
- Public telephone subscriber line
- Private branch exchange (PBX)

Using the Wireless LAN

The Wireless LAN (WLAN) allows your computer to connect to a network through a wireless connection.



The WLAN uses the following IEEE 802.11a/b/g/n standard, which specifies the type of technology used. See the specifications to find out about the configuration of your computer.

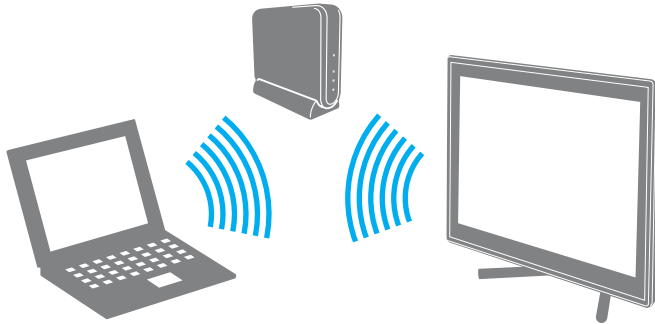

WLAN standard	Frequency band	Remarks
IEEE 802.11a	5 GHz	Available only on models compliant with the IEEE 802.11a/b/g/n standard.
IEEE 802.11b/g	2.4 GHz	The IEEE 802.11g standard provides higher-speed communications than the IEEE 802.11b standard.
IEEE 802.11n	5 GHz/2.4 GHz	On models compliant with the IEEE 802.11b/g/n standard, only the 2.4 GHz band can be used.

Notes on Using the Wireless LAN Function

General notes on using the wireless LAN function

- ❑ In some countries or regions, using WLAN products may be restricted by the local regulations (e.g. limited number of channels).
- ❑ The IEEE 802.11a standard and the IEEE 802.11n standard are not available on ad-hoc networks.
- ❑ The 2.4 GHz band, with which wireless LAN devices work, is used by various devices. Although the wireless LAN devices use the technology to minimize radio interference from other devices that use the same band, such radio interference may cause slower communication speeds and narrower communication ranges or communication failures.
- ❑ The communication speed and range may vary depending on the following conditions:
 - ❑ Distance between communication devices
 - ❑ Existence of obstacles between devices
 - ❑ Device configuration
 - ❑ Radio conditions
 - ❑ Ambient environment that includes existence of walls and materials of such walls
 - ❑ Software in use
- ❑ Communications may be cut off depending on radio conditions.
- ❑ Actual communication speed may not be as fast as the one displayed on your computer.
- ❑ Deploying WLAN products compliant with different standards that use the same band on the same wireless network may reduce the communication speed due to radio interference. Taking this into consideration, WLAN products are designed to reduce the communication speed to ensure communications with another WLAN product if it is compliant with a different standard that uses the same band. When the communication speed is not as fast as expected, changing the wireless channel on the access point may increase the communication speed.

Note on the data encryption



The WLAN standard includes the encryption methods: Wired Equivalent Privacy (WEP), which is a security protocol, Wi-Fi Protected Access 2 (WPA2), and Wi-Fi Protected Access (WPA). Proposed jointly by the IEEE and Wi-Fi Alliance, both WPA2 and WPA are specifications of standards based on interoperable security enhancements that increase the level of data protection and access control for existing Wi-Fi networks. WPA is designed to be forward compatible with the IEEE 802.11i specification. It utilizes the enhanced data encryption Temporal Key Integrity Protocol (TKIP) in addition to user authentication using 802.1X and Extensible Authentication Protocol (EAP). Data encryption protects the vulnerable wireless link between clients and access points. Besides that, there are other typical LAN security mechanisms to ensure privacy, such as: password protection, end-to-end encryption, virtual private networks, and authentication. WPA2, the second generation of WPA, provides stronger data protection and network access control and is also designed to secure all versions of 802.11 devices, including 802.11b, 802.11a, 802.11g, and 802.11n standards, multi-band and multi-mode. In addition, based on the ratified IEEE 802.11i standard, WPA2 provides government grade security by implementing the National Institute of Standards and Technology (NIST) FIPS 140-2 compliant AES encryption algorithm and 802.1X-based authentication. WPA2 is backward compatible with WPA.

Starting Wireless LAN Communications

You first need to establish wireless LAN communications between your computer and an access point (not supplied). See **Windows Help and Support** for more information. For help on setting up a wireless network, click **Start, All Programs**, and **VAIO Easy Connect**, and then follow the on-screen instructions of the **Easy Internet Connection Setup**.

! For details on how to select the channel that will be used by the access point, see the manual that came with your access point.

To start wireless LAN communications

- 1 Make sure an access point is set up.
See the manual that came with your access point for more information.
- 2 Click **Start, All Programs**, and **VAIO Smart Network** or click the **VAIO Smart Network** icon  on the taskbar.
- 3 Click the switch next to **Wireless LAN** to toggle it to **On** in the **VAIO Smart Network** window.
Make sure the **WIRELESS** indicator light turns on.
- 4 Click  or  on the taskbar.
- 5 Select the desired access point and click **Connect**.

Stopping Wireless LAN Communications

To stop wireless LAN communications

Click the switch next to **Wireless LAN** to toggle it to **Off** in the **VAIO Smart Network** window.

! Turning off the wireless LAN function while accessing remote documents, files, or resources may result in data loss.

Using the BLUETOOTH Function

You can establish wireless communications between your computer and other BLUETOOTH® devices such as another computer or a mobile phone. You can transfer data between these devices without cables at a range of up to 10 meters in an open area.

BLUETOOTH Security

The BLUETOOTH wireless technology has an authentication function, which allows you to determine with whom you choose to communicate. With the authentication function, you can prevent any anonymous BLUETOOTH devices from accessing your computer.

The first time two BLUETOOTH devices communicate, a common passkey (a password required for authentication) should be determined for both devices to be registered. Once a device is registered, there is no need to re-enter the passkey.



The passkey can be different each time, but must be the same at both ends.

For certain devices, such as a mouse, no passkey can be entered.

Communicating with Another BLUETOOTH Device

You can connect your computer to a BLUETOOTH device such as another computer, a mobile phone, a PDA, a headset, a mouse, or a digital camera without the use of any cables.



To communicate with another BLUETOOTH device

To communicate with another BLUETOOTH device, you first need to set up the BLUETOOTH function. For information on setting up and using the BLUETOOTH function, see **Windows Help and Support**.

- 1 Click **Start, All Programs, and VAIO Smart Network** or click the **VAIO Smart Network** icon  on the taskbar.
- 2 Click the switch next to **BLUETOOTH** to toggle it to **On** in the **VAIO Smart Network** window. Make sure the **WIRELESS** indicator light turns on.

Stopping BLUETOOTH Communications

To stop BLUETOOTH communications

- 1 Turn off the BLUETOOTH device that is communicating with your computer.
- 2 Click the switch next to **BLUETOOTH** to toggle it to **Off** in the **VAIO Smart Network** window.

Notes on Using the BLUETOOTH Function

- ❑ The data transfer rate varies, depending on the following conditions:
 - ❑ Obstacles, such as walls, located between devices
 - ❑ Distance between devices
 - ❑ Material used in walls
 - ❑ Proximity to microwaves and cordless telephones
 - ❑ Radio frequency interference and other environmental conditions
 - ❑ Device configuration
 - ❑ Type of software application
 - ❑ Type of operating system
 - ❑ Use of both wireless LAN and BLUETOOTH functions at the same time on your computer
 - ❑ Size of file being exchanged
- ❑ Large files may occasionally be corrupted during continuous transfer due to limitations of the BLUETOOTH standard and electromagnetic interference in the environment.
- ❑ All BLUETOOTH devices must be certified to make sure that the applicable standard requirements are maintained. Even if standards are met, individual device performance, specifications, and operation procedures can vary. Data exchange may not be possible in all situations.
- ❑ Video and audio may not be synchronized if you play videos on your computer with audio output from a connected BLUETOOTH device. This is a frequent occurrence with BLUETOOTH technology and does not indicate a malfunction.
- ❑ The 2.4 GHz band, with which BLUETOOTH devices or wireless LAN devices work, is used by various devices. Although BLUETOOTH devices use the technology to minimize radio interference from other devices that use the same band, such radio interference may cause slower communication speeds and shorter distances or communication failures.

- ❑ The BLUETOOTH function may not work with other devices, depending on the manufacturer or the software version employed by the manufacturer.
- ❑ Connecting multiple BLUETOOTH devices to your computer may cause channel congestion, resulting in poor performance of the devices. This is normal with BLUETOOTH technology and does not indicate a malfunction.
- ❑ High-speed communications between your computer and BLUETOOTH devices are available when they are compliant with BLUETOOTH high speed technology. For the high-speed communications, enable both the wireless LAN and BLUETOOTH functions on the computer.



See the specifications to find out about the configuration of your computer.

Using Peripheral Devices

You can add functionality to your VAIO computer by using the various ports on the computer.

- ❑ **Connecting External Speakers or Headphones** ([page 89](#))
- ❑ **Connecting an External Display** ([page 90](#))
- ❑ **Selecting Display Modes** ([page 97](#))
- ❑ **Using the Multiple Monitors Function** ([page 98](#))
- ❑ **Connecting an External Microphone** ([page 100](#))
- ❑ **Connecting a USB Device** ([page 101](#))
- ❑ **Connecting an i.LINK Device** ([page 103](#))

Connecting External Speakers or Headphones

You can connect external sound output devices (not supplied), such as speakers or headphones, to your computer.

To connect external speakers



Make sure your speakers are designed for computer use.



Turn down the volume of the speakers before you turn them on.

Connect external speakers (1) to the headphones jack (2) with a speaker cable (3) (not supplied).

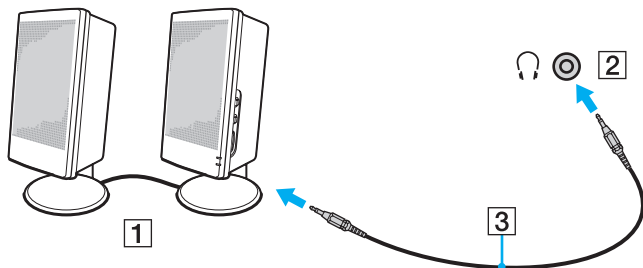

Connecting an External Display



Some features and options in this section may not be available on your computer.

Connecting a Computer Display

You can connect an external display, such as a computer display, to your computer.

To connect a computer display

- 1 Plug the power cord (1) of your external display into an AC outlet.
- 2 Plug one end of a display cable (2) to an HDMI to DVI-D adapter (3) and the other end to the external display.
- 3 Plug one end of an HDMI cable (4) to the HDMI to DVI-D adapter (3) and the other end to the **HDMI OUTPUT** port (5) on the computer.

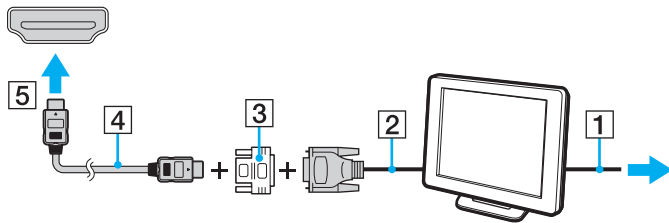

! Your computer is compliant with the HDCP standard and capable of encrypting the transmission channel of digital video signals for the purpose of copyright protection, which enables you to play and view a wide variety of copyright protected and high-quality content. To view the copyright protected content, connect an HDCP-compliant monitor to your computer. If your computer has a non-compliant monitor connected, you will not be able to play or view any copyright protected content.



If the external computer display is equipped with an HDMI input port, plug one end of an HDMI cable into the **HDMI OUTPUT** port on the computer and the other end into the HDMI input port on the computer display.

To connect a TFT/DVI monitor, use an HDMI to DVI-D adapter to connect it to the **HDMI OUTPUT** port on the computer.

The HDMI cable carries both video and audio signals.

Connecting a TV with an HDMI Input Port

You can connect a TV with an HDMI input port to your computer.

To connect a TV to your computer

! To hear sound from the device connected to the **HDMI OUTPUT** port, you need to change the device for sound output. For detailed instructions, see **How do I change the sound output device?** ([page 171](#)).

- 1 Plug the power cord of your TV (1) into an AC outlet.
- 2 Plug one end of an HDMI cable (2) to the **HDMI OUTPUT** port (3) on the computer and the other end to the TV.
- 3 Switch the input channel of the TV to external input.
- 4 Set up the TV configuration system.

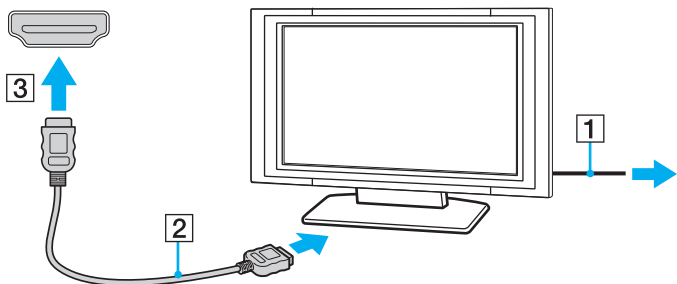

! If a device driver other than the one provided by Sony is used, the image will not be displayed and the audio will not be heard. Always use the device driver provided by Sony for updates.



See the manual that came with your TV for more information on installation and use.

The HDMI cable carries both video and audio signals.

Playing Blu-ray 3D Disc media



Some features and options may not be available on your computer.
See the specifications to find out about the configuration of your computer.

On models with the Blu-ray Disc Drive, you can play Blu-ray 3D Disc media and view 3D images on a 3D-capable display, such as a 3D TV, by connecting the display to the computer with an HDMI cable.



Be sure to follow the instructions in the manuals that came with your VAIO computer when viewing 3D images.

On models not equipped with a 3D-capable LCD screen, you can output 3D images to a 3D-capable display only when playing Blu-ray 3D Disc media on the computer.

Be sure to use the 3D glasses specified by the TV manufacturer while viewing 3D images.



See the manual that came with your 3D TV for detailed information on the 3D function.

Before viewing 3D images on a 3D-capable display, you first need to complete the initial setup.

- ❑ If your computer is equipped with a 3D-capable LCD screen, refer to the **Enjoying 3D: Information Guide** to initialize NVIDIA 3D Vision.
- ❑ If your computer is equipped with the NVIDIA video controller but not with a 3D-capable LCD screen, follow these steps to initialize NVIDIA 3D Vision.
 - 1 Follow the steps in **To connect a TV to your computer (page 92)** for connecting your 3D TV to the computer with an HDMI cable and set up the TV configuration system.
 - 2 Press the **Windows+P** keys to change the display output to an external display.
 - 3 Right-click on the desktop and select **NVIDIA Control Panel**.

- 4 Select an item for the 3D function settings.
- 5 Click to select a check box to enable the 3D function.
- 6 Follow the instructions in the initialization wizard.
After the settings are complete, playback of the 3D-demo video automatically starts. To stop the playback, press the **Esc** key.

To play Blu-ray 3D Disc media

- 1 Follow the steps in **To connect a TV to your computer** ([page 92](#)) for connecting your 3D TV to the computer with an HDMI cable and set up the TV configuration system.
- 2 Press the **Windows+P** keys to change the display output to an external display.
If your computer is equipped with a 3D-capable LCD screen, you need to change the screen resolution settings. Proceed to the next step.
If your computer is not equipped with a 3D-capable LCD screen, skip steps 3 to 5.
- 3 Click **Start, All Programs, and VAIO Control Center**.
- 4 Click **Display and HDMI Resolution Setting Configuration**.
- 5 Select **1080 (3D)** or **720 (3D)**.

!
To play 2D content, select **1080 (2D)** or **720 (2D)**.
- 6 Click **Start, All Programs, Corel, and Corel WinDVD BD**.
- 7 Insert Blu-ray 3D Disc media into the optical disc drive.

To connect a high-quality digital sound output device between your computer and a TV

You can connect a high-quality home theater receiver or other surround sound decoder devices between your computer and TV using an HDMI connection.



Before connecting the device to the computer, make sure the HDMI connection has been set up between the TV and the home theater receiver or surround sound decoder device first.

To hear sound from the device connected to the **HDMI OUTPUT** port, you need to change the device for sound output. For detailed instructions, see **How do I change the sound output device?** ([page 171](#)).

- 1 Turn on the TV and set its input to the HDMI input.
- 2 Turn on the home theater receiver or surround sound decoder device and set its input to the HDMI input.
- 3 Plug one end of an HDMI cable to the HDMI input port on the home theater receiver or surround sound decoder device and the other end to the **HDMI OUTPUT** port on the computer.



You can adjust the screen resolution of the connected TV with your computer. See **Why doesn't my screen display a video?** ([page 160](#)) for more information.

With the HDMI connection, the volume can be adjusted by the connected audio device only. Your computer has no control over the output volume of any connected devices.

Selecting Display Modes

When an external display is connected, you can select either your computer screen or the connected display to use as the primary monitor.



You may not be able to display the same content on your computer screen and the external display at the same time, depending on the type of your external display.

Turn on the external display before turning on your computer.

To select a display mode from the display settings

- 1 Right-click on the desktop and select **Screen resolution**.
- 2 Click the drop-down list next to **Multiple Displays**, select your desired setting, and then click **OK**.

Using the Multiple Monitors Function

The Multiple Monitors function allows you to distribute portions of your desktop across separate displays. For example, if you have an external display connected to your computer, your computer screen and the external display can function as a single desktop.

You can move the cursor from one display to the other. This allows you to drag objects, such as an open application window or a toolbar, from one display to the other.

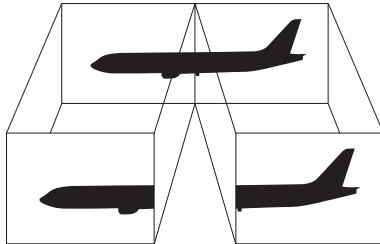

To use the Multiple Monitors function



Your external display may not support the Multiple Monitors function.

Certain software applications may not be compatible with Multiple Monitors settings.

Make sure that your computer does not enter Sleep mode while you are using the Multiple Monitors function, or the computer may not return to Normal mode.

If you set different colors on each display, do not expand a single window across two displays, or your software may not work properly.

- 1 Right-click on the desktop and select **Screen resolution**.
- 2 Click the drop-down list next to **Multiple Displays**, select **Extend these displays**, and then click **OK**.



You can set the display colors and resolution for each display and customize the Multiple Monitors function.

Set fewer colors or a lower resolution for each display.

Connecting an External Microphone

You can connect an external microphone (not supplied) to your computer.

To connect an external microphone

Plug the microphone cable (1) into the microphone jack (2) .

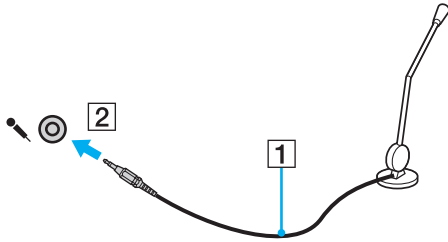

Make sure your microphone is designed for computer use.

Connecting a USB Device

You can connect a Universal Serial Bus (USB) device, such as a mouse, a floppy disk drive, a speaker, or a printer, to your computer.

To connect a USB device

- 1 Choose the USB port (1) you prefer to use.
- 2 Plug the USB device cable (2) into the USB port.

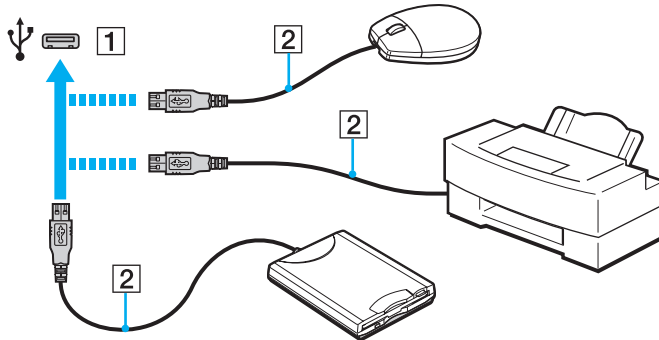

Notes on connecting a USB device

- ❑ You may need to install the driver software supplied with your USB device before use. See the manual that came with the USB device for more information.
- ❑ Be sure to use a USB printer compatible with your version of Windows to print documents.
- ❑ For information on how to remove a USB device, see the manual that came with the device.
- ❑ To protect your computer and/or USB devices from damage, observe the following:
 - ❑ When moving the computer with USB devices connected, avoid exposing the USB ports to shock or impact.
 - ❑ Do not put the computer into a bag or carrying case when it has USB devices connected.

Connecting an i.LINK Device

Your computer is equipped with an i.LINK port which you can use to connect an i.LINK device, such as a digital video camcorder.



i.LINK is a trademark of Sony Corporation used only to designate that a product contains an IEEE 1394 connection. The procedure to establish an i.LINK connection may vary, depending on a software application, an operating system, and a compatible i.LINK device. Not all products with an i.LINK connection can communicate with each other. See the manual that came with your compatible i.LINK device for more information on operating conditions and proper connection. Before connecting compatible i.LINK PC peripherals to your system, such as a CD-RW or hard disk drive, confirm their operating system compatibility and required operating conditions.

Notes on connecting i.LINK devices

- ❑ The i.LINK port on your computer does not supply power to an external device. If the external device requires external power, be sure to connect it to a power source.
- ❑ The i.LINK port supports transfer rates up to 400 Mbps. However, the actual transfer rate depends on the transfer rate of the external device.
- ❑ The optional i.LINK cables may not be available in some countries or regions.
- ❑ An i.LINK connection with other compatible devices is not fully guaranteed.
- ❑ The i.LINK connection may not be available depending on the software applications, operating system, and i.LINK-compatible devices you use. See the manual that came with your software for more information.
- ❑ Check the working conditions and operating system compatibility of i.LINK-compatible PC peripherals (for example, an HDD or a CD-RW drive) before you connect them to your computer.

Connecting a Digital Video Camcorder

To connect a digital video camcorder

Plug one end of an i.LINK cable (1) (not supplied) into the i.LINK port (2) on the computer and the other end into the DV In/Out port (3) on the digital video camcorder.

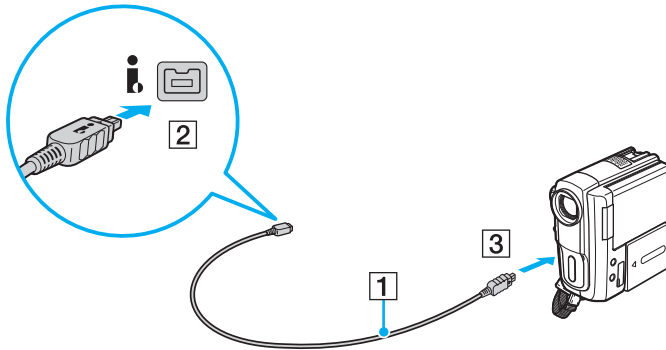

 The connection procedure varies depending on your compatible i.LINK device. See the manual that came with the device for more information.

You cannot access the contents of "Memory Stick" in the digital video camcorder via an i.LINK connection.

Customizing Your VAIO Computer



This section briefly describes how to change the main settings of your VAIO computer. Among other things, you will learn how to use and customize the look of your Sony software and utilities.

- ❑ **Setting the Password** ([page 106](#))
- ❑ **Using the VAIO Control Center** ([page 112](#))

Setting the Password

Setting the password allows you to protect your computer from unauthorized access by making the user enter the password when the computer is turned on or returns to Normal mode from Sleep mode.

! Do not forget your password. Write down the password and keep it in a secure place.

Type of Password	Description
Power-on password	<p>You can use BIOS functions to set two types of passwords:</p> <ul style="list-style-type: none">- Machine password: Allows users with administrative rights to change all the setup options in the BIOS setup screen, as well as to start the computer.- User password: Allows the standard users to change some of the BIOS setup options, as well as to start the computer. To set the user password, you must first set the machine password. <p> Entry of the power-on password will be prompted after the VAIO logo appears to start your computer.</p> <p>! If you forget the machine password, the password needs to be reset and a fee will be charged. To reset the password, contact an authorized Sony service/support center. To find the nearest center or agent, see Finding More about Your VAIO Computer (page 5). You can reset the user password at the BIOS setup screen by entering the machine password.</p>
Windows password	<p>Allows users to log onto your computer and protect each user account with its own password.</p> <p> Entry of the Windows password will be prompted after you select your user account.</p>

Setting the Power-on Password

To add the power-on password (machine password)

- 1 Turn on the computer and press the **F2** key repeatedly until the VAIO logo disappears.
The BIOS setup screen appears. If the screen does not appear, restart the computer and try again.
- 2 Press the **←** or **→** key to select **Security** to display the **Security** tab, select **Set Machine Password**, and then press the **Enter** key.
- 3 On the password entry screen, enter the password twice and press the **Enter** key.
The password can be up to 32 alphanumeric characters long (including spaces).
- 4 Select **Password when Power On** under **Security** and press the **Enter** key.
- 5 Change the setting from **Disabled** to **Enabled**.
- 6 Press the **←** or **→** key to select **Exit**, select **Exit Setup**, and then press the **Enter** key.
At the confirmation prompt, press the **Enter** key.

To add the power-on password (user password)

! Make sure you set the machine password before setting the user password.

- 1 Turn on the computer and press the **F2** key repeatedly until the VAIO logo disappears. The BIOS setup screen appears. If the screen does not appear, restart the computer and try again.
- 2 Enter the machine password and press the **Enter** key.
- 3 Press the **←** or **→** key to select **Security** to display the **Security** tab, select **Set User Password**, and then press the **Enter** key.
- 4 On the password entry screen, enter the password twice and press the **Enter** key. The password can be up to 32 alphanumeric characters long (including spaces).
- 5 Press the **←** or **→** key to select **Exit**, select **Exit Setup**, and then press the **Enter** key. At the confirmation prompt, press the **Enter** key.

To change or remove the power-on password (machine password)

- 1 Turn on the computer and press the **F2** key repeatedly until the VAIO logo disappears. The BIOS setup screen appears. If the screen does not appear, restart the computer and try again.
- 2 Enter the machine password and press the **Enter** key.
- 3 Press the **←** or **→** key to select **Security** to display the **Security** tab, select **Set Machine Password**, and then press the **Enter** key.
- 4 On the password entry screen, enter the current password once and a new password twice, and then press the **Enter** key. To remove the password, leave the **Enter New Password** and **Confirm New Password** fields blank and press the **Enter** key.
- 5 Press the **←** or **→** key to select **Exit**, select **Exit Setup**, and then press the **Enter** key. At the confirmation prompt, press the **Enter** key.

To change or remove the power-on password (user password)

- 1 Turn on the computer and press the **F2** key repeatedly until the VAIO logo disappears.
The BIOS setup screen appears. If the screen does not appear, restart the computer and try again.
- 2 Enter the user password and press the **Enter** key.
- 3 Press the **←** or **→** key to select **Security** to display the **Security** tab, select **Set User Password**, and then press the **Enter** key.
- 4 On the password entry screen, enter the current password once and a new password twice, and then press the **Enter** key.
To remove the password, leave the **Enter New Password** and **Confirm New Password** fields blank and press the **Enter** key.
- 5 Press the **←** or **→** key to select **Exit**, select **Exit Setup**, and then press the **Enter** key.
At the confirmation prompt, press the **Enter** key.

Setting the Windows Password

To add the Windows password

- 1 Click **Start** and **Control Panel**.
- 2 Click **User Accounts and Family Safety** or **User Accounts**.
- 3 Click **User Accounts**.
- 4 Click **Create a password for your account** under **Make changes to your user account**.
- 5 In the **New password** and **Confirm new password** fields, enter the password for your account.
- 6 Click **Create password**.



See **Windows Help and Support** for more information on the Windows password.

To change the Windows password

- 1 Click **Start** and **Control Panel**.
- 2 Click **User Accounts and Family Safety** or **User Accounts**.
- 3 Click **User Accounts**.
- 4 Click **Change your password**.
- 5 In the **Current password** field, enter your current password.
- 6 In the **New password** and **Confirm new password** fields, enter a new password.
- 7 Click **Change password**.

To remove the Windows password

- 1 Click **Start** and **Control Panel**.
- 2 Click **User Accounts and Family Safety** or **User Accounts**.
- 3 Click **User Accounts**.
- 4 Click **Remove your password**.
- 5 In the **Current password** field, enter the current password that you want to remove.
- 6 Click **Remove password**.

Using the VAIO Control Center

The **VAIO Control Center** utility allows you to access system information and to specify preferences for system behavior.

To use the VAIO Control Center

- 1 Click **Start**, **All Programs**, and **VAIO Control Center**.
- 2 Select your desired control item and change the settings.
- 3 Once finished, click **OK**.
The setting of the desired item is changed.



For more information about each option, see the help file included with the **VAIO Control Center**.

Some of the control items will not be visible if you open the **VAIO Control Center** as a standard user.

Using S-FORCE Front Surround 3D

S-FORCE Front Surround 3D is a virtual surround technology which allows you to enjoy powerful and realistic surround sound using the built-in speakers. Its effect is especially noticeable when you are watching movies.

To enable S-FORCE Front Surround 3D

- 1 Click **Start**, **All Programs**, and **VAIO Control Center**.
- 2 Click **Sound** and **Sound Effect Settings**.
- 3 Click **Use S-FORCE Front Surround 3D** and **OK**.



S-FORCE Front Surround 3D works only on sound output from the built-in speakers.

Simultaneous use of S-FORCE Front Surround 3D and Dolby Home Theater v4 is not possible.



To achieve maximum effect of S-FORCE Front Surround 3D, place your computer directly across from your listening position and stay within the optimum distance: approximately 1 m from the computer.

Changing the default SONY logo lamp activity

The **SONY** logo lamp illuminates when you turn on your computer. You can change this default activity of the lamp to make it stay unlit by following these steps:

- 1 Click **Start, All Programs**, and **VAIO Control Center**.
- 2 Click **Display** and **Logo Lamp Control**.
- 3 Follow the on-screen instructions.

!
You cannot change this option for the HDMI input. To change settings, see **Using the OSD Menu (page 63)** for the procedure.

Upgrading Your VAIO Computer

Your VAIO computer and memory modules use high precision components and electronic connectors technology. To avoid invalidation of the warranty during your product warranty period, we recommend that:

- You should contact your dealer to install a new memory module.
- You should not install it yourself, if you are not familiar with upgrading memory on a computer.
- You should not touch the connectors or open the memory module compartment cover.

For assistance, contact an authorized Sony service/support center. To find the nearest center or agent, see **Finding More about Your VAIO Computer** ([page 5](#)).



The type of module and the amount of memory installed on your computer may differ depending on the model you purchased. See the specifications to find out about the configuration of your computer.

Adding and Removing Memory

If you want to expand the functionality of your computer, you can increase the amount of memory by installing optional memory modules. Before you upgrade your computer's memory, read the notes and procedures in the following pages.

Notes on adding/removing memory modules

- ❑ Be sure to place your computer on a flat surface before adding or removing memory modules.
- ❑ Be careful when changing memory. Improper installation of memory modules may cause damage to your system. This damage may void your manufacturer's warranty.
- ❑ Only use memory modules that are compatible with your computer. If a memory module is not detected by the computer or the Windows operating system becomes unstable, contact the sales dealer or the manufacturer of your memory module.
- ❑ Electrostatic discharge (ESD) can damage electronic components. Before touching a memory module, ensure the following:
 - ❑ The procedures described in this document assume user familiarity with the general terminology associated with personal computers and with the safety practice and regulatory compliance requirements for using and modifying electronic equipment.
 - ❑ Turn off your computer and disconnect it from the AC adapter and from any telecommunication links, networks, or modems before you remove any cover or panel from the computer. Failure to do so may result in personal injury or equipment damage.
 - ❑ ESD can damage memory modules and other components. Install the memory module only at an ESD workstation. If such a station is not available, do not work in a carpeted area, and do not handle materials that produce or hold static electricity (cellophane wrappers, for example). Ground yourself by maintaining contact with an unpainted metal portion of the chassis while performing the procedure.

- Do not open the memory module package before you are ready to change the module. The package protects the module from ESD.
- Use the special bag supplied with the memory module or wrap the module in aluminum foil to protect it from ESD.
- Introducing any liquids, foreign substances, or objects into the memory module slots or other internal components of your computer will result in damage to the computer and any repair costs will not be covered by the warranty.
- Do not place the memory module in a location subject to:
 - Heat sources such as radiators or air ducts
 - Direct sunlight
 - Excessive dust
 - Mechanical vibration or shock
 - Strong magnets or speakers that are not magnetically shielded
 - Ambient temperature of more than 35°C or less than 10°C
 - High humidity
- Handle the memory module with care. To avoid injuries to your hands and fingers, do not touch the edges of the components and circuit boards inside your computer.

Removing and Installing a Memory Module

To change or add a memory module

- 1 Shut down the computer, turn off all peripheral devices, and disconnect the AC adapter and the peripheral devices from the power sources.
- 2 Gently face down your computer on a flat surface and wait about an hour until the computer cools down.

! When facing down your computer, be sure to place it on a soft cloth to avoid damage to the screen frame.

- 3 Remove the four screws and take the foot stand off the computer.

! The foot stand is securely attached to your computer. While holding down the bottom part of the main unit, firmly grasp the foot stand and pull the stand out of the unit.

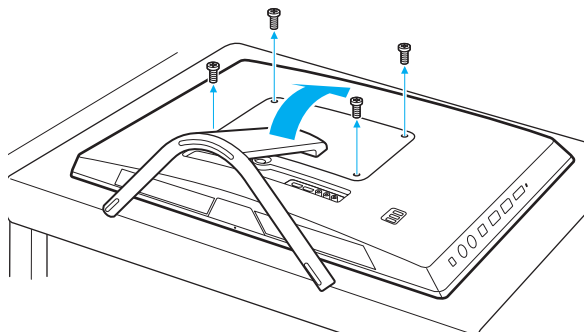

! Be careful not to lose the removed screws.

- 4 Touch a metal object to discharge static electricity.
- 5 Remove the currently installed memory module as follows:
 - Pull the latches in the direction of the arrows (1).
The memory module is released.
 - Make sure that the memory module tilts up and then pull it out in the direction of the arrow (2).

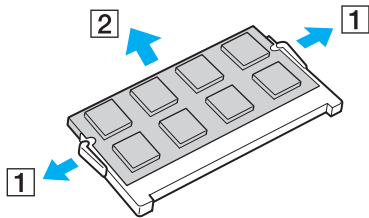

- 6 Remove the new memory module from its packaging.

- 7 Slide the memory module into the memory module slot and push it in until it clicks into place.

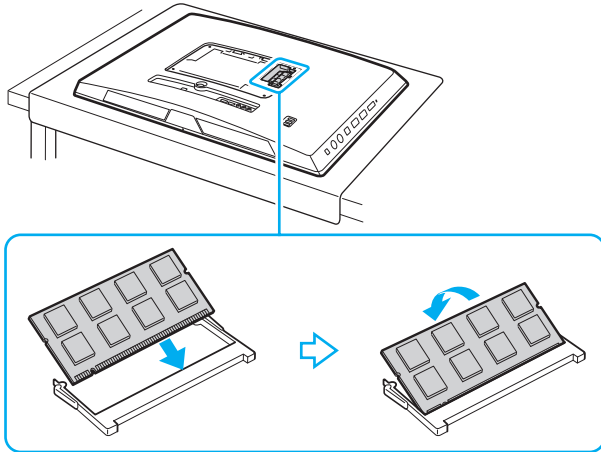

! Do not touch any components on the motherboard other than the memory module.

If you want to install only one memory module, be sure to use the lower slot.

Be sure to insert the connector edge of the memory module into the slot while aligning the notch on the module with the small projection in the open slot. Do not force the memory module into the slot in a wrong orientation, as it may cause damage to the slot and the module.

- 8 Replace the foot stand and tighten the screws.
- 9 Connect the AC adapter and the peripheral devices to the computer, and then plug them into power sources.
- 10 Turn on all peripheral devices and then the computer.

Viewing the Amount of Memory

To view the amount of memory

- 1 Turn on the computer.
- 2 Click **Start, All Programs, and VAIO Control Center.**
- 3 Click **System Information** and **System Information.**

You can view the amount of system memory in the right pane. If the additional memory does not appear, repeat the installation procedure and restart the computer.

Precautions

This section describes safety guidelines and precautions to help you protect your VAIO computer from potential damage.



Some features and options in this section may not be available on your computer.

- Safety Information** ([page 123](#))
- Care and Maintenance Information** ([page 125](#))
- Handling Your Computer** ([page 126](#))
- Handling the LCD Screen/Touch Screen** ([page 128](#))
- Using the Power Source** ([page 129](#))
- Handling the Built-in Camera** ([page 130](#))
- Handling Discs** ([page 131](#))
- Handling "Memory Stick"** ([page 132](#))
- Handling the Built-in Storage Device** ([page 133](#))

Safety Information

Computer

- Use your computer on a solid, stable surface.
- Do not grasp the foot stand to lift your computer as the stand may break and cause the main unit to fall, resulting in damage to the computer or personal injuries.
- Use only specified peripheral equipment and interface cables.
- Keep small parts such as "Memory Stick" and "Memory Stick" adaptors out of reach of children. There is a risk of swallowing them.

Power Source

- Do not place the AC adapter in contact with your skin. Remove the AC adapter away from your body if it becomes warm and causes discomfort.
- Do not place heavy objects on the power cord, or this could cause a fire.
- To disconnect the power cord, pull it out by holding the plug. Never pull the cord itself.
- Unplug your computer from the AC outlet if you are not planning to use the computer for an extended period of time.
- Make sure that an AC outlet is easily accessible.

Battery Cell

If the battery liquid is leaking:

- Do not touch the battery liquid directly.
- Be sure to follow the instructions below.
If your eyes, skin, or clothing comes into contact with the battery liquid, wash well with pure water. If you have skin inflammation or a wound results, consult a doctor immediately.
- Do not throw the battery into a fire. Never heat, disassemble, modify, charge, nor get battery wet.
- Be sure to use a commercially available alkaline AA battery.

Mouse

- Do not look directly at the red light from the bottom of the optical mouse. Doing so could cause injury.
- Do not look directly into the lens at the bottom of the laser mouse. Doing so could cause eye injuries. The laser light is invisible.

Headphones

Preventing hearing damage – Avoid using headphones at high volume. Hearing experts advise against continuous, loud and extended play. If you experience a ringing in your ears, reduce the volume or discontinue use.

Care and Maintenance Information

Computer

- ❑ Clean the cabinet with a soft, dry or lightly moistened cloth with a mild detergent solution. Do not use an abrasive pad, scouring powder, or solvent such as alcohol or benzene, as these may damage the finish of your computer.
- ❑ Make sure you unplug the AC adapter before cleaning your computer.

LCD Screen/Touch Screen

Use a soft, dry cloth to wipe the surface of the LCD screen/touch screen. Rubbing the surface could damage the screen.

Built-in Camera

Clean the area on and around the built-in camera with a soft, dry cloth. Do not rub the area too hard, as it can be easily scratched.

Discs

- ❑ Proper care of the disc is essential to its continuous reliability. Do not use solvents (such as benzene, thinner, alcohol, commercially available cleaners, or anti-static spray) which may cause damage to the disc.
- ❑ For normal cleaning, hold the disc by its edges and use a soft cloth to wipe the surface from the center out.
- ❑ If the disc is badly soiled, moisten a soft cloth with water, wring it out well, and use it to wipe the surface of the disc from the center out. Wipe off any remaining moisture with a dry soft cloth.

Handling Your Computer

- ❑ If you drop a solid object or any liquid onto your computer, shut down the computer and then unplug it. You may want to have the computer checked by qualified personnel before operating it again.
- ❑ Do not drop your computer.
- ❑ Do not place your computer in a location subject to:
 - ❑ Heat sources, such as radiators or air ducts
 - ❑ Direct sunlight
 - ❑ Excessive dust
 - ❑ Moisture or rain
 - ❑ Mechanical vibration or shock
 - ❑ Strong magnets or speakers that are not magnetically shielded
 - ❑ Ambient temperature of more than 35°C or less than 10°C
 - ❑ High humidity
- ❑ Do not place electronic equipment near your computer. The electromagnetic field of the equipment may cause the computer to malfunction.
- ❑ Your computer uses high-frequency radio signals and may cause interference to radio or TV reception. If this occurs, move the computer a suitable distance away from the radio or TV.
- ❑ Do not use cut or damaged connection cables.
- ❑ If your computer is brought directly from a cold location to a warm one, moisture may condense inside the computer. In such a case, allow at least one hour before turning on the computer. If any problems occur, unplug the computer and contact an authorized Sony service/support center. To find the nearest center or agent, see **Finding More about Your VAIO Computer (page 5)**.

- ❑ To avoid losing data when your computer is damaged, back up your data regularly.
- ❑ To lift or move your computer, grasp the main unit on the sides with both hands from behind the computer to avoid any damage to the LCD screen/touch screen. There is a risk of scratching the LCD screen/touch screen, for example with your waist belt buckle, if you hold your computer from its front.
- ❑ Be careful not to scratch your desk with the tip of the foot stand when moving your computer.

Handling the LCD Screen/Touch Screen

- ❑ Due to the mechanical design of your computer's LCD screen/touch screen, some areas of the screen surface may become warm while you are using the computer for an extended period of time. This is normal and does not indicate a malfunction.
- ❑ Do not exert pressure on the LCD screen/touch screen surface in any way. The LCD screen/touch screen is made of reinforced glass to implement high durability but is not 100% unbreakable.
- ❑ Do not exert pressure on the LCD screen/touch screen frame. This may cause lower touch sensitivity or malfunctions.
- ❑ Be sure to use your finger(s) for touch works. Using a thin or thick object for touch works may result in an unintentional operation as well as unwanted scratches on the LCD screen/touch screen surface.
- ❑ Keep the LCD screen/touch screen, especially the frame sill, clean for good touch sensitivity. When cleaning the LCD screen/touch screen, be sure to use a soft, dry cloth to gently wipe its surface and the screen frame.
- ❑ Do not use or leave the LCD screen/touch screen under high-intensity light, for example direct sunlight, to avoid malfunctions or damage.
- ❑ Using your computer in low temperature conditions may produce a residual image on the LCD screen/touch screen. This does not indicate a malfunction. When the computer returns to normal temperature, the screen returns to normal.
- ❑ A residual image may appear on the LCD screen/touch screen if the same image is displayed for an extended period of time. The residual image disappears after a while. You can use a screen saver to prevent residual images.
- ❑ The LCD screen/touch screen is manufactured using high-precision technology. You may, however, see tiny black points and/or bright points (red, blue, or green) that continuously appear on the screen. This is a normal result of the manufacturing process and does not indicate a malfunction.

Using the Power Source

- ❑ Do not share an AC outlet with other power-consuming equipment, such as a photocopier or a shredder.
- ❑ You can purchase a power strip with a surge protector. This device helps prevent damage to your computer caused by sudden power surges, in an electrical storm, for example.
- ❑ Use the AC adapter supplied with your computer or genuine Sony products. Do not use any other AC adapter as it may cause a malfunction.

Handling the Built-in Camera

- ❑ Do not scratch or soil the area on and around the built-in camera, as it may cause poor quality images.
- ❑ Do not let the direct sunlight get into the lens of the built-in camera regardless of your computer's power state, as it may cause the camera to malfunction.

Handling Discs

- ❑ Fingerprints and dust on the surface of a disc may cause read errors. Be sure to hold the disc by its edges and central hole, as shown below:

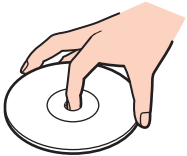

- ❑ Never affix an adhesive label to a disc. This will affect the use of the disc and may result in irreparable damage.

Handling "Memory Stick"

- ❑ Do not touch the "Memory Stick" connector with your finger or metallic objects.
- ❑ Use only the adhesive label supplied with "Memory Stick".
- ❑ Do not bend, drop, or expose "Memory Stick".
- ❑ Do not disassemble or modify "Memory Stick".
- ❑ Keep "Memory Stick" dry.
- ❑ Do not use or store "Memory Stick" in a location subject to:
 - ❑ Static electricity
 - ❑ Electrical noise
 - ❑ Extremely high temperatures, such as in a car parked in the sun
 - ❑ Direct sunlight
 - ❑ High humidity
 - ❑ Corrosive substances
- ❑ Use the storage case supplied with "Memory Stick".
- ❑ Be sure to make a backup copy of your valuable data.
- ❑ When using "Memory Stick Duo", do not use a fine-tipped pen to write on the label adhered to "Memory Stick Duo". Exerting pressure on the media may damage internal components.

Handling the Built-in Storage Device

The built-in storage device (hard disk drive or solid state drive) has a high storage density and reads or writes data in a short time. However, it can be easily damaged if improperly used. If the built-in storage device is damaged, the data cannot be restored. To prevent losing data, you should be careful when handling your computer.

To avoid damaging your built-in storage device

- Do not subject your computer to sudden movements.
- Keep your computer away from magnets.
- Do not place your computer in a location subject to mechanical vibration or in an unstable position.
- Do not turn off the power or restart your computer while reading or writing data to the storage device.
- Do not use your computer in a place subject to extreme changes in temperature.
- Do not remove the storage device from your computer.

Troubleshooting

This section describes how to solve common problems you might encounter when using your VAIO computer. Many problems have simple solutions. If these suggestions fail to solve your problems, use the **VAIO Care**. To launch the software, see **Using the VAIO Care (page 26)**.

If the problems still cannot be solved and you need assistance, visit the support web sites listed in **Finding More about Your VAIO Computer (page 5)**.



Some features and options in this section may not be available on your computer.

- Computer Operations (page 136)**
- System Update / Security (page 141)**
- Recovery / Recovery Media (page 142)**
- Partition (page 143)**
- Built-in Camera (page 144)**
- Networking (LAN/Wireless LAN) (page 146)**
- BLUETOOTH Technology (page 150)**
- Optical Discs (page 153)**
- Display (page 158)**
- Printing (page 162)**
- Microphone (page 163)**
- Mouse (page 164)**
- Speakers (page 166)**



- ❑ **Touch Screen** ([page 168](#))
- ❑ **Keyboard** ([page 169](#))
- ❑ **Floppy Disks** ([page 170](#))
- ❑ **Audio/Video** ([page 171](#))
- ❑ **HDMI/VIDEO Input Function** ([page 174](#))
- ❑ **"Memory Stick"** ([page 175](#))
- ❑ **Peripherals** ([page 176](#))

Computer Operations

What should I do if my computer does not start?

- ❑ Make sure your computer is securely plugged into a power source and turned on and the power indicator light shows the power is on.
- ❑ Disconnect all connected USB devices (if any), and then restart your computer.
- ❑ Remove any extra memory modules you may have installed since purchase, and then restart your computer.
- ❑ If your computer is plugged into a power strip or an uninterruptible power supply (UPS), make sure the power strip or UPS is plugged into a power source and turned on.
- ❑ If the orange **DISPLAY OFF** indicator light is lit, press the **DISPLAY OFF** button.
- ❑ Make sure the brightness and contrast controls are adjusted correctly.
- ❑ Make sure the computer input is selected as the audio/video input source. To change the display input, press the **INPUT/OK** button on the computer ([page 62](#)).
- ❑ Unplug the AC adapter. Wait three to five minutes. Plug the AC adapter again and press the power button to turn on your computer.
- ❑ Condensation may cause your computer to malfunction. If this occurs, do not use the computer for at least one hour.
- ❑ Check that you are using the supplied Sony AC adapter. For your safety, use only the genuine Sony AC adapter, which is supplied by Sony for your VAIO computer.
- ❑ Make sure your computer is not in Sleep mode by pressing the power button on the computer or the sleep button on the wireless keyboard. If you press and hold the power button for more than four seconds, your computer will turn off automatically.

What should I do if the green power indicator light turns on but my screen remains blank?

- ❑ If the orange **DISPLAY OFF** indicator light is lit, press the **DISPLAY OFF** button.
- ❑ Make sure the computer input is selected as the audio/video input source. To change the display input, press the **INPUT/OK** button on the computer ([page 62](#)).
- ❑ Press the **Alt+F4** keys several times to close the application window. An application error may have occurred.
- ❑ Press the **Ctrl+Alt+Delete** keys and click the arrow  next to the **Shut down**  button and **Restart**.
- ❑ Press and hold the power button for more than four seconds to shut down your computer. Unplug the AC adapter and leave the computer for about five minutes. Then, plug the AC adapter and turn on the computer again.

!
Make sure that the battery of your wireless keyboard is properly installed and not running out of power.

Turning off your computer with the **Ctrl+Alt+Delete** keys or the power button may cause loss of unsaved data.

What should I do if my computer or software stops responding?

- ❑ If your computer stops responding while a software application is running, press the **Alt+F4** keys to close the application window.
- ❑ If the **Alt+F4** keys do not work, click **Start** and the **Shut down** button to turn off your computer.
- ❑ If your computer does not turn off, press the **Ctrl+Alt+Delete** keys and click the **Shut down** button. If the **Windows Security** window appears, click **Shut Down**.
- ❑ If this procedure does not work, press and hold the power button until the computer turns off.
!
Turning off your computer with the **Ctrl+Alt+Delete** keys or the power button may cause loss of unsaved data.
- ❑ Unplug the AC adapter. Wait three to five minutes. Plug the AC adapter again and press the power button to turn on your computer.
- ❑ Try reinstalling the software.
- ❑ Contact the software publisher or designated provider for technical support.

Why doesn't my computer enter Sleep mode?

Your computer may become unstable if the operating mode is changed before the computer completely enters Sleep mode.

To restore your computer to normal mode

- 1 Close all open programs.
- 2 Click **Start**, the arrow next to the **Shut down** button, and **Restart**.
- 3 If your computer does not restart, press the **Ctrl+Alt+Delete** keys and click the arrow next to the **Shut down** button and **Restart**.
- 4 If this procedure does not work, press and hold the power button until the computer turns off.

! Turning off your computer with the **Ctrl+Alt+Delete** keys or the power button may cause loss of unsaved data.

What should I do if my computer does not accept my password and returns a message, Enter Onetime Password?

If you enter a wrong power-on password three times consecutively, the **Enter Onetime Password** message appears and Windows will not start. Press and hold the power button for more than four seconds to check that the power indicator light turns off. Wait for 10 to 15 seconds, then restart your computer and enter the correct password. The password is case sensitive, so be sure to check letters for the current case before you enter the password.

What should I do if my game software does not work or it keeps crashing?

- Check the web site of the game if there are any patches or updates to download.
- Make sure you have installed the latest video driver software.
- On some VAIO models, the graphics memory is shared with the system. The optimal graphic performance in such a case is not guaranteed.

Why doesn't my screen turn off after the automatic turn-off time has passed?

Some software applications or screen savers are designed to temporarily disable the feature of your operating system that turns off the computer screen or places the computer into Sleep mode after a certain period of inactivity. To solve this problem, exit the running software application(s) or change the current screen saver.

How can I change the boot device order?

You can use one of the BIOS functions to change the boot device order. Follow these steps:

- 1 Turn on the computer and press the **F2** key repeatedly until the VAIO logo disappears.
The BIOS setup screen appears. If the screen does not appear, restart the computer and try again.
- 2 Press the **←** or **→** key to select **Boot**.
- 3 Press the **↑** or **↓** key to select your desired priority under **Boot Priority** and press the **Enter** key.
- 4 Press the **↑** or **↓** key to select the device to which you want to assign the priority and press the **Enter** key.
- 5 Press the **←** or **→** key to select **Exit**, select **Exit Setup**, and then press the **Enter** key.
At the confirmation prompt, press the **Enter** key.

What should I do if I cannot boot my computer from the USB floppy disk drive connected to the computer?

To boot your computer from the USB floppy disk drive, you need to change the boot device.

Turn on your computer and press the **F11** key repeatedly until the VAIO logo disappears.

System Update / Security

How can I find important updates for my computer?

You can find and install the latest updates on your computer with the software applications: the **Windows Update** and the **VAIO Update**. See **Updating Your Computer (page 24)** for more information.

How do I schedule the installation of Windows updates to my computer?

The Microsoft Windows operating system is preinstalled on your computer. The best way to protect your computer against security threats, such as viruses, is to download and install the latest Windows updates regularly.

You can get important Windows updates by doing the following:



Your computer must be connected to the Internet to download the updates.

- 1 Click **Start** and **Control Panel**.
- 2 Click **System and Security**.
- 3 Click **Action Center**.
- 4 Follow the on-screen instructions to set up automatic or scheduled updates.

Recovery / Recovery Media

How can I create Recovery Media?

You can create Recovery Media using the **VAIO Care** (page 26). The media are used to restore your computer system to its factory default settings.

! If your computer is not equipped with a built-in optical disc drive, you need to connect an external optical disc drive (not supplied).

See the **Recovery, Backup and Troubleshooting Guide** for more information.

How can I restore my computer system to its factory default settings?

There are two ways to recover your computer system: from Recovery Media and from the recovery area. See the **Recovery, Backup and Troubleshooting Guide** for more information.

How can I reinstall the original software and drivers?

You can restore the preinstalled software and drivers using the **VAIO Care** (page 26).

See the help file included with the **VAIO Care** for more information.

How do I check the volume of the recovery area?

Your built-in storage device contains the recovery area where the data for the system recovery is stored. To check the volume of the recovery area, follow these steps:

- 1 Click **Start**, right-click **Computer**, and select **Manage**.
- 2 Click **Disk Management** under **Storage** in the left pane.
The volume of the recovery area and the total volume of the C drive are displayed in the **Disk 0** row in the center pane.

Partition

How can I create a hard disk partition?

The Windows feature allows you to create a partition without recovering your computer system.

- 1 Click **Start**, **Control Panel**, **System and Security**, and **Create and format hard disk partitions** under **Administrative Tools**.
- 2 If the **User Account Control** window appears, click **Yes**.
If you are currently logged onto your computer as a standard user, you may be prompted to enter an administrator name and password.
- 3 Right-click the C drive and select **Shrink Volume**.
- 4 Enter the size of the partition to be created in **Enter the amount of space to shrink in MB** and click **Shrink**.
- 5 Right-click **Unallocated** and select **New Simple Volume**.
- 6 Follow the on-screen instructions.



If you use the **VAIO Care Rescue**, you can create a partition in the recovery process. See **Using the VAIO Care** ([page 26](#)) for more information.

Built-in Camera

Why does the viewfinder show no images or poor-quality images?

- ❑ The built-in camera cannot be shared by more than one software application. Exit the current application before launching another. On models with **Media Gallery**, you cannot use another camera application that uses the built-in camera while using the gesture function of **Media Gallery**.
- ❑ The viewfinder may show some noise, for example horizontal streaks, when you are viewing a rapid-moving object. This is normal and does not indicate a malfunction.
- ❑ If the problem persists, restart your computer.

Why is the video input from the built-in camera suspended for a few seconds?

The video input may be suspended for a few seconds if:

- ❑ a shortcut key with the **Fn** key is used.
- ❑ the CPU load increases.

This is normal and does not indicate a malfunction.

Why are captured images poor in quality?

- ❑ The images captured under the fluorescent light may show reflections of light.
- ❑ A dark portion in captured images may appear as a noise.
- ❑ The area on and around the built-in camera is dirty. Clean the area. See **Care and Maintenance Information (page 125)**.

What should I do if captured images contain dropped frames and audio interruptions?

- ❑ The effect settings on your software application may cause dropped frames. See the help file included with your software application for more information.
- ❑ There may be more software applications running than your computer can handle. Exit the applications that you are not currently using.
- ❑ This problem may occur while your computer is running on the power saving plan, which reduces the CPU performance. Check the current power plan.



What should I do if captured images flicker?

This problem occurs when you use the camera under fluorescent lights due to a mismatch between the lighting output frequency and the shutter speed.

To reduce flicker noise, change the direction of the camera or the brightness of camera images. In some software applications, you can set an appropriate value to one of the camera properties (e.g. light source, flicker, etc.) to eliminate flicker noise.

Networking (LAN/Wireless LAN)

What should I do if the VAIO Smart Network icon is not displayed on the taskbar?

- Click  on the taskbar and check if the **VAIO Smart Network** icon  is displayed.
- If the **VAIO Smart Network** icon  is not on the taskbar, click **Start**, **All Programs**, and **VAIO Smart Network**, and then change the setting to display the icon on the taskbar.

What should I do if my computer cannot connect to a wireless LAN access point?

- Connection capability is affected by distance and obstructions. You need to place your computer away from obstructions or move any access point you may be using closer to the computer.
- Make sure the **WIRELESS** indicator light is lit on your computer.
- Make sure power to the access point is on.
- Follow these steps to check the settings:
 - 1 Click **Start** and **Control Panel**.
 - 2 Click **View network status and tasks** under **Network and Internet**.
 - 3 Click **Connect to a network** to confirm that your access point is selected.
- Make sure the encryption key is correct.

- ❑ Make sure **Maximum Performance** is selected for **Wireless Adapter Settings** in the **Power Options** window. Selecting any other option may result in a communication failure. To change the settings, follow these steps:
 - 1 Click **Start** and **Control Panel**.
 - 2 Click **System and Security** and **Power Options**.
 - 3 Click **Change plan settings** for the current power plan.
 - 4 Click **Change advanced power settings**.
 - 5 Double-click **Wireless Adapter Settings** and **Power Saving Mode**.
 - 6 Select **Maximum Performance** from the drop-down list.

What should I do if I cannot access the Internet?

- ❑ Check the access point settings. See the manual that came with your access point for more information.
- ❑ Make sure your computer and the access point are connected to one another.
- ❑ Place your computer away from obstacles or move any access point you may be using closer to the computer.
- ❑ Make sure your computer is properly configured for Internet access.
- ❑ Make sure **Maximum Performance** is selected for **Wireless Adapter Settings** in the **Power Options** window. Selecting any other option may result in a communication failure. Follow the steps in **What should I do if my computer cannot connect to a wireless LAN access point? (page 146)** to change the settings.

Why is the data transfer speed slow?

- ❑ The wireless LAN data transfer speed is affected by distance and obstructions between devices and access points. Other factors include device configurations, radio conditions, and software compatibility. To maximize the data transfer speed, place your computer away from obstacles or move any access point you may be using closer to the computer.
- ❑ If you are using a wireless LAN access point, the device may be temporarily overloaded depending on how many other devices are communicating via the access point.
- ❑ If your access point interferes with other access points, change the access point channel. See the manual that came with your access point for more information.
- ❑ Make sure **Maximum Performance** is selected for **Wireless Adapter Settings** in the **Power Options** window. Selecting any other option may result in a communication failure. Follow the steps in **What should I do if my computer cannot connect to a wireless LAN access point? (page 146)** to change the settings.

How do I avoid data transfer interruptions?

- While your computer is connected to an access point, data transfer interruptions may occur if a large file is exchanged or the computer is placed in close proximity to microwaves and cordless telephones.
- Move your computer closer to the access point.
- Make sure the access point connection is intact.
- Change the access point channel. See the manual that came with your access point for more information.
- Make sure **Maximum Performance** is selected for **Wireless Adapter Settings** in the **Power Options** window. Selecting any other option may result in a communication failure. Follow the steps in **What should I do if my computer cannot connect to a wireless LAN access point? (page 146)** to change the settings.

What are channels?

- Wireless LAN communication uses divided frequency bands known as channels. Third-party wireless LAN access point channels may be preset to different channels from Sony devices.
- If you are using a wireless LAN access point, see connectivity information contained in the manual that came with your access point.

Why does the network connection stop when I change the encryption key?

Two computers with the wireless LAN function may lose a peer-to-peer network connection if the encryption key is changed. You can either change the encryption key back to the original profile or re-enter the key on both computers so the key matches.

BLUETOOTH Technology

What should I do if other BLUETOOTH devices cannot find my computer?

- ❑ Make sure both devices have the BLUETOOTH function enabled.
- ❑ Make sure the **WIRELESS** indicator light is lit on your computer.
- ❑ Your computer and the device may be too far apart. Wireless BLUETOOTH technology works best when the devices are within 10 meters of each other.

What should I do if I cannot find the BLUETOOTH device I want to communicate with?

- ❑ Check that the BLUETOOTH function of the device you want to communicate with is on. See the other device's manual for more information.
- ❑ If the device you want to communicate with is already communicating with another BLUETOOTH device, it may not be found or it may not be able to communicate with your computer.
- ❑ To allow other BLUETOOTH devices to communicate with your computer, follow these steps:
 - 1 Click **Start** and **Devices and Printers**.
 - 2 Right-click the BLUETOOTH device icon and click **Bluetooth settings**.
 - 3 Click the **Options** tab and select the **Allow Bluetooth devices to find this computer** check box.

What should I do if other BLUETOOTH devices cannot connect to my computer?

- ❑ Check the suggestions in **What should I do if I cannot find the BLUETOOTH device I want to communicate with?** (page 150).
- ❑ Make sure the other devices are authenticated.
- ❑ The data transfer distance can be shorter than 10 meters depending on existing obstacles between the two devices, on radio wave quality, and on the operating system or the software in use. Move your computer and BLUETOOTH devices closer to each other.

Why is my BLUETOOTH connection slow?

- ❑ The data transfer speed depends on the obstructions and/or the distance between the two devices, on the radio wave quality, and on the operating system or the software in use. Move BLUETOOTH devices closer to your computer.
- ❑ The 2.4 GHz band, with which BLUETOOTH devices or wireless LAN devices work, is used by various devices. Although BLUETOOTH devices use the technology to minimize radio interference from other devices that use the same band, such radio interference may cause slower communication speeds and shorter distances or communication failures.
- ❑ If a version of a BLUETOOTH standard employed on the BLUETOOTH device with which you want to communicate is not the same version as the one employed on your computer, the communication speed becomes slower.
- ❑ High-speed communications between your computer and BLUETOOTH devices are available when they are compliant with BLUETOOTH high speed technology. For the high-speed communications, enable both the wireless LAN and BLUETOOTH functions on the computer.

! Some BLUETOOTH profiles do not support high-speed communications.

Why can't I use the BLUETOOTH function when I log onto my computer as a user with a standard user account?

The BLUETOOTH function may not be available to a user with a standard user account on your computer. Log onto the computer as a user with administrative rights.

Why can't I use the BLUETOOTH devices when I switch users?

If you switch users without logging off your system, the BLUETOOTH devices will not work. Be sure to log off before switching users. To log off your system, click **Start**, the arrow next to the **Shut down** button, and **Log off**.

Why can't I exchange business card data with a mobile phone?

The business card exchange function is not supported.

What should I do if the BLUETOOTH icon is not displayed on the taskbar?

- ❑ Make sure that the switch next to **BLUETOOTH** is set to **On** in the **VAIO Smart Network** window.
- ❑ To display the BLUETOOTH icon on the taskbar, follow these steps:
 - 1 Click **Start** and **Devices and Printers**.
 - 2 Right-click the BLUETOOTH device icon and click **Bluetooth settings**.
 - 3 Click the **Options** tab and select the **Show the Bluetooth icon in the notification area** check box.

Optical Discs

Why does my computer freeze when I try to read a disc?

The disc that your computer is trying to read may be dirty or damaged. Follow these steps:

- 1 Press the **Ctrl+Alt+Delete** keys and click the arrow next to the **Shut down** button and **Restart** to restart the computer.



Turning off your computer with the **Ctrl+Alt+Delete** keys may cause loss of unsaved data.

- 2 Remove the disc from the optical disc drive.
- 3 Check the disc for dirt or damage. If you need to clean the disc, see **Discs (page 125)** for instructions.

What should I do if the drive tray does not open?

- Make sure your computer is in Normal mode.
- Press the drive eject button or the **Fn+E** keys.
- If this does not work, click **Start** and **Computer**, right-click the optical disc drive icon, and select **Eject**.
- If none of the above options work, insert a thin, straight object (such as a paper clip) into the manual eject hole on the optical disc drive.
- Try restarting your computer.

What should I do if I cannot play a disc properly on my computer?

- Make sure the disc is inserted into the optical disc drive with the label side facing toward you.
- Make sure the necessary program(s) is installed according to the manufacturer's instructions.
- If a disc is dirty or damaged, your computer will stop responding. Follow these steps:
 - 1** Press the **Ctrl+Alt+Delete** keys and click the arrow next to the **Shut down** button and **Restart** to restart the computer.
!
Turning off your computer with the **Ctrl+Alt+Delete** keys may cause loss of unsaved data.
 - 2** Remove the disc from the optical disc drive.
 - 3** Check the disc for dirt or damage. If you need to clean the disc, see **Discs (page 125)** for instructions.
- If you are playing a disc and cannot hear sound, do any of the following:
 - The volume may have been turned off by the muting button on the wireless keyboard. Press the button once again.
 - The volume may have been minimized by the **VOL (-)** button on the right of the computer or the volume down button on the wireless keyboard. Press the volume up button to turn up the volume loud enough to hear sound.
 - Right-click the volume icon on the taskbar and click **Open Volume Mixer** to check the settings.
 - Check the volume setting in the audio mixer.
 - If you are using external speakers, check the volume settings on the speakers and the connections between the speakers and your computer.

- ❑ Make sure the correct driver software is installed. Follow these steps:
 - 1 Click **Start** and **Control Panel**.
 - 2 Click **System and Security**.
 - 3 Click **System**.
 - 4 Click **Device Manager** in the left pane.

The **Device Manager** window appears with a listing of your computer's hardware devices.
If an "X" or an exclamation point appears on the listed device, you may need to enable the device or reinstall the driver software.
 - 5 Double-click the optical disc drive device to open a list of the optical disc drives of your computer.
 - 6 Double-click your desired drive.

You can confirm the driver software by selecting the **Driver** tab, and clicking **Driver Details**.
 - 7 Click **OK** to close the window.
- ❑ Make sure an adhesive label is not affixed to a disc. Adhesive labels can come off while the disc is in the optical disc drive and damage the drive or cause it to malfunction.
- ❑ If a region code warning appears, the disc may be incompatible with the optical disc drive. Check the package to make sure the region code is compatible with the optical disc drive.
- ❑ If you notice condensation on your computer, do not use the computer for at least one hour. Condensation can cause the computer to malfunction.

What should I do if I cannot play Blu-ray Disc media or my computer becomes unstable during Blu-ray Disc playback?

- ❑ Check if your optical disc drive supports the Blu-ray Disc media.
- ❑ To play copyright protected Blu-ray Disc media continually, you need to update the AACS key. If a message prompts you to update the AACS key, follow the message.



Your computer must be connected to the Internet to update the AACS key.

- ❑ You may not be able to play some Blu-ray Disc content on your computer, or the computer may become unstable during Blu-ray Disc playback. To play content normally, download and install the latest updates for Blu-ray Disc playback software using the **VAIO Update**.

For information on how to use the **VAIO Update**, see **Updating Your Computer (page 24)**.

What should I do if I cannot write data to CD media?

- ❑ Make sure you neither launch any software application nor allow any to launch automatically, not even a screen saver.
- ❑ If you are using a CD-R/RW disc with an adhesive label affixed, replace it with one with no affixed adhesive label. Using a disc with an affixed adhesive label could cause a write error or other damage.

What should I do if I cannot write data to DVD media?

- ❑ Make sure you are using the correct DVD recordable media.
- ❑ Check which DVD recordable format is compatible with your optical disc drive. Some brands of DVD recordable media do not work.

Why can't I write data to Blu-ray Disc media?

- Check if your optical disc drive supports the Blu-ray Disc writing function.
- BD-R Disc media are not rewritable. You cannot add or erase data to or from the BD-R Disc media.

What should I do if my external optical disc drive does not work properly?

Make sure that your external optical disc drive is connected to an AC power source and the USB port on your computer. If it is not connected, the external optical disc drive may not work properly.

Display

Why did my screen go blank?

- ❑ Your computer screen may go blank if the computer enters Sleep mode. If the computer is in Sleep mode, press any key to bring the computer back into Normal mode. See **Using the Power Saving Mode (page 21)** for more information.
- ❑ Make sure the computer input is selected as the audio/video input source. To change the input source, press the **INPUT/OK** button on the computer (page 62).
- ❑ Make sure your computer is securely plugged into a power source and turned on and the power indicator light is lit.
- ❑ The LCD backlight of your computer may have been turned off. Press the **DISPLAY OFF** button.

What should I do if I do not see proper images or videos?

- ❑ Be sure to select **True Color (32 bit)** for the display colors before using video/image software or starting DVD playback. Selecting any other option may prevent such software from displaying images successfully. To change the display colors, follow these steps:
 - 1 Right-click on the desktop and select **Screen resolution**.
 - 2 Click **Advanced settings**.
 - 3 Click the **Monitor** tab.
 - 4 Select **True Color (32 bit)** under **Colors**.
- ❑ Do not change the display resolution or colors while using video/image software or playing DVDs, as it may cause unsuccessful playback/display or unstable system operations. Additionally, it is recommended you disable your screen saver before starting DVD playback. If the screen saver is enabled, it may be activated during DVD playback and prevent the playback from running successfully. Some screen savers have been found to even change the display resolution and colors.

What should I do if some items do not fit on the computer screen?

Check that the text size is set to 100%. If not, some items, for example a software menu, may not be displayed correctly, depending on the software you are using. See **Windows Help and Support** for more information on how to change the text size.

What should I do if no image is displayed on my TV screen or external display connected to the HDMI output port?

Make sure you are using an HDCP-compliant display. The copyright protected content is not displayed on a non-HDCP compliant display. See **Connecting a TV with an HDMI Input Port (page 92)** or **Connecting a Computer Display (page 91)** for more information.

What should I do if 3D images are not displayed or the 3D effect is less pronounced on the computer screen?

If your computer is equipped with a 3D-capable LCD screen, refer to the **Enjoying 3D: Information Guide** for detailed information on 3D playback.

What should I do if 3D images are not displayed on my 3D TV connected to the HDMI output port?

- ❑ Change the 3D playback settings. To change the settings, click **Tools** in the upper right corner of the **WinDVD BD** window and select . See the help file included with the **WinDVD BD** for more information.
- ❑ If the computer is connected to your 3D TV through an AV amplifier, make sure the AV amplifier supports 3D playback.
- ❑ Check the HDMI output resolution settings on the computer. If the resolution is not set to 1920 x 1080 or 1280 x 720, images are not displayed in 3D. See **To play Blu-ray 3D Disc media (page 95)** for details on how to set up the resolution.
- ❑ You should also see the manual that came with your 3D TV for more information on 3D playback.

Why doesn't my screen display a video?

- ❑ If the display output is directed to the external display and the external display is disconnected, you cannot display a video on your computer screen. Stop video playback, change the display output to the computer screen, and then restart video playback. See **Selecting Display Modes (page 97)** for changing the display output.
- ❑ The video memory of your computer may be insufficient for displaying high resolution videos. In such a case, lower the resolution of the LCD screen.

To change the screen resolution, follow these steps:

- 1 Right-click on the desktop and select **Screen resolution**.
- 2 Click the drop-down list next to **Resolution**.
- 3 Move the slider up to increase or down to decrease the screen resolution.



You can check the total amount of the graphics and video memory available. Right-click on the desktop, select **Screen resolution**, and click **Advanced Settings** and the **Adapter** tab. The displayed value may be different from the actual amount of memory on your computer.

What should I do if my screen is dark?

Make sure the computer input is selected as the audio/video input source and press the **Fn+F6** keys on the wireless keyboard to brighten your computer screen. To change the input source, press the **INPUT/OK** button on the computer ([page 62](#)).

What should I do if the external display remains blank?

Change the display output to your computer screen. See **Selecting Display Modes** ([page 97](#)) for more information.

How do I run Windows Aero?

To run Windows Aero, follow these steps:

- 1 Right-click on the desktop and select **Personalize**.
- 2 Select your desired theme from **Aero Themes**.

For information about the Windows Aero features, such as Windows Flip 3D, see **Windows Help and Support**.

Printing

What should I do if I cannot print a document?

- ❑ Make sure your printer is on, and the printer cable is securely connected to the ports on the printer and your computer.
- ❑ Make sure your printer is compatible with the Windows operating system installed on your computer.
- ❑ You may need to install the printer driver software before you use your printer. See the manual that came with your printer for more information.
- ❑ If your printer is not functioning after your computer resumes from Sleep mode, then restart the computer.
- ❑ If the bidirectional communication functions are provided with your printer, disabling the functions on your computer may enable printing. Follow these steps:
 - 1 Click **Start** and **Devices and Printers**.
 - 2 Right-click the printer icon and select **Properties**.
 - 3 Click the **Ports** tab.
 - 4 Click to cancel the **Enable bidirectional support** check box.
 - 5 Click **OK**.

This disables the bidirectional communication functions of the printer, such as data transfer, status monitoring, and remote panel.

Microphone

What should I do if my microphone does not work?

- ❑ If you are using an external microphone, make sure the microphone is turned on and is properly plugged into the microphone jack on your computer.
- ❑ Your sound input device may have been incorrectly configured. To configure the sound input device, follow these steps:
 - 1 Close all open programs.
 - 2 Click **Start** and **Control Panel**.
 - 3 Click **Hardware and Sound**.
 - 4 Click **Manage audio devices** under **Sound**.
 - 5 On the **Recording** tab, select your desired device for sound input and click **Set Default**.

How can I prevent microphone feedback?

Microphone feedback occurs when the microphone receives the sound from a sound output device, such as a speaker.

To prevent this problem:

- ❑ Keep the microphone away from a sound output device.
- ❑ Turn down the volume of the speakers and the microphone.

Mouse

What should I do if my computer does not recognize my mouse?

- Make sure the power switch on the bottom of the wireless mouse is in the **ON** position.
- Make sure another mouse is not connected.
- Make sure the supplied AA battery is properly installed.
- The supplied AA battery may have run out of power. Replace the battery.
- Your wireless mouse may have been disconnected from the computer. See **To connect the wireless mouse (page 38)** to reconnect the mouse.

What should I do if the pointer does not move when I use my mouse?

- ❑ Make sure another mouse is not connected.
- ❑ If the pointer does not move while a software application is running, press the **Alt+F4** keys to close the application window.
- ❑ If the **Alt+F4** keys do not work, press the Windows key once and then the **→** key several times, select **Restart** with the **↑** or **↓** key, and press the **Enter** key to restart your computer.
- ❑ If your computer does not restart, press the **Ctrl+Alt+Delete** keys, select the arrow next to the **Shut down** button with the **↓** and **→** keys and then **Restart** with the **↑** or **↓** key, and press the **Enter** key to restart your computer.
- ❑ If this procedure does not work, press and hold the power button until the computer turns off.



Turning off your computer with the power button may cause loss of unsaved data.

- ❑ Avoid using any wireless devices that exchange radio signals on the 2.4 GHz band near your wireless mouse. These devices may create radio interference, causing the mouse to stop working properly.
- ❑ Do not place metal furniture or objects near your computer or wireless mouse, as this may create radio interference, causing the mouse to stop working properly.

Speakers

What should I do if I do not hear sound from the built-in speakers?

- ❑ If you are using a program that has its own volume control, make sure the volume control is properly set. See the program's help file for more information.
- ❑ The volume may have been turned off by the muting button on the wireless keyboard. Press the button once again.
- ❑ The volume may have been minimized by the **VOL (-)** button on the right of the computer or the volume down button on the wireless keyboard. Press the volume up button to turn up the volume loud enough to hear sound.
- ❑ Check the Windows volume controls by clicking the volume icon on the taskbar.
- ❑ Your sound output device may have been incorrectly configured. To change the sound output device, see **How do I change the sound output device? (page 171)**.

What should I do if my external speakers do not work?

- ❑ Check the suggestions in **What should I do if I do not hear sound from the built-in speakers? (page 166)**.
- ❑ If you are using a program that has its own volume control, make sure the volume control is properly set. See the program's help file for more information.
- ❑ Make sure your speakers are properly connected and the volume is turned up loud enough to hear sound.
- ❑ Make sure your speakers are designed for computer use.
- ❑ If your speakers have a muting button, set the button to off.
- ❑ If your speakers require external power, make sure the speakers are connected to a power source. See the manual that came with your speakers for more information.
- ❑ Check the Windows volume controls by clicking the volume icon on the taskbar.
- ❑ Your sound output device may have been incorrectly configured. To change the sound output device, see **How do I change the sound output device? (page 171)**.

Touch Screen

What should I do if the touch screen does not work?

- ❑ The HDMI input or the video input may be selected as the audio/video input source. Press the **INPUT/OK** button on the computer ([page 62](#)).
- ❑ You may have disabled the touch screen. Use the wireless mouse to click **Start, Control Panel, Hardware and Sound,** and **Pen and Touch**, and then click to select the **Use your finger as an input device** check box on the **Touch** tab.

What should I do if I cannot tap on the exact spot that I intend on the touch screen?

Changing the aspect ratio along with the screen resolution may cause loss of correct coordinates on the touch screen. In such a case, follow these steps to calibrate the touch screen with the **Control Panel**.

- 1 Click **Start, Control Panel,** and **Tablet PC Settings** with the wireless mouse.
- 2 Click **Calibrate** on the **Display** tab.
- 3 Follow the on-screen instructions.

Keyboard

What should I do if the keyboard configuration is wrong?

The language layout of your wireless keyboard is labeled on the packaging box. If you choose a different regional keyboard when you complete the Windows setup, the key configuration will be mismatched.

To change the keyboard configuration, follow these steps:

- 1 Click **Start** and **Control Panel**.
- 2 Click **Clock, Language, and Region**, and then **Change keyboards or other input methods** under **Region and Language**.
- 3 Click **Change keyboards** on the **Keyboards and Languages** tab.
- 4 Change the settings as desired.

What should I do if I cannot use the numeric keypad to enter numbers?

If you cannot use the numeric keypad, Num Lk mode may not be activated. Check if the green Num lock icon is on the taskbar. If the Num lock icon is not on the taskbar or is white, press the **Num Lk** key to activate the mode before entering numerals.

What should I do if my computer does not recognize my keyboard?

- Make sure the power switch on the wireless keyboard is in the **ON** position.
- Make sure the supplied AA battery is properly installed.
- The supplied AA battery may have run out of power. Replace the battery.
- Your wireless keyboard may have been disconnected from the computer. See **To connect the wireless keyboard (page 33)** to reconnect the keyboard.

Floppy Disks

Why doesn't the Safely Remove Hardware and Eject Media icon appear on the taskbar when the drive is connected?

Your computer does not recognize the floppy disk drive. First, make sure the USB cable is properly connected to the USB port. If you need to secure the connection, wait a few moments for the computer to recognize the drive. If the icon still does not appear, follow these steps:

- 1 Close all programs that are accessing the floppy disk drive.
- 2 Wait until the indicator light on the floppy disk drive turns off.
- 3 Push the eject button to remove the disk, and unplug the USB floppy disk drive from your computer.
- 4 Reconnect the floppy disk drive by plugging the USB cable into the USB port.
- 5 Restart the computer by clicking **Start**, the arrow next to the **Shut down** button, and **Restart**.

What should I do if I cannot write data to a floppy disk?

- Make sure the floppy disk is properly inserted in the drive.
- If the disk is inserted properly and you are still unable to write data to it, the disk may be full or write-protected. You can either use a floppy disk that is not write-protected or disable the write-protect feature.

Audio/Video

What should I do if I cannot use my digital video camcorder?

If a message appears stating that the i.LINK device is disconnected or turned off, the i.LINK cable may not be securely plugged into the port on your computer or camcorder. Unplug the cable, and plug it in once again. See **Connecting an i.LINK Device** (page 103) for more information.

How do I turn off the Windows startup sound?

To turn off the Windows startup sound, follow these steps:

- 1 Click **Start** and **Control Panel**.
- 2 Click **Hardware and Sound**.
- 3 Click **Manage audio devices** under **Sound**.
- 4 On the **Sounds** tab, click to cancel the **Play Windows Startup sound** check box.
- 5 Click **OK**.

How do I change the sound output device?

If you do not hear sound from the device connected to a port, such as the USB port, HDMI output port, optical output port, or headphones jack, you need to change the device for sound output.

- 1 Close all open programs.
- 2 Click **Start** and **Control Panel**.
- 3 Click **Hardware and Sound**.
- 4 Click **Manage audio devices** under **Sound**.
- 5 On the **Playback** tab, select your desired device for sound output and click **Set Default**.

What should I do if I do not hear the sound from the sound output device connected to the HDMI output port, optical output port, or headphones jack?

- ❑ You need to change the sound output device if you want to hear sound from the device connected to a port, such as the HDMI output port, optical output port, or headphones jack. For the detailed procedure, see **How do I change the sound output device?** (page 171).
- ❑ If you still hear no sound from the sound output device, follow these steps:
 - 1 Follow steps 1 to 4 in **How do I change the sound output device?** (page 171).
 - 2 On the **Playback** tab, select the HDMI or S/PDIF icon and click **Properties**.
 - 3 Click the **Advanced** tab.
 - 4 Select the sample rate and bit depth (for example, 48000 Hz, 16 bit) which the device supports.
 - 5 Click **OK**.

Why do sound interruptions and/or dropped frames occur when I play high-definition videos, such as those recorded with the AVCHD digital video camcorder?

Playing high-definition videos requires substantial hardware resources, such as CPU, GPU, or system memory performance on your computer. During the video playback, some operations and/or functions may become unavailable, and sound interruptions, dropped frames, and playback failure may occur depending on the configuration of your computer.

How do I turn off sound along with the LCD backlight using the DISPLAY OFF button?

You can use one of the BIOS functions to change the **DISPLAY OFF** button settings. Follow these steps:

- 1 Turn on your computer and press the **F2** key repeatedly until the VAIO logo disappears.
The BIOS setup screen appears. If the screen does not appear, restart the computer and try again.
- 2 Press the **←** or **→** key to select **Advanced**.
- 3 Press the **↑** or **↓** key to select **Display off button** and press the **Enter** key.
- 4 Press the **↑** or **↓** key to select **Turn off Display and Sound** and press the **Enter** key.
- 5 Press the **←** or **→** key to select **Exit**, select **Exit Setup**, and then press the **Enter** key.
At the confirmation prompt, press the **Enter** key.

! The muting function of the **DISPLAY OFF** button overrides the Windows sound settings and disables all the built-in sound input and output devices of your computer, including the built-in speakers, the headphone jack, the microphone jack, and the built-in microphone. To put the Windows sound settings back in place, press the **DISPLAY OFF** button once again to restore sound on your computer.

HDMI/VIDEO Input Function

What should I do if I cannot change the volume or LCD brightness with the wireless keyboard?

You cannot change the volume or the brightness with the wireless keyboard while using the HDMI/VIDEO input function. Use the OSD menu for brightness control. To change the volume, use the **VOL** buttons on the right of your computer. See **Using the HDMI/VIDEO Input Control Buttons (page 62)** for more information on volume control.



While the HDMI input or the video input is selected as the audio/video input source, the corresponding indicator light illuminates in green (page 17).

How do I view the Windows desktop?

To display the Windows desktop, make sure your computer is turned on, and then press the **INPUT/OK** button on the computer (page 62) to switch the audio/video input source to the computer input. If your computer screen remains blank, see **What should I do if the green power indicator light turns on but my screen remains blank? (page 137)**.

How can I save audio/video signals receiving with the HDMI/VIDEO input function into a file?

You cannot capture audio/video signals coming from the device connected to the **HDMI INPUT** port or the **VIDEO INPUT** jacks and save them into a file on your computer. It is logically impossible because the audio/video input source must be either the HDMI input or the video input to receive such signals and, to access Windows for any file operations, you must change the input source to the computer input.

"Memory Stick"

What should I do if I cannot use "Memory Stick" that was formatted on a VAIO computer on other devices?

You may need to reformat your "Memory Stick".

Formatting "Memory Stick" erases all data, including music data previously saved on it. Before you reformat "Memory Stick", back up important data and confirm that "Memory Stick" does not contain files you want to keep.

- 1 Copy the data from "Memory Stick" onto your built-in storage device to save data or images.
- 2 Format "Memory Stick" by following the steps in **Formatting "Memory Stick" (page 69)**.

Can I copy images from a digital camera using "Memory Stick"?

Yes, and you can view video clips that you have recorded with digital cameras that are compatible with "Memory Stick".

Why can't I write data to "Memory Stick"?

Some versions of "Memory Stick" are equipped with an erasure prevention switch to protect data from unintentional erasure or overwriting. Make sure the erasure prevention switch is off.

Peripherals

What should I do if I cannot connect a USB device?

- ❑ If applicable, check the USB device is turned on and using its own power supply. For example, if you are using a digital camera, check if the battery is charged. If you are using a printer, check if the power cable is connected properly to an AC outlet.
- ❑ Try using another USB port on your computer. The driver software could be installed to the specific port you used the first time you connected the device.
- ❑ See the manual that came with your USB device for more information. You may need to install software before you connect the device.
- ❑ Try connecting a simple, low-powered device such as a mouse to test if the port is working at all.
- ❑ USB hubs may prevent a device from working because of a power distribution failure. We recommend you connect the device directly to your computer without a hub.

About the International ENERGY STAR(R) Program



The following information is applicable to ENERGY STAR qualified products only.

As an ENERGY STAR Partner, Sony confirmed that this product meets the ENERGY STAR standards for energy efficiency.

The International ENERGY STAR Office Equipment Program is an international program that promotes energy saving through the use of computers and office equipment. The program backs the development and dissemination of products with functions that effectively reduce energy consumption.

For detailed information on the ENERGY STAR Program, visit the following web sites:

- ❑ <http://www.energystar.gov> (USA)
- ❑ <http://www.eu-energystar.org> (Europe)

This computer is designed in compliance with the ENERGY STAR standards and delivered with the following power saving settings that apply to the computer running on AC power:

- ❑ The LCD backlight is turned off automatically after no more than 15 minutes of inactivity.
- ❑ The computer enters Sleep mode automatically after no more than 30 minutes of inactivity.

Press any key to bring the computer back into Normal mode.

Trademarks

SONY and the SONY logo are registered trademarks of Sony Corporation.

VAIO, the VAIO logo and other Sony product or service names are trademarks or registered trademarks of Sony Corporation or any of its affiliates.

i.LINK is a name to denote IEEE 1394.

Intel, Pentium, Intel SpeedStep, and Atom are trademarks or registered trademarks of Intel Corporation.

Microsoft, Windows, Windows Vista, BitLocker, Aero, and the Windows logo are either registered trademarks or trademarks of Microsoft Corporation in the United States and/or other countries.

Blu-ray Disc™, Blu-ray™, Blu-ray 3D™, the Blu-ray Disc logo, and the Blu-ray 3D logo are trademarks of the Blu-ray Disc Association.

The BLUETOOTH word mark and logos are registered trademarks owned by Bluetooth SIG, Inc. and any use of such marks by Sony Corporation is under license. Other trademarks and trade names are those of their respective owners.

Roxio Easy Media Creator is a trademark of Sonic Solutions.

WinDVD is trademark of Corel Inc.

PowerDVD is trademark of CyberLink.Inc.

NVIDIA and 3D Vision are registered trademarks and/or trademarks of NVIDIA Corporation in the United States and other countries.

ArcSoft and the ArcSoft logo are registered trademarks of ArcSoft, Inc. ArcSoft WebCam Companion is a trademark of ArcSoft, Inc.

AMD, the AMD Arrow logo, ATI, and combinations thereof, Radeon, AMD Phenom, AMD Turion, AMD Athlon, AMD Virtualization, AMD-V are trademarks of Advanced Micro Devices, Inc.

SD Logo is a trademark. 

SDHC Logo is a trademark. 

SDXC Logo is a trademark. 

The ExpressCard word mark and logos are owned by the PCMCIA and any use of such marks by Sony Corporation is under license. Other trademarks and trade names are those of their respective owners.

HDMI, the HDMI logo, and High-Definition Multimedia Interface are trademarks or registered trademarks of HDMI Licensing LLC.

CompactFlash® is a trademark of SanDisk Corporation.

"PlaceEngine" is a registered trademark of Koozyt, Inc.

"PlaceEngine" was developed by Sony Computer Science Laboratories, Inc. and is licensed by Koozyt, Inc.

"AVCHD" is a trademark of Panasonic Corporation and Sony Corporation.

ENERGY STAR and the ENERGY STAR mark are registered U.S. marks.

All other names of systems, products, and services are trademarks of their respective owners. In the manual, the ™ or ® marks are not specified.

Features and specifications are subject to change without notice.

All other trademarks are trademarks of their respective owners.

Not all the software listed above may be delivered with your model.

Notice

© 2011 Sony Corporation. All rights reserved.

This manual and the software described herein, in whole or in part, may not be reproduced, translated, or reduced to any machine-readable form without prior written approval.

Sony Corporation provides no warranty with regard to this manual, the software, or other information contained herein and hereby expressly disclaims any implied warranties or merchantability or fitness for any particular purpose with regard to this manual, the software, or such other information. In no event shall Sony Corporation be liable for any incidental, consequential, or special damages, whether based on tort, contract, or otherwise, arising out of or in connection with this manual, the software, or other information contained herein or the use thereof.

In the manual, the ™ or ® marks are not specified.

Sony Corporation reserves the right to make any modification to this manual or the information contained herein at any time without notice. The software described herein is governed by the terms of a separate user license agreement.

Sony Corporation is not liable and will not compensate for any lost recordings made to your computer, external recording media, or recording devices or any relevant losses, including when recordings are not made due to reasons including your computer failure, or when the contents of a recording are lost or damaged as a result of your computer failure or repair undertaken to your computer. Sony Corporation will not restore, recover, or replicate the recorded contents made to your computer, external recording media, or recording devices under any circumstances.

