

Hardware Guide

PCG-TR series

PCG-Z1 series

PCG-V505 series



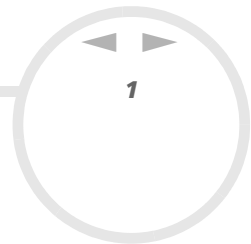

Read this first

Notice

© 2003 Sony Corporation. All rights reserved.

This manual and the software described herein, in whole or in part, may not be reproduced, translated, or reduced to any machine-readable form without prior written approval.

Sony Corporation provides no warranty with regard to this manual, the software, or other information contained herein and hereby expressly disclaims any implied warranties or merchantability or fitness for any particular purpose with regard to this manual, the software or such other information. In no event shall Sony Corporation be liable for any incidental, consequential, or special damages, whether based on tort, contract, or otherwise, arising out of or in connection with this manual, the software, or other information contained herein or the use thereof.

Macrovision: This product incorporates copyright protection technology that is protected by U.S. patents and other intellectual property rights. Use of this copyright protection technology must be authorized by Macrovision, and is intended for home and other limited viewing uses only unless otherwise authorized by Macrovision. Reverse engineering or disassembly is prohibited.

In the manual, the ™ or ® marks are not specified.

Sony Corporation reserves the right to make any modification to this manual or the information contained herein at any time without notice. The software described herein is governed by the terms of a separate user licence agreement.

Please note that the illustrations in this manual may not necessarily apply to your model. Please see the Specifications sheet for the specific configuration of your VAIO.

ENERGY STAR

As an ENERGY STAR Partner, Sony has determined that this product meets the ENERGY STAR guidelines for energy efficiency. The International ENERGY STAR Office Equipment Program is an international program that promotes energy saving through the use of computers and their office equipment. The program backs the development and dissemination of products with functions that effectively reduce energy consumption. It is an open system in which business proprietors can participate voluntarily. The targeted products are office equipment such as computers, displays, printers, facsimiles and copiers. Their standards and logos are uniform among participating nations.

ENERGY STAR is a U.S. registered mark.



Owner's record

The serial number and model number are located on the bottom of your Sony computer. Record the numbers and refer to them if you call VAIO-Link. See also the printed **Specifications** document.

Safety Information

General

- ❑ Opening the unit, for whatever reason, could lead to damages that are not covered by the guarantee.
- ❑ To avoid electrical shock, do not open the cabinet. Refer servicing to qualified personnel only.
- ❑ To prevent fire or shock hazard, do not expose your VAIO computer to rain or moisture.
- ❑ If reporting a gas leak, do not use the modem or a telephone in the vicinity of the leak.
- ❑ Avoid using the modem during a severe electrical storm.
- ❑ To change the backup battery, please contact your nearest Sony Service Centre.
- ❑ Before you connect peripherals, turn off the computer and all peripherals.
- ❑ Connect the power cord only after connecting all cables.
- ❑ Turn on the computer only after turning off all peripherals.
- ❑ Do not move your computer while the system is in **Standby** mode.
- ❑ The magnetic properties of some objects can have serious consequences for your hard disk drive. They can erase the data on the hard disk drive and cause the computer to malfunction. Do not place your computer near or on any objects which emit magnetic fields, mainly:
 - ❑ TV sets
 - ❑ Speakers
 - ❑ Magnets and magnetic bracelets.

Audio/video

- ❑ Audio and picture distortion may occur if this equipment is positioned in close proximity to any equipment emitting electromagnetic radiation.



Connectivity

- ❑ Never install modem or telephone wiring during a severe lightning storm.
- ❑ Never install telephone jacks in wet locations unless the jack is specifically designed for wet locations.
- ❑ Take care when installing or modifying telephone lines.
- ❑ Use your computer only with the supplied AC adapter. To disconnect your computer completely from mains voltage, unplug the AC adapter.
- ❑ Make sure that the socket outlet is easily accessible.
- ❑ Never touch uninsulated telephone wire or terminals unless the telephone line has been disconnected at the network interface.

Regulatory information

Sony hereby declares that this product is in compliance with the essential requirements and other relevant provisions of European Directive 1999/5/EC (radio equipment and telecommunications terminal equipment Directive).



Declaration of Conformity

The European Union is targeting the free movement of goods for the internal market and to prevent technical barriers to trade. This effort has resulted in several EU Directives asking that manufacturers make their products comply with essential standards. Manufacturers are required to affix the "CE" mark on the products they sell and to draw up a "Declaration of Conformity" (DoC).

Primarily, the Declarations of Conformity are intended for the market surveillance authorities as proof that products satisfy the required standards. Additionally, Sony provides these EU DoC's on the website <http://www.compliance.sony.de> as a service to our customers.

You can search for all Declarations of Conformity available for a specific product by typing in the model name in the search box above. A list of matching documents will be displayed and can be downloaded. Please note that the availability of declarations depends on the scope of the EU Directives and the individual product specifications.

This product complies with EN 55022 Class B and EN 55024 for use in following areas: residential, commercial and light-industrial. This product has been tested and found compliant with the limits set out in the EMC Directive for using connection cables not longer than 3 metres (9.8 feet).

Before activating the built-in modem, please read the **Modem Regulations** leaflet.

The optical disc drive is classified as a CLASS 1 LASER PRODUCT and complies with the Laser Product Safety Standard EN 60825-1. Repair and maintenance only by authorised Sony technicians. Improper repairs and use can create safety hazards.

**CLASS 1
LASER PRODUCT
TO EN 60825-1**

Depending on the country, usage of the **built-in Bluetooth™** functionality may be restricted. For country-specific details, please refer to the **Bluetooth™ Safety Regulations** leaflet.

Depending on the country, usage of the **Wireless LAN** functionality may be restricted. For country-specific details, please refer to the **Wireless LAN Regulations** leaflet. The Wireless LAN PC functionality which is incorporated into this unit has passed Wi-Fi certification, and complies with the interoperability specifications established by WECA (Wireless Ethernet Compatibility Alliance).



Disposing of lithium ion batteries

- ❑ Do not handle damaged or leaking lithium ion batteries. Dispose of promptly and properly at end-of-life.
- ❑ Danger of explosion if the battery is incorrectly replaced. Replace only with the same or equivalent type recommended by the manufacturer. Discard used batteries according to the manufacturer's instructions.
- ❑ The battery pack used in this device may present a fire or chemical burn hazard if mistreated. Do not disassemble, heat above 60°C (140°F) or incinerate.
- ❑ Dispose of used batteries promptly and properly.
- ❑ Keep away from children.
- ❑ In some areas the disposal of lithium ion batteries in household or business waste may be prohibited.
- ❑ Use the public collection system.

Disposing of internal memory backup battery

- ❑ Your computer is equipped with an internal memory backup battery that should not have to be replaced during the lifetime of the product. For changing this battery, please contact VAIO-Link.
- ❑ Danger of explosion if the battery is incorrectly replaced.
- ❑ Dispose of properly at end-of-life.
- ❑ In some areas the disposal of lithium ion and other non-hazardous batteries in household or business waste may be prohibited.
- ❑ Please use the public collection system.

Welcome

Congratulations on purchasing a Sony VAIO computer. Sony has combined leading-edge technology in audio, video, computing and communications to provide you with state-of-the-art personal computing.

Here are the main features you can enjoy:

- ❑ **Exceptional performance.**
- ❑ **Portability** - The rechargeable battery pack provides hours of use without AC power.
- ❑ **Sony audio and video quality** - A high-resolution LCD screen enables you to take advantage of today's advanced multimedia applications, games, and entertainment software.
- ❑ **Multimedia features** – Enjoy audio and video CDs/DVDs.
- ❑ **Interconnectivity** – Your computer has Ethernet, USB 2.0 (High-speed/Full-speed/Low-speed) and i.LINK functionalities. i.LINK is a bidirectional digital interface for exchanging data. With the Memory Stick you can easily exchange and share digital data with compatible products.
- ❑ **Wireless technology** – Thanks to the Bluetooth™* and the Wireless LAN (IEEE 802.11b/g)* technology, you can communicate freely, without cables or wires.
- ❑ **Windows** - Your system includes Microsoft's Windows XP Professional or Home Edition* with Service Pack 1a operating system.
- ❑ **Photo, video, and webcam capabilities*** – Use the built-in **MOTION EYE** camera to capture pictures and videos.
- ❑ **Communications** - Access popular online services, send and receive e-mails, browse the Internet.
- ❑ **Excellent customer support** - If you are experiencing any problems with your computer, please check the VAIO-Link website for a possible solution: <http://www.vaio-link.com>
Before contacting VAIO-Link, please try to solve the problem by reading this guide, your printed **Guide to Troubleshooting and Using the VAIO Recovery and Documentation Disc** or the manuals and help files for the peripherals or software.

* Depending on your model. Read the printed **Specifications** document for more information.

Documentation pack

Your Documentation Pack contains printed information and user guides to read on your computer.

Online documentation

You can read the online Hardware and Software Guides on your computer by double-clicking the **My Documentation** icon on your desktop.

Printed documentation

- ❑ A **Getting Started** brochure, where you will find a brief description of the items in your box, and how to setup your computer;
- ❑ A **Specifications** sheet, containing a table of specifications , a list of bundled software and an overview of all connectors;
- ❑ A **Guide to Troubleshooting and Using the VAIO Recovery and Documentation Disc**, where you will find solutions to common problems, an explanation of the purpose and use of the **VAIO Recovery and Documentation Disc** delivered with your computer, and VAIO-Link information;
- ❑ Your **Sony Guarantee** conditions;
- ❑ A **Safety Regulations** leaflet;
- ❑ A **Modem Regulations** leaflet.
- ❑ A **Wireless LAN Regulations leaflet**;
- ❑ A **Bluetooth™ Regulations** leaflet applying to the Bluetooth function*.

* Depending on your model. Read the printed **Specifications** document for more information.

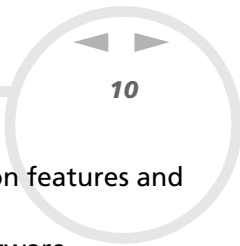

Further sources

- 1 Consult the **Online Help** files of the software you are using for detailed information on features and troubleshooting.
- 2 Go to <http://www.club-vaio.com> to find online tutorials about your favourite VAIO software.

Ergonomic considerations

You will be using your computer as a portable device in a variety of environments. Whenever possible, you should attempt to take account of the following ergonomic considerations to both stationary and portable environments:

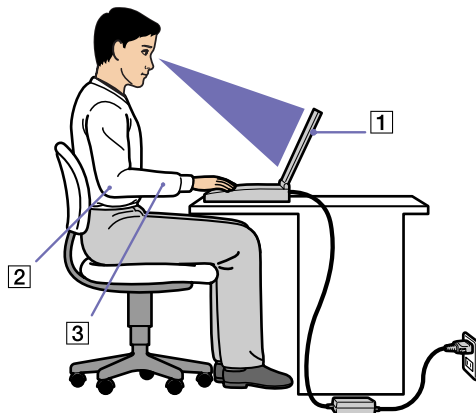

- ❑ **Position of your computer** – Place the computer directly in front of you (1). Keep your forearms horizontal (2), with your wrists in a neutral, comfortable position (3) while using the keyboard, touchpad, or external mouse. Let your upper arms hang naturally at your sides. Have breaks during sessions with your computer. Excessive use of the computer may strain muscles or tendons.
- ❑ **Furniture and posture** – Sit in a chair with good back support. Adjust the level of the chair so your feet are flat on the floor. A footrest may make you more comfortable. Sit in a relaxed, upright posture and avoid slouching forward or leaning far backwards.
- ❑ **Viewing angle of the computer's display** – Use the display's tilting feature to find the best position. You can reduce eye strain and muscle fatigue by adjusting the tilt of the display to the proper position. Adjust the brightness setting of the display as well.

- ❑ **Lighting** – Choose a location where windows and lights do not create glare and reflection on the display. Use indirect lighting to avoid bright spots on the display. You can also purchase accessories for your display that help reduce glare. Proper lighting adds to your comfort and work effectiveness.
- ❑ **Positioning an external display** – When using an external display, set the display at a comfortable viewing distance. Make sure the display screen is at eye level or slightly lower when you are sitting in front of the monitor.

Using your VAIO computer

Once you have read and followed the information in the printed **Getting Started** guide and **Specifications** sheet, you can start using your computer safely and confidently. Read on to get the most out of using your VAIO computer

- Connecting a power source ([page 14](#))
- Setting up your computer with Sony Notebook Setup ([page 20](#))
- Shutting down your computer safely ([page 22](#))
- Using the keyboard ([page 23](#))
- Using the touchpad ([page 27](#))
- Using the volume buttons and the Magnify button ([page 27](#))
- Using the disc drive ([page 29](#))
- Using PC Cards ([page 35](#))
- Using the Memory Stick ([page 38](#))
- Using the modem ([page 41](#))
- Using the Bluetooth functionality ([page 44](#))
- Using Wireless LAN (WLAN) ([page 50](#))
- Using the built-in MOTION EYE Camera* ([page 60](#))
- Using power saving modes ([page 63](#))
- Managing power with PowerPanel ([page 67](#))

Connecting a power source

You can use either an AC adapter or a rechargeable battery pack as a power source.

Using the AC adapter

To use the AC adapter, proceed as follows:

- 1 Plug the cable attached to the AC adapter (1) into the DC In connector (2) on the computer.
- 2 Plug one end of the power cord (3) into the AC adapter.
- 3 Plug the other end of the power cord into an AC outlet (4).
The LED at the end of the power cord turns green when the AC adapter is plugged in.

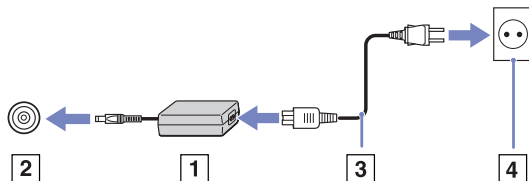

 Use your computer only with the supplied AC adapter.

To disconnect your computer completely from mains voltage, unplug the AC adapter.

Make sure that the socket outlet is easily accessible.

Using the battery pack

You can use a battery pack as a source of power. The battery pack supplied with your computer is not fully charged at the time of purchase.

Inserting the battery pack (PCG-Z1, PCG-V505 series)

To insert the battery pack, proceed as follows:

- 1 Move the lock lever (1) on the bottom of the computer to the **Unlock** position.

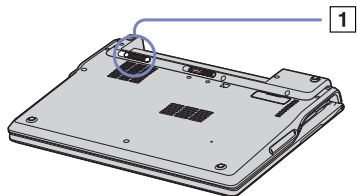

- 2 Align the grooves (2) and tabs on the battery (3) with the tabs and notches on the back of the computer, and then slide the battery towards the computer until it clicks into place.

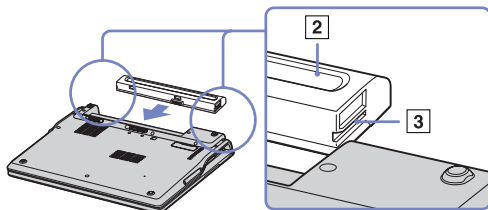

- 3 Slide the lock lever into the **Lock** position to secure the battery on the computer.

 When the computer is directly connected to AC power and has a battery pack inserted in the battery bay, it uses power from the AC outlet. Make sure the cover is closed before inserting the battery pack.

Inserting the battery pack (PCG-TR series)

To insert the battery, proceed as follows:

- 1 Insert the tabs (1) on the battery into the notches (2) and push the battery down into the compartment until it clicks into place.
- 2 Slide the lock lever into the **Lock** position to secure the battery on the computer.

 When the computer is directly connected to AC power and has a battery pack inserted in the battery bay, it uses power from the AC outlet.

Make sure the cover is closed before inserting the battery pack.

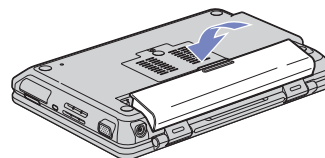
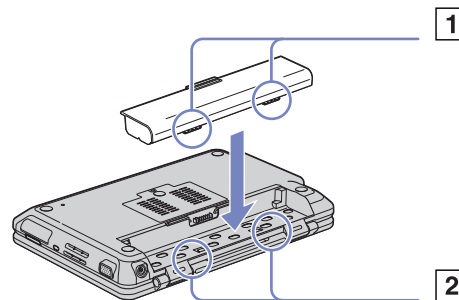

Charging the battery pack

To charge the battery pack, proceed as follows:

- 1 Connect the AC adapter to the computer.
- 2 Insert the battery pack. The computer automatically charges the battery (the battery indicator light flashes in a double blink pattern as the battery charges). Depending on your model, your computer has one or two battery indicator lights.

Battery indicator light status Meaning

On	The computer is using battery power.
Single blink	The battery is running out of power.
Double blink	The battery is charging.
Off	The computer is using AC power.



When the battery is running out of power, both the battery and power indicators blink.

Keep the battery pack in the computer while it is directly connected to AC power. The battery pack continues to charge while you are using the computer.

If the battery level falls below 10%, you should either attach the AC adapter to recharge the battery or shut down your computer and insert a fully charged battery.

You can extend battery life by changing the power management modes in the PowerPanel utility.

The battery pack supplied with your computer is a lithium ion battery and can be recharged any time. Charging a partially discharged battery does not affect battery life.

The battery indicator light is on while you use the battery pack as a power source. When the battery life is nearly depleted, both the battery and power indicators start flashing.

For some software applications and some peripheral devices, your computer may not enter **Hibernate** mode even when battery life is low. To avoid loss of data when using battery power, you should save your data frequently and manually activate a power management mode, such as **Standby** or **Hibernate**.

When the computer is directly connected to AC power and has a battery pack inserted in the battery bay, it uses power from the AC outlet.

Removing the battery pack

To remove the battery pack, proceed as follows:

- 1 Turn off the computer and close the cover.
- 2 Slide the lock lever (1) to the **Unlock** position.
- 3 Slide and hold the release lever (2) as indicated and slide the battery away from the computer.

PCG-Z1, PCG-V505 series:

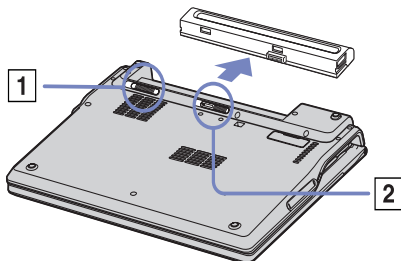

PCG-TR series:

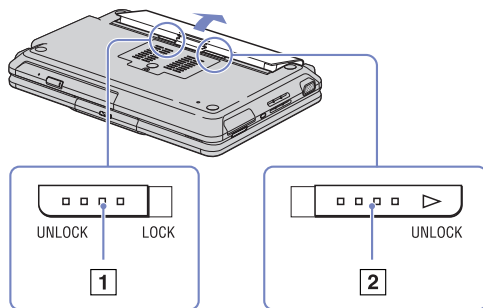



You can remove the battery pack without turning off the computer if it is connected to the mains voltage (AC adapter).

Close the cover before you remove the battery pack.

You may lose data if you remove the battery pack while the computer is on and not connected to the AC adapter or if you remove the battery while the computer is in **Standby** mode.

Setting up your computer with Sony Notebook Setup

The **Sony Notebook Setup** utility allows you to consult system information, specify preferences for system behaviour, and set up password protection for your VAIO computer.

To use Sony Notebook Setup, proceed as follows:

- 1 Click the **Start** button on the **Windows** taskbar.
- 2 In **All Programs**, select **Sony Notebook Setup** and then click **Sony Notebook Setup**. The **Sony Notebook Setup** window appears.

<i>Tab</i>	<i>Description</i>
About This Computer	Displays system information, including memory capacity, serial number, and BIOS version.
Initial Setting	Selects the drive and device order you wish to use for loading the operating system. You can specify the hard drive as well as other drives inserted into your computer. You can change the volume of the sounds played while the operating system is loading.
Power On Password	Sets the password to secure your computer. If you use this option, remember the password at all times. If you forget the password, you cannot change this setting anymore, and you will not be able to start your computer.
Device	Disables ports or devices to release resources to the system. To change the port settings, select a port and click Settings in the Device tab.
Bass boost	Turns the Bass Boost function on/off (only with headphones). You can also check the effect of the Bass Boost function by selecting a sound file sample and playing it.
P1 P2 buttons	Sets the functions from a drop-down list for the P1/P2 buttons located next to the keyboard. Select External Display and click Advanced to set up the display options*. * Depending on your model. Read the printed Specifications document for more information.

- 3 Select the tab for the item you want to change.

- 4 Once finished, click **OK**.
The item has been changed.



For more information about each option, click Help on the **Sony Notebook Setup** screen to display the help file.
If you open **Sony Notebook Setup** as a limited user, then only the **About This Computer** tab will be visible.

Shutting down your computer safely

It is important that you shut down your computer properly so you do not lose unsaved data.

To shut down your computer, proceed as follows:

- 1 Turn off any peripherals connected to your computer.
- 2 Click the **Start** button.
- 3 Click **Turn Off Computer**.
The **Turn off computer** window appears.
- 4 Click **Turn Off**.
- 5 Respond to any prompts warning you to save documents or to consider other users and wait for your computer to turn off automatically.
The power indicator turns off.













 See the printed **Troubleshooting guide** if you have problems shutting down your computer.

Using the keyboard

Your keyboard is very similar to a desktop computer's, but has additional keys that perform specific notebook-related tasks.

For more information on the standard keys, please go to the **Windows Help and Support Center**. The VAIO-Link website (www.vaio-link.com) also contains glossary information to help you use the keyboard.

Combinations and functions with the <Fn> key

Combinations/ Feature	Functions
<Fn> + <Esc> : Standby	Puts the system into Standby mode, a power management state. To return the system to the active state, press any key.
<Fn> +  (F3): speaker switch	Toggles the built-in speaker on and off.
<Fn> +  (F4): speaker volume	Adjusts the built-in speaker volume. To increase volume, press <Fn>+<F4> and then  or  . To decrease volume, press <Fn>+<F4> and then  or  . You can also adjust the volume by pressing the Volume up and Volume down keys below the touchpad of your computer.
<Fn> +  (F5): brightness control	Adjusts the brightness of the LCD. To increase lightness intensity, press <Fn>+<F5> and then  or  . To decrease light intensity, press <Fn>+<F5> and then  or  .
<Fn> +  (F7)*: switch to the external display	Toggles between the LCD, external device (monitor or TV depending on which device is connected) and both LCD and external device. This function can only be used by the first user to log in. It will not work under a second user account.



<i>Combinations/ Feature</i>	<i>Functions</i>
<Fn> +  (F12): Hibernate	Provides for the lowest level of power consumption. When you execute this command, the states of the system and of the peripheral devices are written to the hard disk and the system power is turned off. To return the system to its original state, use the power switch to turn on the power. For details on power management, see the section Using power saving modes (page 63) .
FN + B	Activates BassBoost . This means that the bass sound level is enhanced at all levels without distorting other frequencies (only with headphones).

! * This function can only be used by the first user to log on. It will not work if you have switched to another user account. If another user wants to display on an external monitor or TV, use the monitor properties to switch to an external monitor or TV.



 Some functions are not available until Windows is launched.

Troubleshooting sound

My speakers are not producing sound





- The built-in speakers may be turned off. Press **<Fn>+<F3>** to turn on the speakers.
- The speaker volume may be turned to the minimum. Press **<Fn>+<F4>** and then  or  to increase the volume. You can also use the **Volume up** and **Volume down** keys.
- If your computer is powered by battery, check that the battery is inserted properly.
- If you are using an application that has its own volume control, check that the volume is turned up.
- Check the volume controls in Windows.

Indicators

<i>Indicator</i>	<i>Functions</i>
Power 	Power on: lights green. Standby mode: flashes amber.
Battery 	Indicates the status of the battery.
Wireless LAN	Turns on when the Wireless LAN is activated. Turns off when the Wireless LAN is not activated.
MagicGate Memory Stick 	Turns on when the Memory Stick is in use. Turns off when the Memory Stick is no longer in use.
P1 P2 indicator*	Set up functions for each button. For more details see the Sony Notebook Setup chapter in the Software Guide.
Bluetooth indicator*	Turns blue when the Bluetooth functionality is available.
MOTION EYE camera indicator*	Turns green when the MOTION EYE Camera is working.

* Depending on your model. Read the printed **Specifications** document for more information.

*Light**On**Off*

Hard disk 	Data is read from or written to the hard drive.	The hard drive is not being accessed.
Num Lock 	Turns on when the number keys in the numeric keypad are active.	Turns off when the alphanumeric character keys in the keypad area are active.
Caps Lock 	Turns on when the letters appear in uppercase as you type. The <Shift> key lowers the case of typed characters when Caps Lock is on.	Turns off when the letters appear in lowercase as you type (unless you hold down the <Shift> key).
Scroll Lock 	Turns on when the screen scrolls differently (Not all applications support this function).	Turns off when the information moves across the display normally.

Using the touchpad

The keyboard contains a cursor-pointing device, your touchpad (1). You can point to, select, drag, and scroll objects on the screen using the built-in touchpad.

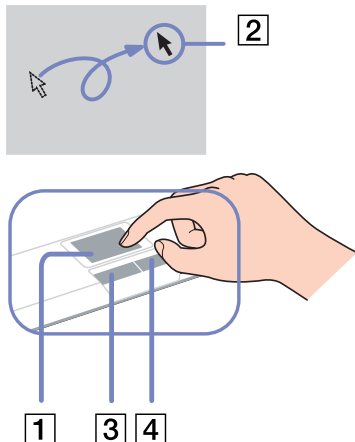

Action	Description
Point	Slide one finger on the touchpad to place the pointer (2) on an item or object.
Click	Press the left button (3) once.
Double-click	Press the left button twice.
Right-click	Press the right button (4) once. In many applications, this action displays a shortcut menu.
Drag	Slide one finger while pressing the left button.
Scroll	Move your finger along the right edge of the touchpad to scroll vertically. Move your finger along the bottom to scroll horizontally (the scroll function is available only with applications that support a touchpad scroll feature).

Using the volume buttons and the Magnify button

Your computer is provided with special buttons to help you using the computer*. They are located on the right side of the LCD screen.

- Volume buttons
 - You can increase and decrease the volume. It corresponds to the key combinations <Fn>+<F4>.
 - See Combinations and functions with the <Fn> key ([page 23](#)).

* Depending on your model. Read the printed **Specifications** document for more information.

□ Magnify button (Zoom)

You can change the image resolution in all applications, except in those that use the MOTION EYE Camera or the DVD player.



When an external display is connected to your computer, the Magnify button is disabled.

The default resolution of your computer's LCD is 1280 x 768 pixels ,Highest (32 bit), and the resolution of 1024 x 600 pixels is applied after magnification.

The magnified view is implemented by applying the resolution of 1024 x 600 pixels to the LCD with the resolution of 1280 x 768 pixels, thus not as clear as the original view.

Pressing the (Magnify) button changes the resolution, thus may cause a defect to any running software that does not support change in resolution. Make sure to quit such software before pressing the (Magnify) button.

The (Magnify) button may not work with graphic images as it magnifies the screen view by changing the resolution.

The location and size of software windows may change when the screen view is magnified or the original view is restored because pressing the (Magnify) button changes the resolution.

When the LCD screen view is magnified, switching the view to the external display disables the function and restores the original view.

Using the disc drive

Your computer is equipped with a disc drive. See the **Specifications** sheet for details on your model.

To insert a disc, proceed as follows:

- 1 Turn on the computer.
- 2 Press the eject button (1) to open the drive. The tray slides out.
- 3 Place a disc in the middle of the tray with the label side facing up until the disc clicks into place.
- 4 Close the tray by pushing it gently.

 See the **Troubleshooting Guide** if you have problems using discs.

1

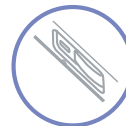

Reading and writing CDs and DVDs*

To achieve optimum performance when writing data on to disc (also called 'burning'), follow these recommendations :

- To make the data on a disc readable on an optical drive, you need to close the session when you eject it. To complete this process, follow the instructions included with your software.
- Only use circular discs. Do not use discs with any other shape (star, heart, card, etc.), as this may damage the disk drive.
- Do not strike or shake the computer while writing data to a disc.
- For optimal writing speed, deactivate the screensaver before writing data to a disc.
- Memory-resident disc utilities may cause unstable operation or data loss. Deactivate these utilities before writing data to a disc.
- When using your software application to burn discs, make sure you exit and close all other applications.

- ❑ Never touch the surface of the disc. Fingerprints and dust on the surface of a disc may cause writing errors.
- ❑ Do not put your VAIO computer into a power saving mode while using the pre-installed software and while using the CD burning software.
- ❑ Never put stickers on discs. This will affect the use of the disc irreparably.

* Depending on your model. Ultra Speed CD-RW is not supported.

Playing DVDs

To achieve optimum performance when playing DVDs, you should follow these recommendations.

- ❑ You can play DVDs using the optical drive and the **WinDVD for VAIO** software. See the help file on the **WinDVD for VAIO** software for details.
- ❑ Close all open applications before playing a DVD movie.
- ❑ Do not use resident disc utilities or resident utilities to speed up the access of discs, because they may cause the system to become unstable.
- ❑ Make sure that the screensaver is deactivated.
- ❑ Region codes indicators are labelled on the DVDs to indicate in which region and on what type of player you can play the disc. Unless a '2' (Europe belongs to region '2') or 'all' (this means that you can play this DVD everywhere in the world) is labelled on your DVD disc or on the packaging, you cannot play the disc on this player.
- ❑ Do not try to change the region code settings of the DVD drive. Any difficulties caused by changing the region code settings of the DVD drive are out of warranty.

Troubleshooting optical disc drives

I cannot switch from LCD display to TV and vice versa

If a DVD disc is inserted in the optical drive, remove the disc.

My disc drive tray does not open

- Make sure the computer is turned on and press the eject button on the drive.
- Click **Start**, and select **My Computer**. Right-click the optical disc drive and select **Eject**.
- Make sure the computer is not in **Standby** or **Hibernate** mode.
- If this does not work, try the following:
When the computer is OFF, open the tray by inserting a sharp, pointed object (for example a paperclip) into the hole next to the eject button.

I cannot play a disc

- After inserting the disc, wait for a few seconds for the system to detect it before you try to access it.
- Make sure the label of the disc is facing up.
- If the disc requires software, make sure the software is installed according to the instructions of the program.
- Check the volume of your speakers.
- Clean the disc with an appropriate cleaner.
- Make sure your computer is running on AC power supply only and try the disc again.
- There may be condensation in the drive. Remove the disc and leave the drive open for approximately one hour. Remove the battery while you wait for the condensation to disappear.
- Make sure that the power profile you are using is not **Ultimate Battery Life**. Please use **AC Power** (when using AC power) or **Maximum Battery Life** (when running on batteries).

I cannot play a DVD

- ❑ If a region code warning appears when you are using the DVD player, it could be that the DVD you are trying to play is incompatible with the DVD drive on your computer. The region code is listed on the packaging of the disc.
 - ❑ Change the resolution under **Control Panel - Display** to a lower resolution.
 - ❑ If you see video but cannot hear sound, check all of the following:
 - ❑ Make sure the mute setting is off on your DVD player.
 - ❑ Check the **Master Volume** settings of the **Sounds and Audio Device Properties**.
 - ❑ If you have connected speakers externally, check the volume settings of your computer speakers and check the connections between your speakers and the computer.
 - ❑ In the **Device Manager**, check that the correct drivers are installed properly. To display the **Device Manager**, click **Start**, then **Control Panel**. Double-click the **System** icon. On the **Hardware** tab, click the **Device Manager** button.
 - ❑ A dirty or damaged disc may cause the computer to 'hang' while it tries to read the disc. If necessary, reboot the computer, remove the disc and then check that it is not dirty or damaged.
 - ❑ Check your PG settings (Parental Guidance) in the DVD software as they might be preventing you from playing certain DVDs when they are activated.
-  On your computer, the default DVD region code is 2. Do not change this setting using the **Region Code Change** function in Windows, or using any other software applications. System malfunctions originating from the user changing the DVD region code are beyond the scope of your warranty and will result in service charges for repair.

If you do not immediately see the **Display** icon after clicking **Control Panel**, click **Switch to Classic View** on the left.

I cannot play a DVD when using two screens

- ❑ When you use two screens at the same time (LCD and TV / LCD and CRT), the following errors will occur:
 - ❑ You will see a Hardware Overlay error message if you attempt to launch Click to DVD.
 - ❑ You cannot play a DVD with Windows Media Player version 9*.
 - ❑ You cannot play a DVD with Real One Player. This is because your computer uses the "video overlay" when two screens are in use. The software applications above do not support this feature, which is why the problems occur*.
- ❑ You will not have a problem in the following situations:
 - ❑ When you use a CRT or an LCD display on its own.
 - ❑ When you play MPEG files which are recorded on the hard drive with Windows Media Player 9 or RealOne Player*.

* Depending on your model. Read the Specifications document for more information.

The reading speed of CD/DVD-RWs is very slow

Generally, the reading speed of a CD/DVD-RW is slower than that of a -ROM or -R. The reading speed can also vary depending on the type of format.

The disc tray does not eject even when the eject button is pressed

- ❑ Check that the computer is turned on.
- ❑ The CD-writing application software may be stopping the disk from being ejected.
- ❑ Make sure the computer is not in **Standby** or **Hibernate** mode.
- ❑ Make sure that the power profile you are using is not **Ultimate Battery Life**. Please use **AC Power** (when using AC power) or **Maximum Battery Life** (when running on batteries).



The disc tray ejects even when it has been locked into place

- ❑ Ensure that the disc is placed with the label side facing up.
- ❑ Clean the disc and the disc drive lens with an appropriate cleaner.
- ❑ The disc may be scratched. Place another disc to see if that is the reason.
- ❑ There may be condensation in the drive. Remove the disc and leave the drive open for approximately one hour. Remove the battery while you wait for the condensation to disappear.

Using PC Cards

Your computer includes one or two PC Card slots (depending on your model). PC Cards allow you to connect portable external devices. Please see your printed **Specifications** sheet to see if your computer has one or two PC Card slots.

You do not need to shut down your computer when inserting a PC Card.

Inserting a PC Card

To insert a PC Card, proceed as follows:

- 1 Insert the PC Card into one of the PC Card slots with the front label facing upwards.

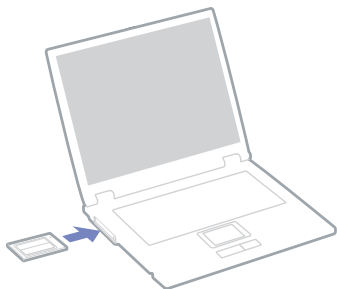

- 2 Gently push the PC Card slot into the connector.
The PC Card is automatically detected by your system.
The **Safely Remove Hardware** icon appears in the system tray.

 Some devices may not function properly if you repeat returning to **Normal** mode from **Standby** mode or **Hibernate** mode.
The computer will return to its original state if you restart it.

Some PC Cards may require you to disable idle devices when using the PC Card. You can use Sony computer Setup to disable devices.
Make sure you use the most recent software driver provided by the PC Card manufacturer.

If an "!" mark appears on the **Device Manager** tab in the **System Properties** dialog box, remove the software driver and then reinstall it.

You do not need to shut down the computer before inserting or removing a PC Card.

Do not force a PC Card into the slot. It may damage the connector pins. If you have difficulty inserting a PC Card, check that you are inserting the PC Card in the correct direction. See the manual supplied with your PC Card for more information on use.

For some PC Cards, if you alternate between **Normal** power operation and **Standby** or **Hibernate** power management modes while the card is inserted, you may find that a device connected to your system is not recognised. Restart your system to correct the problem.

Do not carry your computer while touching the head of a PC Card, as pressure or shock may damage the connector pins.

If your computer has two PC Card slots, it is recommended that you always use the same slot for a PC Card as switching slots can cause problems with some PC Cards.

If your computer has two PC Card slots, the PC Card slots can accommodate (at the same time) two Type I, two Type II or one Type III PC Card. These slots are compatible with Card Bus ports.

If your computer has two PC Card slots, use the lower slot for PC Type III cards.

Removing a PC Card

Follow the steps below to remove the PC Card while your computer is on. If it is not removed properly, your system may not work properly. If you want to remove a PC Card when your computer is off, skip steps 1 to 7.

To remove a PC Card, proceed as follows:

- 1 Double-click the **Safely Remove Hardware** icon in the system tray.
The **Safely Remove Hardware** dialog box appears.
- 2 Select the hardware you want to unplug.
- 3 Click **Stop**.
- 4 In the **Stop a Hardware Device** dialog box, confirm that the device can be safely removed from the system.
- 5 Click **OK**.
A dialog box appears, explaining that it is safe to remove the device.

- 6 Click **OK**.
- 7 Click **Close**.
- 8 Push the PC Card release button so that the release button pops out.
- 9 Push the PC Card release button a second time so that the PC Card pops out.
- 10 Gently take hold of the Card and pull it out of the slot.
- 11 If the PC Card release button is still out, push it back in to close the front panel cover.

 If you unplug the PC Card from the computer when it is still turned on, your system might crash and you might lose data that you did not save before. Before you remove the PC Card, click the PC Card icon in the taskbar and close the card. Close any applications that use the PC Card before removing the card. Otherwise, data may be lost.

While the card is inserted, your computer may not enter the **Hibernate** power management mode. It may enter **Standby** mode. It is recommended that you remove the card before your computer enters **Hibernate** mode by pressing the <Fn>+<F12> keys or by using the PowerPanel Utility, and when it is set to enter **Hibernate** automatically while using a battery as the source of power.

Some PC Cards or their functions may not be compatible with this computer.

Troubleshooting PC Cards

My PC Card is not working

- Make sure the PC Card is compatible with your version of Windows.
- Use the **Sony Notebook Setup** utility to disable devices you are not currently using.

Using the Memory Stick

Your VAIO computer is designed to support the Memory Stick. The Memory Stick is a compact, portable, and versatile device especially designed for exchanging and sharing digital data with compatible products, such as digital cameras, mobile phones and CLIE handheld devices. Because it is removable, it can be used for external data storage.

Use the flash memory technology to download anything that can be converted into digital data, such as pictures, music, words, sounds, movies and photographs. The Memory Stick family ranges in capacity and compatibility.

Please see your printed **Specifications** sheet to see which Memory Stick types are compatible with your VAIO and if there are any limitations.

- ❑ You can purchase Memory Sticks from the Sony Style website (www.sonystyle-europe.com), or from your local Sony dealer.
- ❑ Detailed information about which CLIE handhelds are compatible with which Memory Sticks can be found here: www.clie-link.com.
- ❑ Detailed information about which VAIO computers are compatible with which Memory Sticks can be found here: www.vaio-link.com.

Write-protecting a Memory Stick

Memory Sticks are designed with an erasure prevention switch to protect valuable data from accidental erasure or overwriting.

Move the tab to the right or left* to set or release write-protection. When the erasure prevention switch is off, data can be saved on the Memory Stick. When the erasure prevention switch is on, data can be read from but not saved on the Memory Stick.

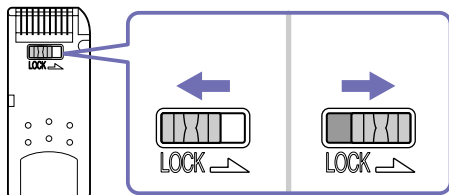

* The 128 MB Memory Stick has a vertical lock.

Inserting a Memory Stick

There are 2 ways you can insert a Memory Stick in your computer:

- Using the Memory Stick slot;
- Using a PC Card slot. To do this, you need an optional PC Card adapter.

You can only insert one Memory Stick at a time.

To insert a Memory Stick using the Memory Stick slot, proceed as follows:

- 1 Once you have stored your data from your digital device, insert the Memory Stick with the arrow facing up and toward the Memory Stick slot.

- 2 Carefully slide the Memory Stick into the slot until it clicks in place. The Memory Stick is automatically detected by your system and appears in your **My Computer** window as a local drive, under the appropriate letter (depending on the configuration of your computer).

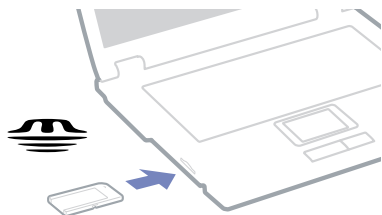

- ! Hold the Memory Stick with the arrow pointing in the correct direction when you insert it into the slot. To avoid damaging the computer or the Memory Stick, do not force the Memory Stick into the slot if it does not insert smoothly.

Removing a Memory Stick

To remove a Memory Stick using the Memory Stick slot, proceed as follows:

- 1 Check that the access light is off.
 - 2 Push the Memory Stick in towards the computer. The Memory Stick ejects.
 - 3 Pull the Memory Stick out of the slot.
-  Always remove the Memory Stick gently, or it may pop out unexpectedly.

It is recommended that you remove the Memory Stick before shutting down the computer.

Using the modem

Your computer is equipped with an internal modem.

You need to connect to a phone line to take advantage of online services and the Internet, as well as to register your computer and software online, and to contact VAIO-Link.

To connect a phone line, proceed as follows:

- 1 Plug one end of the phone cable (1) into the phone line jack  on the computer.
- 2 Plug the other end into the wall jack (2).

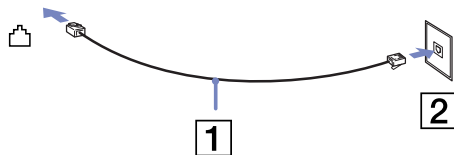

Troubleshooting the modem

My modem does not work or cannot establish a connection

- Check that the phone line is plugged into your computer.
- Make sure that the modem is the only device connected to your phone line.
- Check that the phone line is working. You can check the line by plugging in an ordinary phone and listening for a dial tone.
- Check that the phone number the program is dialling is correct. The modem dialling mode may be incompatible with your telephone line.
- The modem may not work properly if you are with a **P**riate **A**utomatic **B**ranch **eX**change (PABX).

- ❑ In the **Phone and Modem Options** dialog box (**Control Panel / Phone and Modem Options**), check that your modem is listed in the **Modems** tab, and that the location information is correct on the **Dialing Rules** tab.
If you do not see the **Phone and Modem Options** icon, click **Switch to Classic View** on the left side.
- ❑ A country-specific phone plug is supplied with your VAIO computer, allowing you to plug the phone line into the wall jack.
We recommend you to use the supplied plug, because the usage of any other phone plug can decrease the connection quality.
- ❑ Your computer cannot be connected to a coin-operated telephone, and may not work with multiple phone lines or a private branch exchange (PBX). If you connect the modem to a parallel connected phone line, the modem or the other connected device may not function properly. Some of these connections may result in excess electrical current and could cause a malfunction in the internal modem.
- ❑ Only DTMF (Dual Tone Multi Frequency) signalling (tone dialling) is supported.
- ❑ Before using the modem, it will be necessary to select the country where you are actually using it. The detailed procedure for selecting your present location is explained in **Configuring your modem** in the **Software Guide**.
- ❑ Do not pull the flexible cover too forcefully.

My modem connection is slow

Many factors influence modem connection speed, including telephone line noise or compatibility with telephone equipment (such as fax machines or other modems). If you think your modem is not connecting properly to other PC-based modems, fax machines, or your Internet Service Provider, check the following:

- ❑ Have your phone company check that your phone line is free from any line noise.
- ❑ If your problem is fax-related, check that there are no problems with the fax machine you are calling and that it is compatible with fax modems.



- ❑ If you are having a problem connecting with your Internet Service Provider, check that the ISP is not experiencing technical problems.
- ❑ If you have a second phone line available, try connecting the modem to that line.

Using the Bluetooth functionality

Your notebook is equipped with Bluetooth*. The Bluetooth wireless technology enables you to establish wireless communication between your notebook and other Bluetooth devices such as a notebook, a mobile phone or a modem station without any cable within a 10 metres range in open space.

All Bluetooth communications are made in conjunction with the **BlueSpace NE** software.

To connect to a Bluetooth device, proceed as follows:

- 1 Turn on the Wireless switch.
The **Switch wireless devices** dialog box appears.
- 2 Select the **Bluetooth** option button.
- 3 Click **OK**.
The Bluetooth icon appears in the taskbar.

*Depending on your model. Read the printed **Specifications** document for more information.

 Read the Bluetooth Regulations Lea flet before using the Bluetooth functionality.

The 2.4 GHz band with which Bluetooth devices or wireless LAN devices work, is used by various devices. Bluetooth devices use the technology to minimize the interference from other devices that use the same wave length. Communication speed and distances can be inferior to the standard values. Interference from other devices may also stop communications.

- ! The Bluetooth functions may not work depending on the devices or the software version used.
- ! When you purchase Bluetooth devices, check their operating conditions.

Bluetooth security

The Bluetooth wireless technology has an authentication function, which allows you to make sure with whom you communicate. With the authentication function, you can avoid any anonymous Bluetooth device to access your notebook.

The first time two Bluetooth devices communicate, a common **Passkey** (a password required for

authentication) should be determined for both devices to be registered. Once a device is registered, there is no need to reenter the **Passkey**.

You can change your settings in order not to be discovered by other Bluetooth devices or you can set a limit. For more information, see the **BlueSpace NE** online help.

Setting up Wireless Connections with BlueSpace NE

Your notebook is equipped with the Bluetooth wireless technology*. This new technology allows wireless communication over short distances and completely eliminates the need of using cables.

All Bluetooth communications are made in conjunction with the **BlueSpace NE** software.

* Depending on your model. Read the printed **Specifications** document for more information.

Communicating with another Bluetooth device

With the **BlueSpace NE** software, you can connect your notebook to a Bluetooth device such as another notebook, a mobile phone or a modem station without any cables.

For more details, see the **BlueSpace NE** online help.

To communicate with another Bluetooth device, proceed as follows:

- 1 Turn on the Bluetooth switch.
- 2 When the **Switch wireless devices** dialog box appears, select Bluetooth, and the application will start automatically. The Bluetooth light indicator turns blue.
- 3 Click the **Device Discovery** button in your notebook's panel on the left of the window to see the available remote devices.
- 4 Select the remote device you want to connect to. If necessary, scroll up and down in the **Bluetooth Device List** to make your selection.

- 5 Click the **Service Discovery** button to find the services available for the selected device. Sometimes when using a remote device, the **confirmation for the authentication** dialog box is displayed.
- 6 Click **Yes** and the **Bluetooth Connection Wizard** appears.
- 7 Click **Next** to continue.
- 8 Enter the same passkey in both your local and your remote device, and then click **Next**. Once the remote device has been successfully authenticated, click **Finish** and the **Service Discovery** will be carried out.
- 9 Click the service icon you want to use and proceed as applicable in each profile. When the connection has been completed and the information has been sent, the service icon turns blue.



 Do not simultaneously use the Bluetooth function and wireless communication devices which use the 2.4 GHz band such as a wireless LAN PC Card.

The passkey can be different each time, but must be the same at both ends. For certain devices, such as a mouse, no passkey can be entered.

! If you changed the name of your computer during Windows[®] setup, please go to USB Bluetooth Device under Device Manager (Start - Control Panel - System - Hardware - Device Manager - Bluetooth Radios) and right-click Properties. Under Advanced click Default to restore the default name since the name of your computer and the computer name defined in BlueSpace NE must be the same. For further information, please go to www.vaio-link.com.

Communicating with another Bluetooth device using the connection navigation

With the **BlueSpace NE** connection navigation, you can easily establish a Bluetooth connection and transfer data, such as files or pictures, to another Bluetooth device*.

To use the BlueSpace NE connection navigation, proceed as follows:

- 1 Turn on the Bluetooth switch.
- 2 When the **Switch wireless devices** dialog box appears, select Bluetooth, and the application will start automatically. The Bluetooth light indicator turns blue.
- 3 Click the **Connection navigation** button in your notebook's panel on the left of the window and follow the steps in the **BlueSpace NE connection navigation** dialog box.

* For more details, see the **BlueSpace NE** online help.

 Do not simultaneously use the Bluetooth function and wireless communication devices which use the 2.4 GHz band such as a wireless LAN PC Card. The passkey can be different each time, but must be the same at both ends.

For certain devices, such as a mouse, no passkey can be entered.

 If you changed the name of your computer during Windows® setup, please go to USB Bluetooth Device under Device Manager (Start - Control Panel - System - Hardware - Device Manager - Bluetooth Radios) and right-click Properties. Under Advanced click Default to restore the default name since the name of your computer and the computer name defined in BlueSpace NE must be the same. For further information, please go to www.vaio-link.com.

Stopping the Bluetooth connection

To stop the Bluetooth individual connection, proceed as follows:

- 1 Click the service button of the service from which you wish to disconnect.
- 2 Click **Yes** in the **Confirm Service Disconnection** dialog box.
- 3 Turn off the Bluetooth switch located on the left front side of your notebook. The Bluetooth LED turns off.

Troubleshooting Bluetooth

I cannot use the Bluetooth function

- If the Bluetooth LED is off, turn on the Bluetooth switch.
- You cannot use the Bluetooth function when the computer is in a power saving mode. Return to normal mode, then turn on the Bluetooth switch located on the front of your notebook.
- You may not be able to use the Bluetooth function if you choose the **Minimum CPU performance** feature in **PowerPanel**. Select another mode. See the **PowerPanel** online help for more details.
- You may not be able to use the Bluetooth function if you choose **Ultimate Battery Life** in **PowerPanel**. Select another mode. See the **PowerPanel** online help for more details.

The connected device does not appear in the Remote Bluetooth Device List

If the connected device is also connected to other devices, it may not appear in your **Remote Bluetooth Device Panel** or you may not be able to communicate with the device.

I cannot find the Bluetooth device with which I want to communicate

- Check that the Bluetooth function of the device with which you want to communicate is on. See the other device's manual for more details.
- If the device with which you want to communicate is already communicating with another Bluetooth™ device, it may not be found or it may not be able to communicate with your notebook.

The data transfer speed is slow

The data transfer speed depends on the obstacles and/or the distance between the two devices, but also on the radio wave quality, the operating system or the software used. Try to move your notebook or try to place the two devices closer.

I cannot communicate with the other device although the distance between both devices is within 10 metres

- ❑ The data transfer distance can be shorter than 10 metres depending on existing obstacles between the two devices, on radio wave quality, on the operating system or the software used. Try to move your notebook or to place both devices closer.
- ❑ If the device with which you want to communicate is already communicating with another Bluetooth device, it may not be found or it may not be able to communicate with your notebook.
- ❑ Check that the Bluetooth function of the device with which you want to communicate is on. See the other device's manual for more details.

Using Wireless LAN (WLAN)

Thanks to Sony's Wireless LAN (WLAN), all your digital devices with built-in WLAN functionality communicate freely with each other through a powerful network. A WLAN is a network in which a mobile user can connect to a local area network (LAN) through a wireless (radio) connection. So there is no need anymore to pull cables or wires through walls and ceilings.

The Sony WLAN supports all normal Ethernet activities, but with the added benefits of mobility and roaming. You can still access information, internet/intranet and network resources, even in the middle of a meeting, or as you move from one place to another.

You can communicate **without an Access Point**, this means that you can communicate between a limited number of computers (**ad-hoc**), or you can communicate through **an Access Point**, which allows you to create a full infrastructure network (**infrastructure**).

 In some countries, using WLAN products may be restricted by the local regulations (e.g. limited number of channels). Therefore, before activating the WLAN functionality, read the **Wireless LAN Regulation** carefully. For more information on channel selection, see **Wireless LAN channel selection** (page 57).

WLAN uses the IEEE 802.11b/g standard, which specifies the used technology. The standard includes the encryption method: **Wired Equivalent Privacy** (WEP), which is a security protocol and **WiFi Protected Access** (WPA - Proposed jointly by the IEEE and Wi-Fi Alliance, WiFi Protected Access is a specification of standards based, interoperable security enhancements that increase the level of data protection and access control for existing WiFi networks. WPA has been designed to be forward compatible with the IEEE 802.11i specification. It utilizes the enhanced data encryption TKIP (Temporal Key Integrity Protocol) in addition to user authentication using 802.1X and EAP (Extensible Authentication Protocol)). Data encryption protects the vulnerable wireless link between clients and Access Points. Besides that, there are other typical LAN security mechanisms to ensure privacy, such as: password protection, end-to-end encryption, virtual private networks, and authentication.

Wireless LAN devices using the IEEE 802.11a standard and the ones using the IEEE 802.11b or g standard cannot communicate because the frequencies are different. Wireless LAN devices using the IEEE 802.11g standard can only communicate with a device using the IEEE 802.11b standard, not with the a standard.

IEEE 802.11b: The standard speed is 11 Mbps, or about 30 to 100 times faster than a standard dial up.

IEEE 802.11g: The standard speed is 54 Mbps, or about 5 times faster than a Wireless LAN device using the IEEE 802.11b standard.

Communicating without Access Point (ad-hoc)*

An ad-hoc network is a network in which a local network is created only by the wireless devices themselves, with no other central controller or Access Point. Each device communicates directly with other devices in the network. You can set up an ad-hoc network easily at home.

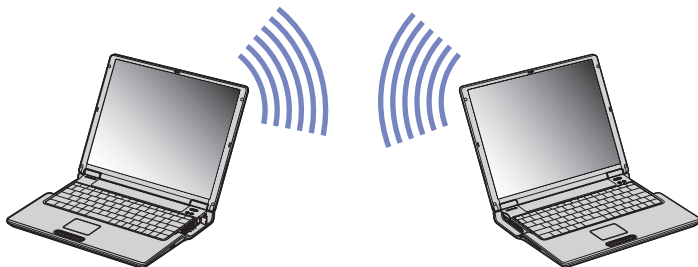

* For more information on your model, please read your **Specifications** document.

If your computer is equipped with **wireless LAN 802.11 b/g**, proceed as follows:

- 1 Turn on the **Wireless LAN switch**.
If your notebook supports Bluetooth, the **Switch wireless devices** dialog box appears. Select **Wireless LAN** and click **OK**.
The **Wireless Switcher** button changes into Wireless LAN.
- 2 Double-click the network icon in the taskbar displaying **Wireless Network Connection**.
The **Connect to Wireless Network** dialog box appears.
- 3 Click the **Advanced** button.
The **Wireless Network Connection Properties** dialog box appears.
- 4 Select the **Wireless Networks** tab.

- 5 Click the **Add...** button.
The **Wireless Network Properties** dialog box appears.
- 6 Enter a **Network name (SSID)***.
You can choose a **6-digit** name.
- 7 Select **Open** from the **Network Authentication** drop-down box.
- 8 Select **WEP** from the **Data Encryption** drop-down box.
- 9 Deselect the **The key is provided for me automatically** option button.
Some information becomes visible.
- 10 Fill in the **Network key***.
The network key should be 5 or 13 ascii characters or 10 or 26 hexadecimal characters long. You can choose whatever you want**.
- 11 Fill in exactly the same **Network key** again, for confirmation.
- 12 Select the checkbox **This is a computer to computer (ad hoc) network; wireless access points are not used** at the bottom of the screen.
- 13 Click **OK**.
Your **Network name** appears in the **Preferred networks**.
- 14 Click **Advanced**.
The **Advanced** dialog box appears.
- 15 Select the **Computer-to-computer (ad hoc) networks only** option button.
- 16 Click **Close**.
- 17 Click **OK**.
Your computer is ready to communicate with another computer.

* If you want to communicate between two or more computers, you need to configure all these computers the exact same way. This means that you need to enter the same **Network name** and the same **Network key** on all computers as on the first computer you configure.

** **ASCII**: The basis of character sets used in almost all present-day computers. ASCII is a code for representing English characters as numbers, with each letter assigned a number from 0 to 127.

Hexadecimal: A number representation using the digits 0-9, with their usual meaning, plus the letters A-F (or a-f) to represent hexadecimal digits with values of (decimal) 10 to 15.



In France, only certain channels are legally allowed when using WLAN outdoors.
For more information, see the Wireless LAN Regulations leaflet.

An ad-hoc network does not support WPA.

If your computer is equipped with **wireless LAN 802.11 b**, proceed as follows:

- 1 Turn on the **Wireless LAN switch**.
The **Switch wireless devices** dialog box appears.
- 2 Select **Wireless LAN** and click **OK**.
The **Wireless Switcher** button changes into Wireless LAN.
- 3 Double-click the network icon in the taskbar displaying **Wireless Network Connection**.
The **Wireless Network Connection** dialog box appears.
- 4 Click the **Advanced** button.
The **Wireless Network Connection Properties** dialog box appears.
- 5 Select the **Wireless Networks** tab.
- 6 Click the **Add...** button.
The **Wireless Network Properties** dialog box appears.
- 7 Enter a **Network name (SSID)***.
The **Data encryption (WEP enabled)** option button must be selected.
- 8 Select the **Network Authentication (Shared mode)** option button.
- 9 Deselect the **The key is provided for me automatically** option button.
Some information becomes visible.

- 10 Fill in the **Network key****.

The network key should be 5 or 13 ascii characters or 10 or 26 hexadecimal characters long. You can choose whatever you want***.

- 11 Click **OK**.

Your **Network name** appears in the **Preferred networks**.

- 12 Click **Advanced**.

The **Advanced** dialog box appears.

- 13 Select the **Computer-to-computer (ad hoc) networks only** option button.

- 14 Click **Close**.

- 15 Click **OK**.

Your computer is ready to communicate with another computer.

* For more information on your model, please read your **Specifications** document.

** If you want to communicate between two or more computers, you need to configure all these computers the exact same way. This means that you need to enter the same **Network name** and the same **Network key** on all computers as on the first computer you configure.

*** **ASCII**: The basis of character sets used in almost all present-day computers. ASCII is a code for representing English characters as numbers, with each letter assigned a number from 0 to 127.

Hexadecimal: A number representation using the digits 0-9, with their usual meaning, plus the letters A-F (or a-f) to represent hexadecimal digits with values of (decimal) 10 to 15.



In France, only certain channels are legally allowed when using WLAN outdoors. For more information, see the Wireless LAN Regulations leaflet.

Communicating with an Access Point (infrastructure)

An infrastructure network is a network that extends an existing wired local network to wireless devices by providing an Access Point, for example the **Sony PCWA-A320 Access Point**. The Access Point bridges the wireless and wired LAN and acts as a central controller for the Wireless LAN. The Access Point coordinates transmission and reception from multiple wireless devices within a specific range.

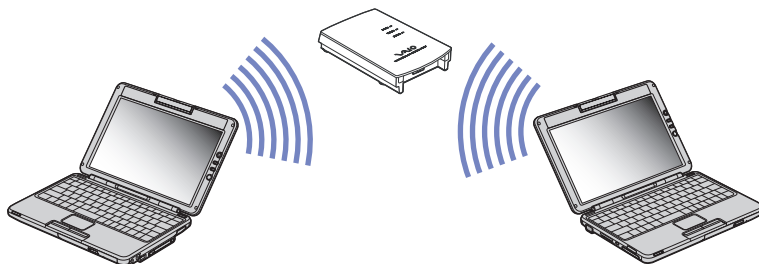

To communicate with an Access Point (infrastructure), proceed as follows:

- 1 Turn on the **Wireless switch**.
If your notebook supports Bluetooth, the **Switch wireless devices** dialog box appears. Select **Wireless LAN** and click **OK**.
The **Wireless Switcher** button changes into Wireless LAN.
- 2 Right-click the network icon  in the taskbar displaying the **Wireless Network Connection** message.
- 3 Click **View Available Wireless Networks**.
The **Wireless Network Connection** dialog box appears.
- 4 Select the network you want to use.

5 Type the **Network Key**.

If you are using the **Sony Access Point PCWA-A320**, by default, you do not need to enter any encryption key (WEP/WPA). To be able to communicate, you must select the box **Allow me to connect to the selected wireless network, even though it is not secure**.

6 Click **Connect**.

After 30 seconds, the connection is established.



For more information about setting up an access point, see the documentation supplied with your **Access Point**.

The length of the network key can be set up as in the case of ad-hoc network; meaning, 5 or 13 ascii characters or 10 or 26 hexadecimal characters long.

The WPA key needs to contain at least 8 characters.

Using the WiFi protected access (WPA)

WPA is a wireless security enhancement that allows you to transfer data in a highly secure way*.

To use WPA on your notebook, proceed as follows:

1 Turn on the **Wireless LAN switch**.

If your notebook supports Bluetooth, the **Switch wireless devices** dialog box appears. Select **Wireless LAN** and click **OK**.

The **Wireless Switcher** button changes into Wireless LAN.

2 Right-click the network icon in the taskbar displaying **Wireless Network Connection**.

3 Select **View available network connections**.

The **Wireless Network Properties** dialog box appears.

4 Select the wireless network to which you want to connect.

5 Fill in the **Network key**.

The network key should be at least 8 characters long. You can choose whatever you want.

6 Fill in exactly the same **Network key** again, for confirmation.

7 Click **Connect**.

The connection is established.

* For more information on the access point, please refer to its manual.

 In France, only certain channels are legally allowed when using WLAN outdoors.
For more information, see the Wireless LAN Regulations leaflet.

Wireless LAN channel selection

In a 802.11b configuration, channel 1 to 11 can be used.

In a 802.11g configuration, channel 1 to 13 can be used*.

* Depending on your model. Read the printed **Specifications** document for more information.

(a) With an access point ("Infrastructure")

- The channel used will be the channel selected by the Access Point.
- ATT: For details on how to select the channel that will be used by the Access Point, please refer to the corresponding Instruction Manual.

(b) Without an access point ("Ad-hoc")

- If the Wireless connection is initiated by the VAIO computer, channel 11 will be selected.
- ATT: In France, outdoors, Wireless LAN connections are only allowed on certain channels. For details, please refer to the **Wireless LAN Regulations** leaflet.
- If the Wireless connection is initiated by a peer Wireless LAN equipment, the Wireless LAN communication will make use of the channel selected by the peer Wireless LAN equipment.

Troubleshooting Wireless LAN

I cannot use the Wireless LAN function

- Check if the Wireless switch is turned on.

The Wireless LAN Access Point and your computer cannot communicate

- Check if the Wireless LAN switch is turned on.
- Check if the power of the Access Point is turned on.
- Check if the Access Point is displayed in the **Available networks** window.
 - To check this, click **Start** and then **Control Panel**.
 - Double-click the **Network Connections** icon.
 - Right-click the **Wireless Network Connection** icon and select **Properties**.
 - Select the **Wireless Networks** tab.
 - Check if the Access Point is displayed in **Available networks**.
 - Connection availability is affected by distance and obstructions. You may need to move your computer away from obstructions or neared to any Access Point you may be using.

The data transfer speed is slow

- The maximum communication speed can vary depending on the obstacles or the distance between the communication devices, the radio waves, the operating system or the software you use. Remove the obstacle or make the distance between the Access Point and your machine smaller.
- It is possible that your Access Point communicates at the same time with another Access Point. Read the manual of the Access Point.
- If several computers communicate with the same Access Point, the concentration may be too high. Wait a few minutes and try to access again.

- ❑ If a Wireless LAN device using the IEEE 802.11g standard communicates with a device using the IEEE 802.11b standard, then it is normal that the speed reduces. Devices using the IEEE 802.11g standard are 5 times faster than the ones using the IEEE 802.11b standard.

I cannot access the Internet

- ❑ Check the settings of the Access Point. See the manual of the Access Point.
- ❑ Check if your computer and the Access Point are communicating.
- ❑ Make the distance between the Access Point and your machine smaller.

Using the built-in MOTION EYE Camera*

Your computer includes a built-in **MOTION EYE** camera. You can use the camera software to shoot still images, record video clips or make on line video conferences.

You can focus the image turning the adjustment dial (2) in the camera. You can also rotate the **MOTION EYE** camera backwards and forwards to choose the view point shown in the camera.

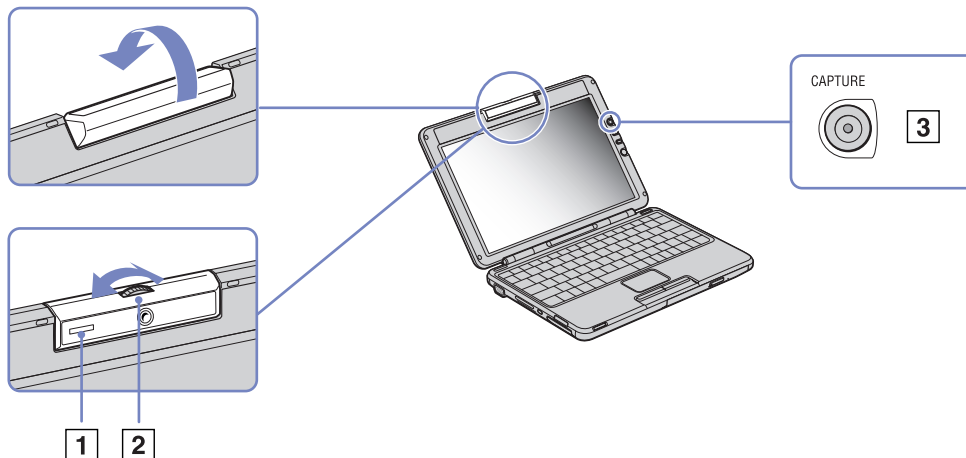

* Depending on your model. Read the printed **Specifications** document for more information.

On the right side of the LCD screen, you find the CAPTURE button (3) for using with the **MOTION EYE** camera. Clicking this button you can:

- Shoot still images
- Start and stop recording video clips

- ❑ Start the **Network Smart Capture** application

 To start Network Smart Capture with the Capture button, the application must be installed.

To start the **MOTION EYE** camera with the Windows® application, proceed as follows:

Under **Start- My Computer- Scanners and Cameras** click **Sony Visual Communication Camera VCC-U01**.

The camera starts automatically.

The **MOTION EYE** camera indicator (1) turns green when the camera is working.

 You can only shoot still images.

To start the **MOTION EYE** camera with the **Network Smart Capture** application, proceed as follows:

- ❑ Click **Start - All Programs - Network Smart Capture**,

or

- ❑ Press the **Capture** button.

For more information about **Network Smart Capture**, please refer to the **Software Guide** supplied with your computer.

Troubleshooting MOTION EYE Camera

There is a vertical line when shooting a bright subject with a dark background using MOTION EYE

This is a phenomenon called "smear". It is not a malfunction.

The image in the view finder of Network Smart Capture is rough

If you are shooting a subject in rapid movement, there may be a gap. This is not a malfunction.

The images captured with MOTION EYE are not clear

- ❑ Shooting under fluorescent light may result in reflections.
- ❑ Red or green noises may occur if the captured images include dark parts.
- ❑ Check that the lens of the MOTION EYE is clean.
- ❑ Use the focus ring to adjust.

There are picture gaps and sound gaps when importing video images

Gaps may occur based on the effect settings in **Network Smart Capture**.

The MOTION EYE does not show any images

- ❑ Check that other software such as **Network Smart Capture** does not use the MOTION EYE.
- ❑ Depending on monitor mode, colour palette and other causes, the video memory is running out and the camera image is not displayed. Reduce the colour palette or monitor resolution.
- ❑ If the above countermeasures do not work, restart the computer.

Using power saving modes

When you use a battery as the source of power for your computer, you can take advantage of power management settings to conserve battery life. In addition to the normal operating mode, which allows you to turn off specific devices, your computer has two distinct power saving modes: **Standby** and **Hibernate**. When using battery power, you should be aware that the computer automatically enters **Hibernate** mode when the remaining battery charge drops below 7 percent, regardless of the power management setting you select.

 If the battery level falls below 10 percent, you should either attach the AC adapter to recharge the battery or shut down your computer and insert a fully charged battery.

Using Normal mode

This is the normal state of your computer when it is in use. The green power indicator light is on in this mode. To save power while not working, you can turn off a specific device such as the LCD or the hard disk.

Using Standby mode

Standby mode turns off the LCD screen and sets the hard disk and the CPU to a low power consumption mode. The amber power light flashes in this mode.

To activate Standby mode, proceed as follows:

Go to **Start/Turn Off Computer** and press **Stand By**.

Or press the **<Fn>+<Esc>** keys simultaneously.

To return to **Normal** mode, press any key.

 If you press the power button for more than four seconds, the computer will switch off automatically.

When the computer is in **Standby** mode, you cannot insert a disc.

The computer comes out of **Standby** mode quicker than out of **Hibernate** mode.

Standby uses more power than **Hibernate**.

If the computer is not used for 25 minutes, it will enter **System Standby** mode when running on AC power. When running on batteries, the computer will enter **System Standby** mode after 5 minutes if unused. To avoid this, you can change the settings either in PowerPanel (right-click on the **PowerPanel** icon and select **Edit/Create Profile**) or in the **Control Panel**. Please note that your **Control Panel** settings are valid only until the next reboot.

Using Hibernate mode

The state of the system is saved on the hard disk and power is turned off. The power indicator light is off in this mode.

To activate Hibernate mode, proceed as follows:

Press **<Fn>+<F12>**.

The **Hibernating** screen appears and the computer enters **Hibernate** mode.

Alternatively,

Click **Start**, and then **Turn Off Computer**.

In the **Turn off computer** screen, hold down the **<Shift>**-key and press **Hibernate**.

To return to Normal mode, proceed as follows:

Turn on the computer by pressing the power button.

The computer returns to its previous state.

 If you press the power button for more than four seconds, the computer will switch off automatically.

When the computer is in **Hibernate** mode, you cannot insert a disc.

Hibernate mode requires more time than **Standby** mode to be activated.

It takes more time to return to normal mode from **Hibernate** mode than from **Standby** mode.

Hibernate mode uses less power than **Standby** mode.

Do not move the computer until its power indicator turns off.

Troubleshooting power management

The power management setting is not responding

Your computer's operating system may become unstable if a lower power state, such as **Hibernate** is initiated, and then changed before the computer completely enters the lower power state.

To restore the computer to its normal operating stability, proceed as follows:

- 1 Close all open applications.
- 2 Press **<Ctrl>+<Alt>+<Delete>** simultaneously and select **Restart** from the drop-down list. The computer restarts.
- 3 If the procedure does not work, press and hold the power button for four seconds or longer to shut down the computer.

Managing power with PowerPanel

The **PowerPanel** utility controls the power management of your computer and provides key information about system activity and battery life. The automatic power management selects the most advantageous profiles, or lets you customise the profiles you choose, according to your own needs, with the goal of extended battery life.

Moreover, performance of your computer can be improved with Performance Balancer, both for battery and AC mode, adjusting LCD brightness and CPU fan noise.

PowerPanel has the following features:

- ❑ Automatic Profile Selection (APS) based on the currently active application;
- ❑ Ability to select specific Power Profiles manually from the menu;
- ❑ Ability to edit and create new profiles;
- ❑ Ability to display detailed battery information;
- ❑ It works in harmony with your Windows settings;
- ❑ Support for Windows XP Theme;
- ❑ ToolTips to signal Power Profile changes;
- ❑ Ability to select limited Power Profiles directly from the Power Profile page;
- ❑ Ability to prevent specific users from modifying profiles.

Activating PowerPanel

When you start the computer, the **PowerPanel** icon appears in the system tray by default. To see the current power profile, simply point to the icon. The current power profile will be displayed in a tooltip.

To change profiles, proceed as follows:



- 1 Right-click the **PowerPanel** icon in the taskbar and select **Profiles**.
- 2 In the **Profiles** menu, select a profile.
The appropriate power settings are activated.

 When you use the battery pack as power source, your system selects the **Maximum Battery Life** power management profile by default. If you select a different power management profile while using battery power, the same profile will automatically be selected the next time you use the battery pack to power your computer.









Activating power management profiles





PowerPanel provides several predefined **power management profiles**. Each profile consists of a group of power management settings that are designed to meet specific power management goals, ranging from maximum power management to no power management.

Running on AC

Icon	Description
	AC Power – The power management state when AC power is in use. PowerPanel automatically loads the AC profile unless you disable this feature.
	Power Management Off (Plugged in) – Turns off all power management features such as Standby and Hibernate modes.

Running on batteries

Icon	Description
	Automatic Profile Selection - Analyses the performance of each application you choose and matches the profiles to its needs.
	Maximum Battery Life – Provides power saving features to give you maximum battery life and good performance. It reduces the brightness of the display and puts the system into Standby mode after a specified time period.
	Ultimate Battery Life – Extends the Maximum Battery Life by completely disabling the optical drive. <p>! When you select this profile, it completely shuts off the power of the Memory Stick port to save some extra power for longer battery life. The Memory Stick port is accessible again as soon as a Memory Stick is inserted in the slot.</p> <p>! When you select this profile, it completely shuts off the power of the optical drive to save extra power for longer battery life. The system can neither read nor write from or to the optical drive, moreover the drive does not start spinning at all.</p>
	Maximum Performance – Provides the best system performance while still conserving power.
	Word Processing – Optimises power management with longer timeouts on the hard disk and display screen. You can also establish settings for LCD (Video) Standby, Hard Disk Standby, and Standby to optimise power management for your system.
	Spreadsheet – Reduces the LCD brightness to 'medium', as your software does not require higher performance.
	Presentation – Keeps the display on at all times while it conserves power. This option is ideal for slideshow presentations. You can establish settings for LCD (Video) Standby , Hard Disk Standby , and Standby to optimise power management for your system.
	Communications – Extends battery life by initiating a quick display time-out. You can also establish settings for LCD (Video) Standby , Hard Disk Standby , and Standby to optimise power management for your system.

<i>Icon</i>	<i>Description</i>
	Games – Disables the display and the Hard Disk timer.
	DVD – Optimises performance and power requirements for DVD usage.
	Camera – Optimises performance and power requirements for camera usage.
	Power Management Off (Running on batteries) – Turns off all power management features such as Standby and Hibernate modes.

Selecting automatic profiles when running on batteries

A power profile is a set of timer values for a variety of system devices. PowerPanel automatically selects the profile associated with the application you are using and changes profiles as you switch between applications.

Power management lets your system enter energy saving modes by levelling some energy-consuming parameters, such as LCD brightness, or hard disk activity.

To select automatic profiles, proceed as follows:

- 1 Right-click the **PowerPanel** icon in the taskbar and select **Profiles**.
- 2 Select **Automatic Profile Selection**.

 The **Automatic Profile Selection** feature deactivates when you manually select another power profile from the menu.





Displaying detailed battery information

You can display detailed information of your computer's battery.

There are 3 ways in which you can display battery information:



- ❑ Right-click the **PowerPanel** icon in the taskbar and select **Battery Information** from the menu.
- ❑ Double-click the **PowerPanel** icon in the taskbar and select the **Battery** tab. The **Battery** tab in the **PowerPanel** window contains information such as the estimated battery life remaining and charging time.
- ❑ Display the **Battery Information** toolbar on the screen, which shows the battery status icon, the percentage of remaining capacity and the amount of running time left in the battery. To display the **Battery Information** toolbar, right-click the taskbar and select **Toolbars** then **Battery Information** from the menu.

Battery icon *Battery status*

	Discharging: the icon is blue
	Fully charged: the icon is completely blue with an AC power plug
	Charging: the icon is blue with a red clip attached to the terminal
	No battery: the icon is blue with a yellow cross over it

Displaying CPU information

You can also view the level of performance of your notebook with the CPU Controls. To do so, you just have to hover your cursor over the CPU icon in the taskbar. There are three possible icons:

<i>Icon</i>	<i>Action</i>
Adaptive 	This control automatically selects the CPU optimal clock speed and power voltage according to the state in which the computer is used. This will be the default icon when the computer is connected to the mains supply.
Battery Life 	This control helps to reduce the notebook's power consumption by decreasing the CPU clock speed and the power voltage. This icon appears when you right-click the CPU icon in the taskbar and select Profiles and then Ultimate Battery Life. This will be the default icon when the computer running on batteries.
Performance 	This control helps to maximize the CPU clock speed. The computer can then be used at its maximum performance. This will be the default icon when playing games or watching a DVD.

Editing a power profile

To edit the power management settings of a power profile, proceed as follows:

- 1 Right-click the **PowerPanel** icon in the taskbar and select **Edit/Create Profiles** from the menu. The **Profile Editor** window appears.
- 2 Click the profile you want to edit on the left of the screen.
- 3 Double-click the power profile property (Hibernate, Standby...) you want to modify on the right of the screen.
An option list or a dialog box appears.

- 4 Make your settings.
- 5 Click the **File** menu and then click **Save**

 You must have Administrator's rights on your computer to be able to edit existing profiles. Users whose account type is **Limited** can only open the **Power Profile** tab in the **Power Panel** window in view mode. To check your user account information, select the **User Accounts** category in the **Control Panel**. Your account type must be **Computer administrator** to be able to edit power profile.

Creating a power profile

To create a power profile, proceed as follows:

- 1 Right-click the **PowerPanel** icon in the taskbar and select **Edit/Create Profiles** from the menu. The **Profile Editor** window appears.
- 2 Select **New** from the **File** menu.
- 3 In the **Create New Profile** dialog box, check the appropriate option button to specify the type of power management profile that you want to create and click **OK**.
- 4 Select the new power management settings you would like for the device.
- 5 Click the **File** menu and then click **Save**.

Managing performance with Performance Balancer

The Performance Balancer is installed by default together with PowerPanel to set up the performance of your computer depending on the LCD brightness and the quietness of the CPU fan.

To use Performance Balancer, proceed as follows:

- 1 Click the **Start** button on the **Windows®** taskbar.
- 2 In All Programs, select Performance Balancer and then click Performance Balancer. The Performance Balancer window appears.

To set up the performance of your computer, proceed as follows:

1 When operating on battery mode:

- ❑ Click **Power-saving** to enjoy a long battery life and a CPU fan with minimum noise. Performance and LCD brightness will be reduced to lower battery consumption.
- ❑ Click **Customize** if you want to adjust the brightness and the CPU fan quietness to determine the CPU performance and the battery life.
- ❑ Click **Full-power** to maximise system performance what allows you to run many applications at the same time with a high LCD brightness. With this setting, the battery life and the quietness of CPU fan are reduced.

2 When plugged in:

- ❑ Click **Customize** if you want to adjust the brightness and CPU fan quietness manually to determine the CPU performance and the power consumption.
- ❑ Click **Full power** to maximise system performance, which allows you to run many software at the same time, renouncing to CPU fan quietness.

An additional option is the **Timer Settings** where you can set up the LCD display to turn off automatically and go into **Standby** mode after a period of inactivity, when operating either on battery or AC mode.

Connecting peripheral devices

You can add functionality to your computer by using the various ports on your unit.

- ❑ Connecting a port replicator ([page 76](#))
- ❑ Connecting an external display ([page 81](#))
- ❑ Selecting display modes (PCG-Z1, PCG-V505 series) ([page 85](#))
- ❑ Selecting display modes (PCG-TR series) ([page 86](#))
- ❑ Using the Dual Display function ([page 88](#))
- ❑ Connecting external speakers ([page 91](#))
- ❑ Connecting an external microphone ([page 92](#))
- ❑ Connecting a Universal Serial Bus (USB) device ([page 93](#))
- ❑ Connecting a printer ([page 98](#))
- ❑ Connecting an i.LINK device ([page 100](#))
- ❑ Connecting to a network (LAN) ([page 103](#))

 To identify and locate the ports on your computer, please see the printed **Specifications** sheet.

Sony computer supplies, accessories and peripherals can be purchased from your local retailer or from the Sony website: www.sonystyle-europe.com

For more information about connection compatibility, go to the VAIO-Link website: www.vaio-link.com

Connecting a port replicator

Your computer supports the use of an optional port replicator. Attaching a port replicator enables you to connect additional peripherals to your computer, such as a printer or an external display*.

PCG-Z1 series:

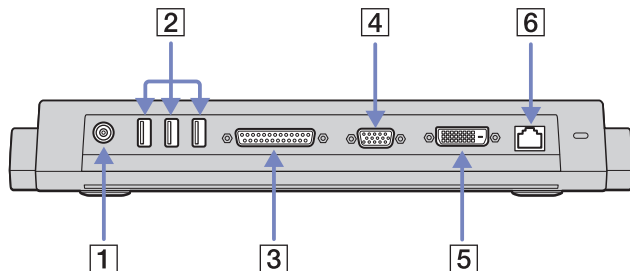

1	DC In port	(page 14)	4	Monitor/VGA port	(page 81)
2	3 USB ports	(page 93)	5	DVI-D connector	(page 82)
3	Parallel printer port	(page 98)	6	Ethernet port (10BASE-T/ 100BASE-TX)	(page 103)

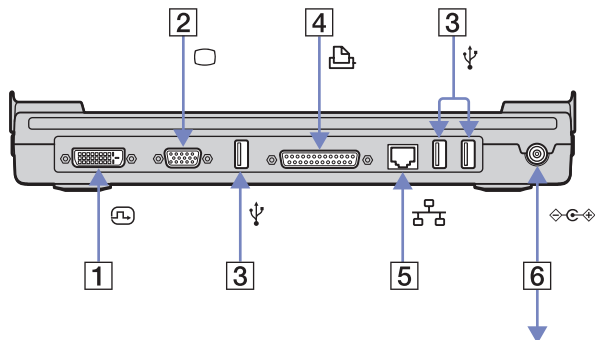
PCG-V505 series:

1	DVI-D connector	(page 82)	4	Parallel printer port	(page 98)
2	Monitor/VGA port	(page 81)	5	Ethernet port (10BASE-T/100BASE-TX)	(page 103)
3	3 USB ports	(page 93)	6	DC In port	(page 14)

* Depending on your model. Read the printed **Specifications** document for more information.

 The port replicator can be powered only with the AC adapter supplied with your notebook. Do not remove the AC adapter from the port replicator or the AC outlet when using the port replicator; this may cause data damage or hardware malfunctions.

Attaching your computer to the port replicator

If your computer is equipped with a port replicator, proceed as follows:

- 1 Disconnect all peripherals from the computer.
- 2 Plug the cable attached to the AC adapter (1) into the DC In port (2) on the port replicator (3).

- 3 Plug the power cord (4) into the AC adapter and an AC outlet.

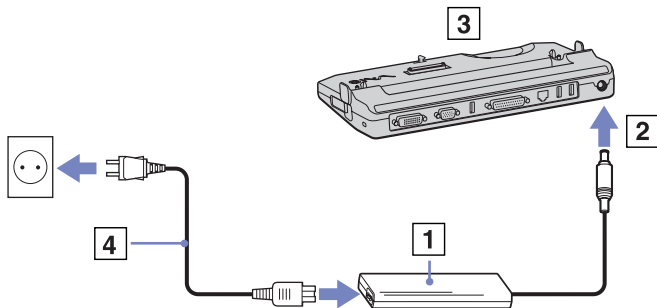

- 4 Open the port replicator cover.

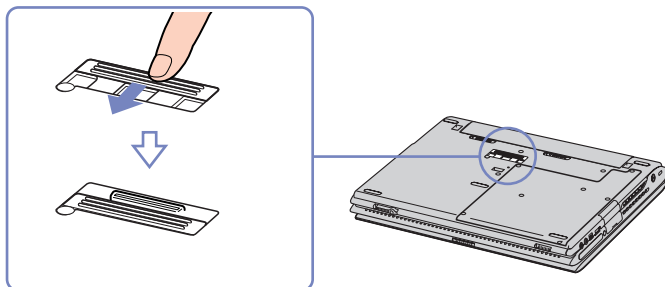

- 5 Align the bottom connector of the notebook with the connector on the port replicator and push down until it clicks into place.

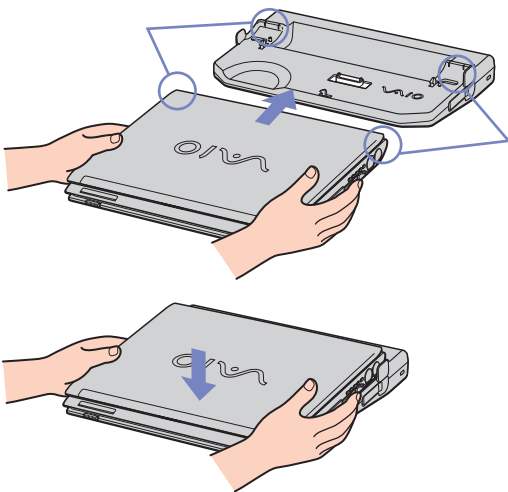

6 Turn on the notebook.

 When attaching your computer to the port replicator, do not attempt to insert or remove the battery pack. Lifting and turning the computer with the attached port replicator may cause a temporary loss of power.

Use the AC adapter that comes with your notebook or the optional Sony adapter.

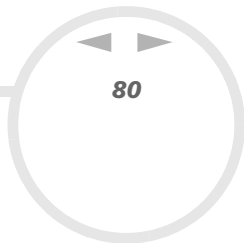

Disconnecting your computer from the port replicator

To disconnect your computer from the port replicator, proceed as follows:

- 1 Stop the connected peripherals.**
- 2 Close the cover and pull the levers on each side of the port replicator to disconnect the computer from the port replicator.**
- 3 Lift the computer away from the port replicator.**
- 4 Close the port replicator connector cover on the bottom of your computer.**

 It is extremely important to close the port replicator connector cover after removing your computer from the port replicator. If the cover is left open, dust may get inside and damage the computer.

To disconnect your port replicator completely from the mains voltage, unplug the AC adapter.

Connecting an external display

You can connect an external display to your computer. For example, you can use your computer with a computer display or a projector.

-  Turn off your computer and the peripherals, unplug the AC adapter and the power cord before connecting the external display.
 - Connect the power cord after connecting all other cables.
 - Turn on the peripherals, then turn on your computer.
 - Connected external displays are used as second screens.
 - On Windows systems only, you can also use an external display to set up a virtual desktop.

Connecting a computer display

You can connect a computer display (monitor) either directly to your computer or via the (optional) port replicator.

To connect a computer display, proceed as follows:

- 1 If you want to connect a VGA monitor, plug the display cable (1) (not supplied) on the notebook or on the port replicator.
- 2 If you want to connect a TFT/DVI monitor, plug the display cable (not supplied) into the DVI-D connector on the port replicator.
- 3 If necessary, plug one end of the display's power cord (3) into the display, and the other end into an AC outlet.

 **DVI-D** stands for **D**igital **V**isual **I**nterface - **D**igital. It is a kind of DVI connector that only supports digital video signals, so no analogue video signals. It has 24 pins.

A **DVI-I** connector (**D**igital **V**isual **I**nterface - **I**ntegrated) supports digital video and analogue video signals. It has 29 pins.

! You can not connect a DVI-I to VGA cable to a DVI-D connector!

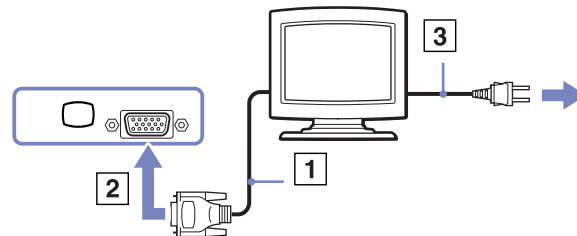

Connecting a multimedia computer display

You can connect the computer to a multimedia computer display that includes built-in speakers and a microphone.

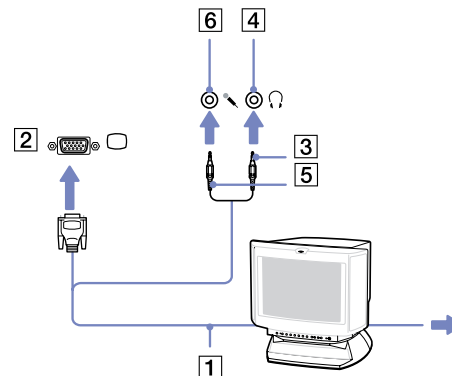

To connect a multimedia computer display, proceed as follows:

- 1 Plug the display cable (1) into the monitor/VGA connector (2) on the computer.
- 2 Plug the speaker cable (3) into the headphone connector (4) on the computer.
- 3 Plug the microphone cable (5) into the microphone connector (6) on the computer.



Connecting a projector

To connect a projector, proceed as follows:

- 1 Plug the RGB signal cable (1) into the monitor/VGA connector (2) identified by the  symbol.
- 2 Plug the audio cable (3) (not supplied) into the earphone connector (4) identified by the  symbol.
- 3 Plug the RGB signal cable and the audio cable into the connectors of the projector (5).
- 4 Connect the power cord (6) of the projector into an AC outlet.

 Under certain circumstances, you may not be able to display the computer LCD screen and an external display or a projector at the same time.

You can toggle the output between the computer LCD-screen and the external monitor by pressing the key combination **<Fn>+<F7>**.

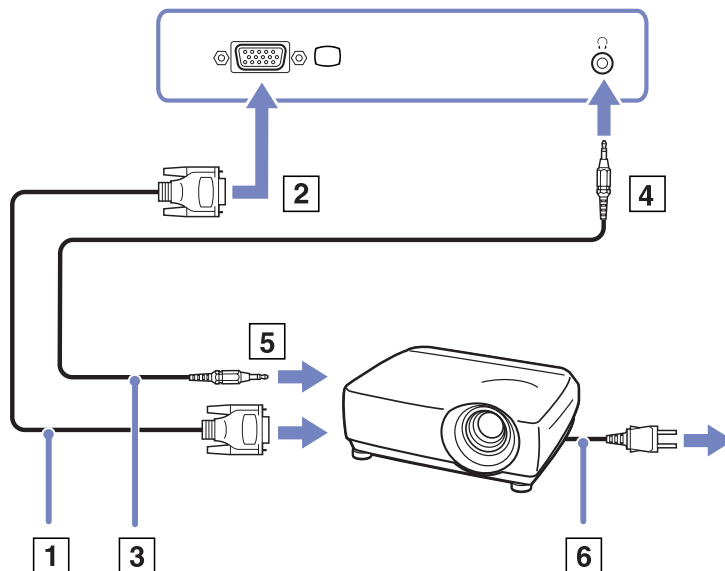

Selecting display modes (PCG-Z1, PCG-V505 series)

Both models use the MOBILITY RADEON video controller. You can select which display is used when the computer is connected to an external display. When you connect an external display, you can switch the display between your computer's LCD and the external monitor.

Before you can select a display, you need to shut down your computer, connect the external display (FDP (Flat Display Panel)), panel or monitor to your computer, and restart.

To select a display, proceed as follows:

- 1 Click the **Start**, then **Control Panel**.
The **Control Panel** appears.
- 2 Double-click **Appearance and Themes**, and then select **Display**.
The **Display Properties** dialog box appears.
- 3 Click the **Settings** tab.
- 4 Click the **Advanced** button.
The **Sony Notebook LCD and MOBILITY RADEON Properties** dialog box appears.
- 5 Click the **Displays** tab.
Select the **Monitor, Panel** or **FPD** icon.
- 6 Click **Apply** and then **OK**.

 You may not be able to display the computer LCD screen and an external display or a projector at the same time, depending on the types of computer displays and projectors you are using.

Before turning on the computer, turn on the peripheral devices.

Selecting display modes (PCG-TR series)

This model uses the Intel® 855 GM Integrated Graphics video controller. You can select which display is used when the notebook is connected to an external device.

To connect an external display, proceed as follows:

- 1 Connect the external device to the Monitor/VGA connector on the left side of the computer.
- 2 Press and hold the **<Fn>** key and press the **<F7>** key to change the destination.
The output destination changes every time you press the **<F7>** key while holding the **<Fn>** key. The output destination options are listed below:
 - **LCD only:** Displays contents on your computer's LCD only.
 - **LCD only + MONITOR (VGA):** Displays contents simultaneously on your computer's LCD and the external display*.
 - **MONITOR (VGA):** Displays contents on the external display only*.
 - **Setup:** Displays the resolution setting window for the external display.
The image appears on the external display.

To set up the video controller options, proceed as follows:

- 1 Click Start, then Control Panel.
The Control Panel appears.
- 2 Double-click **Appearance and Themes**, and then select **Display**.
The **Display Properties** dialog box appears.
- 3 Click the **Settings** tab.
- 4 Click the **Advanced** button and choose the **Intel® Extreme Graphics** tab.
Then choose the **Graphics Properties** icon.
- 5 Click the **Devices** tab.
Select the **Monitor, Notebook, Intel® Dual Display Clone** or **Extended Desktop** icon.
- 6 Click **Apply** and then **OK**.

* The external destination is displayed only when an external display is connected to your computer.

-  You cannot switch the display during video playback or while using the built-in MOTION EYE camera. Selecting the external display may automatically change the resolution of your computer's LCD.

Using the Dual Display function

The dual display function allows you to distribute portions of your desktop across separate displays. For example, if you have an external monitor attached to the monitor connector, your LCD display and the monitor can function as a single desktop.

You can move the cursor from one display to the other. This allows you to drag objects, such as an open application window or a toolbar, from one display to the other.

This configuration of a single desktop distributed across separate displays, is referred to as a virtual desktop.

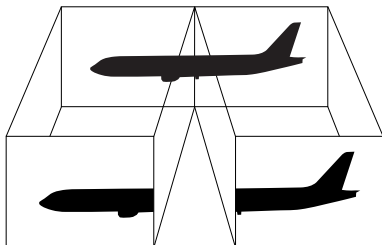

 Your monitor or TV hardware may not support the Dual Display function.

Certain software applications may not be compatible with Dual Display settings.

Make sure that your computer does not enter **Standby** or **Hibernate** mode while you are using Dual Display mode, otherwise your computer may not return to **Normal** mode.

If you set different colours on each display, do not divide one single window on two displays, otherwise your software may not work properly.

Set fewer colours or a lower resolution for each display.

Selecting the Dual Display mode

To select the Dual Display mode, proceed as follows:

- 1 Click the **Start** button on the **Windows** taskbar.
- 2 Click **Control Panel**.
- 3 Click **Appearance and Themes**.
- 4 Click the **Display** icon.
- 5 Select the **Settings** tab.
- 6 Click the display marked **2**.
- 7 Select the **Extend my Windows desktop onto this monitor** check box.
- 8 Click **Apply** and then **OK**.

 Your monitor or TV hardware may not support the Dual Display function.

Setting the colours and resolution for each display

You can set the display colours and resolution for each display that is part of a virtual desktop.

To set the display colours and resolution for each display, proceed as follows:

- 1 Click the **Start** button on the **Windows** taskbar.
- 2 Click **Control Panel**.
- 3 Click **Appearance and Themes**.
- 4 Click the **Display** icon.
- 5 Select the **Settings** tab.
- 6 Click the display you want to change (1 or 2): display colours or resolution.
- 7 Select an option from the **Color quality** list to change colours.
- 8 Use the slider in the **Screen resolution** to adjust the resolution.
- 9 Click **Apply** and then **OK**.

Customizing the virtual desktop

You can customize the Dual Display mode by changing the position of the two monitors comprising the virtual desktop.

To customize Dual Display mode, proceed as follows:

- 1 Click the **Start** button on the **Windows** taskbar.
- 2 Click **Control Panel**.
- 3 Click **Appearance and Themes**.
- 4 Click the **Display** icon.
- 5 Click the **Settings** tab.
- 6 Drag the monitor icons to match the physical arrangement of your monitors. The two monitor icons must be connected to create a virtual desktop.
- 7 Click **Apply** and then **OK**.

Deactivating the Dual Display function

To deactivate the Dual Display function, proceed as follows:

- 1 Click the **Start** button on the **Windows** taskbar.
- 2 Click **Control Panel**.
- 3 Click **Appearance and Themes**.
- 4 Click the **Display** icon.
- 5 Click the **Settings** tab.
- 6 Click the display 2.
- 7 Deselect the **Extend my Windows desktop onto this monitor** option.
This will disable the Dual Display.



For switching from Primary to Secondary display, see the section **Selecting display modes (PCG-Z1, PCG-V505 series)** ([page 85](#)).

Connecting external speakers

You can enhance the sound quality of your computer by connecting external speakers.

To connect external speakers, proceed as follows:

- 1 Plug the speaker cable (1) into the headphone connector (2).
- 2 Plug the other end of the speaker cable into the external speaker (3).
- 3 Turn down the volume of the speakers before you turn them on.

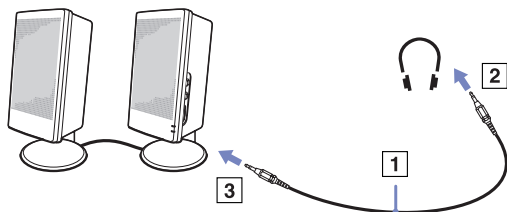

 Make sure your speakers are designed for computer use.

Do not place floppy disks on the speakers; their magnetic field may damage the data on the disks.

Troubleshooting sound

My speakers are not producing sound

- If you use external speakers, check that the speakers are properly connected and the volume is turned up. If the speakers have a mute button, make sure it is off. If batteries power the speakers, check that the batteries are inserted properly and that they are charged.
- If you have connected an audio cable to the headphone connector, disconnect the cable.

Connecting an external microphone

If you need to use a sound input device, for example to chat on the Internet, you need to plug in an external microphone.

To connect an external microphone, proceed as follows:

Plug the microphone cable (1) into the microphone connector (2) identified by the  symbol.

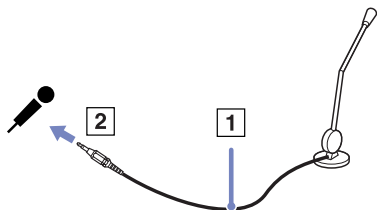

 Make sure your microphone is designed for computer use.

Troubleshooting sound

My microphone does not work

- If you are using an external microphone, check that the microphone is plugged into the microphone connector correctly.

Connecting a Universal Serial Bus (USB) device

You can connect a USB device (for example, a mouse, floppy disk drive, keyboard, printer) to your computer.

USB devices are hot plug and play devices. You do not need to shut down your computer prior to connecting these devices unless the manual supplied with the device states otherwise.

For some USB devices you need to install the software before you connect the device. Not following this procedure might cause the device not to work properly. For more information, check the manual provided with the USB device.

- ❑ Connecting a USB mouse ([page 94](#))
- ❑ Connecting a USB floppy disk drive ([page 95](#))

Connecting a USB mouse

To connect a USB mouse, proceed as follows:

- 1 Choose the USB connector (1) you prefer to use.
 - 2 Plug the USB mouse cable (2) into the USB connector.
- You can use your USB mouse (3).

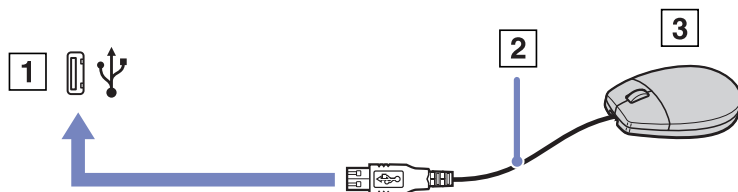

-  The VAIO USB mouse software driver is preinstalled on your computer, therefore, you only need to plug the USB mouse into the USB connector and you can start working.

Connecting a USB floppy disk drive

As an optional extra, you can purchase a USB floppy disk drive and connect it to your computer.

To connect a USB floppy disk drive, proceed as follows:

- 1 Choose the USB connector you prefer to use.
- 2 Plug the USB floppy disk drive cable into the USB connector. The VAIO logo on the disk drive should be facing up.
Your USB floppy disk drive is now ready for use.

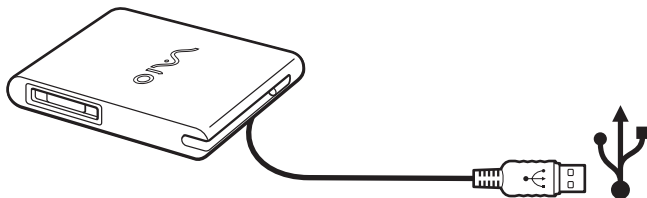

To remove a USB floppy disk drive, proceed as follows:

- ❑ If your computer is on, wait until the floppy drive LED indicator turns off and then unplug the USB cable. If the floppy disk drive is not removed properly, your system may crash and you may lose any unsaved data.
- ❑ If your computer is off, you can unplug the USB cable directly from the computer.

Inserting a floppy disk

To insert a floppy disk, proceed as follows:

- 1 Hold the disk (1) with the label side facing up.
- 2 Gently push the disk into the drive (2) until it clicks into place.

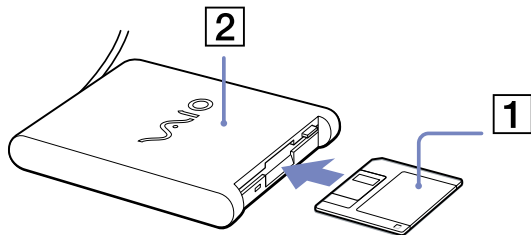

Removing a floppy disk

To remove a floppy disk, proceed as follows:

When you have finished using the floppy disk, wait until the LED indicator (1) turns off and then press the eject button (2) to remove the disk.

- 📌 Before pressing the eject button, make sure that the LED indicator is turned off.
If the disk does not come out by pressing the eject button, disconnect the floppy disk drive from the computer.

! Do not press the eject button while the LED indicator is on. It may damage the floppy disk.

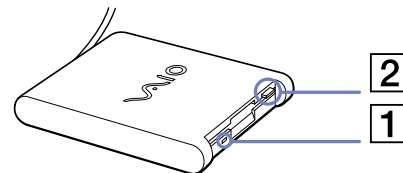

Troubleshooting floppy disks

My USB floppy disk drive cannot write to a floppy disk

- ❑ The floppy disk is write-protected. Disable the write-protect feature or use a floppy disk that is not write-protected.
- ❑ Check that the disk is properly inserted into the floppy disk drive.
- ❑ Your disk may be corrupt. Try to insert another floppy disk.

The optional PCGA-UFD5/A (USB) floppy disk drive is not recognised as drive A

To set the UFD5/A to A, proceed as follows :

- 1 Turn the system power on.
- 2 Connect the UFD5/A.
- 3 Select **Control Panel** from the **Start** menu.
- 4 Double-click **System**.
- 5 Select the **Hardware** tab, then click **Device Manager**.
- 6 Select **Universal Serial Bus controllers**, then **Y-E Data USB Floppy**.
- 7 From the **Action** menu, click **Uninstall**.
- 8 Keep clicking **OK** until the **Confirmation of deletion of device** message appears.
- 9 Select **Scan for hardware changes** from the **Action** menu.
The UFD5/A is recognised as drive A.

Connecting a printer

You can connect a Windows-compatible printer to your computer to print documents.

Connecting a printer using the USB connector

You can connect a USB printer compatible with your version of Windows to your computer.

To connect a printer using the USB connector, proceed as follows:

- 1 Plug a USB printer cable (1) into one of the USB connectors (2) on your computer. A USB connector is identified by the  symbol on your computer and printer.
- 2 Plug the printer power cord into an AC outlet (3).

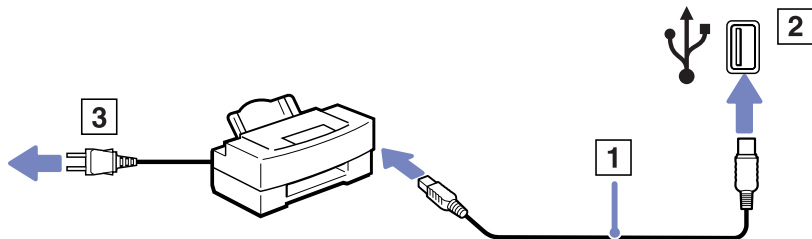

Connecting a printer using the printer connector

To connect a printer using the printer connector, proceed as follows:

- 1 Plug the printer cable (1) supplied with the printer into the printer connector (2) identified by the  symbol.
- 2 Plug the printer power cord (3) into an AC outlet.

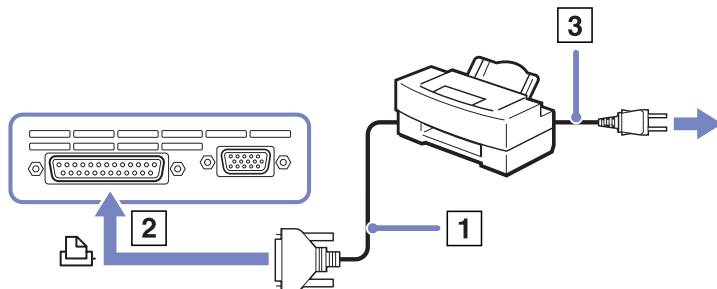

-  Turn off your computer and the printer, unplug the AC adapter and the power cord before connecting the printer.

Connecting an i.LINK device

Your computer includes an i.LINK (IEEE1394) connector, which you can use to connect to an i.LINK device such as a digital video camera recorder or to connect two VAIO notebooks in order to copy, delete or edit files.

The i.LINK connector of your computer does not supply power to external devices generally powered by i.LINK connectors.

The i.LINK connector supports transfer rates up to 400 Mbps; however, the actual transfer rate depends on the transfer rate of the external device.

The i.LINK features available may vary depending on the software applications you use. Refer to the documentation that came with your software for more information.

i.LINK cables compatible with your VAIO computer include cables with the following part numbers: VMC-IL4415A (a 1.5 meter cable with a 4-pin connector at each end), VMC-IL4408Series (a 0.8 meter cable with a 4-pin connector at each end).

- ❑ [Connecting a digital video camera recorder \(page 101\)](#)
- ❑ [Connecting two VAIO notebooks \(page 101\)](#)

 An i.LINK connection with other compatible devices is not fully guaranteed.

The i.LINK connection varies depending on the software applications, operating system and i.LINK compatible devices you use. Refer to the documentation that came with your software for more information.

Check the working conditions and OS compatibility of i.LINK-compatible PC peripherals (HDD, CD-RW drive etc.) before you connect them to your computer.

Connecting a digital video camera recorder

To connect a digital video camera recorder, proceed as follows:

- 1 Plug one end of the i.LINK cable (1) into the i.LINK connector (2) of the computer and the other end into the DV Out connector (3) on the digital video camera recorder.
- 2 Launch the DVgate application.

 On Sony digital video cameras, connectors labelled **DV Out**, **DV In/Out** or **i.LINK** are i.LINK-compatible.

The Sony digital video camera recorder is an example; your digital video camera recorder may need to be connected differently.

If your digital video camera recorder includes a Memory Stick slot, you can copy images from it to your computer via a Memory Stick. To do so, simply copy images on the Memory Stick, then use a special PC Card adapter to insert it into your computer.

You cannot access the pictures stored on a Memory Stick when using an i.LINK connection.

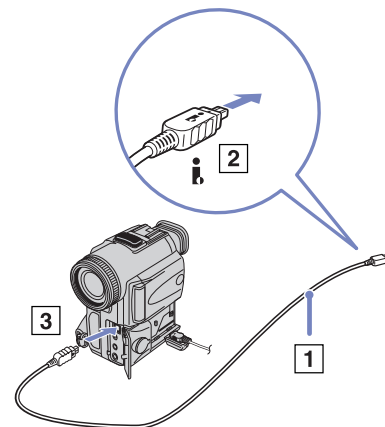

Connecting two VAIO notebooks

You can copy, edit or delete files on another VAIO computer to your computer with an optional i.LINK cable.

You can also print a document on a printer connected to another VAIO computer.

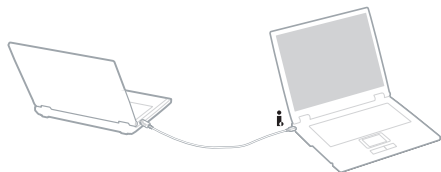

Troubleshooting i.LINK devices

I cannot establish an i.LINK connection between two VAIO computers

- ❑ You must have administrator rights on your computer to be able to link the two.
- ❑ Disconnect then reconnect the i.LINK cable.
- ❑ If you still have no connection after waiting for a while, restart both computers.
- ❑ If either computer has just returned from a power saving mode, the connection may be affected. In this case, make sure you perform a full restart before connecting them.

When I record images to a digital video device using DVgate, I see an error message

- ❑ Close all open applications and restart your computer. Frequent recording of images to a digital video device while using **DVgate** sometimes causes this error.
- ❑ Your DV device will need to have DV In/Out in order to be able to transfer your files to the DV device.
- ❑ Check that both units are in the same workgroup, and that the **Sharing** option is enabled.

I cannot use digital devices

- ❑ Check that the DV device is turned on and that the cables are properly connected.
- ❑ If you are using multiple i.LINK devices, the combination of the connected devices may cause unstable operation. If this is the case, turn off all connected devices and disconnect unused devices. Check the connection and then turn on the power again.
- ❑ You are strongly advised to use only Sony i.LINK cables, as using other brands may cause problems with the i.LINK devices.

Connecting to a network (LAN)

You can connect your computer to 10BASE-T/100BASE-TX-type networks via an Ethernet network cable. For the detailed settings and devices needed to connect to the network, consult your Network Administrator.

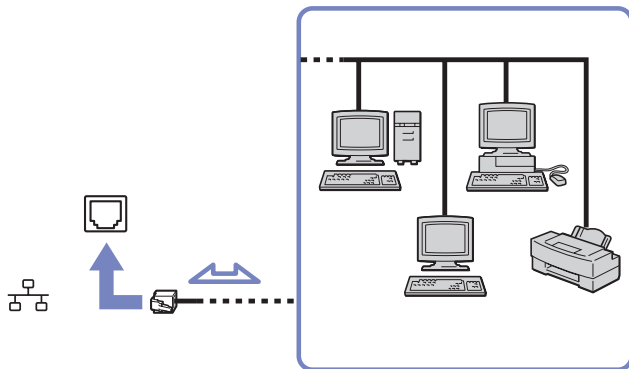

 The default settings make your computer able to connect to the network.

If the main unit is docked, you can only use the Ethernet network connector on the port replicator (depending on your model).

For more information about connecting your computer to the network, please consult the Hardware troubleshooting section of the VAIO-Link website:

! Do not plug a phone cable into your computer network connector.

Upgrading your VAIO computer

Your computer and memory modules use high precision components and electronic connectors technology. To avoid the invalidation of your guarantee by mishandling, it is recommended that:

- ❑ You contact your dealer to install a new memory module.
- ❑ You do not install it yourself, if you are not familiar with upgrading memory on a computer.
- ❑ You do not touch the connectors or open the memory panel.

Please contact VAIO-Link if you need assistance.

*Adding and removing memory**

In the future you may want to change or add memory modules in order to expand the functionality of your computer. You can increase the memory by installing optional memory modules.

Be careful when changing memory. Mistakes on installation or removal of the memory module may cause a malfunction.

For memory upgrades, use only **DDR266**, **DDR333** DDR-SDRAM SO-DIMM or **DDR266** DDR-SDRAM Micro-DIMM* (gold leaf contacts).

Electrostatic discharge can damage electronic components. Before touching a memory expansion board, ensure the following:

- ❑ Handle the memory module gently.
- ❑ The procedures described in this document assume familiarity with the general terminology associated with personal computers and with the safety practices and regulatory compliance required for using and modifying electronic equipment.
- ❑ Disconnect the system from its power source (that is, battery or AC adapter) and from any telecommunication links, networks, or modems before you open the system. Failure to do so may result in personal injury or equipment damage.

* Depending on your model. Read the printed **Specifications** document for more information.

- ❑ Electrostatic Discharge (ESD) can damage memory modules and other components. Install the memory Module only at an ESD workstation. If such a station is not available, do not work in a carpeted area, and do not handle materials that produce or hold static electricity (cellophane wrappers, for example). Ground yourself by maintaining contact with an unpainted metal portion of the chassis while performing the procedure.
- ❑ Do not open the memory module package until you are ready to change the module. The package protects the module from ESD.
- ! Use the special bag delivered with the memory module or wrap the module in aluminium foil to protect it from electrostatic discharge. Introducing any liquids or any foreign substances or objects into the memory slots, or other internal components of the computer, will result in damage to the computer and any repairs will be out of warranty.
- ! Do not place the memory module in places subject to:
 - Heat sources such as radiators or air ducts,
 - Direct sunlight,
 - Excessive dust,
 - Mechanical vibration or shock,
 - Strong magnets or speakers that are not magnetically shielded,
 - Ambient temperature of more than +35°C or less than +5°C,
 - High humidity.

* Depending on the configuration of your computer, the number of available slots can vary.

Removing and installing a memory module (PCG-TR series)

To change or add a memory module, proceed as follows:

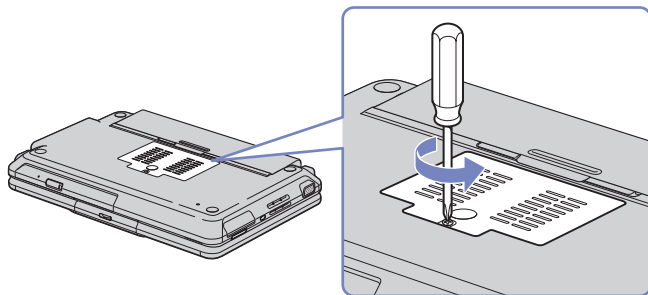

- 1 Shut down your computer and disconnect all peripheral devices.
- 2 Unplug the computer and remove the battery pack.
- 3 Wait until the computer cools down.
- 4 Unscrew the central screw at the bottom of your computer.
- 5 Touch a metal object (such as the connector panel on the back of your computer) to discharge static electricity.
- 6 Remove the memory module:
 - Pull the tabs in the direction of the arrows. The memory module is released.
 - Pull the memory module in the direction of the arrow.

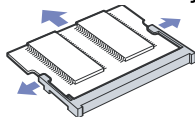

- 7 Remove the new memory module from its packaging.

- 8 Install the memory module. Be careful not to touch the other components on the motherboard.
 - ❑ Slide the memory module into the slot.
 - ❑ Snap the connectors into place when the board is correctly seated.

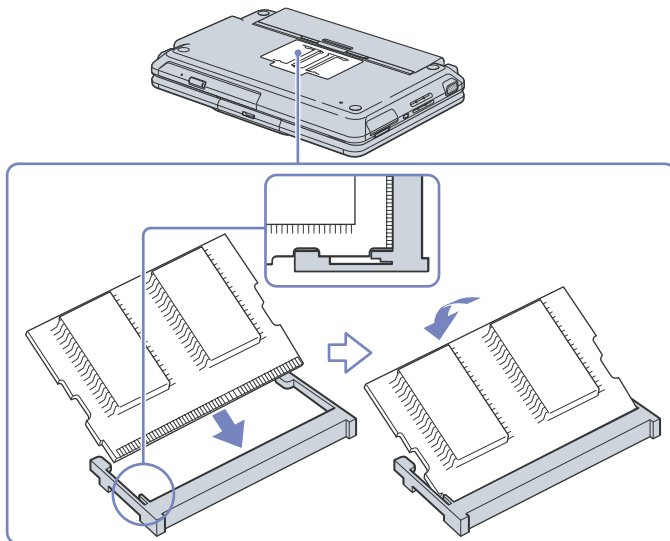

- 9 Close the module cover, then tighten the screw on the bottom of the computer.
- 10 Reinsert the battery and turn the computer on.

Removing and installing a memory module (Z1 series)

To change or add a memory module, proceed as follows:

- 1 Shut down your computer and disconnect all peripheral devices.
- 2 Unplug the computer and remove the battery pack.
- 3 Wait until the computer cools down.
- 4 Unscrew the two screws at the bottom of your computer, next to the release lever of the battery pack.

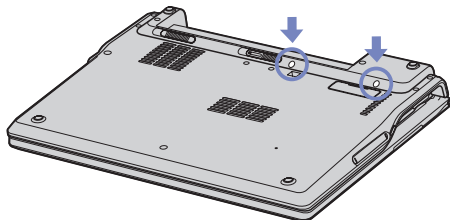

- 5 Turn your computer around and lift the cover.
- 6 Introduce a sharp object (such as a fine screwdriver) between the keys indicated on the picture (1) and push gently upwards.

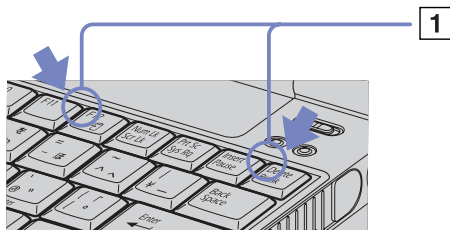



- 7 Lift the keyboard from the LCD display side and gently turn it over the touchpad. Be careful not to detach the cable (1) when lifting the keyboard.
- 8 Touch a metal object (such as the connector panel on the back of your computer) to discharge static electricity.
- 9 Remove the memory module:
 - Pull the tabs in the direction of the arrows. The memory module is released.

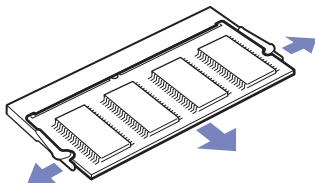

- Pull the memory module in the direction of the arrow.
- 10 Remove the new memory module from its packaging.
 - 11 Install the memory module. Be careful not to touch the other components on the motherboard.
 - Slide the memory module into the slot.

- Snap the connectors into place when the board is correctly seated.

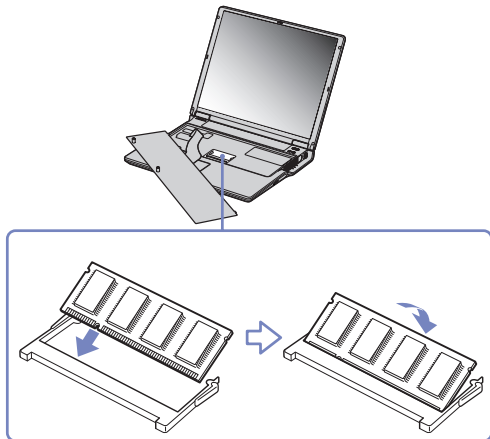

- 12 Gently replace the keyboard, then press it into your computer.



- 13 Close the computer cover, then tighten the screws on the bottom of the computer.
14 Reinsert the battery and turn the computer on.

Removing and installing a memory module (V505 series)

To change or add a memory module, proceed as follows:

- 1 Shut down your computer and disconnect all peripheral devices.
- 2 Unplug the computer and remove the battery pack.
- 3 Wait until the computer cools down.
- 4 Unscrew the screw at the bottom of your computer.

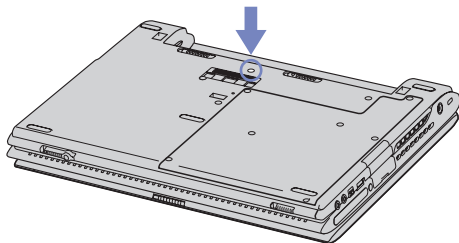

- 5 Slide the LCD lock lever and lift the cover.
- 6 Slide the keyboard toward the LCD display, then lift it away slightly.

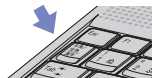

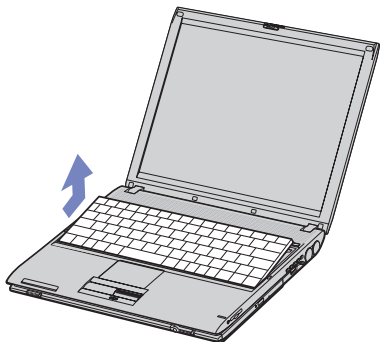

- 7 Lift the keyboard from the LCD display side and gently turn it over the touchpad. Be careful not to detach the cable (1) when lifting the keyboard.

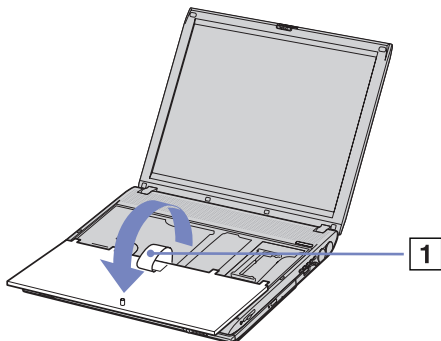

- 8 Touch a metal object (such as the connector panel on the back of your computer) to discharge static electricity.
- 9 Remove the memory module:

- ❑ Pull the tabs in the direction of the arrows. The memory module is released.
- ❑ Pull the memory module in the direction of the arrow.

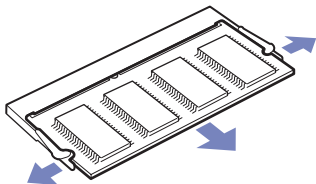

- 10 Remove the new memory module from its packaging.
- 11 Install the memory module. Be careful not to touch the other components on the motherboard.
 - ❑ Slide the memory module into the slot.
 - ❑ Snap the connectors into place when the board is correctly seated.

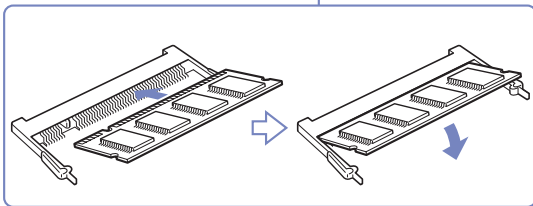
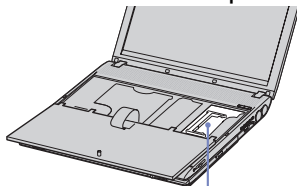

- 12 Gently replace the keyboard, then press it into your computer.

- 13 Close the computer cover, then tighten the screws on the bottom of the computer.
- 14 Reinsert the battery and turn the computer on.

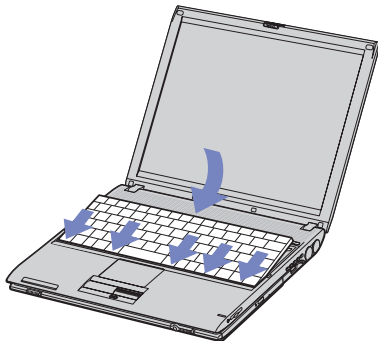

Viewing the amount of memory

To view the amount of memory, proceed as follows:

- 1 Turn on the computer.
- 2 Go to **Sony Notebook Setup** via the **Start** menu.
The **Sony Notebook Setup** dialog box appears.
- 3 In the **About this Computer** tab you can view the amount of system memory. If the additional memory does not appear, repeat the whole procedure and restart the computer.

Getting help

This section describes how to get help and support if something goes wrong with your computer. Sony offers you many support options for your computer.

Sony support options

Please see the section **Documentation pack (page 9)** for details on the printed and online documentation delivered with your computer, as well as further sources of reference.

Other sources of information

- ❑ Go to the **online help files** that accompany your software for instructions on using the software.
- ❑ **VAIO-Link website:** if you have any problem with your computer, you can access the VAIO-Link website for troubleshooting. Go to: <http://www.vaio-link.com>
- ❑ **e- Support:** This interactive part of our website <http://www.vaio-link.com> allows you to get in contact with our dedicated support team over the internet. Using a personalised account, you can log your technical queries with ease.
- ❑ **VAIO-Link help lines:** Before contacting VAIO-Link by telephone, try to solve the problem by reading the online and printed documentation.
- ❑ Visit the other Sony websites:
 - ❑ www.club-vaio.com if you want to know more about VAIO and become part of the growing VAIO community.
 - ❑ www.sonymstyle-europe.com for online purchases.
 - ❑ www.sony.net for other Sony products.

 You need to set up an Internet connection before you can access the online features described here.

e-Support

What is e-Support?

You have searched our user guides and website (www.vaio-link.com) but have not found an answer to your question/issue? e-Support is the ideal solution for you!

Our e-Support Web Portal is an interactive website on which you can submit any technical query you may have regarding your VAIO and receive answers from our dedicated support team.

Every submitted query will result in a unique 'case number' to ensure smooth communication between yourself and the e-Support Team.

Who can use e-Support?

All registered VAIO customers are entitled to unlimited access to the VAIO-Link e-Support Web Portal.

How can I access the e-Support portal?

When you register your VAIO computer online at Club-VAIO (www.club-vaio.com), you will automatically receive an email with the link to the e-Support Web Portal, your Customer ID and some basic explanation a few hours later.

All you need to do is activate your account by clicking on the provided link in the email.

You are now ready to create your first case!

You can access the e-Support Web Portal from any computer with an active Internet connection.

A complete help file is available on the e-Support Web Portal to help you use our e-Support Service.

Can I submit questions in my native language?

Since you are interacting with our e-Support Team through a portal, which connects you directly to our central database, e-Support will only accept and deal with queries submitted in English.

Can I submit my questions at any time?

Yes, you can submit your questions 24/7, but please keep in mind that our e-Support Team can only treat your queries from Monday till Friday between 8am and 6pm.

Is there a cost involved for using e-Support?

No, this is a complete free of charge service offered to all registered VAIO customers!

How do I know when the e-Support Team has handled my query/case?

As soon as your case has been dealt with by our e-Support Team, you will receive an email, notifying you that your case has been updated.

Precautions

This section describes safety guidelines and precautions to help you protect your computer from potential damage.

Please contact VAIO-Link if you need assistance.

- ❑ On handling the hard disk ([page 120](#))
- ❑ On handling the LCD screen ([page 120](#))
- ❑ On using the power source ([page 121](#))
- ❑ On handling your computer ([page 121](#))
- ❑ On handling floppy disks ([page 123](#))
- ❑ On handling discs ([page 123](#))
- ❑ On using the battery pack ([page 124](#))
- ❑ On using headphones ([page 125](#))
- ❑ On handling Memory Sticks ([page 125](#))

On handling the hard disk

The hard disk has a high storage density and reads or writes data in a short time. However, it can be easily damaged by mechanical vibration, shock or dust.

Although the hard disk has the internal safety device to prevent losing data due to mechanical vibration, shock or dust, you should be careful when handling your computer.

To avoid damaging your hard disk:

- ❑ Do not subject your computer to sudden movements.
- ❑ Keep the computer away from magnets.
- ❑ Do not place your computer in a location subject to mechanical vibration or in an unstable position.
- ❑ Do not move your computer while the power is on.
- ❑ Do not turn off the power or restart the computer while reading or writing data to disk.
- ❑ Do not use your computer in a place subject to extreme changes in temperature.
- ❑ Do not move your computer while the system is in **Standby** mode.

 If the hard disk is damaged, the data cannot be restored.

On handling the LCD screen

- ❑ Do not leave the LCD facing the sun as it can damage the LCD. Be careful when using the computer near a window.
- ❑ Do not scratch the LCD or exert pressure on it. This could cause malfunction.
- ❑ Using the computer in low temperature conditions may produce a residual image on the screen. This is not a malfunction. When the computer returns to normal temperature, the screen returns to normal.
- ❑ A residual image may appear on the screen if the same image is displayed for a lengthy period of time. The residual image disappears in a while. You can use a screensaver to prevent residual images.
- ❑ The screen becomes warm during operation. This is normal and does not indicate a malfunction.

- ❑ The LCD is manufactured using high-precision technology. You may, however, see tiny black points and/or bright points (red, blue, or green) that continuously appear on the LCD. This is a normal result of the manufacturing process and does not indicate a malfunction.
- ❑ Avoid rubbing the LCD screen, as this can damage the screen. Use a soft, dry cloth to wipe the LCD screen.

On using the power source

- ❑ See the printed **Specifications** sheet to check the power operation of your VAIO.
- ❑ Do not share the AC outlet with other power-consuming equipment, such as a photocopier or shredder.
- ❑ You can purchase a power strip with a surge protector. This device prevents damage to your computer caused by sudden power surges, in an electrical storm, for example.
- ❑ Do not place heavy objects on the power cord.
- ❑ To disconnect the cord, pull it out by the plug. Never pull the cord itself.
- ❑ Unplug your computer from the wall outlet if you are planning to not use the computer for a long time.
- ❑ Make sure that the socket outlet is easily accessible.
- ❑ When the AC adapter is not used, unplug it from the AC outlet.
- ❑ Use only the supplied AC adapter. Do not use any other AC adapter.

On handling your computer

- ❑ Clean the cabinet with a soft cloth, which is either dry or lightly moistened with a mild detergent solution. Do not use any type of abrasive pad, scouring powder, or solvent such as alcohol or benzine, as these may damage the finish of your computer.
- ❑ Should you drop a solid object or any liquid onto the computer, shut down your computer and then unplug it. You may want to have the computer checked by qualified personnel before operating it again.
- ❑ Do not drop the computer or place heavy objects on top of the computer.

- ❑ Do not place your computer in a location subject to:
 - ❑ Heat sources, such as radiators or air ducts,
 - ❑ Direct sunlight,
 - ❑ Excessive dust,
 - ❑ Moisture or rain,
 - ❑ Mechanical vibration or shock,
 - ❑ Strong magnets or speakers that are not magnetically shielded,
 - ❑ Ambient temperature of more than 35°C or less than 5°C,
 - ❑ High humidity.
- ❑ Do not place electronic equipment near your computer. The electromagnetic field of your computer may cause a malfunction.
- ❑ Provide adequate air circulation to prevent internal heat from building up. Do not place your computer on porous surfaces such as rugs or blankets, or near material such as curtains or draperies that may block its ventilation slots.
- ❑ The computer uses high-frequency radio signals and may cause interference to radio or TV reception. Should this occur, relocate the computer a suitable distance away from the set.
- ❑ Use only specified peripheral equipment and interface cables; otherwise, problems may occur.
- ❑ Do not use cut or damaged connection cables.
- ❑ If the computer is brought directly from a cold location to a warm one, moisture may condense inside your computer. In this case, allow at least one hour before turning on your computer. If any problems occur, unplug your computer and contact VAIO-Link.
- ❑ Make sure you disconnect the power cord before cleaning the computer.
- ❑ As you may lose important data once your computer is damaged, you should back up your data regularly. You can restore most of the original application programs from the supplied disc (read the **Troubleshooting Guide** for details).

On handling floppy disks

- ❑ Do not open the shutter manually or touch the surface of the floppy disk.
- ❑ Keep floppy disks away from magnets.
- ❑ Keep floppy disks away from direct sunlight and other sources of heat.

On handling discs

- ❑ Do not touch the surface of the disc.
- ❑ Do not drop or bend the disc.
- ❑ Fingerprints and dust on the surface of a disc may cause read errors. Always hold the disc by its edges and central hole, as shown:

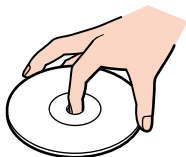

- ❑ Proper care of the disc is essential to its continuous reliability. Do not use solvents such as benzene, thinning agents, commercially available cleaners or anti-static spray, as they may cause damage to the disc.
- ❑ For normal cleaning, hold the disc by its edge and use a soft cloth to wipe the surface from the centre out.
- ❑ If the disc is badly soiled, moisten a soft cloth with water, wring it out well, and use it to wipe the surface of the disc from the centre out. Wipe off any remaining moisture with a dry soft cloth.
- ❑ Never put stickers on discs. This will affect the use of the disc irreparably.

On using the battery pack

- ❑ Never leave the battery pack in temperatures above 60°C, such as in a car parked in the sun or under direct sunlight.
- ❑ Battery life is shorter in a cold environment. This is due to decreased battery efficiency at low temperatures.
- ❑ Charge the batteries at temperatures between 10°C to 30°C. Lower temperatures require a longer charging time.
- ❑ While the battery is in use or being discharged, the battery pack heats up. This is normal and is not cause for concern.
- ❑ Keep the battery pack away from all sources of heat.
- ❑ Keep the battery pack dry.
- ❑ Do not open or try to disassemble the battery pack.
- ❑ Do not expose the battery pack to any mechanical shock.
- ❑ If you are not using the computer for an extended period of time, remove the battery pack from the computer to prevent damage to the battery.
- ❑ If, after fully charging the battery pack, the battery power is still low, the battery pack may be reaching the end of its life and should be replaced.
- ❑ You do not need to discharge the battery before recharging.
- ❑ If you have not used the battery pack for a considerable amount of time, recharge the battery.

On using headphones

- ❑ **Road safety** – Do not use headphones while driving, cycling, or operating any motorized vehicle. It may create a traffic hazard and is illegal in some areas. It can also be potentially dangerous to play loud music while walking, especially at pedestrian crossings.
- ❑ **Preventing hearing damage** – Avoid using headphones at high volume. Hearing experts advise against continuous, loud and extended play. If you experience a ringing in your ears, reduce the volume or discontinue use.

On handling Memory Sticks

- ❑ Do not touch the Memory Stick connector with your finger or metallic objects.
- ❑ Use only the label supplied with the Memory Stick as a label.
- ❑ Do not bend, drop, or apply strong shock to the Memory Stick.
- ❑ Do not disassemble or modify Memory Sticks.
- ❑ Do not let Memory Sticks get wet.
- ❑ Do not use or store Memory Sticks in a location subject to:
 - ❑ Extremely high temperatures, such as in a car parked in the sun,
 - ❑ Direct sunlight,
 - ❑ High humidity or,
 - ❑ Corrosive substances.
- ❑ Use the storage case supplied with the Memory Stick.

Trademarks

Sony, BlueSpace NE, Click to DVD, DVgate Plus, Giga Pocket, HotKey Utility, Memory Stick Formatter, PictureGear Studio, SonicStage, Sony Notebook Setup, UI Design Selector, VAIO Action Setup, VAIO Edit Components, VAIO Media, VAIO Power Management, VAIO System Information, Memory Stick, the Memory Stick logo, VAIO and the VAIO logo are trademarks of Sony Corporation.

Microsoft, Internet Explorer, Windows Movie Maker, Windows Media Player, Windows XP Professional, Windows Home Edition, Microsoft Works and the Windows logo are trademarks or registered trademarks of Microsoft Corporation in the U.S. and other countries.

i.LINK is a trademark of Sony used only to designate that a product contains an IEEE1394 connection.

Adobe, Adobe Acrobat Elements, Adobe Photoshop Album, Adobe Reader, Adobe Premiere and Adobe Photoshop Elements are trademarks of Adobe Systems Incorporated.

QuickTime and the QuickTime logo are trademarks used under licence. QuickTime is registered in the U.S. and other countries.

RealOne Player is a trademark or registered trademark of RealNetworks, Inc. in the U.S. and other countries.

MoodLogic is a trademark of MoodLogic, Inc.

PowerPanel is a trademark of Phoenix Technologies Ltd.

Norton Internet Security 2004 and Norton Password Manager are trademarks or registered trademarks of Symantec Corporation.

Drag'n Drop CD+DVD is a registered trademark of Easy Systems Japan Ltd and DigiOn Inc.

WinDVD for VAIO is a trademark of InterVideo, Inc.

Sun Java VM is a trademark of Sun Microsystems, Inc.

All other names of systems, products and services are trademarks of their respective owners. In the manual, the ™ or ® marks are not specified.

Specifications are subject to change without notice. All other trademarks are trademarks of their respective owners.

Please see the printed Specifications sheet to see what software is available for your model.