

# ***Sony Notebook User Guide***

**PCG-SR31K/PCG-SR31LK**

The WAVIO logo is rendered in a blue, stylized font. The 'W' is formed by a continuous wavy line. The 'A' is a solid blue circle. The 'I' is a vertical bar with a pointed top. The 'O' is a solid blue circle.

## Read this first

### Notice

© 2001 Sony Corporation. All rights reserved.

This manual and the software described herein, in whole or in part, may not be reproduced, translated, or reduced to any machine-readable form without prior written approval.

Sony Corporation provides no warranty with regard to this manual, the software, or other information contained herein and hereby expressly disclaims any implied warranties or merchantability or fitness for any particular purpose with regard to this manual, the software or such other information. In no event shall Sony Corporation be liable for any incidental, consequential, or special damages, whether based on tort, contract, or otherwise, arising out of or in connection with this manual, the software, or other information contained herein or the use thereof.

Sony Corporation reserves the right to make any modification to this manual or the information contained herein at any time without notice. The software described herein is governed by the terms of a separate user license agreement.

Sony, DVgate, i.LINK™ and the i.LINK logo, JogDial™, PictureGear, Memory Stick and the Memory Stick logo, VAIO and the VAIO logo are trademarks of Sony Corporation. i.LINK™ is the name for the IEEE 1394-1995 standards and their revisions.

Microsoft, Windows and the Windows logo, Windows Media and Outlook are trademarks or registered trademarks of U.S. Microsoft Corporation in the U.S. and other countries.

Adobe®, Adobe® Acrobat® Reader, Adobe® Premiere® are trademarks of Adobe Systems Incorporated.

QuickTime and the QuickTime logo are trademarks used under license. QuickTime is registered in the U.S. and other countries.

RealPlayer is a trademark or registered trademark of RealNetworks, inc. in the U.S. and other countries.

PowerPanel is a trademark of U.S. Phoenix Technologies Corporation.

VirusScan is a trademark of Network Associates Corporation.

All other names of systems, products and services are trademarks of their respective owners. In the manual, the ™ or ® marks are not specified.

Specifications are subject to change without notice.

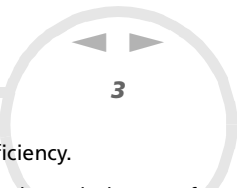

As an ENERGY STAR Partner, Sony has determined that this product meets the ENERGY STAR guidelines for energy efficiency.

The International ENERGY STAR Office Equipment Program is an international program that promotes energy saving through the use of computers and their office equipment. The program backs the development and dissemination of products with functions that effectively reduce energy consumption. It is an open system in which business proprietors can participate voluntarily. The targeted products are office equipment such as computers, displays, printers, facsimiles and copiers. Their standards and logos are uniform among participating nations.

ENERGY STAR is a U.S. registered mark.





## *Safety information*

### *Owner's record*

The model number and serial number are located on the bottom of your Sony notebook. Record the serial number in the space provided here. Refer to the model and serial number when you call VAIO-Link.

Serial number: \_\_\_\_\_

Model number:

**PCG-431M/PCG-433M**

## Warnings

### General

- ❑ Opening the unit, for whatever reason, could lead to damages that are not covered by the guarantee.
- ❑ To avoid electrical shock, do not open the cabinet. Refer servicing to qualified personnel only.
- ❑ To prevent fire or shock hazard, do not expose your VAIO notebook to rain or moisture.
- ❑ Avoid using the modem during a storm.
- ❑ Do not use the modem or a telephone to report a gas leak in the vicinity of the leak.
- ❑ To change the backup battery, please contact your nearest SONY Service Center.

### Audio/video

- ❑ Audio and picture distortion may occur if this equipment is positioned in close proximity to any equipment emitting electromagnetic radiation.

### Connectivity

- ❑ Never install modem or telephone wiring during a storm.
- ❑ Never install telephone jacks in wet locations unless the jack is specifically designed for wet locations.
- ❑ Use caution when installing or modifying telephone lines.
- ❑ Use your notebook only with the supplied AC adapter. To disconnect your notebook completely from mains voltage, unplug the AC adapter.
- ❑ Please make sure that the socket outlet is easily accessible.
- ❑ Never touch uninsulated telephone wire or terminals unless the telephone line has been disconnected at the network interface.

### *CD-ROM*

- ❑ The use of the optical instruments supplied with your notebook will cause eye hazard. As the laser beam used in this product is harmful to eyes, do not attempt any disassembling process. For servicing, refer to qualified personnel only.

### *Hard disk drive*

The magnetic properties of some objects can have serious consequences for your hard disk drive. They can erase the data on the hard drive and cause the computer to malfunction. Do not place your computer near or on any products which emit magnetic fields, mainly:

- ❑ TV sets,
- ❑ Speakers,
- ❑ Magnets,
- ❑ magnetic bracelets.



## Regulatory information

This product conforms to the following European Directives:

73/23/EEC (Low Voltage Directive)

89/336/EEC, 92/31/EEC (EMC Directives)

93/68/EEC (CE Marking Directive)

1999/5/EC (radio equipment and telecommunications terminal equipment Directive)

This product complies with EN 55022 Class B and EN 55024 for use in following areas: residential, commercial and light-industrial.

This product has been tested and found compliant with the limits set out in the EMC Directive for using connection cables shorter than 3 metres (9.8 feet).

The optical disc drive is classified as a CLASS 1 LASER PRODUCT and complies with the Laser Product Safety Standard EN 60825-1. Repair and maintenance only by authorized Sony technicians. Improper repairs and use can create safety hazards.



## *Disposing of lithium ion batteries*

Do not handle damaged or leaking lithium ion batteries. Dispose of promptly and properly at end-of-life.

Danger of explosion if the battery is incorrectly replaced. Replace only with the same or equivalent type recommended by the manufacturer. Discard used batteries according to the manufacturer's instructions.

The battery pack used in this device may present a fire or chemical burn hazard if mistreated. Do not disassemble, heat above 60°C (140°F) or incinerate.

Keep away from children.

Your notebook is equipped with an internal backup memory battery. For changing this battery, please contact VAIO-Link:

<http://www.vaio-link.com>

In some areas the disposal of lithium ion batteries in household or business waste may be prohibited.

Use the public collection system.



## Welcome

Congratulations on purchasing a Sony VAIO notebook. Sony has combined leading-edge technology in audio, video, computing and communications to provide you with state-of-the-art personal computing.

Here are just some of the features your VAIO notebook has to offer.

- ❑ **Exceptional performance** - Your PC includes a fast processor, a fast CD-ROM drive and an internal modem.
- ❑ **Portability** - The rechargeable battery pack provides hours of use without AC power.
- ❑ **Sony audio and video quality** - A high-resolution LCD screen enables you to take advantage of today's advanced multimedia applications, games, and entertainment software.
- ❑ **Multimedia features** – Enjoy the speakers to listen to audio and video CDs.
- ❑ **Interconnectivity** – Your computer has Memory Stick™ and i.LINK™ functionalities. Memory Stick is Sony's new universal storage medium. i.LINK is a bidirectional digital interface for exchanging data.
- ❑ **Windows®** - Your system includes the latest operating system from Microsoft.
- ❑ **Communications** - Access popular online services, send and receive e-mails, browse the Internet...
- ❑ **Excellent customer support** - If you are experiencing any problems with your computer, please check the VAIO-Link website for a possible solution:  
<http://www.vaio-link.com>
- ❑ Before contacting VAIO-Link, you may try to solve the problem by reading the User Guide or the manuals and help files for the peripherals or software.

## Documentation pack

Your Documentation Pack contains paper and online user guides on a Documentation CD-ROM.

### Printed documentation

- ❑ A **Getting Started** brochure, where you find a brief description of the items in your box and some specifications of your notebook. This also offers a quick guide to setting up your computer;
- ❑ A **Customer Guide**, where you find all the basic information to start using your notebook;
- ❑ Your **Sony Guarantee conditions**;
- ❑ A **Safety Regulations Guide** for your information.

### Online documentation

- 1 The Sony Notebook User Guide:
  - ❑ **Using Your Sony Notebook** shows you how to use the standard components of your system.
  - ❑ **Connecting Peripheral Devices** explains how you can add functionality by connecting various peripherals.
  - ❑ **Getting Help** explains the support options available to you, and offers basic troubleshooting tips.
  - ❑ **Precautions** provides facts and advice about using your notebook.
  - ❑ **Specifications** provides details on your computer, drivers and accessories.

- 2 Refer to your **Software Guide** for information on the bundled software and the Sony applications.
  - ❑ **About the Software** is a short description of the features of the software pre-installed on your system.
  - ❑ **Customizing your notebook** explains how to set your system and power management.
  - ❑ **Using the Product Recovery CD-ROMs** explains how to perform a system and application recovery.
- 3 Consult the **Online Help** files of the software you are using for detailed information on features and troubleshooting.
- 4 Refer to the Microsoft **Quick Start** manual for more information on Windows.

## Your notebook and its accessories

Remove the following hardware items from the box:

1

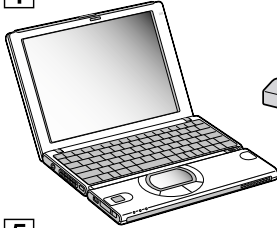

2

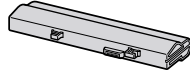

3

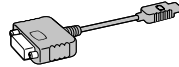

4

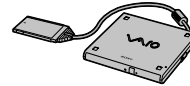

5



6



7

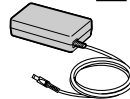

8



9



10



1	main unit	6	documentation pack
2	rechargeable battery pack	7	AC adapter
3	display adapter	8	power cord (country specific)
4	CD-ROM drive	9	phone plug (country specific)
5	product recovery CD-ROMs	10	phone cable

## Ergonomic considerations

- ❑ You will be using your notebook as a portable device in a variety of environments. Whenever possible, you should attempt to take account of the following ergonomic considerations to both stationary and portable environments:

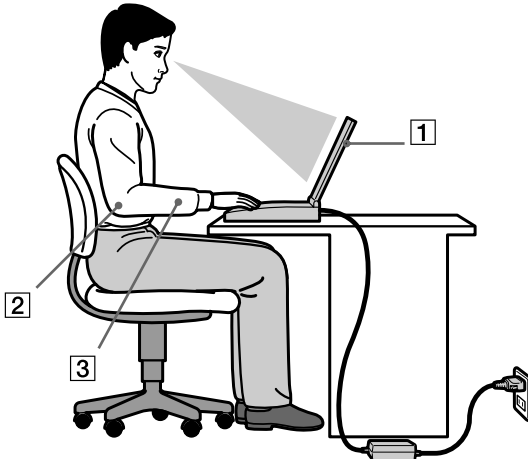

- ❑ **Position of your computer** – Place the computer directly in front of you (1). Keep your forearms horizontal (2), with your wrists in a neutral, comfortable position (3) while using the keyboard, touchpad, or external mouse. Let your upper arms hang naturally at your sides. Have breaks during sessions with your computer. Excessive use of the computer may strain muscles or tendons.
- ❑ **Furniture and posture** – Sit in a chair with good back support. Adjust the level of the chair so your feet are flat on the floor. A footrest may make you more comfortable. Sit in a relaxed, upright posture and avoid slouching forward or leaning far backwards.

- ❑ **Viewing angle of the computer's display** – Use the display's tilting feature to find the best position. You can reduce eye strain and muscle fatigue by adjusting the tilt of the display to the proper position. Adjust the brightness setting of the display as well.
- ❑ **Lighting** – Choose a location where windows and lights do not create glare and reflection on the display. Use indirect lighting to avoid bright spots on the display. You can also purchase accessories for your display that help reduce glare. Proper lighting adds to your comfort and work effectiveness.
- ❑ **Placement of an external display** – When using an external display, set the display at a comfortable viewing distance. Make sure the display screen is at eye level or slightly lower when you are sitting in front of the display.

## Using your notebook

This section describes how to start using your computer and how to use your computer's internal and external devices.

### Locating controls and connectors

#### Right

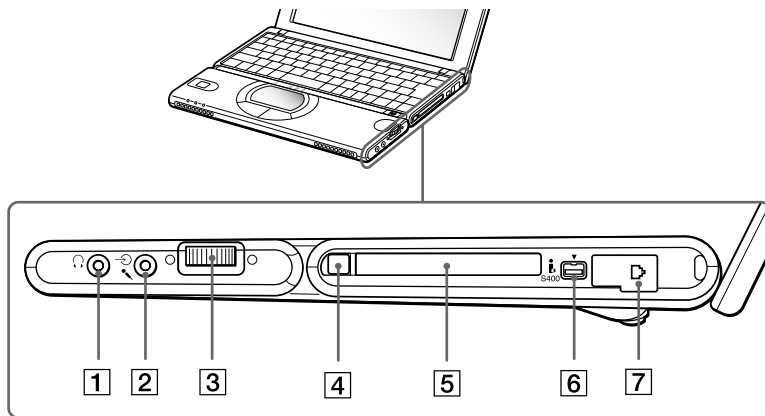

1	headphone connector	<a href="#">(page 53)</a>	5	PC Card slot	<a href="#">(page 37)</a>
2	line-in/microphone connector	<a href="#">(page 54)</a>	6	S400 i.LINK™ connector	<a href="#">(page 63)</a>
3	Jog Dial	<a href="#">(page 33)</a>	7	phone line jack	<a href="#">(page 46)</a>
4	PC Card eject button	<a href="#">(page 37)</a>			

## Left

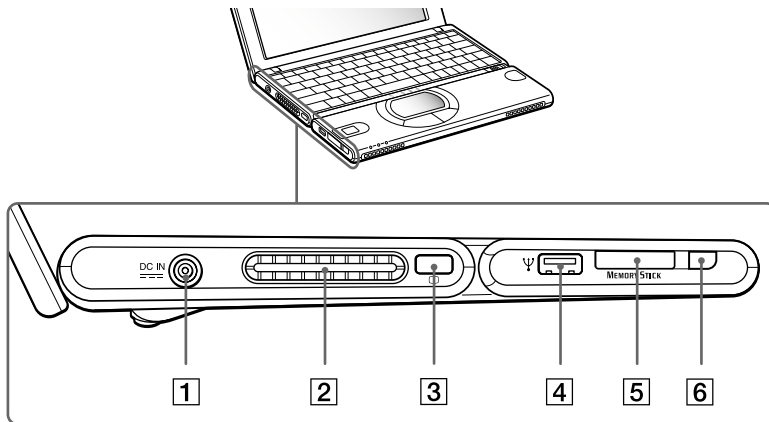

1	DC In	<a href="#">(page 19)</a>	4	USB connector	<a href="#">(page 55)</a>
2	ventilation slot		5	MagicGate Memory Stick™ slot	<a href="#">(page 41)</a>
3	monitor connector	<a href="#">(page 50)</a>	6	Memory Stick™ eject button	<a href="#">(page 41)</a>

 Phone cable and connectors are TNV (Telecommunications Network Voltage), according to EN60950.

AC adapter mains connector and power cord: hazardous voltage, according to EN 60950.

All other connectors for this notebook are SELV (Safety Extra Low Voltage), according to EN 60950.

Do not cover the ventilation slot when your computer is on.



## Front

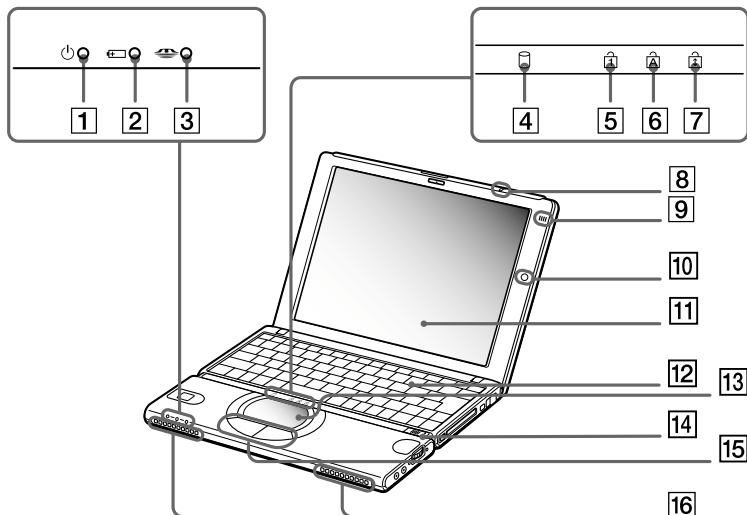

1	power indicator	<a href="#">(page 24)</a>	9	internal microphone	<a href="#">(page 54)</a>
2	battery indicator	<a href="#">(page 20)</a>	10	Bluetooth™ button*	<a href="#">(page 62)</a>
3	Memory Stick™ indicator		11	LCD screen	<a href="#">(page 31)</a>
4	hard disk drive indicator	<a href="#">(page 41)</a>	12	keyboard	<a href="#">(page 27)</a>
5	Num Lock indicator	<a href="#">(page 29)</a>	13	touchpad	<a href="#">(page 32)</a>
6	Caps Lock indicator	<a href="#">(page 29)</a>	14	power switch	<a href="#">(page 24)</a>
7	Scroll Lock indicator	<a href="#">(page 29)</a>	15	left/right buttons	<a href="#">(page 32)</a>
8	Bluetooth™ indicator*	<a href="#">(page 29)</a>	16	speakers	<a href="#">(page 31)</a>

\* Depending on the model and your country of residence.

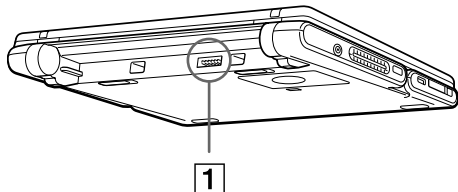
*Back*

1	battery connector	<a href="#">(page 20)</a>
---	-------------------	---------------------------

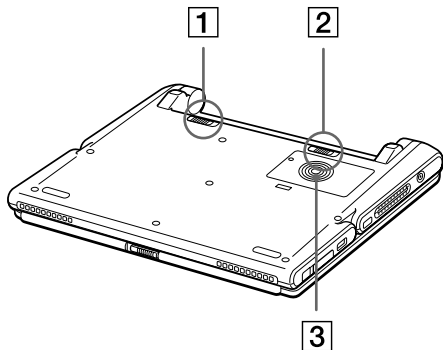
*Bottom*

1	battery lock lever	<a href="#">(page 20)</a>
2	battery release lever	<a href="#">(page 20)</a>
3	ventilation area	

## Connecting a power source

You can use either an AC adapter or a rechargeable battery pack as a power source.

### Using the AC adapter

To use the AC adapter, proceed as follows:

- 1 Plug the cable attached to the AC adapter (1) into the DC In connector (2) on the computer.
- 2 Plug one end of the power cord (3) into the AC adapter.
- 3 Plug the other end of the power cord into an AC outlet.

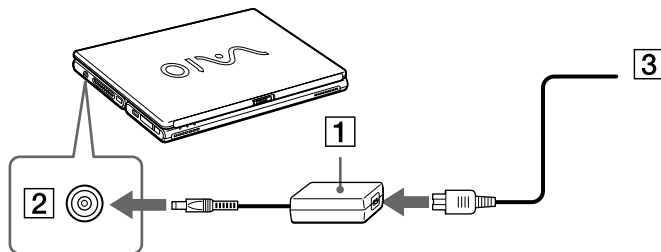

Use your notebook only with the supplied AC adapter.

To disconnect your notebook completely from mains voltage, unplug the AC adapter.

Make sure that the socket outlet is easily accessible.

## Using the battery pack

You can use a battery pack as a source of power. The battery pack supplied with your computer is not fully charged at the time of purchase.

### Inserting the battery pack

To insert the battery, proceed as follows:

- 1 Move the lock lever (1) on the bottom of the computer to the **Unlock** position.

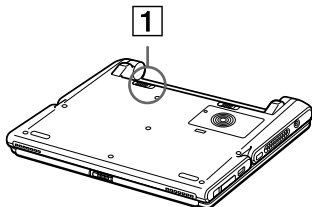

- 2 Align the grooves (2) and tabs on the battery (3) with the tabs and notches on the back of the computer, and then slide the battery towards the computer until it clicks into place.

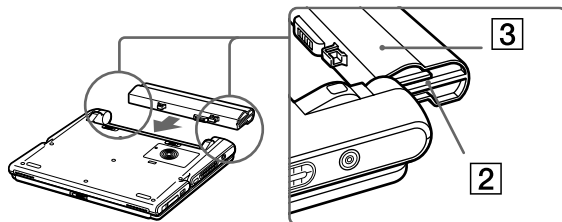

- 3 Slide the lock lever into the **Lock** position to secure the battery on the computer.

 When the computer is directly connected to AC power and has a battery pack inserted in the battery bay, it uses power from the AC outlet.

 Make sure the cover is closed before inserting the battery pack.

### Charging the battery pack

To charge the battery pack, proceed as follows:

- 1 Connect the AC adapter to the computer.
- 2 Insert the battery pack.

The computer automatically charges the battery (1) (the battery indicator (2) light flashes in a double blink pattern as the battery charges). When the battery is 85% full, the battery indicator light turns off. This process takes approximately 5.5 hours if your notebook is on. To charge the battery completely, continue charging for three additional hours.

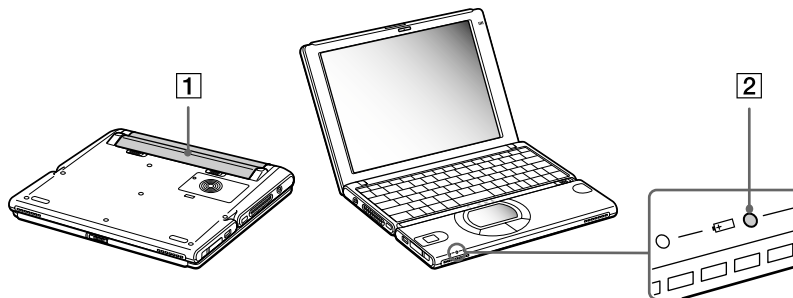

#### *battery indicator light status*

#### *meaning*

on	The computer is using battery power.
single blink	The battery is running out of power.
double blink	The battery is charging.
off	The computer is using AC power.



When the battery is running out of power, both the battery and power indicators blink.

Keep the battery pack in the computer while it is directly connected to AC power. The battery pack continues to charge while you are using the computer.

If the battery level falls to below 10%, you should either attach the AC adapter to recharge the battery or shut down your computer and insert a fully charged battery.

You can extend battery life by changing the power management modes in the **PowerPanel** utility.

The battery pack supplied with your computer is a lithium ion battery and can be recharged any time. Charging a partially discharged battery does not affect battery life or battery autonomy.

The battery indicator light is on while you use the battery pack as a power source. When the battery life is nearly depleted, the battery indicator starts flashing.

### Removing the battery pack

To remove the battery pack, proceed as follows:

- 1 Turn off the computer and close the cover.
- 2 Slide the lock lever (1) to the **Unlock** position.
- 3 Slide the release lever (2) to the **Unlock** position and slide the battery away from the computer.

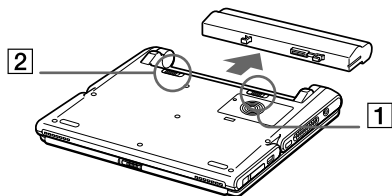

 You can remove the battery pack without turning off the computer when it is connected to the mains voltage (AC adapter).

Close the cover before you remove the battery pack.

You may lose data if you remove the battery pack while the computer is on and not connected to the AC adapter or if you remove the battery while the computer is in System Suspend mode.

## Starting your notebook

To start your computer, proceed as follows:

- 1 Slide the LCD lock lever (1) in the direction of the arrow, and lift the cover.

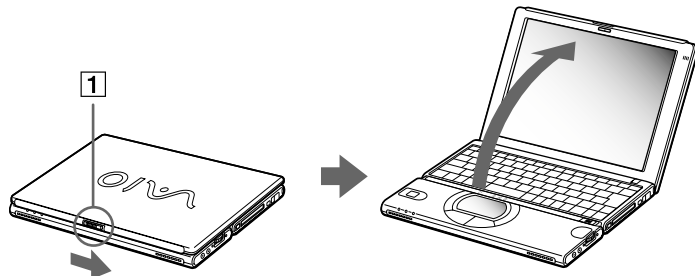

- 2 Slide the power switch (2) of the computer until the green power indicator (3) light turns on.

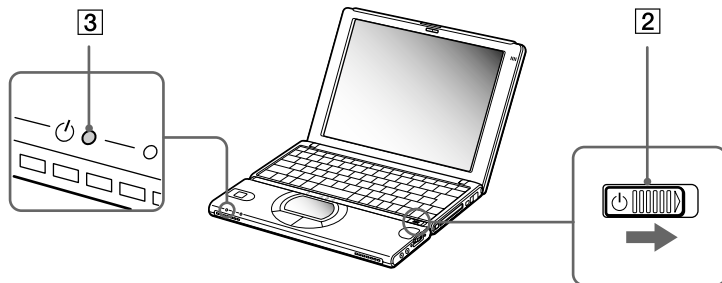

- 3 If necessary, press **<Fn>+<F5>** to adjust the brightness controls for the LCD display. To increase the brightness, use the up or right arrow keys. To decrease, use the down or left arrow keys.

 If you hold the power switch in the on position for more than four seconds, the computer will turn off.



## Shutting down your notebook

It is important that you shut down your computer properly in order not to lose unsaved data.

To shut down your computer, proceed as follows:

- 1 Click the **Start** button on the Windows® taskbar.
- 2 Click **Shut Down**.  
The **Shut Down** dialog box appears.
- 3 Select **Shut down**.
- 4 Click **OK**.
- 5 Wait for your computer to turn off automatically.  
The power indicator turns off.
- 6 Turn off any peripheral connected to your computer.

 Respond to any prompts warning you to save documents.

If you are unable to shut down your computer:

close all software in use,

remove the PC Cards if inserted,

disconnect any USB devices,

Then press the <Ctrl>+<Alt>+<Delete> keys at the same time; the Task Manager appears, allowing you to close open applications and to shut down the computer. If this does not work, you can slide the power switch forward and hold for four seconds. This will shut down the computer. This operation may result in data loss.

During a period of inactivity, you can conserve battery life by using **System Suspend** mode.

## Registering your notebook

You can take advantage of Sony's commitment to quality customer support and receive the following benefits by registering your computer:

- ❑ **VAIO-Link** – If you are experiencing any problems with your computer, you can check the VAIO-Link web site for a possible solution:  
<http://www.vaio-link.com>
- ❑ **Guarantee** – Protect your investment. See the Guarantee sheet for the terms and conditions and refer to your Customer Service Guide for more information.

To register your Sony Notebook, proceed as follows:

- 1 Click on the **Welcome** button on your desktop,
- 2 Click **Next**,
- 3 Click **Internet**,
- 4 Fill in your Registration card fields,
- 5 Scroll down to the bottom of the form and click **Send**,
- 6 Click **OK**.

 You must connect your phone line before using any online services, including the online registration service.

To access the online Registration web page, you must have a connection to the Internet.

## Using the keyboard



Your keyboard is very similar to a desktop computer's, but the keyboard has additional keys that perform specific notebook-related tasks.



### Keys

### Descriptions



Escape key (1)	The <b>&lt;Esc&gt;</b> (Escape) key is used to cancel commands.
Function keys (2)	The twelve function keys along the top of the keyboard are used to perform designated tasks. For example, in many applications, <b>&lt;F1&gt;</b> is the <b>Help</b> key. The task associated with each function key may vary from one application to the next.
Print Screen key (3)	The <b>&lt;Print Screen&gt;</b> key takes an electronic snapshot of the screen and moves it to the Windows Clipboard. You can then paste the screenshot into a document and print it.

<i>Keys</i>	<i>Descriptions</i>
Correction keys (4)	The <b>&lt;Insert&gt;</b> , <b>&lt;Back Space&gt;</b> and <b>&lt;Delete&gt;</b> keys enable you to make corrections.
Fn key (5)	The <b>&lt;Fn&gt;</b> key is used in combination with other keys to execute commands.
Navigation keys (6)	These keys enable you to move the cursor on the screen.
 Application key (7)	The Application key displays a shortcut menu; pressing this key is equivalent to clicking the right mouse button.
Numeric keypad area (8)	Contains the keys found on a typical calculator. Use the numeric keypad area to type numbers or to perform mathematical calculations such as addition and subtraction. Note that you must press the <b>&lt;Num Lock&gt;</b> key to activate the numeric keypad. When you do so, the <b>&lt;Num Lock&gt;</b> indicator illuminates.
Operator keys (9)	Several keys are always used with at least one other key: <b>&lt;Ctrl&gt;</b> , <b>&lt;Alt&gt;</b> , and <b>&lt;Shift&gt;</b> . When held down with another key, the <b>&lt;Ctrl&gt;</b> (Control) and <b>&lt;Alt&gt;</b> (Alternate) keys offer another way to execute commands. For example, in many applications, instead of choosing the <b>Save</b> command from a menu, you can hold down <b>&lt;Ctrl&gt;</b> and press <b>S</b> (referred to as <b>&lt;Ctrl&gt;+&lt;S&gt;</b> ). The <b>&lt;Shift&gt;</b> key is used to produce capital letters or special symbols such as @ and \$.
 Windows® key (10)	The key with the <b>Windows®</b> logo displays the Windows® Start menu; it is equivalent to clicking the <b>Start</b> button on the taskbar.







## Combinations and functions with the Windows key

### Combinations



### Functions





 + F1	Displays <b>Windows</b> Help.
 + Tab	Switches the selected button on the taskbar.
 + E	Displays <b>Windows Explorer</b> .

*Combinations**Functions*

 + F	Displays the <b>Search Results</b> window to find a file or folder. This is equivalent to selecting <b>Search</b> and then <b>For files or Folders</b> from the <b>Start</b> menu.
 + Ctrl + F	Displays the <b>Search Results - Computer</b> window where you can locate other computers.
 + M	Minimizes all displayed windows.
Shift +  + M	Returns all minimized windows to their previous size.
 + R	Displays the <b>Run</b> window. This is equivalent to selecting <b>Run</b> from the <b>Start</b> menu.
 + Insert	Displays the <b>System Properties</b> window. This is equivalent to double-clicking the <b>System</b> icon in the <b>Control Panel</b> .















*Indicators**Indicator**Functions*

 power	Power on: lights green. <b>System Idle</b> mode: lights amber. <b>System Suspend</b> mode: flashes amber.
 Battery	Indicates the status of the battery inserted in the computer.
 Memory Stick™	Turns on when the Memory Stick™ is in use. Turns off when the Memory Stick™ is no longer in use.

<i>Light</i>	<i>On</i>	<i>Off</i>
 hard disk	Data is read from or written to the hard drive. Do not enter <b>System Suspend</b> mode or turn off the computer when this indicator light is on.	The hard drive is not being accessed.
 Num Lock	Turns on when the number keys in the numeric keypad are active*.	Turns off when the alphanumeric character keys in the keypad area are active.
 Caps Lock	Turns on when the letters appear in uppercase as you type. The <b>&lt;Shift&gt;</b> key lowers the case of typed letters when <b>Caps Lock</b> is on.	Turns off when the letters appear in lowercase as you type (unless you hold down the <b>&lt;Shift&gt;</b> key).
 Scroll Lock	Turns on when the screen scrolls differently (depends on the application, no effect in many applications.)	Turns off when the information moves across the display normally.

 If you connect an external keyboard and activate the Num Lock function, the Num Lock function on your notebook's keyboard will also be activated.

## Combinations and functions with the Fn key

Combinations/ Feature	Functions
Fn +  (ESC) System Suspend	Puts the system into <b>System Suspend</b> mode, a power management state. To return the system to the active state, press any key.
Fn +  (F3) speaker switch	Toggles the built-in speaker on and off.
Fn +  (F4) speaker volume	Adjusts the built-in speaker volume. To increase volume, press <Fn>+<F4> and then  or  To decrease volume, press <Fn>+<F4> and then  or 
Fn +  (F5) brightness control	Adjusts the brightness of the LCD. To increase light intensity, press <Fn>+<F5> and then  or  To decrease light intensity, press <Fn>+<F5> and then  or 
Fn+  /  (F7) switch to the external display	Toggles between the LCD, external display (connected to the Monitor connector) and both LCD and external display.
Fn+  (F12) System Hibernation	Provides for the lowest level of power consumption. When you execute this command, the states of the system and of the peripheral devices are written to the hard disk and the system power is turned off. To return the system to its original state, use the power switch to turn on the power.
Fn+B : Bass Boost	Toggles the Bass Boost function off and on. This feature is available with headphones only.
Fn+F : change the display size	Zooms the display size in or out when the display is set to less than maximum resolution.
Fn+S : System Idle	Puts the system into System Idle mode, a power management state. To return to the active state, press any key.

 Some functions are not available until Windows is launched.

## Using the touchpad

The keyboard contains a cursor-pointing device, your touchpad (1). You can point to, select, drag, and scroll objects on the screen using the built-in touchpad.

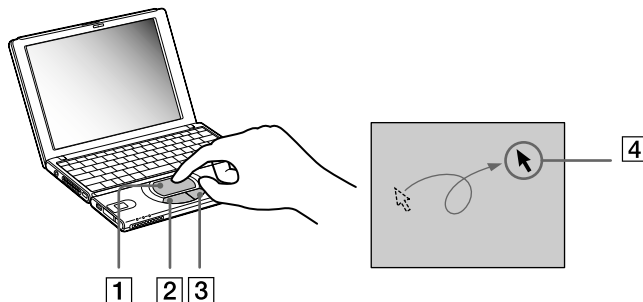

### Action

### Description

point	Slide one finger on the touchpad (1) to place the pointer (4) on an item or object.
click	Press the left button (2) once.
double-click	Press the left button twice.
right-click	Press the right button (3) once. In many applications, this action displays a shortcut menu.
drag	Slide one finger while pressing the left button.
scroll	Move your finger along the right edge of the touchpad to scroll vertically. Move your finger along the bottom to scroll horizontally (the scroll function is available only with applications that support a touchpad scroll feature.)



## Using Jog Dial

Your computer is equipped with a **Jog Dial** (1) on the right side of your computer. You can turn (2) or / and press (3) the Jog Dial to scroll the window, select a software, adjust the internal speaker volume, etc.

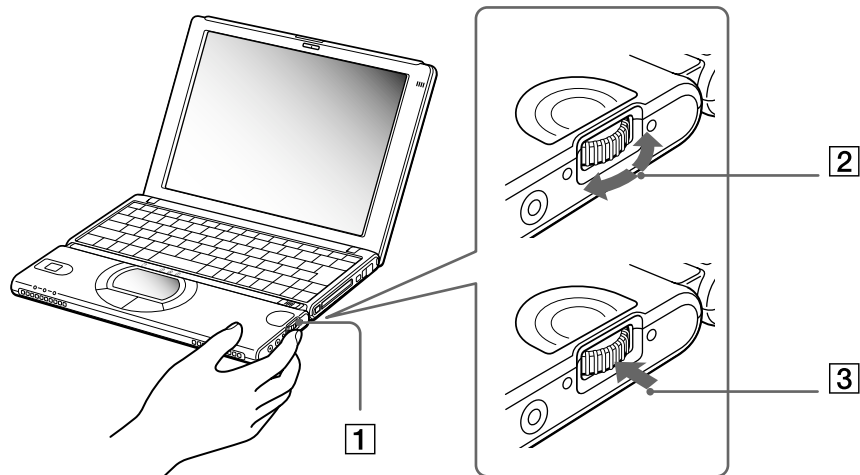

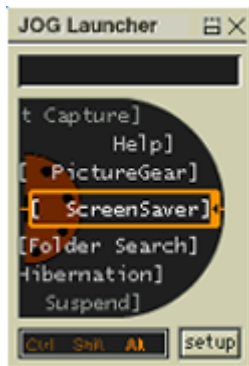

The Jog Dial window is always displayed on the screen. This window has two modes: Launcher mode or Guide mode.

The Jog Dial window is in Launcher mode until you start an application or the Jog Dial window becomes active. When an arrow appears next to an item in the Jog Dial window, you can display a submenu for that item by selecting it and pressing the Jog Dial.



The Jog Dial window switches to Guide mode when you start an application and its window becomes active. Depending on the application, the Jog Dial window displays different commands that you can select or execute by rotating or pressing the Jog Dial.



 You can adjust the size of the Jog Dial window or close it. To display the Jog Dial window, double-click  or  on the taskbar.

To use the Jog Dial in Launcher mode, proceed as follows:

- 1 Click the **Jog Dial** window or press the Jog Dial while pressing the **<Ctrl>** key to switch to Launcher mode.
- 2 Turn the Jog Dial to select an item, then press the Jog Dial.  
The Jog Dial window switches to Guide mode, and shows the Jog Dial function.

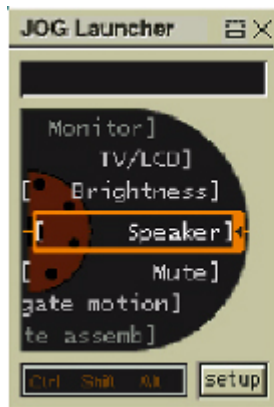

- 3 Turn or press the Jog Dial to use the Jog Dial function.
- 4 To select another item, switch to Launcher mode and repeat this procedure.

### *Software supporting Jog Dial*

If the Sony software supporting the Jog Dial is active, you can use Jog Dial functions allocated to each software.

### *Software not supporting Jog Dial*

If the software in use does not support the Center Jog Control, you can scroll the window or adjust the window size.

## Using PC Cards

Your computer includes a PC Card slot. PC Cards allow you to connect portable external devices.

### Inserting a PC Card

To insert a PC Card, proceed as follows:

- 1 Insert the PC Card into the PC Card slot, front label facing up (1).

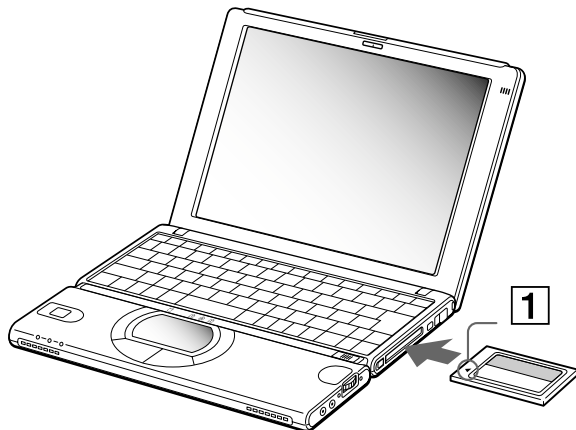

- 2 Gently push the card into the slot until the card is fixed into the connector.

 Some PC Cards may require you to disable idle devices when using the PC Card. You can use Sony Notebook Setup to disable devices.

Be sure to use the most recent software driver provided by the PC Card manufacturer.

If an “!” mark appears on the Device Manager tab in the System Properties dialog box, remove the software driver and then reinstall it.

You do not need to shut down the computer before inserting or removing a PC Card.

Do not force a card into the slot. It may damage the connector pins. If you have difficulty inserting a card, check that you are inserting the card in the correct direction. See the manual supplied with your PC Card for more information on use.

For some PC Cards, if you alternate between normal power operation and the System Suspend or System Hibernation power management modes while the card is inserted, you may find that a device connected to your system is not recognized. Reboot your system to correct the problem.

## Removing a PC Card

If you unplug this device from the computer when turned on, your system might crash and you might lose data that you did not save before.

If your computer is turned off, you do not have to follow these instructions.

To remove a PC Card, proceed as follows:

- 1 Double-click  in the taskbar.  
The **Unplug or Eject Hardware** dialog box appears.
- 2 Select the hardware you want to unplug and click **Stop**.  
The **Stop a Hardware device** dialog box appears.
- 3 Confirm the device to stop and click **OK**.  
The **Safe to Remove Hardware** dialog box appears, confirming the device can be safely removed from the system.
- 4 Click **OK**.
- 5 Click **Close** to close the **Unplug or Eject Hardware** dialog box.
- 6 Eject the PC Card release button and then press it to eject the card.
- 7 Gently press the card and pull it out.

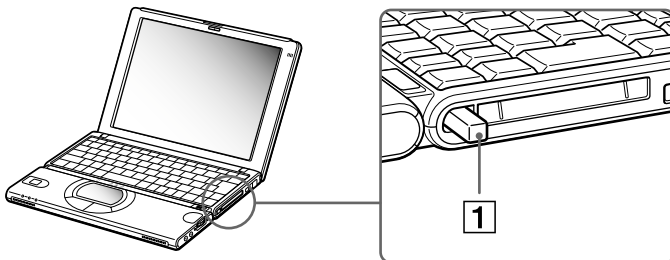

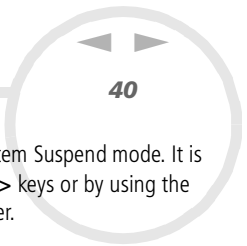

 While the card is inserted, your computer may not enter the System Hibernation power management mode. It may enter System Suspend mode. It is recommended to remove the card when your computer enters the System Hibernation mode by pressing the **<Fn> + <F12>** keys or by using the Power Panel utility, and when it is set to enter System Hibernation automatically while using a battery as the source of power.

You may not be able to use some PC Cards or some functions within the PC Card with this computer.



## Using Memory Stick™

This compact, portable, and versatile recording medium has a data capacity exceeding that of a floppy disk. The Memory Stick™ is specially designed for exchanging and sharing digital data with compatible products. Because it is removable, it can be used for external data storage.



When the Memory Stick™ erasure prevention switch is set to LOCK, data cannot be recorded or erased.

You can enjoy images that you have recorded with a Memory Stick™ compatible video camera recorder or a digital still camera.

Before using Memory Sticks™, you should back up important data.

Only MagicGate Memory Stick™ media can be used with copyright protected data like music.

To avoid damaging data:

- Do not remove a Memory Stick™ or turn off the power while the access light is on.
- Do not use Memory Sticks™ in locations that are subject to static electricity or electrical noise.
- Do not touch the Memory Stick™ connector with your finger or metallic objects.
- Do not attach labels other than the supplied label to a Memory Stick™.
- Do not bend, drop, or apply strong shock to Memory Sticks™.
- Do not disassemble or modify Memory Sticks™.
- Do not allow Memory Sticks™ to get wet.
- Do not use or store Memory Sticks™ in a location that is subject to:
  - Extremely high temperatures, such as in a car parked in the sun
  - Direct sunlight

To prolong the life of Memory Sticks™, use the supplied storage case.

## Types of Memory Stick™

Two types of **Memory Stick™** are available. The first type, **MagicGate™ Memory Stick** (hereafter referred to as **MG Memory Stick**), is provided with copyright protection. The second type, simply referred to as **Memory Stick™**, does not have the same copyright protection as the MagicGate one.

You can use both media with your notebook.

For music, which requires copyright protection, you can only use **MG Memory Stick** with your notebook. You can also use MagicGate-compatible devices to record and playback music when they are connected to your computer.

You can store mixed data on the **Memory Stick™**. For example, you can copy an image onto an **MG Memory Stick** that already contains music.

## What is MagicGate?

MagicGate is copyright protection that consists of authentication and encryption technology. Authentication technology ensures that protected content is only transferred between compliant devices and media. Protected content is recorded and transferred in an encrypted format to prevent unauthorized duplication or playback.



A MG Memory Stick can be recognized from its  mark.

Copyright protected music data cannot be checked out to a Memory Stick other than an MG Memory Stick.

The recorded music is limited to private use only. The use of music for any purpose other than the intended use requires the permission of the copyright holders.

Sony is not responsible for music files that are not saved on your computer due to unsuccessful recording from CDs or unsuccessful downloading of music.

## Inserting a Memory Stick™

To insert a Memory Stick™, proceed as follows:

- 1 Insert it into the slot until the Memory Stick™ is fixed into the connector.
  - 2 When the Memory Stick™ is connected properly, you can see the contents of the card by clicking the Removable Disk (S:) icon.
-  **VisualFlow** can be configured to start automatically when you insert a Memory Stick. You can change the settings in **VAIO Action Setup**.
- ! Hold the Memory Stick™ media with the arrow pointing in the correct direction when you insert it into the slot. To avoid damaging the computer or the Memory Stick™ media, do not force the Memory Stick™ media into the slot if it does not insert smoothly.

## Removing a Memory Stick™

To remove a Memory Stick™, proceed as follows:

- 1 Make sure that the Memory Stick™ access indicator (1) is off.
- 2 When the Memory Stick™ comes out, pull it out. Push the Memory Stick™ media eject button (2).
- 3 When the button comes out, push the eject button again and remove the Memory Stick™.

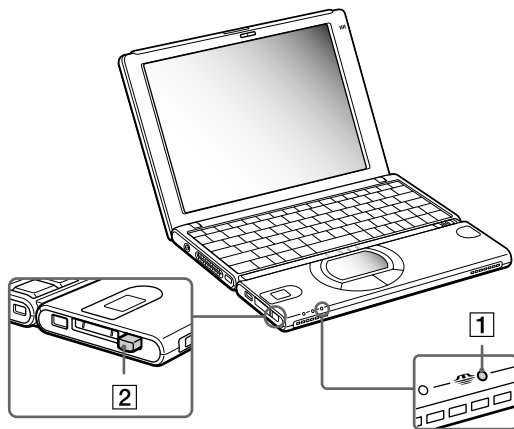

 Always remove the Memory Stick™ gently, or it may pop out unexpectedly.

It is recommended that you remove the Memory Stick™ before shutting down the computer.

- ! To prevent the possible loss of data, do not remove a Memory Stick™ when the Memory Stick™ access light is on. Large image files require more time to store on a Memory Stick™, so always check the Memory Stick™ access indicator and make sure that it is off before you remove the Memory Stick™.

## Write-protecting a Memory Stick™

**Memory Sticks™** are designed with an erasure prevention switch to protect valuable data from accidental erasure or overwriting.

Move the tab to the right or left to set or release write-protection. When the erasure prevention switch is off, data can be saved on the Memory Stick™. When the erasure prevention switch is on, data can be read from but not saved on the Memory Stick™.

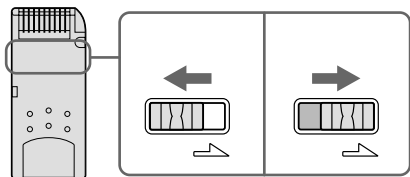

## Formatting a Memory Stick™

**Memory Sticks™** are formatted for immediate use when you purchase them. If you need to reformat a Memory Stick, use the **Memory Stick Formatter** software provided with your notebook. For more details about using **Memory Stick Formatter**, refer to the help files.

To format a Memory Stick™, proceed as follows:

- 1 Insert the Memory Stick™ into the notebook.
- 2 Click the **Start** button, point to **Programs**, click **Memory Stick Utility** and then click **Memory Stick Formatter**.

The **Memory Stick Formatter** window appears.

- ! If you format a Memory Stick™ that already contains data, all the data (including music data) will be erased. Confirm that the Memory Stick™ does not contain files that you want to keep.

## Using the modem

Your notebook is equipped with an internal modem.

You need to connect a phone line to take advantage of online services and the Internet, to register your computer and software online, and to contact VAIO-Link.

To connect a phone line, proceed as follows:

- 1 Plug one end of the phone cable (1) into the phone line jack on the computer.

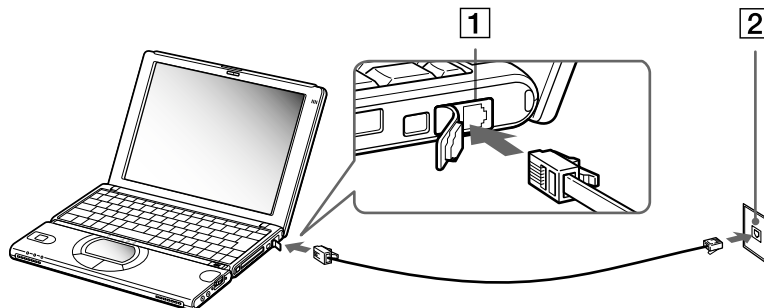

- 2 Plug the other end into the wall jack (2).



A country-specific phone plug is supplied with your VAIO notebook, allowing you to plug the phone line into the wall jack.

Your computer cannot be connected to a coin-operated telephone, and may not work with multiple phone lines or a private branch exchange (PBX). If you connect the modem to a parallel connected phone line, the modem or the other connected device may not function properly. Some of these connections may result in excess electrical current and could cause a malfunction in the internal modem.

Phone cable and connectors are TNV (Telecommunications Network Voltage), according to EN60950.

## Using power saving modes

When you use a battery as the source of power for your computer, you can take advantage of power management settings to conserve battery life. In addition to the normal operating mode, which allows you to turn off specific devices, your computer has three distinct power saving modes: **System Idle**, **System Suspend** and **System Hibernation**.

When using battery power, you should be aware that the computer automatically enters **System Hibernation** mode when the remaining battery charge drops below 7 percent, regardless of the power management setting you select.

 If the battery level falls to below 10 percent, you should either attach the AC adapter to recharge the battery or shut down your computer and insert a fully charged battery.

### Using Normal mode

This is the normal state of your computer when it is in use. The green power indicator light is on in this mode. To save power, you can turn off a specific device such as the LCD or the hard disk.

### Using System Idle mode

This mode is convenient if you do not need to use your computer for a short period. The hard disk and the video display enter a low power state and the CPU stops. The power indicator light is amber in this mode.

To activate System Idle mode, proceed as follows:

Press **<Fn>+<S>**. You can also enter System Idle mode by using the PowerPanel utility.

To return to Normal mode, proceed as follows:

Press any key.

### Using System Suspend mode

The computer saves the current state of the system in RAM and switches off power to the CPU. The amber power light flashes in this mode.

To activate System Suspend mode, proceed as follows:

Press **<Fn>+<Esc>**.

Or,

Slide the power switch quickly.

You can also use the PowerPanel utility to enter **System Suspend** mode.

To return to Normal mode, proceed as follows:

Press any key.

 If you slide the power switch and hold for more than four seconds, the computer will switch off automatically.

### Using System Hibernation mode

The state of the system is saved on the hard disk and power is turned off. The power indicator light is off in this mode.

To activate System Hibernation mode, proceed as follows:

Press **<Fn>+<F12>**.

Or,

Use the PowerPanel utility.

To return to normal mode, proceed as follows:

Turn on the computer by sliding the power switch.

The computer returns to its previous state.



## Connecting peripheral devices

You can add functionality to your computer by connecting or using any of these peripherals and enjoy the software described in the About the software on your Sony Notebook user guide.

 Before you connect peripherals, turn off the computer and all peripherals.

Connect the power cord only after connecting all cables.

Turn on the computer only after turning on all peripherals.

Connecting an external display [\(page 50\)](#)

Connecting external speakers [\(page 53\)](#)

Connecting an external microphone [\(page 54\)](#)

Connecting a Universal Serial Bus (USB) device [\(page 55\)](#)

Using a CD-ROM drive [\(page 59\)](#)

Connecting a printer [\(page 61\)](#)

Connecting a Bluetooth™ device to your notebook\* [\(page 62\)](#)

Connecting an i.LINK™ device [\(page 63\)](#)

\* The Bluetooth™ availability depends on the model and your country of residence.

## Connecting an external display

You can connect an external display to your notebook. For example, you can use your computer with the following devices:

- ❑ Computer display (monitor),
- ❑ Projector.

 Turn off your computer and the peripherals, unplug the AC adapter and the power cord before connecting the external display.

Connect the power cord after connecting all other cables.

Turn on the peripherals, then turn on your computer.

## Connecting a computer display

Use the supplied display adapter to connect your external display to the computer.

When you connect an external display to the monitor connector, you can press **<Fn>+<F7>** to toggle the output between the Liquid Crystal Display (LCD), the external monitor or both devices.

You may not be able to display the computer's LCD and the external display together, depending on the type of computer display and projector used.

To connect a computer display, proceed as follows:

- 1 Plug the supplied display adapter (1) into the computer's monitor connector (2) and the display cable (3) into the display adapter.
- 2 If necessary, plug one end of the display's power cord (4) into the display, and the other end into an AC outlet.

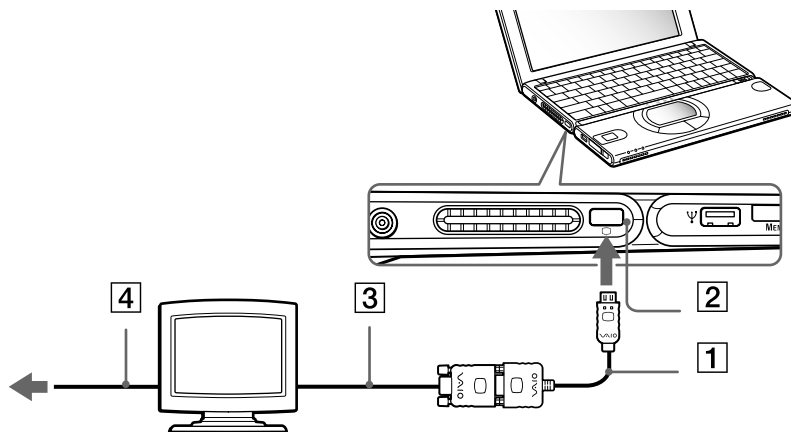

 To remove the display adapter, first turn off the computer, then press both sides of the display adapter connector and unplug it from the computer.

## Connecting a projector

You can use a projector as an external display, such as the Sony LCD Projector. You can connect a projector using the supplied display adapter.

To connect a projector, proceed as follows:

- 1 Plug the supplied display adapter (1) into the computer's monitor connector (2) and the display signal cable (3) to the display adapter.
- 2 Plug the speaker audio cable (4) into the earphone connector (5) identified by the  symbol.
- 3 Plug the projector power cord (6) into an AC outlet.

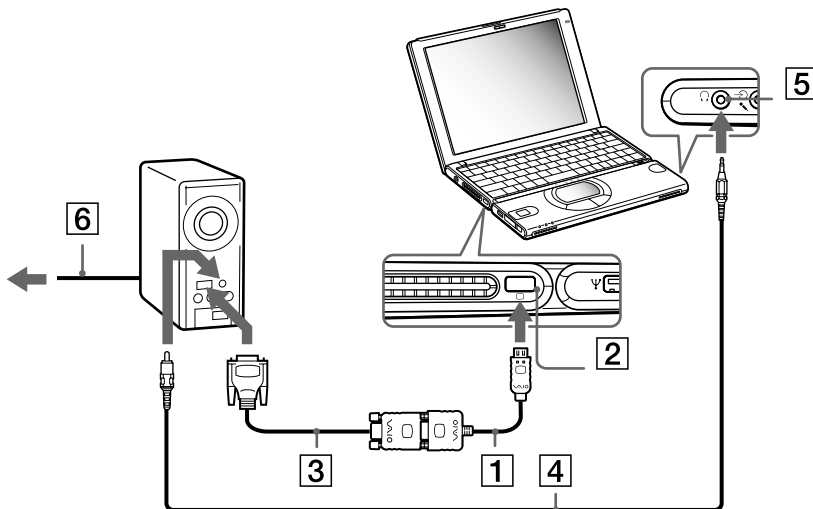



## Connecting external speakers

You can enhance the sound quality of your computer by connecting external speakers.

To connect external speakers, proceed as follows:

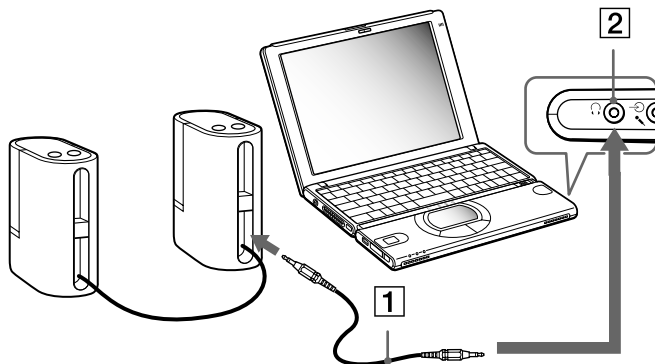
- 1 Plug the speaker cable (1) into the earphone connector (2) identified by the  symbol.
- 2 Turn down the volume of the speakers before you turn them on.



 Make sure your speakers are designed for computer use.

Do not place diskettes on the speakers; their magnetic field may damage the data on the diskettes.

## Connecting an external microphone

Your VAIO notebook contains an internal microphone. It is also possible to plug in an external microphone.

To connect an external microphone, proceed as follows:

Plug the microphone cable (1) into the microphone connector (2) identified by the  symbol.

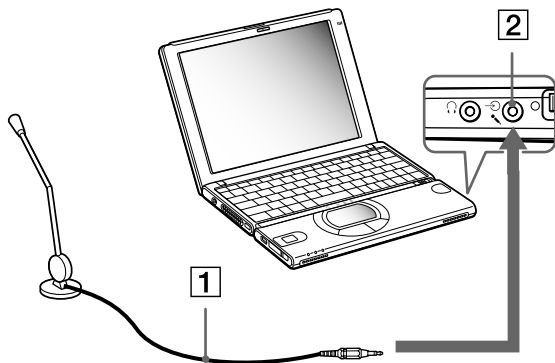

 Make sure your microphone is designed for computer use.

## Connecting a Universal Serial Bus (USB) device

You can connect a USB device (e.g. mouse, floppy disk drive...) to your computer. You do not need to shut down the computer before connecting or disconnecting a USB peripheral. When you start your notebook with a USB hub connected to it, make sure that a device is connected to the USB hub. If you encounter problems booting when a USB hub is connected to your notebook, unplug the hub and reboot.

### Connecting a USB mouse

To connect a USB mouse, proceed as follows:

Plug the USB mouse cable (2) into the USB connector (1) identified by the  symbol.

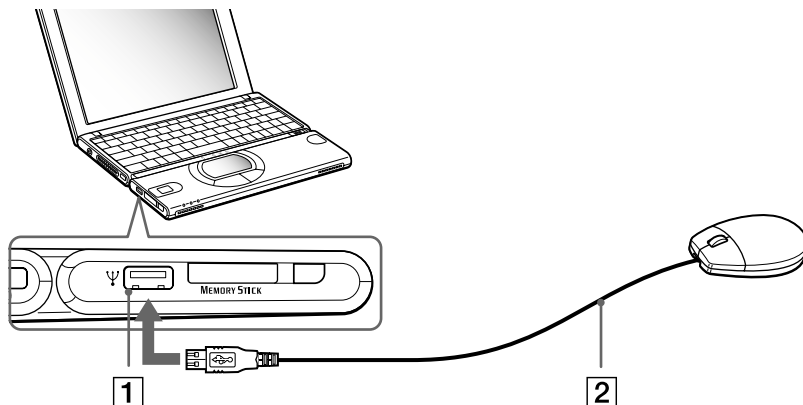

 You can connect the optional Sony USB mouse (PCGA-UMS1 series). As the driver for this mouse is preinstalled on your computer, you can use the mouse by just connecting it.

## Connecting a USB floppy disk drive

You can connect a floppy disk drive to the USB connector on your computer.

### Connecting the floppy disk drive

To connect the floppy disk drive, proceed as follows:

Plug the floppy disk drive (1) cable into the USB connector (2) identified by the  symbol. The VAIO logo on the disk drive should be facing up.

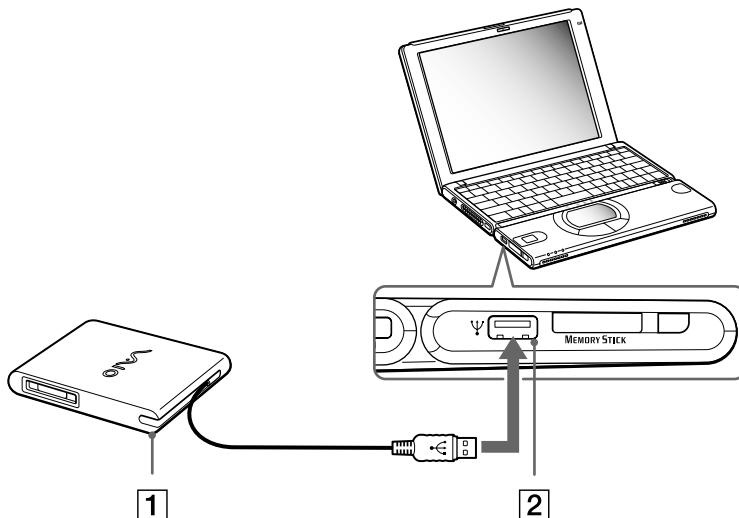



### Inserting a diskette

To insert a diskette, proceed as follows:

- 1 Hold the diskette (2) with the label side facing up.
- 2 Gently push the diskette into the drive (1) until it clicks into place.

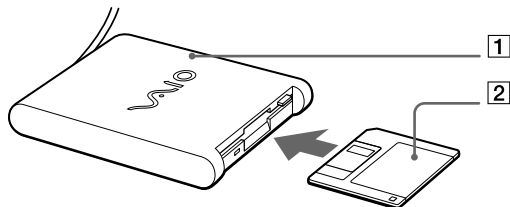

### Removing a diskette

To remove a diskette, proceed as follows:

When you finish using the diskette, wait until the LED indicator (2) turns off and then press the Eject button (1) to remove the diskette.

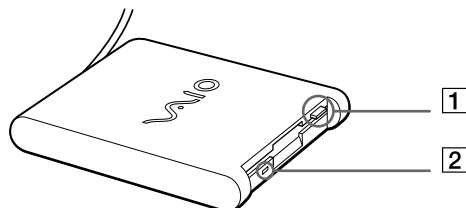

 Before pressing the Eject button, make sure that the LED indicator is turned off.

If the diskette does not come out by pressing the Eject button, disconnect the floppy disk drive from the computer.

**!** Do not press the Eject button while the LED indicator is on. It may damage the diskette.

### *Removing the floppy disk drive*

To remove the floppy disk drive, proceed as follows:

- ❑ If your computer is on, wait until the LED indicator turns off and then unplug the USB cable from the computer. If the floppy disk drive is not removed properly, your system may crash and you may lose data that you did not save before.
- ❑ If your computer is off, you can directly unplug the USB cable from the computer.
-  To carry your floppy disk drive when you have finished using it, fold the floppy disk cable into the compartment on the side of the floppy disk drive.

## Using a CD-ROM drive

You can use the CD-ROM drive supplied with your notebook to read CD-ROMs, Audio-CDs and CD Extras.

### Connecting the CD-ROM drive

To connect the CD-ROM drive, proceed as follows:

- 1 Insert the CD-ROM card into the PC Card slot with the SONY logo facing up.
- 2 If this is not the case, try to reinsert the CD-ROM card.

 You cannot insert a disk when the computer is in **System Suspend** or **System Hibernation mode**.

Depending on the CD-ROM drive, the connection procedures may vary.

The driver for the PCGA-CD51/A optical disc drive is preinstalled on your computer. As no guarantee is supplied with your PCGA-CD51/A optical disc drive, your device is covered by the guarantee of your notebook.

## Removing the CD-ROM drive

If you unplug the CD-ROM drive from the computer when turned on, your system might crash and you might lose data that you did not save before. If your computer is turned off, you do not have to follow these instructions.

To remove the CD-ROM drive, proceed as follows:

- 1 Double-click  in the taskbar.  
The **Unplug or Eject Hardware** dialog box appears.
- 2 Select the hardware you want to unplug and click **Stop**.  
The **Stop a Hardware device** dialog box appears.
- 3 Confirm the device to stop and click **OK**.  
The **Safe to Remove Hardware** dialog box appears, confirming the device can be safely removed from the system.
- 4 Click **OK**.
- 5 Click **Close** to close the **Unplug or Eject Hardware** dialog box.
- 6 Remove the device safely.

## Connecting a printer

You can connect a Windows-compatible printer to your computer to print documents.

### Connecting a printer using the USB connector

You can connect a USB printer compatible with your version of Windows to your computer.

To connect a printer using the USB connector, proceed as follows:

- 1 Plug an optional USB printer cable (2) into the USB connector (1) identified by the  symbol on your computer and printer.

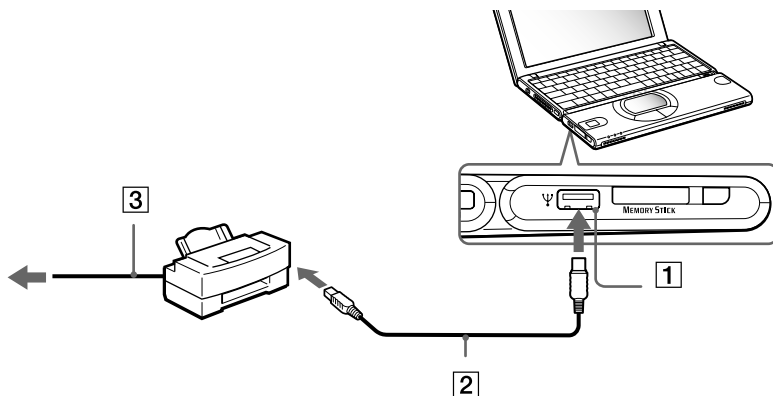

- 2 Plug the printer (3) power cord into an AC outlet.

 Before using the printer, you may need to change the Printer settings in the **Sony Notebook Setup** software. Turn off your computer and the printer, unplug the AC adapter and the power cord before connecting the printer.

## Connecting a Bluetooth™ device to your notebook\*

The Bluetooth™ wireless technology enables you to establish a wireless communication between your notebook and other Bluetooth™ devices such as a notebook, a mobile phone or a modem station without any cable within a 10 to 100 metres range in open space.

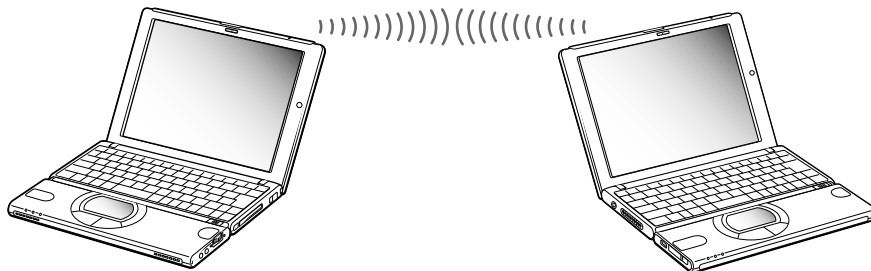

### Bluetooth™ security\*

The Bluetooth™ wireless technology has an authentication function which allows you to make sure with whom you communicate. With the authentication function, you can avoid any anonymous Bluetooth™ device to access your notebook.

The first time two Bluetooth™ devices communicate, a common Passkey should be determined for both devices to be registered. Once a device is registered, there is no need to reenter the Passkey.

You can change your settings in order not to be discovered by other Bluetooth™ devices or you can set a limit. For more information, see the BlueSpace online help.

 The 2.4 GHz band with which Bluetooth™ devices or wireless LAN devices work is used by various devices. Bluetooth™ devices use the technology to minimize the interference from other devices that use the same wavelength. However communication speed and distances can be inferior. Interference from other devices may also stop communications.

- ! The Bluetooth™ functions may not work depending on the devices or the software version used.
- ! When you purchase Bluetooth™ devices, check their operating conditions.

\* The Bluetooth™ availability depends on the model number and your country of residence.

## Connecting an i.LINK™ device

Your computer includes an i.LINK™ (IEEE1394) connector, which you can use to connect to an i.LINK™ device such as a digital video camera recorder or to connect two VAIO notebooks in order to copy, delete or edit files.

The i.LINK™ connector of your notebook does not supply power to external devices generally powered by i.LINK™ connectors.

The i.LINK™ connector supports transfer rates up to 400 Mbps; however, the actual transfer rate depends on the transfer rate of the external device.

The i.LINK™ features available may vary depending on the software applications you use. Refer to the documentation that came with your software for more information.

i.LINK™ cables compatible with your VAIO notebook include cables with the following part numbers: VMC-IL4415 (a 1.5 meter cable with a 4-pin connector at each end), VMC-IL4408Series (a 0.8 meter cable with a 4-pin connector at each end).

## Connecting a digital video camera recorder

To connect a digital video camera recorder, proceed as follows:

- 1 Plug one end of the i.LINK™ cable (1) into the i.LINK™ connector (2) of the computer and the other end into the DV Out connector (3) on the digital video camera recorder.

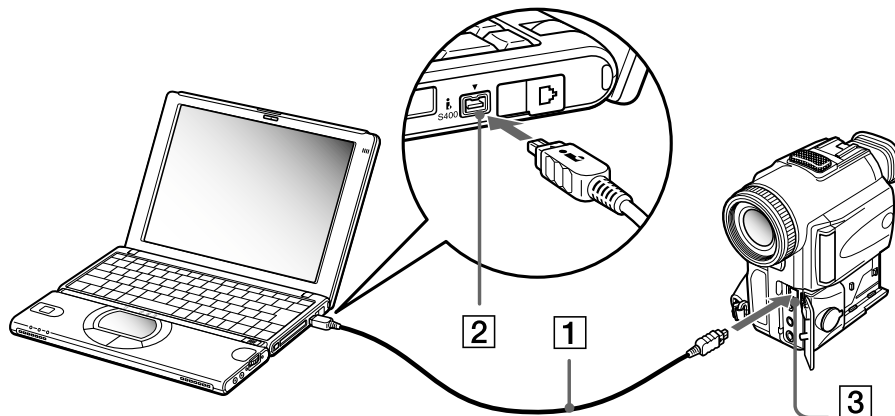

- 2 Launch the DVgate application.

 On Sony digital video cameras, connectors labeled **DV Out**, **DV In/Out** or **i.LINK™** are i.LINK™-compatible.

The Sony digital video camera recorder is an example; your digital video camera recorder may need to be connected differently.

If your digital video camera recorder includes a Memory Stick™ slot, you can copy images from it to your computer via a Memory Stick™. To do so, simply copy images on the Memory Stick™, then insert it into the Memory Stick™ slot of your computer.



### Connecting two VAIO notebooks

With Smart Connect you can copy, edit or delete files on another VAIO computer (equipped with Smart Connect) connected to your computer with an i.LINK™ cable (1) (not supplied).

You can also print a document on a printer connected to another VAIO computer.

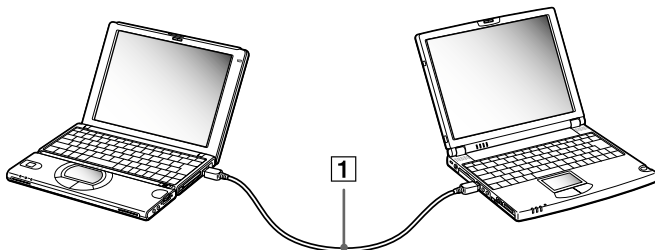

- When you use **Smart Connect** to connect two VAIO computers, you must assign each computer a unique name by which it can be identified when the two computers are networked.

## Getting help

This section describes how to get help and support from Sony, as well as troubleshooting tips for your computer.

### *Sony support options*

Sony provides several support options for your computer.

#### *Printed documentation supplied with your notebook*

- ❑ The **Customer Guide** explains how to start your computer and use the basic functions. This guide gives you the information to access VAIO-Link.
- ❑ The **Getting Started** gives you a list of the items you find in the box and a summary of the bundled applications.

#### *Online user guides on your Documentation CD-ROM*

- ❑ The **Hardware guide** explains how to use your computer, connect peripheral devices. It gives you a packing list and the list of specifications of your computer and accessories.
- ❑ The **Software guide** lists the pre-installed software titles and explains how to use the utility programs and perform basic computer tasks.
- ❑ The **Customer Service Guide** gives you complete information on the VAIO-Link Services.

### *Other sources of information*

- ❑ The **online help files** that accompany your pre-installed software contain instructions on using the software.
  - ❑ **VAIO-Link website:** if you have any problems with your computer, you can access the VAIO-Link website. Go to:  
<http://www.vaio-link.com>
  - ❑ **VAIO-Link Response Centre:** Before contacting VAIO-Link Response Centre, try to solve the problem by reading the User Guides and help files for the peripherals or software.
-  You need to plug in the phone line and configure your modem for use before using the communication features described in this manual.

## *Troubleshooting*

This section describes how to solve common problems you might encounter when using your notebook. Many problems have simple solutions. Please try these suggestions before contacting VAIO-LINK.

About the computer and software ([page 69](#))

About Bluetooth™\* ([page 72](#))

About the display ([page 74](#))

About CD-ROMs and diskettes ([page 75](#))

About sound ([page 77](#))

About the modem ([page 78](#))

About peripherals ([page 79](#))

About digital video captures and DVgate ([page 80](#))

\* The Bluetooth™ availability depends on the model and your country of residence.

## About the computer and software

### *My computer does not start*

- ❑ Check that the computer is plugged into a power source and that it is turned on.
- ❑ Check that the power indicator on the front panel of the computer indicates that the power is on.
- ❑ Check that the battery packs are inserted properly and that they are charged.
- ❑ Make sure there is no diskette in the floppy disk drive.
- ❑ Confirm that the power cord and all cables are connected firmly.
- ❑ If you have plugged the computer into a UPS, make sure the UPS is turned on and works.
- ❑ If you are using an external display, check that it is plugged into a power source and turned on. Check that you have switched to the external display and that the brightness and contrast controls are adjusted correctly.
- ❑ Moisture condensation may have occurred. Do not use the computer for at least one hour and then turn it on.
- ❑ When the internal backup battery is low on power, it may not be able to start your system properly.

*The message Press <F1> to resume, <F2> to setup appears at startup*

If the floppy disk drive is empty, proceed as follows to initialize the BIOS:

- 1 Turn off the computer.
- 2 Remove any peripheral devices connected to the computer.
- 3 Turn on the computer and press **<F2>** when the Sony logo appears.  
The BIOS setup menu screen appears.
- 4 Press the arrow keys to select the **Exit** menu.
- 5 Press the arrow keys to select **Get Default Values** and then press **<Enter>**. The message **Load default configuration now?** appears.
- 6 Make sure that **[Yes]** is selected and then press **<Enter>**.
- 7 Press the arrow keys to select **Exit** (save changes) and then press **<Enter>**.  
The message **Save configuration changes and exit now?** appears.
- 8 Make sure that **[Yes]** is selected and then press **<Enter>**.
- 9 Restart the computer by pressing **<Ctrl> + <Alt> + <Delete>** and by choosing **Shut Down**.

*My computer does not shut down*

It is recommended that you shut down your computer using the **Shut Down** command on the Windows® **Start** menu. Using other methods, including those listed here, may result in loss of unsaved data. If the **Shut Down** command does not work properly, proceed as follows:

- Restart the computer by pressing **<Ctrl> + <Alt> + <Delete>** and by choosing **Shut Down**.
- If this does not work, slide the power switch and hold it for at least four seconds, this turns off the power.
- Unplug the computer from the AC adapter and remove the battery pack from your computer.

### *My computer locks up*

- ❑ If you suspect one application is locking your system, you can try to stop it. To do this, press **<Ctrl>+<Alt>+<Delete>** once, click **Task Manager**, select the application or the process that is locking your system, and then click **End Task**.
- ❑ If the above method does not work or you do not know which application is locking your system, restart the computer. On the Windows<sup>®</sup> taskbar, click the **Start** button, click **Shut Down**, and then select **Shut Down** in the list and click **OK**.
- ❑ If the above method does not work, slide the power switch and hold it for at least four seconds. This turns off the power.
- ❑ If your computer locks up while playing a CD-ROM, stop the CD-ROM, and shut down the computer by pressing **<Ctrl>+<Alt>+<Delete>**, and then click **Shut Down**.

### *My software program locks up or crashes*

Contact the software publisher or designated provider for technical support.

### *My touchpad interprets a single tap as a double-click*

Open the **Mouse** icon in the **Control Panel** and change the button assignments in the **Mouse Properties** dialog box. One of the buttons is assigned to the double-click action.

### *My mouse does not work*

- ❑ Check that the mouse is plugged into the USB connector.
- ❑ If you are using an optional Sony USB mouse, check that the appropriate driver and mouseware are properly installed.

## About Bluetooth™\*

\* The Bluetooth™ availability depends on the model and your country of residence.

### *I cannot use the Bluetooth™ function*

- ❑ If the Bluetooth™ LED is off, press the Bluetooth™ power button for two seconds to turn the LED on.
- ❑ You cannot use the Bluetooth™ function when the computer is in a power saving mode. Return to normal mode and then press the Bluetooth™ power button.

### *I cannot find the Bluetooth™ device with which I want to communicate*

- ❑ Check that the Bluetooth™ function of the device with which you want to communicate is on. See the other device's manual for more details.
- ❑ If the device with which you want to communicate is already communicating with another Bluetooth™ device, it may not be found or it may not be able to communicate with your notebook.

### *The data transfer rate is slow*

- ❑ Check that the Bluetooth™ antenna is not covered.
- ❑ The data transfer speed depends on the obstacles and/or the distance between the two devices, but also on the radio wave quality, the operating system or the software used. Try to move your notebook or try to place the two devices closer.



*I cannot communicate with the other device although the distance between both devices is within 100 metres*

- ❑ Check that the Bluetooth™ antenna is not covered.
- ❑ The data transfer distance can be shorter than 100 metres depending on existing obstacles between the two devices, on radio wave quality, on the operating system or the software used. Try to move your notebook or to place both devices closer.
- ❑ If the device with which you want to communicate is already communicating with another Bluetooth™ device, it may not be found or it may not be able to communicate with your notebook.
- ❑ Check that the Bluetooth™ function of the device with which you want to communicate is on. See the other device's manual for more details.

*I cannot stop the Bluetooth™ function*

- ❑ Press the Bluetooth™ power button for at least four seconds and make sure that the Bluetooth™ LED turns off.
- ❑ If the above method does not work, press the power switch and hold it for at least four seconds. This turns off the power.

*I cannot connect to another Bluetooth™ device using services provided by another Bluetooth™ device*

The only way you can connect to another Bluetooth™ device is by using the services provided by your notebook. See the other Bluetooth™ device's manual for details.

## About the display

### *My LCD does not display anything*

- Check that the computer is plugged into a power source and that it is turned on.
- Check that the power indicator on the front panel of the computer is on.
- Check that the battery packs are inserted properly and that they are charged.
- Adjust the brightness of the LCD.
- The computer may be in LCD (video) standby mode. Press any key to activate the display.
- The display mode may be set to external display mode. Press and hold the **<Fn>** key while pressing **<F7>** several times.

### *The screen image on my external display is not centered or sized properly*

Use the controls on your external display to adjust the image.

### *The window I have just closed continues to appear on my LCD*

Press the **<Windows>**<sup>®</sup> key and **<D>** key twice to refresh the screen.

## About CD-ROMs and diskettes

### *My CD-ROM drive tray does not open*

- Make sure the computer is turned on.
- Press the **Eject** button on the optical device drive.
- If the **Eject** button does not work, you can open the tray by inserting a sharp, pointed object into the hole to the right of the **Eject** button.

### *I cannot play a CD-ROM disc*

- Make sure the label of the CD is facing up.
- If the CD requires software, make sure the software is installed according to the instructions of the program.
- Check the volume of your speakers.
- Clean the CD.
- Moisture condensation may have occurred. Leave the computer for at least one hour while it is turned on.
- Make sure the disk is properly inserted (you should hear a click).

### *My floppy disk drive cannot write to a diskette*

- The diskette is write-protected. Disable the write-protect feature or use a diskette that is not write-protected.
- Check that the diskette is properly inserted into the floppy disk drive.

*When I double-click an application icon, a message such as 'You must insert the application CD into your CD-ROM drive' appears and the software does not start*

- ❑ Some titles require specific files that are located on the applications' CD-ROM disc. Insert the disc and try starting the program again.
- ❑ Make sure you place the disc on the tray with the label side facing up.

*When I remove the Memory Stick, an error message appears*

Insert the Memory Stick™ in the slot again and press **<Enter>**. Wait until the active application finishes, then remove the Memory Stick. If the message confirms eject of the Memory Stick, click **OK**.

## About sound

### *My speakers are not producing sound*

- ❑ The built-in speakers may be turned off. Press **<Fn>+<F3>** to turn on the speakers.
- ❑ The speaker volume may be turned to the minimum. Press **<Fn>+<F4>**, and then press **➡** or **⬆** to increase the volume.
- ❑ If your computer is powered by battery, check that the battery is inserted properly and that it is charged.
- ❑ If you are using an application that has its own volume control, check that the volume is turned up.
- ❑ Check the volume controls in Windows®.
- ❑ If you use external speakers, check that the speakers are properly connected and the volume is turned up. If the speakers have a mute button, make sure it is off. If batteries power the speakers, check that the batteries are inserted properly and that they are charged.
- ❑ If you have connected an audio cable to the headphone connector, disconnect the cable.

### *My microphone does not work*

- ❑ If you are using an external microphone, check that the microphone is plugged into the microphone connector.
- ❑ Make sure that the volume for the microphone is not disabled or low in the **Sounds and Multimedia** icon of the **Control Panel**.

## About the modem

### *My internal modem does not work*

- Check that the phone line is plugged into your computer.
- Check that the phone line is working. You can check the line by plugging in an ordinary phone and listening for a dial tone.
- Check that the phone number the program is dialing, is correct.
- In the **Phone and Modem Options** dialog box (**Control Panel / Phone and Modem Options**), check that your modem is listed on the **Modems** tab, and that the location information is correct on the **Dialing Rules** tab.

### *My modem cannot establish a connection*

- The modem dialing mode may be incompatible with your telephone line.
- The modem may not work properly if you are behind a **Private Automatic Branch eXchange (PABX)**.
- Make sure that the modem is the only device connected to your telephone line.

### *My modem connection is slow*

Many factors influence modem connection speed, including telephone line noise or compatibility with telephone equipment (such as fax machines or other modems). If you think your modem is not connecting properly to other PC-based modems, fax machines, or your Internet Service Provider, check the following:

- Have your phone company check that your phone line is free from any line noise.
- If your problem is fax-related, check that there are no problems with the fax machine you are calling and that it is compatible with fax modems.
- If you are having a problem connecting with your Internet Service Provider, check that the ISP is not experiencing technical problems.
- If you have a second phone line available, try connecting the modem to that line.

## About peripherals

*I cannot use DV devices. The message 'DV equipment seems to be disconnected or turned off' appears*

- ❑ Check that the DV device is turned on and that the cables are properly connected.
- ❑ If you are using multiple i.LINK™ devices, the combination of the connected devices may cause unstable operation. In this case, turn off the power of all connected devices and disconnect unused devices. Check the connection and then turn on the power again.
- ❑ Select **IMPORT – Manual** and **EXPORT – Manual** in the **DVgate Motion Mode** scroll-down menu if this issue occurs with a non-Sony camera.

*My PC Card is not working*

- ❑ Make sure the PC card is compatible with your version of Windows®.
- ❑ Use the **Sony Notebook Setup** utility to disable devices you are not currently using.
- ❑ If you are using two PC cards, use the **Sony Notebook Setup** utility to disable the devices you are not currently using.

*I cannot print*

- ❑ Check that all the cables of the printer are correctly connected.
- ❑ Check that your printer is correctly configured and that you have up-to-date drivers. If needed, contact your dealer.

*The i.LINK™ device, which is connected to the computer, is not recognized, or a message appears*

Disconnect the i.LINK™ device once, then connect it again.

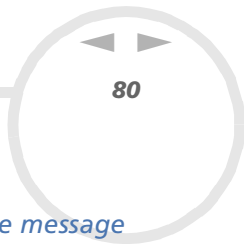

### *About digital video captures and DVgate*

*While I am recording images to a digital video device using DVgate, my system displays the message 'Recording to DV device failed. Check the power and cable connections to the DV device and try the operation again'*

Close all open applications and restart your computer. Frequent recording of images to a digital video device while using DVgate sometimes causes this error.



## Precautions

This section describes safety guidelines and precautions to help you protect your computer from potential damage.

Your notebook and memory modules use high precision components and electronic connectors technology. To avoid the invalidation of your guarantee by mishandling, it is recommended that:

- You contact your dealer to install a new memory module.
- You do not install it yourself, if you are not familiar with upgrading memory on a notebook.
- You do not touch the connectors or open the memory panel.

Please contact VAIO-Link if you need assistance.

## *Adding and removing memory*

In the future you may want to install memory modules to expand the functionality of your computer. You can increase the memory by installing optional memory modules.

Be careful when adding memory. Mistakes on installation or removal of the memory module may cause a malfunction.

For memory upgrades, use only PC100 (CL2) SDRAM SO-DIMM (gold leaf contacts).

Electrostatic discharge can damage electronic components. Before touching a memory expansion board, ensure the following:

- ❑ Handle the memory module gently.
  - ❑ The procedures described in this document assume familiarity with the general terminology associated with personal computers and with the safety practices and regulatory compliance required for using and modifying electronic equipment.
  - ❑ Disconnect the system from its power source and from any telecommunication links, networks, or modems before you open the system. Failure to do so may result in personal injury or equipment damage.
  - ❑ Electrostatic Discharge (ESD) can damage memory modules and other components. Install the memory module only at an ESD workstation. If such a station is not available, do not work in a carpeted area, and do not handle materials that produce or hold static electricity (cellophane wrappers, for example). Ground yourself by maintaining contact with an unpainted metal portion of the chassis while performing the procedure.
  - ❑ Do not open the memory module package until you are ready to install the module. The package protects the module from ESD.
- ! Use the special bag delivered with the memory module or wrap the module in aluminium foil to protect it from electrostatic discharge.



- ! Do not place the memory module in places subject to:
  - Heat sources such as radiators or air ducts,
  - Direct sunlight,
  - Excessive dust,
  - Mechanical vibration or shock,
  - Strong magnets or speakers that are not magnetically shielded,
  - Ambient temperature of more than +35°C or less than +5°C,
  - High humidity.

## Removing a memory module

To remove a memory module, proceed as follows:

- 1 Shut down your computer and disconnect all peripheral devices.
- 2 Unplug the computer and remove the battery pack.
- 3 Wait until the computer cools down.  
The inside of a notebook becomes extremely hot during operation. Wait for about one hour for the computer to cool down before you remove the screws.
- 4 Unscrew the six screws at the bottom of your computer.  
Use a precision Phillips screwdriver that matches the size of the screw heads.
- 5 Slide the LCD lock lever and lift the cover.
- 6 Raise the palmrest towards you, turn it over, and then set it gently on the keyboard.
- 7 Before you remove the memory module, touch a metal part of the computer to discharge any static electricity accumulated on your body.
- 8 Remove the memory module:
  - Carefully press down on the release tabs on either end of the memory module at the same time (1).
  - Pull out the memory module in the direction of the arrow (2).

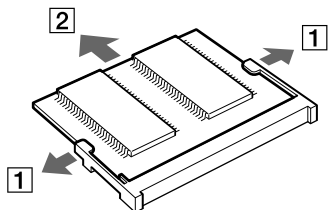

- 9 Return the palmrest to its original position by aligning it with the notch on the keyboard and then setting it on the keyboard. Handle the palmrest gently to avoid breaking the attached cable.
- 10 Close the display panel and replace the six screws on the bottom of the computer.
- 11 Use a Phillips (+) screwdriver to tighten all six screws.

## Adding a memory module

To add a memory module, proceed as follows:

- 1 Shut down your computer and disconnect all peripheral devices.
- 2 Unplug the computer and remove the battery packs.
- 3 Wait until the computer cools down.  
The inside of a notebook becomes extremely hot during operation. Wait at least one hour for the computer to cool down before you remove the screws.
- 4 Unscrew the six screws at the bottom of your computer.  
Use a precision Phillips screwdriver that matches the size of the screw heads.

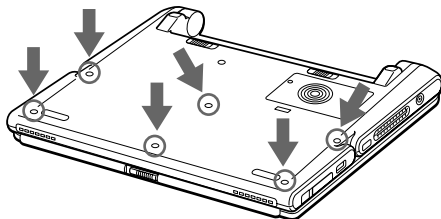

- 5 Slide the LCD lock lever and lift the cover.
- 6 Raise the palmrest (1) toward you, turn it over, and then set it gently on the keyboard.

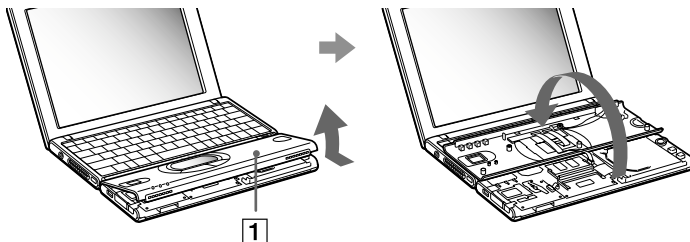

- 7 Before you remove the model from its package, touch a metal part of the computer to discharge any static electricity accumulated on your body.
- 8 Remove the module from its protective package.
- 9 Install the memory module by holding the module edge connector pointing down and the notch on the right, and then insert it diagonally into an empty slot.
- 10 Lower the memory module until it clicks into place on both ends:
  - ❑ Slide the memory module into the slot.
  - ❑ Snap the connector into place when the board is correctly seated.

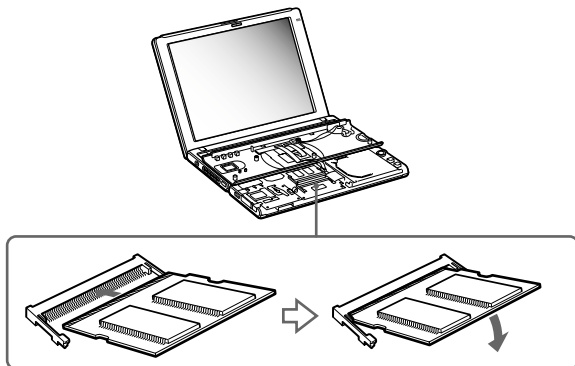

- ❑ Return the palm rest to its original position by aligning it with the notch on the keyboard and then setting it on the keyboard. Handle the palmrest gently to avoid breaking the attached cable.

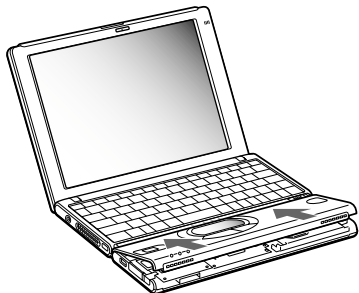

- 11 Close the display panel and replace the six screws on the bottom of the computer. Use a Phillips (+) screwdriver to tighten all six screws at the locations shown below.

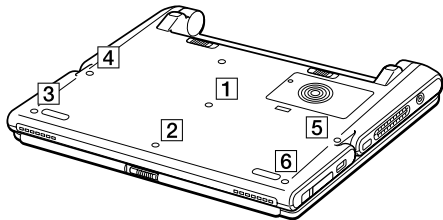

### *Viewing the amount of memory*

To view the amount of memory, proceed as follows:

- 1 Turn on the computer.
- 2 Click the **Start** button, point to **VAIO**, and click **Sony Notebook Setup**. The **Sony Notebook Setup** dialog box appears.
- 3 Click the **About this Computer** tab to view the amount of system memory. If the additional memory does not appear, you should try again to add memory.



## *Other precautions*

### *On handling the LCD screen*

- ❑ Do not leave the LCD facing the sun as it can damage the LCD. Be careful when using the computer near a window.
- ❑ Do not scratch the LCD or exert pressure on it. This could cause malfunction.
- ❑ Using the computer in low temperature conditions may produce a residual image on the screen. This is not a malfunction. When the computer returns to normal temperature, the screen returns to normal.
- ❑ A residual image may appear on the screen if the same image is displayed for a lengthy period of time. The residual image disappears in a while. You can use a screensaver to prevent residual images.
- ❑ The screen becomes warm during operation. This is normal and does not indicate a malfunction.
- ❑ The LCD is manufactured using high-precision technology. You may, however, see tiny black points and/or bright points (red, blue, or green) that continuously appear on the LCD. This is a normal result of the manufacturing process and does not indicate a malfunction.
- ❑ Avoid rubbing the LCD screen, as this can damage the screen. Use a soft, dry cloth to wipe the LCD screen.

### *On using power source*

- ❑ Your computer operates on 100V-240V AC 50/60 Hz.
- ❑ Do not share the AC outlet with other power-consuming equipment, such as a photocopier or shredder.
- ❑ You can purchase a power strip with a surge protector. This device prevents damage to your computer caused by sudden power surges such as those that may occur during an electrical storm.
- ❑ Do not place heavy objects on the power cord.
- ❑ To disconnect the cord, pull it out by the plug. Never pull the cord itself.
- ❑ Unplug your computer from the wall outlet, if you will not be using the computer for a long time.
- ❑ When the AC adapter is not used, unplug it from the AC outlet.
- ❑ Use only the supplied AC adapter. Do not use any other AC adapter.

### *On handling your notebook*

- ❑ Clean the cabinet with a soft, dry cloth or a soft cloth lightly moistened with a mild detergent solution. Do not use any type of abrasive pad, scouring powder, or solvent such as alcohol or benzene, as these may damage the finish of your computer.
- ❑ Should any solid object or liquid fall into the computer, shut down your computer and then unplug it. You may want to have the computer checked by qualified personnel before operating it any further.
- ❑ Do not drop the computer or place heavy objects on top of the computer.
- ❑ Do not place your computer in a location subject to:
  - ❑ Heat sources, such as radiators or air ducts,
  - ❑ Direct sunlight,
  - ❑ Excessive dust,
  - ❑ Moisture or rain,
  - ❑ Mechanical vibration or shock,

- ❑ Strong magnets or speakers that are not magnetically shielded,
- ❑ Ambient temperature of more than 35°C or less than 10°C,
- ❑ High humidity.
- ❑ Do not place electronic equipment near your computer. The electromagnetic field of your computer may cause a malfunction.
- ❑ Provide adequate air circulation to prevent that internal heat builds up. Do not place your computer on porous surfaces such as rugs or blankets, or near material such as curtains or draperies that may block its ventilation slots.
- ❑ The computer uses high-frequency radio signals and may cause interference to radio or TV reception. Should this occur, relocate the computer a suitable distance away from the set.
- ❑ Use only specified peripheral equipment and interface cables; otherwise, problems may result.
- ❑ Do not use cut or damaged connection cables.
- ❑ Your computer cannot be connected to a coin-operated telephone, and may not work with a private branch exchange (PBX).
- ❑ If the computer is brought directly from a cold location to a warm one, moisture may condense inside your computer. In this case, allow at least one hour before turning on your computer. If any problem occurs, unplug your computer and contact VAIO-Link.
- ❑ Make sure to disconnect the power cord before cleaning the computer.

### *On handling diskettes*

- ❑ Do not open the shutter manually and touch the surface of the diskette.
- ❑ Keep diskettes away from magnets.
- ❑ Keep diskettes away from direct sunlight and other heat sources.

### *On handling CD-ROM discs*

- ❑ Do not touch the surface of the disc.
- ❑ Do not drop or bend the disc.
- ❑ Fingerprints and dust on the surface of a disc may cause read errors. Proper care of the disc is essential to maintain its reliability. Do not use solvents such as benzine, thinner, commercially available cleaners or anti-static spray, as they may cause damage to the disc.
- ❑ For normal cleaning, hold the disc by its edge and use a soft cloth to wipe the surface from the center out.
- ❑ If the disc is badly soiled, moisten a soft cloth with water, wring it out well, and use it to wipe the surface of the disc from the center out. Wipe off any remaining moisture with a dry soft cloth.

### *On using the battery pack*

- ❑ Never leave the battery pack in temperatures above 60° C, such as in a car parked in the sun or under direct sunlight.
- ❑ Battery life is shorter in a cold environment. This is due to decreased battery efficiency at low temperatures.
- ❑ Charge the batteries at temperatures between 10° C to 30° C. Lower temperatures require a longer charging time.
- ❑ While the battery is in use or being discharged, the battery pack heats up. This is normal and is not cause for concern.
- ❑ Keep the battery pack away from all sources of heat.
- ❑ Keep the battery pack dry.
- ❑ Do not open or try to disassemble the battery pack.
- ❑ Do not expose the battery pack to any mechanical shock.

- ❑ If you are not using the computer for an extended period of time, remove the battery pack from the computer to prevent damage to the battery.
- ❑ If, after fully charging the battery pack, the battery power is still low, the battery pack may be reaching the end of its life and should be replaced.
- ❑ You do not need to discharge the battery before recharging.
- ❑ If you have not used the battery pack for a considerable amount of time, recharge the battery.

### *On using earphones*

- ❑ **Road safety** – Do not use earphones while driving, cycling, or operating any motorized vehicle. It may create a traffic hazard and is illegal in some areas. It can also be potentially dangerous to play loud music while walking, especially at pedestrian crossings.
- ❑ **Preventing hearing damage** – Avoid using earphones at high volume. Hearing experts advise against continuous, loud and extended play. If you experience a ringing in your ears, reduce the volume or discontinue use.

### *On handling Memory Stick™*

- ❑ Do not touch the connector with your finger or metallic objects.
- ❑ Use only the label supplied with the Memory Stick™ as a label.
- ❑ Do not bend, drop, or apply strong shock to the Memory Stick™.
- ❑ Do not disassemble or modify Memory Sticks™.
- ❑ Do not let cards get wet.
- ❑ Do not use or store Memory Sticks™ in a location subject to:
  - ❑ Extremely high temperatures, such as in a car parked in the sun,
  - ❑ Direct sunlight,
  - ❑ High humidity or near corrosive substances.
- ❑ Use the storage case supplied with the Memory Stick™.

## PCG-SR31K Specifications

### Model Number

### PCG-SR31K

<i>Operating system</i>	Microsoft® Windows® 2000 Professional
<i>Processor</i>	Low Voltage Mobile Intel® Pentium® III processor 750MHz
<i>Hard disk drive</i>	15 GB
<i>Standard RAM</i>	128 MB SDRAM micro DIMM
<i>Maximum RAM</i>	256 MB
<i>LCD screen</i>	10.4" XGA TFT
<i>L2 cache memory</i>	256 KB (CPU integration)
<i>MPEG</i>	MPEG 1 Digital Video Supports full-screen playback
<i>Graphics</i>	S3 Savage/IX (8 MB VRAM)
<i>Sound capabilities</i>	16-bit CD-quality stereo sound
<i>CD-ROM drive</i>	Up to 16x max. CD-ROM reading speed Laser diode properties: Wave length: 795 nm Laser output: 2.43 μW
<i>Internal modem</i>	Built-in modem V.90/K56Flex (56kbps) data/fax modem
<i>Telecommunication capabilities</i>	PSTN data connectivity

**Model Number****PCG-SR31K**

<i>Expansion capabilities</i>	One PCMCIA type I/II Card and Cardbus support
<i>Built-in capabilities</i>	Microphone, stereo speakers, touchpad, Jog Dial, MagicGate Memory Stick™
<i>Special buttons</i>	Jog Dial, Bluetooth
<i>Connection capabilities on notebook</i>	External speakers/headphone, microphone, USB, type II PC cards, i.LINK™ (IEEE1394) S400
<i>Supplied accessories</i>	CD-ROM drive, rechargeable battery, AC adapter, AC cord, phone cable, phone plug, display adapter.
<i>Service</i>	‡ 1 year free VAIO-Link Service
<i>Guarantee</i>	‡ 1 year guarantee (parts and labour)
<i>Power source</i>	16V DC/AC100-240V
<i>Power management</i>	Energy Star compliant ACPI (Advanced Configuration & Power Interface)
<i>Battery</i>	6 cells lithium ion
<i>Dimensions</i>	
<i>Width</i>	259 mm
<i>Height</i>	23.7 mm to 32.1 mm
<i>Depth</i>	209 mm
<i>Weight</i>	
<i>With battery</i>	1.36 kg
<i>Operating temperature</i>	+5°C to +35°C (temperature gradient less than 10°C/hour)

**Model Number****PCG-SR31K**

<i>Storage temperature</i>	-20°C to +60°C (temperature gradient less than 10°C/hour)
<i>Operating humidity</i>	20% to 80% (not condensed), provided that humidity is less than 65% at +35°C (hygrometer reading of less than 29°C)
<i>Storage humidity</i>	10% to 90% (not condensed), provided that humidity is less than 20% at +60°C (hygrometer reading of less than 35°C)
<i>Wireless communication: Method of communication</i>	Bluetooth™ standard Ver. 1.0B
<i>Maximum communication speed</i>	Approx. 723 kbps
<i>Output</i>	Bluetooth™ standard Power Class1
<i>Communication distance</i>	Approx. 100 – 10 m (open space)
<i>Compatible Bluetooth profile</i>	Generic Access Profile Service Discovery Application Profile Serial Port Profile Dial-up Networking Profile
<i>Usable frequency band</i>	2.4 GHz band (2.400 GHz – 2.4835 GHz)
<i>Bluetooth™ software</i>	BlueSpace, VisualShare

‡ See our special Guarantee extension conditions.

Specifications are subject to change without notice.



## PCG-SR31LK Specifications

### Model Number

### PCG-SR31LK

<i>Operating system</i>	Microsoft® Windows® 2000 Professional
<i>Processor</i>	Low Voltage Mobile Intel® Pentium® III processor 750MHz
<i>Hard disk drive</i>	15 GB
<i>Standard RAM</i>	128 MB SDRAM micro DIMM
<i>Maximum RAM</i>	256 MB
<i>LCD screen</i>	10.4" XGA TFT
<i>L2 cache memory</i>	256 KB (CPU integration)
<i>MPEG</i>	MPEG 1 Digital Video Supports full-screen playback
<i>Graphics</i>	S3 Savage/IX (8 MB VRAM)
<i>Sound capabilities</i>	16-bit CD-quality stereo sound
<i>CD-ROM drive</i>	Up to 16x max. CD-ROM reading speed Laser diode properties: Wave length: 795 nm Laser output: 2.43 μW
<i>Internal modem</i>	Built-in modem V.90/K56Flex (56kbps) data/fax modem
<i>Telecommunication capabilities</i>	PSTN data connectivity

**Model Number****PCG-SR31LK**

<i>Expansion capabilities</i>	One PCMCIA type I/II Card and Cardbus support
<i>Built-in capabilities</i>	Microphone, stereo speakers, touchpad, Jog Dial, MagicGate Memory Stick™
<i>Special buttons</i>	Jog Dial
<i>Connection capabilities on notebook</i>	External speakers/headphone, microphone, USB, type II PC cards, i.LINK™ (IEEE1394) S400
<i>Supplied accessories</i>	CD-ROM drive, rechargeable battery, AC adapter, AC cord, phone cable, phone plug, display adapter.
<i>Service</i>	‡ 1 year free VAIO-Link Service
<i>Guarantee</i>	‡ 1 year guarantee (parts and labour)
<i>Power source</i>	16V DC/AC100-240V
<i>Power management</i>	Energy Star compliant ACPI (Advanced Configuration & Power Interface)
<i>Battery</i>	6 cells lithium ion
<i>Dimensions</i> <i>Width</i> <i>Height</i> <i>Depth</i>	259 mm 23.7 mm to 32.1 mm 209 mm
<i>Weight</i> <i>With battery</i>	1.36 kg
<i>Operating temperature</i>	+5°C to +35°C (temperature gradient less than 10°C/hour)

**Model Number****PCG-SR31LK**

<i>Storage temperature</i>	-20°C to +60°C (temperature gradient less than 10°C/hour)
<i>Operating humidity</i>	20% to 80% (not condensed), provided that humidity is less than 65% at +35°C (hygrometer reading of less than 29°C)
<i>Storage humidity</i>	10% to 90% (not condensed), provided that humidity is less than 20% at +60°C (hygrometer reading of less than 35°C)

‡ See our special Guarantee extension conditions.

Specifications are subject to change without notice.

# INDEX

## A

- AC adapter [5](#), [19](#)
- air circulation [91](#)
- Alt key [28](#)
- application key [28](#)

## B

- Bass Boost [31](#)
- battery
  - charging the [21](#)
  - inserting the [20](#)
  - removing the [23](#)
- battery charging status [21](#)
- battery connector [18](#)
- battery indicator [17](#), [21](#), [29](#)
- battery lock lever [18](#)
- battery release lever [18](#)
- Bluetooth™ button [17](#)
- Bluetooth™ indicator [17](#)
- brightness control [31](#)
- button
  - Bluetooth™ [17](#)

## C

- cable
  - i.LINK™ [64](#)
  - microphone [54](#)
  - phone [46](#)
  - printer [61](#)
  - speaker [53](#)
- camera [64](#)
- Caps Lock indicator [17](#), [30](#)
- CD-ROM drive [59](#)
- charging status [21](#)
- combination controls [28](#), [31](#)
- connector
  - battery [18](#)
  - DC In [19](#)
  - headphone [15](#)
  - i.LINK [15](#)
  - line-in/microphone [15](#)
  - microphone [54](#)
  - USB [16](#)
- copyright [2](#)
- correction keys [27](#)
- Ctrl key [28](#)
- Customer Guide [66](#)
- Customer Service Guide [66](#)

## D

- DC In [16](#), [19](#)
- digital video camera [64](#)
- diskette
  - inserting a [57](#)
  - removing a [57](#)
- display [50](#)
- display adapter [52](#)
- documentation pack [10](#)
- DVgate [64](#)

## E

- Energy Star guidelines [3](#)
- ergonomic considerations [13](#)
- Escape key [27](#)

## F

- floppy disk drive
  - connecting a USB [56](#)
  - removing a USB [58](#)
- Fn key [27](#), [31](#)
- function keys [27](#)

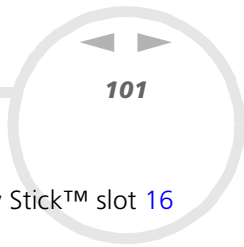
**G**

guarantee 5, 26

**H**

hard disk drive indicator 17, 30

headphone connector 15

help 66

**I**

i.LINK connector 15

i.LINK™

device 63

i.LINK™ cable 64

indicator

battery 17, 21, 29

Bluetooth™ 17

Caps Lock 17, 30

hard disk drive 17, 30

Num Lock 17, 30

power 17, 29

Scroll Lock 17, 30

Insert key 27

internal microphone 17

**J**

Jog Dial 15, 33

**K**

key

Alt 28

application 28

Ctrl 28

Escape 27

Fn 27, 31

Insert 27

Print Screen 27

Shift 28

Windows 28

keyboard 27

**L**

LCD screen 17

line-in/microphone connector 15

lithium ion battery 8

lock lever

battery 18

LCD 24

**M**

MagicGate Memory Stick™ slot 16

memory module

adding a 85

removing a 84

Memory Stick 41

inserting a 43

removing a 44

microphone 54

internal 17

microphone cable 54

microphone connector 54

modem 5, 46

moisture condensation 91

monitor 50

mouse 55

**N**

navigation keys 28

Normal mode 47

Num Lock 28

Num Lock indicator 17, 30

numeric keypad 28

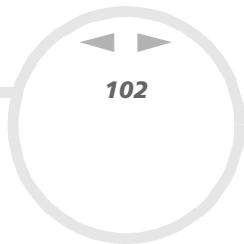

## O

operator keys 28

## P

PC Card

inserting a 37

removing a 39

PC Card slot 15, 37

peripherals 49

phone cable 46

phone line jack 46

power indicator 17, 29

power saving modes 47

power switch 17, 24

precautions 81

Print Screen key 27

printer 61

printer cable 61

projector 52

## R

registration 26

regulatory information 7

release lever

battery 18

## S

safety information 4

Scroll Lock indicator 17, 30

Shift key 28

slot

MagicGate Memory Stick™ 16

PC Card 15, 37

ventilation 16

Smart Connect 65

Software guide 66

speaker cable 53

speaker switch 31

speaker volume 31

speakers 17, 53

specifications 94, 97

switch

power 17, 24

speaker 31

System Hibernation mode 31, 48

System Idle mode 31, 47

System Suspend mode 31, 48

## T

technical specifications 94, 97

touchpad 32

troubleshooting 68

## U

USB 55

USB connector 16

USB floppy disk drive 56

USB mouse 55

## V

VAIO-Link 8, 26, 67

VAIO-Link Response Centre 67

ventilation 91

ventilation area 18

ventilation slot 16

video camera 64

## W

warnings 5

Windows key 28