

Sony Notebook User Guide

PCG-QR20

The WAVIO logo is rendered in a blue, stylized font. The 'W' is formed by a continuous wavy line, the 'A' is a solid circle, the 'I' is a vertical bar with a pointed top, and the 'O' is a solid circle.

Read this first

Notice

© 2001 Sony Corporation. All rights reserved.

This manual and the software described herein, in whole or in part, may not be reproduced, translated, or reduced to any machine-readable form without prior written approval.

Sony Corporation provides no warranty with regard to this manual, the software, or other information contained herein and hereby expressly disclaims any implied warranties or merchantability or fitness for any particular purpose with regard to this manual, the software or such other information. In no event shall Sony Corporation be liable for any incidental, consequential, or special damages, whether based on tort, contract, or otherwise, arising out of or in connection with this manual, the software, or other information contained herein or the use thereof.

Sony Corporation reserves the right to make any modification to this manual or the information contained herein at any time without notice. The software described herein is governed by the terms of a separate user license agreement.

Sony, DVgate, i.LINK™ and the i.LINK logo, JogDial™, PictureGear, Memory Stick™ and the Memory Stick logo, VAIO and the VAIO logo are trademarks of Sony Corporation. i.LINK™ is the name for the IEEE 1394-1995 standards and their revisions.

Microsoft®, Windows® and the Windows logo, Windows® Media and Outlook® are trademarks or registered trademarks of U.S. Microsoft Corporation in the U.S. and other countries.

Adobe®, Adobe® Acrobat® Reader, Adobe® Premiere® are trademarks of Adobe Systems Incorporated.

QuickTime and the QuickTime logo are trademarks used under license. QuickTime is registered in the U.S. and other countries.

RealPlayer is a trademark or registered trademark of RealNetworks, inc. in the U.S. and other countries.

PowerPanel is a trademark of U.S. Phoenix Technologies Corporation.

Norton Antivirus is a trademark of Symantec.

All other names of systems, products and services are trademarks of their respective owners. In the manual, the ™ or ® marks are not specified.

Specifications are subject to change without notice.

As an ENERGY STAR Partner, Sony has determined that this product meets the ENERGY STAR guidelines for energy efficiency.

The International ENERGY STAR Office Equipment Program is an international program that promotes energy saving through the use of computers and their office equipment. The program backs the development and dissemination of products with functions that effectively reduce energy consumption. It is an open system in which business proprietors can participate voluntarily. The targeted products are office equipment such as computers, displays, printers, facsimiles and copiers. Their standards and logos are uniform among participating nations.

ENERGY STAR is a U.S. registered mark.



Safety information

Owner's record

The model number and serial number are located on the bottom of your Sony notebook. Record the serial number in the space provided here. Refer to the model and serial number when you call VAIO-Link.

Serial number: _____

Model number:

PCG-731M

Warnings

General

- ❑ Opening the unit, for whatever reason, could lead to damages that are not covered by the guarantee.
- ❑ To avoid electrical shock, do not open the cabinet. Refer servicing to qualified personnel only.
- ❑ To prevent fire or shock hazard, do not expose your VAIO notebook to rain or moisture.
- ❑ Avoid using the modem during a storm.
- ❑ If reporting a gas leak, do not use a modem or telephone in the vicinity of the leak.
- ❑ To change the backup battery, please contact your nearest Sony Service Center.

Audio/video

- ❑ Audio and picture distortion may occur if this equipment is positioned in close proximity to any equipment emitting electromagnetic radiation.

Connectivity

- ❑ Never install modem or telephone wiring during a storm.
- ❑ Never install telephone jacks in wet locations unless the jack is specifically designed for wet locations.
- ❑ Use caution when installing or modifying telephone lines.
- ❑ Use your notebook only with the supplied AC adapter. To disconnect your notebook completely from mains voltage, unplug the AC adapter.
- ❑ Make sure that the socket outlet is easily accessible.
- ❑ Never touch uninsulated telephone wire or terminals unless the telephone line has been disconnected at the network interface.

Hard disk drive

The magnetic properties of some objects can have serious consequences for your hard disk drive. They can erase the data on the hard drive and cause the computer to malfunction. Do not place your computer near or on any products which emit magnetic fields, mainly:

- ❑ TV sets,
- ❑ Speakers,
- ❑ Magnets,
- ❑ Magnetic bracelets.

Optical disc drive

- ❑ The use of optical instruments with this product will increase eye hazard. As the laser beam used in this product is harmful to the eyes, do not attempt to disassemble the cabinet. Refer servicing to qualified personnel only.
- ❑ Danger - Visible and invisible laser radiation when open. Avoid direct exposure to beam.

Regulatory information

This product conforms to the following European Directives:

73/23/EEC (Low Voltage Directive)

89/336/EEC, 92/31/EEC (EMC Directives)

93/68/EEC (CE Marking Directive)

1999/5/EC (radio equipment and telecommunications terminal equipment Directive)



This product complies with EN 55022 Class B and EN 55024 for use in following areas: residential, commercial and light-industrial.

This product has been tested and found compliant with the limits set out in the EMC Directive for using connection cables shorter than 3 metres (9.8 feet).

The optical disc drive is classified as a CLASS 1 LASER PRODUCT and complies with the Laser Product Safety Standard EN 60825-1. Repair and maintenance only by authorized Sony technicians. Improper repairs and use can create safety hazards.



**CLASS 1
LASER PRODUCT
TO EN 60825-1**

Disposing of lithium ion batteries

Do not handle damaged or leaking lithium ion batteries. Dispose of promptly and properly at the battery's end-of-life.

Danger of explosion if the battery is incorrectly replaced. Replace only with the same or equivalent type recommended by the manufacturer. Discard used batteries according to the manufacturer's instructions.

The battery pack used in this device may present a fire or chemical burn hazard if mistreated. Do not disassemble, heat above 60°C (140°F) or incinerate.

Keep away from children.

Your notebook is equipped with an internal backup memory battery. If you need to change this battery, please contact VAIO-Link:

<http://www.vaio-link.com>

In some areas, the disposal of lithium ion batteries in household or business waste may be prohibited.

Use the public collection system.

Welcome

Congratulations on purchasing a Sony VAIO notebook. Sony has combined leading-edge technology in audio, video, computing and communications to provide you with state-of-the-art personal computing.

Here are just some of the features your VAIO notebook has to offer.

- ❑ **Exceptional performance** - Your PC includes a fast processor, a fast DVD-ROM and an internal modem.
- ❑ **Portability** - The rechargeable battery pack provides hours of use without AC power.
- ❑ **Sony audio and video quality** - A high-resolution LCD screen enables you to take advantage of today's advanced multimedia applications, games, and entertainment software.
- ❑ **Multimedia features** – Enjoy the speakers to listen to audio and video CDs.
- ❑ **Interconnectivity** – Your computer has Ethernet, Memory Stick™ and i.LINK™ functionalities. Memory Stick™ is Sony's universal storage medium. i.LINK™ is a bidirectional digital interface for exchanging data.
- ❑ **Windows®** - Your system includes the latest operating system from Microsoft.
- ❑ **Communications** - Access popular online services, send and receive e-mails, or browse the Internet.
- ❑ **Excellent customer support** - If you are experiencing any problems with your computer, please check the VAIO-Link website for a possible solution:
<http://www.vaio-link.com>
Before contacting VAIO-Link, you can try to solve the problem by reading the User Guide or the manuals and help files for the peripherals or software.

Documentation pack

Your Documentation Pack contains paper and online user guides on a Documentation CD-ROM.

Printed documentation

- ❑ A **Getting Started** brochure, where you will find a brief description of the items in the box, a quick guide to setting up your VAIO notebook, and a short list of specifications.
- ❑ A **Customer Guide**, where you will find all the basic information you need to start using your notebook;
- ❑ A **Regulatory and Safety Information** poster;
- ❑ Your **Sony Guarantee** conditions.

Online documentation

- 1 The Sony Notebook User Guide:
 - ❑ **Using Your Sony Notebook** shows you how to use the standard components of your system.
 - ❑ **Connecting Peripheral Devices** explains how you can add functionality by connecting various peripherals.
 - ❑ **Getting Help** explains the support options available to you, and offers basic troubleshooting tips.
 - ❑ **Precautions** provides facts and advice about using your notebook.
 - ❑ **Specifications** provides details on your computer, drivers and accessories.
- 2 Refer to your **Software Guide** for information on the bundled software and the Sony applications.
 - ❑ **About the Software** is a short description of the features of the software pre-installed on your system.
 - ❑ **Customizing your Notebook** explains how to set up your system and power management.
 - ❑ **Using the Product Recovery CD-ROMs** explains how to perform a system and application recovery.

- 3 Consult the **Online Help** files of the software you are using for detailed information on features and troubleshooting.
- 4 Refer to the Microsoft® **Quick Start** manual for more information on Windows®.

Your notebook and its accessories

The following items should be in the box:

1



2



3



4

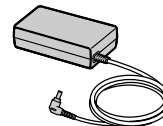

5



6

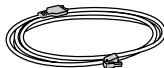

7



8

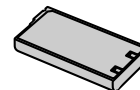

1	main unit	5	phone plug (country-specific)
2	product recovery CD-ROMs	6	phone cable
3	documentation pack	7	power cord
4	AC adapter	8	rechargeable battery pack

Ergonomic considerations

You will be using your notebook as a portable device in a variety of environments. Whenever possible, try and take account of the following ergonomic considerations to both stationary and portable environments:

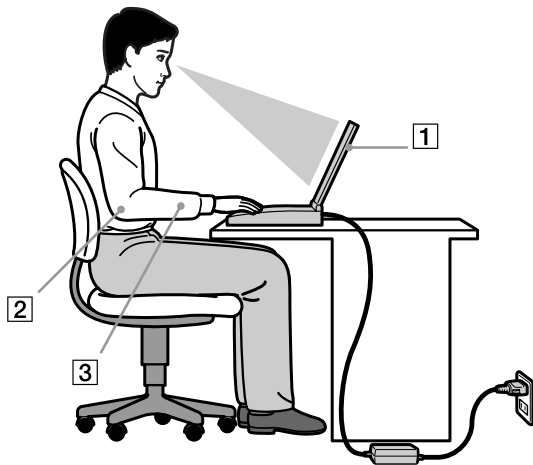

- ❑ **Positioning your computer** – Place the computer directly in front of you (1). Keep your forearms horizontal (2), with your wrists in a neutral, comfortable position (3) while using the keyboard, touchpad, or external mouse. Let your upper arms hang naturally at your sides. Have breaks during sessions with your computer. Excessive use of the computer may strain muscles or tendons.
- ❑ **Furniture and posture** – Sit in a chair with good back support. Adjust the level of the chair so your feet are flat on the floor. A footrest may make you more comfortable. Sit in a relaxed, upright posture and avoid slouching forward or leaning too far backwards.

- ❑ **Viewing angle of the computer's display** – Use the display's tilting feature to find the best position. You can reduce eye strain and muscle fatigue by adjusting the tilt of the display to the proper position. Adjust the brightness setting of the display as well.
- ❑ **Lighting** – Choose a location where windows and lights do not create glare or reflection on the display. Use indirect lighting to avoid bright spots being reflected on the display. You can also purchase accessories for your display that help reduce glare. Proper lighting adds to your comfort and work effectiveness.
- ❑ **Positioning an external display** – When using an external display, set the display at a comfortable viewing distance. Make sure the display screen is at eye level or slightly lower when you are sitting in front of the monitor.

Using your notebook

This section describes how to start using your computer and how to use your computer's internal and external devices.

Locating controls and connectors

Right

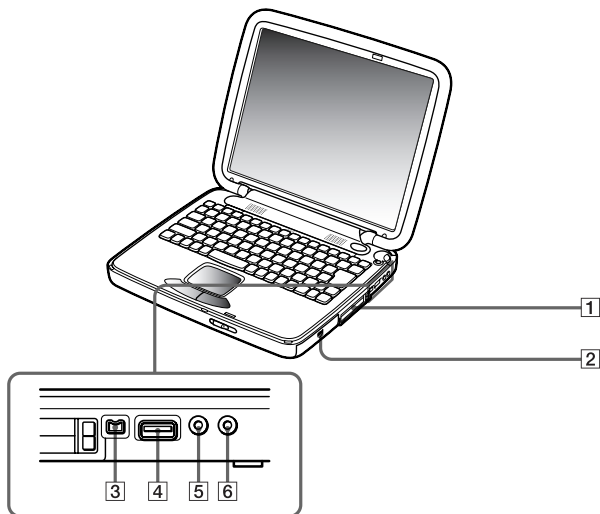

1	PC card slot	(page 33)	4	USB connector	(page 46)
2	battery bay	(page 18)	5	headphone connector	(page 44)
3	i.LINK™ connector	(page 49)	6	microphone connector	(page 45)

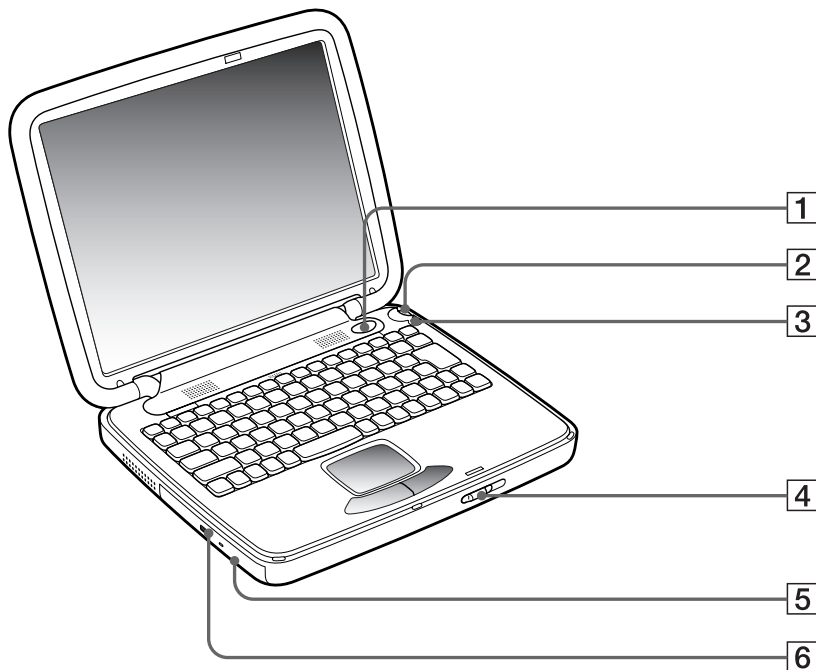
Left

1	power button	(page 20)	4	LCD lock lever	(page 22)
2	Jog Dial	(page 30)	5	manual eject hole	(page 32)
3	back button	(page 30)	6	DVD-ROM drive	(page 32)

 There is a ventilation slot located next to the DVD-ROM drive.

Front

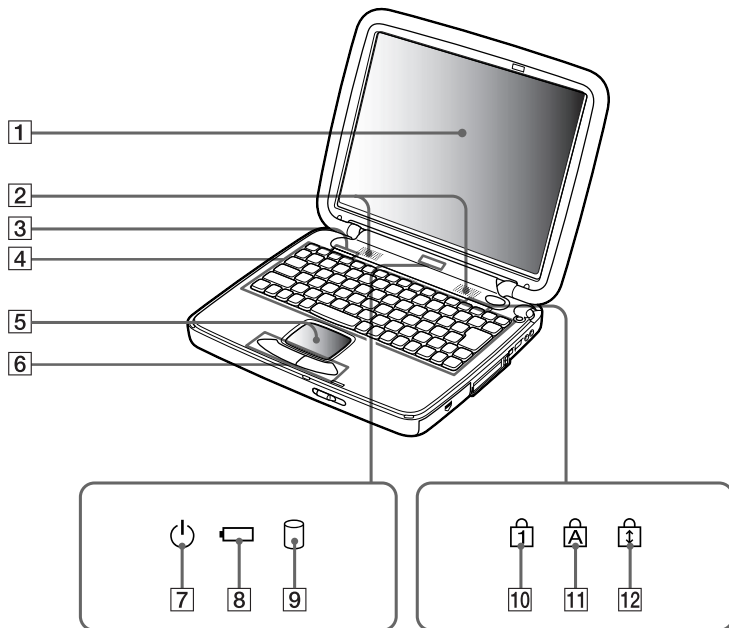

1	LCD screen	(page 70)	7	power indicator	(page 26)
2	speakers		8	battery indicator	(page 26)
3	ID label		9	hard disk drive indicator	(page 26)
4	keyboard	(page 24)	10	Num Lock indicator	(page 26)
5	touchpad	(page 29)	11	Caps Lock indicator	(page 26)
6	left and right buttons	(page 29)	12	Scroll Lock indicator	(page 26)

Back

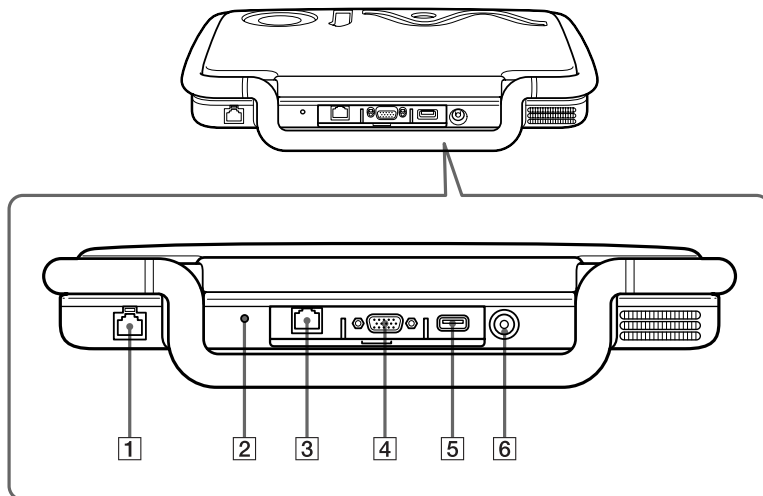

1	phone line jack	(page 37)
2	reset switch	
3	Ethernet connector	(page 51)
4	monitor connector	(page 41)
5	USB connector	(page 46)
6	DC In connector	(page 50)

 AC adapter mains connector and power cord: hazardous voltage, according to EN 60950.

All other connectors for this notebook are SELV (Safety Extra Low Voltage), according to EN 60950.

Phone cables and connectors are TNV (Telecommunication Network Voltage), according to EN 60950.

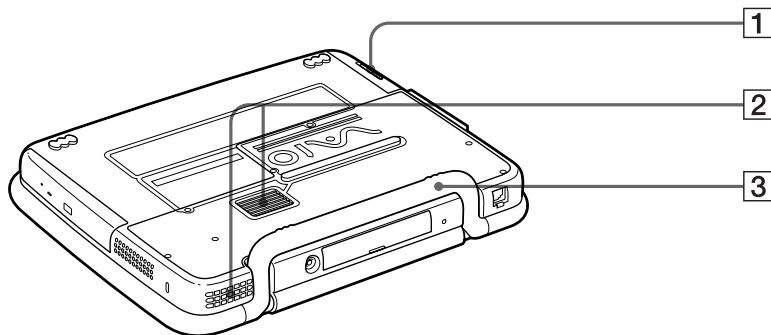
Bottom

1	battery pack release lever	(page 18)
2	ventilation slot	
3	handle	(page 22)

Connecting a power source

You can use either an AC adapter or a rechargeable battery pack as a power source.

Using the AC adapter

To use the AC adapter, proceed as follows:

- 1 Make sure the handle is folded into the back of your notebook.
- 2 Plug the cable attached to the AC adapter (1) into the DC In connector (2) on the computer.
- 3 Plug one end of the power cord (3) into the AC adapter.
- 4 Plug the other end of the power cord into an AC outlet.

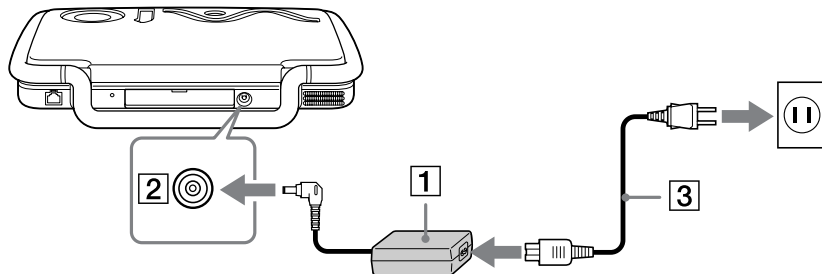

 Use your notebook only with the supplied AC adapter.

To disconnect your notebook completely from mains voltage, unplug the AC adapter.

Make sure that the socket outlet is easily accessible.

Using the battery pack

You can use a battery pack as a source of power.
The battery pack supplied with your computer is not fully charged at the time of purchase.

Inserting the battery pack

To insert the battery pack, proceed as follows:

- 1 Open the cover of the battery bay (1).
- 2 Insert the battery pack (2) into the battery bay, with the text facing upwards. Make sure you leave the end of the transparent strip outside the battery bay when inserting the battery. The strip enables you to remove the battery later on.

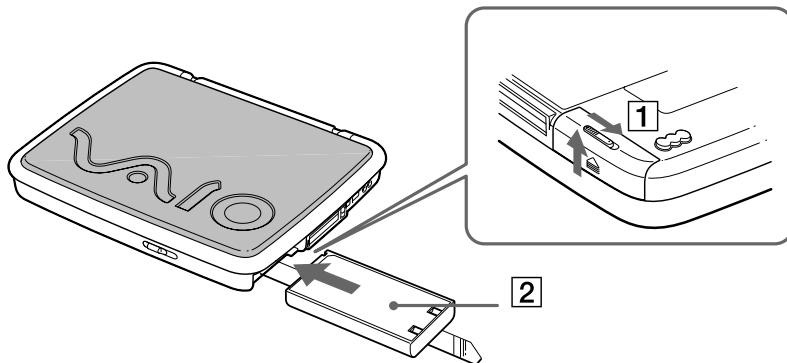

- 3 Close the cover of the battery bay until it clicks.

 When the computer is directly connected to AC power and has a battery pack inserted in the battery bay, it uses power from the AC outlet.

Charging the battery pack

To charge the battery pack, proceed as follows:

- 1 Connect the AC adapter to the computer.
- 2 Insert the battery pack.

The computer automatically charges the battery (the battery indicator light flashes in a double blink pattern as the battery charges). When the battery is 85% full, the battery indicator light turns off. This process takes approximately one and a half hours with the notebook's power on. To charge the battery completely, continue charging for an additional hour.

<i>Battery indicator light status</i>	<i>Meaning</i>
---------------------------------------	----------------

<i>Battery indicator light status</i>	<i>Meaning</i>
on	The computer is using battery power
single blink	The battery is running out of power
double blink	The battery is charging
off	The computer is using AC power



When the battery is running out of power, both the battery and power indicators blink.

Keep the battery pack in the computer while it is directly connected to AC power. The battery pack continues to charge while you are using the computer.

If the battery level falls to below 10%, you should either attach the AC adapter to recharge the battery or shut down your computer and insert a fully charged battery.

You can extend battery life by changing the power management modes in the PowerPanel utility.

The battery pack supplied with your computer is a lithium ion battery and can be recharged any time. Charging a partially discharged battery does not affect battery life.

The battery indicator light is on while you use the battery pack as a power source. When the battery life is nearly depleted, the battery indicator starts flashing.

For some software applications and some peripheral devices, your computer may not enter **Hibernate** mode when battery life is low. To avoid loss of data when using battery power, you should save your data frequently and manually activate a power management mode, such as **Standby** or **Hibernate**.

When the computer is directly connected to AC power and has a battery pack inserted in the battery bay, it uses power from the AC outlet.

Removing the battery pack

To remove the battery pack, proceed as follows:

- 1 Turn off the computer.
- 2 Open the cover of the battery bay.
- 3 Pull the transparent strip to remove the battery.
- 4 Close the cover of the battery bay.

 You may lose data if you remove the battery pack while the computer is on and not connected to the AC adapter, or if you remove the battery while the computer is in **Standby** mode.

Starting your notebook

To start your computer, proceed as follows:

- 1 Make sure the handle is folded into the back of the notebook.
- 2 Slide the LCD lock lever (1) in the direction of the arrow, and lift the cover.

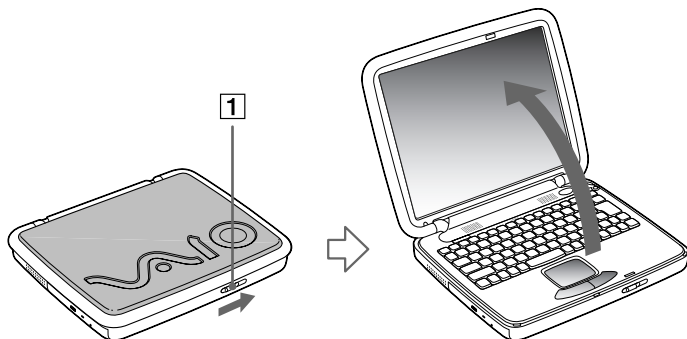

- 3 Press the power button (2) of the computer until the power indicator (3) light turns on.

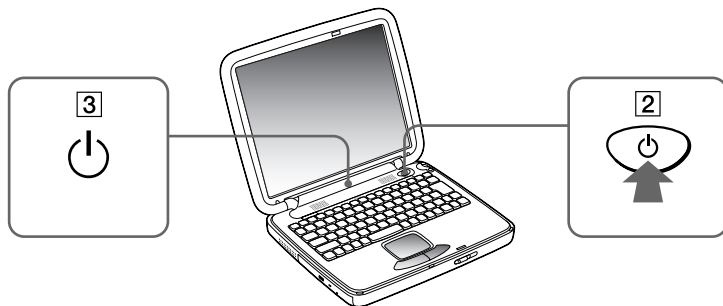

- 4 If necessary, press **<Fn>+<F5>** to adjust the brightness control on the LCD display. To increase the brightness, use the up or right arrow keys. To decrease the brightness, use the down or left arrow keys.

 If you press the power button for more than four seconds, the computer will turn off.

- ! Keep magnetic objects away from your notebook. If they are close to your touchpad, your computer enters LCD/Video Standby or **Hibernate** mode, assuming that the LCD display is off.

Carrying your notebook

If you are going to carry your notebook by the handle, make sure you:

- ❑ remove all cables,
- ❑ lock the LCD panel by sliding the LCD lock lever,
- ❑ carry it carefully.

Shutting down your notebook

It is important that you shut down your computer properly in order not to lose unsaved data.

To shut down your computer, proceed as follows:

- 1 Click the **Start** button on the Windows® taskbar.
- 2 Click **Shut Down**.
The **Shut Down Windows** dialog box appears.
- 3 Select **Shut down**.
- 4 Click **OK**.
- 5 Wait for your computer to turn off automatically.
The power indicator turns off.
- 6 Turn off any peripheral connected to your computer.

 Respond to any prompts warning you to save documents.

If you are unable to shut down your computer:

- Close all software in use.
- Remove the PC Card if inserted. To do so, double-click the **Unplug or Eject Hardware** icon in the taskbar. Select the hardware you want to unplug and click **Stop**.
- Disconnect any USB devices.

- Then press the <Ctrl>+<Alt>+<Delete> keys at the same time to restart the computer.

If this does not work, you can press the power button for more than four seconds. This will shut down the computer. This operation may result in data loss.

During a period of inactivity, you can conserve battery life by using **Standby** mode.

Registering your notebook

You can take advantage of Sony's commitment to quality customer support and receive the following benefits by registering your computer:

- ❑ **VAIO-Link** – If you are experiencing any problems with your computer, you can check the VAIO-Link website for a possible solution:
<http://www.vaio-link.com>
- ❑ **Guarantee** – Protect your investment. See the Guarantee sheet for the terms and conditions and refer to your Customer Service Guide for more information.

To register your Sony notebook, proceed as follows:

- 1 Click on the **Welcome** button on your desktop,
- 2 Click **Next**,
- 3 Click **Internet**,
- 4 Fill in your Registration card fields,
- 5 Scroll down to the bottom of the form and click **Send**,
- 6 Click **OK**.

 You must connect your phone line before using any online services, including the online registration service.

To access the online Registration Web page, you must have a connection to the Internet.

Using the keyboard

Your keyboard is very similar to a desktop computer's, but there are additional keys that perform specific notebook-related tasks.

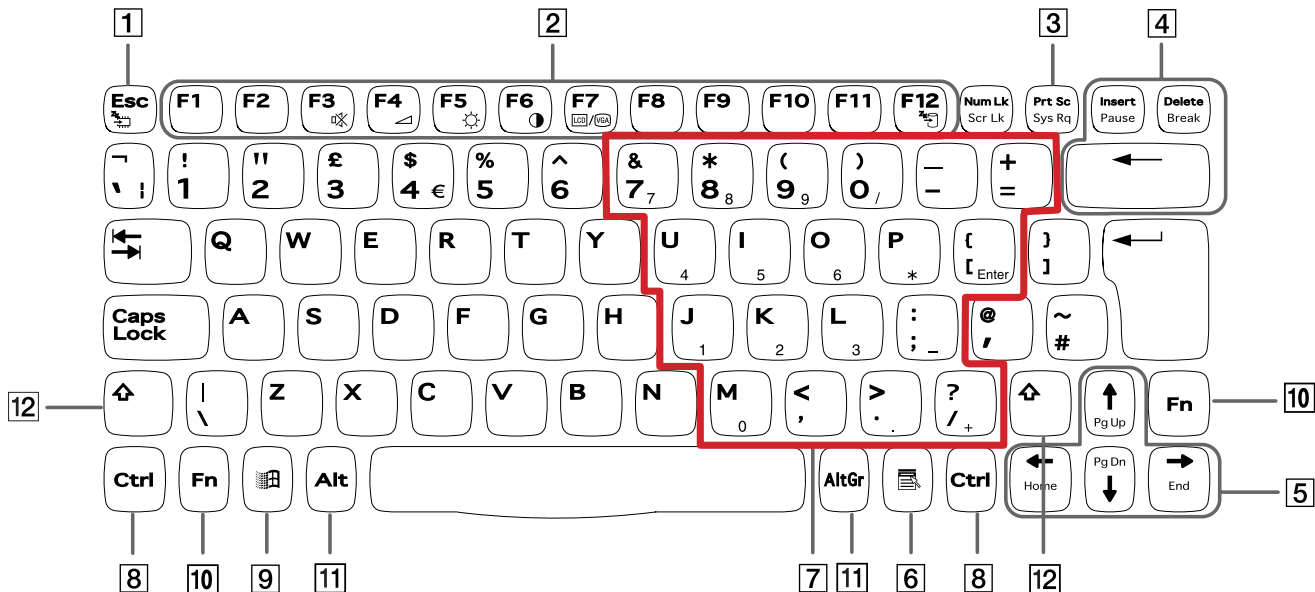



Keys



Descriptions





Escape key (1)

The <Esc> (Escape) key is used to cancel commands.

Keys	Descriptions
Function keys (2)	The twelve function keys along the top of the keyboard are used to perform designated tasks. For example, in many applications, <F1> is the Help key. The task associated with each function key may vary from one application to the other.
Print Screen key (3)	The <Print Screen> key takes an electronic snapshot of the screen and moves it to the Windows Clipboard. You can then paste the screenshot into a document and print it.
Correction keys (4)	The <Insert> , <Back Space> and <Delete> keys enable you to make corrections.
Navigation keys (5)	These keys enable you to move the cursor on the screen.
Application key (6) 	The Application key displays a shortcut menu; pressing this key is equivalent to clicking the right mouse button.
Numeric keypad area (7)	Contains the keys found on a typical calculator. Use the numeric keypad area to type numbers or to perform mathematical calculations such as addition and subtraction. Note that you must press the <Num Lock> key to activate the numeric keypad. When you do so, the Num Lock light illuminates.
Operator keys (8-11-12)	Several keys are always used with at least one other key: <Ctrl> , <Alt> , and <Shift> . When held down with another key, the <Ctrl> (Control) and <Alt> (Alternate) keys offer another way to execute commands. For example, in many applications, instead of choosing the Save command from a menu, you can hold down <Ctrl> and press S (referred to as Ctrl+S). The <Shift> key is used to produce capital letters or special symbols such as @ and \$.
Windows® key (9) 	The key with the Windows® logo displays the Windows® Start menu; it is equivalent to clicking the Start button on the taskbar.
Fn key (10)	The <Fn> key is used in combination with other keys to execute commands.









Indicators

Indicator	Functions
Power 	<p>Power on: lights green.</p> <p>Standby mode: flashes amber.</p> <p>Hibernate mode: turns off</p>
Battery 	Indicates the status of the battery inserted in your notebook.















Light	On	Off
 hard disk	Data is read from or written to the hard drive. Do not enter Standby mode or turn off the computer when this indicator light is on.	The hard drive is not being accessed.
 Num Lock	Turns on when the number keys in the numeric keypad are active.	Turns off when the alphanumeric character keys in the keypad area are active.
 Caps Lock	Turns on when the letters appear in uppercase as you type. The <Shift> key lowers the case of typed letters when Caps Lock is on.	Turns off when the letters appear in lowercase as you type (unless you hold down the <Shift> key).
 Scroll Lock	Turns on when the screen scrolls differently (depends on the application, no effect in many applications.)	Turns off when the information moves across the display normally.

Combinations and functions with the Windows® key

Combinations Functions

 + F1	Displays Windows Help .
 + Tab	Switches the selected button on the taskbar.
 + E	Displays Windows Explorer .
 + F	Displays the Search Results window to find a file or folder. This is equivalent to selecting Search and then For files or Folders from the Start menu.
 + Ctrl + F	Displays the Search Results - Computers window where you can locate other computers.
 + M	Minimizes all displayed windows.
Shift +  + M	Returns all minimized windows to their previous size.
 + R	Displays the Run window. This is equivalent to selecting Run from the Start menu.
Fn +  + Insert	Displays the System Properties window. This is equivalent to double-clicking the System icon in the Control Panel .

Combinations and functions with the <Fn> key

Combinations/ Feature	Functions
Fn +  (ESC): Standby	Puts the system into Standby mode, a power management state. To return the system to the active state, press any key.
Fn +  (F3): speaker switch	Toggles the built-in speaker on and off.
Fn +  (F4): speaker volume	Adjusts the built-in speaker volume. To increase volume, press <Fn>+<F4> and then  or  To decrease volume, press <Fn>+<F4> and then  or 
Fn +  (F5): brightness control	Adjusts the brightness of the LCD. To increase light intensity, press <Fn>+<F5> and then  or  To decrease light intensity, press <Fn>+<F5> and then  or 
Fn +  (F7): switch to the external display	Toggles between the LCD, external display (connected to the monitor connector) and both LCD and external display.
Fn +  (F12): Hibernate	Provides for the lowest level of power consumption. When you execute this command, the states of the system and of the peripheral devices are written to the hard disk and the system power is turned off. To return the system to its original state, use the power switch to turn on the power.
Fn + D: Video Standby	Darkens the LCD in order to save power. To turn the LCD back on, press any key.

 Some functions are not available until Windows® is launched.

Using the touchpad

The keyboard contains a cursor-pointing device, your touchpad (1). You can point to, select, drag, and scroll objects on the screen using the built-in touchpad.

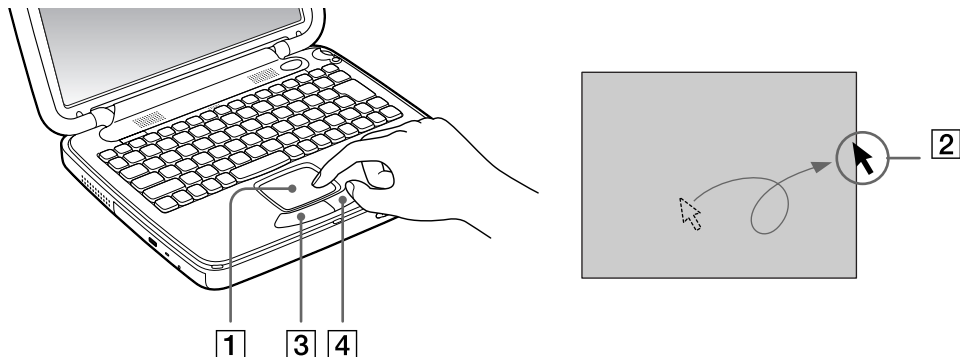

Function

Action

point	Slide one finger on the touchpad to place the pointer (2) on an item or object.
click	Press the left button (3) once.
double-click	Press the left button twice.
right-click	Press the right (4) button once. In many applications, this action displays a shortcut menu.
drag	Slide one finger while pressing the left button.
scroll	Move your finger along the right edge of the touchpad to scroll vertically. Move your finger along the bottom to scroll horizontally. (The scroll function is available only with applications that support a touchpad scroll feature.)

Using the Jog Dial

Your computer is equipped with a **Jog Dial** on the right side of your computer. You can turn and/or press the Jog Dial to scroll the window, select a software, adjust the internal speaker volume, etc.

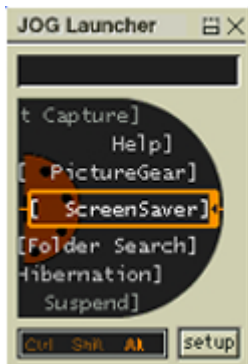

The Jog Dial window is always displayed on the screen. This window has two modes: Launcher mode or Guide mode.

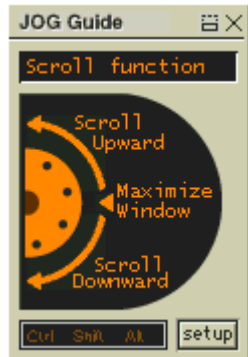

The Jog Dial window is in Launcher mode until you start an application or the Jog Dial window becomes active. When an arrow appears next to an item in the Jog Dial window, you can display a submenu for that item by selecting it and pressing the Jog Dial.



The Jog Dial window switches to Guide mode when you start an application and its window becomes active. Depending on the application, the Jog Dial window displays different commands that you can select or execute by rotating or pressing the Jog Dial.

 You can adjust the size of the Jog Dial window or close it. To display the Jog Dial window, double-click  or  on the taskbar.

To use the Jog Dial in Launcher mode, proceed as follows:

- 1 Click the **Jog Dial** window or press the Jog Dial while pressing the **<Ctrl>** key to switch to Launcher mode.
- 2 Turn the Jog Dial to select an item, then press the Jog Dial.
The Jog Dial window switches to Guide mode, and shows the Jog Dial function.

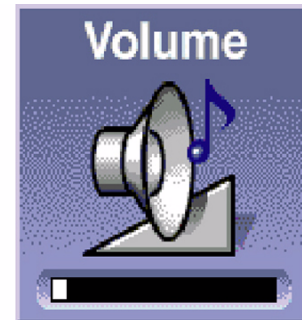
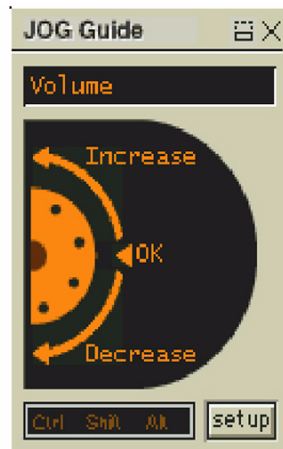

- 3 Turn or press the Jog Dial to use the Jog Dial function.
- 4 To select another item, switch to Launcher mode and repeat this procedure.
- 5 Use the Back button underneath the Jog Dial to go back to the previous state of the Jog Dial window.

Using the DVD-ROM drive

Your computer is equipped with a DVD-ROM drive.

To insert a DVD-ROM, proceed as follows:

- 1 Turn on the computer.
- 2 Press the eject button (1) to open the DVD-ROM drive. The tray slides out.
- 3 Place a DVD-ROM in the tray with the label side facing up.
- 4 Close the tray by pushing it gently.

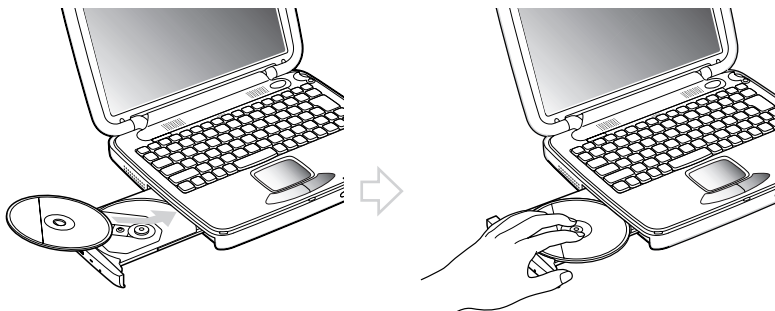

 When the computer is in **Standby** or **Hibernate** mode, you cannot insert or remove a disc.

Be sure to seat the disc firmly over the drive hub fingers. If you do not seat the disc firmly, you could damage your disc drive and you may not be able to open the tray.

When you have finished using a disc, wait until the LED indicator turns off and then press the eject button to remove the disc.

If the disc does not come out when you press the eject button, go to **Windows Explorer**. Select the drive, click the right button of your mouse and select **Eject**. If it still doesn't work, turn off the computer and insert a thin, pointed object into the manual eject hole.

Using PC cards

Your computer includes two PC Card slots. PC Cards allow you to connect portable external devices.

Inserting a PC Card

To insert a PC Card, proceed as follows:

- 1 Push the release button.
The release button (1) pops out.
- 2 Push the release button again.
The PC Card slot protector comes out.
- 3 Insert the PC Card into the PC Card slot (2) with the front label facing upwards.
- 4 Gently push the PC Card slot into the connector.
The PC Card is automatically detected by your system.
The **Unplug or Eject Hardware** icon appears in the taskbar.

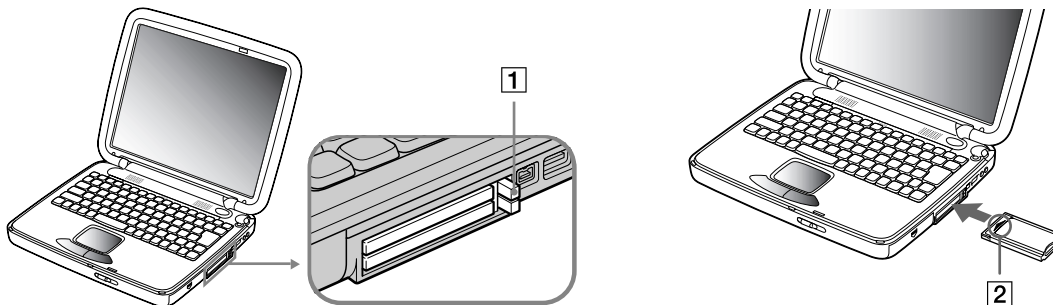

 Some devices may not function properly if you repeat Returning to Normal mode from **Standby** mode or **Hibernate** mode. The computer will return to its original state if you restart it.

Some PC Cards may require you to disable idle devices when using the PC Card. You can use Sony Notebook Setup to disable devices.

Be sure to use the most recent software driver provided by the PC Card manufacturer.

If an "!" mark appears on the Device Manager tab in the System Properties dialog box, remove the software driver and then reinstall it.

You do not need to shut down the computer before inserting or removing a PC Card.

Do not force a PC Card into the slot. It may damage the connector pins. If you have difficulty inserting a PC Card, check that you are inserting the PC Card in the correct direction. See the manual supplied with your PC Card for more information on use.

For some PC Cards, if you alternate between Normal power operation and **Standby** or **Hibernate** power management modes while the card is inserted, you may find that a device connected to your system is not recognized. Reboot your system to correct the problem.

Removing a PC Card

Follow the steps below to remove the PC card while your computer is on. If it is not removed safely, your system may not work properly. If your computer is switched off, skip steps 1 to 7.

To remove a PC Card, proceed as follows:

- 1 Double-click the **Unplug or Eject Hardware** icon in the taskbar.
The **Unplug or Eject Hardware** dialog box appears.
- 2 Select the hardware you want to unplug.
- 3 Click **Stop**.
- 4 In the **Stop a Hardware device** dialog box, confirm that the device can be safely removed from the system.
- 5 Click **OK**.
You get the message that it is safe to remove the device.
- 6 Click **OK**.
- 7 Click **Close**.
- 8 Press the PC Card release button so that it pops out.

- 9 Push the PC Card release button again to eject the card.
- 10 Gently grasp the card and pull it out.
- 11 If the PC Card release button is still out, push it in again.



If you unplug the PC Card from the computer when this is still turned on, your system might crash and you might lose data that you didn't save before.

Before you remove the PC Card, click the PC Card icon in the taskbar and close the card. While the card is inserted, your computer may not enter the **Hibernate** power management mode. It may enter **Standby** mode. You are recommended to remove the card when your computer enters **Hibernate** mode by pressing <Fn> + <F12> keys or by using the PowerPanel Utility, and when it is set to enter **Hibernate** automatically while using a battery as the source of power.

You may not be able to use some PC Cards or some functions within the PC Card with this computer.

Using the Memory Stick™

This compact, portable, and versatile recording medium has a data capacity exceeding that of a floppy disk. The Memory Stick™ is specially designed for exchanging and sharing digital data with compatible products. Because it is removable, it can be used for external data storage.



You need an optional PC Card adapter to use this function.

When the Memory Stick™ erasure prevention switch is set to LOCK, data cannot be recorded or erased.

You can enjoy still images that you have recorded with a Memory Stick™-compatible video camera recorder or a digital still camera.

Before using Memory Sticks™, you should back up important data.

To avoid damaging data:

- Do not remove a Memory Stick™ or turn off the power while the access light is on.
- Do not use Memory Sticks™ in locations that are subject to static electricity or electrical noise.
- Do not touch the Memory Stick™ connector with your fingers or metallic objects.
- Do not attach labels other than the supplied label to a Memory Stick™.
- Do not bend, drop, or apply strong shock to Memory Sticks™.

- Do not disassemble or modify Memory Sticks™.
 - Do not allow Memory Sticks™ to get wet.
 - Do not use or store Memory Sticks™ in a location that is subject to extremely high temperatures, such as in a car parked in the sun, direct sunlight.
- To prolong the life of Memory Sticks™, use the supplied storage case.

Inserting a Memory Stick™

To insert a Memory Stick™, proceed as follows:

- 1 Once you have stored your data from your digital device, insert the Memory Stick™ into the optional PC Card adapter.
- 2 Push the release button.
The release button pops out.
- 3 Push the release button again.
The PC Card slot comes out.
- 4 Pull the PC Card slot out of the connector.
- 5 Insert the PC Card adapter into the connector on your computer (label facing up) and push it gently.
- 6 The Memory Stick™ is automatically detected by your system and appears in your **My Computer** window as a local drive, under the appropriate letter (depending on the configuration of your computer).
When your Memory Stick™ is detected, the **Unplug or Eject Hardware** icon appears in the taskbar.

! Hold the Memory Stick™ with the arrow pointing in the correct direction when you insert it into the slot. To avoid damaging the computer or the Memory Stick™, do not force the Memory Stick™ into the slot if it does not insert smoothly.

Removing a Memory Stick™

To remove a Memory Stick™, proceed as follows:

- 1 Double-click the **Unplug or Eject Hardware** icon in the taskbar. The **Unplug or Eject Hardware** dialog box appears.
- 2 Select the hardware you want to unplug.
- 3 Click **Stop**.
- 4 In the **Stop a Hardware device** dialog box, confirm that the device can be safely removed from the system.
- 5 Click **OK**.
You get a message that it is safe to remove the device.
- 6 Click **OK**.
- 7 Click **Close**.
- 8 Press the PC Card release button so that it pops out.
- 9 Push the PC Card release button again to eject the Memory Stick™.
- 10 Gently grasp the Memory Stick™ and pull it out.

 You can skip steps 1-7 if your notebook is off.

Using the modem

Your notebook is equipped with an internal modem.

You need to connect a phone line to take advantage of online services and the Internet, to register your computer and software online, and to contact VAIO-Link.

To connect a phone line, proceed as follows:

- 1 Plug one end of the phone cable (1) into the phone line jack (2) on the computer.

- 2 Plug the other end into the wall jack (3).

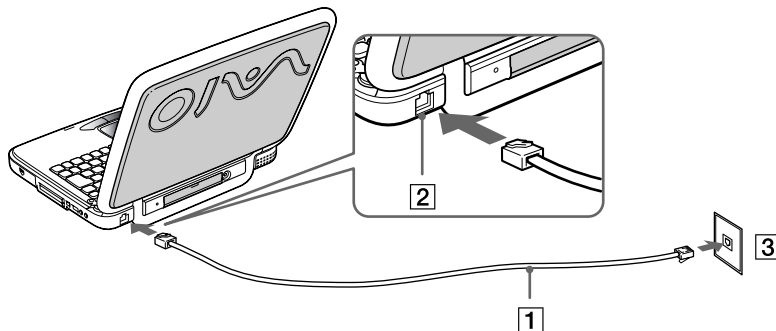

-  A country-specific phone plug is supplied with your VAIO notebook, allowing you to plug the phone line into the wall jack. Your computer cannot be connected to a coin-operated telephone, and may not work with multiple phone lines or a private branch exchange (PBX). If you connect the modem to a parallel connected phone line, the modem or the other connected device may not function properly. Some of these connections may result in excess electrical current and could cause a malfunction in the internal modem.
- Phone cable and connectors are TNV (Telecommunications Network Voltage), according to EN60950.
- Only DTMP (Dual Tone Multi Frequency) signalling (tone dialling) is supported.

Using power saving modes

When you use a battery as the source of power for your computer, you can take advantage of power management settings to conserve battery life. In addition to the normal operating mode, which allows you to turn off specific devices, your computer has two distinct power saving modes: **Standby** and **Hibernate**. When using battery power, you should be aware that the computer automatically enters **Hibernate** mode when the remaining battery charge drops below 7 percent, regardless of the power management setting you select.

-  If the battery level falls to below 10 percent, you should either attach the AC adapter to recharge the battery, or shut down your computer and insert a fully charged battery.

Using Normal mode

This is the normal state of your computer when it is in use. The green power indicator light is on in this mode. To save power, you can turn off a specific device such as the LCD or the hard disk.

Using Standby mode

The computer saves the current state of the system in RAM and switches off power to the CPU. The amber power light flashes in this mode.

To activate **Standby** mode, proceed as follows:

Press **<Fn>+<Esc>**.

You can also use the PowerPanel utility to enter **Standby** mode.

To return to Normal mode, proceed as follows:

Press any key.



If you press the power button for more than four seconds, the computer will switch off automatically.

When the computer is in **Standby** mode, you cannot insert a disc.

Standby requires less time than **Hibernate** to be activated or to return to Normal mode.

Standby uses more power than **Hibernate**.

Using Hibernate mode

The state of the system is saved on the hard disk and power is turned off. The power indicator light is off in this mode.

To activate **Hibernate** mode, proceed as follows:

Press **<Fn>+<F12>**,

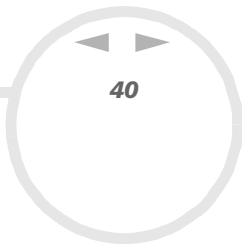

Or

Press the power button,

Or

Use the PowerPanel utility.

To return to Normal mode, proceed as follows:

Turn on the computer by pressing the power button. The computer returns to its previous state.

 When the computer is in **Hibernate** mode, you cannot insert a disc.

Hibernate mode requires more time than **Standby** mode to be activated or to return to Normal mode.

Hibernate mode uses less power than **Standby** mode.

Connecting peripheral devices

You can add functionality to your computer by connecting or using any of these peripherals.

Connecting an external display ([page 41](#))

Connecting external speakers ([page 44](#))

Connecting an external microphone ([page 45](#))

Connecting a Universal Serial Bus (USB) device ([page 46](#))

Connecting a printer ([page 48](#))

Connecting an i.LINK™ device ([page 49](#))

Connecting to a network (LAN) ([page 51](#))

 Before you connect peripherals, turn off the computer and all peripherals.

Connect the power cord only after connecting all cables.

Turn on the computer only after turning on all peripherals.

Connecting an external display

You can connect an external display to your notebook. For example, you can use your computer with the following devices:

Computer display (monitor);

Projector.

 Turn off your computer and the peripherals, unplug the AC adapter and the power cord before connecting the external display.

Connect the power cord after connecting all other cables.

Turn on the peripherals, then turn on your computer.

Connected external displays are used as second screens.

Make sure the handle is folded into the back of your computer.

Connecting a computer display

To connect a computer display, proceed as follows:

- 1 Make sure the handle is folded into the back of the computer.
- 2 Plug the display cable (1) into the monitor connector (2) on the computer.
- 3 If applicable, plug one end of the display's power cord (3) into the display, and the other end into an AC outlet.

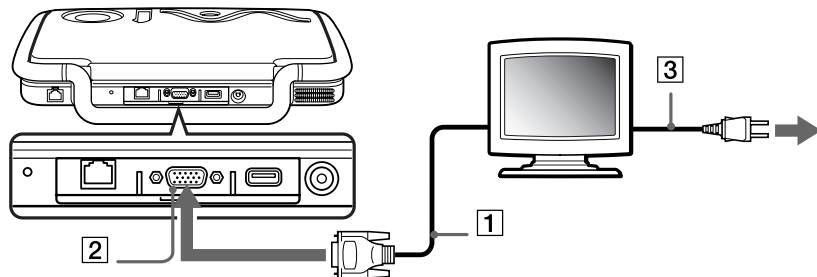

Connecting a projector

You can use a projector as an external display, such as the Sony LCD Projector.

To connect a projector, proceed as follows:

- 1 Make sure the handle is folded into the back of the computer.
- 2 Plug the RGB signal cable (1) into the monitor connector identified by the I/O symbol.
- 3 Plug the audio cable (2) into the headphone connector identified by the  symbol.
- 4 Plug the power cord of the projector into an AC outlet.

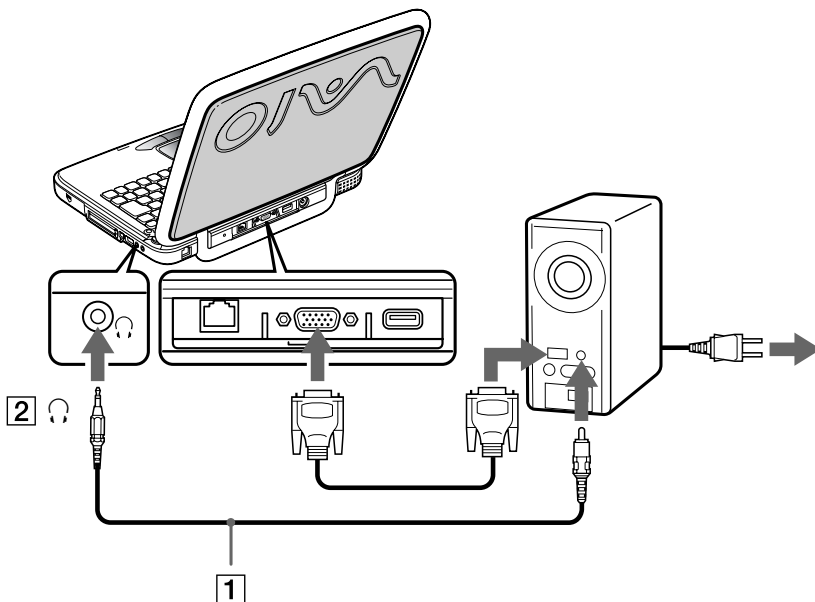



Connecting external speakers

You can enhance the sound quality of your computer by connecting external speakers.

To connect external speakers, proceed as follows:

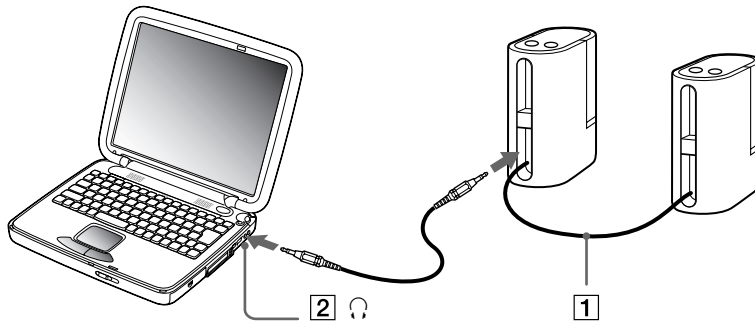
- 1 Plug the speaker cable (1) into the headphone connector (2).
- 2 Plug the other end of the speaker cable into the external speaker.
- 3 Turn down the volume of the speakers before you turn them on.



 Make sure your speakers are designed for computer use.

Do not place diskettes on the speakers; their magnetic field may damage the data on the diskettes.

Connecting an external microphone

Your VAIO notebook does not contain an internal microphone. If you need to use a sound input device, for example to chat on the Internet, you need to plug in an external microphone.

To connect an external microphone, proceed as follows:

- 1 Insert the microphone cable into the microphone connector on your notebook (1), identified by the  symbol (2).

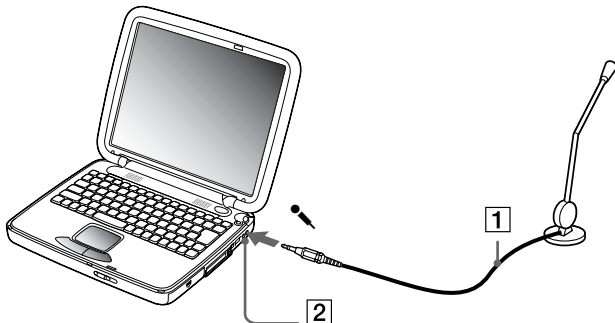

 Make sure your microphone is designed for computer use.

Connecting a Universal Serial Bus (USB) device

You can connect a USB device, for example, a mouse or a floppy disk drive, to your computer.

Connecting a USB mouse

To connect a USB mouse, proceed as follows:

Plug the USB mouse cable into the USB connector.

Your USB mouse is ready for use.

 You do not need to shut down the computer before connecting or disconnecting a USB peripheral.

The USB mouse software driver of PCGA-UMS1 is preinstalled on your notebook, therefore, you only need to plug the USB mouse into the USB connector and you can start working.

You may need to install software (device drivers) supplied with your USB device before using the USB device.

You cannot use a PS/2 style mouse.

Connecting a USB floppy disk drive

You can connect a floppy disk drive to the USB connector on your computer.

Connecting the floppy disk drive

To connect the floppy disk drive, proceed as follows:

Plug the floppy disk drive cable into the USB connector identified by the  symbol. The VAIO logo on the disk drive should be facing upwards.

Inserting a diskette

To insert a disk, proceed as follows:

- 1 Hold the diskette with the label side facing up.
- 2 Gently push the diskette into the drive until it clicks into place.

Removing a diskette

To remove a diskette, proceed as follows:

When you finish using the diskette, wait until the LED indicator turns off and then press the eject button to remove the diskette.

 Before pressing the eject button, make sure that the LED indicator is turned off.

If the diskette does not come out by pressing the eject button, disconnect the floppy disk drive from the computer.

! Do not press the eject button while the LED indicator is on. It may damage the diskette.

Removing the floppy disk drive

To remove the floppy disk drive, proceed as follows:

- If your computer is on, wait until the LED indicator turns off and then unplug the USB cable from the computer. If the floppy disk drive is not removed properly, your system may crash and you may lose data that you did not save before.
- If your computer is off, you can directly unplug the USB cable from the computer.

 To carry your floppy disk drive when you have finished using it, fold the floppy disk cable into the compartment on the side of the floppy disk drive.

Connecting a printer

You can connect a USB printer, assuming it is compatible with your version of Windows®, to your computer.

To connect a printer using the USB connector, proceed as follows:

- 1 Make sure the handle is folded into the back of the notebook.
- 2 Plug an optional USB printer cable (1) into the USB connector (2) identified by the  symbol on your computer and printer.
- 3 Plug the printer (3) power cord into an AC outlet.

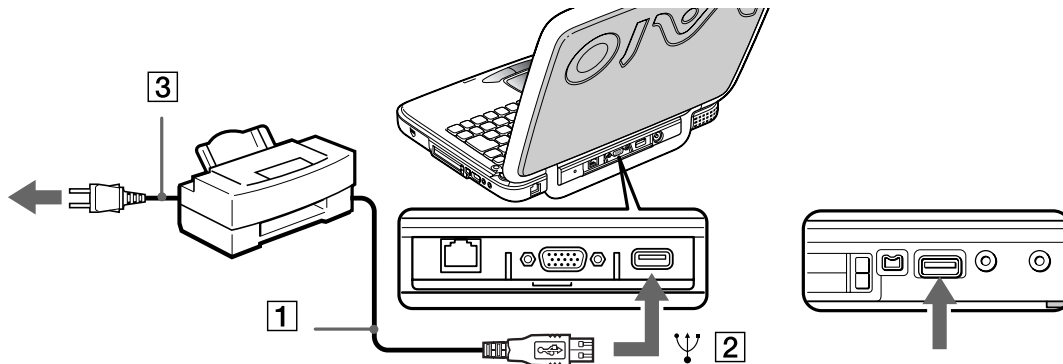

Connecting an i.LINK™ device

Your computer includes an i.LINK™ (IEEE1394) connector, which you can use to connect to an i.LINK™ device such as a digital video camera recorder or to connect two VAIO notebooks in order to copy, delete or edit files.

The i.LINK™ connector of your notebook does not supply power to external devices generally powered by i.LINK™ connectors.

The i.LINK™ connector supports transfer rates up to 400 Mbps; however, the actual transfer rate depends on the transfer rate of the external device.

i.LINK™ cables compatible with your VAIO notebook include cables with the following part numbers: VMC-IL4415 (a 1.5 meter cable with a 4-pin connector at each end), VMC-IL4408Series (a 0.8 meter cable with a 4-pin connector at each end).

The software limits the use of more than 1 digital video camera recorder or i.LINK™ device at the same time.

An i.LINK™ connection with other compatible devices is not fully guaranteed.

The i.LINK™ connection varies depending on the software applications, operating system and i.LINK™ compatible devices you use. Refer to the documentation that came with your software for more information.

You are strongly advised to use only Sony i.LINK™ cables, as using other brands may cause problems with the i.LINK™ devices.

Connecting a digital video camera recorder

To connect a digital video camera recorder, proceed as follows:

- 1 Plug one end of the i.LINK™ cable (1) into the i.LINK™ connector (2) of the computer and the other end into the DV Out connector (3) on the digital video camera recorder.

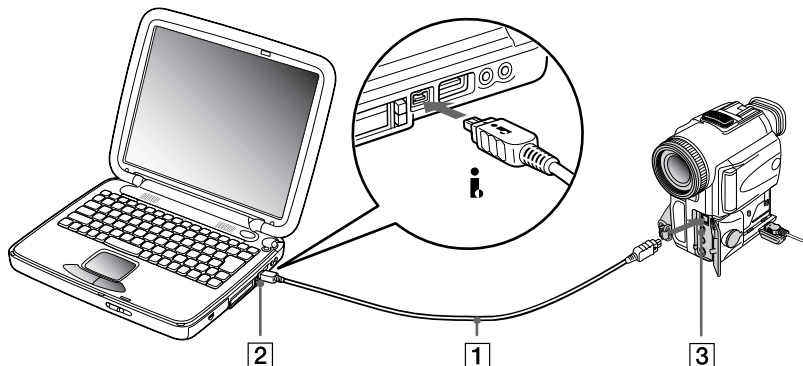

- 2 Launch the DVgate application.

 On Sony digital video cameras, connectors labeled **DV Out**, **DV In/Out** or **i.LINK** are i.LINK™-compatible.

The Sony digital video camera recorder is an example; your digital video camera recorder may need to be connected differently.

If your digital video camera recorder includes a Memory Stick™ slot, you can copy images from it to your computer via a Memory Stick™. To do so, simply copy images on the Memory Stick™, then insert it into an optional PCMCIA Memory Stick™ adapter which can be plugged into the PC card slot of your computer.

Connecting two VAIO notebooks

You can connect your notebook to another VAIO notebook using an i.LINK™ cable (not supplied). Your notebook includes Windows® Millennium Edition and can be connected through i.LINK™ to any other VAIO computer that also has Windows® Millennium Edition installed or that has Smart Connect 3.0. You can then use your computer to copy, edit or delete files from another VAIO computer.

You can also print a document on a printer connected to another VAIO computer.

Connecting to a network (LAN)

You can connect your computer to 10BASE-T/100BASE-TX-type networks via an Ethernet network cable. For the detailed settings and devices needed to connect to the network, consult your Network Administrator.

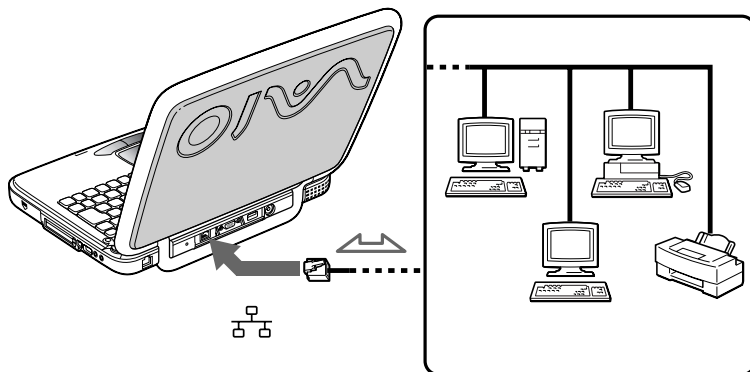

For more information about connecting your notebook to the network, please consult the Hardware troubleshooting section of the VAIO-Link website:

[How to troubleshoot network problems](#)

! Do not plug a phone cable into your computer network jack.

Getting help

This section describes how to get help and support from Sony, as well as troubleshooting tips for your computer.

Sony support options

Sony provides several support options for your computer.

Printed documentation supplied with your Sony notebook

- ❑ The **Customer Guide** explains how to start your computer and use the basic functions. This guide gives you the information to access VAIO-Link.
- ❑ A **Getting Started** brochure, where you will find a brief description of the items in the box, a quick guide to setting up your VAIO notebook, and a short list of specifications.

Online user guides on your Documentation CD-ROM

- ❑ The **Hardware Guide** explains how to use your computer and connect peripheral devices. It also contains a list of specifications of your computer and accessories.
- ❑ The **Software Guide** lists the pre-installed software titles and explains how to use the utility programs and perform basic computer tasks.
- ❑ The **Customer Service Guide** gives you complete information on the VAIO-Link Services.

Other sources of information

- ❑ The **online help files** that accompany your pre-installed software contain instructions on using the software.

- ❑ **VAIO-Link website:** if you have any problems with your computer, you can access the VAIO-Link website. Go to:
<http://www.vaio-link.com>
- ❑ **VAIO-Link Response Centre:** Before contacting VAIO-Link Response Centre, try to solve the problem by reading the User Guides and help files for the peripherals or software.

 You need to plug in the phone line and configure your modem for use before using the communication features described in this manual.

Troubleshooting

This section describes how to solve common problems you might encounter when using your notebook. Many problems have simple solutions. Please try these suggestions before contacting VAIO-Link.

About the computer and software

My computer does not start

- ❑ Check that the computer is plugged into a power source and that it is turned on.
- ❑ Check that the power indicator on the front panel of the computer indicates that the power is on.
- ❑ Check that the battery packs are inserted properly and that they are charged.
- ❑ Make sure there is no diskette in the floppy disk drive.
- ❑ Confirm that the power cord and all cables are connected firmly.
- ❑ If you have plugged the computer into a UPS, make sure the UPS is turned on and works.
- ❑ If you are using an external display, check that it is plugged into a power source and turned on. Check that you have switched to the external display and that the brightness and contrast controls are adjusted correctly.
- ❑ Moisture condensation may have occurred. Leave the computer for at least one hour before turning it on.

- ❑ Take the battery pack off the notebook, unplug the power cord and plug it in again, then turn on the power.
- ❑ If the message **Press <F1> to continue, <F2> to enter setup** appears at the bottom of the display, you need to initialize the BIOS.

The message Press <F1> to continue, <F2> to enter setup appears at startup

If the floppy disk drive is empty, proceed as follows to initialize the BIOS:

- 1 Turn off the computer.
- 2 Remove any peripheral devices connected to the computer.
- 3 Turn on the computer and press **<F2>** when the Sony logo appears.
The BIOS setup menu screen appears.
- 4 Press the arrow keys to select the **Exit** menu.
- 5 Press the arrow keys to select **Get Default Values** and then press **<Enter>**. The message **Load default configuration now?** appears.
- 6 Make sure that **[Yes]** is selected and then press **<Enter>**.
- 7 Press the arrow keys to select **Exit** (save changes) and then press **<Enter>**.
The message **Save configuration changes and exit now?** appears.
- 8 Make sure that **[Yes]** is selected and then press **<Enter>**.
- 9 Restart the computer by pressing **<Ctrl> + <Alt> + <Delete>** twice.

My computer does not shut down

You are recommended to shut down your computer by using the **Shut Down** command on the Windows® **Start** menu. Using other methods, including those listed here, may result in loss of unsaved data. If the **Shut Down** command does not work properly, proceed as follows:

- ❑ Restart the computer by pressing **<Ctrl> + <Alt> + <Delete>** twice.

- ❑ If this does not work, press the power button and hold it for at least four seconds. This turns off the power.
- ❑ Unplug the computer from the AC adapter and remove the battery pack from your computer.

My computer locks up

- ❑ If you suspect one application is locking your system, you can try to stop it. To do this, press **<Ctrl>+<Alt>+<Delete>** once, select the application that is locking your system, and then click **End Task**.
- ❑ If the above method does not work or you do not know which application is locking your system, restart the computer. On the Windows[®] taskbar, click the **Start** button, click **Shut Down**, and then select **Shut Down** in the list and click **OK**.
- ❑ If the above method does not work, press the power button and hold it for at least four seconds. This turns off the power.
- ❑ If your computer locks up while playing a CD or DVD-ROM, stop the CD or DVD-ROM, shut down the computer by pressing **<Ctrl>+<Alt>+<Delete>**, and then click **Shut Down**.

My software program locks up or crashes

Contact the software publisher or designated provider for technical support.

My touchpad interprets a single tap as a double-click

Open the **Mouse** icon in the **Control Panel** and change the button assignments in the **Mouse Properties** dialog box. One of the buttons is assigned to the double-click action.

My mouse does not work

- ❑ Check that the appropriate driver for the USB mouse is properly installed.
- ❑ Check that the USB mouse is plugged into the USB connector.

About the display

My LCD screen does not display anything

- ❑ Check that the computer is plugged into a power source and that it is turned on.
- ❑ Check that the power indicator on the front panel of the computer is on.
- ❑ Check that the battery pack is inserted properly and that it is charged.
- ❑ Adjust the brightness of the LCD.
- ❑ The computer may be in LCD (video) Standby mode. Press any key to activate the display.
- ❑ The display mode may be set to external display mode. Press and hold the **<Fn>** key while pressing **<F7>** several times.

The screen image on my external display is not centred or sized properly

Use the controls on your external display to adjust the image.

The window I have just closed still appears on my LCD screen

Press the **Windows**[®] key and **<D>** key twice to refresh the screen.

About compact discs and diskettes

My DVD-ROM drive tray does not open

- ❑ Make sure the computer is turned on.
- ❑ Press the eject button on the DVD-ROM drive.
- ❑ If the eject button does not work, you can open the tray by inserting a sharp, pointed object into the hole to the right of the eject button.

I cannot play a CD

- ❑ Make sure the label of the disk is facing up.
- ❑ If the disk requires software, make sure the software is installed according to the instructions of the program.
- ❑ Check the volume of your speakers.
- ❑ Clean the disk.
- ❑ Moisture condensation may have occurred. Leave the computer for at least 1 hour while it is turned on.

I cannot play a DVD-ROM

- ❑ If a region code warning appears when you are using the DVD player, it could be that the DVD-ROM you are trying to play is incompatible with the DVD-ROM drive on your VAIO notebook. The region code is listed on the packaging of the disc.
- ❑ If you hear sound but cannot see a picture, your computer's video resolution may be set too high. For the best results, change the resolution in the Windows® **Control Panel - Display - Settings** to 800 x 600 using 8-bit color.
- ❑ If you see the video but cannot hear sound, check all of the following:
 - ❑ Make sure the mute setting is off in your DVD player software.
 - ❑ Check the master volume setting in the **Audio Mixer**. If you have connected external speaker, check the volume settings for your computer speakers and check the connections between your speakers and the computer.
 - ❑ In the **Device Manager**, check that the correct drivers are installed properly. To display the **Device Manager**, click **Start**, point to **Settings** and click **Control Panel**. Double-click the **System** icon. On the **System** properties, click on the **Device Manager** tab.
- ❑ A dirty or damaged disc may cause the computer to 'hang' while it tries to read the disc. If necessary, reboot the computer, remove the disc and then check that it is not dirty or damaged.

-  On your computer, the default DVD region code is 2, which is the region code for European DVDs. Do not change this setting using the Region Code Change function in Windows®, or any other software application. System malfunctions originating from the user changing the DVD region code are beyond the scope of your warranty and will result in service charges for repair.

My floppy disk drive cannot write to a diskette

- The diskette is write-protected. Disable the write-protect feature or use a diskette that is not write-protected.
- Check that the diskette is properly inserted into the floppy disk drive.

When I double-click an application icon, a message such as 'You must insert the application CD into your disc drive' appears and the software does not start.

- Some titles require specific files that are located on the application CD-ROM. Insert the disc and try starting the program again.
- Make sure you place the disc in the tray with the label side facing upwards.

The disc tray does not eject even when I press the eject button

- Check that the notebook is turned on.

The disc tray ejects even when it has been locked into place

- Ensure that the disc is placed with the label side facing up.
- Clean the disc.
- The disc may be scratched. Insert another disc to see if that is the reason.
- There may be condensation in the drive. Remove the disc and leave the drive open for approximately one hour.

About sound

My speakers are not producing sound

- ❑ The built-in speakers may be turned off. Press **<Fn>+<F3>** to turn on the speakers.
- ❑ The speaker volume may be turned to the minimum. Press **<Fn>+<F4>**, and then press **↑** or **➡** to increase the volume.
- ❑ If your computer is powered by battery, check that the battery is inserted properly and that it is charged.
- ❑ If you are using an application that has its own volume control, check that the volume is turned up.
- ❑ Check the volume controls in Windows®.
- ❑ If you use external speakers, check that the speakers are properly connected and the volume is turned up. If the speakers have a mute button, make sure it is off. If batteries power the speakers, check that the batteries are inserted properly and that they are charged.
- ❑ If you have connected an audio cable to the headphone connector, disconnect the cable.

My microphone does not work

If you are using an external microphone, check that the microphone is plugged into the microphone connector.

About the modem

My internal modem does not work

- ❑ Check that the phone line is plugged into your computer.
- ❑ Check that the phone line is working. You can check the line by plugging in an ordinary phone and listening for a dial tone.
- ❑ Check that the phone number the program is dialing is correct.

- ❑ In the **Modems Properties** dialog box (**Control Panel / Modems**), check that your modem is listed in the **General** tab, and that the location information is correct on the **Dialing Properties** tab.

If you do not see the **Modems** icon, proceed as follows:

- 1 In **Control Panel** click **Tools** and click **Folder Options...**
- 2 Select the **View** tab.
- 3 In the **Advanced settings:** dialog box, select the option **Display all Control Panel options and all folder contents**.
- 4 Click **OK**.

My modem cannot establish a connection

The modem dialing mode may be incompatible with your telephone line.

My modem connection is slow

Many factors influence modem connection speed, including telephone line noise or compatibility with telephone equipment (such as fax machines or other modems). If you think your modem is not connecting properly to other PC-based modems, fax machines, or your Internet Service Provider, check the following:

- ❑ Have your phone company check that your phone line is free from any line noise.
- ❑ If your problem is fax-related, check that there are no problems with the fax machine you are calling and that it is compatible with fax modems.
- ❑ If you are having a problem connecting with your Internet Service Provider, check that the ISP is not experiencing technical problems.
- ❑ If you have a second phone line available, try connecting the modem to that line.

About peripherals

I cannot use DV devices. The message 'DV equipment seems to be disconnected or turned off' appears

- ❑ Check that the DV device is turned on and that the cables are properly connected.
- ❑ If you are using multiple i.LINK™ devices, the combination of the connected devices may cause unstable operation. In this case, turn off the power of all connected devices and disconnect unused devices. Check the connection and then turn on the power again.
- ❑ You are strongly advised to use only Sony i.LINK™ cables, as using other brands may cause problems with the i.LINK™ devices.

My PC Card is not working

- ❑ Make sure the PC Card is compatible with your version of Windows®.
- ❑ If you are using two PC Cards, use the **Sony Notebook Setup** utility to disable the devices you are not currently using.

I cannot print

- ❑ Check that all the cables of the printer are correctly connected.
- ❑ Check that your printer is correctly configured and that you have up-to-date drivers. If needed, contact your dealer.

About digital video captures and DVgate

While I am recording images to a digital video device using DVgate, my system displays the message 'Recording to DV device failed. Check the power and cable connections to the DV devices and try the operation again...'

Close all open applications and restart your computer. Frequent recording of images to a digital video device while using DVgate sometimes causes this error.

Precautions

This section describes safety guidelines and precautions to help you protect your computer from potential damage.

Your notebook and memory modules use high precision components and electronic connectors technology. To avoid the invalidation of your guarantee by mishandling, it is recommended that:

- ❑ You contact your dealer to install a new memory module.
- ❑ You do not install it yourself, if you are not familiar with upgrading memory on a notebook.
- ❑ You do not touch the connectors or open the memory panel.

Please contact VAIO-Link if you need assistance.

Adding and removing memory

In the future you may want to install memory modules to expand the functionality of your computer. You can increase the memory by installing optional memory modules.

Be careful when adding memory. Mistakes on installation or removal of the memory module may cause a malfunction.

For memory upgrades, use only PC100 (CL2) SDRAM SO-DIMM (gold leaf contacts).

Electrostatic discharge can damage electronic components. Before touching a memory expansion board, ensure the following:

- ❑ Handle the memory module gently.
- ❑ The procedures described in this document assume familiarity with the general terminology associated with personal computers and with the safety practices and regulatory compliance required for using and modifying electronic equipment.

- ❑ Disconnect the system from its power source and from any telecommunication links, networks, or modems before you open the system. Failure to do so may result in personal injury or equipment damage.
- ❑ Electrostatic Discharge (ESD) can damage memory modules and other components. Install the memory module only at an ESD workstation. If such a station is not available, do not work in a carpeted area, and do not handle materials that produce or hold static electricity (cellophane wrappers, for example). Ground yourself by maintaining contact with an unpainted metal portion of the chassis while performing the procedure.
- ❑ Do not open the memory module package until you are ready to install the module. The package protects the module from ESD.
 - ! Use the special bag delivered with the memory module or wrap the module in aluminium foil to protect it from electrostatic discharge.
 - ! Do not place the memory module in places subject to:
 - Heat sources such as radiators or air ducts,
 - Direct sunlight,
 - Excessive dust,
 - Mechanical vibration or shock,
 - Strong magnets or speakers that are not magnetically shielded,
 - Ambient temperature of more than +35°C or less than +5°C,
 - High humidity.

Removing a memory module

If you are not familiar with upgrading memory on a notebook, we highly recommend that you contact your dealer.

To remove a memory module, proceed as follows:

- 1 Shut down your computer and disconnect all peripheral devices.
- 2 Unplug the computer and remove the battery pack.

- 3 Wait until the computer cools down.
The inside of a notebook becomes extremely hot during operation. Wait for about one hour for the computer to cool down before you remove the screws.
- 4 Push the LCD screen away from you until it is completely flat.
- 5 Remove the thin plastic strip containing the Num Lock, Caps Lock and Scroll Lock indicators by sliding it toward the keyboard and pulling it up gently.

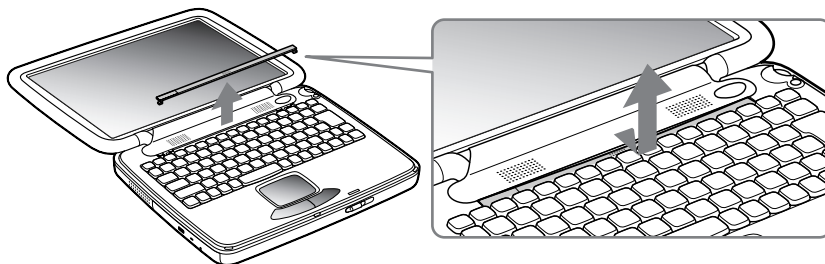

- 6 Unscrew the two screws underneath the plastic strip (turn counter-clockwise).

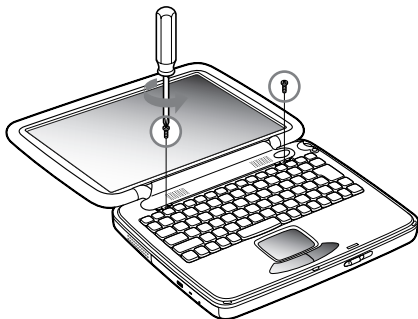

- 7 Lift the speaker cover toward the LCD screen.

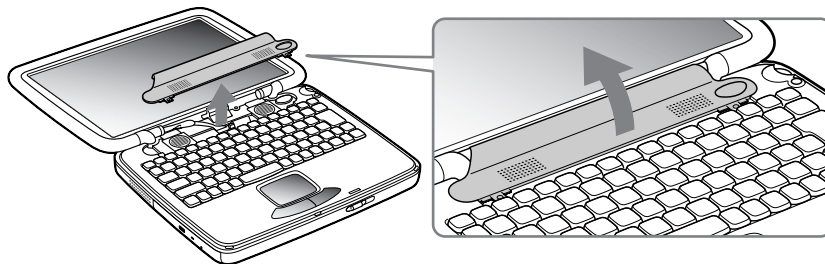

- 8 Lift the keyboard toward the LCD display and turn over the keyboard. Be careful not to pull the cables of the display.

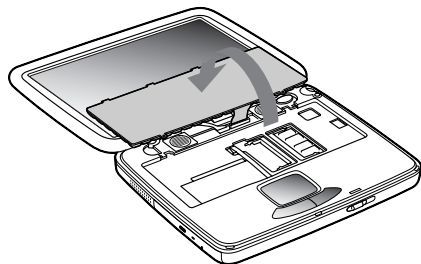

- 9 Before you remove the memory module , touch a metal part of the computer to discharge any static electricity accumulated on your body.
- 10 Remove the memory module:
- ❑ Carefully pull the release tabs (1) on both ends of the memory module at the same time in the direction of the arrow.

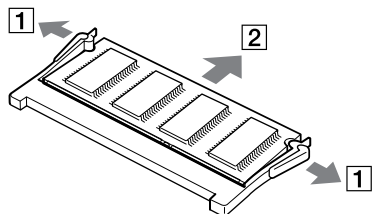

- Pull out the memory module in the direction of the arrow (2).

Adding or changing a memory module

If you are not familiar with upgrading memory on a notebook, we highly recommend that you contact your dealer.

To add or replace a memory module, proceed as follows:

- 1 Shut down your computer and disconnect all peripheral devices.
- 2 Unplug the computer and remove the battery pack.
- 3 Wait until the computer cools down.
The inside of the notebook becomes extremely hot during operation. Wait for about one hour for the computer to cool down before you remove the screws.
- 4 Push the LCD screen away from you until it is completely flat.
- 5 Remove the thin plastic strip containing the Num Lock, Caps Lock and Scroll Lock indicators by sliding it toward the keyboard and pulling it up gently.
- 6 Unscrew the two screws underneath the plastic strip (turn anti-clockwise).
- 7 Lift the speaker cover toward the LCD screen.

- 8 Lift the keyboard toward the LCD screen and turn over the keyboard. Be careful not to pull the display cables.
- 9 Before you remove the old memory module, touch a metal part of the computer to discharge any static electricity accumulated on your body.
- 10 Remove the old memory module if applicable (for more information, see Removing a memory module).
- 11 Slide the new memory module into the slot.
- 12 Put the keyboard gently back.

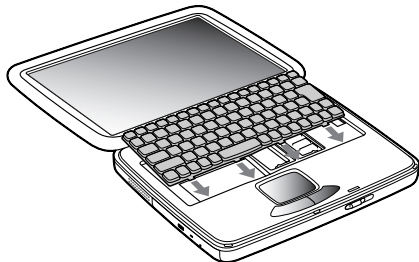

- 13 Put the speaker cover back. Adjust the placement at both ends and press the center until it clicks.

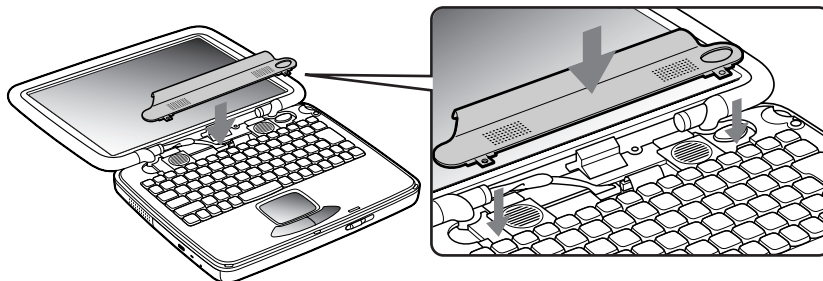

- 14 Tighten the two screws to fix the keyboard.

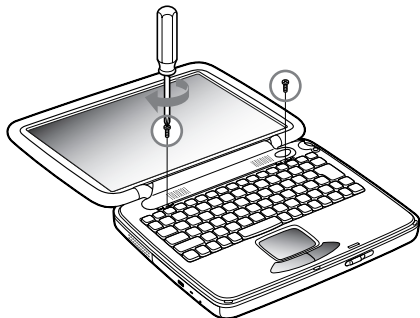

- 15 Insert the nails of both ends first and then slide the center toward the LCD panel.

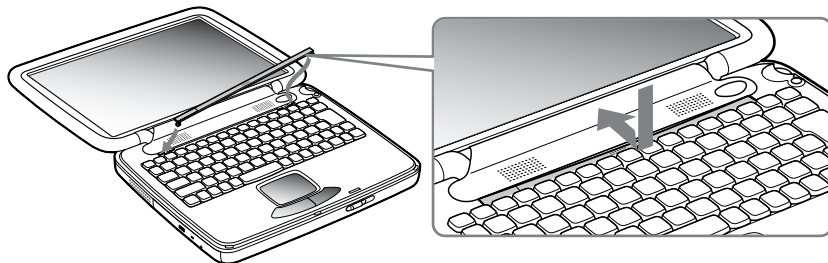

- 16 Put the LCD back to its normal position.
17 Turn on your notebook.

Viewing the amount of memory

To view the amount of memory, proceed as follows:

- 1 Turn on the computer.
- 2 Click the **Start** button, point to **VAIO**, and click **Sony Notebook Setup**. The **Sony Notebook Setup** screen appears.
- 3 Click the **About this Computer** tab to view the amount of system memory. If the additional memory does not appear, repeat the whole procedure.

Other precautions

On handling the hard disk

The hard disk has a high storage density and reads or writes data in a short time. On the other hand, it may be easily damaged by mechanical vibration, shock or dust.

Although the hard disk has the safety device in itself to prevent losing data due to mechanical vibration, shock or dust, you should be careful when handling your computer.

To avoid damaging your hard disk:

- Do not give a shock to your computer.
- Keep away from magnets.
- Do not place your computer on an unstable surface or in a location subject to mechanical vibration.
- Do not move your computer while the power is on.
- Do not turn off the power or restart the computer while reading or writing data.
- Do not use your computer in a place subject to extreme change of temperature.
- If the hard disk is damaged, the data cannot be restored.

On handling the LCD screen

- ❑ Do not leave the LCD facing the sun as it can damage the LCD. Be careful when using the computer near a window.
- ❑ Do not scratch the LCD or exert pressure on it. This could cause a malfunction.
- ❑ Using the computer in low temperature conditions may produce a residual image on the screen. This is not a malfunction. When the computer returns to normal temperature, the screen returns to normal.
- ❑ A residual image may appear on the screen if the same image is displayed for a lengthy period of time. The residual image disappears in a while. You can use a screensaver to prevent residual images.
- ❑ The screen becomes warm during operation. This is normal and does not indicate a malfunction.
- ❑ The LCD is manufactured using high-precision technology. You may, however, see tiny black points and/or bright points (red, blue, or green) that continuously appear on the LCD. This is a normal result of the manufacturing process and does not indicate a malfunction.
- ❑ Avoid rubbing the LCD screen, as this can damage the screen. Use a soft, dry cloth to wipe the LCD screen.

On using the power source

- ❑ Your computer operates on 100V-240V AC 50/60 Hz.
- ❑ Do not share the AC outlet with other high power-consuming equipment, such as a photocopier or shredder.
- ❑ You can purchase a power strip with a surge protector. This device prevents damage to your computer caused by sudden power surges such as those that may occur during an electrical storm.
- ❑ Do not place heavy objects on the power cord.
- ❑ To disconnect the cord, pull it out by the plug. Never pull the cord itself.
- ❑ Unplug your computer from the wall outlet if you are going to use the computer for a long time.
- ❑ When the AC adapter is not in use, unplug it from the AC outlet.
- ❑ Use only the supplied AC adapter. Do not use any other AC adapter.

On handling your notebook

- ❑ Clean the cabinet with a soft, dry cloth or a soft cloth lightly moistened with a mild detergent solution. Do not use any type of abrasive pad, scouring powder, or solvent such as alcohol or benzine, as these may damage the finish of your computer.
- ❑ Should any solid object or liquid fall into the computer, shut down your computer and then unplug it. You may want to have the computer checked by qualified personnel before operating it any further.
- ❑ Do not drop the computer or place heavy objects on top of the computer.
- ❑ Do not place your computer in a location subject to:
 - ❑ Heat sources, such as radiators or air ducts,
 - ❑ Direct sunlight,
 - ❑ Excessive dust,
 - ❑ Moisture or rain,
 - ❑ Mechanical vibration or shock,
 - ❑ Strong magnets or speakers that are not magnetically shielded,
 - ❑ Ambient temperature of more than 35° C or less than 10° C,
 - ❑ High humidity.
- ❑ Do not place electronic equipment near your computer. The electromagnetic field of your computer may cause a malfunction.
- ❑ Provide adequate air circulation to prevent internal heat from building up. Do not place your computer on porous surfaces such as rugs or blankets, or near material such as curtains or draperies that may block its ventilation slots.
- ❑ The computer uses high-frequency radio signals and may cause interference to radio or TV reception. Should this occur, relocate the computer a suitable distance away from the set.
- ❑ Use only specified peripheral equipment and interface cables; otherwise, problems may occur.

- ❑ Do not use cut or damaged connection cables.
- ❑ Your computer cannot be connected to a coin-operated telephone, and may not work with a private branch exchange (PBX).
- ❑ If the computer is brought directly from a cold location to a warm one, moisture may condense inside your computer. In this case, allow at least one hour before turning on your computer. If any problem occurs, unplug your computer and contact VAIO-Link.
- ❑ Make sure you disconnect the power cord before cleaning the computer.

On handling diskettes

- ❑ Do not open the shutter manually or touch the surface of the diskette.
- ❑ Keep diskettes away from magnets.
- ❑ Keep diskettes away from direct sunlight and other heat sources.

On handling compact discs

- ❑ Do not touch the surface of the disc.
- ❑ Do not drop or bend the disc.
- ❑ Fingerprints and dust on the surface of a disc may cause read errors. Proper care of the disc is essential to maintain its reliability. Do not use solvents such as benzene, thinner, commercially available cleaners or anti-static spray, as they may cause damage to the disc.
- ❑ For normal cleaning, hold the disc by its edge and use a soft cloth to wipe the surface from the center out.
- ❑ If the disc is badly soiled, moisten a soft cloth with water, wring it out well, and use it to wipe the surface of the disc from the center out. Wipe off any remaining moisture with a dry soft cloth.

On using the battery pack

- ❑ Never leave the battery pack in temperatures above 60° C, such as in a car parked in the sun or under direct sunlight.
- ❑ Battery life is shorter in a cold environment. This is due to decreased battery efficiency at low temperatures.
- ❑ Charge the batteries at temperatures between 10° C to 30° C. Lower temperatures require a longer charging time.
- ❑ While the battery is in use or being discharged, the battery pack heats up. This is normal and is not a cause for concern.
- ❑ Keep the battery pack away from all sources of heat.
- ❑ Keep the battery pack dry.
- ❑ Do not open or try to disassemble the battery pack.
- ❑ Do not expose the battery pack to any mechanical shock.
- ❑ If you are not using the computer for an extended period of time, remove the battery pack from the computer to prevent damage to the battery.
- ❑ If, after fully charging the battery pack, the battery power is still low, the battery pack may be reaching the end of its life and should be replaced.
- ❑ You do not need to discharge the battery before recharging.
- ❑ If you have not used the battery pack for a considerable amount of time, recharge the battery.

On using headphones

- ❑ **Road safety** – Do not use headphones while driving, cycling, or operating any motorized vehicle. It may create a traffic hazard and is illegal in some areas. It can also be potentially dangerous to play loud music while walking, especially on pedestrian crossings.

- ❑ **Preventing hearing damage** – Avoid using headphones at high volume. Hearing experts advise against continuous, loud and extended play. If you experience a ringing in your ears, reduce the volume or discontinue use.

On handling the Memory Stick™

- ❑ Do not touch the connector with your fingers or metallic objects.
- ❑ Use only the label supplied with the Memory Stick™ as a label.
- ❑ Do not bend, drop, or apply strong shock to the Memory Stick™.
- ❑ Do not disassemble or modify Memory Sticks™.
- ❑ Do not let cards get wet.
- ❑ Do not use or store Memory Sticks™ in a location subject to:
 - ❑ Extremely high temperatures, such as in a car parked in the sun,
 - ❑ Direct sunlight,
 - ❑ High humidity or near corrosive substances.
- ❑ Use the storage case supplied with the Memory Stick™.

Specifications

Model

PCG-QR20

<i>Operating system</i>	Microsoft® Windows® Millennium Edition
<i>Processor</i>	Mobile Intel® Celeron™ processor 700 MHz
<i>Hard disk drive</i>	10 GB
<i>Standard RAM</i>	128 MB SDRAM (2 x 64 MB in slot)
<i>Maximum RAM</i>	512 MB
<i>LCD screen</i>	13.3" XGA (1024x768) TFT
<i>L2 cache memory</i>	128 KB (on die)
<i>MPEG</i>	MPEG 2 Digital Video Supports full-screen playback
<i>Graphics</i>	Intel® 815EM chipset integrated graphic
<i>Sound capabilities</i>	16-bit CD-quality stereo sound
<i>DVD-ROM drive</i>	24x max. CD-ROM reading speed 8x max. DVD-ROM reading speed laser diode properties: CD wave length: 770nm - 800nm DVD wave length: 640nm - 660nm laser output: 30.2 μW
<i>Internal modem</i>	built-in modem V.90/K56Flex (56kbps) data/fax modem

Model**PCG-QR20**

<i>Telecommunication capabilities</i>	10BASE-T/100BASE-TX Fast Ethernet LAN connection (RJ-45) PSTN data connectivity
<i>Expansion capabilities</i>	Two type I/II or one type III cards, Cardbus compatible
<i>Built-in capabilities</i>	stereo speakers, touchpad, Jog Dial with back button
<i>Connection capabilities on notebook</i>	Monitor, external speakers/headphone, external microphone, 2 USB, modem, i.LINK™ (IEEE1394) S400, Ethernet
<i>Supplied accessories</i>	rechargeable battery, AC adapter, AC power cord, phone cable, country-specific phone plug
<i>Service</i>	± 1 year free VAIO-Link Service
<i>Guarantee</i>	± 1 year guarantee (parts and labour)
<i>Power source</i>	19.5V DC/AC100-240V
<i>Power management</i>	ACPI (Advanced Configuration & Power Interface)
<i>Battery</i>	Lithium ion
<i>Dimensions</i>	
<i>Width</i>	330.6 mm
<i>Height</i>	47.2 mm
<i>Depth</i>	261.1 mm
<i>Weight</i>	3.0 kg
<i>Operating temperature</i>	+5°C to +35°C (temperature gradient less than 10°C/hour)
<i>Storage temperature</i>	-20°C to +60°C (temperature gradient less than 10°C/hour)

Model**PCG-QR20**

<i>Operating humidity</i>	20% to 80% (not condensed), provided that humidity is less than 65% at +35°C (hygrometer reading of less than 29°C)
<i>Storage humidity</i>	10% to 90% (not condensed), provided that humidity is less than 20% at +60°C (hygrometer reading of less than 35°C)

‡ See our special Guarantee extension conditions.

Specifications are subject to change without notice.

Index

A

- AC adapter 4, 9, 17
- accessory 76
- air circulation 71
- Alt key 25
- application key 25

B

- battery 6
 - bay 12, 18
 - charging status 19
 - charging the 19
 - indicator 14, 19, 26
 - pack 9, 18, 20
- brightness control 21, 28
- built-in capability 76
- button
 - back 13
 - power 21

C

- cable
 - display 42

- Ethernet network 51
 - i.LINK™ 50
 - microphone 45
 - phone 38
 - printer 48
 - speaker 44
- camera 50
- Caps Lock indicator 14, 26
- charging status 19
- combination controls 27, 28
- connection capability 76
- connector
 - DC In 15, 17
 - Ethernet 15
 - headphone 12, 44
 - i.LINK™ 12
 - microphone 12, 45
 - monitor 15
 - USB 12, 15, 48
- copyright 2
- correction key 25
- Ctrl key 25
- Customer Guide 52
- Customer Service Guide 52

D

- DC In 17
- DC In connector 15

- digital video camera 50
- dimension 76
- diskette
 - inserting a 47
 - removing a 47
- display 41
 - cable 42
 - computer 41, 42
- documentation pack 8, 9
- DVD-ROM drive 13, 32, 75
- DVgate 50

E

- eject hole 13
- Energy Star guidelines 3
- ergonomic considerations 10
- Escape key 24
- Ethernet
 - connector 15
 - network cable 51
- expansion capability 76
- external
 - display 28
 - microphone 45
 - speaker 44

F

- floppy disk drive
 - connecting a USB 46
 - removing a USB 47
- Fn key 25, 28
- function key 25

G

- graphic 75
- guarantee 4, 23, 76

H

- hard disk drive 75
 - indicator 14, 26
- headphone connector 12, 44
- help 52
- Help key 25
- Hibernate mode 20, 28, 38, 39
- humidity
 - operating 77
 - storage 77

I

- i.LINK™
 - cable 50

- device 49
- indicator
 - battery 19, 26
 - Caps Lock 14, 26
 - hard disk drive 14, 26
 - Num Lock 14, 26
 - power 14, 26
 - Scroll Lock 14, 26
- Insert key 25

J

- Jog Dial 13, 30

K

- key
 - Alt 25
 - application 25
 - correction 25
 - Ctrl 25
 - Escape 24
 - Fn 25, 28
 - function 25
 - Help 25
 - Insert 25
 - navigation 25
 - operator 25
 - Print Screen 25

- Shift 25
- Windows® 25, 27
- keyboard 14, 24

L

- L2 cache memory 75
- LCD screen 14, 75

M

- maximum RAM 75
- memory module
 - removing a 63, 66
- Memory Stick™ 35
 - inserting a 36
 - removing a 37
- microphone 45
 - cable 45
 - connector 12, 45
- model number 3
- modem 4, 37, 75
- moisture condensation 72
- monitor 41
 - connector 15, 42
- MPEG 75

N

- navigation key 25
- network 51
- Normal mode 39
- Num Lock 25
 - indicator 14, 26
- numeric keypad 25

O

- operating system 75
- operator key 25

P

- PC Card
 - adapter 36
 - inserting a 33
 - removing a 34
 - slot 33
- peripherals 41
- phone
 - cable 9, 38
 - line jack 15, 38
 - plug 9
- power
 - button 13, 21
 - cord 9, 48

- indicator 14, 26
 - management 76
 - source 76
- power mode
 - Hibernate 26
 - Standby 26
- power saving modes 38
- precautions 62
- Print Screen key 25
- printer cable 48
- processor 75
- product recovery CD-ROM 9
- projector 41, 43

R

- registration 23
- regulatory information 5
- release lever 13
- reset switch 15

S

- screen lock 20
- Scroll Lock indicator 14, 26
- serial number 3
- service 76
- Shift key 25
- Smart Connect 51

- Software guide 52
- sound 75
- speaker 14, 44
 - cable 44
 - switch 28
 - volume 28
- specifications 75
- standard RAM 75
- Standby mode 20, 28, 38, 39

T

- technical specifications 75
- telecommunication 76
- temperature
 - operating 76
 - storage 76
- touchpad 14, 29
- troubleshooting 53

U

- USB
 - connector 12, 15, 48
 - floppy disk drive 46
 - mouse 46

V

VAIO-Link [3](#), [6](#), [23](#), [53](#)

VAIO-Link Response Centre [53](#)

ventilation [71](#)

slot [13](#)

video camera [50](#)

W

warnings [4](#)

weight [76](#)

Windows® key [25](#), [27](#)