



Sony Notebook Computer User Guide

PCG-N505SN



Notice to Users

© 2000 Sony Corporation. All rights reserved. This manual and the software described herein, in whole or in part, may not be reproduced, translated, or reduced to any machine-readable form without prior written approval.

Sony Corporation provides no warranty with regard to this manual, the software, or other information contained herein and hereby expressly disclaims any implied warranties or merchantability or fitness for any particular purpose with regard to this manual, the software or such other information. In no event shall Sony Corporation be liable for any incidental, consequential, or special damages, whether based on tort, contract, or otherwise, arising out of or in connection with this manual, the software, or other information contained herein or to use thereof.

Sony Corporation reserves the right to make any modification to this manual or the information contained herein at any time without notice. The software described herein is governed by the terms of a separate user license agreement.

Sony, DVgate, i.LINK™, Mavica, PictureGear, Memory Stick and the Memory Stick logo, VAIO and the VAIO logo are trademarks of Sony Corporation. Windows and the Windows 98 logo are registered trademarks of Microsoft Corporation.

Intel, MMX, Celeron and Pentium are trademarks of Intel Corporation.

All other trademarks are trademarks of their respective owners.

Specifications are subject to change without notice.

Safety Information

Owner's Record

The model number and serial number are located on the bottom of your Sony Notebook Computer. Record the serial number in the space provided here. Refer to the model and serial number when you call VAIO-Link.

Serial number: _____

Model number:

PCG-N505SN



As an ENERGY STAR Partner, Sony has determined that this product meets the ENERGY STAR guidelines for energy efficiency.

The International ENERGY STAR Office Equipment Program is an international program that promotes energy saving through the use of computers and their office equipment. The program backs the development and dissemination of products with functions that effectively reduce energy consumption. It is an open system in which business proprietors can participate voluntarily. The targeted products are office equipment such as computers, displays, printers, facsimiles and copiers. Their standards and logos are uniform among participating nations.

ENERGY STAR is an U.S. registered mark.

WARNING

- ❑ Opening the unit, for whatever reason, could lead to damages that are not covered by the guarantee.
- ❑ To avoid electrical shock, do not open the cabinet. Refer servicing to qualified personnel only.
- ❑ Audio and picture distortion may occur if this equipment is positioned in close proximity to any equipment emitting electromagnetic radiation.
- ❑ To prevent fire or shock hazard, do not expose your Sony Notebook Computer to rain or moisture.
- ❑ Never install modem or telephone wiring during a lightning storm.
- ❑ Never install telephone jacks in wet locations unless the jack is specifically designed for wet locations
- ❑ Never touch uninsulated telephone wire or terminals unless the telephone line has been disconnected at the network interface.
- ❑ Use caution when installing or modifying telephone lines.
- ❑ Avoid using the modem during an electrical storm.
- ❑ Do not use the modem or a telephone to report a gas leak in the vicinity of the leak.
- ❑ Use your notebook only with the supplied AC adapter. To disconnect your notebook completely from mains voltage, unplug the AC-adapter.
- ❑ Please make sure that the socket outlet is easily accessible.

Regulatory Information

This product conforms to the following European Directives:

73/23/EEC (Low Voltage Directive)

89/336/EEC, 92/31/EEC (EMC Directives)

93/68/EEC (CE Marking Directive)

This product complies with EN 55022 Class B and EN 50082-1 for use in following areas: residential, commercial and light-industrial.

This product has been tested and found compliant with the limits set out in the EMC Directive for using connection cables shorter than 3 metres (9.8 feet)



Disposal of Lithium ion batteries

Dispose of properly at end-of-life. In some areas the disposal of lithium ion batteries in household or business waste may be prohibited. Please use the public collection system.

DISPOSAL OF LITHIUM ION BATTERY

- ! Do not handle damaged or leaking Lithium ion batteries. Dispose of promptly and properly.**
- ! Danger of explosion if battery is incorrectly replaced. Replace only with the same or equivalent type recommended by the manufacturer. Discard used batteries according to the manufacturer's instructions (see below).**
- ! The battery pack used in this device may present a fire or chemical burn hazard if mistreated. Do not disassemble, heat above 100°C (212°F) or incinerate. Dispose of used battery promptly.**
- ! Keep away from children.**
- ! Your notebook is equipped with an internal backup memory battery. For changing this battery, please contact VAIO-Link.**

Contents

Welcome

About the User Guides	8
Unpacking Your Notebook Computer	10
Ergonomic Considerations.....	11

Using Your Notebook Computer

Locating the Controls and Connectors.....	13
Connecting a Power Source	17
Starting Your Computer	22
Shutting Down Your Computer	23
Registering Your Computer.....	24
Using the Keyboard	25
Using the Touchpad.....	32
Using the Floppy Disk Drive	33
CD-ROM Drive	36
Using PC Cards.....	37
Using a Programmable Power Key (PPK)	40
Using Smart Connect	42
Using Infrared Communication Devices	43
Using Power Saving Modes.....	45

Connecting peripheral devices

PC card modem*	48
i.LINK™ Port Replicator	50
Printer	53
External Display	55
Desktop Computer or Serial Device	57
Memory Sticks™	60
i.LINK™ device	61
MiniDisc® deck with MD Player	63
External Speakers	65
External Microphone	66
Universal Serial Bus (USB) Device	67

Getting Help

About Sony's Support Options	68
Troubleshooting	70
Using the Product Recovery CD-ROMs	82

Notes on Use

Placing a key top	86
Other precautions	87

Specifications 93

Index 96



Welcome

Congratulations on purchasing a Sony VAIO Notebook Computer. Sony has combined leading-edge technology in audio, video, computing and communications to provide you with state-of-the-art personal computing.

Here are just some of the features your Sony Notebook Computer has to offer (read the details in the Specifications chapter of this guide).

- ❑ **Exceptional performance** - Your PC includes a fast Intel[®] processor, a fast CD-ROM drive and a PC card modem (depending on the model).
- ❑ **Portability** - The rechargeable battery pack provides hours of use without AC power.
- ❑ **Sony audio and video quality** - A high-resolution LCD screen enables you to take advantage of today's advanced multimedia applications, games, and entertainment software.
- ❑ **Windows[®] 98 Second Edition** - Your system includes the latest operating system from Microsoft.
- ❑ **Communications** - Access popular online services, send and receive e-mails, browse the Internet...
- ❑ **Excellent customer support** - If you have any problem with your computer, you can contact VAIO-Link by telephone, fax or e-mail (see your Customer Service Guide for phone numbers and addresses). Before calling VAIO-Link, you may try to solve the problem by reading your User Guide (troubleshooting chapter) or the manuals and Help files for the peripherals or software.



 * Depending on the model, the on-line documentation could be supplied on a floppy disk.

About the User Guides

Your Documentation Pack contains paper and on-line user guides on a Documentation CD-ROM:

Printed Documentation:

- ❑ A **Setting Up** poster in colour and a **Getting Started** brochure; a **Customer Guide**, where you will find all the basic information to start using your Notebook Computer;
- ❑ A complete Regulatory and safety information poster;
- ❑ Your Sony Guarantee conditions.

On-line Documentation:

- 1 This User Guide:
 - ❑ **Using Your Sony Notebook Computer** shows you how to use the standard components of your system.
 - ❑ **Connecting Peripheral Devices** explains how you can add functionality by connecting various peripherals.
 - ❑ **Getting Help** explains the support options available to you, and offers basic troubleshooting tips.
 - ❑ **Notes on Use** provides facts and advice about using your notebook computer.
 - ❑ **Specifications** provides details of your computer, drivers and accessories.
- 2 Refer to your **Software Guide** for information on the bundled software and the Sony applications:

- ❑ **About the Software** is a short description of the features of the software pre-installed on your system
- ❑ **Customizing your notebook** explains how to set your system and power management with Sony Notebook Setup, PPK Setup, PowerPanel, BatteryScope, etc.
Learn how to set your display with NeoMagic® and enjoy the Dual Screen Display option.
- 3 Consult the **On-line Help** files of the software you're using for detailed information on features and troubleshooting.



 *Depending on the type of Sony Notebook you have purchased, some accessories may be optional. However, you need to have these peripherals to enjoy some of the features described in this manual.

 * Depending on the model, the on-line documentation could be supplied on a floppy disk.

Unpacking Your Notebook Computer

Remove the following hardware items from the box:

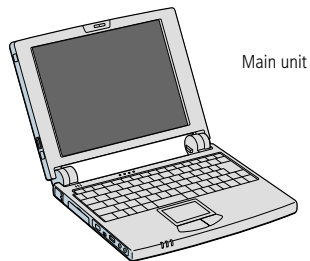

Rechargeable battery pack

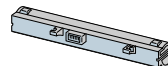

USB floppy disk drive



CD-ROM drive*

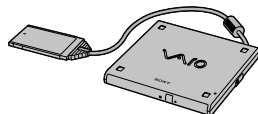

Product Recovery CD-ROMs



Documentation Pack*

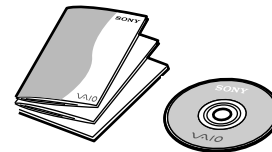

AC adapter

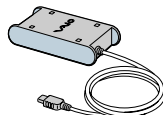

Power cord



i.LINK™ Port replicator

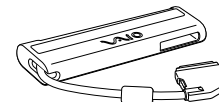

PC card *
modem

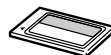

Phone plug* (country specific)



Phone cable *

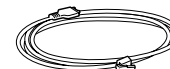

Ergonomic Considerations

You will be using your notebook computer as a portable device in a variety of environments. Whenever possible, you should attempt to take account of the following ergonomic considerations to both stationary and portable environments:

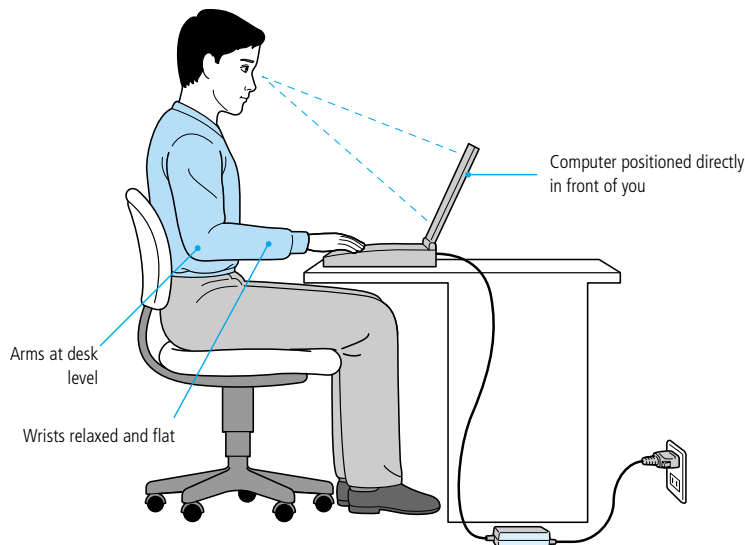

- ❑ **Position of your computer** – Place the computer directly in front of you as you work. Keep your forearms horizontal, with your wrists in a neutral, comfortable position while using the keyboard, touchpad, or external mouse. Let your upper arms hang naturally at your sides. Take breaks during sessions with your computer. Excessive use of the computer may strain muscles or tendons.

- ❑ **Furniture and posture** – Sit in a chair with good back support. Adjust the level of the chair so your feet are flat on the floor. A footrest may make you more comfortable. Sit in a relaxed, upright posture and avoid slouching forward or leaning far backwards.
- ❑ **Viewing angle of the computer's display** – Use the display's tilting feature to find the best position. You can reduce eye strain and muscle fatigue by adjusting the tilt of the display to the proper position. Adjust the brightness setting of the display as well.
- ❑ **Lighting** – Choose a location where windows and lights do not create glare and reflection on the display. Use indirect lighting to avoid bright spots on the display. You can also purchase accessories for your display that help reduce glare. Proper lighting adds to your comfort and work effectiveness.
- ❑ **Placement of an external display** – When using an external display, set the display at a comfortable viewing distance. Make sure the display screen is at eye level or slightly lower when you are sitting in front of the monitor.



Using Your Notebook Computer

This section describes how to start using your computer and how to use your computer's internal devices, such as the touchpad, the disk drives and the battery...

Locating the Controls and Connectors

Right

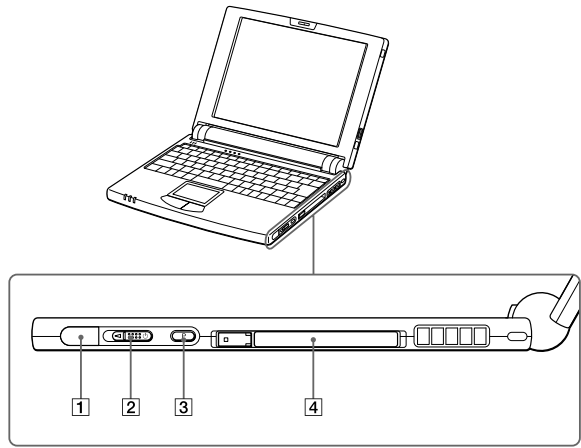

- 1 Infrared port (page 43)
- 2 Power switch (page 22)
- 3 Programmable power key
- 4 PC card slot (page 37)

Locating the Controls and Connectors

⚠ AC adapter mains connector and power cord: hazardous voltage, according to EN 60950.

All other connectors for this notebook are SELV (Safety Extra Low Voltage), according to EN 60950.

Left

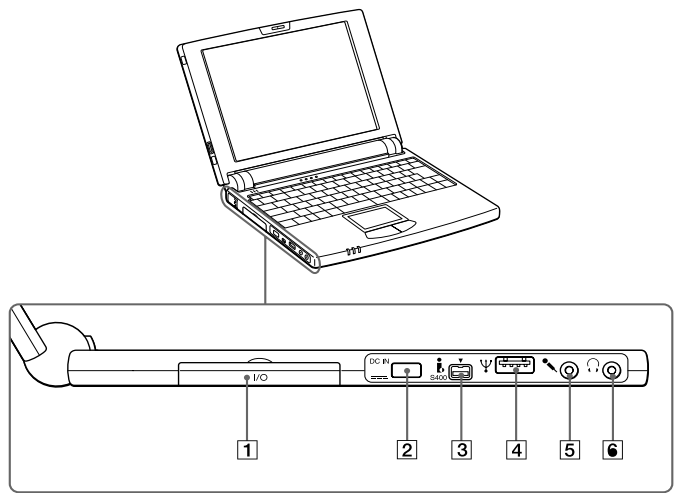

- 1 I/O i.LINK™ Port Replicator connector (page 50)
- 2 DC In (page 17)
- 3 S400 i.LINK™ connector (page 61)
- 4 USB connector (page 67)
- 5 Microphone connector (page 66)
- 6 Headphone connector (page 65)

Front

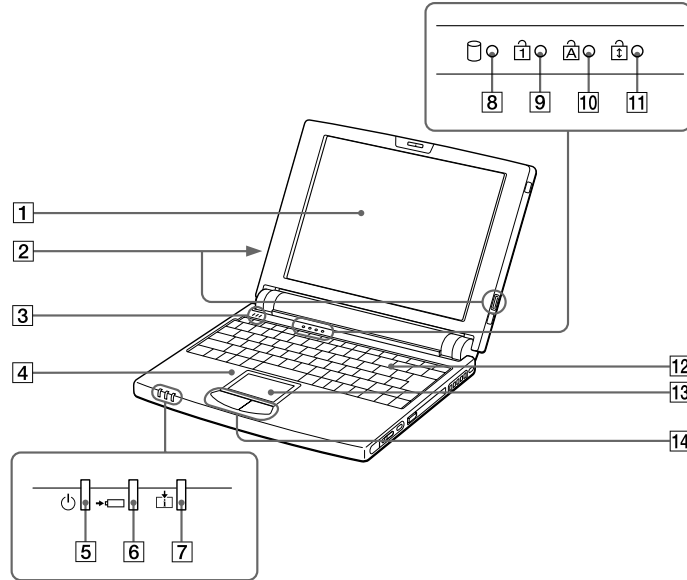

- | | | | |
|-------------------------------|--|---|--|
| 1 LCD screen (page 30) | 5 Power indicator (page 22) | 9 Num Lock indicator (page 29) | 13 Touchpad (page 32) |
| 2 Speaker connectors | 6 Battery indicator (page 28) | 10 Caps Lock indicator (page 29) | 14 Left/right buttons (page 32) |
| 3 Microphone | 7 Information indicator | 11 Scroll Lock indicator (page 29) | |
| 4 Speaker | 8 Hard disk drive indicator (page 28) | 12 Keyboard (page 25) | |

Back

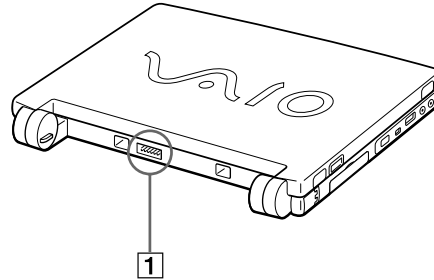

1 Battery connector (page 18)

Bottom

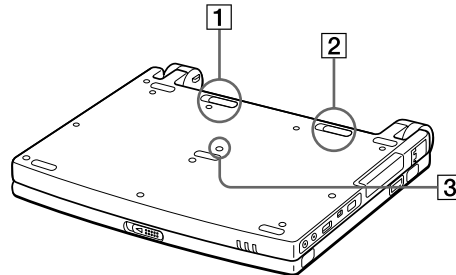

1 Battery release lever (page 18)

3 Reset switch

2 Battery lock lever (page 18)

 There is a ventilation slot located near the PC card slot. Do not cover the ventilation slot when your computer is on.

Connecting a Power Source

🔌 Use your notebook only with the supplied AC adapter.

To disconnect your notebook completely from mains voltage, unplug the AC adapter.

Please make sure that the socket outlet is easily accessible.

Connecting a Power Source

You can use either AC power or a rechargeable battery pack as a power source.

Using the AC Adapter

- 1 Plug the cable attached to the AC adapter into the DC In connector on the computer.
- 2 Plug one end of the power cord into the AC adapter.
- 3 Plug the other end of the power cord into an AC outlet.

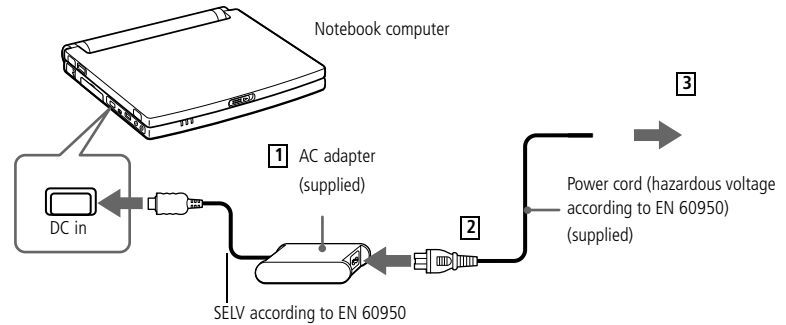

 You can also purchase the high-capacity PCGA-BP52 / BP54 battery pack as a separate option.

Using Battery Power

You can use a battery pack as a source of power.

The PCGA-BP51 battery pack supplied with your computer is not fully charged at the time of purchase. Follow the steps below to insert and charge the battery pack.

To insert the battery pack

- 1 Move the lock lever on the bottom of the computer to the UNLOCK position.

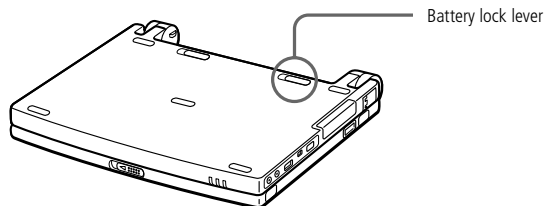

- 2 Align the grooves and tabs on the battery with the tabs and notches on the back of the computer, and then slide the battery towards the computer until it clicks into place.

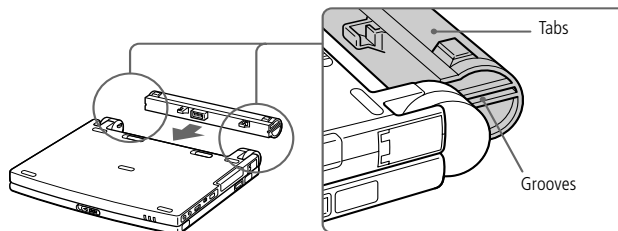

- 3 Slide the lock lever into the LOCK position to secure the battery on the computer.

 You can also purchase the high-capacity PCGA-BP52 / BP54 battery pack as a separate option.

To charge the battery pack

- 1 Connect the AC adapter to the computer.
- 2 Insert the battery pack.

The computer automatically charges the battery (the battery indicator light flashes in a double blink pattern as the battery charges). When the battery is 85% full, the battery indicator light turns off. This process takes approximately one and one half hours. To charge the battery completely, continue charging for an additional hour.

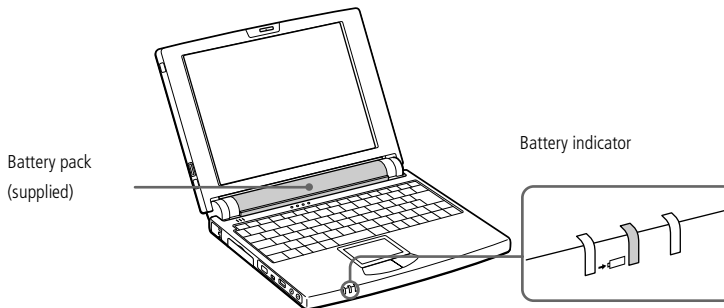

Battery Indicator Light Status	Meaning
On	The computer is using battery power.
Single blink	The battery is running out of power.
Double blink	The battery is charging.
Off	The computer is using AC power.



When the battery is running out of power, both the battery and power indicators blink. To determine the time the battery lasts, please refer to "Displaying Battery information" in your Software Guide.

Keep the battery pack in the computer while it is directly connected to AC power. The battery pack continues to charge while you are using the computer.

If the battery level falls to below 10%, you should either attach the AC adapter to recharge the battery or shut down your computer and insert a fully charged battery.

You can extend battery life by changing the power management modes in the PowerPanel utility. See your Software guide, in "Controlling Power Management".

The battery pack supplied with your computer is a lithium ion battery and can be recharged any time. Charging a partially discharged battery does not affect battery life.

The battery indicator light is on while you use the battery pack as a power source. When the battery life is nearly depleted, the battery indicator starts flashing.

For some software applications and some peripheral devices, your computer may not enter system hibernation mode when battery life is low. To avoid loss of data when using battery power, you should save your data frequently and manually activate a power management mode, such as system suspend or system hibernation.



! You may lose data if you remove the battery pack while the computer is on and not connected to the AC adapter or if you remove the battery while the computer is in system suspend mode.

 You can remove the battery pack without turning off the computer when it is connected to the mains voltage (AC adapter).

Before you remove/insert the battery pack, close the cover.

To remove the battery pack

- 1 Turn off the computer and close the cover.
- 2 Slide the lock lever to the UNLOCK position.
- 3 Slide the release lever to the UNLOCK position and slide the battery away from the computer.

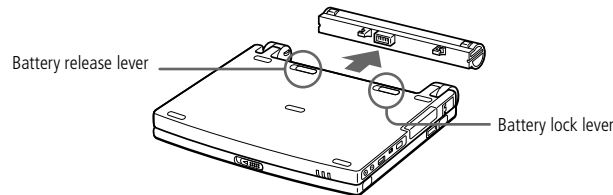

Starting Your Computer

- 1 Slide the LCD lock lever in the direction of the arrow, and lift the cover.

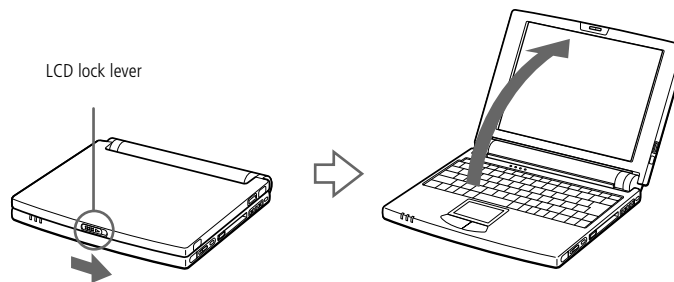

- 2 Slide the power switch on the right side toward the front of the computer until the green power indicator light turns on.

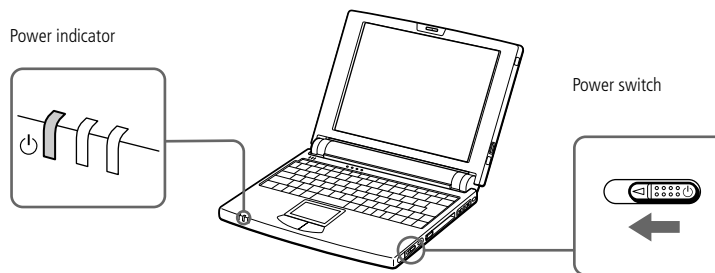

- 3 If necessary, adjust the brightness controls for the LCD display with Fn+F5. To increase the brightness, use the up or right arrow keys. To decrease use the down or left arrow keys.

 If you hold the power switch in the on position for more than four seconds, the computer will turn off.

! To avoid potential loss of data, follow these steps to shut down your computer.

 Respond to any prompts warning you to save documents.

 If you are unable to shut down your computer using the steps described above, press the Ctrl+Alt+Delete keys at the same time to restart the computer. If you are unable to restart the computer in this way, you can slide the power switch forward and hold for four seconds. This operation may result in data loss.

During a period of inactivity, you can conserve battery life by using System Suspend mode. See "Controlling Power Management" in your Software Guide for further details.

Shutting Down Your Computer

- 1 Click the Start button on the Windows® 98 Second Edition taskbar.
- 2 Click Shut Down at the bottom of the Start menu to display the Shut Down Windows dialog box.

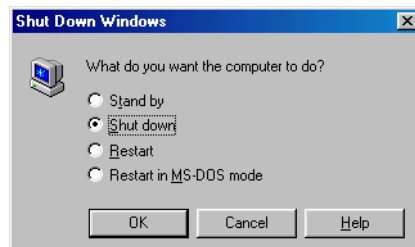

- 3 Select Shut down.
- 4 Click on OK.
- 5 Wait for your computer to turn off automatically. The power indicator will turn off.
- 6 Turn off any peripheral connected to your computer.

 You must connect your phone line before using any online services, including the online registration service. Please refer to "Connecting to a phone line".

To access the on-line Registration web page, you must have a connection to the internet.

You need to plug in the PC Card Modem* and the phone line to use the communication features described in this manual.

*Depending on the model, this accessory could be optional.

Registering Your Computer

You can take advantage of Sony's commitment to quality customer support and receive the following benefits by registering your computer with Sony:

- **VAIO-Link** – You can contact VAIO-Link by telephone, fax or e-mail (see your Customer Service Guide for addresses and phone numbers).
- **Guarantee** – Protect your investment. See the Guarantee Card for the terms and conditions and please refer to your Customer Service Guide for more information.

Follow these steps to use the Sony Notebook Computer's online registration service:

- 1 Click on the Welcome button on your Desktop,
- 2 Click Next,
- 3 Click Internet,
- 4 Fill in your Registration card fields,
- 5 Scroll down to the bottom of the form and click Send,
- 6 Click OK.

Using the Keyboard

Your keyboard is very similar to a desktop computer's, but the keyboard has additional keys that perform specific notebook computer-related tasks.

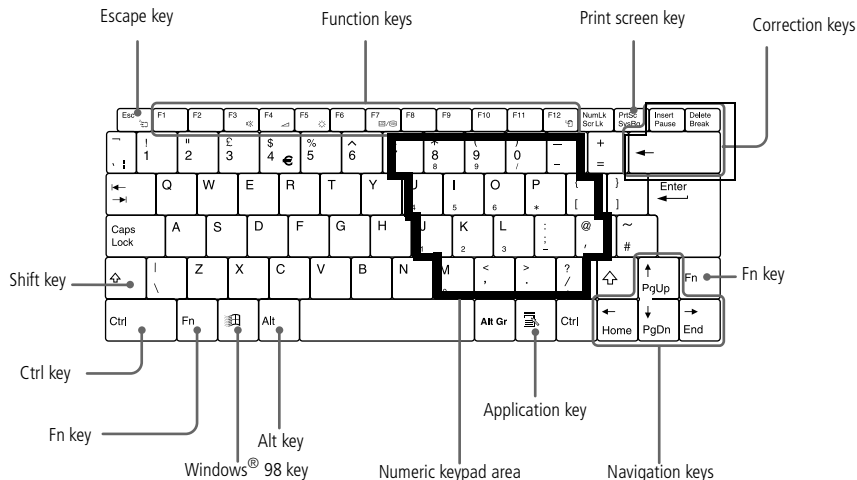









Keys	Descriptions
Numeric keypad area	Contains the keys found on a typical calculator. Use the numeric keypad area to type numbers or to perform mathematical calculations such as addition and subtraction. Note that you must press the Num Lock key to activate the numeric keypad. (When you do so, the Num Lock light will illuminate.)
Navigation keys	Several keys are devoted to moving the cursor on the screen.





<i>Keys</i>	<i>Descriptions</i>
Correction keys	The Insert, Back Space, and Delete keys enable you to make corrections in your documents.
Function keys	The twelve function keys along the top of the keyboard are used to perform designated tasks. For example, in many applications, F1 is the Help key. The task associated with each function key may vary from one application to the next.
Escape key	The Esc (Escape) key is used to cancel commands.
Print Screen key	The Print Screen key takes an electronic snapshot of the screen and places it in the Windows Clipboard. You can then paste the screen shot into a document and print it.
Operator keys	Several keys are always used with at least one other key: Ctrl, Alt, and Shift. When held down with another key, the Ctrl (Control) and Alt (Alternate) keys offer another way to give commands. For example, in many applications, instead of choosing the Save command from a menu, you can hold down Ctrl and press S (referred to as Ctrl+S). The Shift key is used to produce capital letters or special symbols such as @ and \$.
Windows [®] 98 key 	The key with the Windows [®] logo displays the Windows [®] 98 Start menu; it's the equivalent of clicking the Start button on the task bar. See "Combinations and functions with the Windows [®] 98 key" for further details.
Fn key	The Fn key is used in combination with other keys to issue commands. See "Combinations and functions with the Fn key".

<i>Keys</i>	<i>Descriptions</i>
Applications key 	The Applications key displays a shortcut menu of context-sensitive choices; pressing this key is the equivalent of clicking the right mouse button.

Combinations and Functions with the Windows® 98 Key

<i>Combinations</i>	<i>Functions</i>
 + F1	Displays Windows Help
 + Tab	Switches the selected button on the taskbar.
 + E	Displays Windows Explorer.
 + F	Displays the Windows Find: All Files window to find a file or folder. This is the equivalent of selecting Find and then Files or Folders from the Start menu.
 + Ctrl + F	Displays the Windows Find: Computer window where you can locate other computers. This is the equivalent of selecting Find and then Computer from the Start menu.
 + M	Minimizes all displayed windows.
Shift +  + M	Returns all minimized windows to their previous size.
 + R	Displays the Run window. This is the equivalent of selecting Run from the Start menu.

Indicators

















<i>Indicator</i>	<i>Functions</i>
Information 	Turns on when the PPK Timer is set. Turns off when the PPK Timer is not set or the PPK Timer setting is inactive (such as when the computer's power is off or in System Hibernation mode).
Power 	Power on: lights green. System Idle mode: lights amber. System suspend mode: flashes amber.
Battery 	Indicates the status of the battery inserted in the computer.
Hard disk 	Lights when data is read from or written to the hard drive. Do not enter System Suspend mode or turn off the computer when this indicator light is on.

<i>Light</i>	<i>On</i>	<i>Off</i>
Num Lock	Turns on when the number keys area in the numeric keypad are active.	Turns off when the alphanumeric character keys in the keypad area are active.
Caps Lock	Turns on when the letters appear in uppercase as you type. The Shift key lowers the case of typed letters when Caps Lock is on.	Turns off when letters appear in lower case as you type (unless if you hold down the Shift key).
Scroll Lock	Turns on when the screen scrolls differently. (depends on the application. No effect in many applications.)	Turns off when information moves across the display normally.

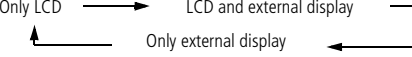

 Some functions are not available until Windows launches.

Combinations and Functions with the Fn Key

Combinations/ Feature	Functions
Fn+  (ESC) System Suspend	Puts the system into System Suspend mode, a power management state. To return the system to the active state, press any key.
Fn+  (F3) Speaker switch	Toggles the built-in speaker on and off.
Fn+  (F4) Speaker volume	Adjusts the built-in or external speakers' volume. To increase volume, press Fn+F4 and then  or  To decrease volume, press Fn+F4 and then  or 
Fn+  (F5) Brightness control	Adjusts the brightness of the LCD. To increase light intensity, press Fn+F5 and then  or  To decrease light intensity, press Fn+F5 and then  or 
Fn+  /  (F7) Switch to the external display	Toggles between the LCD, external display (connected to the Monitor connector) and both LCD and external display. 
Fn+  (F12) System Hibernation	Provides for the lowest level of power consumption. When you execute this command, the states of the system and of the peripheral devices are written to the hard disk and the system power is turned off.
Fn+B Bass Boost	Toggles the Bass Boost function off and on. This feature is available with headphones only.

<i>Combinations/ Feature</i>	<i>Functions</i>
Fn+D Video standby	Darkens the LCD in order to save power.
Fn+F Change the display size	Zooms the display size in or out when the display is set to less than maximum resolution.
Fn+S System Idle	Puts the system into Idle mode, a power management state. To return to the active state, press any key.



See Mouse Help for information on touchpad features, such as clicking both buttons simultaneously, adjusting touchpad speed, Web Assist, Tap Off, and Easy Launcher functions. To access Mouse Help, press the Start button, select Settings, and then select Control Panel. Click the Mouse icon in the Control Panel and click the Help button.

Using the Touchpad

The keyboard contains a cursor-pointing device called a touchpad. You can point to, select, drag, and scroll objects on the screen using the built-in touchpad.

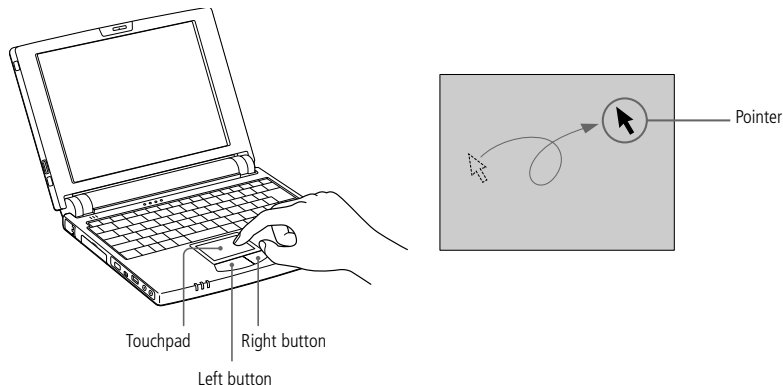

<i>Action</i>	<i>Description</i>
Point	Slide one finger on the touchpad to place the pointer on an item or object.
Click	Press the left button once.
Double-click	Press the left button twice.
Right-click	Press the right button once. In many applications, this action displays a shortcut menu of context-sensitive choices.
Drag	Slide one finger while pressing the left button.

Scroll Move your finger along the right edge of the touchpad to scroll vertically. Move your finger along the bottom to scroll horizontally. (The scroll function is available only with applications that support a touchpad scroll feature.)

 The supplied floppy disk drive should be used only with this computer. You can not use this floppy disk drive with another computer.

To use another USB device, such as a USB mouse, at the same time, connect the i.LINK™ port replicator to your computer, then plug another USB device into the USB connector on the i.LINK™ port replicator.

Using the Floppy Disk Drive

You can connect the floppy disk drive to the USB connector on your computer:

To connect the floppy disk drive

Plug the USB cable into the USB connector. The VAIO logo on the disk drive should be facing up.

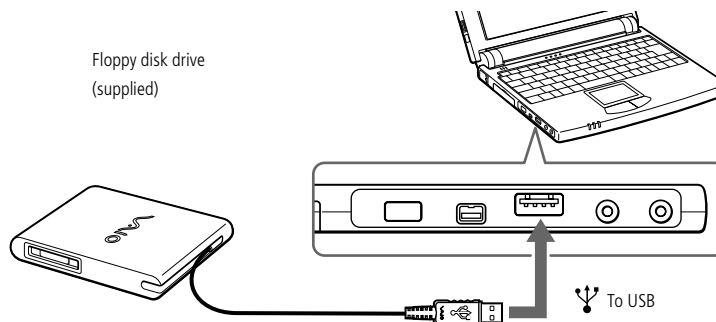

To insert a diskette

- 1 Hold the diskette with the label side facing up.
- 2 Gently push the diskette into the drive until it clicks into place.

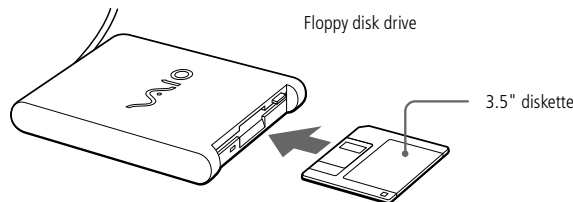

To remove a diskette

When you finish using the diskette, wait until the LED indicator turns off and then press the Eject button to remove the diskette.

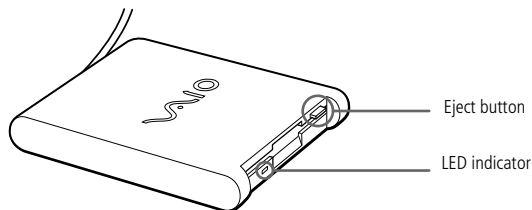

To remove the floppy disk drive

Wait until the LED indicator turns off, and then unplug the USB cable from the computer.

 Do not press the Eject button while the LED indicator is on. It may damage the diskette.

If the diskette does not come out by pressing the Eject button, disconnect the floppy disk drive from the computer.

Using the Floppy Disk Drive

To carry the floppy disk drive

Fold the floppy disk cable into the compartment on the side of the floppy disk drive.



 When the computer is in System Suspend or System Hibernation mode, you cannot insert a disc.

The procedures for connecting the CD-ROM drive may vary, depending on the CD-ROM drive.

See the manual supplied with your CD-ROM drive for more information on use.

 To enjoy audio CDs, you need to connect the optional PCGA-CD51 CD-ROM drive.

To play an audio CD with the PCGA-CD5 CD-ROM drive*, connect headphones or external speakers to your CD-ROM drive and change the settings as below:

- 1> Click the Start button, select Settings and click Control Panel;
- 2> Click the Multimedia icon
- 3> Click the Music CD tab and make sure the "Enable digital CD audio for this CD-ROM device" box is unchecked.

CD-ROM Drive

You can use the CD-ROM drive supplied* with your notebook computer to read CD-ROMs, Audio CDs, CD Extras and Video CDs.

* Depending on the model, could be optional.

! Some PC cards may require you to disable idle devices when using the PC card. You can use Sony Notebook Setup to disable devices. Please refer to "Sony Notebook Setup" in your Software Guide for details.

Be sure to use the most recent software driver provided by the PC card manufacturer.

If an "!" mark appears on the Device Manager tab in the System Properties dialog, remove the software driver and then reinstall it.

You may not be able to use some PC cards or some functions within the PC card with this computer.

You do not need to shut down the computer before inserting or removing a PC card.

To insert a PC Card Modem, please refer to the "PC card modem" section for details.

Using PC Cards

Your computer includes a PC card slot. PC cards allow you to connect portable external devices.

- 1 Pull the PC card RELEASE button up away from the computer and push it in toward the computer.

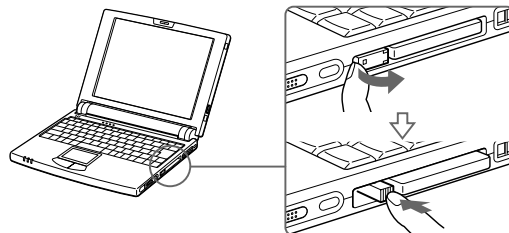

- 2 Remove the PC card slot protector.

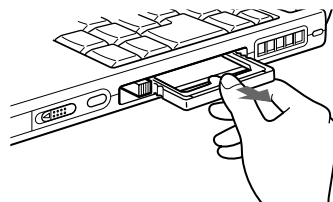

- 3 Insert the PC card into the PC card slot, front label facing up. Gently push the card into the slot until the card is fixed into the connector. The release button will then come out. Pull the release button, then knock it down towards the slot.

Using PC Cards

Some devices may not function properly if you repeat Returning to Normal Mode from System Suspend Mode or System Hibernation mode. The computer will return to its original state if you restart it.

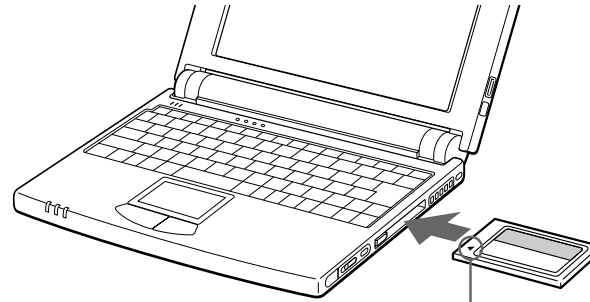

Insert in the direction of the arrow

 Do not force a card into the slot. It may damage the connector pins. If you have difficulty inserting a card, check that you are inserting the card with the correct orientation. See the manual supplied with your PC card for more information on use.

For some PC cards, if you alternate between normal power operation and the system suspend or system hibernation power management modes while the card is inserted, you may find that a device connected to your system is not recognized. Reboot your system to correct the problem.

While the card is inserted, your computer may not enter the System Hibernation power management mode. It may enter the System Suspend mode. It is recommended to remove the card when your computer enters the System Hibernation mode by pressing Fn + F12 keys or by using the PowerPanel utility, and when it is set to enter the System Hibernation mode automatically while using a battery as the source of power.

To remove a PC card

Follow the steps below to remove the PC card while your computer is on. If it is not removed properly, your system may not work properly. When your computer is off, skip the steps 1 to 5.

- 1 Click the start button on the Windows[®] 98 taskbar, point Settings, then click Control Panel.
- 2 Double-click PC card.
- 3 Click the name of the PC card in the list, then click the Stop button.
- 4 Click OK.
- 5 Press the PC card release button.
- 6 Gently grasp the card and pull it out.

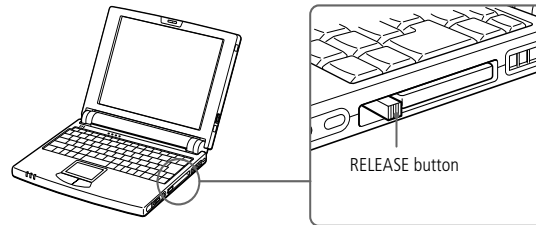

Using a Programmable Power Key (PPK)

Press a programmable power key to start your favorite software without having to click the shortcuts on the desktop.

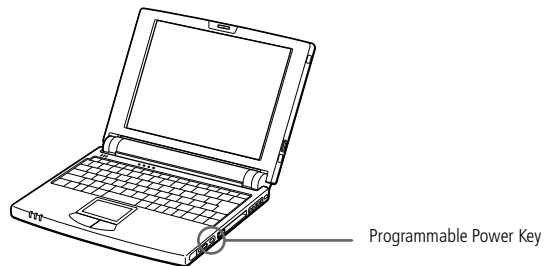

PPK default options

Use a programmable key by simply pressing it, or in combination with other keys on your keyboard: Shift + PPK, Ctrl + PPK or Alt + PPK.

When your computer is off, press PPK, and the system will be powered and launch the appropriate application.

The factory settings for the buttons are:

<i>Key or combination</i>	<i>To open or access...</i>
PPK	The EULA
Alt + PPK	E-mail (Outlook Express)
Shift + PPK	Sony Notebook Setup

Using the Programmable Power Key with other software

You can also choose to start other applications by pressing a programmable power key in combination with the Alt, Ctrl, or Shift keys. See “Starting Your Favorite Software With PPK Setup” in your Software Guide for further details.

Launching applications with the Timer

Use the PPK Timer to launch applications periodically or to let applications work while you don't use your computer. See “Using the internal timer:” in your Software Guide for details.



✎ When you use Smart Connect to connect two VAIO computers, you must assign each computer a unique name by which it can be identified when the two computers are networked.

✎ i.LINK cables compatible with your VAIO notebook include cables with the following part numbers: VMC-IL4415 (a 1.5 meter cable with a 4-pin connector at each end), VMC-IL4408A (a 0.8 meter cable with a 4-pin connector at each end).

Using Smart Connect

With Smart Connect you can copy, edit or delete files on another VAIO computer (equipped with Smart Connect) connected to your computer with an i.LINK™ cable.

You can also print a document on a printer connected to another VAIO computer.

See the online user guide of Smart Connect for more information.

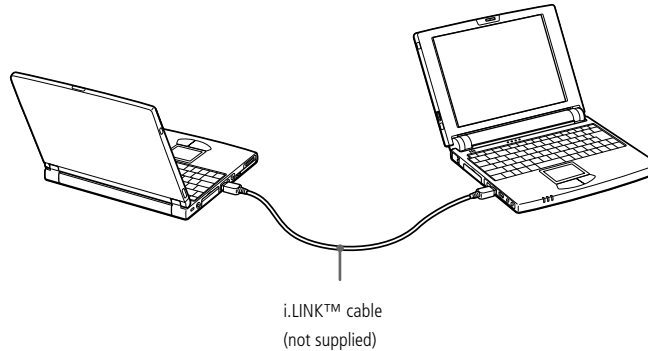

👉 When performing a data transfer with any software using infrared, enable the IrDA in the Control panel of Windows, as follows:

1. In the Control panel, choose Infrared, then Options;
2. Check Enable infrared communication, then click OK.
3. As soon as your transfer is finished, disable Infrared in the Control panel to reduce the power consumption.

Using Infrared Communication Devices

Your computer includes an infrared port. You can use this port to communicate with other infrared-equipped devices with compatible protocols, such as a digital still camera or other computers.

To use Infrared Communication with a Digital still Camera

Align the infrared ports on the computer and the digital camera so that they are in a direct line.

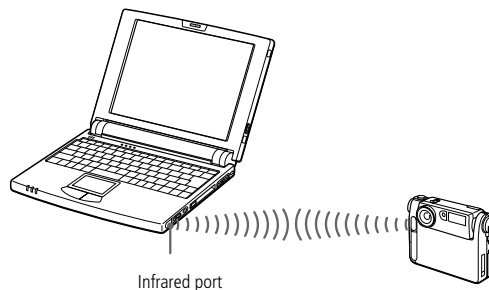

To use Infrared Communication with another Computer

Align the infrared ports on the two computers so that they are in a direct line.

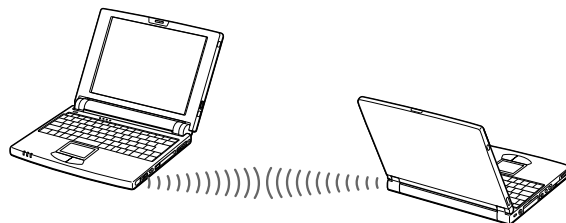

Using Infrared Communication Devices

🔍 Check the Status tag of the Infrared Monitor in the Windows Control Panel to determine if the infrared device has been detected.

If the two devices are too far apart or too close together, data transfer may be interrupted or there may be noise in the transmission.

Do not cover the infrared ports with your hand or any other objects.

Avoid direct sunlight, fluorescent light, or flashing incandescent light near the infrared ports.

See the manual that came with your digital still camera or other infrared communication device for more information on installation and use.

The active area of infrared transmission extends about 1m (39 ³/₈ inches) with a radius of 15 degrees.

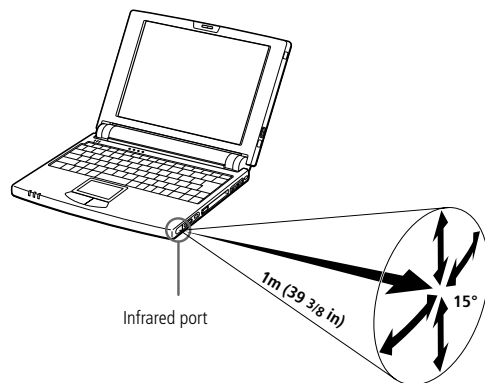

 If the battery level falls to below 10 percent, you should either attach the AC adapter to recharge the battery or shut down your computer and insert a fully charged battery.

Using Power Saving Modes

When you use a battery as the source of power for your computer, you can take advantage of power management settings to conserve battery life. In addition to the normal operating mode, which allows you to turn off specific devices, your computer has three distinct power saving modes: System Idle, System Suspend and System Hibernation.

When using battery power, you should be aware that the computer automatically enters System Hibernation mode when the remaining battery charge drops below 7 percent, regardless of the power management setting you select. See your Software guide, in "Controlling Power Management" for more information.

Normal Mode

This is the normal state of your computer when it is in use. The green power indicator light is on in this mode. To save power, you can turn off a specific device such as the LCD or the hard disk.

System Idle Mode

This mode is convenient if you don't need to use your computer for a short period. The hard disk and the video display enter a low power state and the CPU clock and processor stop. The power indicator light is amber in this mode.

To activate System Idle mode

Press Fn+S. You can also enter system Idle mode by using the PowerPanel utility.

To return to normal mode

Press any key.

 You cannot resume from System Idle by clicking with a mouse or the touchpad.

 If you slide the power switch forward and hold for more than four seconds, the computer will switch off automatically.

 When the computer is in System Suspend or System Hibernation mode, you cannot insert a disc.

When returning from System Hibernation mode, the system status stored on the hard disk is erased and the computer starts normally if you slide the power switch forward and hold for more than four seconds.

System Suspend Mode

The computer saves the current state of the system in RAM and switches off power to the CPU. The amber power light flashes in this mode.

To activate System Suspend mode

Press Fn+Esc, or slide the power switch forward quickly. You can also use the PowerPanel utility to enter System Suspend mode.

To return to normal mode

Press any key.

System Hibernation Mode

The state of the system is saved on the hard disk and power is turned off. The power indicator light is off in this mode.

To activate System Hibernation mode

Press Fn+F12. You can also use the PowerPanel utility to enter System Hibernation mode.

To return to normal mode

Turn on the computer by sliding the power switch forward. The computer returns to its previous state.

- ❑ Steps to return to normal mode:
System hibernation → System suspend → System Idle
System suspend requires less time than System hibernation.
- ❑ Power consumption:
System idle → System suspend → System hibernation
System idle uses more power than System hibernation.

 Before you connect peripherals, turn off the computer and all peripherals.

Connect the power cord only after connecting all cables.

Turn on the computer only after turning on all peripherals.

Connecting peripheral devices

You can add functionality to your computer by connecting or using any of these peripherals and enjoy the software described in the “About the Software” user guide:

- ❑ PC card modem* (page 48)
- ❑ i.LINK™ Port Replicator (page 50)
- ❑ Printer (page 53)
- ❑ External Display (page 55)
- ❑ Desktop Computer or Serial Device (page 57)
- ❑ i.LINK™ device (page 61)
- ❑ MiniDisc® deck with MD Player (page 63)
- ❑ External Speakers (page 65)
- ❑ External Microphone (page 66)
- ❑ Universal Serial Bus (USB) Device (page 67)

PC card modem*

Use your PC card modem to connect to a phone line and access the WWW.

Connecting to a phone line

You need to connect a phone line to take advantage of online services, the Internet and to register your computer and software online.

- 1 Use the PC card slot of your notebook computer. Pull the PC card release button away from the computer. Remove the PC card slot protector as described in "Using PC Cards" on page 37.
- 2 Insert the PC card modem in the slot of the computer (label facing up), push it gently until the release button ejects completely. Put back the release button.

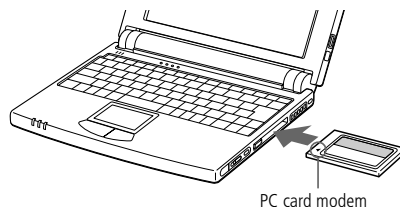

- 3 Plug the phone line jack into the connector on the PC card.
- 4 Plug the other end into the wall jack (using a phone plug if needed).

* Depending on the model, could be optional.

PC card modem*

☞ Phone cable and connectors are TNV (Telecommunication Network Voltage), according to EN60950.

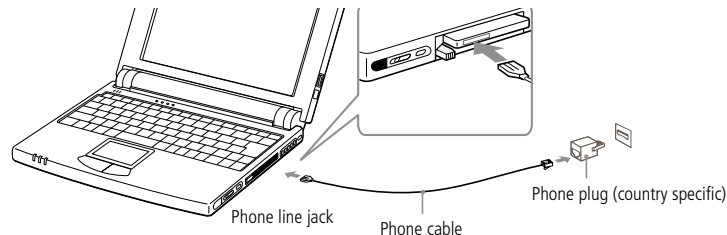

Choosing an optional PC Card Modem

Your VAIO notebook computer is already configured to use the **"COM One Platinum Card MC221 Discovery V.90"** PC Card modem. If this PC Card is not delivered with your notebook, you can purchase a COM One Platinum Card MC221 Discovery V.90 PC Card modem, which supports 56 Kbits/s data transfer rates and 14.4 Kbits/s fax rates.

You can purchase the **"COM One 4 in 1 Platinum Card MC220"** modem as well. This card supports 56 Kbits/s data transfer rates and 14.4 Kbits/s fax rates, Ethernet, ISDN and Sony GSM data connectivity, with the appropriate optional kits*, allowing you to connect to a network, send e-mails and short messages, etc.

* For more information on the COM One Platinum Card Modems and the connectivity kits, browse to the Sony VAIO Direct web site or contact your dealer

i.LINK™ Port Replicator

✎ All connectors are SELV (Safety Extra Low Voltage) according to EN60950.

You cannot use the optional PCGA-PR5 port replicator with your computer.

i.LINK™ Port Replicator

You can use the PCGA-UPR5 i.LINK port replicator (supplied) to connect peripheral devices such as a printer or an external display.

The port replicator features five ports, including an i.LINK™ port.

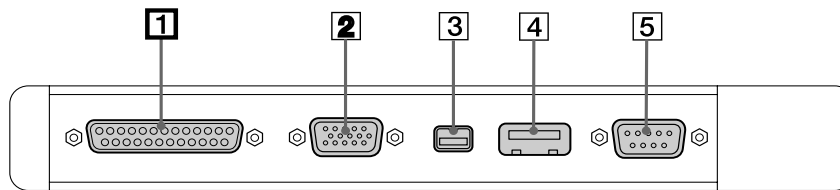

1  Printer (page 53)

4  USB (page 67)

2  Monitor (page 55)

5  IOIO Serial (page 57)

3  i.LINK™ device

To attach your computer to the port replicator

- 1 Turn off the computer.
- 2 Open the port replicator connector cover on the left side of the computer.

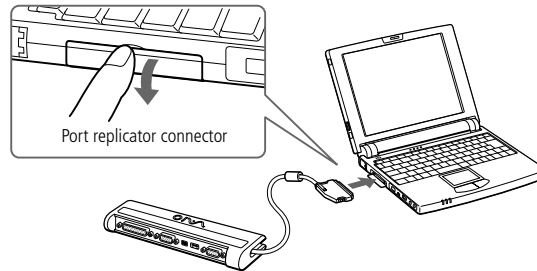

- 3 Plug the port replicator cable into the port replicator connector on the computer.

To remove the port replicator

- 1 Turn off the computer.
- 2 Press both sides of the port replicator cable connector and unplug the cable from the computer.

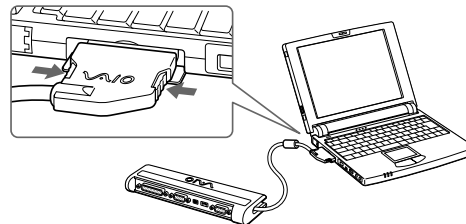

- 3 Fold the port replicator cable into the compartment on the side of the port replicator.

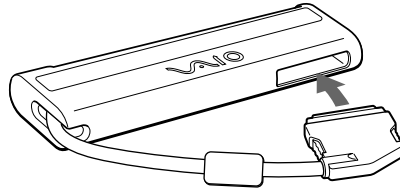

📖 See the manual supplied with your printer for more information on installation and use.

Before using the printer, you may need to change the Printer setting in the Sony Notebook Setup software. Please refer to "Sony Notebook Setup" in the Software Guide for further details.

Turn off your computer and the printer, unplug the AC adapter and the power cord before connecting the printer.

Printer

You can use the port replicator to connect a Windows[®] 98-compatible printer or other parallel port device to your computer.

To connect a printer

Use the 🖨️ symbol to locate the Printer connector on the port replicator. Plug the printer cable (supplied with the printer) into this connector.

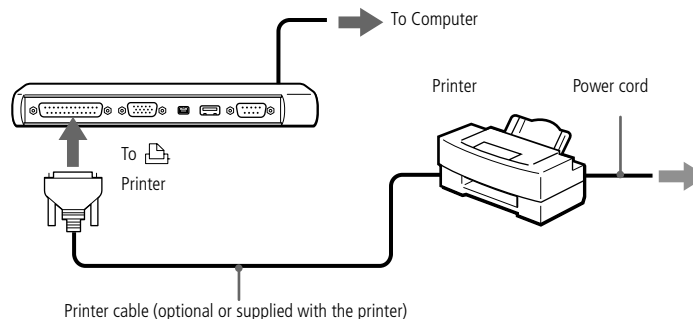

To connect a printer using the USB connector

You can connect a Windows[®] 98-compatible USB printer to your computer.

- ❑ Use the 🖨️ symbol to locate the USB port on your computer and printer.
- ❑ Plug an optional USB printer cable into the USB connector.

Resetting your computer for printer use after resuming from a power saving mode

Your connected printer may not function after the computer resumes from a power saving mode. When this occurs, follow the procedures below to reset the printer connection:

- 1 Right-click the My Computer icon on the desktop, and then select Properties.
- 2 Click the Device Manager tab.
- 3 Select Apply, and then click OK.

The printer should now function properly.



✎ Turn off your computer and the peripherals, unplug the AC adapter and the power cord before connecting the external display.

Connect the power cord after connecting all other cables.

Turn on the peripherals, then turn on your computer.

Some computer displays or projectors may not be used as a monitor with the LCD on your computer display at the same time.

The i.LINK port replicator allows you to connect an external display eliminating the need for the display adapter.

See the manual supplied with your computer display for more information on installation and use.

External Display

You can connect an external display to your notebook computer. For example, you can use the computer with the following:

- ❑ Computer display (monitor)
- ❑ Projector.

Use your external display as a second screen, or set up a virtual desktop (Please refer to “Using the Dual Display Function” in your Software Guide for further details).

To connect a computer display

Use the I/O port replicator connector on the computer. Plug the i.LINK™ port replicator or the optional PCGA-DA5 display adapter into this connector. If necessary, plug one end of the display's power cord into the display, and the other end into an AC outlet.

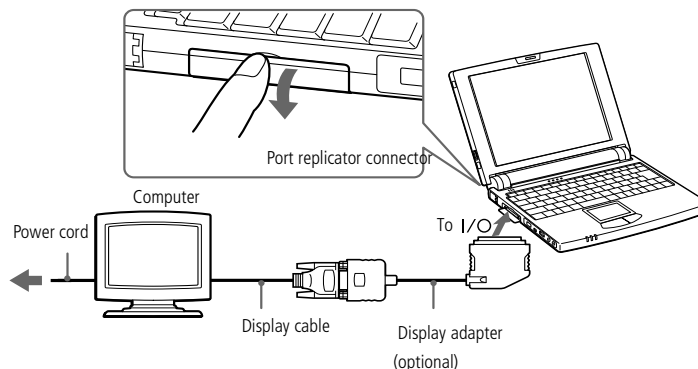



External Display

See the manual supplied with your projector for more information on installation and use.

You may not be able to display the computer's LCD and the external display together, depending on the types of computer display and projector used.

To connect a projector

You can use a projector as an external display, such as the Sony LCD Projector.

- 1 Use the  symbol to locate the Monitor connector. Plug the RGB signal cable into this connector.
- 2 Use the  symbol to locate the Headphone connector. Plug the audio cable into this connector.

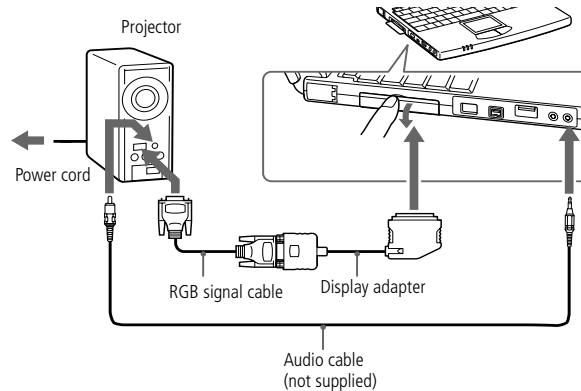

To remove the display adapter

Press both sides of the display adapter connector and unplug it from the computer.

To select a display

When you connect an external display to the monitor connector, you can press Fn+F7 to toggle the output between the Liquid Crystal Display (LCD), the external monitor, or both devices.

See your Software guide in "Selecting the Display Mode" for more information.

✎ Turn off your computer and the peripherals, unplug the AC adapter and the power cord before connecting the null-modem cable.

Connect the power cord after connecting all other cables.

Turn on the peripherals, then turn on your computer.

Use a cross cable as null-modem cable. You can not transfer data by connecting a straight cable.

Before purchasing a null-modem cable, make sure to identify the connector's shape.

To transfer data, the software which support the connection by serial cable should be installed on both computers.

Desktop Computer or Serial Device

You can use the port replicator to connect your notebook computer to another computer, or to connect other peripherals, such as the Sony Digital Still Camera.

To connect a desktop computer

Use the  symbol to locate the Serial connector on the port replicator. Plug a null-modem cable (not supplied) into this port and into the serial port on the desktop computer.

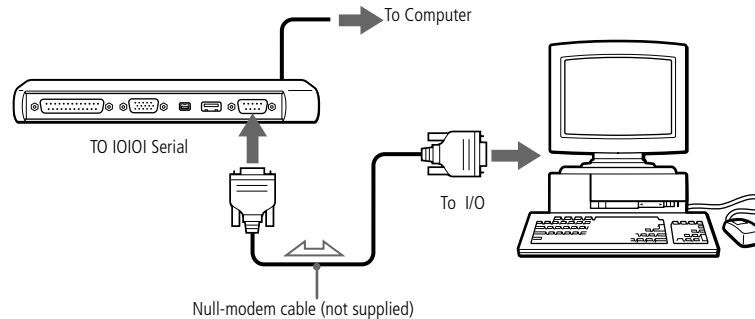

See the manual supplied with your digital camera or other serial device for more information on installation and use.

If you use a digital camera that has an infrared data communication system or other infrared communication device, see "Using Infrared Communication Devices" on page 43 .

To connect a digital still camera

Use the  symbol to locate the Serial connector on the port replicator. Plug the connection cable into this port and into the Digital I/O connector on the digital still camera.

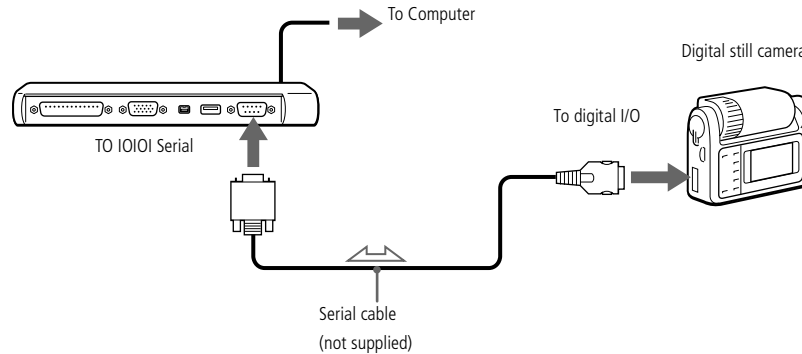

To use diskettes with the Digital Mavica

See the manual supplied with your peripheral for more information on installation and use.

To use diskettes with the Digital Mavica

The Digital Mavica provides you still images you can copy and edit on your computer, using PictureGear software.

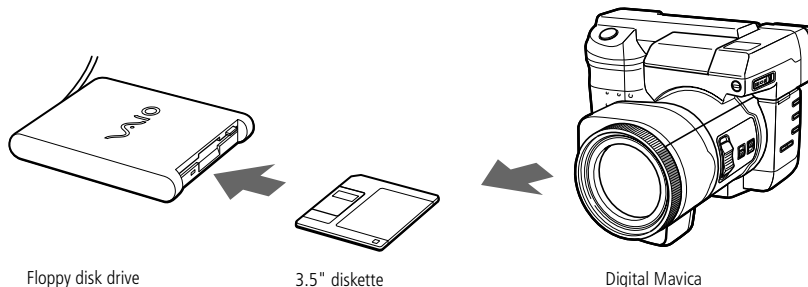
*Follow these steps to transfer the images from your Digital Mavica:*

- 1 Insert the diskette of the Mavica in the FDD drive of your computer and copy them into a dedicated folder.
- 2 Launch the application and open the image to edit or drag and drop it onto the application shortcut. Make the changes you want to the image.
- 3 Save it under the new name and format, if needed.

Memory Sticks™

You can enhance the memory of your digital camera or other digital device with Memory Sticks™. To transfer your data to your computer, insert the Memory Stick™ into the PC Card slot:

- 1 Once you have stored your data from your digital device, insert the Memory Stick™ into the optional PC Card Adapter.
- 2 Insert the PC Card into the slot on your computer (label facing up), push it gently until the release button ejects completely and put back the release button.
- 3 The Memory Stick™ is automatically detected by your system and will appear in your "My Computer" window as a local drive, under the appropriate letter (depending on the configuration of your computer).

Please refer to your Memory Stick™ user guide for precautions and specifications.

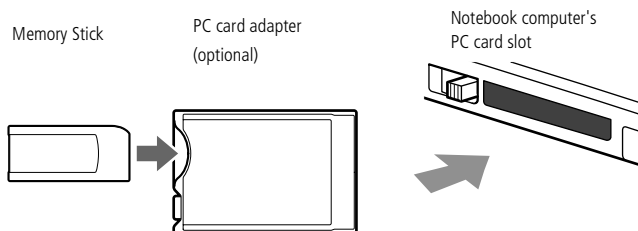

i.LINK™ device

 The Sony digital video camera recorder is taken as example; your digital video camera recorder may need to be connected differently.

See the manual supplied with your digital video camera recorder for more information on installation and use.

Do not connect more than one digital video camera at a time. The software supplied with your computer will not recognize multiple cameras.

i.LINK™ device

Your computer includes an i.LINK (IEEE1394) connector, which you can use to connect to an i.LINK™ device such as a digital video camera recorder.

To connect a digital video camera recorder

- 1 Plug one end of the i.LINK™ cable into the i.LINK™ connector of the computer and the other end into the DV Out connector on the digital video camera recorder.

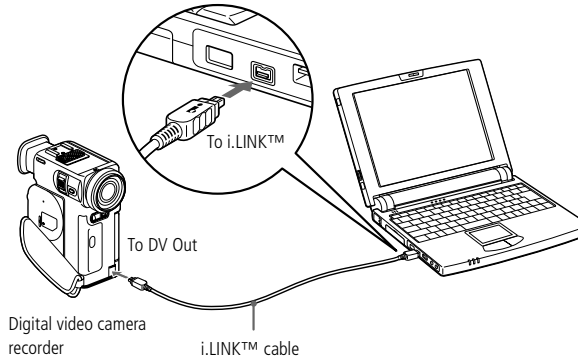

- 2 Launch the DVgate Motion application. Please refer to “DVgate Motion” in your Software Guide for further details.

i.LINK™ device

The software limits the use of more than one digital video camera recorder or i.LINK™ device at the same time.

On Sony digital video cameras, connectors labeled "DV Out", "DV In/Out" or "i.LINK™" are i.LINK™-compatible.

The i.LINK™ connector of your notebook computer does not supply power to external devices generally powered by i.LINK™ connectors.

The i.LINK™ connector supports transfer rates up to 400 Mbps; however, the actual transfer rate depends on the transfer rate of the external device.

The i.LINK™ features available may vary depending on the software applications you use. Please refer to the documentation that came with your software for more information.

 For a list of i.LINK™ cables compatible with your computer, please contact your dealer.

Using Memory Sticks™

If your digital video camera recorder includes a Memory Stick™ slot, you can copy images from it to your computer via a Memory Stick™ Card.

Copy images on the Memory Stick™ Card and insert the card into the optional Memory Stick™/PC Card Adapter, then insert the adapter into the PC card slot of your computer

See "Memory Sticks™" on page 60.

 Refer to your MD deck and CD player manuals to check the specifications.

For further information or if you are not sure of the connection capabilities of your devices, please contact your dealer.

To perform a copy using your computer, you need two CONTROL A1 or Control A1 II and one optical cables, which are maybe sold separately. To purchase them, please contact your dealer.

MiniDisc® deck with MD Player

Use the inter-connectivity and common protocols between Sony audio equipment and your VAIO computer to enjoy the high quality of sound and recordings through optical data transfer.

When you connect a Sony MD deck equipped with a CONTROL A1 or Control A1 II terminal to a Sony CD player (equipped with both digital optical output and CONTROL A1 connector), you can record and edit your MiniDiscs® via your computer. Please refer to “MD Player” in your Software Guide for a description of the software.

MD Player features

To enjoy the MD Player of Media Bar features, you need to connect your computer to the Control A1 connection of your MiniDisc® recorder.

Link your MD deck and CD player with the optical cable and the CONTROL A1 or Control A1 II cable to enjoy:

- ❑ Complete editing and assembly functions: change the order of the numbers on your MD;
- ❑ Use the touchpad or mouse to play and edit MDs, and the keyboard to enter disc and track titles to display on your MD deck while playing;
- ❑ Digital output and input without any noise or loss of data;
- ❑ Drag-and-drop, copy and paste and other functions: your computer is the visual interface of the MiniDisc® recorder.

The Control A1 or Control A1 II features only work with Sony devices. For further information, please refer to your Sony Dealer.

To connect the MD recorder to your computer

- 1 Plug the CONTROL A1 or Control A1 II connecting jack to the MD deck using the CONTROL A1 or Control A1 II connector and the other end to the Serial connector on the port replicator of your computer.

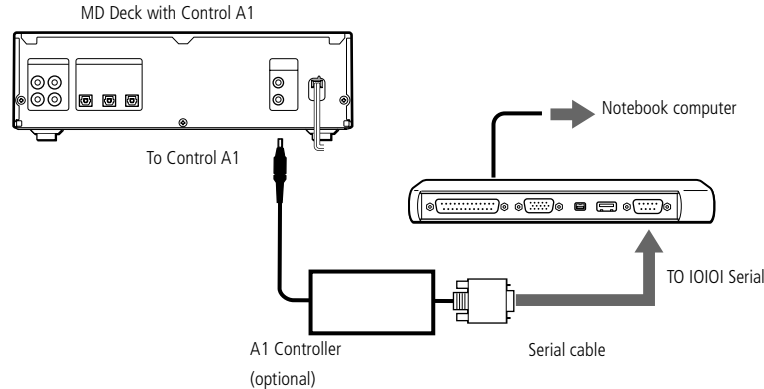

- 2 Plug the optical cable into the Digital Optical output / input of your MD desk.
- 3 Turn on all the devices.
- 4 Launch MD Player to edit the tracks on your MiniDisc®.

 You can not use the optional PCGA-SP5 stereo speakers.

Turn down the volume of the internal speakers before you connect the external speakers.

To adjust the speaker volume, press Fn+F4. See "Combinations and Functions with the Fn Key" on page 20 for details.

Do not place diskettes on the speakers; the speaker's magnetic field may damage the data on the diskettes.

The internal speaker does not work when the external speakers are connected.

External Speakers

You can use the optional PCGA-SP51 stereo speakers with your computer or other speakers designed for computer use.

See the manual supplied with your speakers for more information.

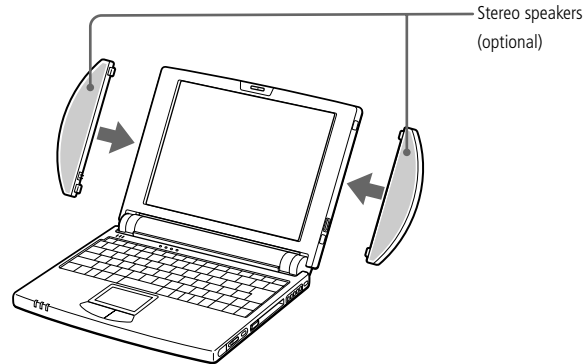

✎ Make sure your microphone is designed for computer use.

See the manual supplied with your microphone for more information on installation and use.

External Microphone

You can enhance the quality of sound input by using an external microphone.

To connect an external microphone

- Use the  to locate the Microphone connector. Plug the microphone cable into this connector.

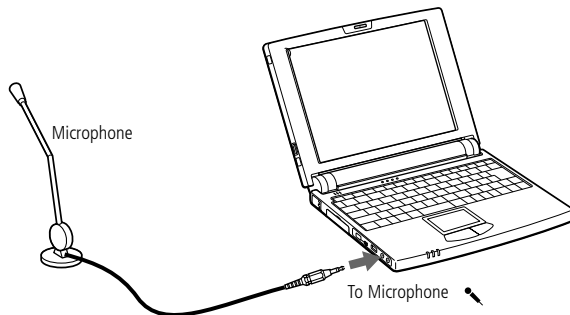

✎ USB ports are included to provide state-of-the-art technology. You may need to install software (device drivers) supplied with your USB device before using the USB device.

Read the manual supplied with your USB device carefully for more information on installation and use.

You can connect the optional Sony USB mouse (PCGA-UMS1). As the driver for PCGA-UMS1 is preinstalled on your computer, you can use this PCGA-UMS1 USB mouse by just connecting it.

To use the supplied floppy disk drive and the USB mouse at the same time, connect the i.LINK™ port replicator to your computer and plug the USB device to the USB connector on the i.LINK™ port replicator.

Universal Serial Bus (USB) Device

You can connect a USB device to your computer.

To connect a USB device

- ❑ Use the  symbol to locate the USB connector. Plug one end of the USB cable into this port and the other end into the USB device.

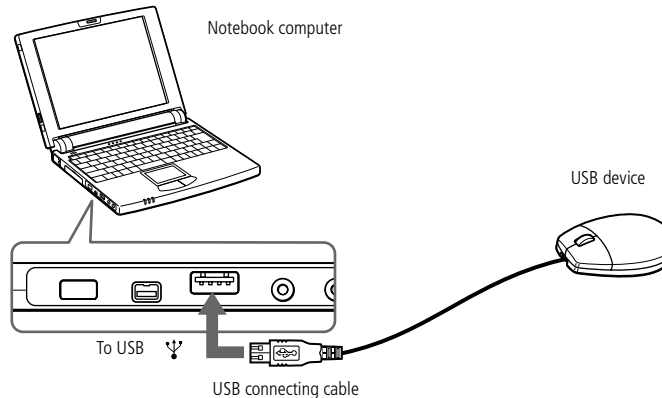

Getting Help

This section describes how to get help and support from Sony, as well as troubleshooting tips for your computer.

See also the on-line FAQ provided on your Documentation CD-ROM.*

About Sony's Support Options

Sony provides several support options for your computer. When you have questions about your computer and the pre-installed software, check these places for answers:

Printed documentation supplied with your computer

- ❑ The Customer Guide explains how to start your computer and use the basic functions. This guide gives you the information to access VAIO-Link.
- ❑ The Setting Up Poster gives you a list of the contents you find in the box, a summary of the bundled applications and the list of specifications of your computer and accessories.

On-line user guides supplied with your Documentation CD-ROM

- ❑ This guide explains how to use your computer, connect peripheral devices. It gives you a packing list and the list of specifications of your computer and accessories.
- ❑ The Software guide lists the pre-installed software titles and explains how to use the utility programs and perform basic computer tasks.
- ❑ The Customer Service Guide gives you complete information on communicating with VAIO-Link Response Centre.

 * Depending on the model, the on-line documentation could be supplied on a floppy disk.

 You need to plug in the PC Card Modem and the phone line to use the communication features described in this manual.

Other sources of information

- ❑ The online help files that accompany your pre-installed software contain instructions on using the software.
- ❑ VAIO-Link: if you have any problem with your computer, you can contact VAIO-Link by telephone, fax or e-mail (see your Customer Service Guide for addresses and phone numbers). Before calling VAIO-Link, try to solve the problem by reading your User Guide (troubleshooting chapter) or the manuals and helpfiles for the peripherals or software.
- ❑ The Sony e-mail support service answers your questions by electronic mail. Just send your question in an e-mail message and a Customer Service Analyst will send you a reply with the answer.
To send a question to Sony e-mail support, please refer to the instructions in your Customer Service Guide.



Troubleshooting

This section describes how to solve common problems you may encounter when using your computer. Many problems have simple solutions, so try these suggestions before you contact VAIO-Link.

Table of troubleshooting methods

- ❑ About the computer and software, see page 70
- ❑ About Digital Video Captures and DVgate Motion, see page 74
- ❑ About the display, see page 75
- ❑ About CD-ROMs and diskettes, see page 75
- ❑ About sound, see page 77
- ❑ About the modem, see page 78
- ❑ About peripherals, see page 80
- ❑ Using the Product Recovery CD-ROMs, see page 82

See also the on-line FAQ provided on your Documentation CD-ROM.*

About the computer and software

My computer does not start

- ❑ Check that the computer is plugged into a power source and that it is turned on. Check that the power indicator on the front panel of the computer indicates that the power is on.
- ❑ Check that the battery packs are inserted properly and that they are charged.
- ❑ Make sure there is no diskette in the floppy disk drive.

 When you reconnect devices, be sure to turn off the computer as described in "Shutting Down Your Computer" on page 23. If you turn off the computer in other ways, it may result in data loss.

- ❑ Confirm that the power cord and all cables are connected firmly, as described in “Connecting a Power Source” on page 20.
- ❑ If you have plugged the computer into an UPS, make sure the UPS is turned on and working.
- ❑ If you are using an external display, check that it is plugged into a power source and turned on. Check that you have switched to the external display and that the brightness and contrast controls are adjusted correctly. Please refer to the manual supplied with your display for details.
- ❑ Moisture condensation may have occurred. Do not use the computer for at least one hour and then turn it on.
- ❑ The internal backup battery of your computer may be low on power. To change the backup battery located on the bottom please contact VAIO-Link.

If any of the above procedures does not work, press the reset switch on the bottom of the computer with a wire and then restart the computer.

When I turn on my computer, the message “Operating system not found” appears and Windows does not start

- ❑ Check the floppy disk drive to see if a non-bootable diskette is in the drive.
- ❑ If a non-bootable diskette is in the drive, eject it and press any key on your keyboard. Windows then starts normally.
If Windows still does not start, follow the procedure below to initialize the BIOS.
- ❑ If the floppy disk drive is empty, follow the steps below to initialize the BIOS:
 - 1 Remove any peripheral devices connected to the computer.
 - 2 Turn the computer off and then turn it on again.
 - 3 Turn on the computer and press the F2 key when the Sony logo appears. The BIOS setup menu screen appears.

- 4 Press the arrow keys to select the Exit menu.
- 5 Press the arrow keys to select Get Default Values and then press the Enter key. The message “Load default configuration now?” appears.
- 6 Check that [Yes] is selected and then press the Enter key.
- 7 Press the arrow keys to select Exit (Save Changes) and then press Enter.

The message “Save configuration changes and exit now?” appears.

- 8 Check that [Yes] is selected, then press the Enter key. The computer will restart.
- 9 If your computer still displays the message “Operating system not found” and Windows does not start, please contact VAIO-Link.

When I turn on my computer, the message “No system disk or disk error. Replace and press any key when ready” appears and the computer does not start.

Remove the diskette from the floppy disk drive by pressing the Eject button and then press any key.

My computer does not shut down

It is best to shut down your computer using the Shut Down command on the Windows® 98 Start menu. Using other methods, including those listed here, may result in loss of unsaved data. If the Shut Down command does not work properly, follow these steps:

- Restart the computer by pressing Ctrl + Alt + Delete twice.
- If this does not work, slide the power switch forward and hold it for at least four seconds, this turns off the power.
- Unplug the computer from the AC adapter and remove the battery pack from your computer.

I cannot put my computer in any Standby mode (Hibernation, Idle or suspend): the system gets unstable

Quit all the applications you launched and restart the system. If you don't succeed, please refer to the question "My computer does not shut down" on page 72.

My computer "locks up"

- ❑ Try restarting the computer. On the Windows taskbar, click the Start button, click Shut Down, and then click Restart.
- ❑ If you cannot restart as described in the preceding step, you can restart the computer by pressing Ctrl+Alt+Delete twice (or by pressing Ctrl+Alt+Delete once and then clicking Shut Down in the Windows Task manager).
- ❑ If the previous step does not work, slide the power switch toward the front and hold it for at least four seconds. This turns off the power.
- ❑ If your computer locks up while playing a DVD-ROM/ CD-ROM, stop the DVD-ROM/ CD-ROM, and restart the computer by pressing Ctrl+Alt+Delete twice.

My software program "locks up" or crashes

Contact the software publisher or designated provider for technical support. Please refer to your Software guide for information on how to contact them.

My mouse doesn't work

- ❑ If you are using an external mouse, check that the mouse is plugged into the mouse connector. Please refer to "To connect a USB device" on page 67 for details.
- ❑ If you have connected an external mouse while your computer is on, you must restart your computer.

 Pressing Ctrl+Alt+Delete may result in data loss in files that are currently open.

- ❑ If you are using an optional Sony USB PCGA-UMS1 mouse, check that the mouse is plugged into the USB connector. Please refer to the chapter about “To connect a USB device” on page 67 for details.

The key top comes off

Put it back where it was and press it until it clicks.

When the enter key or the space key comes off, follow the instruction in “Placing a key top” on page 86 .

If you take off the key top intentionally or press it excessively when you replace it, it may cause a malfunction. Handle it with care.

My touchpad interprets a single tap as a double-click

Open the Mouse icon in the Control Panel and change the button assignments in the Mouse Properties dialog box. One of the buttons is assigned to the double-click action.

My computer's fan makes too much noise.

Use the Power Panel utility to silence the fan. Please refer to the Power Panel help for more information.

About Digital Video Captures and DVgate Motion

While I'm recording images to a digital video device using DVgate Motion, my system displays the message "Failed to record to DV deck,Please check deck's power status, cable connection..."

Close all open applications and restart your computer. Frequent recording of images to a digital video device while using DVgate Motion sometimes causes this to occur. For more information on DVgate Motion, see the DVgate Motion online help.

When I am importing images from a digital video device using the Recover Lost Frames option, the speed of the import process slows down.

To increase the speed of the import process, disable the Recover Lost Frames option. Then, set the import starting point (IN point) to two seconds before the point in the video where you want to set and import images. After you have imported the desired images, cut the unnecessary portions using DVgate Clip.

About the display

My LCD does not display anything

- ❑ Check that the computer is plugged into a power source and that it is turned on. Check that the power indicator on the front panel of the computer is on.
- ❑ Check that the battery packs are inserted properly and that they are charged.
- ❑ Adjust the brightness of the LCD (page 30).
- ❑ The computer may be in LCD (video) standby mode. Press any key to activate the display.

The screen image on my external display is not centered or sized properly

Use the controls on your external display to adjust the image. Please refer to the manual supplied with your display for more information.

The video image on my screen is too dark

If an external display is connected to the Monitor connector, disconnect the display.

About CD-ROMs and diskettes

My CD-ROM drive tray does not open

- ❑ Make sure the computer is turned on.

- ❑ Press the Eject button on the CD-ROM drive.
- ❑ If the Eject button does not work, you can open the tray by inserting a sharp, pointed object into the hole to the right of the Eject button.

I can't play a CD-ROM disc

- ❑ Make sure the label of the CD-ROM is facing up.
- ❑ If the CD-ROM disc requires software, make sure the software is installed according to the program's instructions.
- ❑ Check the volume of your speakers.
- ❑ Clean the CD-ROM disc.
- ❑ Moisture condensation may have occurred. Leave the computer for at least 1 hour while it is turned on.

When I double-click an application icon a message such as "You must insert the application CD into your CD-ROM drive" appears and the software does not start

- ❑ Some titles require specific files that are located on the application's DVD-ROM / CD-ROM disc. Insert the disc and try starting the program again.
- ❑ Make sure you place the disc in the tray with the label side facing up.

My floppy disk drive can't write to a diskette

- ❑ The diskette is write-protected. Disable the write-protect feature or use a diskette that is not write-protected.
- ❑ Check that the diskette is properly inserted into the floppy disk drive.

About sound

My speakers are not producing sound

- ❑ The built-in speakers may be turned off. Press Fn+F3 to turn on the speakers.
- ❑ The speaker volume may be turned to the minimum. Press Fn+F4, and then press ▲ or ► or use the Jog Dial to increase the volume.
- ❑ If your computer is powered by battery, check that the battery is inserted properly and that it is charged.
- ❑ If you are using an application that has its own volume control, check that the volume is turned up.
- ❑ Check the volume controls in Windows® 98.
- ❑ If you use external speakers, check that the speakers are properly connected and the volume is turned up. If the speakers have a mute button, make sure it is off. If batteries power the speakers, check that the batteries are inserted properly and that they are charged.
- ❑ If you have connected an audio cable to the Headphone connector, disconnect the cable.

My microphone doesn't work

If you are using an external microphone, check that the microphone is plugged into the Microphone connector. See “External Microphone” on page 66 for details.

There are Two Icons that Control Sound in the Task Bar

The sound for your Notebook Computer is managed by the Yamaha controller .

Installing a peripheral device with audio functions may call the Windows® 98  controller.

To deactivate the Windows[®] 98 controller and delete the icon  :

- 1 Select My Computer from the Start menu
- 2 Select Control Panel
- 3 Open Multimedia
- 4 In the Audio tab, uncheck the box Show volume control on Task Bar.

About the modem

My modem (PC card) doesn't work

- Check that your PC card is properly inserted into your computer (label side facing up).
- Check that your PC card modem has been detected by the system. See “PC card modem*” on page 48.
- Check that the phone line is plugged into your PC card. See “Connecting to a phone line” on page 48 for details.
- Check that the phone line is working. You can check the line by plugging in an ordinary phone and listening for a dial tone.
- Check that the phone number the program is dialing is correct.
- If you connect a GSM phone, make sure that the programming of the supplied PC card is compatible.
- Check that the communication software you are using is compatible with the PC card: make sure that the driver selected in your communication software matches your PC card programming (refer to your communication software user manual).

My modem connection is slow

Many factors influence modem connection speed, including telephone line noise or compatibility with telephone equipment (such as fax machines or other modems). If you think your modem is not connecting properly to other PC-based modems, fax machines, or your Internet Service Provider, check the following:

- ❑ Have your phone company check that your phone line is free from any line noise.
- ❑ If your problem is fax-related, check that there are no problems with the fax machine you are calling and that it is compatible with fax modems.
- ❑ If you are having a problem connecting with your Internet Service Provider, check that the ISP is not experiencing technical problems.
- ❑ If you have a second phone line available, try connecting the modem to that line.

My Modem Cannot Establish a Connection

The modem dialing mode may be incompatible with your telephone line.

Check the dialing mode:

- 1 Open My Computer
- 2 Open the Control Panel
- 3 Open Modems
- 4 Select "COM One Platinum Card Discovery V.90"
- 5 Choose Dialing Properties

Modify the dialing property "Pulse dial" or "Tone dial" according to your telephone line

About peripherals

I cannot use DV devices. The message "DV equipment seems to be disconnected or turned off" appears.

- ❑ Check that the DV device is turned on and that the cables are properly connected.
- ❑ If you are using multiple i.LINK™ devices, the combination of the connected devices may cause unstable operation. In this case, turn off the power to all connected devices and disconnect unused devices. Check the connection and then turn on the power again.

The device, which is connected to the i.LINK connector on the optional i.LINK port replicator, does not work properly.

Use the i.LINK connector on your computer.

The i.LINK device, which is connected to the computer, is not recognized. Or a message appears.

Disconnect the i.LINK device once, then connect it again.

My PC card is not working

- ❑ Make sure the PC card is compatible with Windows® 98.
- ❑ Use the Sony Notebook Setup utility to disable devices you are not currently using.

I cannot print.

- ❑ Check that all the cables of the printer are correctly connected.
 - ❑ Check that your printer is correctly configured and that you have up to date drivers (See "Printer" on page 53. If needed, contact your dealer).
-

- ❑ The default setting for the printer port mode is correct for most printers. If you cannot print, try changing the printer port mode. In Sony Notebook Setup, select the Printer tab. If the printer port mode is set to ECP, change it to bi-directional. If the printer port mode is set to bi-directional, change it to ECP. Please refer to "Sony Notebook Setup" in your Software Guide for details on how to configure the system.



 Supplied : 2 CD-ROMS (one application and one system recovery CD).

! **Applying a system recovery means that you will lose all your data stored on the hard drive. Therefore, before applying a system recovery, save your data stored on the hard disk to an external disk. If this is not possible under Windows® 98, try to save your data from the DOS-prompt to an external disk (floppy, zip or additional Hard Disk, etc..).**

! **CAUTION: make sure that your computer is connected to AC (not the batteries) before you attempt a system recovery.**

! **CAUTION: when the recovery is performed, you must remove the recovery CD-ROM from the drive before restarting the computer. If the CD-ROM is still in the drive, you will restart a recovery process.**

Using the Product Recovery CD-ROMs

In the event of a serious system crash, you may need to recover the whole contents of your hard drive. A system recovery is required.

Furthermore, if you encounter a problem with your computer (probably caused by a badly configured system) reinstalling an individual device driver may solve the problem.

Another problem could be that a pre-installed application is not working properly any more. Reinstalling the appropriate application should fix the problem. You should therefore perform an application recovery.

Performing a system recovery.

Use this option only when your system is seriously damaged, e.g. if Windows® 98 does not work any more, or your PC behaves abnormally, etc. The system recovery will completely reinstall the originally configured system on your PC.

 You can only use this Recovery CD-ROM on the Sony notebook you purchased and not on any other Sony PC or other manufacturer's PC!

To perform a system recovery, the notebook should not be docked (port replicator).

For more information about using your CD-ROM drive, read "CD-ROM Drive" on page 36.

 The recovery process takes between 10 to 20 minutes to complete.

Procedure for a system recovery

- 1 Take the Recovery CD-ROM.
- 2 Turn on your computer (using AC power only) and insert the Recovery CD-ROM in the CD-ROM drive.
- 3 Shut down your computer (slide the power switch forward and hold it for more than four seconds).
- 4 Wait ten seconds and turn your computer back on.
- 5 Click “OK” to confirm that you have read and accepted the Microsoft End-User License Agreement.
- 6 The system recovery screen appears next. If you're really sure that you do not mind losing all your data, click “YES”.
- 7 You will get a final warning. If you select “GO”, all data will be removed permanently and the recovery process will start.

If your computer does not start the system recovery utility.

Please refer to your Customer Service Guide to contact VAIO-Link by phone or by fax.

Performing an Application Recovery.

The application recovery utility allows you to reinstall individual applications. Reinstalling a program can fix the problems encountered if it does not run correctly any more.

Procedure for an application recovery

- 1 Take the Recovery CD-ROM.
-

 You must run the Recovery CD from Windows® 98. The application will not run from DOS.

When performing an application recovery, you do not lose data on your hard disk.

- 2 Turn on your computer (using AC power only) and wait until Windows® 98 has booted up.
- 3 Insert the Recovery CD-ROM in the CD-ROM drive. The Install Manager will load automatically.
- 4 When the Install Manager menu appears, follow the on-screen instructions to select the application you want to recover.
- 5 Follow the installation instructions in Install Manager.

Reinstalling a device driver

Some applications or peripherals require specific drivers which you won't find in the Windows® 98 drivers folder. To help you find or restore typical drivers needed by your pre-installed applications, you can use the Application Recovery CD-ROM.

- 1 First check whether the driver you plan to reinstall is on the Recovery CD-ROM. Only device drivers that are not delivered with Windows® 98 can be found in the drivers directory (in G:\Drivers).
- 2 Check all underlying sub-directories for the appropriate driver.
- 3 Next, launch the "Add New Hardware" wizard (in the Windows® start menu, select "Settings", then "Control Panel") to install the appropriate device by browsing through the appropriate folders.

Notes on Use

This section describes safety guidelines and precautions to help protect your computer from potential damage.

On Upgrading the System

Your Notebook Computer and memory modules use high precision components and electronic connectors' technology. To avoid the invalidation of your Guarantee by mishandling, it is recommended that:

- ❑ you contact your dealer to install a new memory module,
- ❑ you do not install it yourself, if you are not familiar with upgrading memory on a notebook computer,
- ❑ you do not touch the connectors or open the memory panel.

Please call VAIO-Link if you need assistance.



Placing a key top

Do not take off the key top intentionally. It may cause a malfunction.

As it may damage the computer if you press it to excess, handle it with care.

Placing a key top

If the enter key or the space key comes off, replace the key top as it is shown below. If the other key top comes off, put it where it was and push it until it clicks.

To replace a key top

Take off the wire from key top, then catch on the hook. Align the center of the key top and press it from the top.

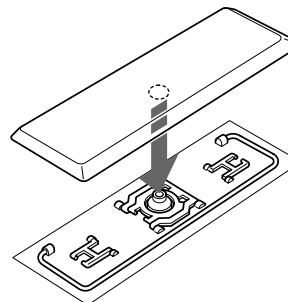
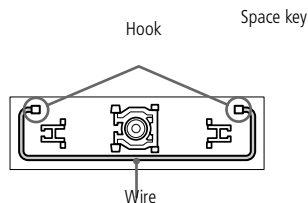
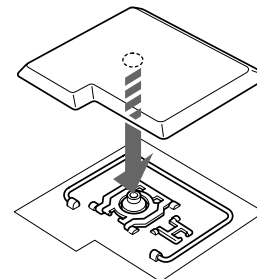
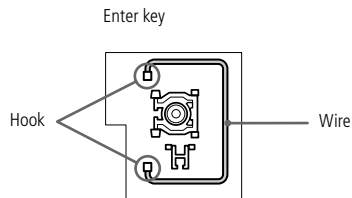

Other precautions

On Handling the Hard Disk

The hard disk has a high storage density and reads or writes data in a short time. On the other hand, it may be easily damaged by mechanical vibration, shock or dust. Keep the hard disk away from magnets.

Although the hard disk has the safety device in itself to prevent losing data due to mechanical vibration, shock or dust, you should be careful to handle your computer. Avoid damaging data:

- ❑ Do not give a shock to your computer.
- ❑ Do not place your computer in a location subject to mechanical vibration or in unstable situation.
- ❑ Do not move your computer while the power is on.
- ❑ Do not turn off the power or restart the computer while reading or writing data.
- ❑ Do not use your computer in a place subject to extreme change of temperature.
- ❑ If the hard disk is damaged, the data can not be restored.

Back up data

As you may lose important data once your computer is damaged, you should back up your data regularly.

About the application programs, you can get the original from the CD-ROM or the floppy disk.

See the Windows® 98 help for more information on back-up data.

On Handling the LCD Screen

- ❑ Do not leave the LCD facing the sun as it can damage the LCD. Be careful when using the computer near a window.

Other precautions

- ❑ Do not scratch the LCD or exert pressure on it. This could cause malfunction.
- ❑ Using the computer in low temperature conditions may produce a residual image on the screen. This is not a malfunction. When the computer returns to normal temperature, the screen returns to normal.
- ❑ A residual image may appear on the screen if the same image is displayed for a lengthy period of time. The residual image disappears in a while. You can use a screen saver to prevent residual images.
- ❑ The screen becomes warm during operation. This is normal and does not indicate a malfunction.
- ❑ The LCD is manufactured using high-precision technology. You may, however, see tiny black points and/or bright points (red, blue, or green) that continuously appear on the LCD. This is a normal result of the manufacturing process and does not indicate a malfunction.

On the Power Source

- ❑ Your computer operates on 100V-240V AC 50/60 Hz.
- ❑ Do not share the AC outlet with other power-consuming equipment, such as a copying machine or shredder.
- ❑ You can purchase a power strip with a surge protector. This device prevents damage to your computer caused by sudden power surges such as those that may occur during an electrical storm.
- ❑ Do not place heavy objects on the power cord.
- ❑ To disconnect the cord, pull it out by the plug. Never pull the cord itself.
- ❑ Unplug your computer from the wall outlet if you will not be using the computer for a long time.
- ❑ When the AC adapter is not used, unplug it from the AC outlet.
- ❑ Use only the AC adapter supplied. Do not use any other AC adapter.

*Other precautions**On Handling*

- ❑ Clean the cabinet with a soft, dry cloth or a soft cloth lightly moistened with a mild detergent solution. Do not use any type of abrasive pad, scouring powder, or solvent such as alcohol or benzene, as these may damage the finish of your computer.
- ❑ Should any solid object or liquid fall into the computer, shut down your computer and then unplug it. You may want to have the computer checked by qualified personnel before operating it any further.
- ❑ Do not drop the computer or place heavy objects on top of the computer.

On Installation

- ❑ Do not place your computer in a location subject to:
 - ❑ Heat sources, such as radiators or air ducts
 - ❑ Direct sunlight
 - ❑ Excessive dust
 - ❑ Moisture or rain
 - ❑ Mechanical vibration or shock
 - ❑ Strong magnets or speakers that are not magnetically shielded
 - ❑ Ambient temperature of more than 35° C or less than 10° C
 - ❑ High humidity.
- ❑ Do not place electronic equipment near your computer. The computer's electromagnetic field may cause a malfunction.
- ❑ Provide adequate air circulation to prevent internal heat build-up. Do not place your computer on porous surfaces such as rugs or blankets, or near materials such as curtains or draperies that may block its ventilation slots. Leave a space of at least 8 inches behind the back panel of the computer.

Other precautions

- ❑ The computer uses high-frequency radio signals and may cause interference to radio or TV reception. Should this occur, relocate the computer a suitable distance away from the set.
- ❑ Use only specified peripheral equipment and interface cables; otherwise, problems may result.
- ❑ Do not use cut or damaged connection cables.
- ❑ Your computer cannot be connected to a coin-operated telephone, and may not work with a private branch exchange (PBX).

On Moisture Condensation

If the computer is brought directly from a cold location to a warm one, moisture may condense inside your computer. In this case, allow at least an hour before turning on your computer. If any problem occurs, unplug your computer and contact VAIO-Link.

On Handling Diskettes

- ❑ Do not open the shutter manually and touch the surface of the diskette.
- ❑ Keep diskettes away from magnets.
- ❑ Keep diskettes away from direct sunlight and other heat sources.

On Handling CD-ROM and DVD-ROM Discs

- ❑ Do not touch the surface of the disc.
- ❑ Do not drop or bend the disc.

On Cleaning CD-ROM and DVD-ROM Discs

- ❑ Fingerprints and dust on the surface of a disc may cause read errors. Proper care of the disc is essential to maintain its reliability. Do not use solvents such as

Other precautions

benzine, thinner, commercially available cleaners or anti-static spray, as they may cause damage to the disc.

- ❑ For normal cleaning, hold the disc by its edge and use a soft cloth to wipe the surface from the center out.
- ❑ If the disc is badly soiled, moisten a soft cloth with water, wring it out well, and use it to wipe the surface of the disc from the center out. Wipe off any remaining moisture with a dry soft cloth.

On Using Batteries

- ❑ Never leave the battery pack in temperatures above 60° C, such as in a car parked in the sun or under direct sunlight.
 - ❑ Battery life is shorter in a cold environment. This is due to decreased battery efficiency at low temperatures.
 - ❑ Charge the batteries at temperatures between 10° C to 30° C. Lower temperatures require a longer charging time.
 - ❑ While the battery is in use or being discharged, the battery pack heats up. This is normal and is not cause for concern.
 - ❑ Keep the battery pack away from all sources of heat.
 - ❑ Keep the battery pack dry.
 - ❑ Do not open or try to disassemble the battery pack.
 - ❑ Do not expose the battery pack to any mechanical shock.
 - ❑ If you are not using the computer for an extended period of time, remove the battery pack from the computer to prevent damage to the battery.
 - ❑ If, after fully charging the battery pack, the battery power is still low, the battery pack may be reaching the end of its life and should be replaced.
 - ❑ You do not need to discharge the battery before recharging.
-

Other precautions

- ❑ If you have not used the battery pack for a considerable amount of time, recharge the battery.

On Using earphones

- ❑ Road safety – Do not use earphones while driving, cycling, or operating any motorized vehicle. It may create a traffic hazard and is illegal in some areas. It can also be potentially dangerous to play your earphones at high volume while walking, especially at pedestrian crossings. You should exercise extreme caution or discontinue use in potentially hazardous situations.
- ❑ Preventing hearing damage – Avoid using earphones at high volume. Hearing experts advise against continuous, loud and extended play. If you experience a ringing in your ears, reduce the volume or discontinue use.

On Maintenance

- ❑ Make sure to disconnect the power cord before cleaning the computer.
- ❑ Avoid rubbing the LCD screen, as this can damage the screen. Use a soft, dry cloth to wipe the LCD screen.
- ❑ Clean the computer with a soft cloth lightly moistened with a mild detergent solution. Do not use any type of abrasive pad, scouring powder or solvent such as alcohol or benzine.

Specifications

<i>Model Number</i>	<i>PCG-N505SN</i>
<i>Processor</i>	Intel® Mobile Pentium® II processor 400 MHz
<i>Hard Disk Drive</i>	6.0 GB
<i>Standard RAM</i>	64 MB SDRAM
<i>Maximum RAM</i>	128 MB
<i>LCD Screen</i>	10.4 XGA TFT
<i>L2 Cache Memory</i>	256 KB (CPU integration)
<i>MPEG</i>	MPEG 1 Digital Video Supports full-screen playback
<i>Graphics</i>	128-bit accelerator with 2.5 MB Video RAM
<i>Sound Capabilities</i>	16-bit CD-quality stereo sound* * With the optional stereo speakers.
<i>Diskette Drive</i>	3.5" 1.44 MB (with cable)
<i>CD-ROM Drive *</i>	CD-ROM 16x Laser Diode properties: Wave Length : 795 nm Laser Output: 16.5 μW
<i>PC card modem *</i>	V.90/ K56 Flex (56 kbps) data / fax



*Depending on the model, this accessory could be optional.

<i>Model Number</i>	<i>PCG-N505SN</i>
<i>Telecommunication Capabilities</i>	PSTN data connectivity
<i>Infrared</i>	Supports 4 Mbps, 1.1 Mbps, and 115 kbps IrDA Standard
<i>Expansion Capabilities</i>	One PCMCIA type II Card and Card Bus support.
<i>Built-In Capabilities</i>	Microphone, Mono speaker, Touchpad
<i>Special Button</i>	PPK (Programmable Power Key)
<i>Connection Capabilities on Notebook</i>	i.LINK™ port replicator, External speakers, Headphone, Mic, USB, Type II PC Cards, Infrared, i.LINK™ (IEEE1394) S400
<i>Connection Capabilities on Port Replicator</i>	Printer, VGA monitor, USB Mouse, Serial, USB, S400 i.LINK™ (IEEE1394)
<i>Supplied Accessories</i>	V.90 56 kbps PC Card modem,* Floppy disk drive, Rechargeable battery, AC adapter, AC Cord, Phone cable, CD-ROM drive, i.LINK™ Port Replicator.
<i>Service</i>	1 year free VAIO-Link Service‡
<i>Guarantee</i>	1 year guarantee (parts and labour) ‡
<i>Power Requirement</i>	40 watts maximum (16V DC / AC100-240V)
<i>Power Management</i>	Energy Star compliant ACPI (Advanced Configuration and Power Interface).
<i>Battery</i>	Lithium ion

 *Depending on the model, this accessory could be optional.

<i>Model Number</i>	<i>PCG-N505SN</i>
<i>Dimensions</i>	
<i>Width</i>	259 mm
<i>Height</i>	19.8 mm to 22.2 mm
<i>Depth</i>	208 mm
<i>Weight</i>	
<i>with battery</i>	1.2 kg
<i>with FDD, CD-ROM and battery</i>	1.97 kg
<i>Operating Temperature</i>	+5°C → +35°C (temperature gradient less than 10°C/hour)
<i>Storage Temperature</i>	-20°C → +60°C (Temperature gradient less than 10°C/hour)
<i>Operating Humidity</i>	20% → 80% (Not condensed), provided that humidity is less than 65% at +35°C (hygrometer reading of less than 29°C)
<i>Storage Humidity</i>	10% → 90% (Not condensed), provided that humidity is less than 20% at +60°C (hygrometer reading of less than 35°C)

‡ See your registration card for conditions.

Specifications are subject to change without notice.

Index

A

- AC adapter **13, 17**
- AC power **17**
- adding
 - hardware **47**
 - peripherals **47**
- adjusting
 - brightness **30**
- air circulation **89**
- Alt key **26**
- Application Recovery **83**
- Applications key **27**

B

- battery pack
 - charging **19**
 - connector **16**
 - inserting **18**
 - loading **18**
 - removing **21**
- battery packs **13, 91**
 - charging **19**
 - indicator lights **15, 28**
 - inserting **18**
 - inserting into battery bay **18**
 - loading **18**
 - rechargeable **17**
- brightness

- adjusting **22, 30**
- built-in speakers
 - See also speakers **30**
- buttons
 - left **15**
 - right **15**
 - Start (Windows 98) **23**

C

- cables
 - floppy disk drive **13**
 - phone **13**
 - power cord **17**
 - video **13**
- cameras
 - digital video recorder **61**
- canceling commands **26**
- Caps Lock **15**
 - indicator light **29**
- CD drive tray
 - troubleshooting **75**
- CD-ROM discs
 - troubleshooting **76**
- CD-ROM drive
 - connecting **37**
 - troubleshooting **76**
- CD-ROM/DVD-ROM discs
 - cleaning **91**
 - handling **90, 91**
- charging battery pack **19**
- charging battery packs **19**

- choosing
 - power source **18**
 - cleaning computer **89**
 - computer
 - cleaning **89**
 - condensation **90**
 - lithium ion battery **4**
 - setting up **13**
 - starting **22**
 - troubleshooting **70, 73**
 - connecting
 - CD-ROM drive **37**
 - digital video recorder **61**
 - floppy disk drive **33**
 - microphone **66**
 - monitor **50, 55**
 - network **37**
 - phone line **48**
 - power source **17**
 - USB device **67**
 - connectors
 - battery **16**
 - DC In **14, 17**
 - i.LINK **14**
 - infrared **13, 43**
 - keyboard **15**
 - microphone **14**
 - monitor **50**
 - Serial port **50**
 - USB **14, 50**
 - Correction keys **26**
 - correction keys **26**
 - Ctrl key **26**
 - cursor-movement keys **26**
 - Customer Service Guide **68**
 - customer support **69**
 - See also VAIO-Link **7**
- D**
- DC In **14, 17**
 - digital still camera **43**
 - digital video camera **61**
 - diskettes
 - ejecting **34**
 - handling **90**
 - inserting into drive **34**
 - troubleshooting **76**
 - drives
 - floppy disk **13, 33**
 - DV In/Out **14, 61**
- E**
- earphones
 - precautions **92**
 - Eject button **34**
 - ejecting
 - diskettes **34**
 - ergonomic considerations **11, 12**
 - Escape key **26**
 - external devices
 - display **12**
 - See also monitor **55**

speakers **30**

F

floppy disk drive **13**

 cable **13**

 connecting **33**

 disconnecting **34**

 troubleshooting **76**

Fn key **26**

 combination commands **30**

Function keys **26**

function keys **27**

G

Guarantee **24**

Guarantee card **24**

H

handling

 audio CDs **91**

 CD-ROM/DVD-ROM discs **90, 91**

 diskettes **90**

hard drives

 indicator light **15, 28**

headphone **13**

Help

 Mouseware **32**

 online **69**

I

i.LINK **14, 61**

IEEE1394 **14, 61**

Indicator lights **28**

indicator lights

 battery **15, 28**

 Caps Lock **15, 29**

 hard drive **15, 28**

 Num Lock **15, 29**

 power **15**

 Scroll Lock **15, 29**

infrared communication devices **43**

 other computers **43**

infrared port **13, 43**

infrared transmission

 active distance **44**

 troubleshooting **44**

Insert key **26**

inserting

 battery pack **18**

 diskettes into drive **34**

installing

 hardware **47**

 memory **37**

 peripherals **47**

interference **89**

K

keyboard **26**

 connector **15**

L

LCD **87**

- lock lever **22**
- troubleshooting **75**
- left button **15**
- lever
 - LCD **22**
- lithium ion battery
 - disposal **4**
 - safety precautions **4**
- loading
 - battery pack **18**
- M**
- maintenance **89, 92**
- microphone **14, 15**
 - connecting **66**
 - troubleshooting **77**
- modem
 - troubleshooting **78**
- moisture condensation **90**
- monitor **50**
 - connecting **55**
- mouse
 - troubleshooting **73**
- Mouse Properties screen **32**
- N**
- Navigation keys **25**
- navigation keys **26**
- network
 - connecting **37**
- Notebook Computer **13**

- Num Lock **15**
 - indicator light **29**
- numeric keypad area **25**

O

- online help **69**
- operator keys **26**

P

- packing list **68**
- PC card **80**
 - release button **37, 48**
 - slot protector **37**
 - slots **13, 37**
 - troubleshooting **80**
- PC card modem **48**
- phone
 - cable **13**
 - connecting line **48**
- power **28**
 - cord **17**
 - indicator light **15**
 - programmable key **13, 40**
 - switch **13, 22**
- power saving modes **45**
 - System Hibernation **30, 46**
 - System Suspend **46**
 - Video Standby **31**
- power sources **18, 88**
 - connecting **17**
- PPK **13, 40**

- precautions **89**
- pre-installed software **68**
- Print Screen key **26**
- printer
 - connecting **50**
- Printer connector **50**
- programmable power key **13, 40**
- R**
- radio interference **89**
- rechargeable battery packs **17**
- recharging battery pack **19**
- recharging battery packs **19**
- registering
 - your computer **24**
- Registering Your Computer **24, 25**
- regulatory information **3**
- Reinstalling a device driver **84**
- removing
 - battery pack **21**
 - diskettes **34**
 - floppy disk drive **34**
- right button **15**
- S**
- Scroll Lock **15**
 - indicator light **29**
- selecting
 - power source **18**
- Serial connector **50**
- Shift key **27**
- Shut Down Windows dialog box **23**
- Smart Connect **42**
- Software guide **68**
- Sony e-mail support service **69**
- Speakers
 - volume **30**
- speakers
 - switching **30**
 - troubleshooting **77**
- Start button **23**
- starting
 - computer **22**
- startup problems **23**
- System and Application Recovery CD **82**
- System Hibernation mode **30, 46**
- System Recovery **82**
- System Suspend mode **30, 46**
- T**
- technical specifications **68**
- technical support **68, 69**
- Touchpad
 - accessing **32**
 - features **32**
- touchpad **15, 32, 74**
- troubleshooting **70**
 - startup **23, 70**
- turning on
 - computer **22**
- TV
 - interference **89**

U

USB

- connecting **67**
- connector **14, 50, 67**

VVAIO-Link **69**

- response center **69**
- software **69**

ventilation **89**video cable **13**video camera **61**Video Standby mode **31****W**weight saver **13**

Windows 98

- Control Panel **44**
- key **26**
- Start button **23**
- taskbar **23, 73**

Windows® 98

- key combinations **27**