

# ***Sony notebook user guide***

**PCG-FX201/PCG-FX202**

**W10**

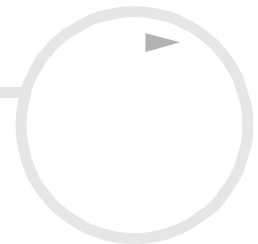

## Read this first

### Notice

© 2001 Sony Corporation. All rights reserved.

This manual and the software described herein, in whole or in part, may not be reproduced, translated, or reduced to any machine-readable form without prior written approval.

Sony Corporation provides no warranty with regard to this manual, the software, or other information contained herein and hereby expressly disclaims any implied warranties or merchantability or fitness for any particular purpose with regard to this manual, the software or such other information. In no event shall Sony Corporation be liable for any incidental, consequential, or special damages, whether based on tort, contract, or otherwise, arising out of or in connection with this manual, the software, or other information contained herein or the use thereof.

**Macrovision:** This product incorporates copyright protection technology that is protected by method claims of certain U.S. patents and other intellectual property rights owned by Macrovision Corporation and other rights owners. Use of this copyright protection technology must be authorized by Macrovision Corporation, and is intended for home and other limited viewing uses only unless otherwise authorized by Macrovision Corporation. Reverse engineering or disassembly is prohibited.

Sony Corporation reserves the right to make any modification to this manual or the information contained herein at any time without notice. The software described herein is governed by the terms of a separate user license agreement.

Sony, DVgate, i.LINK™ and the i.LINK™ logo, PictureGear, Memory Stick and the Memory Stick logo, VAIO and the VAIO logo are trademarks of Sony Corporation.

i.LINK™ is the name for the IEEE 1394-1995 standards and their revisions.

Microsoft, Windows and the Windows logo, Windows Media and Outlook are trademarks or registered trademarks of U.S. Microsoft Corporation in the U.S. and other countries.

Adobe® and Adobe® Acrobat® Reader are trademarks of Adobe Systems Incorporated.

QuickTime and the QuickTime logo are trademarks used under license. QuickTime is registered in the U.S. and other countries.

RealPlayer is a trademark or registered trademark of RealNetworks, Inc. in the U.S. and other countries.

VirusScan is a trademark of Network Associates Corporation.

All other names of systems, products and services are trademarks of their respective owners. In the manual, the ™ or ® marks are not specified.

Specifications are subject to change without notice.

As an ENERGY STAR Partner, Sony has determined that this product meets the ENERGY STAR guidelines for energy efficiency.

The International ENERGY STAR Office Equipment Program is an international program that promotes energy saving through the use of computers and their office equipment. The program backs the development and dissemination of products with functions that effectively reduce energy consumption. It is an open system in which business proprietors can participate voluntarily. The targeted products are office equipment such as computers, displays, printers, facsimiles and copiers. Their standards and logos are uniform among participating nations.

ENERGY STAR is a U.S. registered mark.



## Safety information

### Owner's record

The model number and serial number are located on the bottom of your Sony notebook. Record the serial number in the space provided here. Refer to the model and serial number when you call VAIO-Link.

Serial number: \_\_\_\_\_

Model: **PCG-961C**

### Warnings

#### General

- Opening the unit, for whatever reason, could lead to damages that are not covered by the guarantee.
- To avoid electrical shock, do not open the cabinet. Refer servicing to qualified personnel only.
- To prevent fire or shock hazard, do not expose your notebook to rain or moisture.
- Avoid using the modem during a thunder storm.
- Do not use the modem or a telephone to report a gas leak in the vicinity of the leak.
- To change the backup battery, please contact your nearest Sony Service Center.

#### Audio/video

- Audio and picture distortion may occur if this equipment is positioned in close proximity to any equipment emitting electromagnetic radiation.

### Connectivity

- ❑ Never install modem or telephone wiring during a severe storm.
- ❑ Never install telephone jacks in wet locations unless the jack is specifically designed for wet locations.
- ❑ Use caution when installing or modifying telephone lines.
- ❑ Use your notebook only with the supplied AC adapter. To disconnect your notebook completely from mains voltage, unplug the AC adapter.
- ❑ Please make sure that the socket outlet is easily accessible.
- ❑ Never touch uninsulated telephone wire or terminals unless the telephone line has been disconnected at the network interface.

### CD-ROM

- ❑ The use of the optical instrument supplied with your notebook will cause eye hazard. As the laser beam used in this product is harmful to eyes, do not attempt any disassembling process. For servicing, refer to qualified personnel only.
- ❑ There are visible and invisible radiations when the CD-ROM drive is open: avoid direct exposure to the laser beam.



## Regulatory information

This product conforms to the following European Directives:

73/23/EEC (Low Voltage Directive)

89/336/EEC, 92/31/EEC (EMC Directives)

93/68/EEC (CE Marking Directive)

1999/5/EC (radio equipment and telecommunications terminal equipment Directive)



This product complies with EN 55022 Class B and EN 55024 for use in following areas: residential, commercial and light-industrial.

This product has been tested and found compliant with the limits set out in the EMC Directive for using connection cables shorter than 3 metres (9.8 feet).

The CD-ROM-drive is classified as a CLASS 1 LASER PRODUCT and complies with the Laser Product Safety Standard EN 60825-1. Repair and maintenance only by authorized Sony technicians. Improper repairs and use can create safety hazards.



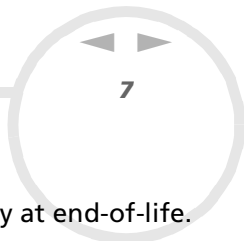

## *Disposing of lithium ion batteries*

Do not handle damaged or leaking lithium ion batteries. Dispose of promptly and properly at end-of-life.

Danger of explosion if battery is incorrectly replaced. Replace only with the same or equivalent type recommended by the manufacturer. Discard used batteries according to the manufacturer's instructions.

The battery pack used in this device may present a fire or chemical burn hazard if mistreated. Do not disassemble, heat above 100°C (212°F) or incinerate.

Keep away from children.

Your notebook is equipped with an internal backup memory battery. For changing this battery, please contact VAIO-Link:

<http://www.vaio-link.com>

In some areas the disposal of lithium ion batteries in household or business waste may be prohibited.

Use the public collection system.

## Welcome

Congratulations on purchasing a Sony VAIO notebook. Sony has combined leading-edge technology in audio, video, computing and communications to provide you with state-of-the-art personal computing.

Here are just some of the features your VAIO notebook has to offer.

- ❑ **Exceptional performance** - Your PC includes a fast processor, a fast CD-ROM drive and an internal modem.
- ❑ **Portability** - The rechargeable battery pack provides hours of use without AC power.
- ❑ **Sony audio and video quality** - A high-resolution LCD screen enables you to take advantage of today's advanced multimedia applications, games, and entertainment software.
- ❑ **Multimedia features** – Enjoy the speakers to listen to audio and video CDs.
- ❑ **Interconnectivity** – Your computer has Ethernet and i.LINK<sup>C</sup> functionalities. i.LINK™ is a bidirectional digital interface for exchanging data.
- ❑ **Windows<sup>®</sup>** - Your system includes the latest operating system from Microsoft.
- ❑ **Communications** - Access popular online services, send and receive e-mails, browse the Internet...
- ❑ **Excellent customer support** - If you are experiencing any problems with your computer, please check the VAIO-Link web site for a possible solution:

<http://www.vaio-link.com>

Before contacting VAIO-Link, you may try to solve the problem by reading the User Guide or the manuals and help files for the peripherals or software.



## Documentation pack

Your Documentation Pack contains paper and online user guides on a Documentation CD-ROM.

### Printed documentation

- ❑ A **Getting Started** brochure, where you find a brief description of the items in your box and some specifications of your notebook;
- ❑ A **Customer Guide**, where you find all the basic information to start using your notebook;
- ❑ A **Modem Regulations Flyer** applying to the modem;
- ❑ Your **Sony Guarantee conditions**.

### Online documentation

- 1 The Sony Notebook User Guide:
  - ❑ **Using Your Sony Notebook** shows you how to use the standard components of your system.
  - ❑ **Connecting Peripheral Devices** explains how you can add functionality by connecting various peripherals.
  - ❑ **Getting Help** explains the support options available to you, and offers basic troubleshooting tips.
  - ❑ **Precautions** provides facts and advice about using your notebook.
  - ❑ **Specifications** provides details on your computer, drivers and accessories.
- 2 Refer to your **Software Guide** for information on the bundled software and the Sony applications.
  - ❑ **About the Software** is a short description of the features of the software pre-installed on your system.
  - ❑ **Customizing your notebook** explains how to set your system and power management.
  - ❑ **Using the Product Recovery CD-ROMs** explains how to perform a system and application recovery.
- 3 Consult the **Online Help** files of the software you are using for detailed information on features and troubleshooting.
- 4 Refer to the Microsoft **Quick Start** manual for more information on Windows.

## Your notebook and its accessories

Following hardware items should be in the box:

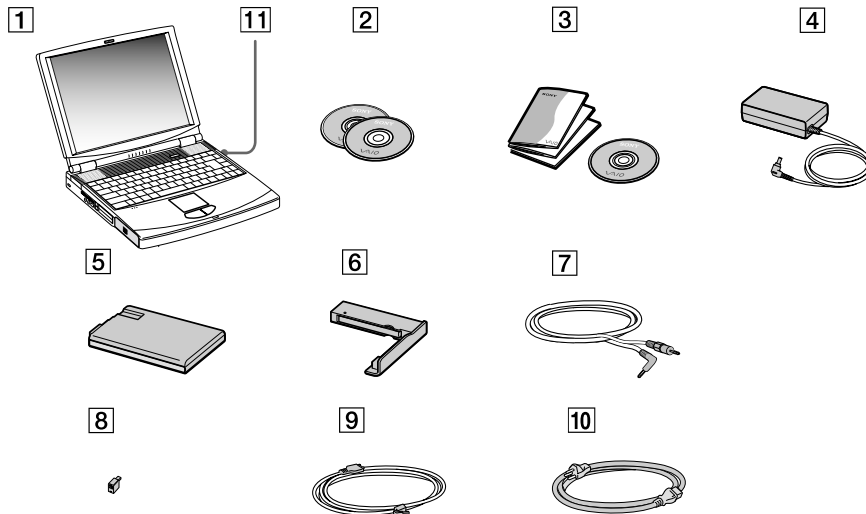

1	main unit	7	video cable
2	product recovery CD-ROMs	8	phone plug (country specific)
3	documentation pack	9	phone cable
4	AC adapter	10	power cord
5	rechargeable battery pack	11	CD-ROM drive
6	weight saver		

## Ergonomic considerations

You will be using your notebook as a portable device in a variety of environments. Whenever possible, you should attempt to take account of the following ergonomic considerations to both stationary and portable environments:

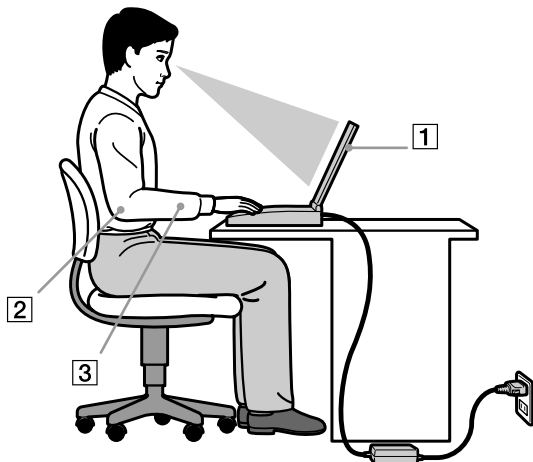

- ❑ **Position of your computer** – Place the computer directly in front of you (1). Keep your forearms horizontal (2), with your wrists in a neutral, comfortable position (3) while using the keyboard, touchpad, or external mouse. Let your upper arms hang naturally at your sides. Have breaks during sessions with your computer. Excessive use of the computer may strain muscles or tendons.
- ❑ **Furniture and posture** – Sit in a chair with good back support. Adjust the level of the chair so your feet are flat on the floor. A footrest may make you more comfortable. Sit in a relaxed, upright posture and avoid slouching forward or leaning far backwards.

- ❑ **Viewing angle of the computer's display** – Use the display's tilting feature to find the best position. You can reduce eye strain and muscle fatigue by adjusting the tilt of the display to the proper position. Adjust the brightness setting of the display as well.
- ❑ **Lighting** – Choose a location where windows and lights do not create glare and reflection on the display. Use indirect lighting to avoid bright spots on the display. You can also purchase accessories for your display that help reduce glare. Proper lighting adds to your comfort and work effectiveness.
- ❑ **Placement of an external display** – When using an external display, set the display at a comfortable viewing distance. Make sure the display screen is at eye level or slightly lower when you are sitting in front of the monitor.
- ❑ **Tilt stands** – You use the tilt stands to place the computer at an angle that allows comfortable typing.

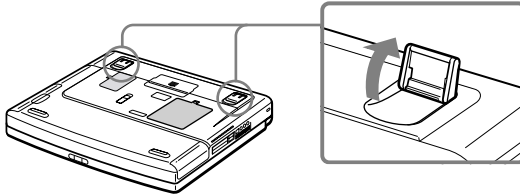

## Using your notebook

This section describes how to start using your computer and how to use your computer's internal and external devices.

### Locating controls and connectors

#### Right

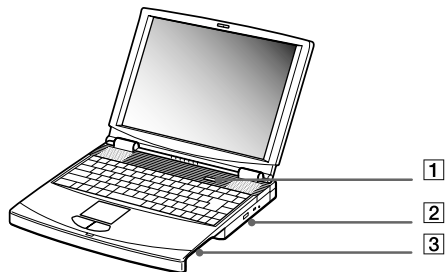

1	power button	<a href="#">(page 27)</a>
2	CD-ROM drive	<a href="#">(page 36)</a>
3	multi-purpose bay	<a href="#">(page 38)</a> <a href="#">(page 40)</a>

## Left

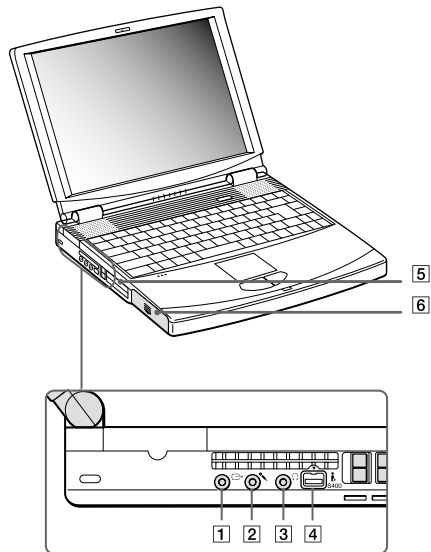

1	TV Out connector	<a href="#">(page 58)</a>	4	i.LINK™ connector	<a href="#">(page 66)</a>
2	microphone connector	<a href="#">(page 62)</a>	5	PC Card slots	<a href="#">(page 44)</a>
3	headphone connector	<a href="#">(page 61)</a>	6	battery bay	<a href="#">(page 19)</a>

 AC adapter mains connector and power cord: hazardous voltage, according to EN 60950.

All other connectors for this notebook are SELV (Safety Extra Low Voltage), according to EN 60950.

## Front

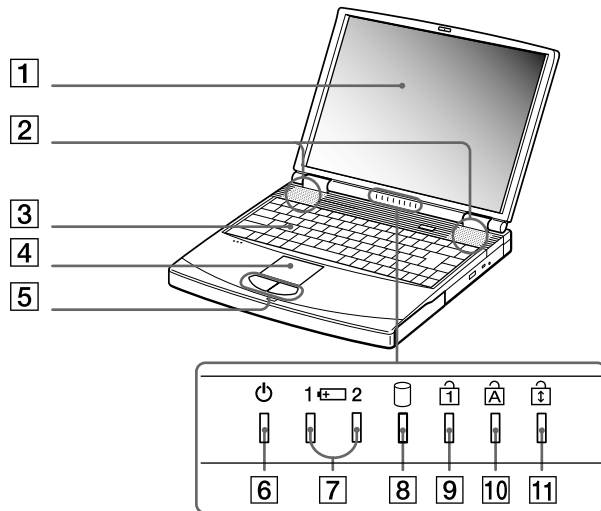

1	LCD screen	<a href="#">(page 34)</a>	7	battery 1 and 2 indicators	<a href="#">(page 33)</a>
2	speakers	<a href="#">(page 34)</a>	8	hard disk drive indicator	<a href="#">(page 33)</a>
3	keyboard	<a href="#">(page 30)</a>	9	Num Lock indicator	<a href="#">(page 33)</a>
4	touchpad	<a href="#">(page 35)</a>	10	Caps Lock indicator	<a href="#">(page 33)</a>
5	left/right buttons	<a href="#">(page 35)</a>	11	Scroll Lock indicator	<a href="#">(page 33)</a>
6	power indicator	<a href="#">(page 33)</a>			

## Back

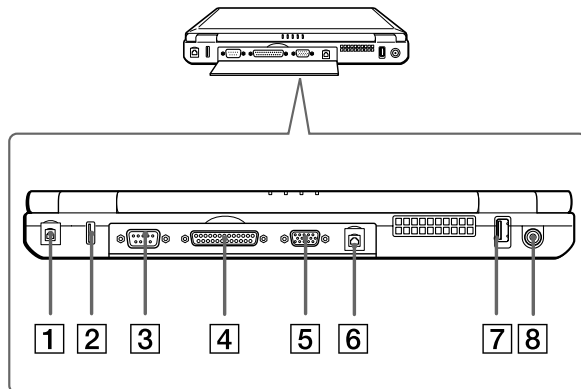

1	phone line jack	<a href="#">(page 51)</a>	5	monitor connector	<a href="#">(page 55)</a>
2	USB connector	<a href="#">(page 63)</a>	6	Ethernet connector	<a href="#">(page 69)</a>
3	serial connector	<a href="#">(page 65)</a>	7	USB connector	<a href="#">(page 63)</a>
4	printer	<a href="#">(page 65)</a>	8	DC In	<a href="#">(page 18)</a>

 There is a ventilation slot located near the USB connector. Do not cover the ventilation slot when the computer is on.

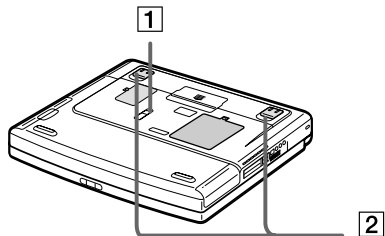

*Bottom*

1	release lever	<a href="#">(page 11)</a>
2	tilt stands	<a href="#">(page 11)</a>

## Connecting a power source

You can use either an AC adapter or a rechargeable battery pack as a power source.

### Using the AC adapter

To use the AC adapter, proceed as follows:

- 1 Plug the cable attached to the AC adapter (1) into the DC In connector (2) on the computer.
- 2 Plug one end of the power cord (3) into the AC adapter.
- 3 Plug the other end of the power cord into an AC outlet.

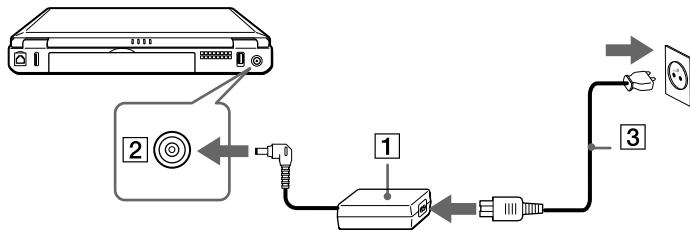

Use your notebook only with the supplied AC adapter.

To disconnect your notebook completely from mains voltage, unplug the AC adapter.

Make sure that the socket outlet is easily accessible.

## Using the battery pack

You can use one or two batteries as a source of power. You can insert the second battery pack into the multi-purpose bay on the right side of the computer. Additional battery packs are available as a separate option. The battery pack supplied with your computer is not fully charged at the time of purchase.

### Inserting the battery pack

To insert the battery pack, proceed as follows:

- 1 Open the cover of the battery bay.



- 2 Insert the battery pack with the label facing down into the battery bay on the left side of the computer.

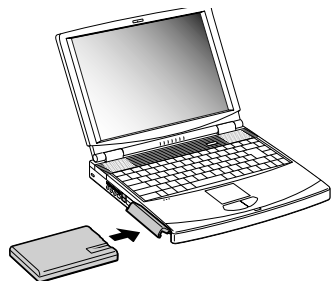

- 3 Close the cover of the battery bay until it clicks.

 When the computer is directly connected to AC power and has a battery pack inserted in the battery bay, it uses power from the AC outlet.



## Charging the battery pack

To charge the battery pack, proceed as follows:

- 1 Connect the AC adapter to the computer.
- 2 Insert the battery pack.

The computer automatically charges the battery (1) (the battery indicator (2) light flashes in a double blink pattern as the battery charges). When the battery is 85% full, the battery indicator light turns off. This process takes approximately one hour for the PCG-FX201 and the PCG-FX202. To charge the battery completely, continue charging for an additional hour.

There are two battery indicator lights on the computer:

- 1  Indicates the status of the battery pack in the battery bay on the left side of the computer.
- 2  Indicates the status of the battery pack in the multi-purpose bay on the right side of the computer.

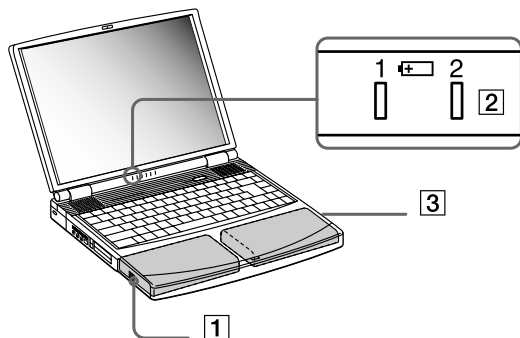

### battery indicator light status

### meaning

on	The computer is using battery power.
single blink	The battery is running out of power.
double blink	The battery is charging.
off	The computer is using AC power.



When the battery is running out of power, both the battery and power indicators blink.

Keep the battery pack in the computer while it is directly connected to AC power. The battery pack continues to charge while you are using the computer.

If the battery level falls to below 10%, you should either attach the AC adapter to recharge the battery or shut down your computer and insert a fully charged battery.

The battery pack supplied with your computer is a lithium ion battery and can be recharged any time. Charging a partially discharged battery does not affect battery life.

The battery indicator light is on while you use the battery pack as a power source. When the battery life is nearly depleted, the battery indicator starts flashing.

For some software applications and some peripheral devices, your computer may not enter **Hibernate** mode when battery life is low. To avoid loss of data when using battery power, you should save your data frequently and manually activate a power management mode, such as **Standby** or **Hibernate**.

When the computer is directly connected to AC power and has a battery pack inserted in the battery bay, it uses power from the AC outlet.

### Removing the battery pack

To remove the battery pack, proceed as follows:

- 1 Turn off the computer.
- 2 Open the cover of the battery bay.
- 3 Pull out the battery pack.

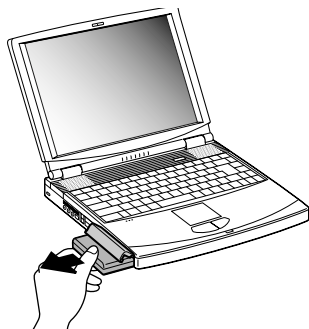

- 4 Close the cover of the battery bay.

 You may lose data if you remove the battery pack while the computer is on and not connected to the AC adapter or if you remove the battery while the computer is in **Standby** mode.

## Using the second battery pack

You can purchase a second rechargeable battery pack. With two battery packs, you can extend the time you use your computer with battery power. When using two battery packs, the battery pack you insert first charges first. The battery pack you insert second charges when the first battery pack is 85 percent full. You can monitor which battery pack is charging by observing the battery indicator lights.

### Inserting the second battery pack

To insert a second battery pack, proceed as follows:

- 1 If the weight saver is in the multi-purpose bay (1), remove the device.
- 2 Insert the battery pack (2) into the multi-purpose bay.  
The battery 2 indicator light turns on.

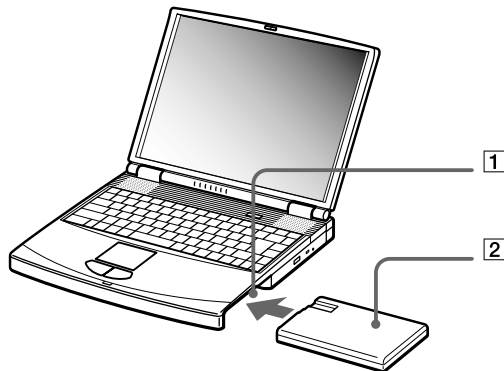

- 3 Attach the weight saver (3) to the computer to stabilize the battery pack.
- 4 Slide the eject lever on the bottom of the weight saver toward the front of the computer to lock it.

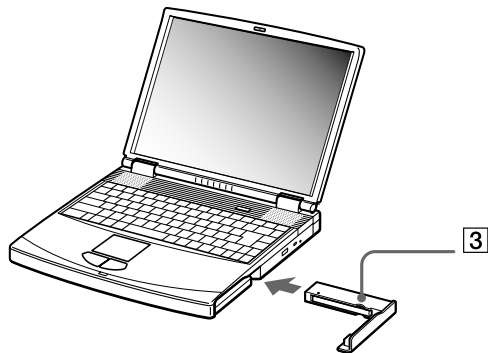

-  If you attach two battery packs, you can remove one of them without shutting down the computer. When removing one battery pack, make sure that the other battery pack indicator is on. If the indicator of the battery pack you are going to remove is on, right click the battery icon on the taskbar and click the switch discharge battery menu.



### Charging the second battery pack

To charge the second battery pack, proceed as follows:

- 1 Keep the battery pack (1-3) in the computer while it is connected to AC power. The battery indicator (2) flashes while the battery is charging.
- 2 When the battery indicator stops flashing, the battery is fully charged.

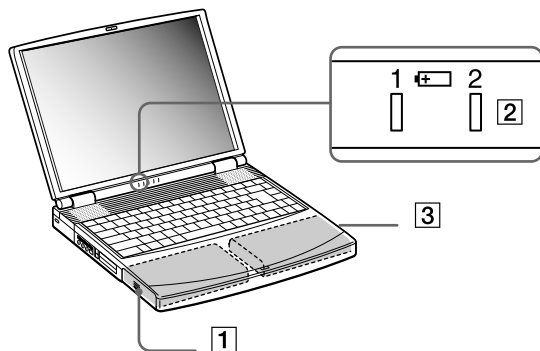

### Removing the second battery pack

To remove the second battery pack, proceed as follows:

- 1 Slide the **eject lever** on the bottom of the weight saver, in the direction of arrow 1.
- 2 Slide the **release lever** on the bottom of the computer in the direction of arrow 2.

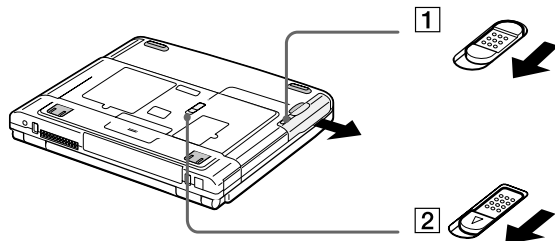

- 3 Remove the weight saver.
- 4 Pull out the battery pack
- 5 Reinsert the weight saver.

## Starting your notebook

To start your computer, proceed as follows:

- 1 Slide the LCD lock lever (1) in the direction of the arrow, and lift the cover.

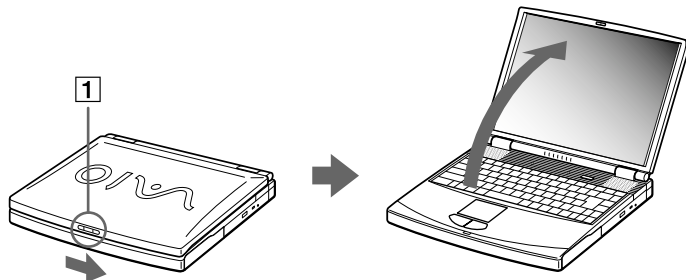

- 2 Press the power button (2) of the computer until the green power indicator (3) light turns on.

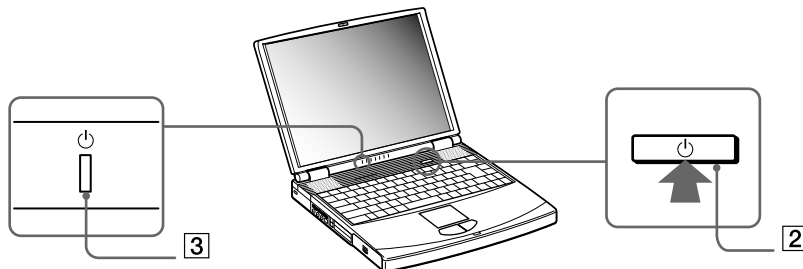

- 3 If necessary, press **<Fn>+<F5>\*** to adjust the brightness controls for the LCD display. To increase the brightness, use the up or right arrow keys. To decrease, use the down or left arrow keys.

 \* <Fn> + <F5> is only possible once you are in Windows.

If you press the power button for more than four seconds, the computer will turn off.

## Shutting down your notebook

It is important that you shut down your computer properly so you do not lose unsaved data.

To shut down your computer, proceed as follows:

- 1 Click the **Start** button on the Windows® taskbar.
- 2 Click **Shut Down**.  
The **Shut Down Windows** dialog box appears.
- 3 Select **Shut down**.
- 4 Click **OK**.
- 5 Wait for your computer to turn off automatically.  
The power indicator turns off.
- 6 Turn off any peripheral connected to your computer.

 Respond to any prompts warning you to save documents.

If you are unable to shut down your computer:

- Close all software in use.
- Remove the PC Cards if inserted. To do so, double-click the **Unplug or Eject Hardware** icon in the taskbar. Select the hardware you want to unplug and click **Stop**.
- Disconnect any USB devices.
- Then press the <Ctrl>+<Alt>+<Delete> keys at the same time to restart the computer.

If this does not work, you can press the power button for more than four seconds. This will shut down the computer. This operation may result in data loss.

If you want to shut down the computer for a short period only, you can save power by using the **Standby** mode.

## Registering your notebook

You can take advantage of Sony's commitment to quality customer support and receive the following benefits by registering your computer:

- ❑ **VAIO-Link** – If you are experiencing any problems with your computer, you can check the VAIO-Link web site for a possible solution:  
<http://www.vaio-link.com>
- ❑ **Guarantee** – Protect your investment. See the Guarantee sheet for the terms and conditions and refer to your Customer Service Guide for more information.

To register your Sony notebook, proceed as follows:

- 1 Click the **Registration** icon on your desktop,
- 2 Click **Next**,
- 3 Click **Internet**,
- 4 Fill in your Registration card fields,
- 5 Scroll down to the bottom of the form and click **Send**,
- 6 Click **OK**.

 You must connect your phone line before using any online services, including the online registration service.

To access the online Registration web page, you must have a connection to the Internet.

## Using the keyboard

Your keyboard is very similar to a desktop computer's, but the keyboard has additional keys that perform specific notebook-related tasks.

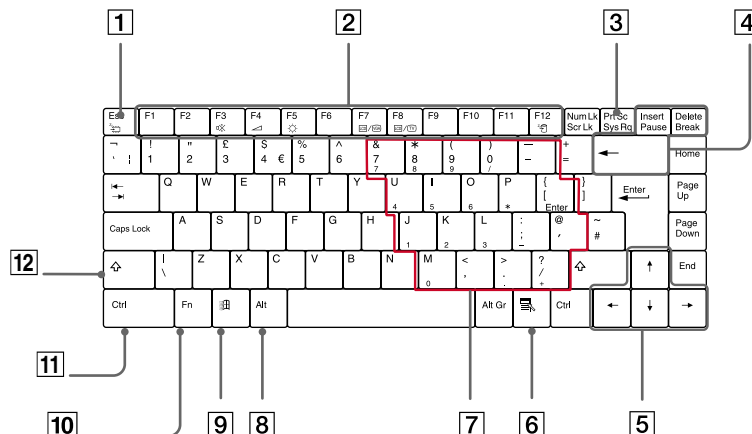



### Keys

### Descriptions

Escape key (1)	The <b>&lt;Esc&gt;</b> (Escape) key is used to cancel commands.
Function keys (2)	The twelve function keys along the top of the keyboard are used to perform designated tasks. For example, in many applications, <b>&lt;F1&gt;</b> is the <b>Help</b> key. The task associated with each function key may vary from one application to the other.
Print Screen key (3)	The <b>&lt;Print Screen&gt;</b> key takes an electronic snapshot of the screen and moves it to the Windows Clipboard. You can then paste the screenshot into a document and print it.
Correction keys (4)	The <b>&lt;Insert&gt;</b> , <b>&lt;Back Space&gt;</b> and <b>&lt;Delete&gt;</b> keys enable you to make corrections.
Navigation keys (5)	These keys enable you to move the cursor on the screen.

*Keys**Descriptions*

Application key (6) 	The <b>Application</b> key displays a shortcut menu; pressing this key is equivalent to clicking the right mouse button.
Numeric keypad area (7)	Contains the keys found on a typical calculator. Use the numeric keypad area to type numbers or to perform mathematical calculations such as addition and subtraction. Note that you must press the <b>&lt;Num Lock&gt;</b> key to activate the numeric keypad. When you do so, the Num Lock light illuminates.
Operator keys (8-11-12)	Several keys are always used with at least one other key: <b>&lt;Ctrl&gt;</b> , <b>&lt;Alt&gt;</b> , and <b>&lt;Shift&gt;</b> . When held down with another key, the <b>&lt;Ctrl&gt;</b> (Control) and <b>&lt;Alt&gt;</b> (Alternate) keys offer another way to execute commands. For example, in many applications, instead of choosing the <b>Save</b> command from a menu, you can hold down <b>&lt;Ctrl&gt;</b> and press <b>S</b> (referred to as Ctrl+S). The <b>&lt;Shift&gt;</b> key is used to produce capital letters or special symbols such as @ and \$.
Windows® key (9) 	The key with the <b>Windows® logo</b> displays the Windows® Start menu; it is equivalent to clicking the <b>Start</b> button on the taskbar.
Fn key (10)	The <b>&lt;Fn&gt;</b> key is used in combination with other keys to execute commands.

## Combinations and functions with the Windows key



<i>Combinations</i>	<i>Functions</i>
Windows + F1	Displays <b>Windows Help</b> .
Windows + Tab	Switches the selected button on the taskbar.
Windows + E	Displays <b>Windows Explorer</b> .
Windows + F	Displays the <b>Search Results</b> window to find a file or folder. This is equivalent to selecting <b>Search</b> and then <b>For files or Folders</b> from the <b>Start</b> menu.
Windows + Ctrl + F	Displays the <b>Search Results - Computers</b> window where you can locate other computers.
Windows + M	Minimizes all displayed windows.
Shift + Windows + M	Returns all minimized windows to their previous size.
Windows + R	Displays the <b>Run</b> window. This is equivalent to selecting <b>Run</b> from the <b>Start</b> menu.
Fn + Windows + Insert	Displays the <b>System Properties</b> window. This is equivalent to double-clicking the <b>System</b> icon in the <b>Control Panel</b> .



## Indicators

### Indicator





### Functions

Power 	<b>Power on:</b> lights green. <b>Standby mode:</b> flashes amber.
Battery 1 	Indicates the status of the battery inserted in the battery bay on the left side of the computer.
Battery 2 	Indicates the status of the battery inserted in the battery bay on the right side of the computer.

















### Light

### On

### Off

 hard disk	Data is read from or written to the hard drive. Do not enter <b>Standby</b> mode or turn off the computer when this indicator light is on.	The hard drive is not being accessed.
 Num Lock	Turns on when the number keys in the numeric keypad are active.	Turns off when the alphanumeric character keys in the keypad area are active.
 Caps Lock	Turns on when the letters appear in uppercase as you type. The <b>&lt;Shift&gt;</b> key lowers the case of typed letters when <b>&lt;Caps Lock&gt;</b> is on.	Turns off when the letters appear in lowercase as you type (unless you hold down the <b>&lt;Shift&gt;</b> key).
 Scroll Lock	Turns on when the screen scrolls differently (depends on the application, no effect in many applications.)	Turns off when the information moves across the display normally.

## Combinations and functions with the Fn key

Combinations/ Feature	Functions
Fn+  (ESC): Standby	Puts the system into <b>Standby</b> mode, a power management state. To return the system to the active state, press any key.
Fn+  (F3): speaker switch	Toggles the built-in speaker on and off.
Fn +  (F4): speaker volume	Adjusts the built-in speaker volume. To increase volume, press <Fn>+<F4> and then  or  To decrease volume, press <Fn>+<F4> and then  or 
Fn +  (F5): brightness control	Adjusts the brightness of the LCD. To increase light intensity, press <Fn>+<F5> and then  or  To decrease light intensity, press <Fn>+<F5> and then  or 
Fn +  /  (F7)*: switch to the external display	Toggles between the LCD, external display (connected to the monitor connector) and both LCD and external display.
Fn +  /  (F8)*	Toggles between the LCD and both LCD and TV.
Fn+  (F12): Hibernate	Provides for the lowest level of power consumption. When you execute this command, the states of the system and of the peripheral devices are written to the hard disk and the system power is turned off. To return the system to its original state, use the power switch to turn on the power.

 \* First you need to connect your external display, then you turn on your notebook. When you connect your external display when the computer is already on, you cannot use the keycombination <Fn>+<F7> or <Fn>+<F8>.

Some functions are not available until Windows is launched.

## Using the touchpad

The keyboard contains a cursor-pointing device, your touchpad (1). You can point to, select, drag, and scroll objects on the screen using the built-in touchpad.

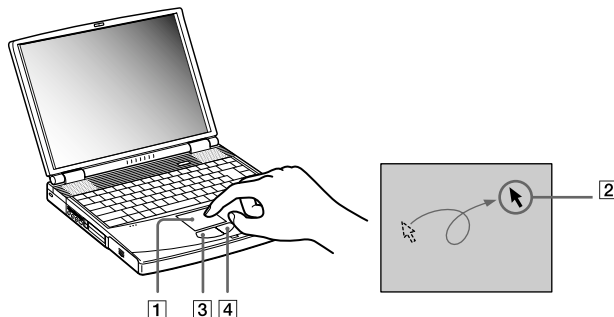

<i>Action</i>	<i>Description</i>
point	Slide one finger on the touchpad to place the pointer (2) on an item or object.
click	Press the left button (3) once.
double-click	Press the left button twice.
right-click	Press the right button (4) once. In many applications, this action displays a shortcut menu.
drag	Slide one finger while pressing the left button.
scroll	Move your finger along the right edge of the touchpad to scroll vertically. Move your finger along the bottom to scroll horizontally. (The scroll function is available only with applications that support a touchpad scroll feature.)

## Using the CD-ROM drive

Your computer is equipped with CD-ROM drive.

To insert a disc, proceed as follows:

- 1 Turn on the computer.
- 2 Press the eject button (1) to open the CD-ROM drive.  
The tray slides out.

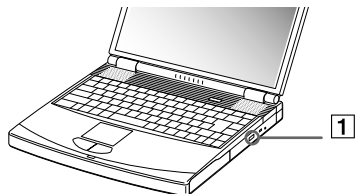

- 3 Place a CD-ROM disc in the middle of the tray with the label side facing up until the disc clicks into place.

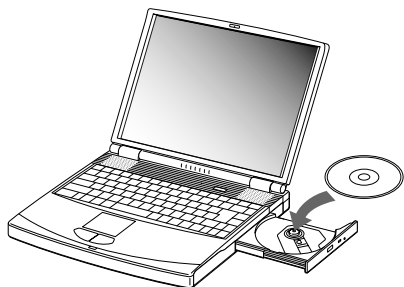

- 4 Close the tray by pushing it gently.

 When the computer is in **Standby** or **Hibernate** mode, you cannot insert or remove a disc.

Be sure to seat the disc firmly over the disc drive hub fingers. If you do not seat the disc firmly, you could damage your disc drive and you may not be able to open the tray.

When you finish using a disc, wait until the LED indicator turns off and then press the eject button to remove the disc.

If the disc does not come out when you press the eject button, go to **Windows Explorer**. Select the drive, click the right button of your mouse and select **Eject**. If it still doesn't work, turn off the computer and insert a thin, pointed object into the manual eject hole.

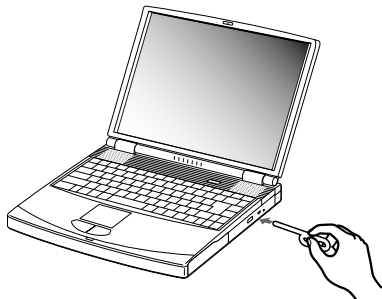

## Using the weight saver

The weight saver protects the multi-purpose bay when it is empty.

To attach the weight saver, proceed as follows:

- 1 If another device is in the multi-purpose bay, remove the device.
- 2 Pull out the guide (1) of the weight saver and slide the weight saver in the direction of the arrow (2) until it clicks.

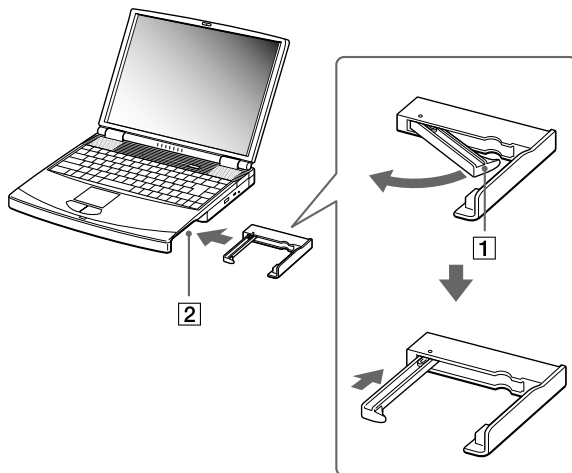

To remove the weight saver, proceed as follows:

- 1 Slide the eject lever of the weight saver in the direction of arrow 1.
- 2 Slide the release lever on the bottom of the computer in the direction of arrow 2.

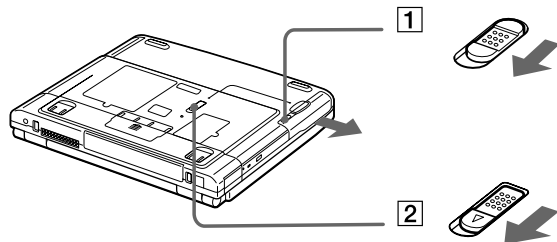

## Using the floppy disk drive

You find the weight saver in the multi-purpose bay. In stead off the weight saver, you can always insert an optional removable floppy disk drive.

### Inserting the floppy disk drive

To insert the floppy disk drive, proceed as follows:

- 1 Turn off the computer.
- 2 If the weight saver is in the multi-purpose bay (1), remove the device.
- 3 Insert the floppy disk drive (2) into the multi-purpose bay with the metallic part up.
- 4 Continue pushing the drive into the bay until the release lever locks into place.

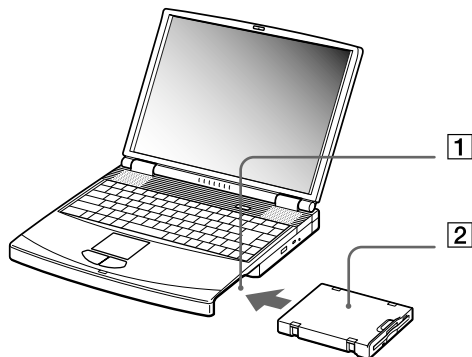



### Inserting a diskette

To insert a diskette, proceed as follows:

- 1 Hold the diskette (1) with the label side facing up.
- 2 Gently push the diskette into the floppy disk drive (2) until it clicks into place.

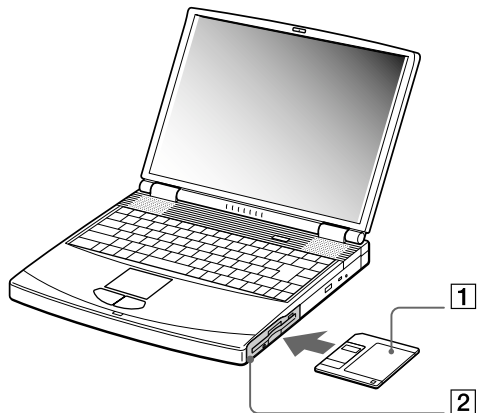

### Removing a diskette

To remove a diskette, proceed as follows:

- 1 Wait until the LED indicator (1) turns off.
- 2 Press the eject button (2) to remove the diskette.

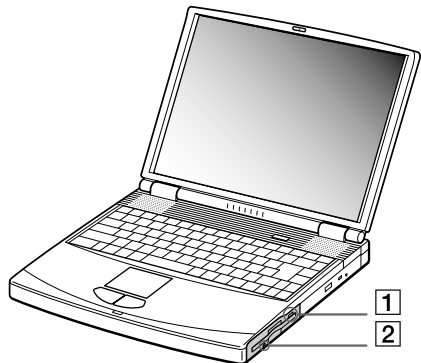

 Do not press the eject button when the LED indicator is turned on. Otherwise, data may be lost.

## Removing the floppy disk drive

To remove the floppy disk drive, proceed as follows:

- 1 Turn off the computer.
- 2 Slide the release lever (1) on the bottom of the computer in the direction of the arrow.

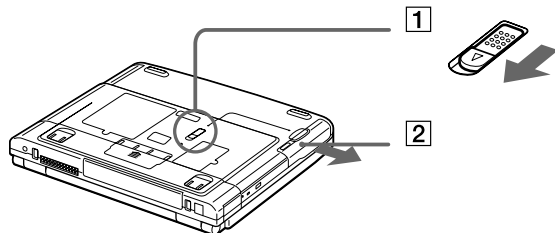

- 3 Slide the drive (2) out of the multi-purpose bay.
- 4 Insert the weight saver.

## Using PC Cards

This computer has a card bus PC Card slot that supports Type I or Type II PC Cards. PC Cards allow you to connect portable external devices.

 You do not need to shut down your computer when inserting a PC Card.

### Inserting a PC Card

To insert a PC Card, proceed as follows:

- 1 Push the release button.  
The release button pops out.
- 2 Push the release button.  
The PC Card slot comes out.

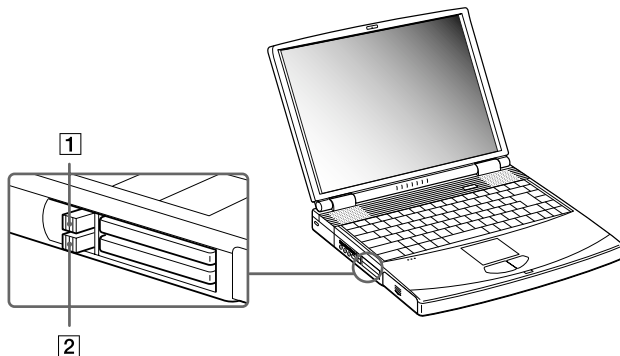

- 3 Insert the PC Card into the PC Card slot front label facing up.

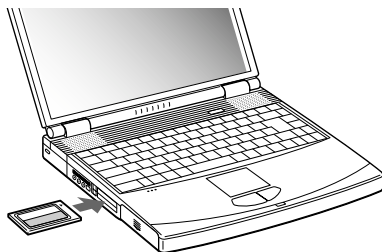

- 4 Gently push the PC Card slot into the connector.  
The PC Card is automatically detected by your system.  
The **Unplug or Eject Hardware** icon appears in the taskbar.

 Some devices may not function properly if you repeat **Returning to Normal mode** from **Standby** mode or **Hibernate** mode.

The computer will return to its original state if you restart it.

The PC Card slots can accommodate (at the same time) two Type I, two Type II or one Type III PC Card. These slots are compatible with Card Bus port. Use the lower slot for PC Type III cards.

Be sure to use the most recent software driver provided by the PC Card manufacturer.

If an "!" mark appears on the **Device Manager** tab in the **System Properties** dialog box, remove the software driver and then reinstall it.

You do not need to shut down the computer before inserting or removing a PC Card.

Do not force a PC Card into the slot. It may damage the connector pins. If you have difficulty inserting a PC Card, check that you are inserting the PC Card in the correct direction. See the manual supplied with your PC Card for more information on use.

For some PC Cards, if you alternate between **Normal** power operation and **Standby** or **Hibernate** power management modes while the card is inserted, you may find that a device connected to your system is not recognized. Reboot your system to correct the problem.

## Removing a PC Card

Follow the steps below to remove the PC Card while your computer is on. If it is not removed properly, your system may not work properly. If you want to remove a PC Card when your computer is off, skip steps 1 to 7.

To remove a PC Card, proceed as follows:

- 1 Double-click the **Unplug or Eject Hardware** icon in the taskbar.  
The dialog box **Unplug or Eject Hardware** appears.
- 2 Select the hardware you want to unplug.
- 3 Click **Stop**.
- 4 In the **Stop a Hardware Device** dialog box, confirm that the device can be safely removed from the system.
- 5 Click **OK**.  
You get the message that it is safe to remove the device.
- 6 Click **OK**.
- 7 Click **Close**.
- 8 Press the PC Card release button so that it pops out.
- 9 Push the PC Card release button to eject the card.
- 10 Gently grasp the card and pull it out.
- 11 If the PC Card release button is still out, push the PC Card release button in the notebook.

 If you unplug the PC Card from the computer when this is still turned on, your system might crash and you might lose data that you did not save before.

Before you remove the PC Card, click the PC Card icon in the taskbar and close the card. Close any applications that use the PC Card before removing the card. Otherwise, data may be lost.

While the card is inserted, your computer may not enter the Hibernate power management mode. It may enter **Standby** mode. It is recommended to remove the card when your computer enters Hibernate mode by pressing <Fn>+<F12> keys, and when it is set to enter **Hibernate** automatically while using a battery as the source of power.

Some PC Cards or their functions may not be compatible with this computer.

## Using Memory Stick™

The Memory Stick™ is specially designed for exchanging and sharing digital data with compatible products. Because it is removable, it can be used for external data storage.

 You need an optional PC Card adapter to use this function.

When the Memory Stick™ erasure prevention switch is set to LOCK, data cannot be recorded or erased.

You can enjoy still images that you have recorded with a Memory Stick compatible video camera recorder or a digital still camera.

Before using Memory Sticks™, you should back up important data.

To avoid damaging data:

- Do not remove a Memory Stick™ or turn off the power while the access light is on.
- Do not use Memory Sticks™ in locations that are subject to static electricity or electrical noise.
- Do not touch the Memory Stick™ connector with your finger or metallic objects.
- Do not attach labels other than the supplied label of a Memory Stick™.
- Do not bend, drop, or apply strong shock to Memory Sticks™.
- Do not disassemble or modify Memory Sticks™.
- Do not allow Memory Sticks™ to get wet.
- Do not use or store Memory Sticks™ in a location that is subject to:
  - Extremely high temperatures, such as in a car parked in the sun
  - Direct sunlight

To prolong the life of Memory Sticks™, use the supplied storage case.

## Inserting a Memory Stick™

To insert a Memory Stick™, proceed as follows:

- 1 Once you have stored your data from your digital device, insert the Memory Stick™ (1) into the optional PC Card adapter (2).



- 2 Push the release button.  
The release button pops out.
- 3 Push the release button.  
The PC Card slot comes out.
- 4 Pull the PC Card slot out of the connector.
- 5 Insert the PC Card adapter into the connector (3) on your computer (label facing up) and push it gently.
- 6 The Memory Stick™ is automatically detected by your system and appears in your **My Computer** window as a local drive, under the appropriate letter (depending on the configuration of your computer). When your Memory Stick™ is detected, the **Unplug or Eject Hardware** icon appears in the taskbar.

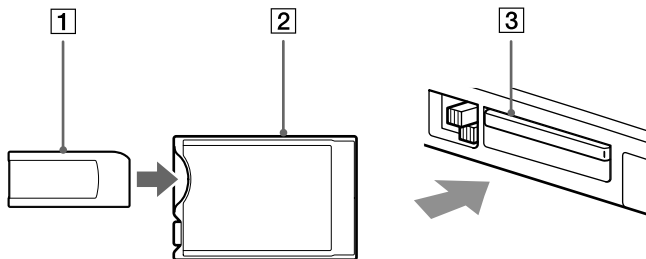

! Hold the Memory Stick™ with the arrow pointing in the correct direction when you insert it into the slot. To avoid damaging the computer or the Memory Stick™, do not force the Memory Stick™ into the slot if it does not insert smoothly.

### Removing a Memory Stick™

To remove a Memory Stick™, proceed as follows:

- 1 Double-click the **Unplug or Eject Hardware** icon in the taskbar.  
The dialog box **Unplug or Eject hardware** appears.
- 2 Select the hardware you want to unplug.

- 3 Click **Stop**.
  - 4 In the **Stop a Hardware device** dialog box, confirm that the device can be safely removed from the system.
  - 5 Click **OK**.  
You get the message that it is safe to remove the device.
  - 6 Click **OK**.
  - 7 Click **Close**.
  - 8 Press the PC Card release button so that it pops out.
  - 9 Push the PC Card release button to eject the card.
  - 10 Gently grasp the card and pull it out.
-  Always remove the Memory Stick™ gently, or it may pop out unexpectedly.  
It is recommended to remove the Memory Stick™ before shutting down the computer.

## Using the modem

Your notebook is equipped with an internal modem. You need to connect a phone line to take advantage of online services and the Internet, to register your computer and software online, and to contact VAIO-Link.

To connect a phone line, proceed as follows:

- 1 Plug one end of the phone cable (1) into the phone line jack on the computer.
- 2 Plug the other end into the wall jack (2).

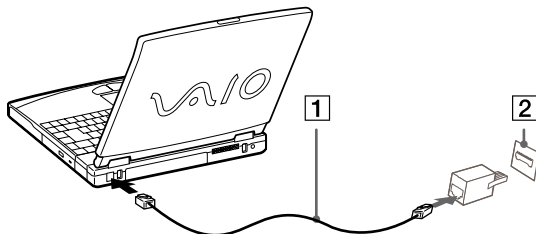

 A country-specific phone plug is supplied with your VAIO notebook, allowing you to plug the phone line into the wall jack. We recommend you to use the supplied plug, because the usage of any other phone plug can decrease the connection quality.

Your computer cannot be connected to a coin-operated telephone, and may not work with multiple phone lines or a private branch exchange (PBX). If you connect the modem to a parallel connected phone line, the modem or the other connected device may not function properly. Some of these connections may result in excess electrical current and could cause a malfunction in the internal modem.

Phone cable and connectors are TNV (Telecommunications Network Voltage), according to EN60950.

Only DTMP (Dual Tone Multi Frequency) signalling (tone dialling) is supported.

## Using power saving modes

When you use a battery as the source of power for your computer, you can take advantage of power management settings to conserve battery life. In addition to the normal operating mode, which allows you to turn off specific devices, your computer has two distinct power saving modes: **Standby** and **Hibernate**. When using battery power, you should be aware that the computer automatically enters **Hibernate** mode when the remaining battery charge drops below 7 percent, regardless of the power management setting you select.

 If the battery level falls to below 10 percent, you should either attach the AC adapter to recharge the battery or shut down your computer and insert a fully charged battery.

## Using Normal mode

This is the normal state of your computer when it is in use. The green power indicator light is on in this mode. To save power, you can turn off a specific device such as the LCD or the hard disk.

## Using Standby mode

The computer saves the current state of the system in RAM and switches off power to the CPU. The amber power light flashes in this mode.

To activate Standby mode, proceed as follows:

Press **<Fn>+<Esc>**

Or,

Press the power button.

To return to Normal mode, proceed as follows:

Press any key.

 If you press the power button for more than four seconds, the computer will switch off automatically.

When the computer is in **Standby** mode, you cannot insert a disc.

**Standby** requires less time than **Hibernate**.

**Standby** uses more power than **Hibernate**.

### Using Hibernate mode

The state of the system is saved on the hard disk and power is turned off. The power indicator light is off in this mode.

To activate Hibernate mode, proceed as follows:

Press **<Fn>+<F12>**.

To return to Normal mode, proceed as follows:

Turn on the computer by pressing the power button.

The computer returns to its previous state.

 When the computer is in **Hibernate** mode, you cannot insert a disc.

**Hibernate** mode requires more time than **Standby** mode.

**Hibernate** mode uses less power than **Standby** mode.

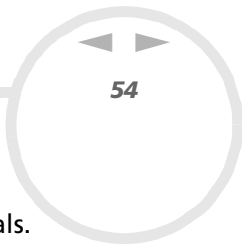

## Connecting peripheral devices

You can add functionality to your computer by connecting or using any of these peripherals.

Before you connect peripherals, turn off the computer and all peripherals.

Connect the power cord only after connecting all cables.

Turn on the computer only after turning on all peripherals.

- ❑ Connecting an external display ([page 55](#))
- ❑ Connecting external speakers ([page 61](#))
- ❑ Connecting an external microphone ([page 62](#))
- ❑ Connecting a Universal Serial Bus (USB) mouse ([page 63](#))
- ❑ Connecting a printer ([page 64](#))
- ❑ Connecting an i.LINK™ device ([page 66](#))
- ❑ Connecting to a network (LAN) ([page 69](#))

## Connecting an external display

You can connect an external display to your notebook. For example, you can use your computer with the following devices:

- ❑ Computer display (monitor);
- ❑ Multimedia computer display;
- ❑ TV;
- ❑ Projector.

 Turn off your computer and the peripherals, unplug the AC adapter and the power cord before connecting the external display.

Connect the power cord after connecting all other cables.

Turn on the peripherals, then turn on your computer.

Connected external displays are used as second screens.

On Windows® systems only, you can also use an external display to set up a virtual desktop.

## Connecting a computer display

To connect a computer display, proceed as follows:

- 1 Plug the display cable (1) in the monitor connector (2) on the computer.
- 2 If necessary, plug one end of the display's power cord (3) into the display, and the other end into an AC outlet.

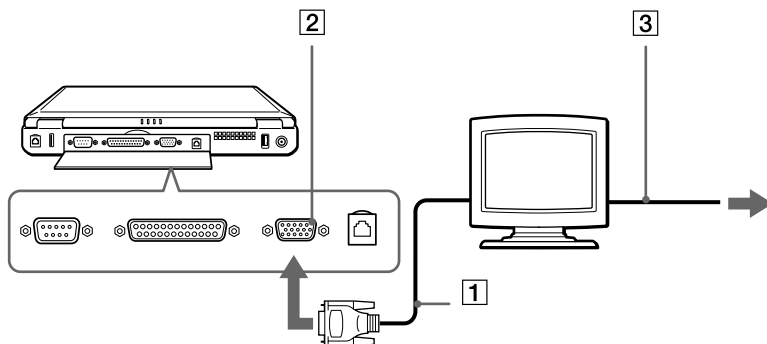



## Connecting a multimedia computer display

You can connect the notebook to a multimedia computer display that includes built-in speakers and a microphone.

To connect a multimedia computer display, proceed as follows:

- 1 Plug the display cable (1) in the monitor connector (2) □ on the computer.
- 2 Plug the speaker cable (3) in the headphone connector (4) ♪ on the computer.
- 3 Plug the microphone cable (5) in the microphone connector (6) 🎤 on the computer.

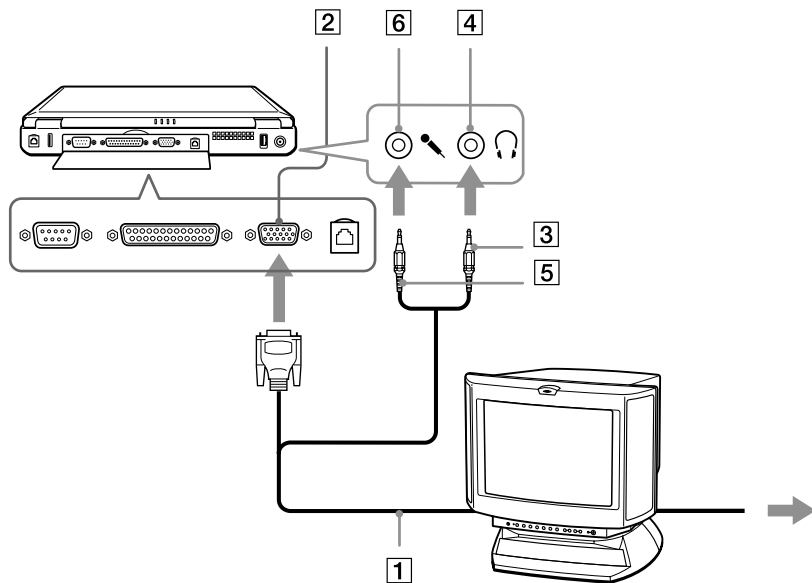

## Connecting a TV

To connect a TV, proceed as follows:

- 1 Plug one end of the audio/video cable (1) into the TV Out connector (2) (yellow) and the other end into the TV.
- 2 Plug one end of the sound cable (3) into the headphone connector (4) and the other end into the TV.
- 3 Plug the power cord of the TV (5) into an AC outlet.
- 4 Switch the input channel of the TV to external input.
- 5 Set up the TV configuration system.

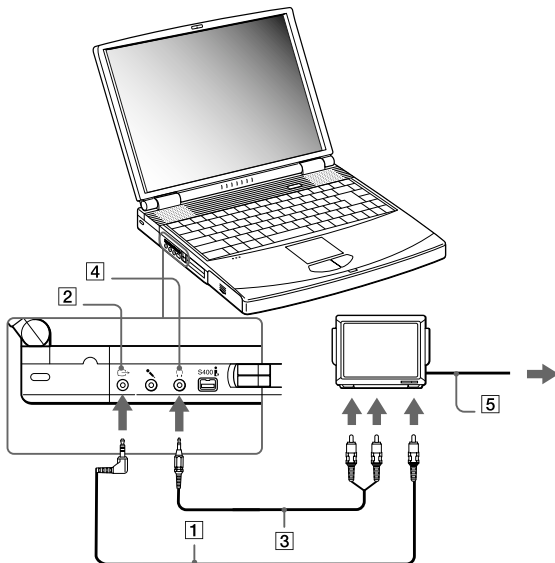



See the manual supplied with your peripheral for more information on installation and use.





## Connecting a projector

You can use a projector as an external display, such as the Sony LCD Projector.

To connect a projector, proceed as follows:

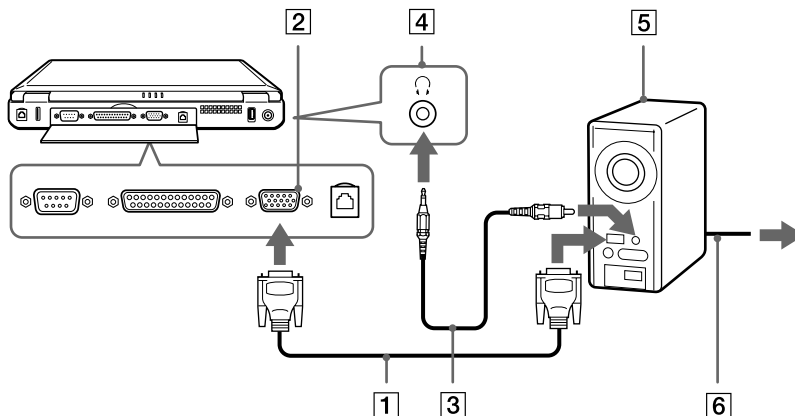
- 1 Plug the RGB signal cable (1) into the monitor connector (2) identified by the □ symbol.
- 2 Plug the audio cable (3) (not supplied) into the earphone connector (4) identified by the 🎧 symbol.
- 3 Plug the RGB signal cable and the audio cable into the connectors of the projector (5).
- 4 Connect the power cord (6) of the projector into an AC outlet.



-  You may not be able to display the computer's LCD and the external display together, depending on the types of computer display and projector used. You can toggle the output between the notebook LCD-screen and the external monitor by pressing the key combination **<Fn>+<F7>**.

## Connecting external speakers

You can enhance the sound quality of your computer by connecting external speakers.

To connect external speakers, proceed as follows:

- 1 Plug the speaker cable (1) into the earphone connector (2).
- 2 Plug the other end of the speaker cable into the external speaker.
- 3 Turn down the volume of the speakers before you turn them on.

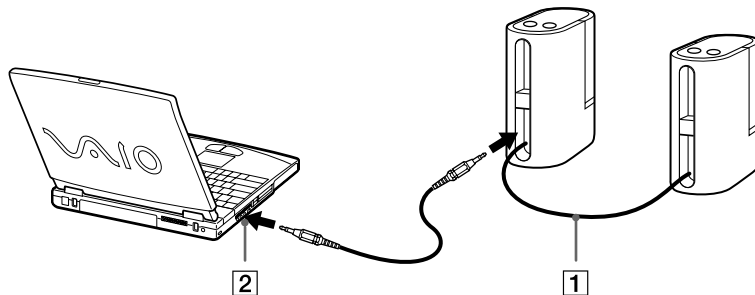

 Make sure your speakers are designed for computer use.

Do not place diskettes on the speakers; their magnetic field may damage the data on the diskettes.

## Connecting an external microphone

Your VAIO notebook does not contain an internal microphone. If you need to use a sound input device, for example to chat on the Internet, you need to plug in an external microphone.

To connect an external microphone, proceed as follows:

- 1 Locate the microphone connector identified by the  symbol.
- 2 Plug the microphone cable (1) into the microphone connector (2).

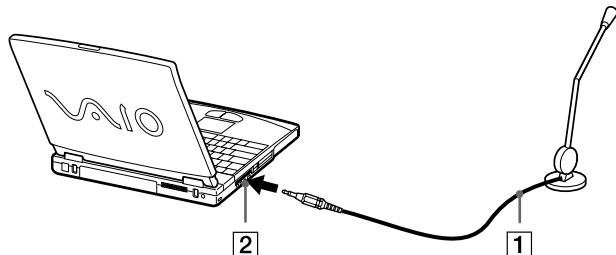

 Make sure your microphone is designed for computer use.

## Connecting a Universal Serial Bus (USB) mouse

You can connect a USB device (e.g. mouse, keyboard...) to your computer.

To connect a USB mouse, proceed as follows:

- 1 You can find 2 USB connectors (1) at the back of your notebook.
- 2 Plug the USB mouse cable (2) into the USB connector.
- 3 You can use your USB mouse (3).

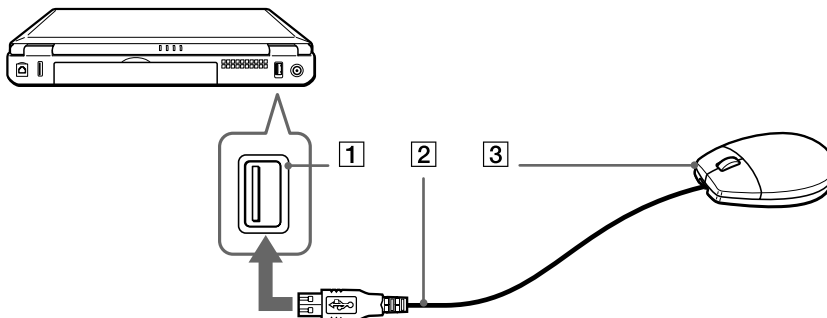

 You do not need to shut down the computer before connecting or disconnecting a USB peripheral.

The USB mouse software driver is preinstalled on your notebook, therefore, you only need to plug the USB mouse into the USB connector and you can start working.

You may need to install software (device drivers) supplied with your USB device before using the USB device.

## Connecting a printer

You can connect a Windows-compatible printer to your computer to print documents.

### Connecting a printer using the USB connector

You can connect a USB printer compatible with your version of Windows to your computer.

To connect a printer using the USB connector, proceed as follows:

- 1 Plug an optional USB printer cable (1) into the USB connector (2) identified by the  symbol on your computer and printer.
- 2 Plug the printer (3) power cord into an AC outlet.

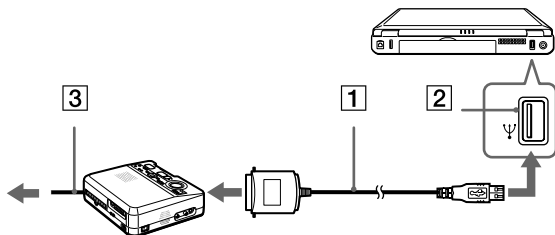

 Turn off your computer and the printer, unplug the AC adapter and the power cord before connecting the printer.



### Connecting a printer using the printer connector

To connect a printer using the printer connector, proceed as follows:

- 1 Plug the printer cable (1) supplied with the printer into the printer connector (2) identified by the  symbol.
- 2 Plug the printer power cord (3) into an AC outlet.

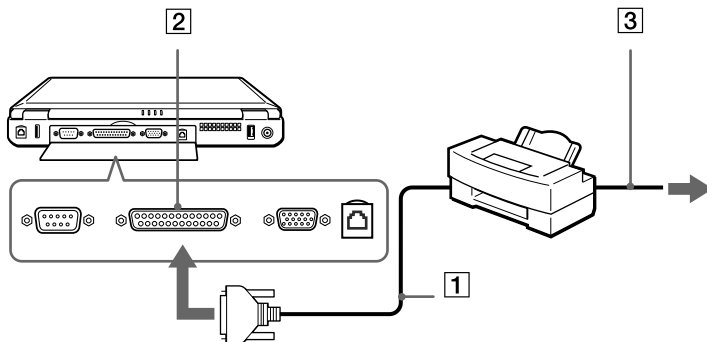

## Connecting an i.LINK™ device

Your computer includes an i.LINK™ (IEEE1394) connector, which you can use to connect to an i.LINK™ device such as a digital video camera recorder or to connect two VAIO notebooks in order to copy, delete or edit files.

The i.LINK™ connector of your notebook does not supply power to external devices generally powered by i.LINK™ connectors.

The i.LINK™ connector supports transfer rates up to 400 Mbps; however, the actual transfer rate depends on the transfer rate of the external device.

The i.LINK™ features available may vary depending on the software applications you use. Refer to the documentation that came with your software for more information.

i.LINK™ cables compatible with your VAIO notebook include cables with the following part numbers: VMC-IL4415 (a 1.5 meter cable with a 4-pin connector at each end), VMC-IL4408Series (a 0.8 meter cable with a 4-pin connector at each end).

## Connecting a digital video camera recorder

To connect a digital video camera recorder, proceed as follows:

- 1 Plug one end of the i.LINK™ cable (1) into the i.LINK™ connector (2) of the the computer and the other end into the DV Out connector (3) on the digital video camera recorder.

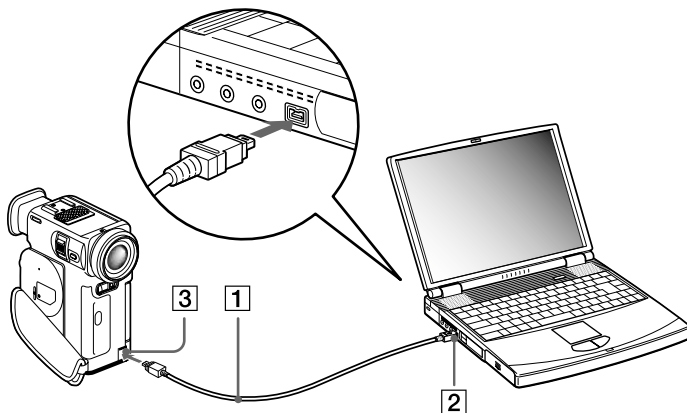

- 2 Launch the DVgate application.

 On Sony digital video cameras, connectors labeled **DV Out**, **DV In/Out** or **i.LINK™** are i.LINK™-compatible.

The Sony digital video camera recorder is an example; your digital video camera recorder may need to be connected differently.

If your digital video camera recorder includes a Memory Stick™ slot, you can copy images from it to your computer via a Memory Stick™. To do so, simply copy images on the Memory Stick™, then insert it into the Memory Stick™ slot of your computer.

## Connecting two VAIO-notebooks

You can connect your notebook to another VAIO notebook using an i.LINK™ cable (1) (not supplied). With Smart Connect\* on your notebook, you can copy, edit or delete files on another VAIO notebook that has also Windows® Millennium® Edition installed or that has Smart Connect 3.0.

You can also print a document on a printer connected to another VAIO computer.

\* You can find Smart Connect on your Applications Recovery CD-ROM.

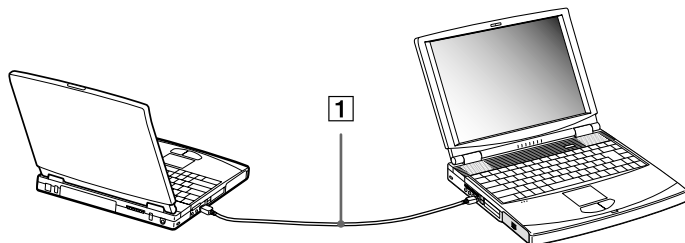

 When you use Smart Connect to connect two VAIO computers, you must assign each computer a unique name by which it can be identified when the two computers are networked.

## Connecting to a network (LAN)

You can connect your computer to 10BASE-T/100BASE-TX-type networks via an Ethernet network cable. For the detailed settings and devices needed to connect to the network, consult your Network Administrator.

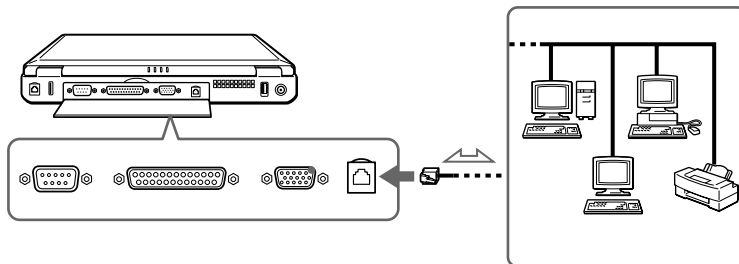

 For more information about connecting your notebook to the network, please consult the Hardware troubleshooting section of the Vaio-Link website:

[How to troubleshoot network problems](#)

! Do not plug a phone cable into your computer network jack.

## Getting help

This section describes how to get help and support from Sony, as well as troubleshooting tips for your computer.

### *Sony support options*

Sony provides several support options for your computer.

#### *Printed documentation supplied with your notebook*

- ❑ The **Customer Guide** explains how to start your computer and use the basic functions. This guide gives you the information to access VAIO-Link.
- ❑ The **Getting Started** gives you a list of the items you find in the box and a summary of the bundled applications.

#### *Online user guides on your Documentation CD-ROM*

- ❑ The **Hardware guide** explains how to use your computer, connect peripheral devices. It contains a list of specifications of your computer and accessories.
- ❑ The **Software guide** lists the pre-installed software titles and explains how to use the utility programs and perform basic computer tasks.
- ❑ The **Customer Service Guide** gives you complete information on the VAIO-Link Services.

#### *Other sources of information*

- ❑ The **online help files** that accompany your pre-installed software contain instructions on using the software.

- ❑ **VAIO-Link website:** if you have any problem with your computer, you can access the VAIO-Link web site. Go to:  
<http://www.vaio-link.com>
  - ❑ **VAIO-Link Response Centre:** Before contacting VAIO-Link Response Centre, try to solve the problem by reading the User Guides and help files for the peripherals or software.
-  You need to plug in the phone line and configure your modem for use before using the communication features described in this manual.

## Troubleshooting

This section describes how to solve common problems you might encounter when using your notebook. Many problems have simple solutions. Please, try these suggestions before contacting VAIO-Link.

### About the computer and software

#### *My computer does not start*

- ❑ Check that the computer is plugged into a power source and that it is turned on.
- ❑ Check that the power indicator on the front panel of the computer indicates that the power is on.
- ❑ Check that the battery packs are inserted properly and that they are charged.
- ❑ Make sure there is no diskette in the (optional) floppy disk drive.
- ❑ Confirm that the power cord and all cables are connected firmly.
- ❑ If you have plugged the computer into an UPS, make sure the UPS is turned on and works.
- ❑ If you are using an external display, check that it is plugged into a power source and turned on. Check that you have switched to the external display and that the brightness and contrast controls are adjusted correctly.
- ❑ Moisture condensation may have occurred. Do not use the computer for at least one hour and then turn it on.

- ❑ If the message **Press <F1> to resume, <F2> to setup** appears at the bottom of the display, you need to initialize the BIOS.
- ❑ Take the battery pack off the notebook, unplug the power cord and plug it again, then turn on the power.

#### *The message 'Press <F1> to resume, <F2> to setup' appears at startup*

If the (optional) floppy disk drive is empty, proceed as follows to initialize the BIOS:

- 1 Turn off the computer.
- 2 Remove any peripheral devices connected to the computer.
- 3 Turn on the computer and press **<F2>** when the Sony logo appears.  
The BIOS setup menu screen appears.
- 4 Press the arrow keys to select the **Exit** menu.
- 5 Press the arrow keys to select **Get Default Values** and then press **<Enter>**. The message **Load default configuration now?** appears.
- 6 Make sure that **[Yes]** is selected and then press **<Enter>**.
- 7 Press the arrow keys to select **Exit** (save changes) and then press **<Enter>**.  
The message **Save configuration changes and exit now?** appears.
- 8 Make sure that **[Yes]** is selected and then press **<Enter>**.
- 9 Restart the computer by pressing **<Ctrl>+<Alt>+<Delete>** twice.

#### *My computer does not shut down*

It is recommended to shut down your computer using the **Shut Down** command on the Windows<sup>®</sup> **Start** menu. Using other methods, including those listed here, may result in loss of unsaved data. If the **Shut Down** command does not work properly, proceed as follows:



- ❑ Restart the computer by pressing <Ctrl>+<Alt>+<Delete>. The **Windows Security** dialog box appears. Click **Shut Down....** The **Shut Down Windows** dialog box appears. Select **Shut down** and click **OK**.
- ❑ If this does not work, press the power button and hold it for at least four seconds. This turns off the power.
- ❑ Unplug the computer from the AC adapter and remove the battery pack from your computer.

### *My computer locks up*

- ❑ If you suspect one application is locking your system, you can try to stop it. To do this, press <Ctrl>+<Alt>+<Delete> once, select the application that is locking your system, and then click **End Task**.
- ❑ If the above method does not work or you do not know which application is locking your system, restart the computer. On the Windows® taskbar, click the **Start** button, click **Shut Down**, and then select **Shut Down** in the list and click **OK**.
- ❑ If the above method does not work, press the power button and hold it for at least four seconds. This turns off the power.
- ❑ If your computer locks up while playing a CD-ROM, stop the CD-ROM, and shutdown the computer by pressing <Ctrl>+<Alt>+<Delete>, and then click **Shut Down**.

### *My software program locks up or crashes*

Contact the software publisher or designated provider for technical support.

### *My touchpad interprets a single tap as a double-click*

Open the **Mouse** icon in the **Control Panel** and change the button assignments in the **Mouse Properties** dialog box. One of the buttons is assigned to the double-click action.

### *My mouse does not work*

- ❑ If you are using a USB mouse, check that the appropriate driver and software are properly installed.
- ❑ Check that the USB mouse is plugged into the USB connector.

### *About the display*

#### *My LCD does not display anything*

- ❑ Check that the computer is plugged into a power source and that it is turned on.
- ❑ Check that the power indicator on the front panel of the computer is on.
- ❑ Check that the battery packs are inserted properly and that they are charged.
- ❑ Adjust the brightness of the LCD.
- ❑ The computer may be in LCD (video) standby mode. Press any key to activate the display.
- ❑ The display mode may be set to external display mode. Press and hold the **Fn** key while pressing **F7** several times.

#### *The screen image on my external display is not centered or sized properly*

Use the controls on your external display to adjust the image.

#### *The window I have just closed continues to appear on my LCD*

Press the **Windows**<sup>®</sup> key and **D** key twice to refresh the screen.

## About CD-ROMs and diskettes

### *My CD-ROM drive tray does not open*

- Make sure the computer is turned on.
- Press the **eject** button on the CD-ROM drive.
- If the **eject** button does not work, you can open the tray by inserting a sharp, pointed object into the hole to the right of the **eject** button.

### *I cannot play a CD*

- Make sure the label of the disc is facing up.
- If the disc requires software, make sure the software is installed according to the instructions of the program.
- Check the volume of your speakers.
- Clean the disc.
- Moisture condensation may have occurred. Leave the computer for at least 1 hour while it is turned on.

### *My (optional) floppy disk drive cannot write to a diskette*

- The diskette is write-protected. Disable the write-protect feature or use a diskette that is not write-protected.
- Check that the diskette is properly inserted into the (optional) floppy disk drive.

### *When I double-click an application icon a message such as 'You must insert the application CD into your CD-ROM drive' appears and the software does not start.*

- Some titles require specific files that are located on the application CD-ROM. Insert the disc and try starting the program again.

- ❑ Make sure you place the disc in the tray with the label side facing up.

*The disc tray does not eject even when the eject button is pressed*



- ❑ Check that the notebook is turned on.

*The disc tray ejects even when it has been locked into place*

- ❑ Ensure that the disc is placed with the label side facing up.
- ❑ Clean the disc and the CD-ROM drive lens.
- ❑ The disc may be scratched. Place another disc to see if that is the reason.
- ❑ There may be condensation in the drive. Remove the disc and leave the drive open for approximately one hour.

## About sound

*My speakers are not producing sound*

- ❑ The built-in speakers may be turned off. Press **<Fn>+<F3>** to turn on the speakers.
- ❑ The speaker volume may be turned to the minimum. Press **<Fn>+<F4>**, and then press  or  to increase the volume.
- ❑ If your computer is powered by battery, check that the battery is inserted properly and that it is charged.
- ❑ If you are using an application that has its own volume control, check that the volume is turned up.
- ❑ Check the volume controls in Windows®.
- ❑ If you use external speakers, check that the speakers are properly connected and the volume is turned up. If the speakers have a mute button, make sure it is off. If batteries power the speakers, check that the batteries are inserted properly and that they are charged.
- ❑ If you have connected an audio cable to the headphone connector, disconnect the cable.

### *My microphone does not work*

If you are using an external microphone, check that the microphone is plugged into the microphone connector.

### *About the modem*

#### *My internal modem does not work*

- Check that the phone line is plugged into your computer.
- Check that the phone line is working. You can check the line by plugging in an ordinary phone and listening for a dial tone.
- Check that the phone number the program is dialing is correct.
- In the **Modems Properties** dialog box (**Control Panel / Modems\***), check that your modem is listed in the **General** tab, and that the location information is correct on the **Dialing Properties** tab.

\* If you do not see the **Modems** icon, proceed as follows:

- 1 In **Control Panel** click **Tools** and click **Folder Options...**
- 2 Select the **View** tab.
- 3 In the **Advanced settings:** dialog box, select the option **Display all Control Panel options and all folder contents.**
- 4 Click **OK.**

#### *My modem cannot establish a connection*

The modem dialing mode may be incompatible with your telephone line.

### *My modem connection is slow*

Many factors influence modem connection speed, including telephone line noise or compatibility with telephone equipment (such as fax machines or other modems). If you think your modem is not connecting properly to other PC-based modems, fax machines, or your Internet Service Provider, check the following:

- Have your phone company check that your phone line is free from any line noise.
- If your problem is fax-related, check that there are no problems with the fax machine you are calling and that it is compatible with fax modems.
- If you are having a problem connecting with your Internet Service Provider, check that the ISP is not experiencing technical problems.
- If you have a second phone line available, try connecting the modem to that line.

### *About peripherals*

#### *I cannot use DV devices. The message 'DV equipment seems to be disconnected or turned off' appears*

- Check that the DV device is turned on and that the cables are properly connected.
- If you are using multiple i.LINK™ devices, the combination of the connected devices may cause unstable operation. In this case, turn off the power of all connected devices and disconnect unused devices. Check the connection and then turn on the power again.

### *My PC Card is not working*

- Make sure the PC Card is compatible with your version of Windows®.

### *I cannot print*

- Check that all the cables of the printer are correctly connected.

- ❑ Check that your printer is correctly configured and that you have up-to-date drivers. If needed, contact your dealer.
- ❑ The default setting for the printer port mode is correct for most printers. If you cannot print, try changing the printer port mode.
- ❑ To change the printer port mode, proceed as follows:
  - ❑ Restart your computer.
  - ❑ When you see the Sony-logo, press <F2>. You are in the BIOS.
  - ❑ Go to the **Advanced** tab.
  - ❑ Use the minus-sign on the numeric keyboard to change the printer port mode. If the printer port mode is set to ECP, change it to Bidirectional (for HP printers). If the printer port is set to Bidirectional, change it to ECP.
  - ❑ Press <F10> and save the new configuration. Your PC will restart.

### *About digital video captures and DVgate*

*While I am recording images to a digital video device using DVgate, my system displays the message 'Recording to DV device failed. Check the power and cable connections to the DV device and try the operation again...'*

Close all open applications and restart your computer. Frequent recording of images to a digital video device while using DVgate sometimes causes this error.

## About power management

### *The Power Management setting is not responding*

Your notebook's operating system may become unstable if a lower power state, such as **Hibernate** is initiated, and then changed before the notebook completely enters the lower power state.

To restore the notebook to its normal operating stability, proceed as follows:

- 1 Close all open applications.
- 2 Push and hold the power button for four seconds or longer to shut down the notebook.



## Precautions

This section describes safety guidelines and precautions to help you protect your computer from potential damage.

Your notebook and memory modules use high precision components and electronic connectors technology. To avoid the invalidation of your guarantee by mishandling, it is recommended that:

- You contact your dealer to install a new memory module.
- You do not install it yourself, if you are not familiar with upgrading memory on a notebook.
- You do not touch the connectors or open the memory panel.

Please contact VAIO-Link if you need assistance.

## *Adding memory*

In the future you may want to install memory modules to expand the functionality of your computer. You can increase the memory by installing optional memory modules.

Be careful when adding memory. Mistakes on installation or removal of the memory module may cause a malfunction.

For memory upgrades, use only PC100 (CL2) SDRAM SO-DIMM (gold leaf contacts).

Electrostatic discharge can damage electronic components. Before touching a memory expansion board, ensure the following:

- ❑ Handle the memory module gently.
  - ❑ The procedures described in this document assume familiarity with the general terminology associated with personal computers and with the safety practices and regulatory compliance required for using and modifying electronic equipment.
  - ❑ Disconnect the system from its power source and from any telecommunication links, networks, or modems before you open the system. Failure to do so may result in personal injury or equipment damage.
  - ❑ Electrostatic Discharge (ESD) can damage memory modules and other components. Install the memory Module only at an ESD workstation. If such a station is not available, do not work in a carpeted area, and do not handle materials that produce or hold static electricity (cellophane wrappers, for example). Ground yourself by maintaining contact with an unpainted metal portion of the chassis while performing the procedure.
  - ❑ Do not open the memory module package until you are ready to install the module. The package protects the module from ESD.
- ! Use the special bag delivered with the memory module or wrap the module in aluminium foil to protect it from electrostatic discharge.



- ! Do not place the memory module in places subject to:
  - Heat sources such as radiators or air ducts,
  - Direct sunlight,
  - Excessive dust,
  - Mechanical vibration or shock,
  - Strong magnets or speakers that are not magnetically shielded,
  - Ambient temperature of more than +35°C or less than +5°C,
  - High humidity.

## Removing a memory module

To remove a memory module, proceed as follows:

- 1 Shut down your computer.
- 2 Disconnect all peripheral devices.
- 3 Unplug the computer and remove the battery pack.
- 4 Wait until the computer cools down.
- 5 Turn your computer upside down.
- 6 Open the cover on the bottom by unscrewing the screws (turn counterclockwise).
- 7 To remove the memory module, pull the tabs in the direction of the arrows 1. The memory module is released.
- 8 Pull the memory module in the direction of arrow 2.
- 9 Close the cover.
- 10 Gently tighten the screws.

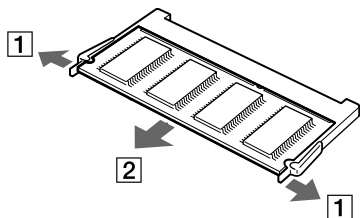

## Installing a memory module

To install a memory module, proceed as follows:

- 1 Shut down your computer and disconnect all peripheral devices.
- 2 Unplug the computer and remove the battery packs.
- 3 Wait until the computer cools down.
- 4 Turn your computer upside down.
- 5 Open the cover on the bottom by unscrewing the screw (turn counterclockwise).

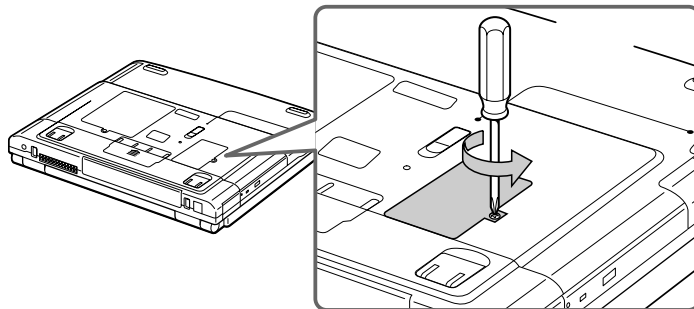

- 6 Remove the memory module from its packaging.
- 7 Install the memory module.

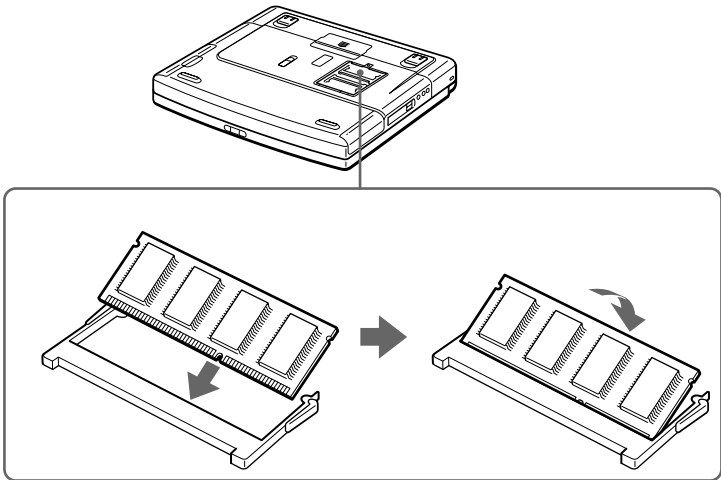

- 8 Close the computer cover.
- 9 Tighten the screws on the bottom of the computer.
- 10 Turn on the computer.

## *Other precautions*

### *On handling the hard disk*

The hard disk has a high storage density and reads or writes data in a short time. On the other hand, it may be easily damaged by mechanical vibration, shock or dust.

Although the hard disk has the safety device in itself to prevent losing data due to mechanical vibration, shock or dust, you should be careful when handling your computer.

To avoid damaging your hard disk:

- Do not give a shock to your computer.
- Keep away from magnets.
- Do not place your computer in a location subject to mechanical vibration or in unstable situation.
- Do not move your computer while the power is on.
- Do not turn off the power or restart the computer while reading or writing data.
- Do not use your computer in a place subject to extreme change of temperature.
- If the hard disk is damaged, the data cannot be restored.

### *On handling the LCD screen*

- Do not leave the LCD facing the sun as it can damage the LCD. Be careful when using the computer near a window.
- Do not scratch the LCD or exert pressure on it. This could cause malfunction.
- Using the computer in low temperature conditions may produce a residual image on the screen. This is not a malfunction. When the computer returns to normal temperature, the screen returns to normal.
- A residual image may appear on the screen if the same image is displayed for a lengthy period of time. The residual image disappears in a while. You can use a screensaver to prevent residual images.

- ❑ The screen becomes warm during operation. This is normal and does not indicate a malfunction.
- ❑ The LCD is manufactured using high-precision technology. You may, however, see tiny black points and/or bright points (red, blue, or green) that continuously appear on the LCD. This is a normal result of the manufacturing process and does not indicate a malfunction.
- ❑ Avoid rubbing the LCD screen, as this can damage the screen. Use a soft, dry cloth to wipe the LCD screen.

### *On using power source*

- ❑ Your computer operates on 100V-240V AC 50/60 Hz.
- ❑ Do not share the AC outlet with other power-consuming equipment, such as a photocopier or shredder.
- ❑ You can purchase a power strip with a surge protector. This device prevents damage to your computer caused by sudden power surges such as those that may occur during an electrical storm.
- ❑ Do not place heavy objects on the power cord.
- ❑ To disconnect the cord, pull it out by the plug. Never pull the cord itself.
- ❑ Unplug your computer from the wall outlet, if you will not be using the computer for a long time.
- ❑ When the AC adapter is not used, unplug it from the AC outlet.
- ❑ Use only the supplied AC adapter. Do not use any other AC adapter.

### *On handling your notebook*

- ❑ Clean the cabinet with a soft, dry cloth or a soft cloth lightly moistened with a mild detergent solution. Do not use any type of abrasive pad, scouring powder, or solvent such as alcohol or benzine, as these may damage the finish of your computer.
- ❑ Should any solid object or liquid fall into the computer, shut down your computer and then unplug it. You may want to have the computer checked by qualified personnel before operating it any further.
- ❑ Do not drop the computer or place heavy objects on top of the computer.
- ❑ Do not place your computer in a location subject to:



- ❑ Heat sources, such as radiators or air ducts,
- ❑ Direct sunlight,
- ❑ Excessive dust,
- ❑ Moisture or rain,
- ❑ Mechanical vibration or shock,
- ❑ Strong magnets or speakers that are not magnetically shielded,
- ❑ Ambient temperature of more than 35°C or less than 10°C,
- ❑ High humidity.
- ❑ Do not place electronic equipment near your computer. The electromagnetic field of your computer may cause a malfunction.
- ❑ Provide adequate air circulation to prevent that internal heat builds up. Do not place your computer on porous surfaces such as rugs or blankets, or near material such as curtains or draperies that may block its ventilation slots.
- ❑ The computer uses high-frequency radio signals and may cause interference to radio or TV reception. Should this occur, relocate the computer a suitable distance away from the set.
- ❑ Use only specified peripheral equipment and interface cables; otherwise, problems may result.
- ❑ Do not use cut or damaged connection cables.
- ❑ Your computer cannot be connected to a coin-operated telephone, and may not work with a private branch exchange (PBX).
- ❑ If the computer is brought directly from a cold location to a warm one, moisture may condense inside your computer. In this case, allow at least one hour before turning on your computer. If any problem occurs, unplug your computer and contact VAIO-Link.
- ❑ Make sure to disconnect the power cord before cleaning the computer.
- ❑ As you may lose important data once your computer is damaged, you should back up your data regularly. Restore the original application programs from the Product Recovery CD-ROM.

### *On handling diskettes*

- ❑ Do not open the shutter manually and touch the surface of the diskette.
- ❑ Keep diskettes away from magnets.
- ❑ Keep diskettes away from direct sunlight and other heat sources.

### *On handling CD-ROM discs*

- ❑ Do not touch the surface of the disc.
- ❑ Do not drop or bend the disc.
- ❑ Fingerprints and dust on the surface of a disc may cause read errors. Proper care of the disc is essential to maintain its reliability. Do not use solvents such as benzine, thinner, commercially available cleaners or anti-static spray, as they may cause damage to the disc.
- ❑ For normal cleaning, hold the disc by its edge and use a soft cloth to wipe the surface from the center out.
- ❑ If the disc is badly soiled, moisten a soft cloth with water, wring it out well, and use it to wipe the surface of the disc from the center out. Wipe off any remaining moisture with a dry soft cloth.

### *On using the battery pack*

- ❑ Never leave the battery pack in temperatures above 60°C, such as in a car parked in the sun or under direct sunlight.
- ❑ Battery life is shorter in a cold environment. This is due to decreased battery efficiency at low temperatures.
- ❑ Charge the batteries at temperatures between 10°C to 30°C. Lower temperatures require a longer charging time.
- ❑ While the battery is in use or being discharged, the battery pack heats up. This is normal and is not cause for concern.

- ❑ Keep the battery pack away from all sources of heat.
- ❑ Keep the battery pack dry.
- ❑ Do not open or try to disassemble the battery pack.
- ❑ Do not expose the battery pack to any mechanical shock.
- ❑ If you are not using the computer for an extended period of time, remove the battery pack from the computer to prevent damage to the battery.
- ❑ If, after fully charging the battery pack, the battery power is still low, the battery pack may be reaching the end of its life and should be replaced.
- ❑ You do not need to discharge the battery before recharging.
- ❑ If you have not used the battery pack for a considerable amount of time, recharge the battery.

### *On using earphones*

- ❑ **Road safety** – Do not use earphones while driving, cycling, or operating any motorized vehicle. It may create a traffic hazard and is illegal in some areas. It can also be potentially dangerous to play loud music while walking, especially at pedestrian crossings.
- ❑ **Preventing hearing damage** – Avoid using earphones at high volume. Hearing experts advise against continuous, loud and extended play. If you experience a ringing in your ears, reduce the volume or discontinue use.

### *On handling Memory Stick™ (optional)*

- ❑ Do not touch the connector with your finger or metallic objects.
- ❑ Use only the label supplied with the Memory Stick™ as a label.
- ❑ Do not bend, drop, or apply strong shock to the Memory Stick™.
- ❑ Do not disassemble or modify Memory Sticks™.
- ❑ Do not let cards get wet.



- ❑ Do not use or store Memory Sticks™ in a location subject to:
  - ❑ Extremely high temperatures, such as in a car parked in the sun,
  - ❑ Direct sunlight,
  - ❑ High humidity or near corrosive substances.
- ❑ Use the storage case supplied with the Memory Stick™.

## Specifications PCG-FX201/PCG-FX202

<b>Model Number</b>	<b>PCG-FX201/PCG-FX202</b>
<i>Operating system</i>	Microsoft® Windows® Millennium Edition
<i>Processor</i>	700 MHz Mobile AMD Duron™ processor
<i>Hard disk drive</i>	10 GB
<i>Standard RAM</i>	64 MB SDRAM (in slot)
<i>Maximum RAM</i>	256 MB
<i>LCD screen</i>	14.1" XGA (1024x768) TFT
<i>L2 cache memory</i>	64 KB (on die)
<i>MPEG</i>	MPEG 1 Digital Video Supports full-screen playback
<i>Graphics</i>	ATI™ 3D RAGE Mobility-M1 with 8 MB Video RAM and 3D accelerator
<i>Display</i>	Dual Display
<i>Sound capabilities</i>	16-bit CD-quality stereo sound
<i>CD-ROM drive</i>	CD-ROM drive: up to 24x max. CD-ROM reading speed  laser diode properties: wave length: 795 nm laser output: 16.5 μW
<i>Internal modem</i>	built-in modem V.90/K56flex (56kbps) data/fax modem
<i>Telecommunication capabilities</i>	Ethernet network, PSTN data connectivity
<i>Expansion capabilities</i>	two PCMCIA type II or one type III Cards and Cardbus support
<i>Built-in capabilities</i>	stereo speakers, touchpad

**Model Number****PCG-FX201/PCG-FX202**

<i>Connection capabilities on notebook</i>	monitor (VGA output), external speakers or headphone, external microphone, 2 USB, serial, parallel, TV Out, modem, i.LINK™ (IEEE1394) S400, Ethernet
<i>Supplied accessories</i>	rechargeable battery, AC adapter, AC power cord, phone cable, phone plug, video cable, weight saver.
<i>Service</i>	‡ 1 year free VAIO-Link Service
<i>Guarantee</i>	‡ 1 year guarantee (parts and labour)
<i>Power source</i>	19.5V DC AC100-240V
<i>Power management</i>	ACPI (Advanced Configuration & Power Interface)
<i>Battery</i>	Lithium ion
<i>Dimensions</i>	
<i>Width</i>	324 mm
<i>Height</i>	35.8 mm to 46.9 mm
<i>Depth</i>	265.5 mm
<i>Weight</i> - with 1 battery and weight saver	2.9 kg
<i>Operating temperature</i>	+5°C to +35°C (temperature gradient less than 10°C/hour)
<i>Storage temperature</i>	-20°C to +60°C (temperature gradient less than 10°C/hour)
<i>Operating humidity</i>	20% to 80% (not condensed), provided that humidity is less than 65% at +35°C (hygrometer reading of less than 29°C)
<i>Storage humidity</i>	10% to 90% (not condensed), provided that humidity is less than 20% at +60°C (hygrometer reading of less than 35°C)

‡ See our special Guarantee extension conditions.

Specifications are subject to change without notice.

# INDEX

## A

AC adapter 5, 10, 18  
accessory 94  
air circulation 89  
Alt key 31  
application key 31  
audio cable 58, 60

## B

battery  
  bay 14, 19  
  charging status 20  
  charging the 20  
  indicator 20  
  pack 19, 22, 26  
battery indicator 15, 33  
battery pack 10  
brightness control 27, 34  
built-in capability 93  
button 15  
  power 27

## C

cable  
  audio 58, 60  
  display 56, 57  
  Ethernet network 69  
  i.LINK™ 67  
  microphone 57, 62  
  phone 51  
  printer 64  
  RGB signal 60  
  speaker 57, 61  
  video 10, 58  
camera 67  
Caps Lock indicator 15, 33  
CD-ROM drive 5, 8, 10, 13, 36, 93  
charging status 20  
combination controls 32, 34  
connection capability 94  
connector  
  DC In 18  
  earphone 60, 61  
  Ethernet 16  
  headphone 14, 57, 58  
  i.LINK™ 14  
  microphone 14, 62  
  monitor 16, 56, 57, 60  
  printer 65  
  serial 16  
  TV Out 14, 58  
  USB 16, 64

copyright 2  
correction key 30  
Ctrl key 31  
Customer Guide 70  
Customer Service Guide 70

## D

DC In 16, 18  
digital video camera 67  
dimension 94  
diskette  
  inserting a 41  
  removing a 42  
display 55, 93  
  cable 56, 57  
  computer 55, 56  
  multimedia computer 55, 57  
  resolution 59  
documentation pack 9, 10  
DVD-ROM drive 59  
DVgate 67

## E

earphone connector 60, 61  
eject lever 26, 39  
Energy Star guidelines 3  
ergonomic considerations 11

Escape key 30  
Ethernet 8  
    network cable 69  
Ethernet connector 16  
expansion capability 93  
external  
    display 34  
    microphone 62  
    speaker 61

## F

floppy disk drive 40, 43  
Fn key 31, 34  
function key 30

## G

graphic 93  
guarantee 4, 29, 94

## H

hard disk drive 93  
hard disk drive indicator 15, 33  
headphone connector 14, 57  
heaphone connector 58  
help 70

Help key 30  
Hibernate mode 21, 34, 53  
humidity  
    operating 94  
    storage 94

## I

i.LINK™ 8, 14  
    cable 67  
    device 66  
indicator  
    battery 15, 20, 33  
    Caps Lock 15, 33  
    hard disk drive 15, 33  
    LED 42  
    Num Lock 15, 33  
    power 15, 33  
    Scroll Lock 15, 33  
Insert key 30

## K

key  
    Alt 31  
    application 31  
    combination 59, 60  
    correction 30  
    Ctrl 31

Escape 30  
Fn 31, 34  
function 30  
Help 30  
Insert 30  
navigation 30  
operator 31  
Print Screen 30  
Shift 31  
    Windows 31, 32  
keyboard 15, 30

## L

L2 cache memory 93  
LCD screen 8, 15, 93  
LED indicator 42  
lithium ion battery 7  
lock lever  
    LCD 27

## M

Macrovision 2  
maximum RAM 93  
memory module  
    adding a 85  
    removing a 84  
Memory Stick™ 88



inserting a 48  
removing a 49

microphone 62  
cable 57, 62  
connector 62

microphone connector 14, 62

mode  
Standby 33

model number 4

modem 4, 5, 8, 51, 93

moisture condensation 89

monitor 55

monitor connector 16, 56, 57, 60

MPEG 93

multi-purpose bay 13, 23, 38, 43

## N

navigation key 30

network 69

Normal mode 52

Num Lock 31

Num Lock indicator 15, 33

numeric keypad 31

## O

operating system 93

operator key 31

## P

PC Card  
adapter 48  
inserting a 44  
removing a 46  
slot 44

PC Card slot 14

peripherals 54

phone  
cable 10, 51  
line jack 51  
plug 10

phone line jack 16

power button 13, 27

power cord 10, 58, 60, 64, 65

power indicator 15, 33

power management 94

power source 94

precautions 81

Print Screen key 30

printer 16, 64, 65  
cable 64  
connector 65

processor 93

product recovery CD-ROM 10

projector 55, 60

## R

registration 29

regulatory information 6

release lever 17, 26, 39, 43

RGB signal cable 60

## S

Scroll Lock indicator 15, 33

serial connector 16

serial number 4

service 94

Shift key 31

slot  
PC Card 14, 44

Smart Connect 68

Software guide 70

sound 93

speaker 15, 61  
cable 57, 61  
switch 34

speaker volume 34

specifications 93

standard RAM 93

Standby mode 21, 34

switch  
speaker 34

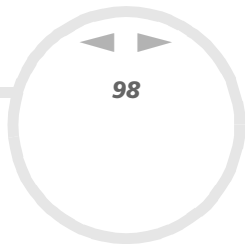

## T

- technical specifications [93](#)
- telecommunication [93](#)
- temperature
  - operating [94](#)
  - storage [94](#)
- tilt stand [17](#)
- touchpad [15](#), [35](#)
- trademark [3](#)
- troubleshooting [71](#)
- TV [55](#), [58](#)
- TV Out connector [14](#), [58](#)

## U

- USB
  - connector [64](#)
  - mouse [63](#)
- USB connector [16](#)

## V

- VAIO [8](#)
- VAIO-Link [4](#), [8](#), [29](#), [71](#)
- VAIO-Link Response Centre [71](#)
- ventilation [89](#)
- ventilation slot [16](#)
- video cable [10](#), [58](#)

- video camera [67](#)

## W

- warnings [4](#)
- weight [94](#)
- weight saver [10](#), [23](#), [38](#), [43](#)
- Windows key [31](#), [32](#)