

Sony Notebook User Guide

**PCG-FX101 / PCG-FX103 / PCG-FX105K/
PCG-FX108K / PCG-FX109K**

The logo features a stylized blue wave on the left, followed by a solid blue dot, and then the numbers '10' in a bold, blue, sans-serif font.

Read this first

Notice

© 2001 Sony Corporation. All rights reserved.

This manual and the software described herein, in whole or in part, may not be reproduced, translated, or reduced to any machine-readable form without prior written approval.

Sony Corporation provides no warranty with regard to this manual, the software, or other information contained herein and hereby expressly disclaims any implied warranties or merchantability or fitness for any particular purpose with regard to this manual, the software or such other information. In no event shall Sony Corporation be liable for any incidental, consequential, or special damages, whether based on tort, contract, or otherwise, arising out of or in connection with this manual, the software, or other information contained herein or the use thereof.

Macrovision: This product incorporates copyright protection technology that is protected by method claims of certain U.S. patents and other intellectual property rights owned by Macrovision Corporation and other rights owners. Use of this copyright protection technology must be authorized by Macrovision Corporation, and is intended for home and other limited viewing uses only unless otherwise authorized by Macrovision Corporation. Reverse engineering or disassembly is prohibited.

Sony Corporation reserves the right to make any modification to this manual or the information contained herein at any time without notice. The software described herein is governed by the terms of a separate user license agreement.

Sony, DVgate, i.LINK™ and the i.LINK™ logo, PictureGear, Memory Stick and the Memory Stick logo, VAIO and the VAIO logo are trademarks of Sony Corporation.

i.LINK™ is the name for the IEEE 1394-1995 standards and their revisions.

Microsoft, Windows and the Windows logo, Windows Media and Outlook are trademarks or registered trademarks of U.S. Microsoft Corporation in the U.S. and other countries.

Adobe®, Adobe® Acrobat® Reader, Adobe® Premiere® are trademarks of Adobe Systems Incorporated.

QuickTime and the QuickTime logo are trademarks used under license. QuickTime is registered in the U.S. and other countries.

RealPlayer is a trademark or registered trademark of RealNetworks, inc. in the U.S. and other countries.



PowerPanel is a trademark of U.S. Phoenix Technologies Corporation.

VirusScan is a trademark of Network Associates Corporation.

All other names of systems, products and services are trademarks of their respective owners. In the manual, the ™ or ® marks are not specified.

Specifications are subject to change without notice.

As an ENERGY STAR Partner, Sony has determined that this product meets the ENERGY STAR guidelines for energy efficiency.

The International ENERGY STAR Office Equipment Program is an international program that promotes energy saving through the use of computers and their office equipment. The program backs the development and dissemination of products with functions that effectively reduce energy consumption. It is an open system in which business proprietors can participate voluntarily. The targeted products are office equipment such as computers, displays, printers, facsimiles and copiers. Their standards and logos are uniform among participating nations.

ENERGY STAR is a U.S. registered mark.



Safety information

Owner's record

The model number and serial number are located on the bottom of your Sony notebook. Record the serial number in the space provided here. Refer to the model and serial number when you call VAIO-Link.

Serial number: _____

Model number: **PCG-9516 / PCG-9526 / PCG-9536 / PCG-954C / PCG-955C**

Warnings

General

- Opening the unit, for whatever reason, could lead to damages that are not covered by the guarantee.
- To avoid electrical shock, do not open the cabinet. Refer servicing to qualified personnel only.
- To prevent fire or shock hazard, do not expose your VAIO notebook to rain or moisture.
- Avoid using the modem during a storm.
- Do not use the modem or a telephone to report a gas leak in the vicinity of the leak.
- To change the backup battery, please contact your nearest SONY Service Center.

Audio/video

- Audio and picture distortion may occur if this equipment is positioned in close proximity to any equipment emitting electromagnetic radiation.

Connectivity

- Never install modem or telephone wiring during a storm.

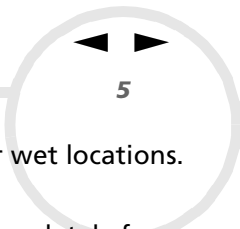

- ❑ Never install telephone jacks in wet locations unless the jack is specifically designed for wet locations.
- ❑ Use caution when installing or modifying telephone lines.
- ❑ Use your notebook only with the supplied AC adapter. To disconnect your notebook completely from mains voltage, unplug the AC adapter.
- ❑ Please make sure that the socket outlet is easily accessible.
- ❑ Never touch uninsulated telephone wire or terminals unless the telephone line has been disconnected at the network interface.

Optical disk

- ❑ The use of the optical instruments supplied with your notebook will cause eye hazard. As the laser beam used in this product is harmful to eyes, do not attempt any disassembling process. For servicing, refer to qualified personnel only.
- ❑ There are visible and invisible radiations when the optical disk drive drive is open: avoid direct exposure to the laser beam.

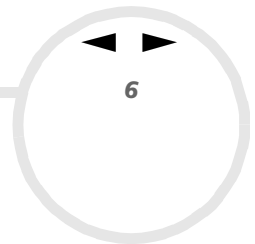

Regulatory information

This product conforms to the following European Directives:

73/23/EEC (Low Voltage Directive)

89/336/EEC, 92/31/EEC (EMC Directives)

93/68/EEC (CE Marking Directive)

1999/5/EC (radio equipment and telecommunications terminal equipment Directive)



This product complies with EN 55022 Class B and EN 50082-1 for use in following areas: residential, commercial and light-industrial.

This product has been tested and found compliant with the limits set out in the EMC Directive for using connection cables shorter than 3 metres (9.8 feet).

The optical disk drive is classified as a CLASS 1 LASER PRODUCT and complies with the Laser Product Safety Standard EN 60825-1. Repair and maintenance only by authorized Sony technicians. Improper repairs and use can create safety hazards.



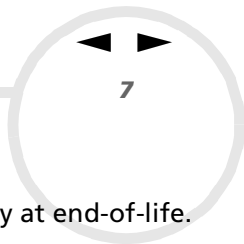

Disposing of lithium ion batteries

Do not handle damaged or leaking lithium ion batteries. Dispose of promptly and properly at end-of-life.

Danger of explosion if battery is incorrectly replaced. Replace only with the same or equivalent type recommended by the manufacturer. Discard used batteries according to the manufacturer's instructions.

The battery pack used in this device may present a fire or chemical burn hazard if mistreated. Do not disassemble, heat above 100°C (212°F) or incinerate.

Keep away from children.

Your notebook is equipped with an internal backup memory battery. For changing this battery, please contact VAIO-Link:

<http://www.vaio-link.com>

In some areas the disposal of lithium ion batteries in household or business waste may be prohibited.

Use the public collection system.

Welcome

Congratulations on purchasing a Sony VAIO notebook. Sony has combined leading-edge technology in audio, video, computing and communications to provide you with state-of-the-art personal computing.

Here are just some of the features your VAIO notebook has to offer.

- ❑ **Exceptional performance** - Your PC includes a fast processor, a fast CD-ROM*, DVD-ROM* or CD-RW/DVD-ROM drive* and an internal modem.
- ❑ **Portability** - The rechargeable battery pack provides hours of use without AC power.
- ❑ **Sony audio and video quality** - A high-resolution LCD screen enables you to take advantage of today's advanced multimedia applications, games, and entertainment software.
- ❑ **Multimedia features** – Enjoy the speakers to listen to audio and video CDs.
- ❑ **Interconnectivity** – Your computer has ethernet* and i.LINK™ functionalities. i.LINK™ is a bidirectional digital interface for exchanging data.
- ❑ **Windows®** - Your system includes the latest operating system from Microsoft.
- ❑ **Communications** - Access popular online services, send and receive e-mails, browse the Internet...
- ❑ **Excellent customer support** - If you are experiencing any problems with your computer, please check the VAIO-Link web site for a possible solution:
<http://www.vaio-link.com>
- ❑ Before contacting VAIO-Link, you may try to solve the problem by reading the User Guide or the manuals and help files for the peripherals or software.

* Depending on your model

Documentation pack

Your Documentation Pack contains paper and online user guides on a Documentation CD-ROM.

Printed documentation

- ❑ A **Getting Started** brochure, where you find a brief description of the items in your box and some specifications of your notebook;
- ❑ A **Customer Guide**, where you find all the basic information to start using your notebook;
- ❑ A **Modem Regulations Flyer** applying to the modem;
- ❑ Your **Sony Guarantee conditions**.

Online documentation

- 1 The Sony Notebook User Guide:
 - ❑ **Using Your Sony Notebook** shows you how to use the standard components of your system.
 - ❑ **Connecting Peripheral Devices** explains how you can add functionality by connecting various peripherals.
 - ❑ **Getting Help** explains the support options available to you, and offers basic troubleshooting tips.
 - ❑ **Precautions** provides facts and advice about using your notebook.
 - ❑ **Specifications** provides details on your computer, drivers and accessories.
- 2 Refer to your **Software Guide** for information on the bundled software and the Sony applications.
 - ❑ **About the Software** is a short description of the features of the software pre-installed on your system.
 - ❑ **Customizing your notebook** explains how to set your system and power management.
 - ❑ **Using the Product Recovery CD-ROMs** explains how to perform a system and application recovery.
- 3 Consult the **Online Help** files of the software you are using for detailed information on features and troubleshooting.
- 4 Refer to the Microsoft **Quick Start** manual for more information on Windows.

Your notebook and its accessories

Following hardware items should be in the box:

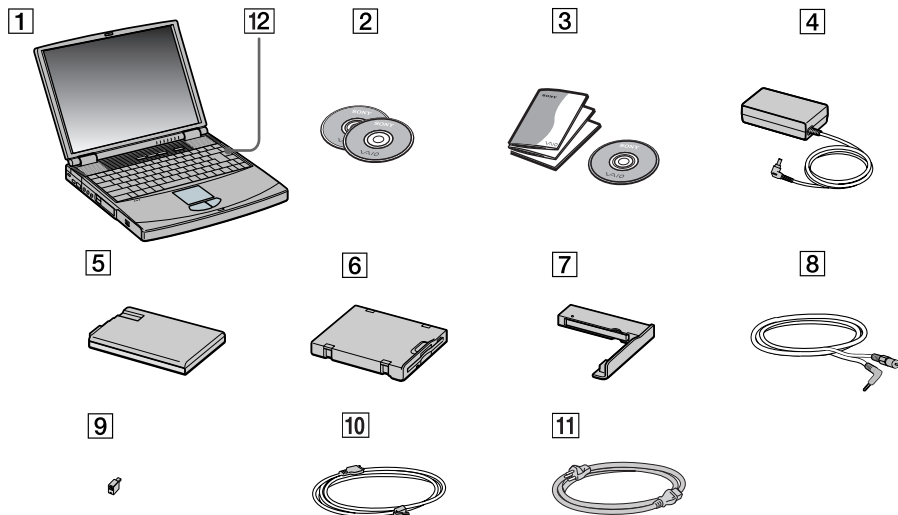

1	main unit	5	rechargeable battery pack	9	phone plug (country specific)
2	product recovery CD-ROMs	6	removable floppy disk drive (installed at factory)*	10	phone cable
3	documentation pack	7	weight saver	11	power cord
4	AC adapter	8	video cable**	12	optical disk drive (installed at factory)***

* PCG-FX101 has no floppy disk drive.

** PCG-FX101 and PCG-FX103 have no video cable.

*** PCG-FX101: CD-ROM drive.

PCG-FX103 / PCG-FX105K / PCG-FX108K: DVD-ROM drive

PCG-FX109K: CD-RW/DVD-ROM drive

Ergonomic considerations

You will be using your notebook as a portable device in a variety of environments. Whenever possible, you should attempt to take account of the following ergonomic considerations to both stationary and portable environments:

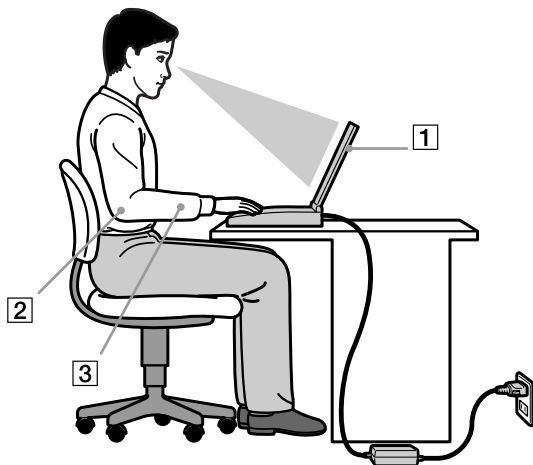

- ❑ **Position of your computer** – Place the computer directly in front of you (1). Keep your forearms horizontal (2), with your wrists in a neutral, comfortable position (3) while using the keyboard, touchpad, or external mouse. Let your upper arms hang naturally at your sides. Have breaks during sessions with your computer. Excessive use of the computer may strain muscles or tendons.
- ❑ **Furniture and posture** – Sit in a chair with good back support. Adjust the level of the chair so your feet are flat on the floor. A footrest may make you more comfortable. Sit in a relaxed, upright posture and avoid slouching forward or leaning far backwards.

- ❑ **Viewing angle of the computer's display** – Use the display's tilting feature to find the best position. You can reduce eye strain and muscle fatigue by adjusting the tilt of the display to the proper position. Adjust the brightness setting of the display as well.
- ❑ **Lighting** – Choose a location where windows and lights do not create glare and reflection on the display. Use indirect lighting to avoid bright spots on the display. You can also purchase accessories for your display that help reduce glare. Proper lighting adds to your comfort and work effectiveness.
- ❑ **Placement of an external display** – When using an external display, set the display at a comfortable viewing distance. Make sure the display screen is at eye level or slightly lower when you are sitting in front of the monitor.
- ❑ **Tilt stands** - You use the tilt stands to place the computer at an angle that allows comfortable typing.

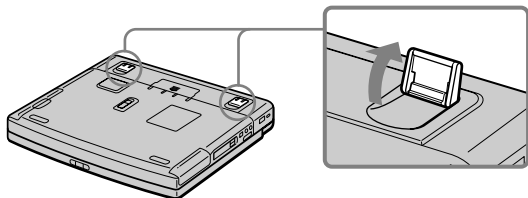

Using your notebook

This section describes how to start using your computer and how to use your computer's internal and external devices.

Locating controls and connectors

Right

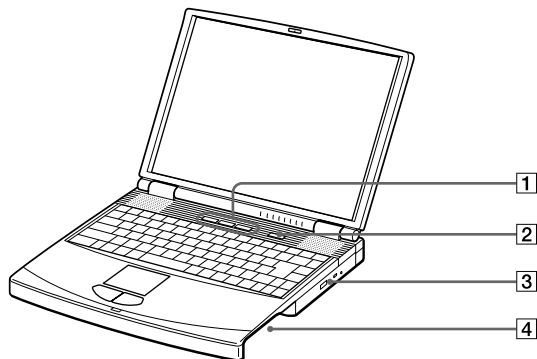

1	PPK buttons*	(page 51)	3	optical disk drive**	(page 35)
2	power button	(page 27)	4	multi-purpose bay (for weight saver or floppy disk drive)***	(page 40) (page 41)

* Except on PCG-FX101

** PCG-FX101: CD-ROM drive

PCG-FX103 / PCG-FX105K / PCG-FX108K: DVD-ROM drive

PCG-FX109K: CD-RW/DVD-ROM drive

*** PCG-FX101 has no floppy disk drive.

 Phone cable and connectors are TNV (Telecommunications Network Voltage), according to EN60950.

Left

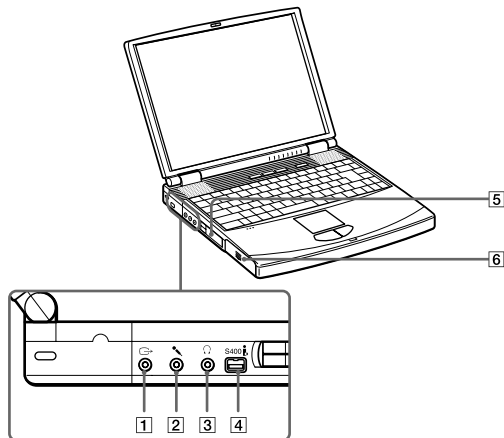

1	TV Out connector*	(page 61)	4	i.LINK™ connector	(page 72)
2	microphone connector	(page 65)	5	PC Card slots	(page 44)
3	headphone connector	(page 64)	6	battery bay	(page 18)

* Only on PCG-FX105K/PCG-FX108K/PCG-FX109K

 AC adapter mains connector and power cord: hazardous voltage, according to EN 60950.

All other connectors for this notebook are SELV (Safety Extra Low Voltage), according to EN 60950.

Front

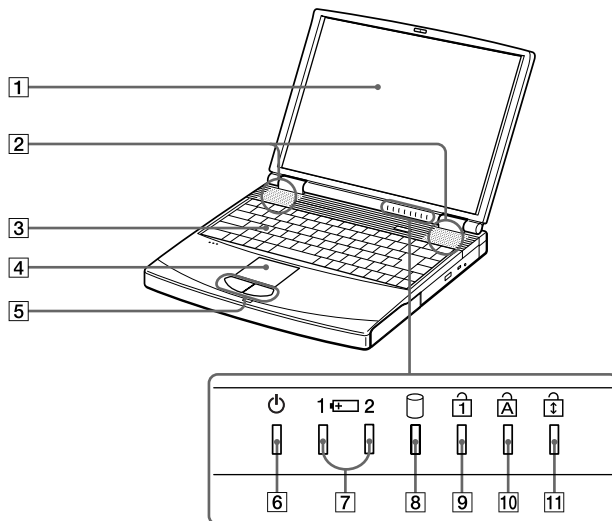

1	LCD screen	(page 33)	7	battery 1 and 2 indicators	(page 32)
2	speakers	(page 33)	8	hard disk drive indicator	(page 32)
3	keyboard	(page 30)	9	Num Lock indicator	(page 32)
4	touchpad	(page 34)	10	Caps Lock indicator	(page 32)
5	left/right buttons	(page 34)	11	Scroll Lock indicator	(page 32)
6	power indicator	(page 32)			

Back

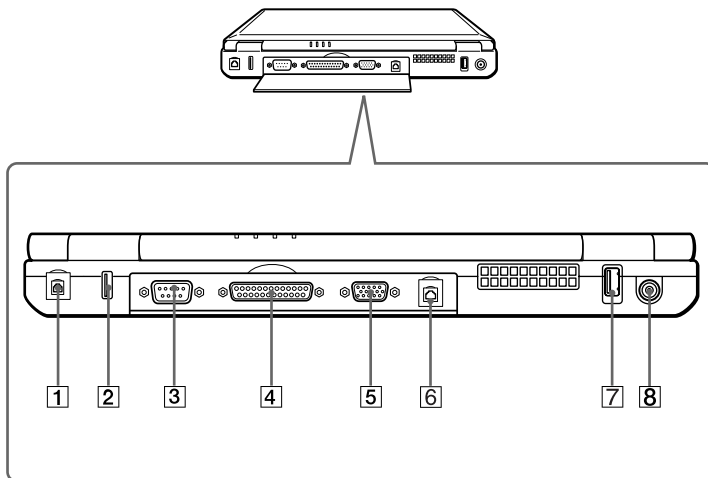

1	phone line jack	(page 50)
2	USB connector	(page 67)
3	serial connector	(page 69)
4	printer	(page 69)
5	monitor connector	(page 59)
6	ethernet connector*	(page 75)
7	USB connector	(page 67)
8	DC In	(page 18)

* Not on PCG-FX101.

 There is a ventilation slot located near the USB connector. Do not cover the ventilation slot when your computer is on.

Bottom

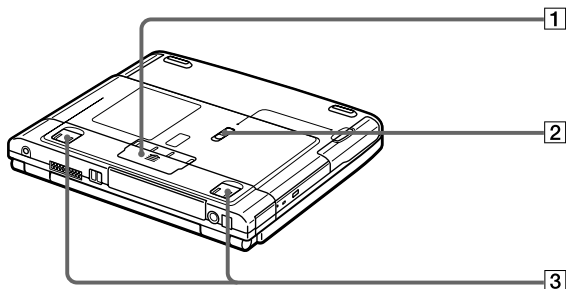

1	port replicator connector cover*	(page 55)
2	release lever	(page 55)
3	tilt stands	(page 11)

* The port replicator connector cover of the PCG-FX101 does not open.

Connecting a power source

You can use either an AC adapter or a rechargeable battery pack as a power source.

Using the AC adapter

To use the AC adapter, proceed as follows:

- 1 Plug the cable attached to the AC adapter (1) into the DC In connector (2) on the computer.
- 2 Plug one end of the power cord (3) into the AC adapter.
- 3 Plug the other end of the power cord into an AC outlet.

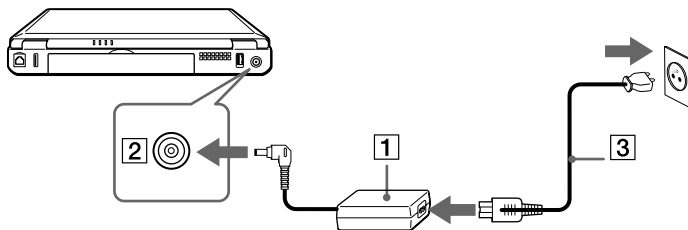

Use your notebook only with the supplied AC adapter.

To disconnect your notebook completely from mains voltage, unplug the AC adapter.

Make sure that the socket outlet is easily accessible.

Using the battery pack

You can use one or two batteries as a source of power. You can insert the second battery pack into the multi-purpose bay on the right side of the computer. Additional battery packs are available as a separate option. The battery pack supplied with your computer is not fully charged at the time of purchase.

Inserting the battery pack

To insert the battery pack, proceed as follows:

- 1 Open the cover of the battery bay.

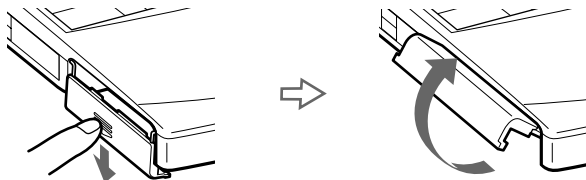

- 2 Insert the battery pack with the label facing down into the battery bay on the left side of the computer.

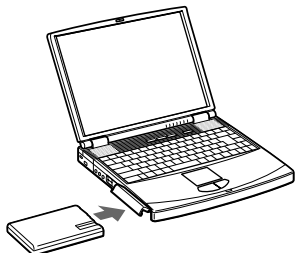

- 3 Close the cover of the battery bay until it clicks.

 When the computer is directly connected to AC power and has a battery pack inserted in the battery bay, it uses power from the AC outlet.



Charging the battery pack

To charge the battery pack, proceed as follows:

- 1 Connect the AC adapter to the computer.
- 2 Insert the battery pack.

The computer automatically charges the battery (1) (the battery indicator (2) light flashes in a double blink pattern as the battery charges). When the battery is 85% full, the battery indicator light turns off. This process takes approximately one and a half hours for the PCG-FX101 and PCG-FX103, and approximately three hours for the PCG-FX105K/PCG-FX108K and PCG-FX109K. To charge the battery completely, continue charging for an additional hour.

There are two battery indicator lights on the computer:

- 1  Indicates the status of the battery pack in the battery bay on the left side of the computer.
- 2  Indicates the status of the battery pack in the multipurpose bay on the right side of the computer.

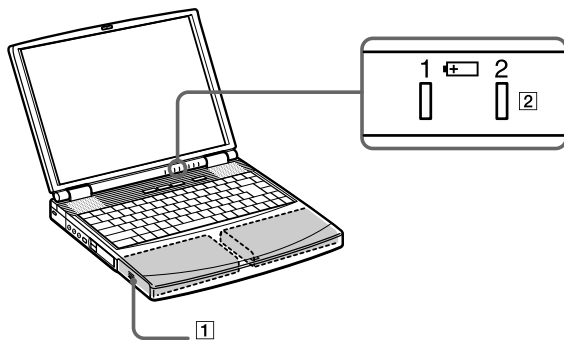

<i>battery indicator light status</i>	<i>meaning</i>
---------------------------------------	----------------

<i>battery indicator light status</i>	<i>meaning</i>
on	The computer is using battery power.
single blink	The battery is running out of power.
double blink	The battery is charging.
off	The computer is using AC power.

 When the battery is running out of power, both the battery and power indicators blink.

Keep the battery pack in the computer while it is directly connected to AC power. The battery pack continues to charge while you are using the computer.

If the battery level falls to below 10%, you should either attach the AC adapter to recharge the battery or shut down your computer and insert a fully charged battery.

You can extend battery life by changing the power management modes in the PowerPanel utility.

The battery pack supplied with your computer is a lithium ion battery and can be recharged any time. Charging a partially discharged battery does not affect battery life.

The battery indicator light is on while you use the battery pack as a power source. When the battery life is nearly depleted, the battery indicator starts flashing.

For some software applications and some peripheral devices, your computer may not enter **Hibernate** mode when battery life is low. To avoid loss of data when using battery power, you should save your data frequently and manually activate a power management mode, such as **Standby** or **Hibernate**.

When the computer is directly connected to AC power and has a battery pack inserted in the battery bay, it uses power from the AC outlet.

Removing the battery pack

To remove the battery pack, proceed as follows:

- 1 Turn off the computer.
- 2 Open the cover of the battery bay.
- 3 Pull out the battery pack.

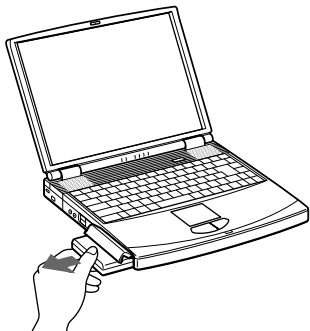

- 4 Close the cover of the battery bay.

 You may lose data if you remove the battery pack while the computer is on and not connected to the AC adapter or if you remove the battery while the computer is in **Standby** mode.

Using the second battery pack

You can purchase a second rechargeable battery pack. With two battery packs, you can extend the time you use your computer with battery power. When using two battery packs, the battery pack you insert first charges first. The battery pack you insert second charges when the first battery pack is 85 percent full. You can monitor which battery pack is charging by observing the battery indicator lights.

Inserting the second battery pack

To insert a second battery pack, proceed as follows:

- 1 If the floppy disk drive is in the multi-purpose bay (1), remove the device.
- 2 Insert the battery pack (2) into the multi-purpose bay.
The battery 2 indicator light turns on.

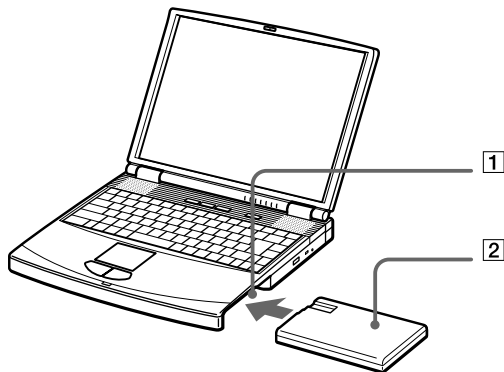

- 3 Attach the weight saver (3) to the computer to stabilize the battery pack.
- 4 Slide the eject lever on the bottom of the weight saver toward the front of the computer to lock it.

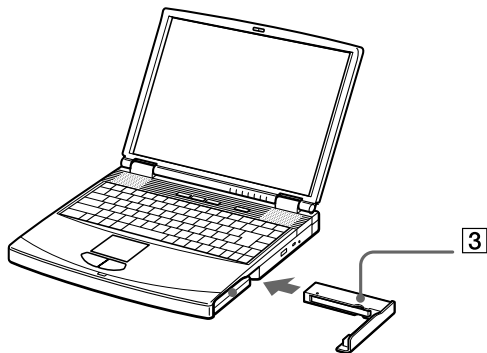

-  If you attach two battery packs, you can remove one of them without shutting down the computer. When removing one battery pack, make sure that the other battery pack indicator is on. If the indicator of the battery pack you are going to remove is on, right click the battery icon on the taskbar and click the switch discharge battery menu.

Charging the second battery pack

To charge the second battery pack, proceed as follows:

- 1 Keep the battery pack (1-3) in the computer while it is connected to AC power. The battery indicator (2) flashes while the battery is charging.
- 2 When the battery indicator stops flashing, the battery is fully charged.

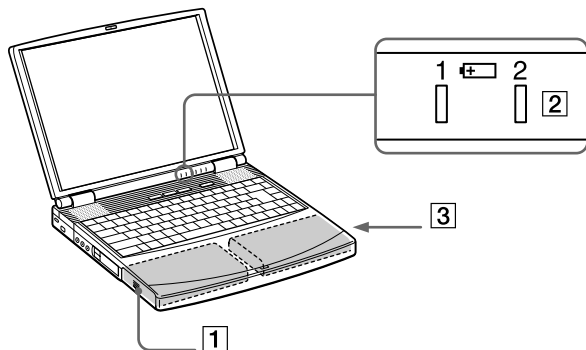

Removing the second battery pack

To remove the second battery pack, proceed as follows:

- 1 Slide the **eject lever** on the bottom of the weight saver, in the direction of arrow 1.
- 2 Slide the **release lever** on the bottom of the computer in the direction of arrow 2.

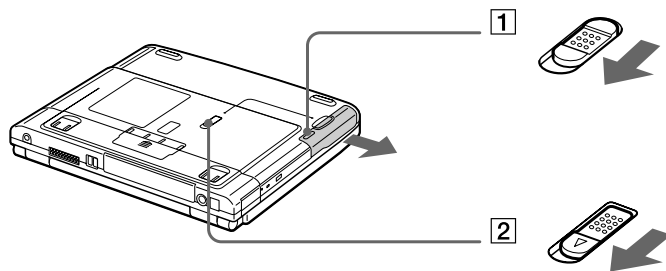

- 3 Remove the weight saver.
- 4 Pull out the battery pack
- 5 Reinsert the weight saver.

Starting your notebook

To start your computer, proceed as follows:

- 1 Slide the LCD lock lever (1) in the direction of the arrow, and lift the cover.

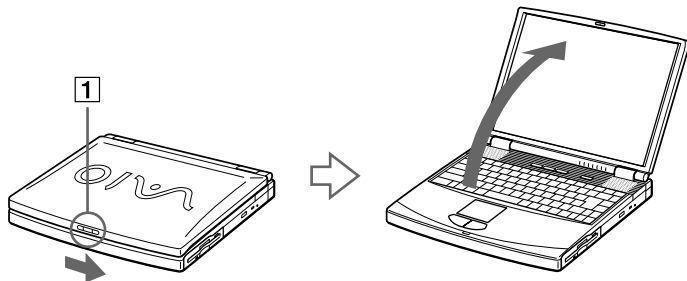

- 2 Press the power button (2) of the computer until the green power indicator (3) light turns on.

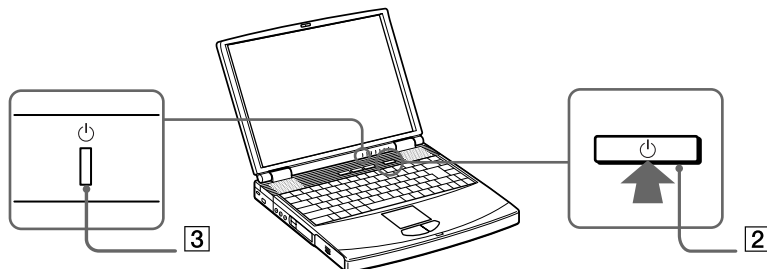

- 3 If necessary, press **<Fn>+<F5>*** to adjust the brightness controls for the LCD display. To increase the brightness, use the up or right arrow keys. To decrease, use the down or left arrow keys.
* **<Fn> + <F5>** is only possible once you are in Windows.

 If you press the power button for more than four seconds, the computer will turn off.

Shutting down your notebook

It is important that you shut down your computer properly in order not to lose unsaved data.

To shut down your computer, proceed as follows:

- 1 Click the **Start** button on the Windows® taskbar.
- 2 Click **Shut Down**.
The **Shut Down Windows** dialog box appears.
- 3 Select **Shut down**.
- 4 Click **OK**.
- 5 Wait for your computer to turn off automatically.
The power indicator turns off.
- 6 Turn off any peripheral connected to your computer.

 Respond to any prompts warning you to save documents.

If you are unable to shut down your computer:

- Close all software in use.
- Remove the PC Cards if inserted. To do so, double-click the **Unplug or Eject Hardware** icon in the taskbar. Select the hardware you want to unplug and click **Stop**.
- Disconnect any USB devices.
- Then press the <Ctrl>+<Alt>+<Delete> keys at the same time to restart the computer.

If this does not work, you can press the power button for more than four seconds. This will shut down the computer. This operation may result in data loss.

During a period of inactivity, you can conserve battery life by using **Standby** mode.

Registering your notebook

You can take advantage of Sony's commitment to quality customer support and receive the following benefits by registering your computer:

- ❑ **VAIO-Link** – If you are experiencing any problems with your computer, you can check the VAIO-Link web site for a possible solution:
<http://www.vaio-link.com>
- ❑ **Guarantee** – Protect your investment. See the Guarantee sheet for the terms and conditions and refer to your Customer Service Guide for more information.

To register your Sony Notebook, proceed as follows:

- 1 Click on the **Welcome** button on your desktop,
- 2 Click **Next**,
- 3 Click **Internet**,
- 4 Fill in your Registration card fields,
- 5 Scroll down to the bottom of the form and click **Send**,
- 6 Click **OK**.

 You must connect your phone line before using any online services, including the online registration service.

To access the online Registration web page, you must have a connection to the Internet.

Using the keyboard

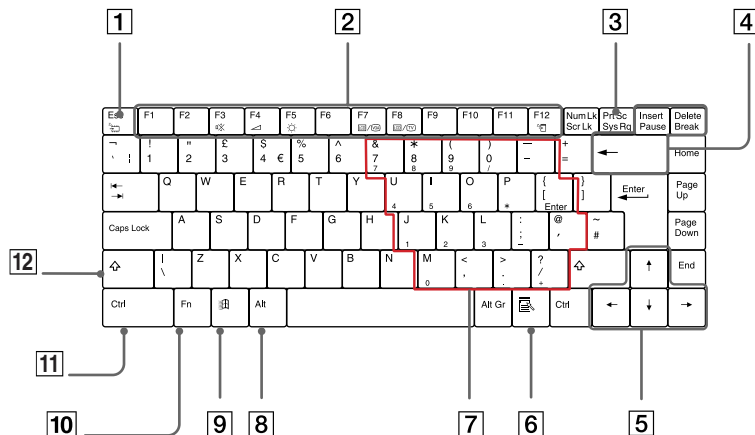

Your keyboard is very similar to a desktop computer's, but the keyboard has additional keys that perform specific notebook-related tasks.











Keys

Descriptions



Escape key (1)	The <Esc> (Escape) key is used to cancel commands.
Function keys (2)	The twelve function keys along the top of the keyboard are used to perform designated tasks. For example, in many applications, <F1> is the Help key. The task associated with each function key may vary from one application to the other.
Print Screen key (3)	The <Print Screen> key takes an electronic snapshot of the screen and moves it to the Windows Clipboard. You can then paste the screenshot into a document and print it.
Correction keys (4)	The <Insert> , <Back Space> and <Delete> keys enable you to make corrections.





<i>Keys</i>	<i>Descriptions</i>
Navigation keys (5)	These keys enable you to move the cursor on the screen.
Application key (6) 	The Application key displays a shortcut menu; pressing this key is equivalent to clicking the right mouse button.
Numeric keypad area (7)	Contains the keys found on a typical calculator. Use the numeric keypad area to type numbers or to perform mathematical calculations such as addition and subtraction. Note that you must press the <Num Lock> key to activate the numeric keypad. When you do so, the Num Lock light illuminates.
Operator keys (8-11-12)	Several keys are always used with at least one other key: <Ctrl> , <Alt> , and <Shift> . When held down with another key, the <Ctrl> (Control) and <Alt> (Alternate) keys offer another way to execute commands. For example, in many applications, instead of choosing the Save command from a menu, you can hold down <Ctrl> and press S (referred to as Ctrl+S). The <Shift> key is used to produce capital letters or special symbols such as @ and \$.
Windows® key (9) 	The key with the Windows® logo displays the Windows® Start menu; it is equivalent to clicking the Start button on the taskbar.
Fn key (10)	The <Fn> key is used in combination with other keys to execute commands.

Combinations and functions with the Windows key

















<i>Combinations</i>	<i>Functions</i>
 + F1	Displays Windows Help .
 + Tab	Switches the selected button on the taskbar.
 + E	Displays Windows Explorer .
 + F	Displays the Search Results window to find a file or folder. This is equivalent to selecting Search and then For files or Folders from the Start menu.
 + Ctrl + F	Displays the Search Results - Computers window where you can locate other computers.
 + M	Minimizes all displayed windows.
Shift +  + M	Returns all minimized windows to their previous size.
 + R	Displays the Run window. This is equivalent to selecting Run from the Start menu.
Fn +  + Insert	Displays the System Properties window. This is equivalent to double-clicking the System icon in the Control Panel .

Indicators

Indicator	Functions
Power 	Power on: lights green. Standby mode: flashes amber.
Battery 1 	Indicates the status of the battery inserted in the battery bay on the left side of the computer.
Battery 2 	Indicates the status of the battery inserted in the battery bay on the right side of the computer.

Light	On	Off
 Hard Disk	Data is read from or written to the hard drive. Do not enter Standby mode or turn off the computer when this indicator light is on.	The hard drive is not being accessed.
 Num Lock	Turns on when the number keys in the numeric keypad are active.	Turns off when the alphanumeric character keys in the keypad area are active.
 Caps Lock	Turns on when the letters appear in uppercase as you type. The <Shift> key lowers the case of typed letters when Caps Lock is on.	Turns off when the letters appear in lowercase as you type (unless you hold down the <Shift> key).
 Scroll Lock	Turns on when the screen scrolls differently (depends on the application, no effect in many applications.)	Turns off when the information moves across the display normally.

Combinations and functions with the Fn key

Combinations/ Feature	Functions
Fn+  (ESC): Standby	Puts the system into Standby mode, a power management state. To return the system to the active state, press any key.
Fn+  (F3): speaker switch	Toggles the built-in speaker on and off.
Fn +  (F4): speaker volume	Adjusts the built-in speaker volume. To increase volume, press <Fn>+<F4> and then  or  To decrease volume, press <Fn>+<F4> and then  or 
Fn +  (F5): brightness control	Adjusts the brightness of the LCD. To increase light intensity, press <Fn>+<F5> and then  or  To decrease light intensity, press <Fn>+<F5> and then  or 
Fn+  /  (F7)*: switch to the external display	Toggles between the LCD, external display (connected to the monitor connector) and both LCD and external display.
Fn +  /  (F8)*	Toggles between the LCD and both LCD and TV. (only for models with TV Out connector: PCG-FX105K/PCG-FX108K/PCG-FX109K)
Fn+  (F12): Hibernate	Provides for the lowest level of power consumption. When you execute this command, the states of the system and of the peripheral devices are written to the hard disk and the system power is turned off. To return the system to its original state, use the power switch to turn on the power.
Fn + D: Video Standby (Windows Millennium Edition only)	Darkens the LCD in order to save power. To turn the LCD back on, press any key.

 * First you need to connect your external display, then you turn on your notebook. When you connect your external display when the computer is already on, you cannot use the keycombination <Fn> + <F7> or <Fn> + <F8>.

Some functions are not available until Windows is launched.

Using the touchpad

The keyboard contains a cursor-pointing device, your touchpad (1). You can point to, select, drag, and scroll objects on the screen using the built-in touchpad.

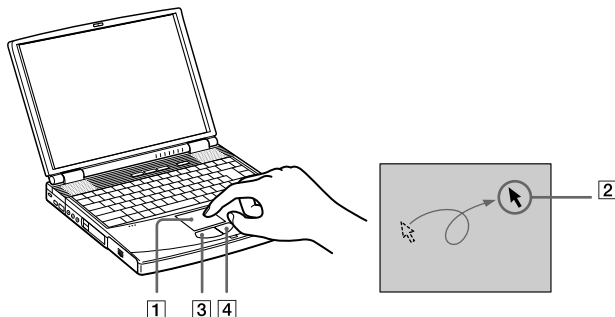

Action	Description
point	Slide one finger on the touchpad to place the pointer (2) on an item or object.
click	Press the left button (3) once.
double-click	Press the left button twice.
right-click	Press the right button (4) once. In many applications, this action displays a shortcut menu.
drag	Slide one finger while pressing the left button.
scroll	Move your finger along the right edge of the touchpad to scroll vertically. Move your finger along the bottom to scroll horizontally. (The scroll function is available only with applications that support a touchpad scroll feature.)

Using the optical disk drive

Your computer is equipped with an optical disk drive*.

* PCG-FX101: CD-ROM drive

PCG-FX103/PCG-FX105K/PCG-FX108K: DVD-ROM drive

PCG-FX109K: CD-RW/DVD-ROM drive

To insert a disk, proceed as follows:

- 1 Turn on the computer.
- 2 Press the Eject button (1) to open the optical disk drive.
The tray slides out.

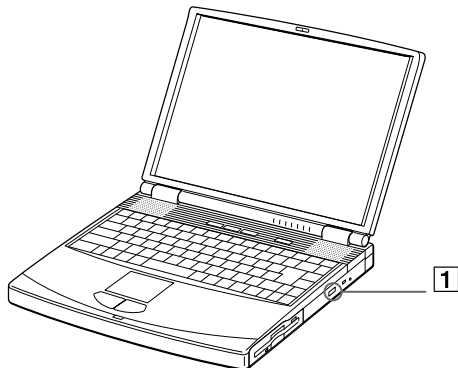

- 3 Place a CD-ROM/DVD-ROM disk in the middle of the tray with the label side facing up until the disk clicks into place.

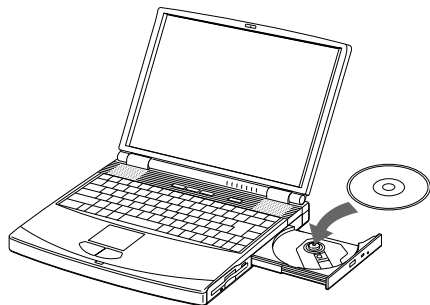

- 4 Close the tray by pushing it gently.



When the computer is in **Standby** or **Hibernate** mode, you cannot insert or remove a disk.

Be sure to seat the disk firmly over the disk drive hub fingers. If you do not seat the disk firmly, you could damage your disk drive and you may not be able to open the tray.

When you finish using a disk, wait until the LED indicator turns off and then press the Eject button to remove the disk.

If the disk does not come out when you press the Eject button, go to **Windows Explorer**. Select the drive, click the right button of your mouse and select **Eject**. If it still doesn't work, turn off the computer and insert a thin, pointed object into the manual eject hole.

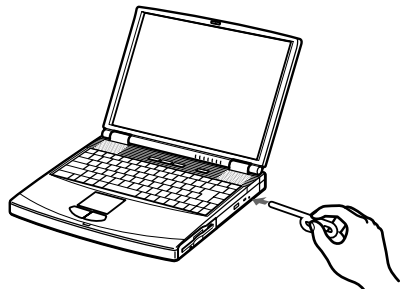

To achieve optimum performance when playing **DVD-ROM** disks, you should use the following recommendations.

- ❑ You can play DVDs using a DVD-ROM drive and the WinDVD software. See the help file in the WinDVD software for details.
- ❑ Your computer should not be connected to the port replicator while playing DVD movies or using DVD applications.
- ❑ Close any open application before playing a DVD-ROM movie.
- ❑ When playing DVD movies on battery power, set the power management profile to DVD. With other profiles, the movies can be choppy.
- ❑ Do not switch the power saving modes while playing DVD video.
- ❑ If the virus checker is active, you need to disable it.
- ❑ Do not use resident disk utilities and resident utilities to speed up access of disks, because they may cause unstable operation.
- ❑ Make sure that the screensaver is deactivated.
- ❑ Region codes indicators are labeled on the DVD disks to indicate in which region and what type of player can play the disk. Unless a '2' or 'all' is labeled on your DVD disk or on the packaging, you cannot play the disk on this player.
- ❑ Do not try to change the region code settings of the DVD-ROM drive. Any troubles caused by changing the region code settings of the DVD-ROM drive are out of warranty.
- ❑ When a DVD video disk is inserted in the DVD-ROM drive, you cannot toggle between LCD and TV by pressing **<Fn> + <F8>***.
- ❑ When a TV* is connected, a part of the video screen will not appear with the factory settings. Adjust the display resolution to 640x480.

* Only on PCG-FX105K/PCG-FX108K/PCG-FX109K.

Using the CD-RW function

Your computer is equipped with a CD-RW/DVD-ROM drive*.

To burn CDs, you can use CD-RW and CD-R disks:

- ❑ The **CD-RW** (CD-ReWritable) disk is a data memory medium that can be used to write, erase and rewrite a program or other data.
- ❑ The **CD-R** (CD-Recordable) is a data memory medium that can be used to write a program or other data, but then only once.

* Only on PCG-FX109K.

To achieve optimum performance when writing data on a CD-RW/CD-R, you should use the following recommendations.

- ❑ Before writing to a new CD-RW or CD-R with DirectCD™, you must first format the disk. If you do not format the disk, your computer will not recognize it.
- ❑ To make a CD-R to which data has been written readable on a CD-ROM drive, you need to close the session when you eject it. To complete this process, follow the instructions included with your software.
- ❑ Always use the AC adapter as the power source for your computer when you are writing data to a CD-RW or CD-R. Using battery power may result in data transfer failure.
- ❑ Only use circular disks. Do not use disks with any other shape (star, heart, card, etc.), as this may damage the CD-RW drive.
- ❑ Do not strike or shake the notebook while writing data to a disk.
- ❑ For optimal writing speed, deactivate the screensaver before writing data to a disk.
- ❑ Memory-resident disk utilities may cause unstable operation or data loss. Deactivate these utilities before writing data to a disk.

- ❑ For best results, use CD-Rs that are compatible with 4x speed, as DirectCD™ and Easy CD Creator™ are preset to that speed. Your notebook does not support 1x writing speed. If you use CD-RW or CD-R writing software other than DirectCD™, use PowerPanel to select the DVD Profile.
- ❑ When using a software to burn CDs, be sure to exit and close all other applications.
- ❑ Exit anti-virus software before writing data to a disk.
- ❑ Never touch the surface of the disk. Fingerprints and dust on the surface of a disk may cause writing errors.
- ❑ Do not put your notebook into power saving mode while using DirectCD™ to write data or while using Easy CD Creator™.
- ❑ If you set the display resolution higher than the default, DVD video may not be played properly.
- ❑ When playing your DVD, it is possible that your DVD is not displayed properly. Change the resolution display to 1024x768 dots (16 bits)*.

* Only on PCG-FX109K

Using the weight saver

The weight saver protects the multipurpose bay when it is empty.

To attach the weight saver, proceed as follows:

- 1 If another device is in the multi-purpose bay, remove the device.
- 2 Pull out the guide (1) of the weight saver and slide the weight saver in the direction of the arrow (2) until it clicks.

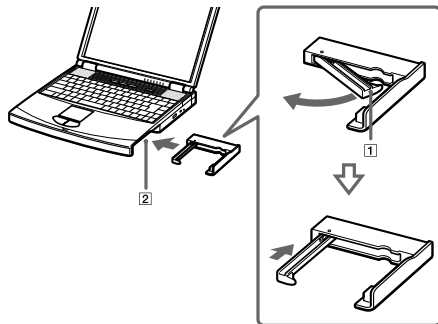

To remove the weight saver, proceed as follows:

- 1 Slide the eject lever of the weight saver in the direction of arrow 1.
- 2 Slide the release lever on the bottom of the computer in the direction of arrow 2.

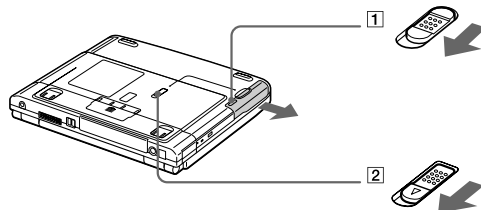

Using the floppy disk drive

The computer is equipped with an internal removable floppy disk drive*.

* Except on PCG-FX101.

Inserting the floppy disk drive

Inserting a diskette

To insert a diskette, proceed as follows:

- 1 Hold the diskette (1) with the label side facing up.
- 2 Gently push the diskette into the floppy disk drive (2) until it clicks into place.

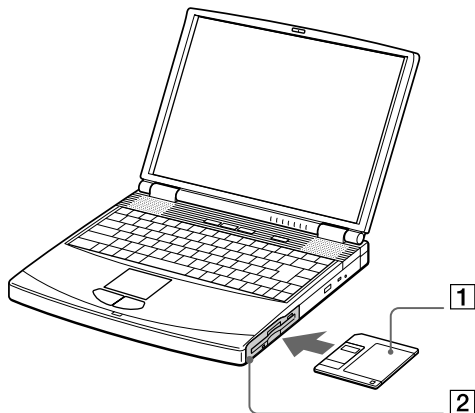

Removing a diskette

To remove a diskette, proceed as follows:

- 1 Wait until the LED indicator (1) turns off.
- 2 Press the eject button (2) to remove the diskette.

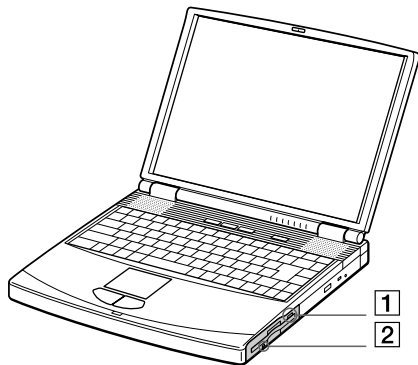

 Do not press the Eject button when the LED indicator is turned on. Otherwise, data may be lost.

Removing the floppy disk drive

To remove the floppy disk drive, proceed as follows:

- 1 Turn off the computer.
- 2 Slide the release lever (1) on the bottom of the computer in the direction of the arrow.

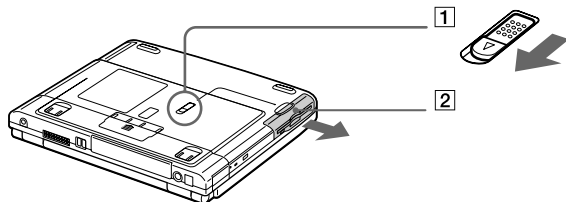

- 3 Slide the drive (2) out of the multi-purpose bay.
- 4 Insert the weight saver.

Re-inserting the floppy disk drive

To re-insert the floppy disk drive, proceed as follows:

- 1 Turn off the computer.
- 2 If another device is in the multipurpose bay (1), remove the device.
- 3 Insert the floppy disk drive (2) into the multi-purpose bay with the metallic part up.
- 4 Continue pushing the drive into the bay until the release lever locks into place.

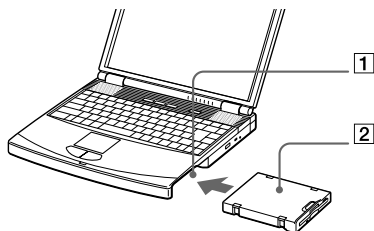

Using PC Cards

Your computer includes two PC Card slots (1-2). PC Cards allow you to connect portable external devices.

Inserting a PC Card

To insert a PC Card, proceed as follows:

- 1 Push the Release button.
The Release button pops out.
- 2 Push the Release button.
The PC Card slot comes out.

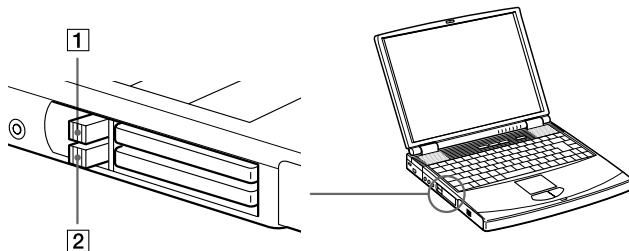

- 3 Insert the PC Card into the PC Card slot front label facing up.

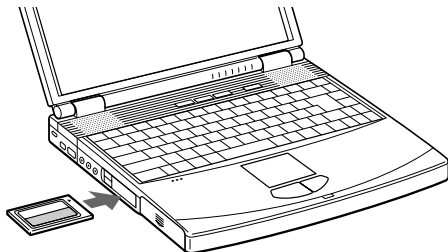

- 4 Gently push the PC Card slot into the connector.
The PC Card is automatically detected by your system.
The **Unplug or Eject Hardware** icon appears in the taskbar.



Some devices may not function properly if you repeat **Returning to Normal mode** from **Standby** mode or **Hibernate** mode.

The computer will return to its original state if you restart it.

The PC Card slots can accommodate (at the same time) two Type I, two Type II or one Type III PC Card. These slots are compatible with Card Bus port.

Use the lower slot for PC Type III cards.

Some PC Cards may require you to disable idle devices when using the PC Card. You can use Sony Notebook Setup to disable devices.

Be sure to use the most recent software driver provided by the PC Card manufacturer.

If an "!" mark appears on the **Device Manager** tab in the **System Properties** dialog box, remove the software driver and then reinstall it.

You do not need to shut down the computer before inserting or removing a PC Card.

Do not force a PC Card into the slot. It may damage the connector pins. If you have difficulty inserting a PC Card, check that you are inserting the PC Card in the correct direction. See the manual supplied with your PC Card for more information on use.

For some PC Cards, if you alternate between **Normal** power operation and **Standby** or **Hibernate** power management modes while the card is inserted, you may find that a device connected to your system is not recognized. Reboot your system to correct the problem.

Removing a PC Card

Follow the steps below to remove the PC card while your computer is on. If it is not removed properly, your system may not work properly. When your computer is off, skip steps 1 to 7.

To remove a PC Card, proceed as follows:

- 1 Double-click the **Unplug or Eject Hardware** icon in the taskbar. The dialog box **Unplug or Eject hardware** appears.
- 2 Select the hardware you want to unplug.
- 3 Click **Stop**.
- 4 In the **Stop a Hardware device** dialog box, confirm that the device can be safely removed from the system.
- 5 Click **OK**. You get the message that it is safe to remove the device.
- 6 Click **OK**.
- 7 Click **Close**.
- 8 Press the PC Card release button so that it pops out.
- 9 Push the PC Card release button to eject the card.
- 10 Gently grasp the card and pull it out.
- 11 If the PC Card release button is still out, push the PC Card release button in the notebook.

 If you unplug the PC Card from the computer when this is still turned on, your system might crash and you might lose data that you did not save before. Before you remove the PC Card, click the PC Card icon in the taskbar and close the card. Close any applications that use the PC Card before removing the card. Otherwise, data may be lost.

While the card is inserted, your computer may not enter the Hibernate power management mode. It may enter **Standby** mode. It is recommended to remove the card when your computer enters Hibernate mode by pressing **<Fn> + <F12>** keys or by using the PowerPanel Utility, and when it is set to enter Hibernate automatically while using a battery as the source of power.

You may not be able to use some PC Cards or some functions within the PC Card with this computer.

Using Memory Stick

This new compact, portable, and versatile recording medium has a data capacity exceeding that of a floppy disk. The Memory Stick™ is specially designed for exchanging and sharing digital data with compatible products. Because it is removable, it can be used for external data storage.

 You need an optional PC Card adapter to use this function.

When the Memory Stick™ erasure prevention switch is set to LOCK, data cannot be recorded or erased.

You can enjoy still images that you have recorded with a Memory Stick compatible video camera recorder or a digital still camera.

Before using Memory Sticks™, you should back up important data.

To avoid damaging data:

- Do not remove a Memory Stick™ or turn off the power while the access light is on.
- Do not use Memory Sticks™ in locations that are subject to static electricity or electrical noise.
- Do not touch the Memory Stick™ connector with your finger or metallic objects.
- Do not attach labels other than the supplied label to a Memory Stick™.
- Do not bend, drop, or apply strong shock to Memory Sticks™.
- Do not disassemble or modify Memory Sticks™.
- Do not allow Memory Sticks™ to get wet.
- Do not use or store Memory Sticks™ in a location that is subject to:
 - Extremely high temperatures, such as in a car parked in the sun
 - Direct sunlight

To prolong the life of Memory Sticks™, use the supplied storage case.

Inserting a Memory Stick

To insert a Memory Stick™, proceed as follows:

- 1 Once you have stored your data from your digital device, insert the Memory Stick™ (1) into the optional PC Card adapter (2).
- 2 Push the Release button.
The Release button pops out.
- 3 Push the Release button.
The PC Card slot comes out.
- 4 Pull the PC Card slot out of the connector.
- 5 Insert the PC Card adapter into the connector (3) on your computer (label facing up) and push it gently.
- 6 The Memory Stick™ is automatically detected by your system and appears in your **My Computer** window as a local drive, under the appropriate letter (depending on the configuration of your computer).

When your Memory Stick™ is detected, the **Unplug or Eject Hardware** icon appears in the taskbar.

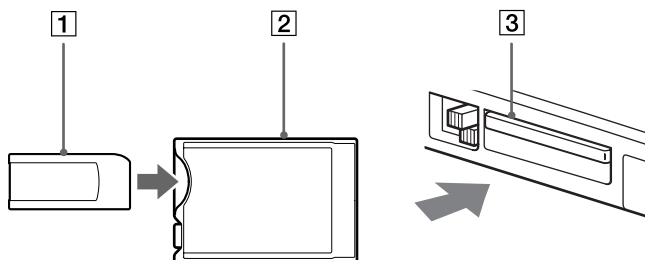

- ! Hold the Memory Stick™ with the arrow pointing in the correct direction when you insert it into the slot. To avoid damaging the computer or the Memory Stick™, do not force the Memory Stick™ into the slot if it does not insert smoothly.

Removing a Memory Stick

To remove a Memory Stick™, proceed as follows:

- 1 Double-click the **Unplug or Eject Hardware** icon in the taskbar. The dialog box **Unplug or Eject hardware** appears.
- 2 Select the hardware you want to unplug.
- 3 Click **Stop**.
- 4 In the **Stop a Hardware device** dialog box, confirm that the device can be safely removed from the system.
- 5 Click **OK**.
You get the message that it is safe to remove the device.
- 6 Click **OK**.
- 7 Click **Close**.
- 8 Press the PC Card release button so that it pops out.
- 9 Push the PC Card release button to eject the card.
- 10 Gently grasp the card and pull it out.

 Always remove the Memory Stick™ gently, or it may pop out unexpectedly.

It is recommended to remove the Memory Stick™ before shutting down the computer.

Using the modem

Your notebook is equipped with an internal modem.

You need to connect a phone line to take advantage of online services and the Internet, to register your computer and software online, and to contact VAIO-Link.

To connect a phone line, proceed as follows:

- 1 Plug one end of the phone cable (1) into the phone line jack on the computer.
- 2 Plug the other end into the wall jack (2).

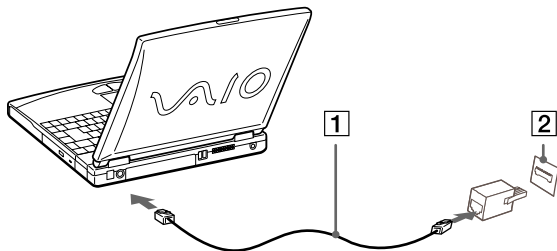

A country-specific phone plug is supplied with your VAIO notebook, allowing you to plug the phone line into the wall jack. We recommend you to use the supplied plug, because the usage of any other phone plug can decrease the connection quality.

Your computer cannot be connected to a coin-operated telephone, and may not work with multiple phone lines or a private branch exchange (PBX). If you connect the modem to a parallel connected phone line, the modem or the other connected device may not function properly. Some of these connections may result in excess electrical current and could cause a malfunction in the internal modem.

Phone cable and connectors are TNV (Telecommunications Network Voltage), according to EN60950.

Only DTMP (Dual Tone Multi Frequency) signalling (tone dialling) is supported.

Using programmable power keys (PPK)

Press a programmable power key* to start your favorite software without having to click the shortcuts on the desktop.

* Except on PCG-FX101

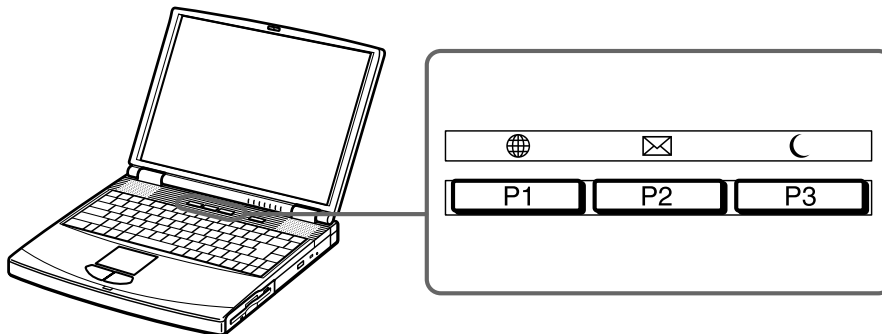

Use a programmable power key by simply pressing it, or use it in combination with 3 keys on your keyboard: **<Shift>**, **<Ctrl>** or **<Alt>**.

When your computer is off, press a PPK, and the system will be powered and launch the appropriate application.

The factory settings for the buttons are:

- P1**: opens the Club VAIO Website
- P2**: opens your e-mail application (Outlook Express)
- P3**: puts your machine in Standby mode (Sleep)

The factory settings for the PPK buttons in combination with other keys are:

- P1 + <Alt>**: opens the VAIO-Link Website

- ❑ **P1 + <Shift>**: opens the VAIO Website
- ❑ **P1 + <Ctrl>**: opens Sony Style Website
- ❑ **P3 + <Ctrl>**: opens the End-User License Agreement

Using power saving modes

When you use a battery as the source of power for your computer, you can take advantage of power management settings to conserve battery life. In addition to the normal operating mode, which allows you to turn off specific devices, your computer has two distinct power saving modes: **Standby** and **Hibernate**. When using battery power, you should be aware that the computer automatically enters **Hibernate** mode when the remaining battery charge drops below 7 percent, regardless of the power management setting you select.

 If the battery level falls to below 10 percent, you should either attach the AC adapter to recharge the battery or shut down your computer and insert a fully charged battery.

Using Normal mode

This is the normal state of your computer when it is in use. The green power indicator light is on in this mode. To save power, you can turn off a specific device such as the LCD or the hard disk.

Using Standby mode

The computer saves the current state of the system in RAM and switches off power to the CPU. The amber power light flashes in this mode.

To activate Standby mode, proceed as follows:

Press **<Fn>+<Esc>**

Or,

Press the power button.

You can also use the PowerPanel utility to enter **Standby** mode.

To return to Normal mode, proceed as follows:

Press any key.

 If you press the power button for more than four seconds, the computer will switch off automatically.

When the computer is in Standby mode, you cannot insert a disk.

Standby requires less time than Hibernate.

Standby uses more power than Hibernate.

Using Hibernate mode

The state of the system is saved on the hard disk and power is turned off. The power indicator light is off in this mode.

To activate Hibernate mode, proceed as follows:

Press **<Fn>+<F12>**.

Or,

Use the PowerPanel utility.

To return to Normal mode, proceed as follows:

Turn on the computer by pressing the power button. The computer returns to its previous state.

 When the computer is in Hibernate mode, you cannot insert a disk.

Hibernate mode requires more time than Standby mode.

Hibernate mode uses less power than Standby mode.

Connecting peripheral devices

You can add functionality to your computer by connecting or using any of these peripherals.

Before you connect peripherals, turn off the computer and all peripherals.

Connect the power cord only after connecting all cables.

Turn on the computer only after turning on all peripherals.

- ❑ Connecting a port replicator ([page 55](#))
- ❑ Connecting an external display ([page 59](#))
- ❑ Connecting external speakers ([page 64](#))
- ❑ Connecting an external microphone ([page 65](#))
- ❑ Connecting an external mouse or keyboard ([page 66](#))
- ❑ Connecting a Universal Serial Bus (USB) mouse ([page 67](#))
- ❑ Connecting a printer ([page 68](#))
- ❑ Connecting an i.LINK device ([page 70](#))
- ❑ Connecting a MiniDisc deck with MD player ([page 73](#))
- ❑ Connecting to a network (LAN) ([page 75](#))

Connecting a port replicator

Your notebook supports the use of an optional port replicator*. Attaching a port replicator enables you to connect additional peripherals to your computer, such as a printer or an external display.

* Except on PCG-FX101.

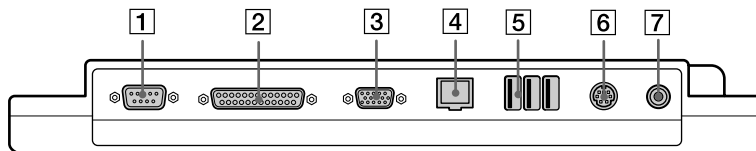

1	serial connector	(page 69)	5	3 USB ports	(page 67) (page 68)
2	parallel port	(page 69)	6	mouse/keyboard connector	(page 66)
3	monitor connector	(page 59)	7	DC In connector	(page 18)
4	network connector (ethernet)	(page 75)			

 All connectors are SELV (Safety Extra Low Voltage) according to EN60950.

The port replicator can be powered only with the AC adapter supplied with your notebook. Do not remove the AC adapter from the port replicator; this may cause data damage or hardware malfunctions.

Attaching your computer to the port replicator

To attach your computer to the port replicator, proceed as follows:

- 1 Turn off the computer and disconnect all peripherals.
- 2 On the bottom of the computer, lift the port replicator port cover.

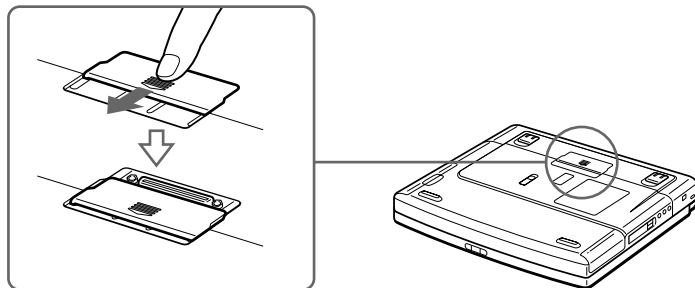

- 3 Attach the bottom of the computer to the port replicator connector until it clicks.

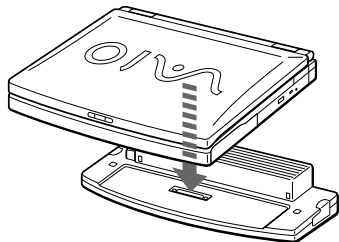

- 4 Plug the cable attached to the AC adapter (1) into the DC In (2) connector on the port replicator (3).
- 5 Plug the power cord (4) into the AC adapter and an AC outlet.

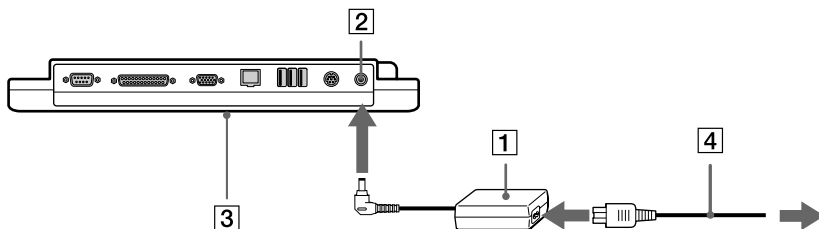

- 6 The power indicator light turns green.
- 7 Turn on the computer.



When you use the port replicator for the first time, the installation of the network drivers starts automatically.

When attaching your computer to the port replicator, do not attempt to insert or remove the battery pack. Lifting and turning the computer with the attached port replicator may cause a temporary loss of power.

You do not need to use the floppy disk supplied with your port replicator.

Disconnecting your computer from the port replicator

To disconnect your computer from the port replicator, proceed as follows:

- 1 Turn off the computer and the connected peripherals.
- 2 Pull the levers on each side of the port replicator (1) to disengage the computer from the port replicator.
- 3 Lift the computer away from the port replicator.
- 4 Close the port replicator connector cover on the bottom of your computer.

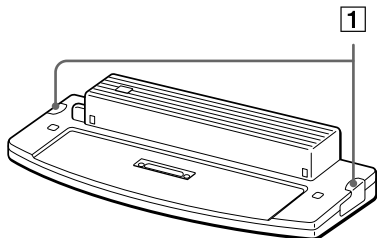

 It is extremely important to close the port replicator connector cover after removing your computer from the port replicator. If the cover is left open, dirt may get inside and damage the computer.

To disconnect your port replicator completely from the mains voltage, unplug the AC adapter.

Connecting an external display

You can connect an external display to your notebook. For example, you can use your computer with the following devices:

- Computer display (monitor);
- Multimedia computer display;
- TV*;
- Projector.

* Only on PCG-FX105K/PCG-FX108K and PCG-FX109K

 Turn off your computer and the peripherals, unplug the AC adapter and the power cord before connecting the external display.

Connect the power cord after connecting all other cables.

Turn on the peripherals, then turn on your computer.

Connected external displays are used as second screens.

On Windows® systems only, you can also use an external display to set up a virtual desktop.108

Connecting a computer display

To connect a computer display, proceed as follows:

- 1 Plug the display cable (1) in the monitor connector (2) on the computer.
- 2 If necessary, plug one end of the display's power cord (3) into the display, and the other end into an AC outlet.

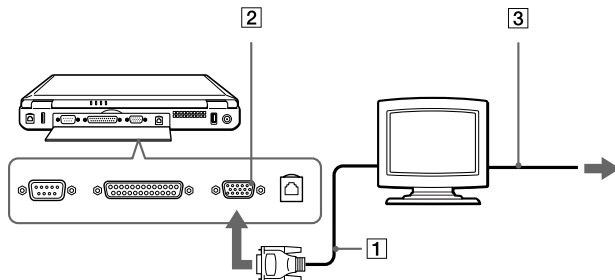

Connecting a multimedia computer display

You can connect the notebook to a multimedia computer display that includes built-in speakers and a microphone.

To connect a multimedia computer display, proceed as follows:

- 1 Plug the display cable (1) in the monitor connector (2) □ on the computer.
- 2 Plug the speaker cable (3) in the headphone connector (4) 🎧 on the computer.
- 3 Plug the microphone cable (5) in the microphone connector (6) 🎤 on the computer.

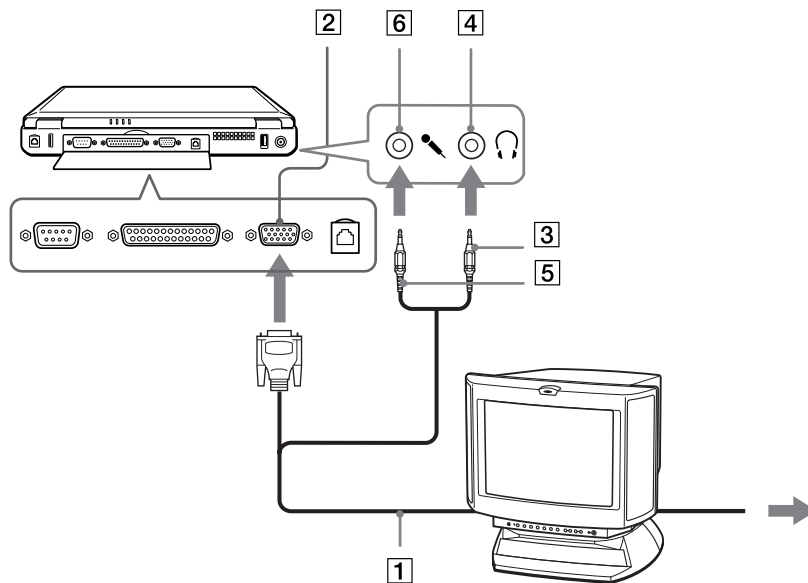

Connecting a TV

To connect a TV, proceed as follows:

- 1 Plug one end of the audio/video cable (1) into the TV Out connector (2) (yellow)* and the other end into the TV.
- 2 Plug one end of the sound cable (3) into the headphone connector (4) and the other end into the TV.
- 3 Plug the power cord of the TV (5) into an AC outlet.
- 4 Switch the input channel of the TV to external input.
- 5 Set up the TV configuration system.

* Only on PCG-FX105K/PCG-FX108K/PCG-FX109K.

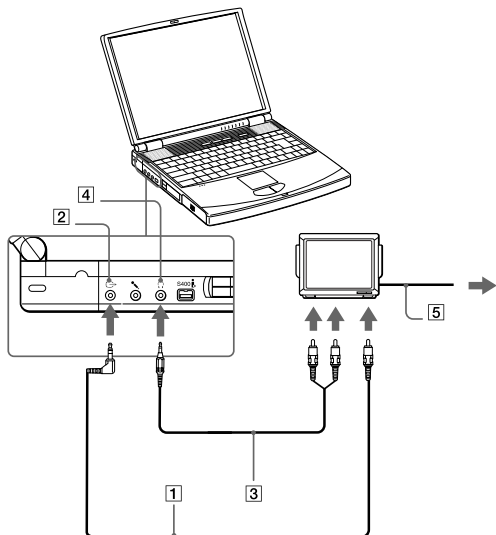



See the manual supplied with your peripheral for more information on installation and use.

If you insert a DVD in your DVD-ROM drive to watch a video on your TV, the **<Fn> + <F8>** key combination might not activate the function to toggle between your LCD and TV.

Solution:

1. Eject your DVD from your computer.
2. Once the DVD is ejected, toggle between your LCD and your TV with the combination **<Fn> + <F8>**.



Your image displays now on both LCD and TV. Re-insert your DVD to launch your DVD software.

If the display resolution of your computer is more than 800 x 600 dots, a part of the image cannot be displayed on your TV. The hidden area on your TV can be seen by moving the cursor on your computer. If you want to display the full image, change the display resolution of your computer to **640 x 480** dots.

Connecting a projector

You can use a projector as an external display, such as the Sony LCD Projector.

To connect a projector, proceed as follows:

- 1 Plug the RGB signal cable (1) into the monitor connector (2) identified by the  symbol.
- 2 Plug the audio cable (3) (not supplied) into the earphone connector (4) identified by the  symbol.
- 3 Plug the RGB signal cable and the audio cable into the connectors of the projector (5).
- 4 Connect the power cord (6) of the projector into an AC outlet.

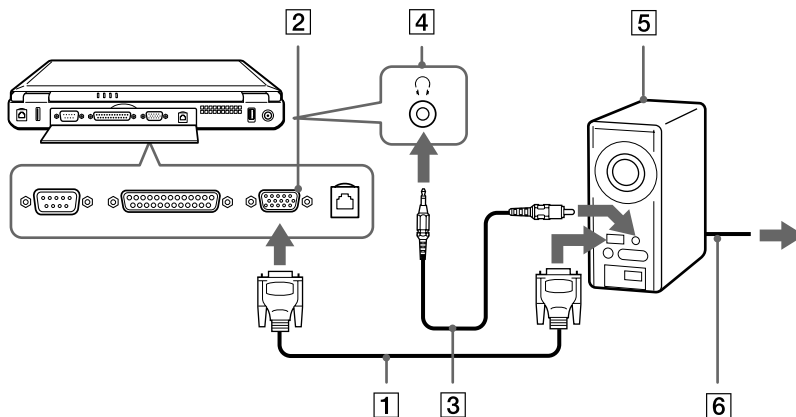

-  You may not be able to display the computer's LCD and the external display together, depending on the types of computer display and projector used. You can toggle the output between the notebook LCD-screen and the external monitor by pressing the key combination **<Fn> + <F7>**.

Connecting external speakers

You can enhance the sound quality of your computer by connecting external speakers.

To connect external speakers, proceed as follows:

- 1 Plug the speaker cable (1) into the earphone connector (2).
- 2 Plug the other end of the speaker cable into the external speaker.
- 3 Turn down the volume of the speakers before you turn them on.

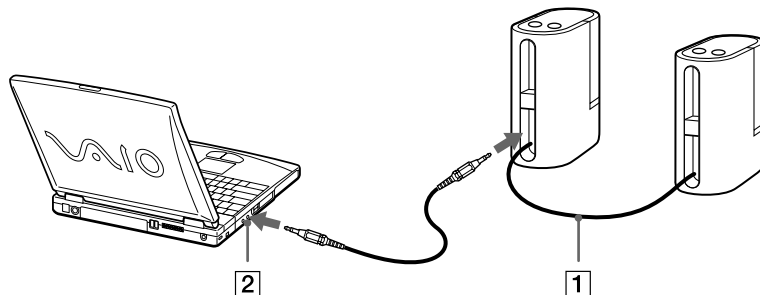

 Make sure your speakers are designed for computer use.

Do not place diskettes on the speakers; their magnetic field may damage the data on the diskettes.

Connecting an external microphone

Your VAIO notebook does not contain an internal microphone. If you need to use a sound input device, for example to chat on the Internet, you need to plug in an external microphone.

To connect an external microphone, proceed as follows:

- 1 Locate the microphone connector identified by the  symbol.
- 2 Plug the microphone cable (1) into the microphone connector (2).

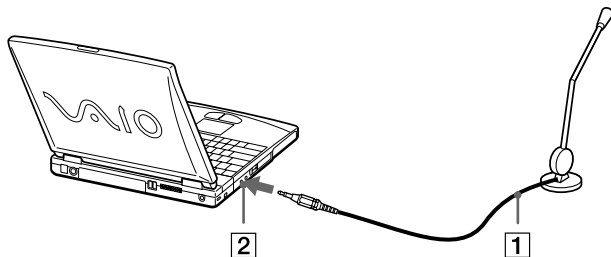

 Make sure your microphone is designed for computer use.

Connecting an external mouse or keyboard



You can connect an external mouse or keyboard to the optional port replicator*. You can only connect one external device at the same time. So, it is not possible to connect both a mouse and a keyboard, because an interface PS/2 keyboard and mouse is not supported.

Before you connect or disconnect the mouse or the keyboard, turn off the computer.

The mouse/keyboard connector requires a PS/2-style plug or adapter.

* PCG-FX101 cannot connect a port replicator.

To connect an external mouse or keyboard, proceed as follows:

- 1 Locate the mouse/keyboard connector (1) identified by the  /  symbol.
- 2 Plug the mouse cable (2) or the keyboard cable (3) into this connector with the  mark facing up.

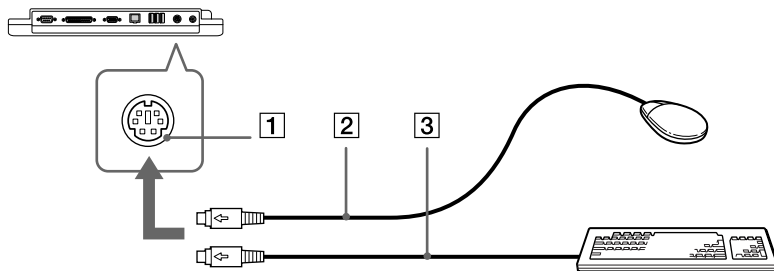

 See the manual supplied with your mouse or keyboard for more information on installation and use.

Connecting a Universal Serial Bus (USB) mouse

You can connect a USB device (e.g. mouse, floppy disk drive...) to your computer.

To connect a USB mouse, proceed as follows:

- 1 You can find 2 USB connectors (1) at the back of your notebook and 3 USB connectors at the back of the port replicator*.
- 2 Plug the USB mouse cable (2) into the USB connector.
- 3 You can use your USB mouse (3).

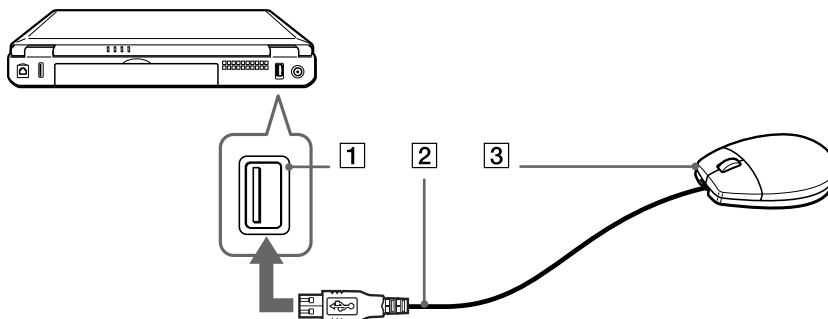

* PCG-FX101 cannot connect a port replicator.



You do not need to shut down the computer before connecting or disconnecting a USB peripheral.

The USB mouse software driver is preinstalled on your notebook, therefore, you only need to plug the USB mouse into the USB connector and you can start working.

You may need to install software (device drivers) supplied with your USB device before using the USB device.

Connecting a printer

You can connect a Windows-compatible printer to your computer to print documents.

Connecting a printer using the USB connector

You can connect a USB printer compatible with your version of Windows to your computer.

To connect a printer using the USB connector, proceed as follows:

- 1 Plug an optional USB printer cable (1) into the USB connector (2) identified by the  symbol on your computer and printer.
- 2 Plug the printer (3) power cord into an AC outlet.

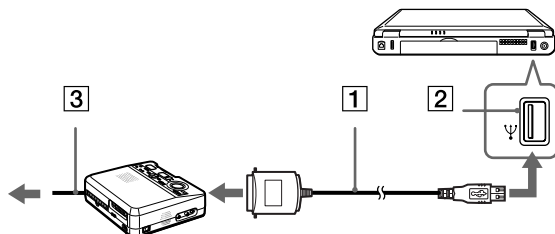



-  Before using the printer, you may need to change the Printer settings in the Sony Notebook Setup software.
Turn off your computer and the printer, unplug the AC adapter and the power cord before connecting the printer.

Connecting a printer using the printer connector

To connect a printer using the printer connector, proceed as follows:

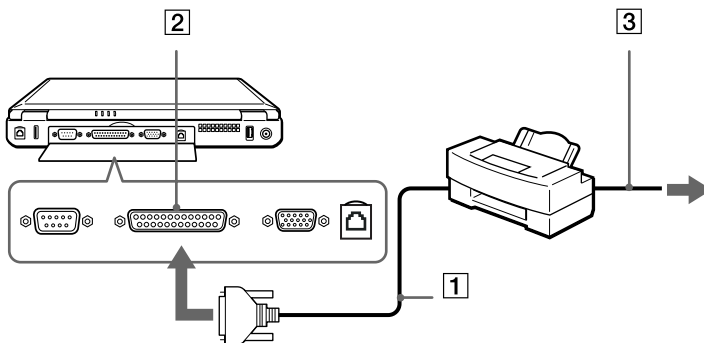
- 1 Plug the printer cable (1) supplied with the printer into the printer connector (2) identified by the  symbol.
- 2 Plug the printer power cord (3) into an AC outlet.



 Before using the printer, you may need to change the Printer settings in the Sony Notebook Setup software.

Connecting an i.LINK device

Your computer includes an i.LINK™ (IEEE1394) connector, which you can use to connect to an i.LINK™ device such as a digital video camera recorder or to connect two VAIO notebooks in order to copy, delete or edit files.

The i.LINK™ connector of your notebook does not supply power to external devices generally powered by i.LINK™ connectors.

The i.LINK™ connector supports transfer rates up to 400 Mbps; however, the actual transfer rate depends on the transfer rate of the external device.

The i.LINK™ features available may vary depending on the software applications you use. Refer to the documentation that came with your software for more information.

i.LINK™ cables compatible with your VAIO notebook include cables with the following part numbers: VMC-IL4415 (a 1.5 meter cable with a 4-pin connector at each end), VMC-IL4408Series (a 0.8 meter cable with a 4-pin connector at each end).

Connecting a digital video camera recorder

To connect a digital video camera recorder, proceed as follows:

- 1 Plug one end of the i.LINK™ cable (1) into the i.LINK™ connector (2) of the computer and the other end into the DV Out connector (3) on the digital video camera recorder.

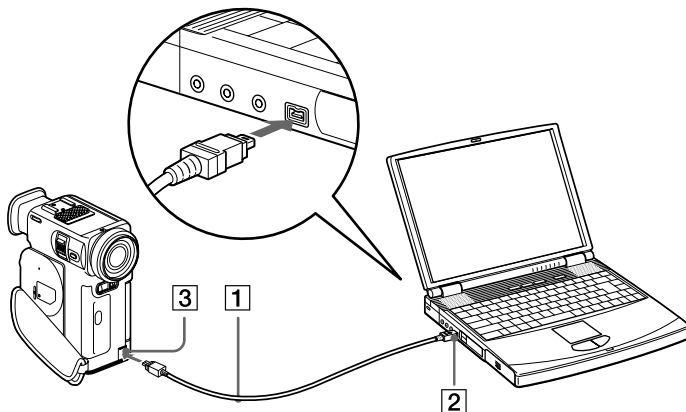

- 2 Launch the DVgate application.

 On Sony digital video cameras, connectors labeled **DV Out**, **DV In/Out** or **i.LINK™** are i.LINK™-compatible.

The Sony digital video camera recorder is an example; your digital video camera recorder may need to be connected differently.

If your digital video camera recorder includes a Memory Stick™ slot, you can copy images from it to your computer via a Memory Stick™. To do so, simply copy images on the Memory Stick™, then insert it into the Memory Stick™ slot of your computer.

Connecting two VAIO-notebooks

If you have **Windows® 2000** installed on your machine:

You can connect your notebook to another VAIO notebook using an i.LINK™ cable (1) (not supplied). With Smart Connect on your notebook, you can copy, edit or delete files on another VAIO notebook that is also equipped with Smart Connect.

You can also print a document on a printer connected to another VAIO computer.

If you have **Windows® Millennium Edition** installed on your machine:

You can connect your notebook to another VAIO notebook using an i.LINK™ cable (1) (not supplied). With Smart Connect* on your notebook, you can copy, edit or delete files on another VAIO notebook that has also Windows Millennium Edition installed or that has Smart Connect 3.0.

You can also print a document on a printer connected to another VAIO computer.

* You can find Smart Connect on your Applications Recovery CD-ROM.

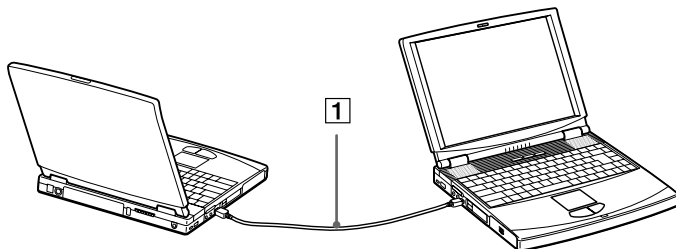

When you use Smart Connect to connect two VAIO computers, you must assign each computer a unique name by which it can be identified when the two computers are networked.

Connecting a MiniDisc deck with MD player

Use the interconnectivity and common protocols between your Sony MiniDisc deck, equipped with MD player software, and your VAIO notebook, equipped with Media Bar, to enjoy the high quality of sound and recordings.

You can connect a Sony MiniDisc deck to a Sony CD player using an optical cable and a CONTROL A1/CONTROL A1 II cable. Then connect the Sony MiniDisc deck to your notebook using a CONTROL A1 cable. This allows you to record and edit your MiniDiscs via your notebook.

You can now:

- ❑ Enjoy complete editing and assembly functions, like changing the order of the numbers on your MiniDisc.
- ❑ Use the touchpad or mouse to play and edit MiniDiscs, and the keyboard to enter disk and track titles to display on you MiniDisc deck while playing.
- ❑ Digital output and input without any noise or loss of data.
- ❑ Drag and drop, copy and paste: your notebook is the visual interface of the MiniDisc recorder.

To connect a MiniDisc deck to your notebook, proceed as follows:

- 1 Plug one end of the CONTROL A1 or CONTROL A1 II cable (1) to the CONTROL A1 or CONTROL A1 II connector (2) on your MiniDisc deck.
- 2 Plug the other end to the serial connector (3) on your notebook.

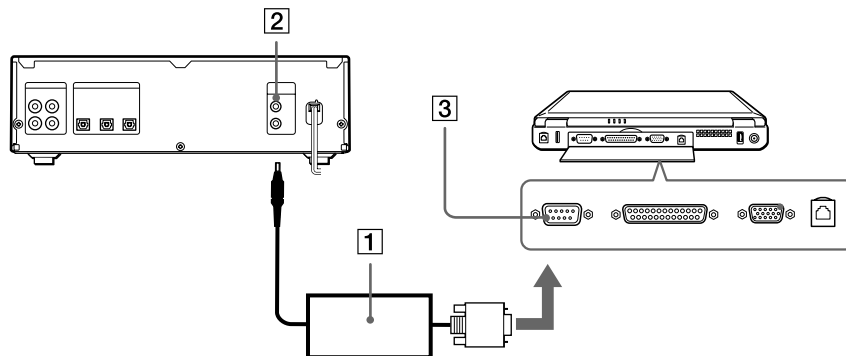

- 3 Plug one end of the optical cable to the digital optical output/input on your CD player and the other end to the digital optical output/input on your MiniDisc.
- 4 Turn on all the devices.
- 5 Launch MD Player.

 Refer to your MiniDisc deck and CD player manuals to check the specifications.

For further information or if you are not sure of the connection capabilities of your devices, please contact your dealer.

To perform a copy using your notebook, you need two CONTROL A1 or CONTROL A1 II cables and one optical cable. These cables are sold separately. To purchase them, please contact your dealer.

The CONTROL A1 or CONTROL A1 II features only work with Sony devices.

Connecting to a network (LAN)

You can connect your computer to 10 BASE-T/100 BASE-TX-type networks via an ethernet network cable*. For the detailed settings and devices needed to connect to the network, consult your Network Administrator.

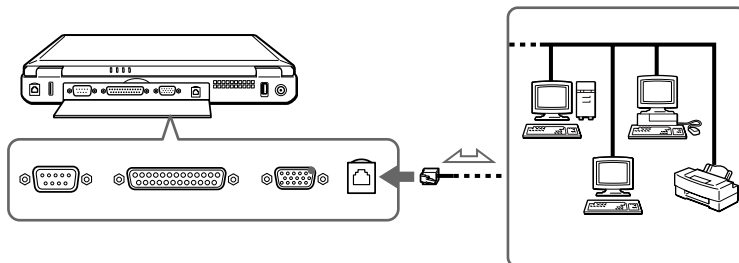

* Not on PCG-FX101.

 The default settings make your computer unable to connect to the network. To connect to the network, check **Ethernet** in Sony Notebook Setup. For more information about connecting your notebook to the network, please consult the Hardware troubleshooting section of the Vaio-Link website:

[How to troubleshoot network problems](#)

! Do not plug a phone cable into your computer network jack.

Getting help

This section describes how to get help and support from Sony, as well as troubleshooting tips for your computer.

Sony support options

Sony provides several support options for your computer.

Printed documentation supplied with your notebook

- ❑ The **Customer Guide** explains how to start your computer and use the basic functions. This guide gives you the information to access VAIO-Link.
- ❑ The **Getting Started** gives you a list of the items you find in the box and a summary of the bundled applications.

Online user guides on your Documentation CD-ROM

- ❑ The **Hardware guide** explains how to use your computer, connect peripheral devices. It contains a list of specifications of your computer and accessories.
- ❑ The **Software guide** lists the pre-installed software titles and explains how to use the utility programs and perform basic computer tasks.
- ❑ The **Customer Service Guide** gives you complete information on the VAIO-Link Services.

Other sources of information

- ❑ The **online help files** that accompany your pre-installed software contain instructions on using the software.

- ❑ **VAIO-Link website:** if you have any problem with your computer, you can access the VAIO-Link web site. Go to:
<http://www.vaio-link.com>
 - ❑ **VAIO-Link Response Centre:** Before contacting VAIO-Link Response Centre, try to solve the problem by reading the User Guides and help files for the peripherals or software.
-  You need to plug in the phone line and configure your modem for use before using the communication features described in this manual.

Troubleshooting

This section describes how to solve common problems you might encounter when using your notebook. Many problems have simple solutions. Please, try these suggestions before contacting VAIO-Link.

About the computer and software

My computer does not start

- ❑ Check that the computer is plugged into a power source and that it is turned on.
- ❑ Check that the power indicator on the front panel of the computer indicates that the power is on.
- ❑ Check that the battery packs are inserted properly and that they are charged.
- ❑ Make sure there is no diskette in the floppy disk drive.
- ❑ Confirm that the power cord and all cables are connected firmly.
- ❑ If you have plugged the computer into a UPS, make sure the UPS is turned on and works.
- ❑ If you are using an external display, check that it is plugged into a power source and turned on. Check that you have switched to the external display and that the brightness and contrast controls are adjusted correctly.
- ❑ Moisture condensation may have occurred. Do not use the computer for at least one hour and then turn it on.

- ❑ If the message **Press <F1> to resume, <F2> to setup** appears at the bottom of the display, you need to initialize the BIOS.
- ❑ Take the battery pack off the notebook, unplug the power cord and plug it again, then turn on the power.

The message Press <F1> to resume, <F2> to setup appears at startup

If the floppy disk drive is empty, proceed as follows to initialize the BIOS:

- 1 Turn off the computer.
- 2 Remove any peripheral devices connected to the computer.
- 3 Turn on the computer and press **<F2>** when the Sony logo appears.
The BIOS setup menu screen appears.
- 4 Press the arrow keys to select the **Exit** menu.
- 5 Press the arrow keys to select **Get Default Values** and then press **<Enter>**. The message **Load default configuration now?** appears.
- 6 Make sure that **[Yes]** is selected and then press **<Enter>**.
- 7 Press the arrow keys to select **Exit** (save changes) and then press **<Enter>**.
The message **Save configuration changes and exit now?** appears.
- 8 Make sure that **[Yes]** is selected and then press **<Enter>**.
- 9 **Windows® 2000**: Restart the computer by pressing **<Ctrl> + <Alt> + <Delete>** and by choosing **Shut Down**.
Windows® Millennium Edition: Restart the computer by pressing **<Ctrl> + <Alt> + <Delete>** twice.

My computer does not shut down

It is recommended to shut down your computer using the **Shut Down** command on the Windows® **Start** menu. Using other methods, including those listed here, may result in loss of unsaved data. If the **Shut Down** command does not work properly, proceed as follows:

- ❑ **(Windows® 2000 Professional)** Restart the computer by pressing **<Ctrl> + <Alt> + <Delete>**. Select **Explorer** and click **Shut Down**.
- ❑ **(Windows® Millennium Edition)** Restart the computer by pressing **<Ctrl> + <Alt> + <Delete>**. The **Windows Security** dialog box appears. Click **Shut Down....** The **Shut Down Windows** dialog box appears. Select **Shut down** and click **OK**.
- ❑ If this does not work, press the power button and hold it for at least four seconds. This turns off the power.
- ❑ Unplug the computer from the AC adapter and remove the battery pack from your computer.

My computer locks up

- ❑ **Windows® 2000:** If you suspect one application is locking your system, you can try to stop it. To do this, press **<Ctrl>+<Alt>+<Delete>** once, click **Task Manager**, select the application or the process that is locking your system, and then click **End Task**.
- ❑ **Windows® Millennium Edition:** If you suspect one application is locking your system, you can try to stop it. To do this, press **<Ctrl>+<Alt>+<Delete>** once, select the application that is locking your system, and then click **End Task**.
- ❑ If the above method does not work or you do not know which application is locking your system, restart the computer. On the Windows® taskbar, click the **Start** button, click **Shut Down**, and then select **Shut Down** in the list and click **OK**.
- ❑ If the above method does not work, press the power button and hold it for at least four seconds. This turns off the power.
- ❑ If your computer locks up while playing a CD-ROM, stop the CD-ROM, and shutdown the computer by pressing **<Ctrl>+<Alt>+<Delete>**, and then click **Shut Down**.

My software program locks up or crashes

Contact the software publisher or designated provider for technical support.

My touchpad interprets a single tap as a double-click

Open the **Mouse** icon in the **Control Panel** and change the button assignments in the **Mouse Properties** dialog box. One of the buttons is assigned to the double-click action.

My mouse does not work

- If you are using an external serial PS/2 mouse, check that the mouse is plugged into the mouse connector of your port replicator.
- If you are using a USB mouse, check that the appropriate driver and software are properly installed.
- Check that the USB mouse is plugged into the USB connector.

About the display

My LCD does not display anything

- Check that the computer is plugged into a power source and that it is turned on.
- Check that the power indicator on the front panel of the computer is on.
- Check that the battery packs are inserted properly and that they are charged.
- Adjust the brightness of the LCD.
- The computer may be in LCD (video) standby mode. Press any key to activate the display.
- The display mode may be set to external display mode. Press and hold the **Fn** key while pressing **F7** several times.

The screen image on my external display is not centered or sized properly

Use the controls on your external display to adjust the image.

The window I have just closed continues to appear on my LCD

Press the **Windows**® key and **D** key twice to refresh the screen.

*I cannot switch from LCD display to TV and vice versa**

If the DVD disk is inserted in the DVD-ROM drive, remove the disk.

* Not available on PCG-FX101 and PCG-FX103.

About CD-ROMs and diskettes

My optical disk drive tray does not open

- Make sure the computer is turned on.
- Press the **Eject** button on the optical disk drive*.
- If the **Eject** button does not work, you can open the tray by inserting a sharp, pointed object into the hole to the right of the **Eject** button.

* CD-ROM: PCG-FX101

DVD-ROM: PCG-FX103/PCG-FX105K/PCG-FX108K

CD-RW/DVD-ROM: PCG-FX109K

I cannot play a CD-ROM disk

- Make sure the label of the disk is facing up.

- ❑ If the disk requires software, make sure the software is installed according to the instructions of the program.
- ❑ Check the volume of your speakers.
- ❑ Clean the disk.
- ❑ Moisture condensation may have occurred. Leave the computer for at least 1 hour while it is turned on.

I cannot play a DVD-ROM disk

- ❑ If a region code warning appears when you are using the DVD player, it could be that the DVD-ROM disk you are trying to play is incompatible with the DVD-ROM drive in your notebook. The region code is listed on the packaging of the disk.
- ❑ If you hear sound but cannot see video, your computer's video resolution may be set too high. For best results, change the resolution in Windows **Control Panel - Display - Settings** to 800 x 600 using 8-bit color.
- ❑ If you see video but cannot hear sound, check all of the following:
 - ❑ Make sure the mute setting is off in your DVD player.
 - ❑ Check the master volume setting in the **Audio Mixer**. If you have connected speakers externally, check the volume settings in your computer speakers and check the connections between your speakers and the computer.
 - ❑ **Windows® 2000**: In the **Device Manager**, check that the correct drivers are installed properly. To display the **Device Manager**, click **Start**, point to **Settings** and click **Control Panel**. Double-click the **System** icon. On the **Hardware** tab, click on the **Device Manager** button.
 - ❑ **Windows® Millennium Edition**: In the **Device Manager**, check that the correct drivers are installed properly. To display the **Device Manager**, click **Start**, point to **Settings** and click **Control Panel**. Double-click the **System** icon. On the **System** properties, click on the **Device Manager** tab.
- ❑ A dirty or damaged disk may cause the computer to 'hang' while it tries to read the disk. If necessary, reboot the computer, remove the disk and then check that it is not dirty or damaged.

-  On your computer, the default DVD region code is 2. Do not change this setting using the Region Code Change function in Windows®, or using any other software applications. System malfunctions originating from the user changing the DVD region code are beyond the scope of your warranty and will result in service charges for repair.

My floppy disk drive cannot write to a diskette

- The diskette is write-protected. Disable the write-protect feature or use a diskette that is not write-protected.
- Check that the diskette is properly inserted into the floppy disk drive.

When I double-click an application icon a message such as You must insert the application CD into your CD-ROM drive appears and the software does not start.

- Some titles require specific files that are located on the application CD-ROM. Insert the disk and try starting the program again.
- Make sure you place the disk in the tray with the label side facing up.

The disk tray does not eject even when the Eject button is pressed

- Check that the notebook is turned on.
- The application software when burning a CD may prohibit it.

The disk tray ejects even when it has been locked into place

- Ensure that the disk is placed with the label side facing up.
- Clean the disk and the CD-RW drive lens.
- The disk may be scratched. Place another disk to see if that is the reason.
- There may be condensation in the drive. Remove the disk and leave the drive open for approximately one hour.

About sound

My speakers are not producing sound

- ❑ The built-in speakers may be turned off. Press **<Fn>+<F3>** to turn on the speakers.
- ❑ The speaker volume may be turned to the minimum. Press **<Fn>+<F4>**, and then press **↑** or **➡** to increase the volume.
- ❑ If your computer is powered by battery, check that the battery is inserted properly and that it is charged.
- ❑ If you are using an application that has its own volume control, check that the volume is turned up.
- ❑ Check the volume controls in Windows®.
- ❑ If you use external speakers, check that the speakers are properly connected and the volume is turned up. If the speakers have a mute button, make sure it is off. If batteries power the speakers, check that the batteries are inserted properly and that they are charged.
- ❑ If you have connected an audio cable to the Headphone connector, disconnect the cable.

The sound of my notebook's fan is too loud

Use the **PowerPanel** utility to change the **Thermal Control Strategy** setting to **Quiet**. This setting slows down the CPU speed. See PowerPanel Help for more information.

My microphone does not work

If you are using an external microphone, check that the microphone is plugged into the microphone connector.

About the modem

My internal modem does not work

- ❑ Check that the phone line is plugged into your computer.

- ❑ Check that the phone line is working. You can check the line by plugging in an ordinary phone and listening for a dial tone.
- ❑ Check that the phone number the program is dialing is correct.
- ❑ **(Windows® 2000 Professional)** In the **Phone and Modem Options** dialog box (**Control Panel / Phone and Modem Options**), check that your modem is listed on the **Modems** tab, and that the location information is correct on the **Dialing Rules** tab.
- ❑ **(Windows® Millennium Edition)** In the **Modems Properties** dialog box (**Control Panel / Modems***), check that your modem is listed in the **General** tab, and that the location information is correct on the **Dialing Properties** tab.

* (Windows Millennium Edition) If you do not see the **Modems** icon, proceed as follows:

- 1 In **Control Panel** click **Tools** and click **Folder Options...**
- 2 Select the **View** tab.
- 3 In the **Advanced settings:** dialog box, select the option **Display all Control Panel options and all folder contents.**
- 4 Click **OK.**

My modem cannot establish a connection

The modem dialing mode may be incompatible with your telephone line.

My modem connection is slow

Many factors influence modem connection speed, including telephone line noise or compatibility with telephone equipment (such as fax machines or other modems). If you think your modem is not connecting properly to other PC-based modems, fax machines, or your Internet Service Provider, check the following:

- ❑ Have your phone company check that your phone line is free from any line noise.

- ❑ If your problem is fax-related, check that there are no problems with the fax machine you are calling and that it is compatible with fax modems.
- ❑ If you are having a problem connecting with your Internet Service Provider, check that the ISP is not experiencing technical problems.
- ❑ If you have a second phone line available, try connecting the modem to that line.

About peripherals

I cannot use DV devices. The message DV equipment seems to be disconnected or turned off appears

- ❑ Check that the DV device is turned on and that the cables are properly connected.
- ❑ If you are using multiple i.LINK™ devices, the combination of the connected devices may cause unstable operation. In this case, turn off the power of all connected devices and disconnect unused devices. Check the connection and then turn on the power again.

My PC Card is not working

- ❑ Make sure the PC card is compatible with your version of Windows®.
- ❑ Use the **Sony Notebook Setup** utility to disable devices you are not currently using.
- ❑ If you are using two PC cards, use the **Sony Notebook Setup** utility to disable the devices you are not currently using.

I cannot print

- ❑ Check that all the cables of the printer are correctly connected.
- ❑ Check that your printer is correctly configured and that you have up-to-date drivers. If needed, contact your dealer.

- ❑ The default setting for the printer port mode is correct for most printers. If you cannot print, try changing the printer port mode. In **Sony Notebook Setup**, select the **Printer** tab. If the printer port mode is set to ECP, change it to bi-directional. If the printer port mode is set to bi-directional, change it to ECP.

About digital video captures and DVgate

While I am recording images to a digital video device using DVgate, my system displays the message Recording to DV device failed. Check the power and cable connections to the DV device and try the operation again...

Close all open applications and restart your computer. Frequent recording of images to a digital video device while using DVgate sometimes causes this error.

About power management

The Power Management setting is not responding

Your notebook's operating system may become unstable if a lower power state, such as **Hibernate** is initiated, and then changed before the notebook completely enters the lower power state.

To restore the notebook to its normal operating stability, proceed as follows:

- 1 Close all open applications.
- 2 Push and hold the power button for four seconds or longer to shut down the notebook.

Precautions

This section describes safety guidelines and precautions to help you protect your computer from potential damage.

Your notebook and memory modules use high precision components and electronic connectors technology. To avoid the invalidation of your guarantee by mishandling, it is recommended that:

- You contact your dealer to install a new memory module.
- You do not install it yourself, if you are not familiar with upgrading memory on a notebook.
- You do not touch the connectors or open the memory panel.

Please contact VAIO-Link if you need assistance.

Adding and removing memory

In the future you may want to install memory modules to expand the functionality of your computer. You can increase the memory by installing optional memory modules.

Be careful when adding memory. Mistakes on installation or removal of the memory module may cause a malfunction.

For memory upgrades, use only PC100 (CL2) SDRAM SO-DIMM (gold lead contacts).

Electrostatic discharge can damage electronic components. Before touching a memory expansion board, ensure the following:

- Handle the memory module gently.
- The procedures described in this document assume familiarity with the general terminology associated with personal computers and with the safety practices and regulatory compliance required for using and modifying electronic equipment.

- ❑ Disconnect the system from its power source and from any telecommunication links, networks, or modems before you open the system. Failure to do so may result in personal injury or equipment damage.
- ❑ Electrostatic Discharge (ESD) can damage memory modules and other components. Install the memory Module only at an ESD workstation. If such a station is not available, do not work in a carpeted area, and do not handle materials that produce or hold static electricity (cellophane wrappers, for example). Ground yourself by maintaining contact with an unpainted metal portion of the chassis while performing the procedure.
- ❑ Do not open the memory module package until you are ready to install the module. The package protects the module from ESD.
 - ! Use the special bag delivered with the memory module or wrap the module in aluminium foil to protect it from electrostatic discharge.
 - ! Do not place the memory module in places subject to:
 - Heat sources such as radiators or air ducts,
 - Direct sunlight,
 - Excessive dust,
 - Mechanical vibration or shock,
 - Strong magnets or speakers that are not magnetically shielded,
 - Ambient temperature of more than +35°C or less than +5°C,
 - High humidity.

Removing a memory module

To remove a memory module, proceed as follows:

- 1 Shut down your computer.
- 1 Disconnect all peripheral devices.
- 2 Unplug the computer and remove the battery pack.
- 3 Wait until the computer cools down.

- ❑ Turn your computer upside down.
- ❑ Open the cover on the bottom by unscrewing the screws (turn counterclockwise).
- ❑ To remove the memory module, pull the tabs in the direction of the arrows 1. The memory module is released.
- ❑ Pull the memory module in the direction of arrow 2.
- ❑ Close the cover.
- ❑ Gently tighten the screws.

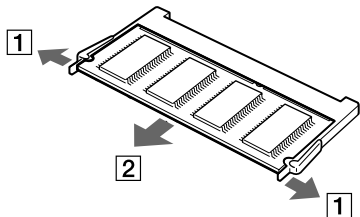

Adding a memory module

To add a memory module, proceed as follows:

- 1 Shut down your computer and disconnect all peripheral devices.
- 2 Unplug the computer and remove the battery packs.
- 3 Wait until the computer cools down.
- 4 Turn your computer upside down.

- 5 Open the cover on the bottom by unscrewing the screw (turn counterclockwise).

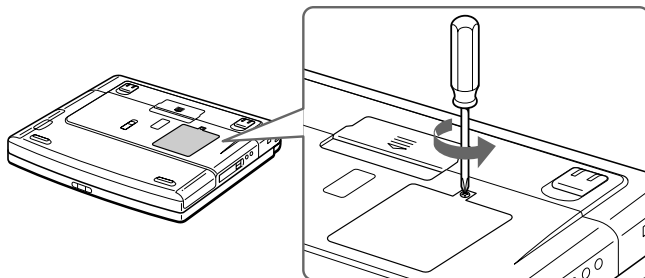

- ❑ Remove the memory module from its packaging.
- ❑ Install the memory module.

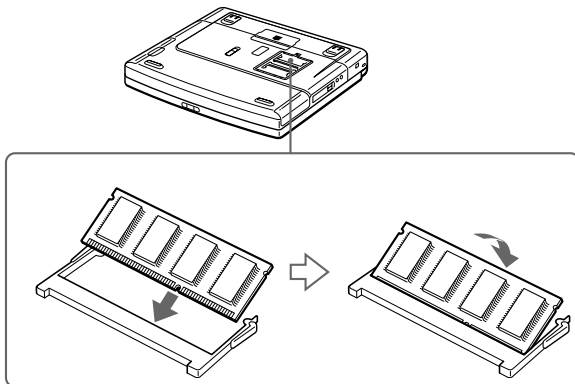

- 6 Close the computer cover.
- 7 Tighten the screws on the bottom of the computer.
- 8 Turn on the computer.

Viewing the amount of memory

To view the amount of memory, proceed as follows:

- 1 Turn on the computer.
- 2 Click the **Start** button, point to **VAIO**, and click **Sony Notebook Setup**. The **Sony Notebook Setup** screen appears.
- 3 Click the **About this Computer** tab to view the amount of system memory. If the additional memory does not appear, repeat the whole procedure.

Other precautions

On handling the hard disk

The hard disk has a high storage density and reads or writes data in a short time. On the other hand, it may be easily damaged by mechanical vibration, shock or dust.

Although the hard disk has the safety device in itself to prevent losing data due to mechanical vibration, shock or dust, you should be careful when handling your computer.

To avoid damaging your hard disk:

- Do not give a shock to your computer.
- Keep away from magnets.
- Do not place your computer in a location subject to mechanical vibration or in unstable situation.
- Do not move your computer while the power is on.
- Do not turn off the power or restart the computer while reading or writing data.
- Do not use your computer in a place subject to extreme change of temperature.
- If the hard disk is damaged, the data cannot be restored.

On handling the LCD screen

- ❑ Do not leave the LCD facing the sun as it can damage the LCD. Be careful when using the computer near a window.
- ❑ Do not scratch the LCD or exert pressure on it. This could cause malfunction.
- ❑ Using the computer in low temperature conditions may produce a residual image on the screen. This is not a malfunction. When the computer returns to normal temperature, the screen returns to normal.
- ❑ A residual image may appear on the screen if the same image is displayed for a lengthy period of time. The residual image disappears in a while. You can use a screensaver to prevent residual images.
- ❑ The screen becomes warm during operation. This is normal and does not indicate a malfunction.
- ❑ The LCD is manufactured using high-precision technology. You may, however, see tiny black points and/or bright points (red, blue, or green) that continuously appear on the LCD. This is a normal result of the manufacturing process and does not indicate a malfunction.
- ❑ Avoid rubbing the LCD screen, as this can damage the screen. Use a soft, dry cloth to wipe the LCD screen.

On using power source

- ❑ Your computer operates on 100V-240V AC 50/60 Hz.
- ❑ Do not share the AC outlet with other power-consuming equipment, such as a photocopier or shredder.
- ❑ You can purchase a power strip with a surge protector. This device prevents damage to your computer caused by sudden power surges such as those that may occur during an electrical storm.
- ❑ Do not place heavy objects on the power cord.
- ❑ To disconnect the cord, pull it out by the plug. Never pull the cord itself.
- ❑ Unplug your computer from the wall outlet, if you will not be using the computer for a long time.
- ❑ When the AC adapter is not used, unplug it from the AC outlet.
- ❑ Use only the supplied AC adapter. Do not use any other AC adapter.

On handling your notebook

- ❑ Clean the cabinet with a soft, dry cloth or a soft cloth lightly moistened with a mild detergent solution. Do not use any type of abrasive pad, scouring powder, or solvent such as alcohol or benzine, as these may damage the finish of your computer.
- ❑ Should any solid object or liquid fall into the computer, shut down your computer and then unplug it. You may want to have the computer checked by qualified personnel before operating it any further.
- ❑ Do not drop the computer or place heavy objects on top of the computer.
- ❑ Do not place your computer in a location subject to:
 - ❑ Heat sources, such as radiators or air ducts,
 - ❑ Direct sunlight,
 - ❑ Excessive dust,
 - ❑ Moisture or rain,
 - ❑ Mechanical vibration or shock,
 - ❑ Strong magnets or speakers that are not magnetically shielded,
 - ❑ Ambient temperature of more than 35° C or less than 10° C,
 - ❑ High humidity.
- ❑ Do not place electronic equipment near your computer. The electromagnetic field of your computer may cause a malfunction.
- ❑ Provide adequate air circulation to prevent that internal heat builds up. Do not place your computer on porous surfaces such as rugs or blankets, or near material such as curtains or draperies that may block its ventilation slots.
- ❑ The computer uses high-frequency radio signals and may cause interference to radio or TV reception. Should this occur, relocate the computer a suitable distance away from the set.
- ❑ Use only specified peripheral equipment and interface cables; otherwise, problems may result.

- ❑ Do not use cut or damaged connection cables.
- ❑ Your computer cannot be connected to a coin-operated telephone, and may not work with a private branch exchange (PBX).
- ❑ If the computer is brought directly from a cold location to a warm one, moisture may condense inside your computer. In this case, allow at least one hour before turning on your computer. If any problem occurs, unplug your computer and contact VAIO-Link.
- ❑ Make sure to disconnect the power cord before cleaning the computer.
- ❑ As you may lose important data once your computer is damaged, you should back up your data regularly. Restore the original application programs from the Product Recovery CD-ROM.

On handling diskettes

- ❑ Do not open the shutter manually and touch the surface of the diskette.
- ❑ Keep diskettes away from magnets.
- ❑ Keep diskettes away from direct sunlight and other heat sources.

On handling CD-ROM disks

- ❑ Do not touch the surface of the disk.
- ❑ Do not drop or bend the disk.
- ❑ Fingerprints and dust on the surface of a disk may cause read errors. Proper care of the disk is essential to maintain its reliability. Do not use solvents such as benzene, thinner, commercially available cleaners or anti-static spray, as they may cause damage to the disk.
- ❑ For normal cleaning, hold the disk by its edge and use a soft cloth to wipe the surface from the center out.
- ❑ If the disk is badly soiled, moisten a soft cloth with water, wring it out well, and use it to wipe the surface of the disk from the center out. Wipe off any remaining moisture with a dry soft cloth.

On using the battery pack

- ❑ Never leave the battery pack in temperatures above 60° C, such as in a car parked in the sun or under direct sunlight.
- ❑ Battery life is shorter in a cold environment. This is due to decreased battery efficiency at low temperatures.
- ❑ Charge the batteries at temperatures between 10° C to 30° C. Lower temperatures require a longer charging time.
- ❑ While the battery is in use or being discharged, the battery pack heats up. This is normal and is not cause for concern.
- ❑ Keep the battery pack away from all sources of heat.
- ❑ Keep the battery pack dry.
- ❑ Do not open or try to disassemble the battery pack.
- ❑ Do not expose the battery pack to any mechanical shock.
- ❑ If you are not using the computer for an extended period of time, remove the battery pack from the computer to prevent damage to the battery.
- ❑ If, after fully charging the battery pack, the battery power is still low, the battery pack may be reaching the end of its life and should be replaced.
- ❑ You do not need to discharge the battery before recharging.
- ❑ If you have not used the battery pack for a considerable amount of time, recharge the battery.

On using earphones

- ❑ **Road safety** – Do not use earphones while driving, cycling, or operating any motorized vehicle. It may create a traffic hazard and is illegal in some areas. It can also be potentially dangerous to play loud music while walking, especially at pedestrian crossings.

- ❑ **Preventing hearing damage** – Avoid using earphones at high volume. Hearing experts advise against continuous, loud and extended play. If you experience a ringing in your ears, reduce the volume or discontinue use.

On handling Memory Stick

- ❑ Do not touch the connector with your finger or metallic objects.
- ❑ Use only the label supplied with the Memory Stick™ as a label.
- ❑ Do not bend, drop, or apply strong shock to the Memory Stick™.
- ❑ Do not disassemble or modify Memory Sticks™.
- ❑ Do not let cards get wet.
- ❑ Do not use or store Memory Sticks™ in a location subject to:
 - ❑ Extremely high temperatures, such as in a car parked in the sun,
 - ❑ Direct sunlight,
 - ❑ High humidity or near corrosive substances.
- ❑ Use the storage case supplied with the Memory Stick™.

Specifications PCG-FX101 / PCG-FX103

Model Number	PCG-FX101	PCG-FX103
<i>Operating system</i>	Microsoft® Windows® Millennium Edition	
<i>Processor</i>	Mobile Intel® Celeron™ processor 600 MHz	Mobile Intel® Pentium® III processor 650 MHz featuring Intel® SpeedStep™ technology
<i>Hard disk drive</i>	10 GB	
<i>Standard RAM</i>	64 MB SDRAM (in slot)	
<i>Maximum RAM</i>	512 MB	
<i>LCD screen</i>	13.3" XGA (1024x768) TFT	
<i>L2 cache memory</i>	128 KB (on die)	256 KB (on die)
<i>MPEG</i>	MPEG 2 Digital Video Supports full-screen playback	
<i>Graphics</i>	Intel® 815EM Chipset integrated graphic accelerator Video RAM: max 11MB (shared with main memory)	
<i>Display cache</i>	not available	
<i>Sound capabilities</i>	16-bit CD-quality stereo sound	

Model Number	PCG-FX101	PCG-FX103
<i>Floppy disk drive</i>	not available	3.5" 1.44 MB (removable)
<i>CD-ROM drive DVD-ROM drive CD-RW/DVD-ROM drive</i>	CD-ROM drive up to 24x max. CD-ROM reading speed laser diode properties: wave length: 785 nm laser output: 3.97 μ W	DVD-ROM drive up to 24x max. CD-ROM reading speed up to 8x max. DVD-ROM reading speed laser diode properties: wave length: 780 nm and 650 nm laser output: 30.2 μ W
<i>Internal modem</i>	built-in modem V90/K56Flex (56kbps) data/fax modem	
<i>Telecommunication capabilities</i>	PSTN data connectivity	ethernet network, PSTN data connectivity
<i>Expansion capabilities</i>	two PCMCIA type I, two PCMCIA type II or one type III Cards and Cardbus support	
<i>Built-in capabilities</i>	stereo speakers, touchpad	
<i>Special buttons</i>	not available	PPK (programmable power keys)

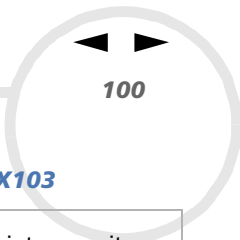

Model Number	PCG-FX101	PCG-FX103
<i>Connection capabilities on notebook</i>	printer, monitor, external speakers, headphone, external microphone, 2 USB, serial, type II PC cards, modem, i.LINK™ (IEEE1394) S400	port replicator, printer, monitor, external speakers, headphone, external microphone, 2 USB, serial, type II PC cards, modem, i.LINK™ (IEEE1394) S400, ethernet
<i>Connection capabilities on port replicator</i>	no port replicator available	DC In, printer, monitor, serial, 3 USB, PS/2 mouse/keyboard, network
<i>Supplied accessories</i>	rechargeable battery, AC adapter, AC power cord, phone cable, phone plug, weight saver.	rechargeable battery, AC adapter, AC power cord, phone cable, phone plug, weight saver, floppy disk drive.
<i>Service</i>	‡ 1 year free VAIO-Link Service	
<i>Guarantee</i>	‡ 1 year guarantee (parts and labour)	
<i>Power requirement</i>	64.35 watts maximum (19.5V DC/AC100-240V)	
<i>Power management</i>	ACPI (Advanced Configuration & Power Interface)	
<i>Battery</i>	Lithium ion	

Model Number	PCG-FX101	PCG-FX103
<i>Dimensions</i>		
<i>Width</i>	324 mm	
<i>Height</i>	35.8 mm to 46.9 mm	
<i>Depth</i>	265.5 mm	
<i>Weight</i>		
- with 1 battery and weight saver	3.0 kg	3.0 kg
- with 1 battery and floppy disk drive	-	3.2 kg
<i>Operating temperature</i>	+5°C to +35°C (temperature gradient less than 10°C/hour)	
<i>Storage temperature</i>	-20°C to +60°C (temperature gradient less than 10°C/hour)	
<i>Operating humidity</i>	20% to 80% (not condensed), provided that humidity is less than 65% at +35°C (hygrometer reading of less than 29°C)	
<i>Storage humidity</i>	10% to 90% (not condensed), provided that humidity is less than 20% at +60°C (hygrometer reading of less than 35°C)	

‡ See our special Guarantee extension conditions.
Specifications are subject to change without notice.

Specifications PCG-FX105K / PCG-FX108K / PCG-109K

Model Number	PCG-FX105K	PCG-FX108K	PCG-FX109K
<i>Operating system</i>	Microsoft® Windows® 2000 Professional		
<i>Processor</i>	Mobile Intel® Pentium® III processor 700 MHz featuring Intel® SpeedStep™ technology	Mobile Intel® Pentium® III processor 750 MHz featuring Intel® SpeedStep™ technology	Mobile Intel® Pentium® III processor 850 MHz featuring Intel® SpeedStep™ technology
<i>Hard disk drive</i>	20 GB		30 GB
<i>Standard RAM</i>	64 MB SDRAM (in slot)	128 MB SDRAM (in slot)	
<i>Maximum RAM</i>	512 MB		
<i>LCD screen</i>	14.1" XGA (1024x768) TFT	15.0" XGA (1024x768) TFT	15.0" SXGA+ (1400x1050) TFT
<i>L2 cache memory</i>	256 KB (on die)		
<i>MPEG</i>	MPEG 2 Digital Video Supports full-screen playback		
<i>Graphics</i>	Intel® 815EM Chipset integrated graphic accelerator Video RAM: max 11MB (shared with main memory)		
<i>Display cache</i>	4 MB		

Model Number	PCG-FX105K	PCG-FX108K	PCG-FX109K
<i>Sound capabilities</i>	16-bit CD-quality stereo sound		
<i>Floppy disk drive</i>	3.5" 1.44 MB (removable)		
<i>CD-ROM drive</i> <i>DVD-ROM drive</i> <i>CD-RW/DVD-ROM drive</i>	DVD-ROM drive up to 24x max. CD-ROM reading speed up to 8x max. DVD-ROM reading speed laser diode properties: wave length: 780 nm and 650 nm laser output: 30.2 μ W		CD-RW/DVD-ROM drive up to 24x max. CD-ROM reading speed up to 8x max. CD-R writing speed up to 4x max. CD-RW writing speed up to 8x max. DVD-ROM reading speed laser diode properties: wave length: 785 nm and 660 nm laser output: 468 μ W
<i>Internal modem</i>	built-in modem V90/K56Flex (56kbps) data/fax modem		
<i>Telecommunication capabilities</i>	ethernet network, PSTN data connectivity		
<i>Expansion capabilities</i>	two PCMCIA type I, two PCMCIA type II or one type III Cards and Cardbus support		

Model Number	PCG-FX105K	PCG-FX108K	PCG-FX109K
<i>Built-in capabilities</i>	stereo speakers, touchpad		
<i>Special button</i>	PPK (programmable power keys)		
<i>Connection capabilities on notebook</i>	port replicator, printer, monitor, external speakers, headphone, external microphone, 2 USB, serial, type II PC cards, modem, i.LINK™ (IEEE1394) S400, ethernet, TV out		
<i>Connection capabilities on port replicator</i>	DC In, printer, monitor, serial, 3 USB, PS/2 mouse/keyboard, network		
<i>Supplied accessories</i>	rechargeable battery, AC adapter, AC power cord, phone cable, phone plug, weight saver, floppy disk drive, video cable.		
<i>Service</i>	± 1 year free VAIO-Link Service		
<i>Guarantee</i>	± 1 year guarantee (parts and labour)		
<i>Power requirement</i>	64.35 watts maximum (19.5V DC/AC100-240V)		
<i>Power management</i>	ACPI (Advanced Configuration & Power Interface)		
<i>Battery</i>	Lithium ion		

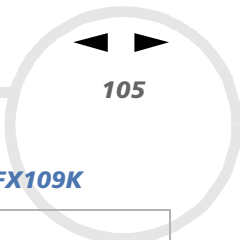

Model Number	PCG-FX105K	PCG-FX108K	PCG-FX109K
<i>Dimensions</i>			
<i>Width</i>	324 mm	324 mm	
<i>Height</i>	35.8 mm to 46.9 mm	38.5 mm to 54.1 mm	
<i>Depth</i>	265.5 mm	265.5 mm	
<i>Weight</i>			
- with 1 battery and weight saver	3.1 kg	3.2 kg	3.3 kg
- with 1 battery and floppy disk drive	3.3 kg	3.4 kg	3.5 kg
<i>Operating temperature</i>	+5°C to +35°C (temperature gradient less than 10°C/hour)		
<i>Storage temperature</i>	-20°C to +60°C (temperature gradient less than 10°C/hour)		
<i>Operating humidity</i>	20% to 80% (not condensed), provided that humidity is less than 65% at +35°C (hygrometer reading of less than 29°C)		
<i>Storage humidity</i>	10% to 90% (not condensed), provided that humidity is less than 20% at +60°C (hygrometer reading of less than 35°C)		

‡ See our special Guarantee extension conditions.
 Specifications are subject to change without notice.

INDEX

A

- AC adapter 5, 10, 18, 57
- accessory 100
- air circulation 94
- Alt key 31
- application key 31
- audio cable 61, 63

B

- battery
 - bay 14, 19
 - charging status 20
 - charging the 20
 - indicator 15, 20, 32
 - pack 10, 19, 22, 26
- brightness control 27, 33
- built-in capability 99
- button
 - left 15
 - power 13, 27
 - right 15

C

- cable
 - audio 61, 63
 - CONTROL A1 73
 - CONTROL A1 II 73
 - display 59, 60
 - ethernet network 75
 - i.LINK™ 71
 - keyboard 66
 - microphone 60, 65
 - mouse 66
 - phone 50
 - printer 68
 - RGB signal 63
 - speaker 60, 64
 - video 10, 61
- camera 71
- Caps Lock indicator 15, 32
- CD-ROM drive 8, 10, 35, 99, 103
- CD-RW 38
- CD-RW drive 10, 35, 38, 99, 103
- charging status 20
- combination controls 31, 33
- connection capability 100
- connector
 - DC In 16, 18, 55, 57
 - earphone 63, 64
 - ethernet 16, 55
 - headphone 14, 60, 61

- i.LINK™ 14
 - keyboard 55, 66
 - microphone 14, 65
 - monitor 16, 55, 59, 60, 63
 - mouse 55, 66
 - port replicator 56
 - printer 69
 - serial 16, 55
 - TV Out 14, 61
 - USB 16, 68
- copyright 2
 - correction key 30
 - Ctrl key 31
 - Customer Guide 76
 - Customer Service Guide 76

D

- DC In 16, 18
- DC In connector 55, 57
- digital video camera 71
- dimension 101
- DirectCD™ 39
- diskette
 - inserting a 41
 - removing a 42
- display 59
 - cable 59, 60
 - computer 59

multimedia computer 59, 60
resolution 37, 62
documentation pack 9, 10
DVD-ROM drive 8, 10, 35, 38, 62, 99,
103
DVgate 71

E

earphone connector 63, 64
Easy CD Creator 39
eject lever 26, 40
Energy Star guidelines 3
ergonomic considerations 11
Escape key 30
ethernet 8
 connector 16, 55
 network cable 75
expansion capability 99
external
 display 33
 keyboard 66
 microphone 65
 mouse 66
 speaker 64

F

floppy disk drive 10, 13, 23, 41, 43,
99
Fn key 31, 33
function key 30

G

graphic 98
guarantee 4, 29, 100

H

hard disk drive 98
hard disk drive indicator 15, 32
headphone connector 14, 60, 61
help 76
Help key 30
Hibernate mode 21, 33, 52, 53
humidity
 operating 101
 storage 101

I

i.LINK™ 8, 14
 cable 71
 device 70
indicator

battery 15, 20, 32
Caps Lock 15, 32
hard disk drive 15, 32
LED 42
Num Lock 15, 32
power 15
Scroll Lock 15, 32
Insert key 30

K

key
 Alt 31, 51
 application 31
 combination 62, 63
 correction 30
 Ctrl 31, 51
 Escape 30
 Fn 31, 33
 function 30
 Help 30
 Insert 30
 navigation 31
 operator 31
 Print Screen 30
 Shift 31, 51
 Windows 31
keyboard 15, 30
keyboard connector 55, 66

L

L2 cache memory 98

LCD

lock lever 27

screen 8, 15, 98

LED indicator 42

lithium ion battery 7

M

Macrovision 2

maximum RAM 98

MD player 73

Media Bar 73

memory module

adding a 90

removing a 89

Memory Stick 47

inserting a 48

removing a 49

microphone 65

cable 60, 65

connector 14, 65

MiniDisc 73, 74

model number 4

modem 4, 8, 50, 99

moisture condensation 95

monitor 59

monitor connector 16, 55, 59, 60, 63

mouse connector 55, 66

MPEG 98

multi-purpose bay 13, 23, 40, 43

N

navigation key 31

network 75

Normal mode 52

Num Lock 31

Num Lock indicator 15, 32

numeric keypad 31

O

operating system 98

operator key 31

optical disk drive 5

P

parallel port 55

PC Card

adapter 48

inserting a 44

removing a 46

slot 14, 44

peripherals 54

phone

cable 10, 13, 50

line jack 16, 50

plug 10

port

parallel 55

USB 55

port replicator

connecting a 56

connector 56

connector cover 17, 58

disconnecting a 58

port cover 56

power

button 13, 27

cord 10, 57, 61, 63, 68, 69

indicator 15, 57

management 100

requirement 100

saving modes 52

PPK (programmable power key) 13, 51

precautions 88

Print Screen key 30

printer 16, 68, 69

cable 68

connector 69

processor 98

product recovery CD-ROM 10

projector 59, 63

R

registration 29
regulatory information 6
release lever 17, 26, 40, 43
RGB signal cable 63

S

screensaver 38
Scroll Lock indicator 15, 32
serial
 connector 16, 55
 number 4
service 100
Shift key 31
slot
 PC Card 14, 44
 ventilation 16
Smart Connect 72
Software guide 76
sound 98
speaker 15, 64
 cable 60, 64
 volume 33
special button 99
specifications 98, 102
standard RAM 98
Standby mode 21, 33, 52

T

technical specifications 98, 102
telecommunication 99
temperature
 operating 101
 storage 101
tilt stand 12, 17
touchpad 15, 34
trademark 3
troubleshooting 77
TV 37, 59, 61
TV Out connector 14, 61

U

USB
 connector 16, 68
 mouse 67
 port 55

V

VAIO 8
VAIO-Link 4, 7, 8, 29, 51, 77
VAIO-Link Response Centre 77
ventilation 94
ventilation slot 16
video

cable 10, 61
camera 71

W

warnings 4
weight 101
weight saver 10, 13, 24, 40, 43
Windows key 31