



# User Guide

Personal Computer  
VGN-FJ series

# Contents

Before Use .....	5
Notice .....	5
ENERGY STAR .....	6
Documentation .....	7
Ergonomic Considerations .....	10
Getting Started .....	12
Locating Controls and Ports .....	13
About the Indicator Lights .....	20
Connecting a Power Source .....	21
Using the Battery Pack .....	22
Shutting Down Your Computer Safely .....	26
Using Your VAIO Computer .....	27
Using the Keyboard .....	28
Using the Touch Pad .....	30
Using Special-function Buttons .....	31
Using the Built-in MOTION EYE Camera .....	32
Using the Optical Disc Drive .....	33
Using PC Cards .....	41
Using the Memory Stick Media .....	44
Using the Internet .....	48
Using Wireless LAN (WLAN) .....	49

Using Peripheral Devices .....	59
Connecting a Port Replicator .....	60
Connecting External Speakers .....	64
Connecting an External Display .....	65
Selecting Display Modes .....	71
Using the Multiple Monitors Function .....	72
Connecting an External Microphone .....	74
Connecting a Universal Serial Bus (USB) Device .....	75
Connecting a Printer .....	78
Connecting an i.LINK Device .....	80
Connecting to a Network (LAN) .....	82
Customizing Your VAIO Computer .....	84
Setting the Password .....	85
Setting Up Your Computer with VAIO Control Center .....	88
Using the Power Saving Modes .....	89
Managing Power with VAIO Power Management .....	94
Upgrading Your VAIO Computer .....	96
Adding and Removing Memory .....	97
Precautions .....	103
On Handling the LCD Screen .....	104
On Using the Power Source .....	105
On Handling Your Computer .....	106
On Using the Built-in MOTION EYE Camera .....	108
On Handling Floppy Disks .....	108

- On Handling Discs ..... 109
- On Using the Battery Pack..... 110
- On Using Headphones..... 111
- On Handling Memory Stick Media..... 111
- On Handling the Hard Disk ..... 112
- Troubleshooting ..... 113
  - Troubleshooting the optical disc drive ..... 114
  - Troubleshooting PC Cards..... 117
  - Troubleshooting the modem ..... 118
  - Troubleshooting Wireless LAN ..... 120
  - Troubleshooting Power Management ..... 123
  - Troubleshooting External Displays ..... 124
  - Troubleshooting Sound (Speaker) ..... 126
  - Troubleshooting Sound (Microphone)..... 127
  - Troubleshooting Floppy Disks..... 128
  - Troubleshooting Printers ..... 129
  - Troubleshooting i.LINK Devices..... 131
  - Troubleshooting the Built-in MOTION EYE Camera..... 132
- Support Options ..... 135
  - Sony Support Information ..... 135
  - e-Support ..... 136
  - Trademarks ..... 138

## Before Use

Congratulations on your purchase of this Sony VAIO® computer, and welcome to the on-screen User Guide. Sony has combined leading-edge technology in audio, video, computing, and communications to provide state-of-the-art personal computing.

### Notice

© 2005 Sony Corporation. All rights reserved.

This manual and the software described herein, in whole or in part, may not be reproduced, translated, or reduced to any machine-readable form without prior written approval.

Sony Corporation provides no warranty with regard to this manual, the software, or other information contained herein and hereby expressly disclaims any implied warranties or merchantability or fitness for any particular purpose with regard to this manual, the software or such other information. In no event shall Sony Corporation be liable for any incidental, consequential, or special damages, whether based on tort, contract, or otherwise, arising out of or in connection with this manual, the software, or other information contained herein or the use thereof.

**Macrovision:** This product incorporates copyright protection technology that is protected by U.S. patents and other intellectual property rights. Use of this copyright protection technology must be authorized by Macrovision, and is intended for home and other limited viewing uses only unless otherwise authorized by Macrovision. Reverse engineering or disassembly is prohibited.

In the manual, the ™ or ® marks are not specified.

Sony Corporation reserves the right to make any modification to this manual or the information contained herein at any time without notice. The software described herein is governed by the terms of a separate user license agreement.

## ENERGY STAR

As an ENERGY STAR Partner, Sony has determined that this product meets the ENERGY STAR guidelines for energy efficiency. The International ENERGY STAR Office Equipment Program is an international program that promotes energy saving through the use of computers and their office equipment. The program backs the development and dissemination of products with functions that effectively reduce energy consumption. It is an open system in which business proprietors can participate voluntarily. The targeted products are office equipment such as computers, displays, printers, facsimiles and copiers. Their standards and logos are uniform among participating nations.

ENERGY STAR is a U.S. registered mark.



## Documentation

Your documentation includes printed information and user guides to read on your VAIO computer.

Guides are provided in PDF format, which you can easily browse through and print out.

The **My Club VAIO** portal is a perfect starting point to use your computer — a comprehensive collection of everything you need to get the most from your computer.

The user guides are collected under **Documentation**, which can be shown as follows:

- 1 Click **Start** and then the **My Club VAIO** icon .
- 2 Click **Documentation**.
- 3 Select the guide you want to read.



You can manually browse to the user guides by going to **My Computer > VAIO (C:)** (your C drive) > **Documentation > Documentation** and opening the folder for your language.

You may have a separate disc for the documentation of bundled accessories.

## Printed Documentation

- A Setting Up Poster** — Describes the process from unpacking to starting up your VAIO.
- Specifications Guide** — Contains a table of specifications and a list of bundled software.
- Troubleshooting Guide** — Contains solutions to common problems.
- Recovery Guide** — Contains an explanation of how to recover your computer's system if you need to.
- Booklets containing the following information: **Sony Guarantee** conditions, **Safety Regulations**, **Modem Regulations**, **Wireless LAN Regulations** and **Bluetooth Regulations**.

## Non-printed Documentation

### My Club VAIO

In **My Club VAIO** you can find:

**Documentation**, which gives you:

- Access to the **User Guide**. This manual explains the features of your computer in detail, how to use these features confidently and safely, connect peripheral devices and more.
- Access to **Help and Training**. This is the portal of **VAIO Help and Support Center**.
- Important information about your computer, in the form of notices and announcements.

In **My Club VAIO** you can also find:

- Accessories**  
Want to expand the capabilities of your computer? Click on this icon and have a look at your compatible accessories.
- Software**  
Feeling creative? Click this icon for an overview of your software and check out our upgrade options.
- Wallpapers**  
Click this icon and check out our most popular Sony and Club VAIO wallpapers.
- Links**  
Click this icon and check out our most popular Sony and Club VAIO web sites.



## Help and Support Center

**Help and Support Center** is a comprehensive resource for practical advice, tutorials, and demonstrations to help you learn to use Microsoft Windows XP and your computer.

Use the Search feature, Index, or table of contents to view all Windows Help resources, including those that are on the Internet.

To access **Help and Support Center**, click **Start** and then **Help and Support**. Or go to the **Help and Support Center** by pressing the Microsoft Windows key  and the **F1** key.

## Further Sources

- ❑ Consult the **Online Help** files of the software you are using for detailed information on features and troubleshooting.
- ❑ Go to [www.club-vaio.com](http://www.club-vaio.com) to find online tutorials about your favorite VAIO software.

## Ergonomic Considerations

You will be using your computer as a portable device in a variety of environments. Whenever possible, you should attempt to take account of the following ergonomic considerations to both stationary and portable environments:

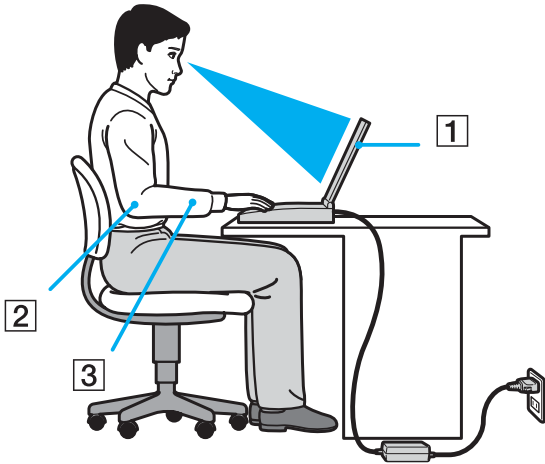

- ❑ **Position of your computer** – Place the computer directly in front of you (1). Keep your forearms horizontal (2), with your wrists in a neutral, comfortable position (3) while using the keyboard, touch pad, or external mouse. Let your upper arms hang naturally at your sides. Have breaks during sessions with your computer. Excessive use of the computer may strain muscles or tendons.
- ❑ **Furniture and posture** – Sit in a chair with good back support. Adjust the level of the chair so your feet are flat on the floor. A footrest may make you more comfortable. Sit in a relaxed, upright posture and avoid slouching forward or leaning far backwards.

- ❑ **Viewing angle of the computer's display** – Use the display's tilting feature to find the best position. You can reduce eye strain and muscle fatigue by adjusting the tilt of the display to the proper position. Adjust the brightness setting of the display as well.
- ❑ **Lighting** – Choose a location where windows and lights do not create glare and reflection on the display. Use indirect lighting to avoid bright spots on the display. You can also purchase accessories for your display that help reduce glare. Proper lighting adds to your comfort and work effectiveness.
- ❑ **Positioning an external display** – When using an external display, set the display at a comfortable viewing distance. Make sure the display screen is at eye level or slightly lower when you are sitting in front of the monitor.

# Getting Started

This section describes how to get started with using your VAIO computer.

- ❑ **Locating Controls and Ports** ([page 13](#))
- ❑ **About the Indicator Lights** ([page 20](#))
- ❑ **Connecting a Power Source** ([page 21](#))
- ❑ **Using the Battery Pack** ([page 22](#))
- ❑ **Shutting Down Your Computer Safely** ([page 26](#))

## Locating Controls and Ports

Take a moment to identify the controls and ports shown on the following pages.

! The following illustrations may appear different from your model, depending on the country or area of your residency.

## Front

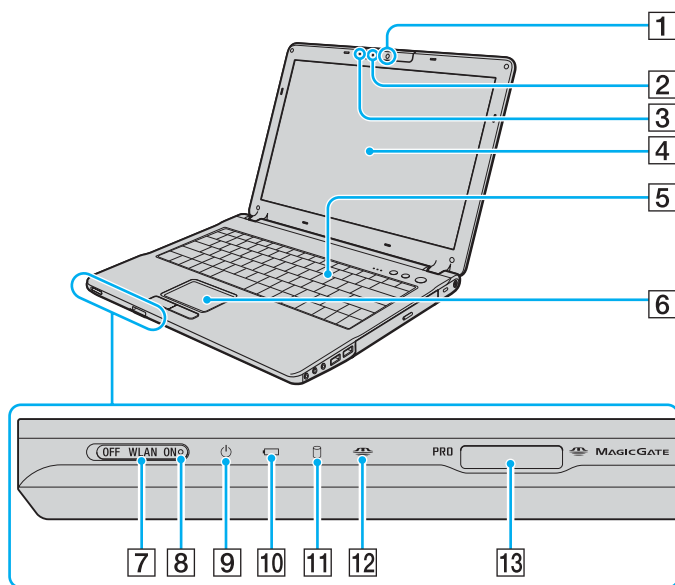

- 1 Built-in MOTION EYE camera ([page 32](#))
- 2 Built-in MOTION EYE camera indicator ([page 20](#))
- 3 Internal microphone (monaural)
- 4 LCD screen ([page 104](#))
- 5 Keyboard ([page 28](#))
- 6 Touch pad ([page 30](#))
- 7 **WLAN** (Wireless LAN) switch ([page 49](#))
- 8 **WLAN** (Wireless LAN) indicator ([page 20](#))
- 9 Power indicator ([page 20](#))
- 10 Battery indicator ([page 20](#))
- 11 Hard disk drive indicator ([page 20](#))
- 12 Memory Stick media indicator ([page 20](#))
- 13 Memory Stick media slot\* ([page 44](#))

\* Your computer supports Memory Stick Duo media and Memory Stick Pro high speed and high capacity capabilities.

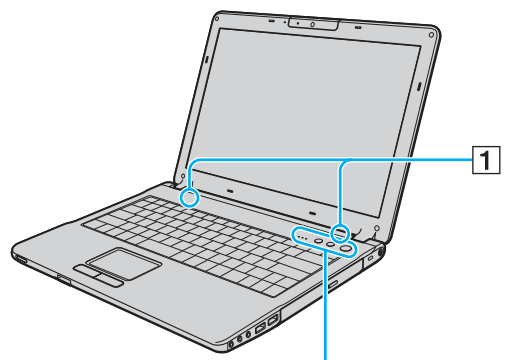

- 1 Speakers
- 2 Num lock indicator ([page 20](#))
- 3 Caps lock indicator ([page 20](#))
- 4 Scroll lock indicator ([page 20](#))
- 5 **S1/S2** buttons ([page 31](#))
- 6 Power button

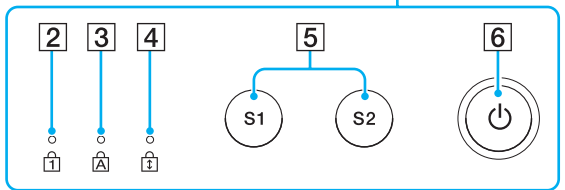

Back

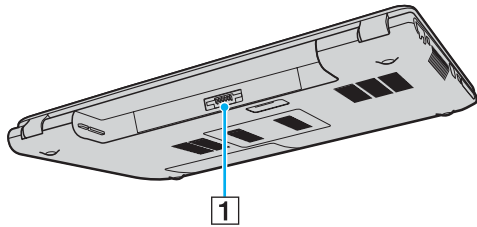

1 Battery connector ([page 22](#))



## Right

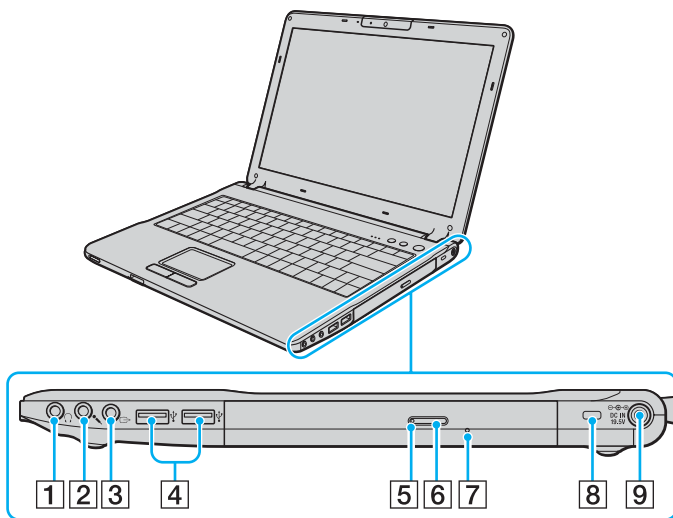

- 1 Headphones jack ([page 64](#))
- 2 Microphone jack ([page 74](#))
- 3 AV Out jack ([page 68](#))
- 4 Hi-Speed USB (USB 2.0) ports\* ([page 75](#))
- 5 Optical disc drive indicator ([page 20](#))
- 6 Drive eject button ([page 33](#))
- 7 Manual eject hole ([page 114](#))
- 8 Security slot
- 9 DC In port ([page 21](#))

\* Supports high-/full-/low- speeds.

## Left

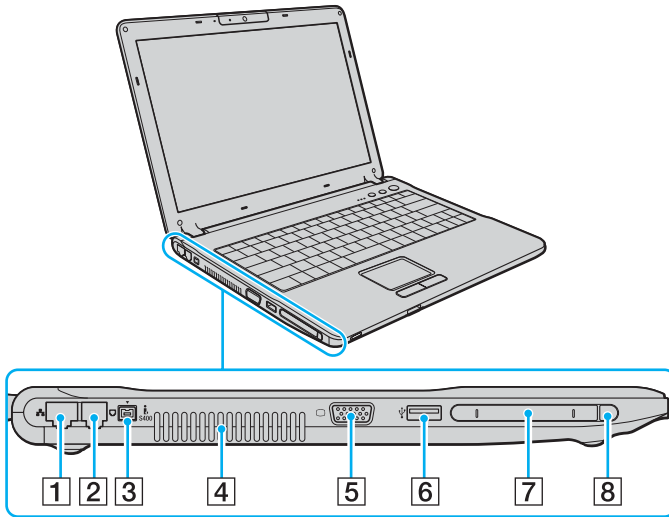

- 1 Network (Ethernet) port <sup>\*1</sup> (page 82)
- 2 Modem port (page 48)
- 3 i.LINK® (IEEE1394) S400 port (page 80)
- 4 Air vent
- 5 Monitor (VGA) port <sup>\*1</sup> (page 66)
- 6 Hi-Speed USB (USB 2.0) port <sup>\*2</sup> (page 75)
- 7 PC Card slot (page 41)
- 8 PC Card eject button (page 43)

<sup>\*1</sup> Disabled when the computer is attached to the optional port replicator.

<sup>\*2</sup> Supports high-/full-/low- speeds.  
Obstructed and unavailable when the computer is attached to the optional port replicator.



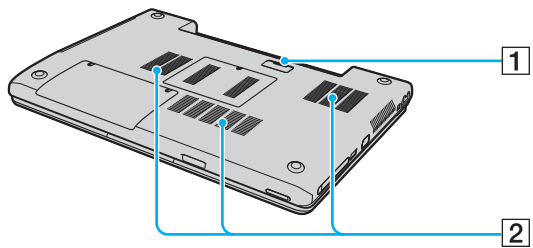



## Bottom



- 1 Port replicator connector ([page 60](#))
- 2 Air vents

## About the Indicator Lights

Your computer is equipped with the following indicator lights.

Indicator	Functions
Power 	Illuminates when the power to the computer is on, blinks in Standby mode, and turns off when the computer is in Hibernate mode or off.
Battery 	Illuminates when the computer is using battery power, blinks when the battery is running out of power, and double-blinks when the battery is charging.
Memory Stick Pro/Duo 	Illuminates when data is read from or written to the Memory Stick media. (Do not enter Standby mode or turn off the computer when this indicator is on.) When the indicator is off, the Memory Stick media is not being used.
Optical disc drive	Illuminates when data is read from or written to the optical disc. When the indicator is off, the optical disc is not being used.
Built-in MOTION EYE camera	Illuminates while the built-in MOTION EYE camera is in use.
Hard disk 	Illuminates when data is read from or written to the hard disk. Do not enter Standby mode or turn off the computer when this indicator is on.
Num lock 	Press the <b>Num Lk</b> key to activate the numeric keypad. Press it a second time to deactivate the numeric keypad. The numeric keypad is not active when the indicator is off.
Caps lock 	Press the <b>Caps Lock</b> key to type letters in uppercase. Letters appear in lowercase if you press the <b>Shift</b> key while the indicator is on. Press the key a second time to turn off the indicator. Normal typing resumes when the <b>Caps Lock</b> indicator is off.
Scroll lock 	Press the <b>Scr Lk</b> key to change how you scroll the display. Normal scrolling resumes when the <b>Scr Lk</b> indicator is off. The <b>Scr Lk</b> key functions differently depending on the program you are using and does not work with all programs.
WIRELESS LAN	Illuminates when the wireless LAN function is running.

## Connecting a Power Source

You can use either an AC adapter or a rechargeable battery pack as a power source for your computer.

### Using the AC Adapter



Use the computer only with the supplied AC adapter.

#### To use the AC adapter

- 1 Plug one end of the power cord (1) into the AC adapter (3).
- 2 Plug the other end of the power cord into an AC outlet (2).
- 3 Plug the cable attached to the AC adapter (3) into the DC In port (4) on the computer or on the (optional) port replicator.

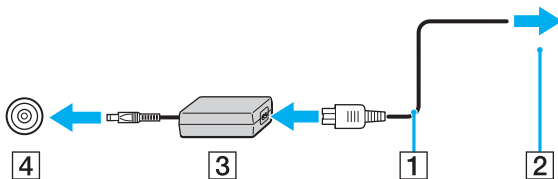

! The shape of the DC In plug varies depending on the AC adapter.



To disconnect the computer completely from AC power, unplug the AC adapter.

Make sure that the AC outlet is easily accessible.

If you do not use the computer for a long period of time, put the computer into Hibernate mode. See **Using Hibernate Mode** (page 92). This power saving mode saves you the time of shutting down in the normal way.

## Using the Battery Pack

The battery pack supplied with your computer is not fully charged at the time of purchase.

### Installing the Battery Pack

To install the battery pack

- 1 Turn off the computer and close the LCD screen lid.
- 2 Slide the lock switch (1) to the **UNLOCK** position.

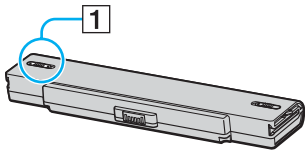

- 3 Slide the battery into the battery compartment until it clicks into place.

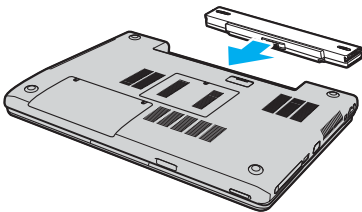

- 4 Slide the lock switch (1) to the **LOCK** position to secure the battery on the computer.



When the computer is directly connected to AC power and has a battery pack installed, it uses power from the AC outlet.

## Charging the Battery Pack

The battery pack supplied with your computer is not fully charged at the time of purchase.

To charge the battery pack

- 1 Install the battery pack.
- 2 Connect the AC adapter to the computer.  
The computer automatically charges the battery (the battery indicator light flashes in a double blink pattern as the battery charges). When the battery is about 85% charged, the battery indicator turns off.

Battery indicator light status	Meaning
On	The computer is using battery power.
Blinks	The battery is running out of power.
Double blinks	The battery is charging.
Off	The computer is using AC power.



When the battery is running out of power, both the battery and power indicator lights blink.

Keep the battery pack in the computer while it is directly connected to AC power. The battery pack continues to charge while you are using the computer.

If the battery level falls below 10%, you should either attach the AC adapter to recharge the battery or shut down the computer and install a fully charged battery.

The battery pack supplied with the computer is a lithium ion battery and can be recharged any time. Charging a partially discharged battery does not affect battery life.

The battery indicator light is on while you use the battery pack as a power source. When the battery life is nearly depleted, both the battery and power indicator lights start flashing.

For some software applications and some peripheral devices, the computer may not enter Hibernate mode even when battery life is low. To avoid loss of data when using battery power, you should save your data frequently and manually activate a power management mode, such as Standby or Hibernate. If the battery wears out when the computer enters Standby mode, you will lose any unsaved data. Going back to the previous work state is impossible. To avoid loss of data, you should save your data frequently.

When the computer is directly connected to AC power and has a battery pack installed, it uses power from the AC outlet.



## Removing the Battery Pack

! You may lose data if you remove the battery pack while the computer is on and not connected to the AC adapter or if you remove the battery while the computer is in Standby mode.

To remove the battery pack

- 1 Turn off the computer and close the LCD screen lid.
- 2 Slide the lock switch (1) to the **UNLOCK** position.

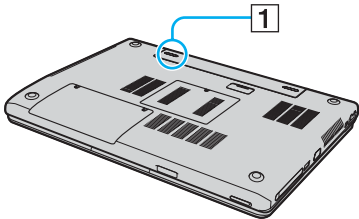

- 3 Slide and hold the release latch (2) and slide the battery away from the computer.

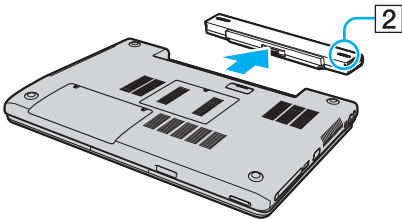

## Shutting Down Your Computer Safely

To avoid losing unsaved data, be sure to shut down your computer properly, as described below.

To shut down your computer

- 1 Turn off any peripherals connected to the computer.
- 2 Click **Start** and then **Turn Off Computer**.  
The **Turn off computer** window appears.
- 3 Click **Turn Off**.
- 4 Respond to any prompts warning you to save documents or to consider other users and wait for the computer to turn off automatically.

The power indicator light turns off.



See the printed **Troubleshooting Guide** if you have problems shutting down the computer.

# Using Your VAIO Computer

Once you have read and followed the information in the printed **Specifications Guide**, you can start using your computer safely and confidently.

Read on to get the most out of using your computer.

- ❑ **Using the Keyboard** ([page 28](#))
- ❑ **Using the Touch Pad** ([page 30](#))
- ❑ **Using Special-function Buttons** ([page 31](#))
- ❑ **Using the Built-in MOTION EYE Camera** ([page 32](#))
- ❑ **Using the Optical Disc Drive** ([page 33](#))
- ❑ **Using PC Cards** ([page 41](#))
- ❑ **Using the Memory Stick Media** ([page 44](#))
- ❑ **Using the Internet** ([page 48](#))
- ❑ **Using Wireless LAN (WLAN)** ([page 49](#))

## Using the Keyboard

Your keyboard is very similar to a desktop computer keyboard, but has additional keys that perform model-specific tasks. For more information on the standard keys, see **Help and Support Center** and click on the **Customizing your computer** link.



The VAIO-Link web site ([www.vaio-link.com](http://www.vaio-link.com)) also contains glossary information to help you use the keyboard.

## Combinations and Functions with the Fn Key



Some functions are not available until Windows is launched.

Combinations/Feature	Functions
<b>Fn</b> +  (F2): muting	Turns on and off the built-in speakers and the headphones.
<b>Fn</b> +  (F3/F4): volume	Adjusts the built-in speaker and headphone volume. To increase volume, press <b>Fn+F4</b> and then  or , or keep pressing <b>Fn+F4</b> . To decrease volume, press <b>Fn+F3</b> and then  or , or keep pressing <b>Fn+F3</b> .
<b>Fn</b> +  (F5/F6): brightness control	Adjusts the brightness of the LCD. To increase lightness intensity, press <b>Fn+F6</b> and then  or , or keep pressing <b>Fn+F6</b> . To decrease lightness intensity, press <b>Fn+F5</b> and then  or , or keep pressing <b>Fn+F5</b> .
<b>Fn</b> +  /  (F7): switch to the external display	Toggles between the LCD, external device (e.g. monitor) and both LCD and external device.

<b>Fn +  (F10): zoom</b>	<p>Changes the screen resolution to magnify/restore the screen view.</p> <p> The default resolutions of the standard view and the magnified view are as follows: Standard view: 1280 x 800 pixels Magnified view: 1024 x 600 pixels The magnified view is not as clear as the standard view, as it is implemented by applying a lower resolution to the LCD screen with a higher resolution. This key combination is disabled during video playback. Make sure to quit such software before pressing the key combination. This key combination may not work with graphic images as it magnifies the screen view by changing the resolution. The location and size of software windows may change when the screen view is magnified or the standard view is restored because pressing this key combination changes the resolution. When the LCD screen view is magnified, switching the view to the external display disables the function and restores the standard view.</p>
<b>Fn +  (F12): Hibernate</b>	<p>Provides for the lowest level of power consumption. When you execute this command, the states of the system and the peripheral devices are written to the hard disk and the system power is turned off. To return the system to its original state, use the power switch to turn on the power.</p> <p>For details on power management, see <b>Using the Power Saving Modes</b> (<a href="#">page 89</a>).</p>

## Using the Touch Pad

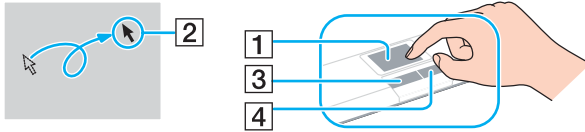

The keyboard contains a cursor-pointing device, the touch pad (1). You can point to, select, drag, and scroll objects on the screen using the touch pad.



Action	Description
Point	Slide one finger on the touch pad to place the pointer (2) on an item or object.
Click	Press the left button (3) once.
Double-click	Press the left button twice.
Right-click	Press the right button (4) once. In many applications, this action displays a shortcut menu.
Drag	Slide one finger while pressing the left button.
Scroll	Move your finger along the right edge of the touch pad to scroll vertically. Move your finger along the bottom to scroll horizontally (the scroll function is available only with applications that support a touch pad scroll feature).

## Using Special-function Buttons

Your computer is equipped with special buttons to help you use specific functions of the computer.

Special-function button	Functions
S1/S2 buttons  	By default, the <b>S1</b> button turns the volume on and off and the <b>S2</b> button toggles the display output between the LCD and external device. You can change these button assignments on the window for changing the <b>S</b> button assignments. To display this window, press and hold either button or launch and navigate through <b>VAIO Control Center</b> .

## Using the Built-in MOTION EYE Camera

The built-in MOTION EYE camera adds video functionality to interactive communication software, for example **Windows Messenger** and **Windows MovieMaker**.

Turning on the computer activates the built-in MOTION EYE camera, so the computer is ready for a video conference using such software.

Note that launching or exiting your interactive communication software does not activate or deactivate the MOTION EYE camera, respectively. Make sure that the camera is activated before using the software.



The built-in MOTION EYE camera cannot be shared by more than one software application. If another software application is using the camera, exit the application before using the built-in MOTION EYE camera.



The viewer window may show some noises, for example horizontal lines, if you view a rapid-moving object. This is normal and does not indicate a malfunction.



## Using the Optical Disc Drive

Your computer is equipped with an optical disc drive.

To insert a disc

- 1 Turn on the computer.
- 2 Press the drive eject button (1) to open the drive.  
The tray slides out.
- 3 Place a disc in the middle of the tray with the label side facing up and gently push until the disc clicks into place.

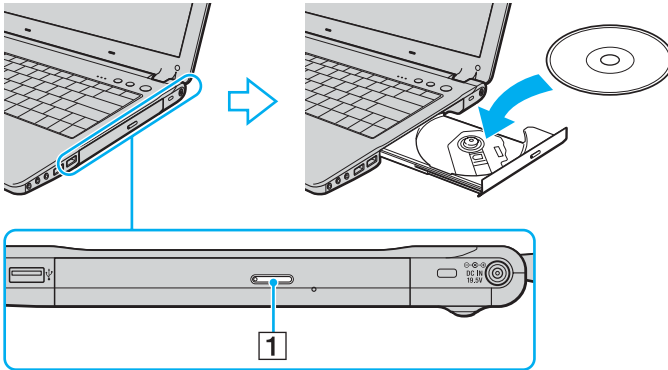

#### 4 Close the tray by pushing it in gently.

! Do not remove the optical disc when the computer is in a power saving mode (Standby or Hibernate). Doing so may cause the computer to malfunction.



If you plan to use an external optical disc drive, connect the drive before you launch any preinstalled CD/DVD program.

See the printed **Troubleshooting Guide** if you have problems using discs.

## Reading and Writing CDs and DVDs

Your computer plays and records CDs and DVDs, depending on the model you purchased. Check your specifications for the type of optical disc drive installed on your model. Use the table below to see which types of media your optical disc drive supports.

Optical disc drive	Plays	Records to
CD-ROM	CD, CD-R, and CD-RW	—
DVD-ROM	CD, CD-R, CD-RW, DVD and most DVD-R, DVD-RW, DVD+R, DVD+RW and DVD+R DL (Double Layer)*	—
CD-RW/DVD-ROM	CD, CD-R, CD-RW, DVD, most DVD-R, DVD-RW, DVD+R, DVD+R DL (Double Layer)* and DVD+RW	CD-R and CD-RW
DVD±RW	CD, CD-R, CD-RW, DVD, most DVD-R, DVD-RW, DVD+R, DVD+R DL (Double Layer)* and DVD+RW	CD-R, CD-RW, DVD-R, DVD-RW, DVD+R, DVD+R DL (Double Layer)* and DVD+RW

\* On selected models only.

**!** This product is designed to playback discs that conform to the Compact Disc Digital Audio standard specifications (CD Standard). A DualDisc is a two sided disc product which mates DVD recorded material on one side with digital audio material on the other side. Please be aware that the audio side (non-DVD side) of a DualDisc may not play on this product because it does not conform to the CD Standard.

**!** Due to the multiple formats of discs now available, when buying pre-recorded or blank discs for use with a VAIO computer, be sure to read the notices on the disc packaging carefully to check both playback and recording compatibility with your computer's optical disc drives. Sony does NOT guarantee the compatibility of VAIO CD drives with discs that not compliant with the official "CD" format standard (or "DVD" standard in relation to DVD drives). **USING NON-COMPLIANT DISCS CAN CAUSE FATAL DAMAGE TO YOUR VAIO PC OR CREATE SOFTWARE CONFLICTS AND CAUSE SYSTEM HANGING.** For inquiries about disc formats, contact the individual publisher of the pre-recorded disc or the manufacturer of the recordable disc.



Supports writing to DVD-RW discs compliant with DVD-RW version 1.1/1.2.

Supports writing to DVD-R discs compliant with DVD-R for General version 2.0/2.1.

Supports 8cm disc reading, but does not support 8cm disc writing.

Writing to DVD+R DL (Double Layer) discs is available only on discs supporting DVD+R DL (Double Layer) recording.

## Notes on writing data onto a disc

- To make the data on a disc readable on an optical disc drive, you need to close the session when you eject it. To complete this process, follow the instructions included with your software.
- Only use circular discs. Do not use discs in any other shape (star, heart, card, etc.), as this may damage the optical disc drive.
- Do not strike or shake the computer while writing data onto a disc.
- Deactivate the screen saver and exit anti-virus software before writing data onto a disc.
- Do not use memory-resident utility software while writing data to a disc. This may cause the computer to malfunction.
- When using your software application to burn discs, make sure you exit and close all other applications.
- Never touch the surface of the disc. Fingerprints and dust on the surface of a disc may cause writing errors.
- Do not switch power modes while using the pre-installed software and while using the CD burning software.
- Never put stickers on discs. This will affect the use of the disc irreparably.
- Connect and use the AC adapter to power the computer or make sure your battery is at least 50 percent charged.
- Some DVD players and computer's DVD drives may not be able to play DVDs created on applicable models using the **VAIO Zone** software.

## Notes on playing DVDs

To achieve optimum performance when playing DVDs, you should follow these recommendations.

- ❑ You can play DVDs using the optical disc drive and the DVD playback software, such as **VAIO Zone** or **WinDVD**. See the help file on such software for details.
- ❑ Close all open applications before playing a DVD movie.
- ❑ Do not use memory-resident utility software to speed up disc access when playing a DVD. This may cause the computer to malfunction.
- ❑ Deactivate the screen saver and exit anti-virus software before playing a disc.
- ❑ Some discs recorded at 20 or 24 bits may produce noise while playing. If you have audio devices connected, this may damage your hearing and the speakers. Reduce the volume before playing a DVD.
- ❑ Do not switch power saving modes while the computer is playing a DVD.
- ❑ Region codes indicators are labeled on the DVDs to indicate in which region and on what type of player you can play the disc. Unless a "2" (Europe belongs to region "2") or "all" (this means that you can play this DVD in most regions of the world) is labeled on your DVD disc or on the packaging, you cannot play the disc on this player.

!

If you change the DVD region code while the **WinDVD** software is running, restart the software or eject the disc and re-insert it to make the new setting effective.

- ❑ Do not try to change the region code settings of the DVD drive. Any difficulties caused by changing the region code settings of the DVD drive are out of warranty.
- ❑ If the computer has Wireless LAN and Wireless LAN is activated, playing DVDs may cause some interruptions in audio and video.
- ❑ When you are playing a DVD (video or audio) and you want to remove a USB device, such as USB-compatible speakers, make sure you stop the DVD first. Removing a USB-compatible device during DVD (video or audio) playback may cause a malfunction.

## Playing CDs

To play an audio CD

- 1 Insert the disc into the optical disc drive.
- 2 If nothing appears on the desktop once you insert an audio CD disc, then click **Start**, point to **All Programs**, and click to open a CD program, such as the **SonicStage** software.

If the **Audio CD** window appears, click to select an option.

## Copying Files to CDs

To determine which type of CD your computer supports, see **Reading and Writing CDs and DVDs** (page 35).

To copy files to a CD-RW or CD-R



Do not strike or shake the computer while writing data onto a disc.

- 1 Insert a blank CD-R or CD-RW disc into the optical disc drive.  
If the **CD Drive** window appears, click **Take no action**.
- 2 Open Windows Explorer by pressing the **Windows** key and the **E** key simultaneously.
- 3 In the **Folders** panel on the left, locate the file(s) or folder(s) you want to copy and either:
  - Right-click the file(s) or folder(s), point to **Send To**, and click the optical disc drive\* name.
  - Drag the file(s) or folder(s) onto the optical disc drive icon in the **Files Stored on This Computer** panel.
- 4 Close Windows Explorer.
- 5 Click **Start** and then **My Computer**.
- 6 Click the optical disc drive icon under **Devices with Removable Storage**. A new window appears with the file(s) or folder(s) you want to copy listed under **Files Ready to Be Written to the CD**.
- 7 In the **CD Writing Tasks** box, click **Write these files to CD**.
- 8 Follow the instructions in the **CD Writing Wizard**.

\* The read/write drive letter designation may vary, depending on your system's hardware configuration.

## Playing DVDs

To play a DVD

- 1 Close all open programs.
- 2 Insert the DVD into the optical disc drive.
- 3 Click **Start** and point to **All Programs**.
- 4 Select a DVD software program to play the DVD.

For instructions on how to use a program, see the help guide included with the DVD software program.

## Copying Files to DVDs

To copy files to a DVD-R or DVD-RW

- 1 Connect the AC adapter to the computer.
- 2 Insert the disc into the optical disc drive.
- 3 Click **Start** and point to **All Programs**.
- 4 Select a DVD software program you want to use from the submenu.

For instructions on how to use a program, see the help guide included with the DVD software program.



## Using PC Cards

PC Cards allow you to connect portable external devices to your computer.

### Inserting a PC Card

! Some PC Cards or their functions may not be compatible with the computer.

You do not need to shut down the computer before inserting or removing a PC Card.

#### To insert a PC Card

- 1 Hold the PC Card with the front label facing up.
- 2 Gently push the PC Card into the PC Card slot.  
The PC Card is automatically detected by your system.  
The **Safely Remove Hardware** icon appears on the taskbar.

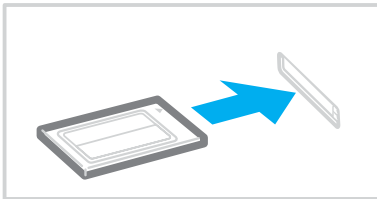



Some devices may not function properly if you continually switch to Normal mode from Standby mode or Hibernate mode. For some PC Cards, if you alternate between Normal mode and Standby or Hibernate mode while the card is inserted, you may find that a device connected to your system is not recognized. Restart your system to correct the problem. Restarting will restore the original state of the computer.

While the card is inserted, the computer may not enter Hibernate power management mode. It may enter Standby mode. We recommend that you remove the card before the computer enters Hibernate mode.

Make sure you use the most recent software driver provided by the PC Card manufacturer.

If an "!" mark appears on the **Device Manager** tab in the **System Properties** window, remove the software driver and then reinstall it.

Do not force a PC Card into the slot. It may damage the connector pins. If you have difficulty inserting a PC Card, check that you are inserting the PC Card in the correct direction. See the manual supplied with your PC Card for more information on use.

## Removing a PC Card

Follow the steps below to remove the PC Card while your computer is on. If it is not removed properly, your system may not work properly.

To remove a PC Card



To remove a PC Card when the computer is off, skip steps 1 to 7.

- 1 Double-click the **Safely Remove Hardware** icon on the taskbar.  
The **Safely Remove Hardware** window appears.
- 2 Select the hardware you want to unplug.
- 3 Click **Stop**.  
The **Stop a Hardware Device** window appears.
- 4 Confirm that the device can be safely removed from the system.
- 5 Click **OK**.  
A window appears, explaining that it is safe to remove the device.
- 6 Click **OK**.
- 7 Click **Close**.
- 8 Push the PC Card release button so that the release button pops out.
- 9 Push the PC Card release button a second time so that the PC Card pops out.
- 10 Gently take hold of the Card and pull it out of the slot.
- 11 If the PC Card release button is still out, push it back in.

## Using the Memory Stick Media

Your computer supports the Memory Stick media. Memory Stick media is a compact, portable, and versatile device especially designed for exchanging and sharing digital data with compatible products, such as digital cameras, mobile phones and other devices. Because it is removable, it can be used for external data storage.

See the printed **Specifications Guide** to see which Memory Stick media types are compatible with your model and if there are any limitations.

- You can purchase Memory Stick media from the Sony Style website ([www.sonystyle-europe.com](http://www.sonystyle-europe.com)), or from your local Sony dealer.
- Detailed information about which VAIO computers are compatible with which Memory Stick media can be found at [www.vaio-link.com](http://www.vaio-link.com).

## Write-protecting a Memory Stick Media

Some versions of Memory Stick media are designed with an erasure prevention switch to protect valuable data from accidental erasure or overwriting.

Move the tab horizontally or vertically\* to set or release write-protection. When the erasure prevention switch is off, data can be saved on the Memory Stick media. When the erasure prevention switch is on, data can be read from but not saved on the Memory Stick media.

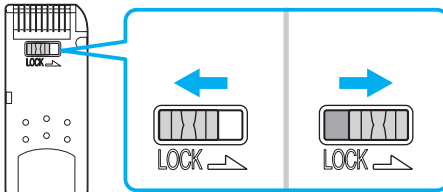

\* Some versions of Memory Stick media do not have an erasure prevention switch.

## Inserting a Memory Stick Media

There are two ways you can insert a Memory Stick media into your computer:

- ❑ Using the Memory Stick media slot;
- ❑ Using a PC Card slot. To do this, you need an optional PC Card adapter.

To insert a Memory Stick media using the Memory Stick media slot

- 1 Hold the Memory Stick media with the arrow facing up and toward the Memory Stick media slot.
- 2 Carefully slide the Memory Stick media into the slot until it clicks in place.

The Memory Stick media is automatically detected by your system and appears in your **My Computer** window as a local drive, under the appropriate letter (depending on the configuration of the computer).

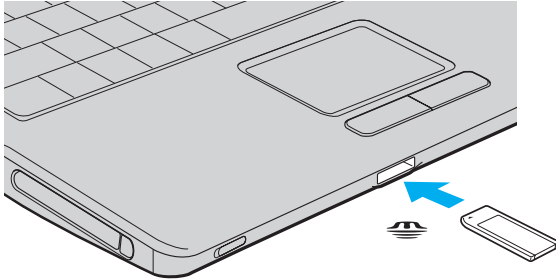

! Be sure to hold the Memory Stick media with the arrow pointing in the correct direction as you insert it into the slot. To avoid damaging the computer or the Memory Stick media, do not force the Memory Stick media into the slot if it does not insert smoothly.

Do not insert more than one Memory Stick media into the Memory Stick media slot. Inserting the media improperly may damage the computer.



The computer supports Memory Stick Duo media and is equipped with the Memory Stick combo slot that is compatible with both standard- and duo-size media. For more information on Memory Stick Duo media, visit the Memory Stick web site at <http://www.memorystick.com/en/>.

### To view the contents of the Memory Stick media

- 1 Click **Start** and then **My Computer** to open the **My Computer** window.
- 2 Double-click the Memory Stick media icon  to view the list of data files saved in the Memory Stick media.

### To format a Memory Stick media

Use the **Memory Stick Formatter** software. See the help file on the **Memory Stick Formatter** software for details.

## Removing a Memory Stick Media

To remove a Memory Stick media using the Memory Stick media slot

- 1 Check that the Memory Stick media indicator is off.
- 2 Push the Memory Stick media in toward the computer.  
The Memory Stick media ejects.
- 3 Pull the Memory Stick media out of the slot.

**!** Always remove the Memory Stick media gently, or it may pop out unexpectedly.

Do not remove the Memory Stick media while the Memory Stick media indicator is turned on. If you do, you may lose data. Large volumes of data may take time to load, so be sure the indicator is off before removing the Memory Stick media.

## Using the Internet

### Setting Up a Dial-up Internet Connection

Before you can connect to the Internet, you need to connect your computer to a telephone line via a telephone cable (not supplied). Once you set up your telephone cable, you're ready to connect to the Internet.

To connect a telephone cable

- 1 Plug one end of the phone cable (1) into the modem port  on the computer.
- 2 Plug the other end into the wall jack (2).

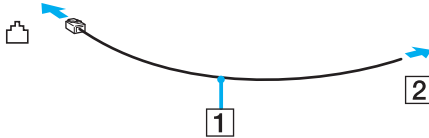

 The computer does not work with party lines, cannot be connected to a coin-operated telephone, and may not work with multiple telephone lines or a private branch exchange (PBX). Some of these connections may result in excess electrical current and could cause a malfunction in the internal modem.

If you connect a telephone cable coming through a splitter, the modem or connected device may not work properly.

To set up a dial-up connection to the Internet

- 1 Click **Start**, point to **All Programs, Accessories, Communications**, and click **New Connection Wizard**. The **New Connection Wizard** appears.
- 2 Click **Next**. If the **Location Information** window appears, follow the on-screen instructions.
- 3 If it is not already selected, click to select **Connect to the Internet**, and click **Next**.
- 4 Follow the on-screen instructions.



## Using Wireless LAN (WLAN)

Using the Sony Wireless LAN (WLAN), all your digital devices with built-in WLAN functionality communicate freely with each other through a powerful network. A WLAN is a network in which a user can connect to a local area network (LAN) through a wireless (radio) connection. So there is no need anymore to pull cables or wires through walls and ceilings.

The Sony WLAN supports all normal Ethernet activities, but with the added benefits of mobility and roaming. You can still access information, internet/intranet and network resources, even in the middle of a meeting, or as you move from one place to another.

You can communicate without an Access Point, which means that you can communicate between a limited number of computers (ad-hoc). Or you can communicate through an Access Point, which allows you to create a full infrastructure network (infrastructure).



In some countries, using WLAN products may be restricted by the local regulations (e.g. limited number of channels). Therefore, before activating the WLAN functionality, read the **Regulations Guide** carefully. Channel selection is explained further in this manual (see **Wireless LAN Channel Selection (page 57)**).

WLAN uses the IEEE802.11b/g standard, which specifies the used technology. The standard includes the encryption method: **Wired Equivalent Privacy** (WEP), which is a security protocol and **WiFi Protected Access** (WPA - Proposed jointly by the IEEE and Wi-Fi Alliance, WiFi Protected Access is a specification of standards based, interoperable security enhancements that increase the level of data protection and access control for existing WiFi networks. WPA has been designed to be forward compatible with the IEEE802.11i specification. It utilizes the enhanced data encryption TKIP (Temporal

Key Integrity Protocol) in addition to user authentication using 802.1X and EAP (Extensible Authentication Protocol)). Data encryption protects the vulnerable wireless link between clients and Access Points. Besides that, there are other typical LAN security mechanisms to ensure privacy, such as: password protection, end-to-end encryption, virtual private networks, and authentication.

Wireless LAN devices using the IEEE802.11a standard and the ones using the IEEE802.11b or g standard cannot communicate because the frequencies are different.

IEEE802.11b: The standard speed is 11 Mbps, or about 30 to 100 times faster than a standard dial up.

IEEE802.11a/g: The standard speed is 54 Mbps, or about 5 times faster than a Wireless LAN device using the IEEE802.11b standard.

## Communicating without an Access Point (Ad-hoc)

An ad-hoc network is a network in which a local network is created only by the wireless devices themselves, with no other central controller or Access Point. Each device communicates directly with other devices in the network. You can set up an ad-hoc network easily at home.

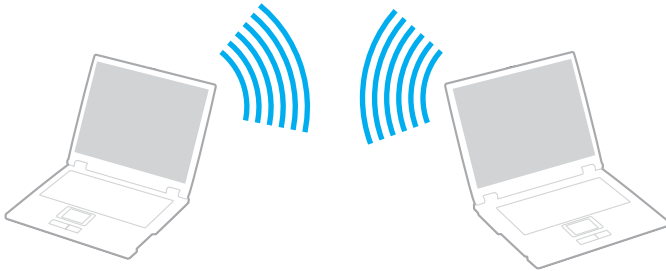

To communicate without an Access Point (ad-hoc)

- 1 Turn on the **WIRELESS** or **WIRELESS LAN** switch.

The WIRELESS LAN indicator lights up.

On models with the Bluetooth functionality<sup>\*1</sup>, double-click  ( / ) on the taskbar to display the **Wireless Device Switch** window. Select the **Enable 2.4 GHz Wireless LAN** check box and click **OK**.

- 2 Click **Start** and then **Control Panel**.

- 3 Click **Network and Internet Connections**.

- 4 Click **Network Connections**.

The **Network Connections** window appears.

- 5 Right-click **Wireless Network Connection**, then click **Properties**.

The **Wireless Network Connection Properties** window appears.

- 6 Select the **Wireless Networks** tab.

- 7 Click the **Add...** button.

The **Wireless network properties** window appears.

- 8 Enter a Network name (SSID)<sup>\*2</sup>.

You can choose a 32-digit alphanumeric name.

- 9 Select **Open** from the **Network Authentication** drop-down box.

- 10 Select **WEP** from the **Data Encryption** drop-down box.

- 11 Deselect the **The key is provided for me automatically** option button.

Some information becomes visible.

- 12 Enter the Network key<sup>\*2</sup>.

The network key should be 5 or 13 alphanumeric characters or 10 or 26 hexadecimal<sup>\*3</sup> characters long. You can choose whatever you want.

- 13 Enter exactly the same Network key again, for confirmation.
- 14 Select the check box **This is a computer-to-computer (ad hoc) network; wireless access points are not used** at the bottom of the screen.
- 15 Click **OK**.  
Your Network name appears in the **Preferred networks**.
- 16 Click **Advanced**.  
The **Advanced** window appears.
- 17 Select the **Computer-to-computer (ad hoc) networks only** option button.
- 18 Click **Close**.
- 19 Click **OK**.  
The computer is ready to communicate with another computer.

\*1 See the printed **Specifications Guide** to see whether your model supports the Bluetooth functionality.

\*2 If you want to communicate between two or more computers, you need to configure all these computers the exact same way. This means that you need to enter the same Network name and the same Network key on all computers as on the first computer you configure.

\*3 Hexadecimal: A number representation using the digits 0-9, with their usual meaning, plus the letters A-F (or a-f) to represent hexadecimal digits with values of (decimal) 10 to 15.



An ad-hoc network does not support WPA.



In France, only certain channels are legally allowed when using WLAN outdoors. For more information, see the **Regulations Guide**.

To disconnect from a computer-to-computer (ad-hoc) network



- 1 Click **Start** and then **Control Panel**.
- 2 Click **Network and Internet Connections**.
- 3 Click **Network Connections**.  
The **Network Connections** window appears.
- 4 In the right panel under **LAN or High-Speed Internet**, double-click **Wireless Network Connection**.  
The **Wireless Network Connection Status** window appears.
- 5 Click **Properties**.  
The **Wireless Network Connection Properties** window appears.
- 6 On the **Wireless Networks** tab, click **Advanced**.  
The **Advanced** window appears.
- 7 Click to select **Any available network (access point preferred)**, and click **Close**.
- 8 Click **OK**.
- 9 Click **Close**.
- 10 Turn off the **WIRELESS** or **WIRELESS LAN** switch.

## Communicating with an Access Point (Infrastructure)

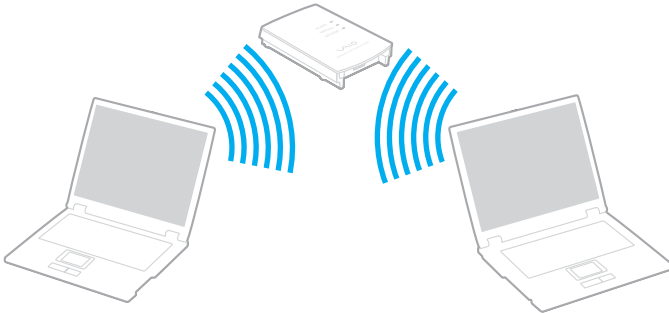
An infrastructure network is a network that extends an existing wired local network to wireless devices by providing an Access Point, for example the Sony Access Point. The Access Point bridges the wireless and wired LAN and acts as a central controller for the Wireless LAN. The Access Point coordinates transmission and reception from multiple wireless devices within a specific range.



## To connect to a wireless network

- 1 Turn on the **WIRELESS** or **WIRELESS LAN** switch.  
The WIRELESS LAN indicator lights up.  
On models with the Bluetooth functionality\*, double-click  ( / ) on the taskbar to display the **Wireless Device Switch** window. Select the **Enable 2.4 GHz Wireless LAN** check box and click **OK**.
- 2 Click **Start** and then **Control Panel**.
- 3 Click **Network and Internet Connections**.
- 4 Click **Network Connections**.  
The **Network Connections** window appears.
- 5 In the right panel under **LAN or High-Speed Internet**, double-click **Wireless Network Connection**.  
The **Wireless Network Connection** window appears.
- 6 Select the network you want to use.
- 7 Enter the Network Key.
- 8 Click **Connect**.  
After 30 seconds, the connection is established.

\* See the printed **Specifications Guide** to see whether your model supports the Bluetooth functionality.

For more information about setting up an access point, see the documentation supplied with your Access Point.



The WPA key needs to contain at least 8 characters.



## Wireless LAN Channel Selection

In an 802.11b/g configuration, channel 1 to 13 can be used.

### (a) With an Access Point ("Infrastructure")

- ❑ The channel used will be the channel selected by the Access Point.

! For details on how to select the channel that will be used by the Access Point, see the access point manual.

### (b) Without an Access Point ("ad-hoc")

- ❑ If the Wireless connection is initiated by the VAIO computer, channel 11 will be selected.

! In France, only certain channels are legally allowed when using WLAN outdoors. For more information, see the **Regulations Guide**.

- ❑ If the Wireless connection is initiated by a peer Wireless LAN equipment, the Wireless LAN communication will make use of the channel selected by the peer Wireless LAN equipment.



The 2.4 GHz bandwidth used by wireless LAN compatible devices is also used by other various devices. Although technologies to minimize interference from other devices that uses the same bandwidth are employed on wireless LAN compatible devices, such interference may cause lower communication speed, narrower communication range, or broken wireless connections.

The communication speed varies depending on the distance between communication devices, existence of obstacles between such devices, the device configuration, the radio conditions, and the software in use. In addition, communications may be cut off depending on the radio conditions.

The communication range varies depending on the actual distance between communication devices, existence of obstacles between such devices, the radio conditions, the ambient environment that includes existence of walls and materials of such walls, and the software in use.

Deploying IEEE802.11b and IEEE802.11g products on the same wireless network may reduce the communication speed due to radio interference.

Taking this into consideration, the IEEE802.11g products are designed to reduce the communication speed to ensure communications with IEEE802.11b products.

When the communication speed is not as fast as expected, changing the wireless channel on the access point may increase the communication speed.



In France, only certain channels are legally allowed when using WLAN outdoors. For more information, see the **Regulations Guide**.

# Using Peripheral Devices

You can add functionality to your computer by using the various ports on the computer.

- ❑ **Connecting a Port Replicator** ([page 60](#))
- ❑ **Connecting External Speakers** ([page 64](#))
- ❑ **Connecting an External Display** ([page 65](#))
- ❑ **Selecting Display Modes** ([page 71](#))
- ❑ **Using the Multiple Monitors Function** ([page 72](#))
- ❑ **Connecting an External Microphone** ([page 74](#))
- ❑ **Connecting a Universal Serial Bus (USB) Device** ([page 75](#))
- ❑ **Connecting a Printer** ([page 78](#))
- ❑ **Connecting an i.LINK Device** ([page 80](#))
- ❑ **Connecting to a Network (LAN)** ([page 82](#))

## Connecting a Port Replicator

Attaching a port replicator enables you to connect additional peripherals to your computer, such as a printer and an external display.

A port replicator may be supplied with your computer, depending on the model you purchased. If not, you can additionally purchase an optional port replicator.

See the printed **Specifications Guide** to see whether your model is supplied with a port replicator.

### Locating Ports on the Port Replicator

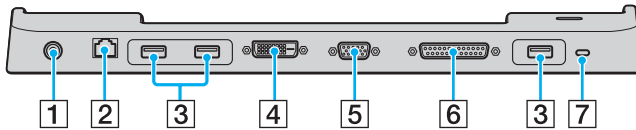

- 1 DC In port ([page 21](#))
  - 2 Network (Ethernet) port (100BASE-TX / 10BASE-T) ([page 82](#))
  - 3 Hi-Speed USB (USB 2.0) ports\* ([page 75](#))
  - 4 DVI-D port ([page 66](#))
  - 5 Monitor (VGA) port ([page 66](#))
  - 6 Printer port ([page 79](#))
  - 7 Security slot
- \* Supports high-/full-/low- speeds.

**!** The port replicator can be powered only through the AC adapter supplied with the computer. Do not unplug the AC adapter from the port replicator and the AC outlet while using the port replicator; this may cause data damage or hardware malfunctions.



The printer port on the port replicator is intended for printer connections only.

## Attaching Your Computer to the Port Replicator

To attach your computer to the port replicator

- 1 Disconnect all peripherals from the computer.
- 2 Plug the power cord (1) into the AC adapter (2) and an AC outlet.
- 3 Plug the cable attached to the AC adapter (2) into the DC In port (3) on the port replicator (4).

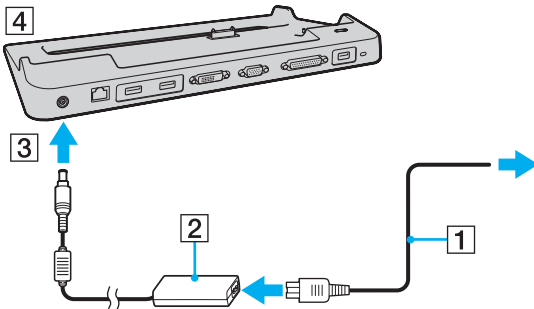

- 4 Open the port replicator connector cover.

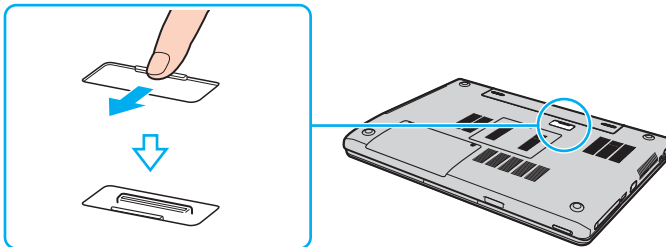

- 5 Align the bottom connector of the computer with the connector on the port replicator and push down until it clicks into place.

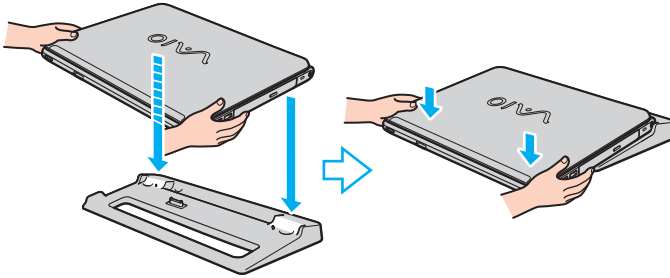

- 6 Turn on the computer.

**!** Use the AC adapter supplied with the computer.

Do not move the computer while attached to the port replicator; this may detach the port replicator and cause damage to the port replicator and the computer.

## Disconnecting Your Computer from the Port Replicator



To prevent loss of unsaved data, be sure to turn off the computer before disconnecting it from the port replicator.

To disconnect your computer from the port replicator

- 1 Turn off the computer and the connected peripherals.
- 2 Lift the computer away from the port replicator.

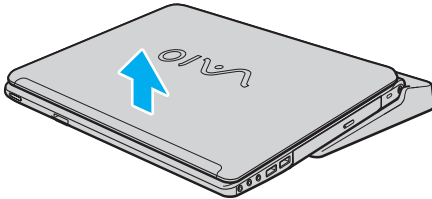

- 3 Close the port replicator connector cover on the bottom of the computer.



It is extremely important to close the port replicator connector cover after disconnecting the computer from the port replicator. If the cover is left open, dust may get inside and damage the computer.

To disconnect the port replicator completely from AC power, unplug the AC adapter.

## Connecting External Speakers

You can enhance the sound quality of your computer by connecting external speakers.

To connect external speakers

- 1 Plug the speaker cable (1) into the headphones jack (2) .
- 2 Plug the other end of the speaker cable to the external speaker (3).
- 3 Turn down the volume of the speakers before you turn them on.

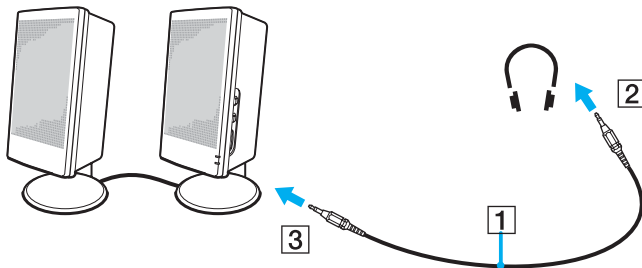

Make sure your speakers are designed for computer use.



Do not place floppy disks on the speakers; their magnetic field may damage the data on the disks.



## Connecting an External Display

You can connect an external display to your computer. For example, you can use the computer with a computer display or a projector.

- ❑ **Connecting a Computer Display** ([page 66](#))
- ❑ **Connecting a Multimedia Computer Display** ([page 67](#))
- ❑ **Connecting a TV** ([page 68](#))
- ❑ **Connecting a Projector** ([page 70](#))



Connect the power cord after connecting all other cables.

Connected external displays are used as second screens.

On Windows systems only, you can also use an external display to set up multiple monitors.



When the computer is attached to the optional port replicator, you can only use the VGA port on the port replicator.

## Connecting a Computer Display

You can connect a computer display (monitor) either directly to your computer or via the (optional) port replicator.

To connect a computer display

- 1 If necessary, plug one end of the display's power cord (1) into the display, and the other end into an AC outlet.
- 2 If you want to connect a VGA monitor, plug the display cable (2) (not supplied) into the monitor (VGA) port (3)  on the computer or on the port replicator.
- 3 If you want to connect a TFT/DVI monitor, plug the display cable (not supplied) into the DVI-D port on the port replicator.

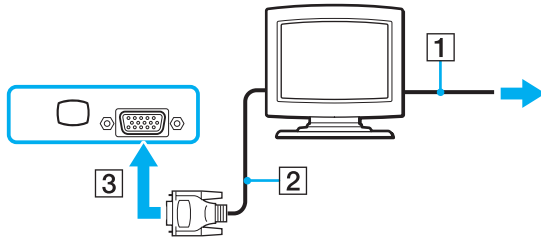

**DVI-D** stands for Digital Visual Interface - Digital. It is a type of DVI connector that supports only digital video signals (no analog video signals). It has 24 pins.

A **DVI-I** connector (Digital Visual Interface - Integrated) supports digital video and analog video signals. It has 29 pins.



A video adapter device is required to connect a VGA monitor using the DVI-D port.

## Connecting a Multimedia Computer Display

You can connect a multimedia computer display that includes built-in speakers and a microphone to your computer or via the (optional) port replicator.

To connect a multimedia computer display

- 1 Plug the power cord of the multimedia computer display (1) into an AC outlet.
- 2 Plug the display cable (2) (not supplied) into the monitor (VGA) port (3) □ on the computer or on the port replicator.
- 3 Plug the speaker cable (4) into the headphones jack (5) 🎧 on the computer.
- 4 Plug the microphone cable (6) into the microphone jack (7) 🎤 on the computer.

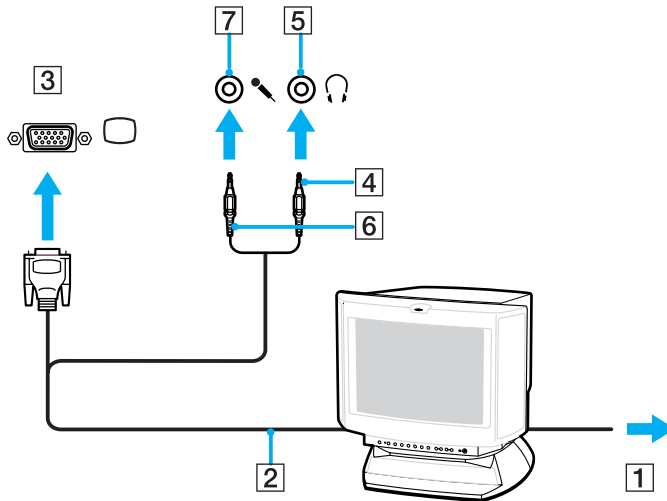

## Connecting a TV

You can connect a TV to your computer.

To connect a TV to the computer

- 1 Plug the power cord of the TV (1) into an AC outlet.
- 2 Plug one end of an audio/video cable (2) into the AV Out jack (3) ↗ on the computer and the other to the TV.
- 3 Switch the input channel of the TV to external input.
- 4 Set up the TV configuration system.

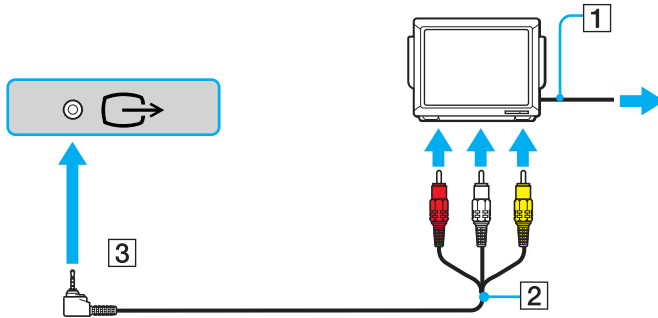

You need to use an AV cable that has a minijack connector on one end and 3 RCA (also called cinch) connectors on the other end. If your TV does not have RCA connectors, but it has a Scart connector, you need an RCA to Scart converter. If your computer has an S VIDEO port, you can use this port as an alternative means of connection.



See the manual supplied with your peripheral for more information on installation and use.

If the display resolution of the computer is more than 1024 x 768 pixels, a part of the image cannot be displayed on your TV. The hidden area on your TV can be seen by moving the cursor on the computer. If you want to display the full image, change the display resolution of the computer to 1024 x 768 pixels or lower.

## Connecting a Projector

You can connect a projector (for example, the Sony LCD projector) directly to your computer or via the (optional) port replicator.

To connect a projector

- 1 Connect the power cord (1) of the projector into an AC outlet.
- 2 Plug the RGB signal cable (2) into the monitor (VGA) port (3) □ on the computer or on the port replicator.
- 3 Plug the audio cable (4) (not supplied) into the headphones jack (5) ♪.
- 4 Plug the RGB signal cable and the audio cable into the jack and port on the projector (6).

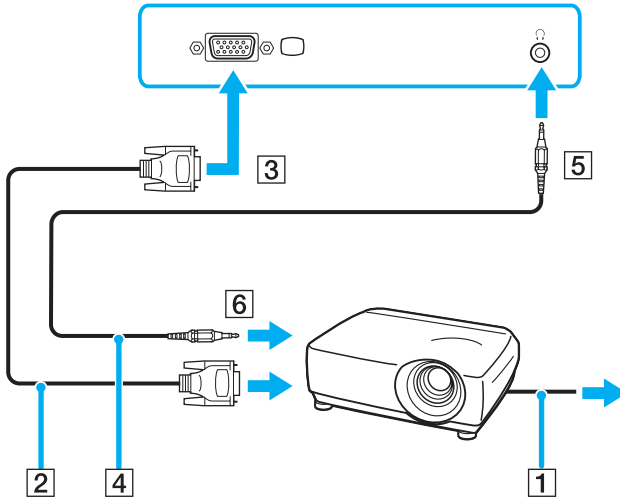

## Selecting Display Modes

You can select which display to be used as the primary monitor when an external display (desktop monitor, etc.) is connected to your computer.

If you want to work on the computer's LCD and the external display at the same time, see **Using the Multiple Monitors Function (page 72)** for more information.

To select a display

- 1 Right-click on the desktop to display the context menu.
- 2 Click **Graphic Properties**.
- 3 Select a display from the **Display Devices** menu.
- 4 Click **OK**.



You may not be able to display on the computer's LCD and the external display or projector at the same time, depending on the type of your external display or projector.

Before turning on the computer, turn on the peripheral devices.

## Using the Multiple Monitors Function

The Multiple Monitors function allows you to distribute portions of your desktop across separate displays. For example, if you have an external display attached to the monitor (VGA) port, your computer's LCD and the external display can function as a single desktop.

You can move the cursor from one display to the other. This allows you to drag objects, such as an open application window or a toolbar, from one display to the other.

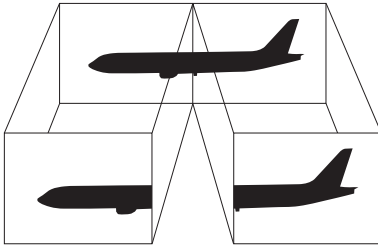

Your external display may not support the Multiple Monitors function.

Certain software applications may not be compatible with Multiple Monitors settings.

Make sure that the computer does not enter Standby or Hibernate mode while you are using Multiple Monitors mode; otherwise the computer may not return to Normal mode.

If you set different colors on each display, do not divide one single window on two displays; otherwise your software may not work properly.

Set fewer colors or a lower resolution for each display.



To select the Multiple Monitors mode

- 1 Right-click on the desktop to display the context menu.
- 2 Click **Graphics Properties**.
- 3 Select **Extended Desktop** from the **Display Devices** menu.  
To change the primary and secondary device settings, use the **Primary Device** and **Secondary Device** drop-down lists under **Multiple Display**.
- 4 Click **OK**.  
If the **Monitor Settings** window appears, click **OK**.



You can also change one of the **S** button assignments to activate the Multiple Monitors mode with the respective **S** button. To change the **S** button assignments, press and hold any **S** button to display the window for changing the assignment. For details on the **S** buttons, see **Using Special-function Buttons (page 31)**.



Additionally, you can set the display colors and resolution for each display and customize the Multiple Monitors mode.

## Connecting an External Microphone

If you need to use a sound input device (for example, to chat on the Internet) you need to plug in an external microphone.

To connect an external microphone

Plug the microphone cable (1) into the microphone jack (2) .

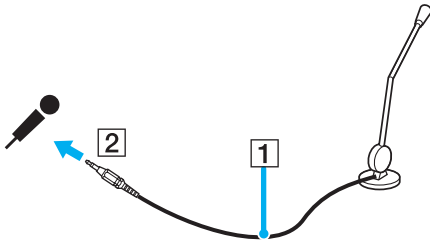

Make sure your microphone is designed for computer use.

## Connecting a Universal Serial Bus (USB) Device

To prevent your computer and/or USB devices from damage, observe the following:

- ❑ When moving the computer with USB devices connected, avoid any shock or force to the USB ports.
- ❑ Do not put the computer into a bag or carrying case when it has USB devices connected.

### Connecting a USB Mouse

To connect a USB mouse

- 1 Choose the USB port (1)  you prefer to use.
  - 2 Plug the USB mouse cable (2) into the USB port.
- You can now use your USB mouse (3).

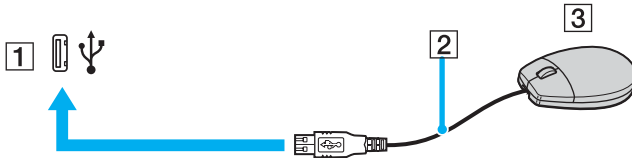

The VAIO USB mouse software driver is preinstalled on the computer. As a result, you only need to plug the USB mouse into the USB port and you can start working.

## Connecting a USB Floppy Disk Drive

You can purchase a USB floppy disk drive and connect it to your computer.

To connect a USB floppy disk drive

- 1 Choose the USB port  you prefer to use.
- 2 Plug the USB floppy disk drive cable into the USB port.  
Your USB floppy disk drive is now ready for use.

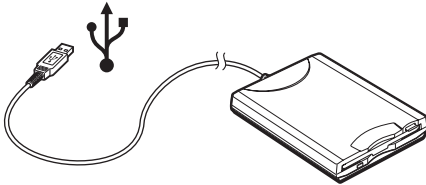

**!** When using a USB floppy disk drive, do not apply force on the USB port. This may cause a malfunction.

## Disconnecting a USB floppy disk drive

You can disconnect a USB floppy disk drive when the computer is on or off. Disconnecting the drive when the computer is in a power saving mode (Standby or Hibernate) may cause the computer to malfunction.

If the computer is off, you can unplug the USB cable directly from the computer.

### To disconnect a USB floppy disk drive

- 1 Close all programs accessing the floppy disk drive.
- 2 Double-click the **Safely Remove Hardware** icon on the taskbar.  
The **Safely Remove Hardware** window appears.
- 3 Select the floppy disk drive you want to unplug.
- 4 Click **Stop**.  
The **Stop a Hardware device** window appears.
- 5 Make sure the floppy disk drive is selected, and click **OK**.  
A message appears stating it is now safe to remove the hardware device.
- 6 Remove the floppy disk drive from the computer.

## Connecting a Printer

You can connect a Windows-compatible printer to your computer to print documents.

### Connecting a Printer Using the USB Port

You can connect a USB printer compatible with your version of Windows to the computer.

To connect a printer using the USB port

- 1 Plug the printer power cord into an AC outlet (1).
- 2 Choose the USB port (3)  you prefer to use.
- 3 Plug one end of a USB printer cable (2) into the USB port and the other end to your printer.

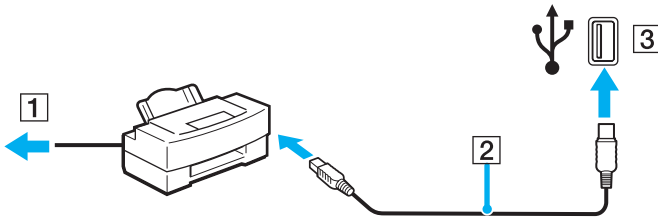

## Connecting a Printer Using the Printer Port

To connect a printer using the printer port

- 1 Plug the printer power cord (1) into an AC outlet.
- 2 Plug the printer cable (2) supplied with your printer into the printer port (3)  on the (optional) port replicator.

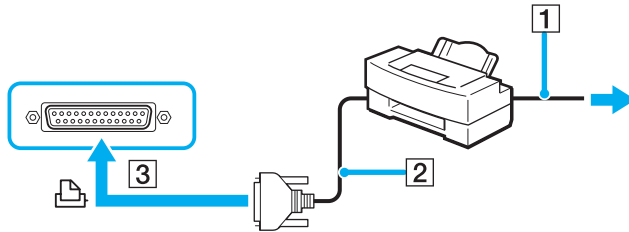

Before connecting the printer, turn off the computer and the printer, and unplug the AC adapter and the power cord.

## Connecting an i.LINK Device

### Notes on connecting i.LINK devices

- ❑ The computer includes an i.LINK (IEEE1394) port, which you can use to connect to an i.LINK device such as a digital video camera recorder or to connect two VAIO computers in order to copy, delete or edit files.
- ❑ The i.LINK port of the computer does not supply power to external devices generally powered by i.LINK ports.
- ❑ The i.LINK port supports transfer rates up to 400 Mbps; however, the actual transfer rate depends on the transfer rate of the external device.
- ❑ i.LINK cables compatible with the computer include cables with the following part numbers:  
VMC-IL4415 (a 1.5 meter cable with a 4-pin connector at each end), VMC-IL4408 Series (a 0.8 meter cable with a 4-pin connector at each end).
- ❑ The optional i.LINK cables may not be available, depending on your country or region.
- ❑ An i.LINK connection with other compatible devices is not fully guaranteed.
- ❑ The i.LINK connection varies depending on the software applications, operating system and i.LINK compatible devices you use. Refer to the manual that came with your software for more information.
- ❑ Check the working conditions and OS compatibility of i.LINK-compatible PC peripherals (for example, an HDD or CD-RW drive) before you connect them to the computer.



## Connecting a Digital Video Camera Recorder

To connect a digital video camera recorder

- 1 Plug one end of the i.LINK cable (1) into the i.LINK port (2) on the computer and the other end into the DV In/Out ports (3) on the digital video camera recorder.
- 2 Launch the **DVgate Plus** software.

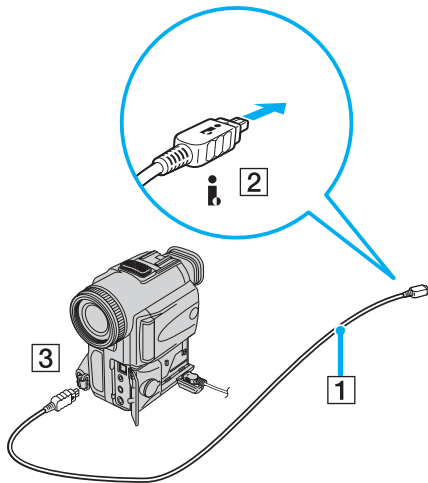

On Sony digital video cameras, ports labeled **DV Out**, **DV In/Out** or **i.LINK** are i.LINK-compatible.

The Sony digital video camera recorder shown here is an example; your digital video camera recorder may need to be connected differently.

You cannot access the pictures stored on a Memory Stick media when using an i.LINK connection.

## Connecting to a Network (LAN)

You can connect your computer to 100BASE-TX/10BASE-T-type networks via an Ethernet network cable. Connect one end of an optional network cable to the Network (Ethernet) port on the computer or the (optional) port replicator and the other end to your network. For detailed settings and devices needed to connect to the network, see your network administrator.

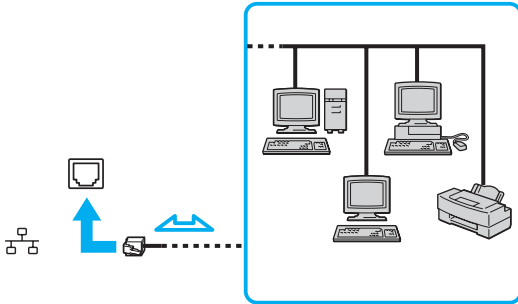

The computer can be connected to the network with the default settings.

When the computer is attached to the optional port replicator, you can only use the Network (Ethernet) port on the port replicator.

! Telephone lines cannot be connected to the Network (LAN) connector on your computer. If the Network (LAN) connector is connected to the telephone lines mentioned below, high electric current to the connector may cause damage, overheating or fire.

- Home (intercom speakerphone) or business-use telephone lines (multi-line business telephone)
- Public telephone subscriber line
- PBX (private branch exchange)

! Do not plug a telephone cable into the network port.

# Customizing Your VAIO Computer

This section briefly describes how to change the main settings of your computer. Among other things, you will learn how to prepare your modem for use, how to use and customize the look of your Sony software and utilities, etc.

- ❑ **Setting the Password** ([page 85](#))
- ❑ **Setting Up Your Computer with VAIO Control Center** ([page 88](#))
- ❑ **Using the Power Saving Modes** ([page 89](#))
- ❑ **Managing Power with VAIO Power Management** ([page 94](#))

## Setting the Password

Use one of the BIOS functions to set the password.

Once you have set the password, you will have to enter the password after the VAIO logo appears to start your computer. The power-on password will allow you to protect your computer from unauthorized access.

## Adding the Power-on Password



Once you have set the power-on password, you cannot start the computer without entering the password. Make sure not to forget the password. Write down your password and keep it safe and private from other people.

If you forget the power-on password and need assistance to reset, a password reset fee will be charged, and your computer may need to be sent in for depot service for password reset.

### To add the power-on password

- 1 Turn on the computer.
- 2 Press the **F2** key when the VAIO logo appears.  
The BIOS setup screen appears. If not, restart the computer and press the **F2** key several times when the VAIO logo appears.
- 3 Use the **←** or **→** key to select **Security** to display the **Security** tab, select **Set Machine Password**, and then press the **Enter** key.
- 4 On the password entry screen, enter the password twice and press the **Enter** key.  
The password can be up to 32 alphanumeric characters (including spaces) long.



The following is to configure the computer to prompt password entry when you turn it on or display the BIOS setup screen.

- 5 Select **Password When Power ON** under **Security**.  
Press the space bar to change the setting from **Disabled** to **Enabled**.
- 6 Use the **←** or **→** key to select **Exit** and select **Exit (Save Changes)**; and then press the **Enter** key.  
On the **Setup Confirmation** screen, make sure that **Yes** is selected and then press the **Enter** key.

## Changing/Removing the Power-on Password

To change or remove the power-on password

- 1 Turn on the computer.
- 2 Press the **F2** key when the VAIO logo appears.  
The BIOS setup screen appears. If not, restart the computer and press the **F2** key several times when the VAIO logo appears.
- 3 Enter the current password for **Enter Password**:
- 4 Use the **←** or **→** key to select **Security** to display the **Security** tab, select **Set Machine Password**, and then press the **Enter** key.
- 5 On the password entry screen, enter the current password once and a new password twice, and then press the **Enter** key.  
To remove the password, leave the **Enter New Password** and **Confirm New Password** fields blank and press the **Enter** key.
- 6 Use the **←** or **→** key to select **Exit** and select **Exit (Save Changes)**; and then press the **Enter** key.  
On the **Setup Confirmation** screen, confirm that **Yes** is selected and then press the **Enter** key.

## Setting Up Your Computer with VAIO Control Center

The **VAIO Control Center** utility allows you to consult system information and specify preferences for system behavior.

To use VAIO Control Center

- 1 Click **Start**, point to **All Programs**, and click **VAIO Control Center**.  
The **VAIO Control Center** window appears.
- 2 Select the desired control item and change the settings.
- 3 Once finished, click **OK**.  
The setting of the desired item has been changed.



For more information about each option, click **Help** on the **VAIO Control Center** window to display the help file.

Some of the control items will not be visible if you open **VAIO Control Center** as a limited user.



## Using the Power Saving Modes

When you use a battery as the power source for your computer, you can take advantage of power management settings to conserve battery life. In addition to the normal operating mode, which allows you to turn off specific devices, your computer has two distinct power saving modes: Standby and Hibernate. When using battery power, you should be aware that the computer automatically enters Hibernate mode when the remaining battery charge becomes short, regardless of the power management setting you select.



If the battery level falls below 10 percent, you should either attach the AC adapter to recharge the battery or shut down the computer and install a fully charged battery.

## Using Normal Mode

This is the normal state of the computer when it is in use. The green power indicator light is on in this mode. To save power while not working, you can turn off a specific device such as the LCD or the hard disk.

## Using Standby Mode

Standby mode turns off the LCD screen and sets the hard disk and the CPU to a low power consumption mode. The amber power light flashes in this mode.

To activate Standby mode

- 1 Click **Start** and then **Turn Off Computer**.
- 2 Click **Stand By**.

To return to Normal mode

Press any key.

! If you press the power button for more than four seconds, the computer will switch off automatically. You will lose any unsaved data.



When the computer is in Standby mode, you cannot insert a disc.

The computer comes out of Standby mode quicker than out of Hibernate mode.

Standby mode uses more power than Hibernate mode.

You can use **VAIO Control Center** to configure the computer to return to Normal mode when you open the LCD screen lid. This power resuming setting will be lost if you remove both the AC adapter and the battery. See **Setting Up Your Computer with VAIO Control Center (page 88)**.

! If the battery runs down when the computer enters Standby mode, you will lose any unsaved data. Going back to the previous work state is impossible. To avoid loss of data, you should save your data frequently.

If the computer is not used for 25 minutes, it will enter Standby mode. To avoid this, you can change the Standby mode settings.

To change the Standby mode settings

- 1 Click **Start** and then **Control Panel**.
- 2 Click **Performance and Maintenance**.
- 3 Click **Power Options**.  
The **Power Options Properties** window appears.
- 4 Select the **Power Schemes** tab.
- 5 Change the **System Standby** settings.

## Using Hibernate Mode

In Hibernate mode, the state of the system is saved on the hard disk and power is turned off. Even when the battery runs down, no data will be lost. The power indicator light is off in this mode.

To activate Hibernate mode

Press the **Fn+F12** keys.

The **Hibernating** screen appears and the computer enters Hibernate mode.

Alternatively,

- 1 Click **Start** and then **Turn Off Computer**.
- 2 Click **Hibernate**.

To return to Normal mode

Turn on the computer by pressing the power button.

The computer returns to its previous state.

! If you press the power button for more than four seconds, the computer will switch off automatically.



If you do not use the computer for a long period of time, put the computer into Hibernate mode. This power saving mode saves you the time of shutting down in the normal way.

When the computer is in Hibernate mode, you cannot insert a disc.

Hibernate mode requires more time than Standby mode to be activated.

It takes more time to return to Normal mode from Hibernate mode than from Standby mode.

Hibernate mode uses less power than Standby mode.

You can use **VAIO Control Center** to configure the computer to return to Normal mode when you open the LCD screen lid. This power resuming setting will be lost if you remove both the AC adapter and the battery. See **Setting Up Your Computer with VAIO Control Center** ([page 88](#)).



Do not move the computer until its power indicator light turns off.

## Managing Power with VAIO Power Management

Power management helps you to set up power schemes for running on AC power or batteries to suit your requirements for power consumption.

**VAIO Power Management** is a software application developed exclusively for VAIO computers. With this software application, you can enhance the Windows power management functions to ensure better operations of your computer and for longer battery life. For more information on **VAIO Power Management**, see the help file on the **VAIO Power Management** software.

### Activating VAIO Power Management

When you start the computer, a **power status** icon appears on the taskbar. This icon indicates what kind of power source you are using at that time, for example, AC power. If you double-click this icon, the **Power Meter** window appears showing you the power status.

VAIO Power Management functionalities are added to the Windows **Power Options Properties**.

To activate VAIO Power Management

- 1 Click **Start** and then **Control Panel**.
- 2 Click **Performance and Maintenance**.
- 3 Click **Power Options**.  
The **Power Options Properties** window appears.
- 4 Select the **VAIO Power Management** tab.

To restore the default settings

- 1 On the **VAIO Power Management** tab, click **Advanced**.  
The **VAIO Power Management** window appears.
- 2 Follow the on-screen instructions to change the settings.

## Activating VAIO Power Management Power Schemes

**VAIO Power Management** provides several predefined **power schemes**. Each power scheme consists of a group of power management settings that are designed to meet specific power management goals, ranging from maximum power management to no power management.

To activate a VAIO Power Management power scheme

- 1 Click **Start** and then **Control Panel**.
- 2 Click **Performance and Maintenance**.
- 3 Click **Power Options**.  
The **Power Options Properties** window appears.
- 4 Select the **Power Schemes** tab.
- 5 Select a power scheme from the **Power schemes** drop-down list.
- 6 If you now select the **VAIO Power Management** tab, you see that the selected power scheme appears to the right of **Power Scheme**.
- 7 If necessary, you can change the items in the list, for example, the brightness of the LCD.
- 8 Click **OK**.  
The power scheme has been activated.



You must have administrator rights on the computer to set up a power scheme.

For more information on **VAIO Power Management** and **Power Schemes**, see the help guide of the **VAIO Power Management** software.

## Upgrading Your VAIO Computer

Your computer and memory modules use high precision components and electronic connectors technology. To avoid the invalidation of your guarantee due to mishandling, we recommend that:

- You contact your dealer to install a new memory module.
- You do not install it yourself, if you are not familiar with upgrading memory on a computer.
- You do not touch the connectors or open the memory panel.

For the type of module and amount of memory installed on your model, refer to the printed **Specifications Guide**.

Contact VAIO-Link if you need assistance.



## Adding and Removing Memory

If you want to expand the functionality of your computer, you can increase the memory by installing optional memory modules. Before you upgrade your computer's memory, read the notes and procedures in the following pages. The number of available slots depends on the configuration of your model.

### Notes on adding/removing memory modules

- ❑ Be careful when changing memory. Improper installation of memory modules may cause damage to your system. This damage may void your manufacturer's warranty.
- ❑ Only use memory modules that are compatible with the computer. If a memory module is not detected by the computer or Windows becomes unstable, contact your sales dealer or the manufacturer of your memory module.
- ❑ Electrostatic discharge can damage electronic components. Before touching a memory module, ensure the following:
  - ❑ The procedures described in this document assume familiarity with the general terminology associated with personal computers and with the safety practices and regulatory compliance required for using and modifying electronic equipment.
  - ❑ Turn off the computer and disconnect the system from its power source (that is, battery or AC adapter) and from any telecommunication links, networks, or modems before you open the computer. Failure to do so may result in personal injury or equipment damage.
  - ❑ Electrostatic Discharge (ESD) can damage memory modules and other components. Install the memory module only at an ESD workstation. If such a station is not available, do not work in a carpeted area, and do not handle materials that produce or hold static electricity (cellophane wrappers, for example). Ground yourself by maintaining contact with an unpainted metal portion of the chassis while performing the procedure.
  - ❑ Do not open the memory module package until you are ready to change the module. The package protects the module from ESD.

- Use the special bag delivered with the memory module or wrap the module in aluminium foil to protect it from electrostatic discharge.
- Introducing any liquids or any foreign substances or objects into the memory slots, or other internal components of the computer, will result in damage to the computer and any repair costs will not be covered by the warranty.
- Do not place the memory module in places subject to
  - Heat sources such as radiators or air ducts
  - Direct sunlight
  - Excessive dust
  - Mechanical vibration or shock
  - Strong magnets or speakers that are not magnetically shielded
  - Ambient temperature of more than 35°C or less than 5°C
  - High humidity
- Handle the memory module with care. To avoid injuries to your hands and fingers, do not touch the edges of the components and circuit boards inside the computer.

## Removing and Installing a Memory Module

To change or add a memory module

- 1 Shut down the computer and disconnect all peripheral devices.
- 2 Unplug the computer and remove the battery.
- 3 Wait until the computer cools down.
- 4 Unscrew the screw at the bottom of the computer.

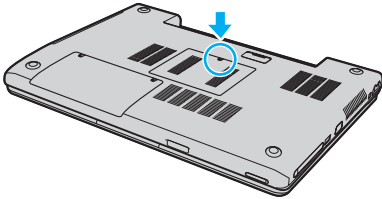

- 5 Touch a metal object (such as the connector panel on the back of the computer) to discharge static electricity.

6 Remove the memory module:

- Pull the latches in the direction of the arrows (1).  
The memory module is released.

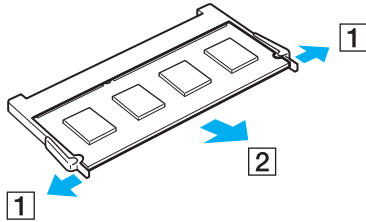

- Make sure that the memory module tilts up and then pull it out in the direction of the arrow (2).

- 7 Slide the memory module into the memory module slot and push it in until it clicks into place.

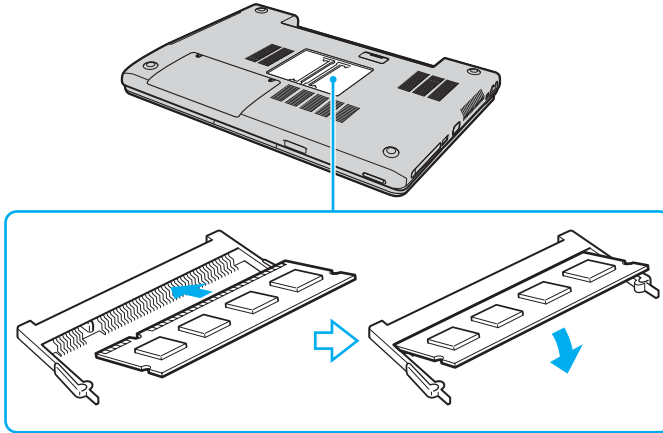

! Do not touch any other components on the motherboard.

Make sure to insert the memory module edge with a notch into the memory module slot.

- 8 Close the module cover and then tighten the screws on the bottom of the computer.
- 9 Reinsert the battery and turn on the computer.

## Viewing the Amount of Memory

To view the amount of memory

- 1 Turn on the computer.
- 2 Click **Start**, point to **All Programs**, and click **VAIO Control Center**.
- 3 Double-click the **System Information** folder in the **VAIO Control Center** window.
- 4 Double-click the **System Information** icon in the **System Information** folder.  
You can view the amount of system memory. If the additional memory does not appear, repeat the whole procedure and restart the computer.

# Precautions

This section describes safety guidelines and precautions to help you protect your computer from potential damage.

- ❑ **On Handling the LCD Screen** ([page 104](#))
- ❑ **On Using the Power Source** ([page 105](#))
- ❑ **On Handling Your Computer** ([page 106](#))
- ❑ **On Using the Built-in MOTION EYE Camera** ([page 108](#))
- ❑ **On Handling Floppy Disks** ([page 108](#))
- ❑ **On Handling Discs** ([page 109](#))
- ❑ **On Using the Battery Pack** ([page 110](#))
- ❑ **On Using Headphones** ([page 111](#))
- ❑ **On Handling Memory Stick Media** ([page 111](#))
- ❑ **On Handling the Hard Disk** ([page 112](#))

## On Handling the LCD Screen

- ❑ Do not leave the LCD facing the sun. This could damage the LCD. Be careful when using the computer near a window.
- ❑ Do not scratch the LCD or exert pressure on it. This could cause a malfunction.
- ❑ Using the computer in low temperature conditions may produce a residual image on the screen. This is not a malfunction. When the computer returns to normal temperature, the screen returns to normal.
- ❑ A residual image may appear on the screen if the same image is displayed for a lengthy period of time. The residual image disappears in a while. You can use a screen saver to prevent residual images.
- ❑ The screen becomes warm during operation. This is normal and does not indicate a malfunction.
- ❑ The LCD is manufactured using high-precision technology. You may, however, see tiny black points and/or bright points (red, blue, or green) that continuously appear on the LCD. This is a normal result of the manufacturing process and does not indicate a malfunction.
- ❑ Avoid rubbing the LCD screen. This could damage the screen. Use a soft, dry cloth to wipe the LCD screen.



## On Using the Power Source

- ❑ See the printed **Specifications Guide** to check the power operation of your model.
- ❑ Do not share the AC outlet with other power-consuming equipment, such as a photocopier or shredder.
- ❑ You can purchase a power strip with a surge protector. This device prevents damage to the computer caused by sudden power surges, in an electrical storm, for example.
- ❑ Do not place heavy objects on the power cord.
- ❑ To disconnect the cord, pull it out by the plug. Never pull the cord itself.
- ❑ Unplug the computer from the AC outlet if you are planning to not use the computer for a long time.
- ❑ Make sure that the AC outlet is easily accessible.
- ❑ When the AC adapter is not used, unplug it from the AC outlet.
- ❑ Use the AC adapter supplied with the computer or genuine Sony products. Do not use any other AC adapter as it may cause a malfunction.

## On Handling Your Computer

- ❑ Clean the cabinet with a soft cloth, which is dry or lightly moistened with a mild detergent solution. Do not use any type of abrasive pad, scouring powder, or solvent such as alcohol or benzine, as these may damage the finish of the computer.
- ❑ If you drop a solid object or any liquid onto the computer, shut down the computer and then unplug it. You may want to have the computer checked by qualified personnel before operating it again.
- ❑ Do not drop the computer or place heavy objects on top of the computer.
- ❑ Do not place the computer in a location subject to:
  - ❑ Heat sources, such as radiators or air ducts
  - ❑ Direct sunlight
  - ❑ Excessive dust
  - ❑ Moisture or rain
  - ❑ Mechanical vibration or shock
  - ❑ Strong magnets or speakers that are not magnetically shielded
  - ❑ Ambient temperature of more than 35°C or less than 5°C
  - ❑ High humidity
- ❑ Do not place electronic equipment near the computer. The electromagnetic field of the computer may cause a malfunction.
- ❑ Provide adequate air circulation to prevent internal heat from building up. Do not place the computer on porous surfaces such as rugs or blankets, or near material such as curtains or draperies that may block its ventilation slots.
- ❑ The computer uses high-frequency radio signals and may cause interference to radio or TV reception. If this occurs, relocate the computer a suitable distance away from the set.
- ❑ Use only specified peripheral equipment and interface cables; otherwise, problems may occur.

- ❑ Do not use cut or damaged connection cables.
- ❑ If the computer is brought directly from a cold location to a warm one, moisture may condense inside the computer. In this case, allow at least one hour before turning on the computer. If any problems occur, unplug the computer and contact VAIO-Link.
- ❑ Make sure you disconnect the power cord before cleaning the computer.
- ❑ To avoid losing data if the computer is damaged, back up your data regularly.

## On Using the Built-in MOTION EYE Camera

- ❑ Do not touch the front mirror plate over the lens of the built-in MOTION EYE camera, as it may make scratches on the plate and such scratches will appear on the captured images.
- ❑ Do not let the direct sunlight get into the scope of the built-in MOTION EYE camera regardless of the computer's power state, as it may cause a malfunction of the camera.
- ❑ The built-in MOTION EYE camera is disabled while videos or still images are imported from an i.LINK-compatible device connected to the S400 (i.LINK) connector.
- ❑ Clean the front mirror plate over the lens of the built-in MOTION EYE camera with a blower brush or a soft brush. If the lens is extremely dirty, wipe it off with a soft dry cloth. Do not rub the plate, as it is force-sensitive.

## On Handling Floppy Disks

- ❑ Do not open the shutter manually or touch the surface of the floppy disk.
- ❑ Keep floppy disks away from magnets.
- ❑ Keep floppy disks away from direct sunlight and other sources of heat.
- ❑ Keep the floppy disk away from any liquid. Do not let the floppy disk get wet. When you are not using the floppy disk, always remove it from the floppy disk drive and use a storage case.
- ❑ If the floppy disk comes with a label, make sure that the label is properly attached. If the edge of the label is curled up, the label may stick to the inside of the floppy disk drive and cause a malfunction or damage your floppy disk.

## On Handling Discs

- ❑ Do not touch the surface of the disc.
- ❑ Do not drop or bend the disc.
- ❑ Fingerprints and dust on the surface of a disc may cause read errors. Always hold the disc by its edges and central hole, as shown below:

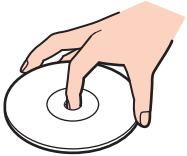

- ❑ Proper care of the disc is essential to its continuous reliability. Do not use solvents (such as benzine, thinner, alcohol, commercially available cleaners, or anti-static spray) which may cause damage to the disc.
- ❑ For normal cleaning, hold the disc by its edge and use a soft cloth to wipe the surface from the center out.
- ❑ If the disc is badly soiled, moisten a soft cloth with water, wring it out well, and use it to wipe the surface of the disc from the center out. Wipe off any remaining moisture with a dry soft cloth.
- ❑ Never put stickers on discs. This will affect the use of the disc irreparably.

## On Using the Battery Pack

- ❑ Do not leave the battery pack in temperatures above 60°C, such as in a car parked in the sun or under direct sunlight.
- ❑ Battery life is shorter in a cold environment. This is due to decreased battery efficiency at low temperatures.
- ❑ Charge the batteries at temperatures between 10°C to 30°C. Lower temperatures require a longer charging time.
- ❑ While the battery is in use or being charged, the battery pack heats up. This is normal and is not cause for concern.
- ❑ Keep the battery pack away from all sources of heat.
- ❑ Keep the battery pack dry.
- ❑ Do not open or try to disassemble the battery pack.
- ❑ Do not expose the battery pack to any mechanical shock.
- ❑ If you are not using the computer for an extended period of time, remove the battery pack from the computer to prevent damage to the battery.
- ❑ If, after fully charging the battery pack, the battery power is still low, the battery pack may be reaching the end of its life and should be replaced.
- ❑ You do not need to discharge the battery before recharging.
- ❑ If you have not used the battery pack for a considerable amount of time, recharge the battery.

## On Using Headphones

- ❑ **Road safety** – Do not use headphones while driving, cycling, or operating any motorized vehicle. It may create a traffic hazard and is illegal in some areas. It can also be potentially dangerous to play loud music while walking, especially at pedestrian crossings.
- ❑ **Preventing hearing damage** – Avoid using headphones at high volume. Hearing experts advise against continuous, loud and extended play. If you experience a ringing in your ears, reduce the volume or discontinue use.

## On Handling Memory Stick Media

- ❑ Do not use the media in locations that are subject to static electricity or electrical noise.
- ❑ Do not touch the Memory Stick media connector with your finger or metallic objects.
- ❑ Use only the label supplied with the Memory Stick media as a label.
- ❑ Do not bend, drop, or apply strong shock to the Memory Stick media.
- ❑ Do not disassemble or modify Memory Stick media.
- ❑ Do not let Memory Stick media get wet.
- ❑ Do not use or store Memory Stick media in a location subject to:
  - ❑ Extremely high temperatures, such as in a car parked in the sun
  - ❑ Direct sunlight
  - ❑ High humidity or
  - ❑ Corrosive substances
- ❑ Use the storage case supplied with the Memory Stick media.

## On Handling the Hard Disk

The hard disk has a high storage density and reads or writes data in a short time. However, it can be easily damaged by mechanical vibration, shock or dust.

Although the hard disk has the internal safety device to prevent losing data due to mechanical vibration, shock or dust, you should be careful when handling the computer.

### To avoid damaging your hard disk

- Do not subject the computer to sudden movements.
- Keep the computer away from magnets.
- Do not place the computer in a location subject to mechanical vibration or in an unstable position.
- Do not move the computer while the power is on.
- Do not turn off the power or restart the computer while reading or writing data to disk.
- Do not use the computer in a place subject to extreme changes in temperature.



If the hard disk is damaged, the data cannot be restored.



# Troubleshooting

This section describes how to solve common problems you might encounter when using your computer. Many problems have simple solutions. Try these suggestions before contacting VAIO-Link.

- ❑ **Troubleshooting the optical disc drive** ([page 114](#))
- ❑ **Troubleshooting PC Cards** ([page 117](#))
- ❑ **Troubleshooting the modem** ([page 118](#))
- ❑ **Troubleshooting Wireless LAN** ([page 120](#))
- ❑ **Troubleshooting Power Management** ([page 123](#))
- ❑ **Troubleshooting External Displays** ([page 124](#))
- ❑ **Troubleshooting Sound (Speaker)** ([page 126](#))
- ❑ **Troubleshooting Sound (Microphone)** ([page 127](#))
- ❑ **Troubleshooting Floppy Disks** ([page 128](#))
- ❑ **Troubleshooting Printers** ([page 129](#))
- ❑ **Troubleshooting i.LINK Devices** ([page 131](#))
- ❑ **Troubleshooting the Built-in MOTION EYE Camera** ([page 132](#))

## Troubleshooting the optical disc drive

### My optical disc drive tray does not open

- Make sure the computer is turned on and press the disc eject button.
- Click **Start** and then **My Computer**. Right-click the optical disc drive and select **Eject**.
- Make sure the computer is not in Standby or Hibernate mode.
- If this does not work, try the following:
  - Turn off the computer and insert a sharp, pointed object (for example a paperclip) into the manual eject hole\* on the optical disc drive to slide out the tray.

\* The location of the eject button and hole depends on your model of your computer. See **Locating Controls and Ports** (page 13).

### I cannot play a disc

- After inserting the disc, wait for a few seconds for the system to detect it before you try to access it.
- Make sure the label of the disc is facing up.
- If the disc requires software, make sure the software is installed according to the instructions of the program.
- Check the volume of your speakers.
- Clean the disc with an appropriate cleaner.
- Make sure the computer is running on AC power supply only and try the disc again.
- There may be condensation in the drive. Remove the disc and leave the drive open for approximately one hour. Remove the battery while you wait for the condensation to disappear.

## I cannot play a DVD

- ❑ If a region code warning appears when you are using your DVD player, it could be that the DVD you are trying to play is incompatible with the optical disc drive on the computer. The region code is listed on the packaging of the disc.
- ❑ Change the resolution under **Control Panel - Display** to a lower resolution.
- ❑ If you see video but cannot hear sound, check all of the following:
  - ❑ Make sure the mute setting is off on your DVD player.
  - ❑ Check the **Master Volume** settings of the **Sounds and Audio Device Properties**.
  - ❑ If you have connected speakers externally, check the volume settings of the computer speakers and check the connections between your speakers and the computer.
  - ❑ In the **Device Manager**, check that the correct drivers are installed properly. To display the **Device Manager**, click **Start, Control Panel**, and **Performance and Maintenance**. Click the **System** icon and then the **Device Manager** button on the **Hardware** tab.
- ❑ A dirty or damaged disc may cause the computer to "hang" while it tries to read the disc. If necessary, reboot the computer, remove the disc and then check that it is not dirty or damaged.
- ❑ Check your PG settings (Parental Guidance) in the DVD software as they might be preventing you from playing certain DVDs when they are activated.



The default DVD region code is 2. Do not change this setting using the **Region Code Change** function in Windows, or using any other software applications. System malfunctions originating from the user changing the DVD region code are beyond the scope of your warranty and will result in service charges for repair.

If you do not immediately see the **Display** icon after clicking **Control Panel**, click **Switch to Classic View** on the left.

## I cannot play a DVD when using two screens

- ❑ You will not have a problem in the following situations:
  - ❑ When you use a CRT or an LCD display on its own.
  - ❑ When you play MPEG files which are recorded on the hard disk drive with **Windows Media Player 10** or **VAIO Zone**.

## The reading speed of CD/DVD-RWs is very slow

Generally, the reading speed of a CD/DVD-RW is slower than that of a -ROM or -R. The reading speed can also vary depending on the type of format.

## The disc tray does not eject even when the eject button is pressed

- ❑ Check that the computer is turned on.
- ❑ The CD-writing application software may be stopping the disc from being ejected.
- ❑ Make sure the computer is not in Standby or Hibernate mode.

## The disc tray ejects even when it has been locked into place

- ❑ Ensure that the disc is placed with the label side facing up.
- ❑ Clean the disc and the optical disc drive lens with an appropriate cleaner.
- ❑ The disc may be scratched. Place another disc to see if that is the reason.
- ❑ There may be condensation in the drive. Remove the disc and leave the drive open for approximately one hour. Remove the battery while you wait for the condensation to disappear.

## Troubleshooting PC Cards

### [My PC Card is not working](#)

Make sure the PC Card is compatible with your version of Windows.

## Troubleshooting the modem

### My modem does not work or cannot establish a connection

- ❑ Check that the phone line is plugged into the computer.
- ❑ Make sure that the modem is the only device connected to your phone line.
- ❑ Check that the phone line is working. You can check the line by plugging in an ordinary phone and listening for a dial tone.
- ❑ Check that the phone number the program is dialing is correct. The modem dialing mode may be incompatible with your telephone line.
- ❑ The modem may not work properly if you are with a Private Automatic Branch eXchange (PABX).
- ❑ In the **Phone and Modem Options** window (**Control Panel / Printers and Other Hardware / Phone and Modem Options**), check that your modem is listed on the **Modems** tab, and that the location information is correct on the **Dialing Rules** tab.  
If you do not see the **Phone and Modem Options** icon, click **Switch to Classic View** on the left side.
- ❑ We recommend you use country-specific phone plug to plug the phone line into the wall jack, because use of any other phone plug can decrease the connection quality.
- ❑ The computer cannot be connected to a coin-operated telephone, and may not work with multiple phone lines or a private branch exchange (PBX). If you connect the modem to a parallel connected phone line, the modem or the other connected device may not function properly. Some of these connections may result in excess electrical current and could cause a malfunction in the internal modem.
- ❑ Only DTMF (Dual Tone Multi Frequency) signaling (tone dialing) is supported.
- ❑ The internal modem is intended to be used for data and fax communications using DTMF (Dual Tone Multi Frequency) signaling (tone dialing) on the PSTN (Public Switched Telephone Network) networks in the following countries: Austria, Belgium, Czech Republic, Denmark, Finland, France, Greece, Germany, Iceland, Ireland, Italy, Luxembourg, Norway, Portugal, Spain, Sweden, Switzerland, the Netherlands and the United Kingdom.
- ❑ If the computer is equipped with the flexible modem connector cover, do not pull it too forcefully.

## My modem connection is slow

Many factors influence modem connection speed, including telephone line noise or compatibility with telephone equipment (such as fax machines or other modems). If you think your modem is not connecting properly to other PC-based modems, fax machines, or your Internet Service Provider, check the following:

- Have your phone company check that your phone line is free from any line noise.
- If your problem is fax-related, check that there are no problems with the fax machine you are calling and that it is compatible with fax modems.
- If you are having a problem connecting with your Internet Service Provider, check that the ISP is not experiencing technical problems.
- If you have a second phone line available, try connecting the modem to that line.

## Troubleshooting Wireless LAN

### I cannot use the Wireless LAN functionality

Check if the **WIRELESS** or **WIRELESS LAN** switch is turned on and the WIRELESS LAN indicator is lit.

### The Wireless LAN Access Point and your computer cannot communicate

- Check if the **WIRELESS** or **WIRELESS LAN** switch is turned on and the WIRELESS LAN indicator is lit.
- Check if the power of the Access Point is turned on.
- Check if the Access Point is displayed in the **Available networks** window.
  - To check this, click Start and then **Control Panel**.
  - Click **Network and Internet Connections**.
  - Click the **Network Connections** icon.
  - Right-click the **Wireless Network Connection** icon and select **Properties**.
  - Select the **Wireless Networks** tab.
  - Check if the Access Point is displayed in **Available networks**.
  - Connection availability is affected by distance and obstructions. You may need to move the computer away from obstructions or neared to any Access Point you may be using.



## The data transfer speed is slow

- ❑ The maximum communication speed can vary depending on the obstacles or the distance between the communication devices, the radio waves, the operating system or the software you use. Remove the obstacle or make the distance between the Access Point and your machine smaller.
- ❑ It is possible that your Access Point communicates at the same time with another Access Point. Read the manual of the Access Point.
- ❑ If several computers communicate with the same Access Point, the concentration may be too high. Wait a few minutes and try to access again.
- ❑ If a Wireless LAN device using the IEEE802.11g standard communicates with a device using the IEEE802.11b standard, then it is normal that the speed reduces. Devices using the IEEE802.11g standard are 5 times faster than the ones using the IEEE802.11b standard.

## I cannot access the Internet

- ❑ Check the settings of the Access Point. See the manual of the Access Point.
- ❑ Check if the computer and the Access Point are communicating.
- ❑ Make the distance between the Access Point and your machine smaller.

## I cannot use a Wireless LAN network

Check if the **Wireless Zero Configuration** service is active.

To check the status of the Wireless Zero Configuration service

- 1 Click **Start** and then **Control Panel**.  
The **Control Panel** window appears.
- 2 Click the **Performance and Maintenance** icon.
- 3 Click the **Administrative Tools** icon.
- 4 Double-click the **Services** icon.  
The **Services** window appears.
- 5 Check **Status** and **Startup Type** for **Wireless Zero Configuration**.  
When **Started** and **Automatic** are shown under **Status** and **Startup Type**, respectively, the **Wireless Zero Configuration** service is active.

To activate the Wireless Zero Configuration service

- 1 On the **Services** window, right-click **Wireless Zero Configuration** and click **Properties**.  
The **Wireless Zero Configuration Properties** window appears.
- 2 Select **Automatic** for **Startup type** and click **Apply**.
- 3 Click **Start** under **Service status**.
- 4 Click **OK** to close the window.

# Troubleshooting Power Management

## The power management setting is not responding

The computer's operating system may become unstable if a lower power state, such as Hibernate is initiated, and then changed before the computer completely enters the lower power state.

To restore the computer to its normal operating stability

- 1 Close all open applications.
- 2 Press the **Ctrl+Alt+Delete** keys simultaneously and select **Restart** from the shut down menu drop-down list.  
The computer restarts.
- 3 If the procedure does not work, press and hold the power button for four seconds or longer to shut down the computer.

## Troubleshooting External Displays

### I cannot use the Plug and Display function

Depending on the external display or the way it is connected, the Plug and Display function may not be available. Use the **Fn+F7** keys to select the output destination.

### I cannot display contents on two or more displays at the same time

You cannot display contents on multiple external displays at the same time. Select one of the external displays.

## The external display with the DVI-D port does not display properly

This troubleshooting entry applies to selected models only. See **Locating Controls and Ports (page 13)** to see whether your model is equipped with the DVI-D port. Note that the (optional) port replicator may also have the DVI-D port.

See the printed **Troubleshooting Guide** first to solve your problems. If the problem persists, proceed as follows:

- 1 Click **Start** and then **Control Panel**.  
The **Control Panel** window appears.
- 2 Click the **Appearance and Themes** icon.
- 3 Click the **Display** icon.  
The **Display Properties** window appears.
- 4 Click the **Settings** tab.
- 5 Click **Advanced**.  
The properties window appears.
- 6 Click **Options**.
- 7 Confirm that the button for **Alternate DVI operational mode** is selected. If not, click to check the button.
- 8 Click to check the button for **Reduce DVI frequency on high-resolution displays**.  
The warning message window appears.
- 9 Click **Yes**.
- 10 Click **Yes** once again.

! Click to check the above button only if the external display with the DVI-D port does not display properly with the default settings.

The external display with the DVI-D port does not display the boot-up screen and the BIOS setup screen at startup. To change the BIOS settings, use the computer's LCD screen.

## Troubleshooting Sound (Speaker)

### My speakers are not producing sound

- ❑ The built-in speakers may be turned off. Press the **Fn+F2** keys or the **S1** button (default assignment) to turn on the speakers.
- ❑ The speaker volume may be turned to the minimum. Press the **Fn+F4** keys and then the **↑** or **→** key, or keep pressing the **Fn+F4** keys to increase the volume.
- ❑ If you use external speakers, check that the speakers are properly connected and the volume is turned up. If the speakers have a mute button, make sure it is off. If batteries power the speakers, check that the batteries are inserted properly and that they are charged.
- ❑ If you have connected an audio cable to the headphones jack, disconnect the cable.
- ❑ If the computer is powered by battery, check that the battery pack is properly installed and charged.
- ❑ If you are using an application that has its own volume control, check that the volume is turned up.
- ❑ Check the volume controls in Windows.

## Troubleshooting Sound (Microphone)

### My microphone does not work

If you are using an external microphone, check that the microphone is plugged into the microphone jack correctly.

### My microphone volume is too high or too low

Proceed as follows to adjust the volume.

- 1 Click **Start** and then **Control Panel**.  
The **Control Panel** window appears.
- 2 Click **Sounds, Speech, and Audio Devices** and then **Sounds and Audio Devices**.
- 3 Click **Volume** under **Sound recording** on the **Audio** tab.
- 4 See if the **Select** check box for **Microphone Balance** is selected. If not, click the check box.
- 5 Move the slider up or down to adjust the volume.
- 6 If the volume is still too high or too low, select **Advanced Controls** from the **Options** menu.  
The **Advanced** button appears for **Microphone Balance**.
- 7 Click the **Advanced** button and select/deselect **Microphone Boost** or **+20db Gain** under **Other Controls** to adjust the volume.

## Troubleshooting Floppy Disks

### My USB floppy disk drive cannot write to a floppy disk

- The floppy disk is write-protected. Disable the write-protect feature or use a floppy disk that is not write-protected.
- Check that the disk is properly inserted into the floppy disk drive.
- Your disk may be corrupt. Try to insert another floppy disk.

### The optional USB floppy disk drive is not recognized as drive A

To set the floppy disk drive to A

- 1 Turn the system power on.
- 2 Connect the floppy disk drive.
- 3 Select **Control Panel** from the **Start** menu.
- 4 Click **Performance and Maintenance**.
- 5 Click **System**.
- 6 Select the **Hardware** tab, then click **Device Manager**.
- 7 Select **Universal Serial Bus controllers**, then **Y-E Data USB Floppy**.
- 8 From the Action menu, click **Uninstall**.
- 9 Keep clicking **OK** until the **Confirmation of deletion of device** message appears.
- 10 Select **Scan for hardware changes** from the **Action** menu.  
The floppy disk drive is recognized as drive A.



## Troubleshooting Printers

- ❑ Make sure that the printer driver supports Windows XP.  
Ask the manufacturer of your printer for the driver that supports Windows XP.
- ❑ The printer port  on the port replicator is internally connected to the USB. If your printer is connected to the printer port on the port replicator, proceed as follows to check the printer port settings.
  - 1 Click **Start** and then **Control Panel**.
  - 2 Click the **Printers and Other Hardware** icon.
  - 3 Click the **Printers and Faxes** icon.
  - 4 Right-click the printer to select **Properties**.
  - 5 Click the **Ports** tab.
  - 6 Check if the check box for **USB001** is selected. If another check box is selected, click the box for **USB001**.
  - 7 Click **OK**.

If the above procedure does not work, right-click the printer and select **Delete** on the window in step 3 above to delete the printer. Then, install the printer driver once again.

- ❑ If the bidirectional communication functions are provided with your printer, disabling the functions on the computer may enable printing. Proceed as follows:
  - 1 Click **Start** and then **Control Panel**.
  - 2 Click the **Printers and Other Hardware** icon.
  - 3 Click the **Printers and Faxes** icon.
  - 4 Right-click the printer to select **Properties**.
  - 5 Click the **Ports** tab.
  - 6 Click the check box for **Enable bidirectional support** to deselect it.
  - 7 Click **OK**.



This change to the settings will disable the bidirectional communication functions of your printer, such as data transfer, status monitoring, and remote panel.

- ❑ Check the physical connections between the computer and printer, the AC adapter and the power cord, and the power cord and an AC outlet, and then restart the computer.

## Troubleshooting i.LINK Devices

### I cannot establish an i.LINK connection between two VAIO computers

- ❑ You must have administrator rights on the computer to be able to link the two.
- ❑ Disconnect then reconnect the i.LINK cable.
- ❑ If you still have no connection after waiting for a while, restart both computers.
- ❑ If either computer has just returned from a power saving mode, the connection may be affected. In this case, make sure you perform a full restart before connecting them.

### When I record images to a digital video device using DVgate Plus, I see an error message

- ❑ Close all open applications and restart the computer. Frequent recording of images to a digital video device while using **DVgate Plus** sometimes causes this error.
- ❑ Your DV device will need to have DV In/Out in order to be able to transfer your files to the DV device.

### I cannot use digital devices

- ❑ Check that the DV device is turned on and that the cables are properly connected.
- ❑ If you are using multiple i.LINK devices, the combination of the connected devices may cause unstable operation. If this is the case, turn off all connected devices and disconnect unused devices. Check the connection and then turn on the power again.
- ❑ You are strongly advised to use only Sony i.LINK cables, as using other brands may cause problems with the i.LINK devices.

## Troubleshooting the Built-in MOTION EYE Camera

### The viewer window shows no images or poor-quality images

- ❑ The built-in MOTION EYE camera cannot be shared by more than one software application. If another software application is using the camera, exit the application before using the built-in MOTION EYE camera.
- ❑ The video memory of the computer may have become insufficient for displaying images from the built-in MOTION EYE camera. Lowering the resolution or reducing the colors of the LCD might help.
- ❑ The viewer window may show some noises, for example horizontal lines, if you view a rapid-moving object. This is normal and does not indicate a malfunction.
- ❑ If the problem persists, restart the computer.

### Captured images are poor in quality

- ❑ The images captured under the fluorescent lamp may show reflection of the light.
- ❑ A dark portion in captured images may appear as a noise.
- ❑ If the front mirror plate over the lens is dirty, you cannot take a clear shot. Clean the lens. See **On Using the Built-in MOTION EYE Camera (page 108)**.

### Captured images contain dropped frames and audio interruptions

- ❑ The effect settings on your software application may have caused dropped frames. See the help file on your software application for more information.
- ❑ There may be more software applications running than your computer can handle. Exit the applications that you are not currently using.
- ❑ The power management function of your computer is activated. Check the CPU performance.

## Movie playback shows dropped frames when my computer is running on the battery

The battery is running out of power. Connect the computer to an AC power source.

## The images captured by the built-in MOTION EYE camera flicker

This problem occurs when you use the camera under fluorescent lights due to the mismatch between lighting output frequency and shutter speed.

To reduce flicker noise, change the pointing direction of the camera or the screen brightness. In some software applications, you can set an appropriate value to Flickness, one of the camera properties, to eliminate flicker noise.

## The video input from the built-in MOTION EYE camera is suspended for a few seconds

The video input may be suspended for a few seconds if

- a shortcut key with the **Fn** key is used.
- the CPU load increases.

This is normal and does not indicate a malfunction.

## I cannot use the built-in MOTION EYE camera

- ❑ The built-in MOTION EYE camera cannot be shared by more than one software application. If another software application is using the camera, exit the application before using the built-in MOTION EYE camera.
- ❑ If the problem persists, you must reinstall the driver software for the camera. Proceed as follows to reinstall the driver software.
  - 1 Click **Start** and then **Control Panel**.
  - 2 Click the **Performance and Maintenance** icon.
  - 3 Click the **System** icon.
  - 4 Click **Device Manager** on the **Hardware** tab.
  - 5 Double-click **Imaging devices**.
  - 6 Right-click **Sony Visual Communication Camera VGP-VCC1** and click **Update Driver**.

# Support Options

The section contains information on where to go for answers to questions about your computer.

## Sony Support Information

See the following sources for answers in the sequence listed below.

See **Documentation (page 7)** for details on the printed and online documentation supplied with your computer, as well as further sources of reference.

- Go to the online **help files** that accompany your software for instructions on using the software.
- Use the search functionality in **Help and Support Center** by pressing the Microsoft Windows key  and the **F1** key.
- VAIO-Link web site:** if you have any problem with the computer, you can access the VAIO-Link web site for troubleshooting. Go to <http://www.vaio-link.com>.
- e- Support:** This interactive part of our web site <http://www.vaio-link.com> allows you to get in contact with our dedicated support team over the internet. Using a personalized account, you can log your technical queries with ease.
- VAIO-Link help lines:** Before contacting VAIO-Link by telephone, try to solve the problem by reading the online and printed documentation.
- Visit the other Sony web sites:
  - [www.club-vaio.com](http://www.club-vaio.com) if you want to know more about VAIO and become part of the growing VAIO community.
  - [www.sonystyle-europe.com](http://www.sonystyle-europe.com) for online purchases.
  - [www.sony.net](http://www.sony.net) for other Sony products.



You need to set up an Internet connection before you can access the online features described here.

## e-Support

### What is e-Support?

You have searched our user guides and web site ([www.vaio-link.com](http://www.vaio-link.com)) but have not found an answer to your question/issue? e-Support is the ideal solution for you!

Our e-Support Web Portal is an interactive web site on which you can submit any technical query you may have regarding your computer and receive answers from our dedicated support team.

Every submitted query will result in a unique 'case number' to ensure smooth communication between yourself and the e-Support Team.

### Who can use e-Support?

All registered VAIO customers are entitled to unlimited access to the VAIO-Link e-Support Web Portal.

### How can I access the e-Support portal?

When you register your computer, you will automatically receive an email with the link to the e-Support Web Portal, your Customer ID and some basic explanation a few hours later.

All you need to do is activate your account by clicking on the provided link in the email.

You are now ready to create your first case!

You can access the e-Support Web Portal from any computer with an active Internet connection.

A complete help file is available on the e-Support Web Portal to help you use our e-Support Service.

### Can I submit questions in my native language?

Since you are interacting with our e-Support Team through a portal, which connects you directly to our central database, e-Support will only accept and deal with queries submitted in English, French or German.



## Can I submit my questions at any time?

Yes, you can submit your questions 24/7, but please keep in mind that our e-Support Team can only treat your queries from Monday till Friday between 8am and 6pm.

## Is there a cost involved for using e-Support?

No, this is a complete free of charge service offered to all registered VAIO customers!

How do I know when the e-Support Team has handled my query/case?

As soon as your case has been dealt with by our e-Support Team, you will receive an email, notifying you that your case has been updated.

## Trademarks

Sony, Battery Checker, Click to DVD, DVgate Plus, HotKey Utility, Keyboard Utility, Memory Stick Formatter, PictureGear Studio, Prepare your VAIO, SonicStage, SonicStage Mastering Studio, VAIO Control Center, VAIO Edit Components, VAIO Launcher, VAIO Media, VAIO Power Management, Image Converter, VAIO Zone, My Club VAIO, VAIO Update, Memory Stick, the Memory Stick logo, VAIO and the VAIO logo are trademarks of Sony Corporation.

Intel, Pentium, and Intel SpeedStep are trademarks or registered trademarks of Intel Corporation.

Microsoft, Internet Explorer, Windows Movie Maker, Windows Media Player, Windows XP Professional, Windows XP Home Edition, MS Works 8.0, Microsoft Office 2003 SBE (Try & Buy) and the Windows logo are trademarks or registered trademarks of Microsoft Corporation in the U.S. and other countries.

i.LINK is a trademark of Sony used only to designate that a product contains an IEEE1394 connection.

Adobe, Adobe Acrobat Elements, Adobe Acrobat Professional, Adobe Reader, Adobe Premiere Standard and Adobe Photoshop Elements are trademarks of Adobe Systems Incorporated.

MoodLogic is a trademark of MoodLogic, Inc.

Norton Internet Security 2005 AntiSpyware Edition and Norton Password Manager 2004 are trademarks or registered trademarks of Symantec Corporation.

Roxio DigitalMedia SE is a trademark of Sonic Solutions.

WinDVD for VAIO is a trademark of InterVideo, Inc.

Sun Java VM is a trademark of Sun Microsystems, Inc.

Google Toolbar is a trademark of Google.

Yahoo! Messenger is a trademark of Yahoo!.

SafeGuard PrivateDisk is a trademark of Utimaco Software.

My Club VAIO uses Macromedia Flash™ Player software by Macromedia, Inc., Copyright © 1995-2003 Macromedia, Inc. All rights reserved. Macromedia and Flash are trademarks of Macromedia, Inc.

All other names of systems, products and services are trademarks of their respective owners. In the manual, the ™ or ® marks are not specified.

Specifications are subject to change without notice. All other trademarks are trademarks of their respective owners.

Please see the printed **Specifications Guide** to see what software is available for your model.

