

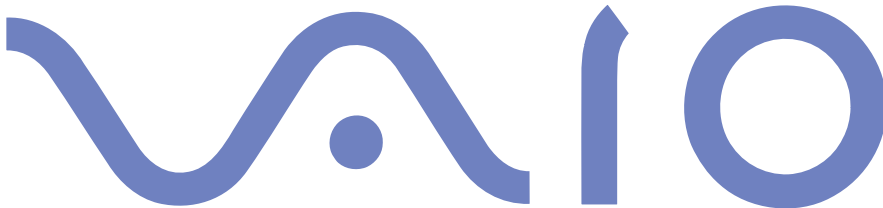

# Sony Notebook Computer User Guide

PCG-F807K / PCG-F808K / PCG-F809K



## *Notice to Users*

© 2000 Sony Corporation. All rights reserved. This manual and the software described herein, in whole or in part, may not be reproduced, translated, or reduced to any machine-readable form without prior written approval.

Sony Corporation provides no warranty with regard to this manual, the software, or other information contained herein and hereby expressly disclaims any implied warranties or merchantability or fitness for any particular purpose with regard to this manual, the software or such other information. In no event shall Sony Corporation be liable for any incidental, consequential, or special damages, whether based on tort, contract, or otherwise, arising out of or in connection with this manual, the software, or other information contained herein or to use thereof.

Sony Corporation reserves the right to make any modification to this manual or the information contained herein at any time without notice. The software described herein is governed by the terms of a separate user license agreement.

Sony, DVgate, i.LINK™, Mavica, PictureGear, Memory Stick and the Memory Stick logo, VAIO and the VAIO logo are trademarks of Sony Corporation. The Windows and the Windows 2000 logos are registered trademarks of Microsoft Corporation.

Intel, MMX, Celeron and Pentium are trademarks of Intel Corporation.

All other trademarks are trademarks of their respective owners.

Specifications are subject to change without notice.

As an Energy Star Partner, Sony has determined that this product meets the Energy Star guidelines for energy efficiency.

The International Energy Star Office Equipment Program is an international program that promotes energy saving through the use of computers and their office equipment. The program backs the development and dissemination of products with functions that effectively reduce energy consumption. It is an open system in which business proprietors can participate voluntarily. The targeted products are office equipment such as computers, displays, printers, facsimiles and copiers. Their standards and logos are uniform among participating nations.

Energy Star is an U.S. registered mark.



## Safety Information

### Owner's Record

The model number and serial number are located on the bottom of your Sony notebook computer. Record the serial number in the space provided here. Refer to the model and serial number when you call VAIO-Link.

Serial number: \_\_\_\_\_

Model number:

**PCG-F807K / PCG-F808K / PCG-F809K**

### WARNINGS

#### General

- Opening the unit, for whatever reason, could lead to damages that are not covered by the guarantee.
- To avoid electrical shock, do not open the cabinet. Refer servicing to qualified personnel only.
- To prevent fire or shock hazard, do not expose your VAIO notebook computer to rain or moisture.
- Avoid using the modem during an electrical storm.
- Do not use the modem or a telephone to report a gas leak in the vicinity of the leak.

#### DVD-ROM

- The use of the optical instrument installed in your notebook computer will cause eye hazard. As the laser beam used in this product is harmful to eyes, do not attempt to disassemble the cabinet. For servicing, refer to qualified personnel only.
- There are visible and invisible radiations when the DVD-ROM drive is open : avoid direct exposure to the laser beam.

#### Audio/Video

- Audio and picture distortion may occur if this equipment is positioned in close proximity to any equipment emitting electromagnetic radiation.

### *Connectivity*

- ❑ Never install modem or telephone wiring during a lightning storm.
  - ❑ Never install telephone jacks in wet locations unless the jack is specifically designed for wet locations
  - ❑ Use caution when installing or modifying telephone lines.
  - ❑ Use your notebook only with the supplied AC adapter. To disconnect your notebook completely from mains voltage, unplug the AC adapter.
  - ❑ Please make sure that the socket outlet is easily accessible.
  - ❑ Never touch uninsulated telephone wire or terminals unless the telephone line has been disconnected at the network interface.
-

## *Regulatory Information*

This product conforms to the following European Directives:

73/23/EEC (Low Voltage Directive)

89/336/EEC, 92/31/EEC (EMC Directives)

93/68/EEC (CE Marking Directive)

1999/5/EC (radio equipment and telecommunications terminal equipment Directive)

This product complies with EN 55022 Class B and EN 50082-1 for use in following areas: residential, commercial and light-industrial.

This product has been tested and found compliant with the limits set out in the EMC Directive for using connection cables shorter than 3 metres (9.8 feet)

The DVD-ROM is classified as a CLASS 1 LASER PRODUCT and complies with the Laser Product Safety Standard EN 60825-1. Repair and maintenance only by authorized Sony technicians. Improper repairs and use can create safety hazards.

**CLASS 1  
LASER PRODUCT  
TO EN 60825-1**

- Disposal of Lithium ion batteries
- Dispose of properly at end-of-life.
- In some areas the disposal of lithium ion batteries in household or business waste may be prohibited.
- Please use the public collection system.

### *Disposal of Lithium Ion battery*

- ! Do not handle damaged or leaking Lithium ion batteries. Dispose of promptly and properly.
- ! Danger of explosion if battery is incorrectly replaced. Replace only with the same or equivalent type recommended by the manufacturer. Discard used batteries according to the manufacturer's instructions (see below).
- ! The battery pack used in this device may present a fire or chemical burn hazard if mistreated. Do not disassemble, heat above 100°C (212°F) or incinerate. Dispose of used battery promptly.
- ! Keep away from children.
- ! Your notebook is equipped with an internal backup memory battery. For changing this battery, please contact VAIO-Link.

## Welcome

Congratulations on purchasing a Sony VAIO notebook computer. Sony has combined leading-edge technology in audio, video, computing and communications to provide you with state-of-the-art personal computing.

Here are just some of the features your VAIO notebook computer has to offer (read the details in the Specifications chapter of this guide).

- ❑ **Exceptional performance** - Your PC includes a fast processor, a fast DVD-ROM drive and an internal modem.
  - ❑ **Portability** - The rechargeable battery pack provides hours of use without AC power.
  - ❑ **Sony audio and video quality** - A high-resolution LCD screen enables you to take advantage of today's advanced multimedia applications, games, and entertainment software.
  - ❑ **Multimedia features** - Enjoy the speaker(s) to listen to audio and video CDs.
  - ❑ **Windows®** - Your system includes the latest operating system from Microsoft.
  - ❑ **Communications** - Access popular online services, send and receive e-mails, browse the Internet...
  - ❑ **Excellent customer support** - If you have any problem with your computer, you can contact VAIO-Link by Internet and e-mail (see your Customer Service Guide for addresses). Before contacting VAIO-Link, you may try to solve the problem by reading your User Guide (troubleshooting chapter) or the manuals and Help files for the peripherals or software.
-



## About the User Guides

Your Documentation Pack contains paper and online user guides on a Documentation CD-ROM:

### Printed Documentation:

- ❑ A **Setting Up** poster in colour and a **Getting Started** brochure; a **Customer Guide**, where you will find all the basic information to start using your notebook computer;
- ❑ A complete **Regulatory and safety information poster**;
- ❑ A **Modem Regulations Flyer** applying to the internal modem;
- ❑ Your **Sony Guarantee conditions**.

### Online Documentation:

- 1 This User Guide:
    - ❑ **Using Your Sony Notebook Computer** shows you how to use the standard components of your system.
    - ❑ **Connecting Peripheral Devices** explains how you can add functionality by connecting various peripherals.
    - ❑ **Getting Help** explains the support options available to you, and offers basic troubleshooting tips.
    - ❑ **Notes on Use** provides facts and advice about using your notebook computer.
    - ❑ **Specifications** provides details on your computer, drivers and accessories.
  - 2 Refer to your **Software Guide** for information on the bundled software and the Sony applications.
-

- ❑ **About the Software** is a short description of the features of the software pre-installed on your system.
  - ❑ **Customizing your notebook** explains how to set your system and power management with Sony Notebook Setup, VAIO Action Setup, PowerPanel, BatteryScope, etc.
  - ❑ **Using the Product Recovery CD-ROMs** explains how to perform a system and an application recovery.
- 3 Consult the **Online Help** files of the software you're using for detailed information on features and troubleshooting.
  - 4 Refer to the Microsoft **Getting started** manual for more information on Windows®.



## Unpacking Your Notebook Computer

Remove the following hardware items from the box:

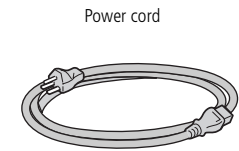
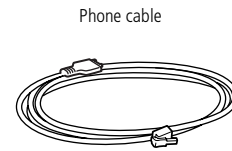
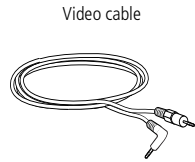
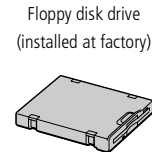
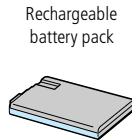
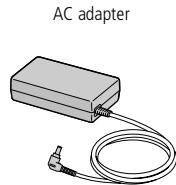
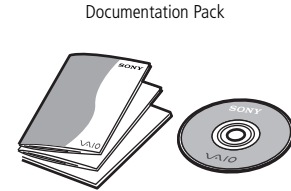
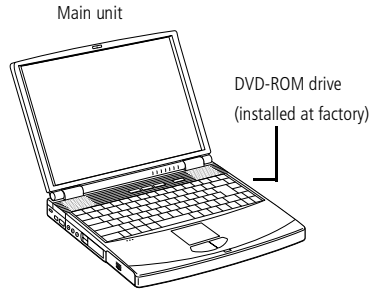

## Ergonomic Considerations

You will be using your notebook computer as a portable device in a variety of environments. Whenever possible, you should attempt to take account of the following ergonomic considerations to both stationary and portable environments:

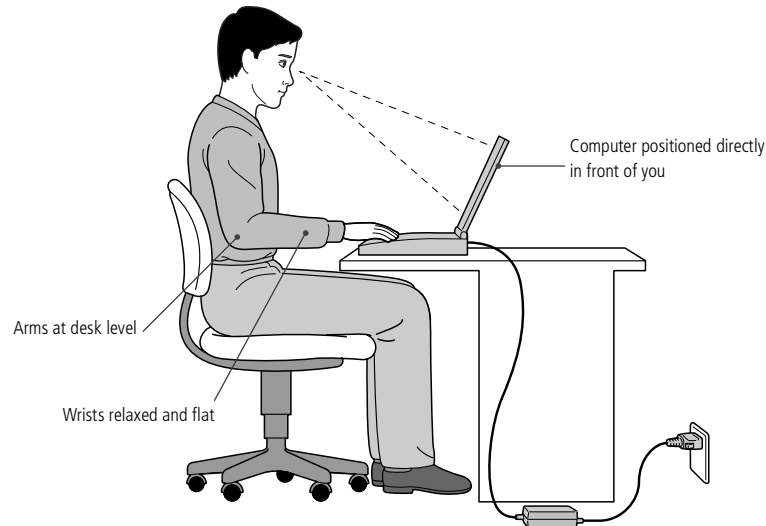

- ❑ **Position of your computer** – Place the computer directly in front of you as you work. Keep your forearms horizontal, with your wrists in a neutral, comfortable position while using the keyboard, touchpad, or external mouse. Let your upper arms hang naturally at your sides. Take breaks during sessions with your computer. Excessive use of the computer may strain muscles or tendons.

- ❑ **Furniture and posture** – Sit in a chair with good back support. Adjust the level of the chair so your feet are flat on the floor. A footrest may make you more comfortable. Sit in a relaxed, upright posture and avoid slouching forward or leaning far backwards.
- ❑ **Viewing angle of the computer's display** – Use the display's tilting feature to find the best position. You can reduce eye strain and muscle fatigue by adjusting the tilt of the display to the proper position. Adjust the brightness setting of the display as well.
- ❑ **Lighting** – Choose a location where windows and lights do not create glare and reflection on the display. Use indirect lighting to avoid bright spots on the display. You can also purchase accessories for your display that help reduce glare. Proper lighting adds to your comfort and work effectiveness.
- ❑ **Placement of an external display** – When using an external display, set the display at a comfortable viewing distance. Make sure the display screen is at eye level or slightly lower when you are sitting in front of the monitor.
- ❑ **Tilt stands** – You use the tilt stands to place the computer at an angle that allows comfortable typing.

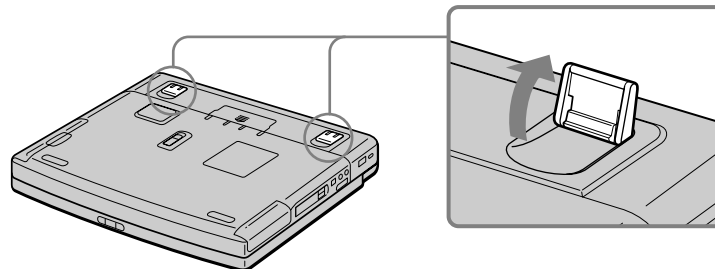

# Using Your Notebook Computer

This section describes how to start using your computer and how to use your computer's internal devices, such as the touchpad, the disk drives and the battery...

## Locating the Controls and Connectors

### Right

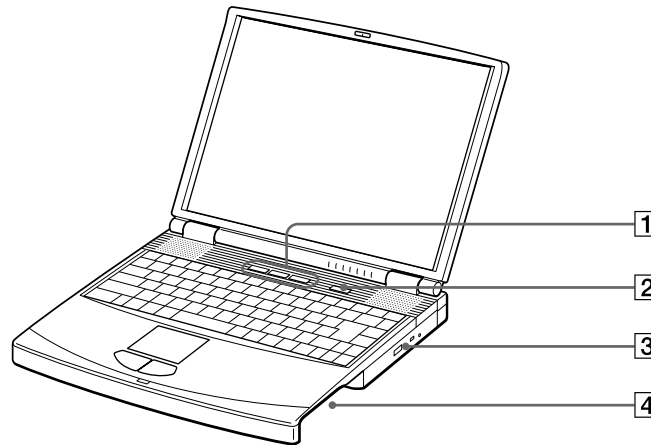

- |                       |           |                            |                        |
|-----------------------|-----------|----------------------------|------------------------|
| <b>1</b> PPK buttons  | (page 44) | <b>3</b> DVD-ROM drive     | (page 38)              |
| <b>2</b> Power button | (page 25) | <b>4</b> Multi-purpose bay | (page 35)<br>(page 53) |

## Locating the Controls and Connectors

 AC adapter mains connector and power cord: hazardous voltage, according to EN 60950.

Phone cable and connectors are TNV (Telecommunications Network Voltage), according to EN60950.

All other connectors for this notebook are SELV (Safety Extra Low Voltage), according to EN 60950.

## Left

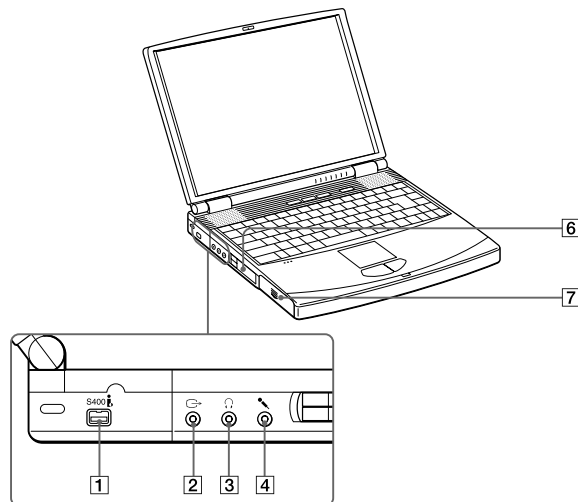

- |          |  |                           |          |  |                           |
|----------|--|---------------------------|----------|--|---------------------------|
| <b>1</b> |  S400 i.LINK™ connector | <a href="#">(page 67)</a> | <b>4</b> |  Microphone connector | <a href="#">(page 75)</a> |
| <b>2</b> | TV Out Connector   | <a href="#">(page 65)</a> | <b>5</b> | PC card slots  | <a href="#">(page 41)</a> |
| <b>3</b> |  Headphone connector    | <a href="#">(page 74)</a> | <b>6</b> | Battery bay  | <a href="#">(page 20)</a> |

### Front

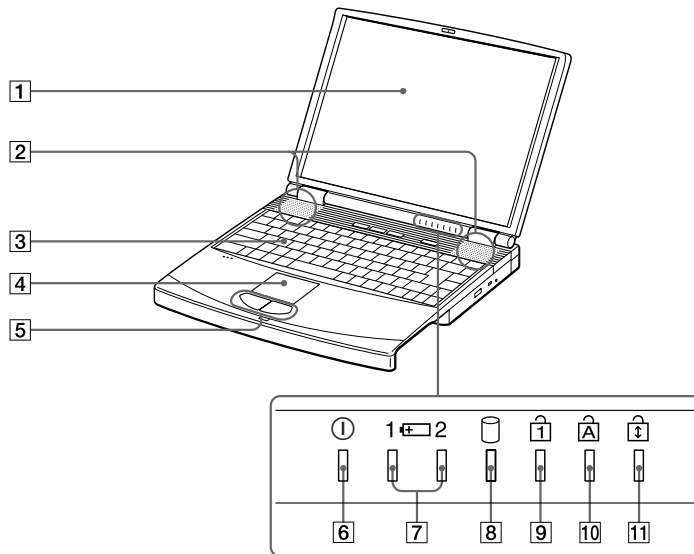

- |                     |                           |                                     |                           |                                 |                           |
|---------------------|---------------------------|-------------------------------------|---------------------------|---------------------------------|---------------------------|
| <b>1</b> LCD screen | <a href="#">(page 32)</a> | <b>5</b> Left/right buttons         | <a href="#">(page 34)</a> | <b>9</b> Num Lock indicator     | <a href="#">(page 31)</a> |
| <b>2</b> Speakers   | <a href="#">(page 32)</a> | <b>6</b> Ⓞ Power indicator          | <a href="#">(page 25)</a> | <b>10</b> Caps Lock indicator   | <a href="#">(page 31)</a> |
| <b>3</b> Keyboard   | <a href="#">(page 28)</a> | <b>7</b> Battery 1 and 2 indicators | <a href="#">(page 31)</a> | <b>11</b> Scroll Lock indicator | <a href="#">(page 31)</a> |
| <b>4</b> Touchpad   | <a href="#">(page 34)</a> | <b>8</b> Hard disk drive indicator  | <a href="#">(page 31)</a> |                                 |                           |





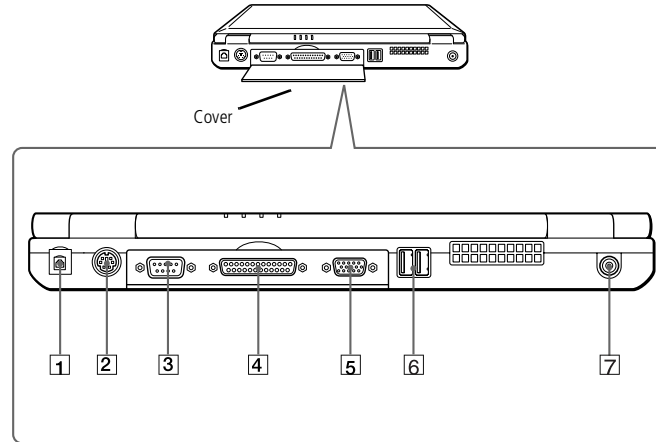

## Locating the Controls and Connectors

 There is a ventilation slot located near the USB connector. Do not cover the ventilation slot when your computer is on.

## Back



- |          |  |           |          |   |           |
|----------|--|-----------|----------|---|-----------|
| <b>1</b> | Phone Line jack  | (page 46) | <b>5</b> | Monitor connector   | (page 62) |
| <b>2</b> |  Mouse connector        | (page 72) | <b>6</b> |  USB connectors | (page 73) |
| <b>3</b> |  IO/IO Serial connector |           | <b>7</b> |  DC In          | (page 19) |
| <b>4</b> |  Printer                | (page 60) |          |   |           |

### Bottom

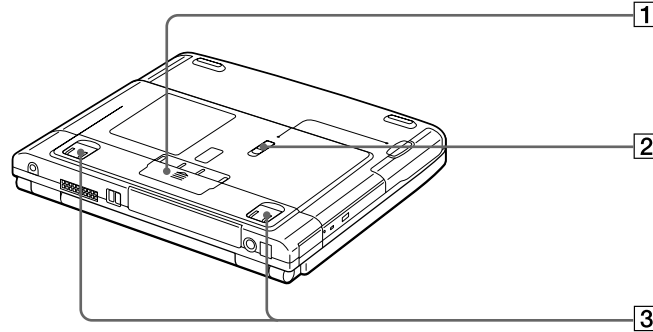

- 1** Port replicator connector cover
- 2** Release lever
- 3** Tilt stands

✎ Use your notebook only with the supplied AC adapter.

To disconnect your notebook completely from mains voltage, unplug the AC adapter.

Please make sure that the socket outlet is easily accessible.

✎ See the Compatibility table to verify which peripheral devices are compatible with your notebook.

## Connecting a Power Source

You can use either AC power or a rechargeable battery pack as a power source.

### Using the AC Adapter

- 1 Plug the cable attached to the AC adapter into the DC In connector on the computer.
- 2 Plug one end of the power cord into the AC adapter.
- 3 Plug the other end of the power cord into an AC outlet.

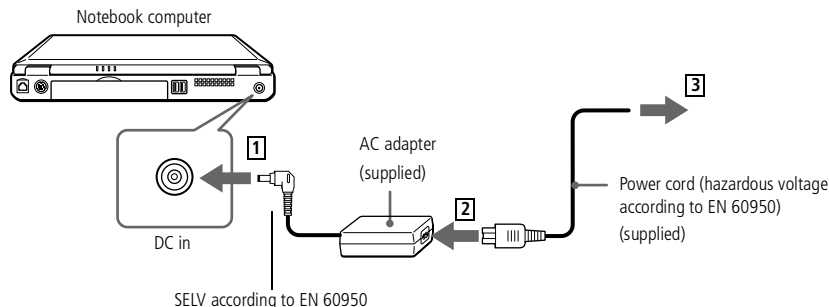

### Using Battery Power

You can use one or two batteries as a source of power. You can insert the second battery pack into the multi-purpose bay on the right side of the computer. (See **Locating the Controls and Connectors** on [page 14](#)). Additional battery packs are available as a separate option.

The battery pack supplied with your computer is not fully charged at the time of purchase. Follow the steps below to insert and charge the battery pack.

#### To insert the battery pack

- 1 Open the cover of the battery bay.

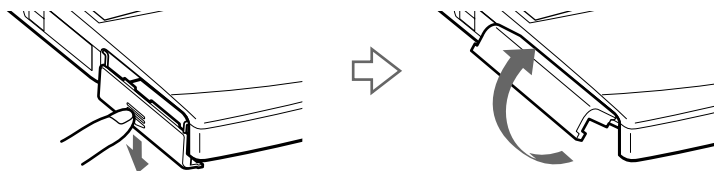

- 2 Insert the battery pack into the battery bay on the left side of the computer.

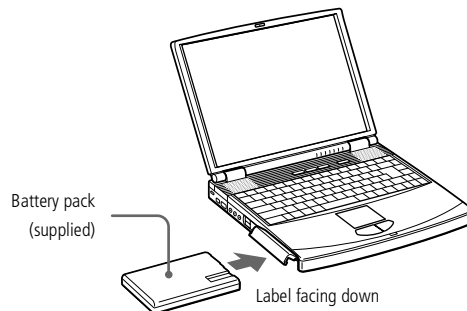

- 3 Close the cover of the battery bay until it clicks.



### To charge the battery pack

- 1 Connect the AC adapter to the computer.
- 2 Insert the battery pack.

The computer automatically charges the battery (the battery indicator light flashes in a double blink pattern as the battery charges). When the battery is 85 percent full, the battery indicator light turns off. This process takes approximately two hours. To charge the battery completely, continue charging for an additional hour.

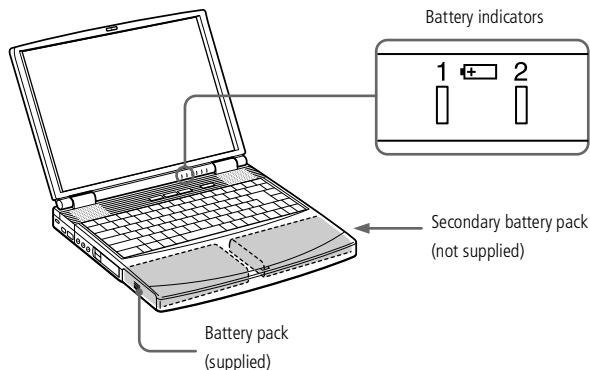
There is one battery indicator light on the computer:



<i>Battery Indicator</i>	<i>Meaning</i>
1 	Indicates the status of the battery pack in the battery bay on the left side of the computer.
 2	Indicates the status of the battery pack in the multi-purpose bay on the right side of the computer.

<i>Battery Indicator Light Status</i>	<i>Meaning</i>
On	The computer is using battery power.
Single blink	The battery is running out of power.
Double blink	The battery is charging.
Off	The computer is using AC power.

 For some software applications and some peripheral devices, your computer may not enter system hibernation mode when battery life is low. To avoid loss of data when using battery power, you should save your data frequently and manually activate a power management mode, such as **system suspend** or **system hibernation**.

When the battery is running out of power, both the battery and power indicators blink.

To determine the time the battery lasts, please refer to **Displaying Battery information** in your Software Guide.

Keep the battery pack in the computer while it is directly connected to AC power. The battery pack continues to charge while you are using the computer.

If the battery level falls to below 10%, you should either attach the AC adapter to recharge the battery or shut down your computer and insert a fully charged battery.

You can extend battery life by changing the power management modes in the PowerPanel utility. See your Software guide, in **Controlling Power Management**.

The battery pack supplied with your computer is a lithium ion battery and can be recharged at any time. Charging a partially discharged battery does not affect battery life.

The battery indicator light is on while you use the battery pack as a power source. When battery life is nearly depleted, the battery indicator starts flashing.

When the computer is directly connected to AC power and has a battery pack inserted in the battery bay, it uses power from the AC outlet.

## Connecting a Power Source

! You may lose data if you remove the battery pack while the computer is on and not connected to the AC adapter or if you remove the battery while the computer is in system suspend mode.

### *To remove the battery pack*

- 1 Open the cover of the battery bay.
- 2 Pull out the battery pack.



- 3 Close the cover of the battery bay.





## Starting Your Computer

- 1 Slide the LCD lock lever in the direction of the arrow, and lift the cover.

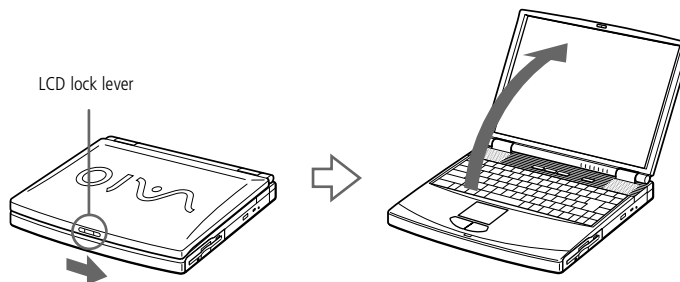

 If you press the power button for more than four seconds, the computer will turn off.

- 2 Press the power button of the computer until the green power indicator light turns on.

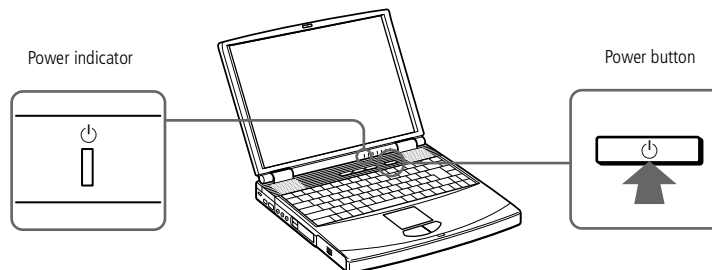

- 3 If necessary, adjust the brightness controls for the LCD display with **Fn+F5**. To increase the brightness, use the up or right arrow keys. To decrease use the down or left arrow keys.

! To avoid potential loss of data, follow these steps to shut down your computer.

📄 Respond to any prompts warning you to save documents.

📄 If you are unable to shut down your computer using the steps described above:

- close all software in use,
  - remove the PC cards if inserted,
  - disconnect any USB devices,
- then restart the computer.

If the previous steps do not work, see the Troubleshooting section of this User Guide.

During a period of inactivity, you can conserve battery life by using System Suspend mode. See Controlling Power Management in your Software Guide for further details.

## Shutting Down Your Computer

- 1 Click the **Start** button on the Windows® taskbar.
- 2 Click **Shut Down** at the bottom of the **Start** menu to display the **Shut Down** Windows dialog box.
- 3 Select **Shut down**.
- 4 Click **OK**.
- 5 Wait for your computer to turn off automatically. The power indicator will turn off.
- 6 Turn off any peripheral connected to your computer.

 You must connect your phone line before using any online services, including the online registration service.

See **Using the Modem** on [page 46](#)

 To access the online Registration web page, you must have a connection to the Internet.

## Registering Your Computer

You can take advantage of Sony's commitment to quality customer support and receive the following benefits by registering your computer with Sony:

- ❑ **VAIO-Link** – You can contact VAIO-Link by Internet or e-mail (see your Customer Service Guide for addresses).
- ❑ **Guarantee** – Protect your investment. See the Guarantee sheet for the terms and conditions and please refer to your Customer Service Guide for more information.

Follow these steps to use the Sony Notebook Computer's online registration service:

- 1 Click on the **Welcome** button on your desktop,
- 2 Click **Next**,
- 3 Click **Internet**,
- 4 Fill in your Registration card fields,
- 5 Scroll down to the bottom of the form and click **Send**,
- 6 Click **OK**.



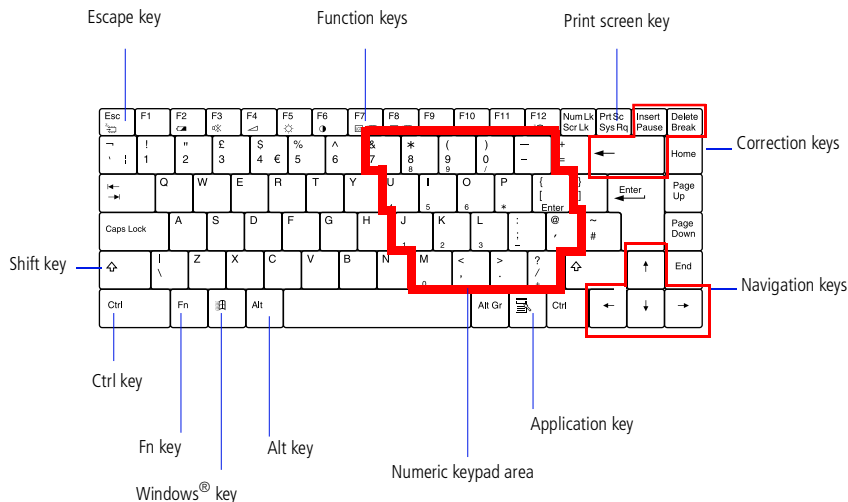

### Using the Keyboard

Your keyboard is very similar to a desktop computer's, but the keyboard has additional keys that perform specific notebook computer-related tasks.











Keys	Descriptions
Numeric keypad area	Contains the keys found on a typical calculator. Use the numeric keypad area to type numbers or to perform mathematical calculations such as addition and subtraction. Note that you must press the <b>Num Lock</b> key to activate the numeric keypad. When you do so, the Num Lock light will illuminate.
Navigation keys	Several keys are devoted to moving the cursor on the screen.







<i>Keys</i>	<i>Descriptions</i>
Correction keys	The <b>Insert</b> , <b>Back Space</b> , and <b>Delete</b> keys enable you to make corrections in your documents.
Function keys	The twelve function keys along the top of the keyboard are used to perform designated tasks. For example, in many applications, <b>F1</b> is the <b>Help</b> key. The task associated with each function key may vary from one application to the next.
Escape key	The <b>Esc</b> (Escape) key is used to cancel commands.
Print Screen key	The <b>Print Screen</b> key takes an electronic snapshot of the screen and places it in the Windows Clipboard. You can then paste the screen shot into a document and print it.
Operator keys	Several keys are always used with at least one other key: <b>Ctrl</b> , <b>Alt</b> , and <b>Shift</b> . When held down with another key, the <b>Ctrl</b> (Control) and <b>Alt</b> (Alternate) keys offer another way to give commands. For example, in many applications, instead of choosing the <b>Save</b> command from a menu, you can hold down <b>Ctrl</b> and press <b>S</b> (referred to as Ctrl+S). The <b>Shift</b> key is used to produce capital letters or special symbols such as @ and \$.
Windows <sup>®</sup> key 	The key with the <b>Windows<sup>®</sup> logo</b> displays the Windows <sup>®</sup> Start menu; it's the equivalent of clicking the Start button on the task bar. See <b>Combinations and functions with the Windows<sup>®</sup> key</b> for further details.
Fn key	The <b>Fn</b> key is used in combination with other keys to issue commands. See <b>Combinations and functions with the Fn key</b> .

<i>Keys</i>	<i>Descriptions</i>
Applications key 	The <b>Applications</b> key displays a shortcut menu of context-sensitive choices; pressing this key is the equivalent of clicking the <b>right mouse</b> button.

### *Combinations and Functions with the Windows® Key*







<i>Combinations</i>	<i>Functions</i>
 + F1	Displays Windows Help
 + Tab	Switches the selected button on the taskbar.
 + E	Displays Windows Explorer.
 + F	Displays the <b>Windows Find: All Files</b> window to find a file or folder. This is the equivalent of selecting <b>Find</b> and then <b>Files or Folders</b> from the <b>Start</b> menu.
 + Ctrl + F	Displays the <b>Windows Find: Computer</b> window where you can locate other computers. This is the equivalent of selecting <b>Find</b> and then <b>Computer</b> from the <b>Start</b> menu.
 + M	Minimizes all displayed windows.
Shift +  + M	Returns all minimized windows to their previous size.
 + R	Displays the <b>Run</b> window. This is the equivalent of selecting <b>Run</b> from the <b>Start</b> menu.
Fn +  + Insert	Displays the <b>System Properties</b> window. This is the equivalent of double-clicking the <b>System</b> icon in the <b>Control Panel</b> .

*Indicators*







<i>Indicator</i>	<i>Functions</i>	
Power 	Power on: lights green. System Idle mode: lights amber. System suspend mode: flashes amber.	
Battery 1  1	Indicates the status of the battery inserted in the battery bay on the left side of the computer.	
 2	Indicates the status of the battery inserted in the multi-purpose bay on the right side of the computer.	
Hard disk 	Lights when data is read from or written to the hard drive. Do not enter System Suspend mode or turn off the computer when this indicator light is on.	
<i>Light</i>	<i>On</i>	<i>Off</i>
 Hard disk	Data is read from or written to the hard drive. Do not enter System Suspend mode or turn off the computer when this indicator light is on.	The hard drive is not being accessed.
 Num Lock	Turns on when the number keys area in the numeric keypad are active.	Turns off when the alphanumeric character keys in the keypad area are active.
 Caps Lock	Turns on when the letters appear in uppercase as you type. The Shift key lowers the case of typed letters when Caps Lock is on.	Turns off when letters appear in lower case as you type (unless if you hold down the Shift key).

 Scroll Lock	Turns on when the screen scrolls differently. (depends on the application. No effect in many applications.)	Turns off when information moves across the display normally.
---	---	---

### Combinations and Functions with the Fn Key

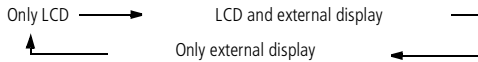
Combinations/Feature	Functions
Fn+  (ESC) System Suspend	Puts the system into System Suspend mode, a power management state. To return the system to the active state, press any key.
Fn+  (F2) Display power status	Display power status
Fn+  (F3) Speaker switch	Toggles the built-in speaker on and off.
Fn+  (F4) Speaker volume	Adjusts the built-in speakers' volume. To increase volume, press <b>Fn+F4</b> and then <b>↑</b> or <b>→</b> To decrease volume, press <b>Fn+F4</b> and then <b>↓</b> or <b>←</b>
Fn+  (F5) Brightness control	Adjusts the brightness of the LCD. To increase light intensity, press <b>Fn+F5</b> and then <b>↑</b> or <b>→</b> To decrease light intensity, press <b>Fn+F5</b> and then <b>↓</b> or <b>←</b>
Fn+  (F6) Contrast control	Not available



<i>Combinations/Feature</i>	<i>Functions</i>
Fn+  /  (F7) Switch to the external display	Toggles between the LCD, external display (connected to the Monitor connector) and both LCD and external display. 
Fn+  /  (F8)	Toggles between the LCD and both LCD and TV. Only LCD ↔ LCD and TV. See <b>AV Devices</b> on <a href="#">page 65</a>
Fn+  (F12) System Hibernation	Provides for the lowest level of power consumption. When you execute this command, the states of the system and of the peripheral devices are written to the hard disk and the system power is turned off.
Fn+S System Idle	Puts the system into Idle mode, a power management state. To return to the active state, press any key.

## Using the Touchpad

See Mouse Help for information on touchpad features, such as clicking both buttons simultaneously, adjusting touchpad speed, Web Assist, Tap Off, and Easy Launcher functions. To access **Mouse Help**, press the **Start** button, select **Settings**, and then select **Control Panel**. Click the **Mouse** icon and then click the **Help** button.

## Using the Touchpad

The keyboard contains a cursor-pointing device called a touchpad. You can point to, select, drag, and scroll objects on the screen using the built-in touchpad.

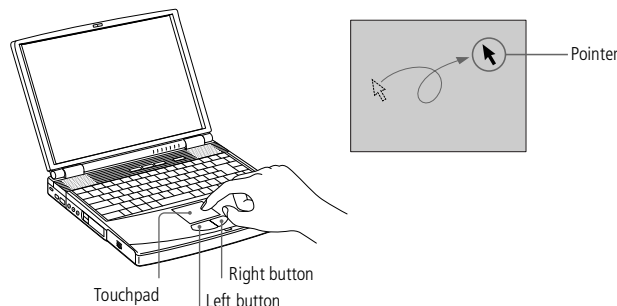

Action	Description
Point	Slide one finger on the touchpad to place the pointer on an item or object.
Click	Press the left button once.
Double-click	Press the left button twice.
Right-click	Press the right button once. In many applications, this action displays a shortcut menu of context-sensitive choices.
Drag	Slide one finger while pressing the left button.
Scroll	Move your finger along the right edge of the touchpad to scroll vertically. Move your finger along the bottom to scroll horizontally. (The scroll function is available only with applications that support a touchpad scroll feature.)

## Using the Floppy Disk Drive

The computer comes with the floppy disk drive in the multi-purpose bay.

*To insert a diskette*

- 1 Hold the diskette with the label side facing up.
- 2 Gently push the diskette into the drive until it clicks into place.

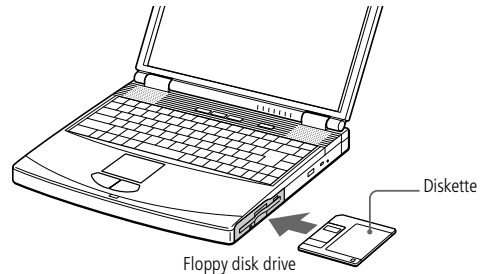

## Using the Floppy Disk Drive

 If you have difficulty removing a diskette from the floppy disk drive, remove the floppy disk drive from the multi-purpose bay.

Do not press the Eject button when the LED indicator is turned on. Otherwise, data may be lost.

*To remove a diskette*

- When you finish using the diskette, wait until the LED indicator turns off and then press the Eject button to remove the diskette.

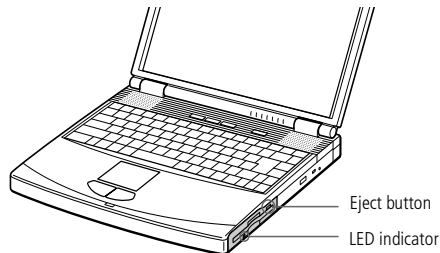
*To remove the floppy disk drive*

- 1 Turn off the computer.
- 2 There is a RELEASE lever on the bottom of the computer. Slide this lever in the direction of the arrow.

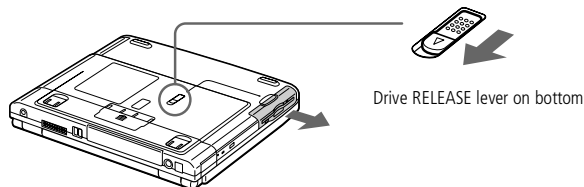

- 3 Slide the drive out of the multi-purpose bay.
- 4 Insert the weight saver.

See **Using the Weight Saver** on [page 53](#)

## Using the Floppy Disk Drive

### To re-insert the floppy disk drive

- 1 Turn off the computer.
- 2 If another device is in the multi-purpose bay, remove the device. See **To remove the second battery pack**.
- 3 Insert the floppy disk drive into the multi-purpose bay with the metallic part up. Continue pushing the drive into the bay until the RELEASE lever locks into place.

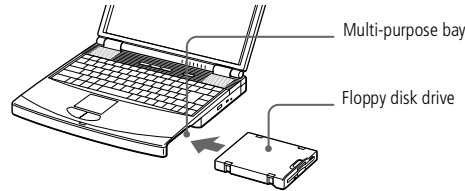

## Using the DVD-ROM Drive

Your computer is equipped with a DVD-ROM drive.

The DVD-ROM drive plays both DVD-ROM and CD-ROM disks.

### To insert a disk

- 1 Turn on the computer.
- 2 Press the Eject button to open the DVD-ROM drive. The tray slides out.

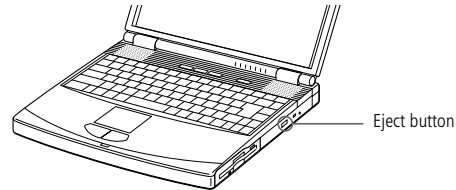

- 3 Place a CD-ROM disk in the tray with the label side facing up. Push the disk onto the hub until the disk clicks into place.

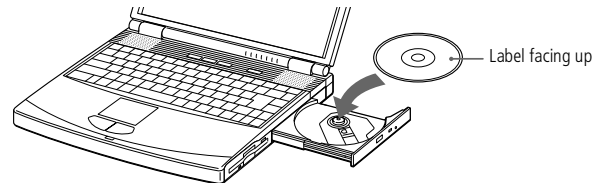

- 4 Close the tray by pushing it gently.

- ✎ When the computer is in **System Suspend** or **System Hibernation** mode, you cannot insert a disk.
- ✎ Be sure to seat the disk firmly over the disk drive hub fingers. If you do not seat the disk firmly, you could damage your disk drive and you may not be able to open the tray.

When you finish using a disk, wait until the LED indicator turns off and then press the Eject button to remove the disk.

When the computer is in **System Suspend** or **System Hibernation** mode, you cannot remove a disk. See the chapter **System Suspend Mode** for more information about System Suspend and System Hibernation modes.

If the disk does not come out when you press the Eject button, turn off the computer and insert a thin, pointed object into the manual eject hole.

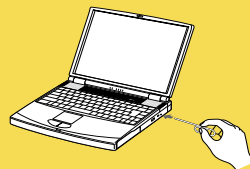

#### *To play DVD-ROM disks*

To achieve optimum performance when playing DVD-ROM disks, you should use the following recommendations.

- ❑ Your computer should not be connected to the port replicator while playing DVD movies or using DVD applications.
- ❑ Close any open applications before playing a DVD-ROM movie.

 When playing DVD movies on battery power, set the power management profile to DVD. With other profiles, the movies are choppy.

Depending on the display setup properties you selected, you may use **Fn+F** command to expand the screen to full screen size.

 Region codes indicators are labeled on the DVD disks to indicate in which region and what type of player can play the disc. Unless a "2" or "ALL" is labeled on your DVD disk or on the packaging, you cannot play the disk on this player.

Do not try to change the region code setting of the DVD-ROM drive. Any troubles caused by changing the region code setting of the DVD-ROM drive are out of warranty.

When a DVD video disk is inserted in the DVD-ROM drive, you cannot toggle between LCD and TV by pressing **Fn+F8**.

For additional information on playing DVD video disks, please refer to the Media Bar Help.



## Using PC Cards

Your computer includes two PC card slots. PC cards allow you to connect portable external devices.

### *To insert a PC card*

Use the lower slot for PC type III cards.

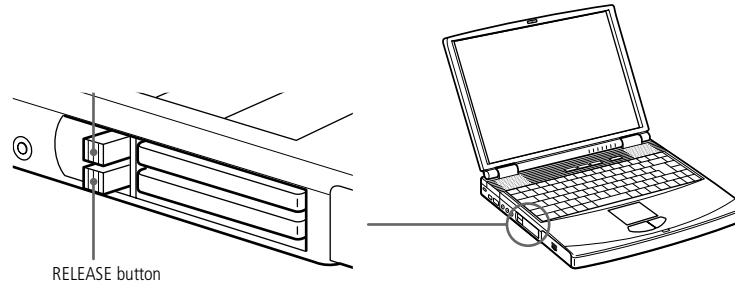



- ! Some devices may not function properly if you repeat Returning to Normal Mode from System Suspend Mode or System Hibernation mode.
- ! The computer will return to its original state if you restart it.

## Using PC Cards

 Do not force a card into the slot. It may damage the connector pins. If you have difficulty inserting a card, check that you are inserting the card with the correct orientation. See the manual supplied with your PC card for more information on use.

For some PC cards, if you alternate between normal power operation and the system suspend or system hibernation power management modes while the card is inserted, you may find that a device connected to your system is not recognized. Reboot your system to correct the problem.

 Before you remove the PC card, click the PC card icon in the task tray and close the card. Close any applications that use the PC card before removing the card. Otherwise, data may be lost.

 The PC card slots can accommodate (at the same time) two Type I, two Type II, or one Type III PC card. These slots are compatible with Card Bus port.

Some PC cards may require that you disable idle devices when using the PC card. You can use Sony Notebook Setup to disable devices. See your Software guide, in "Sony Notebook Setup" for details.

Be sure to use the most recent software driver provided by the PC card manufacturer.

If an "!" mark appears on the Device Manager tab in the System Properties dialog, remove the software driver and then reinstall it.

You may not be able to use some PC cards or some functions within the PC card with this computer.

You do not need to shut down the computer before inserting or removing a PC card.

Insert the PC card into the PC card slot, front label facing up. Gently push the card into the slot until the card is fixed into the connector. The release button will then come out. Pull the release button, then knock it down towards the slot.

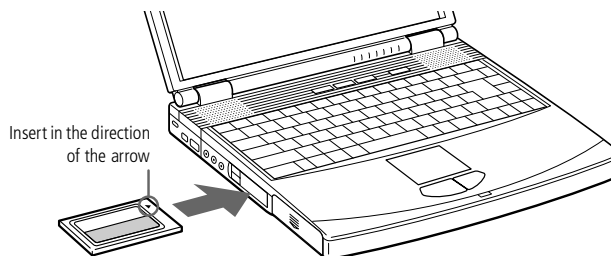

*To remove a PC card*

Follow the steps below to remove a PC card while your computer is on. If the PC card is not properly removed, your system may malfunction. When your computer is off, skip steps 1 to 6.

- 1 Click the **Start** button on the Windows® taskbar, point to **Settings**, then click **Control Panel**.
  - 2 Double-click **Add/Remove Hardware**.
  - 3 Click **Next**, click **Uninstall/Unplug a device**, and then click **Next**.
  - 4 Select the name of the appropriate PC card in the list, and then click **Next**.
  - 5 Click **Next** to confirm that you want to unplug the PC card.
  - 6 Click **Finish**.
  - 7 Press the PC card release button.
  - 8 Gently grasp the card and pull it out.
-

## Using Programmable Power Keys (PPK)

Press a programmable power key to start your favorite software without having to click the shortcuts on the desktop.

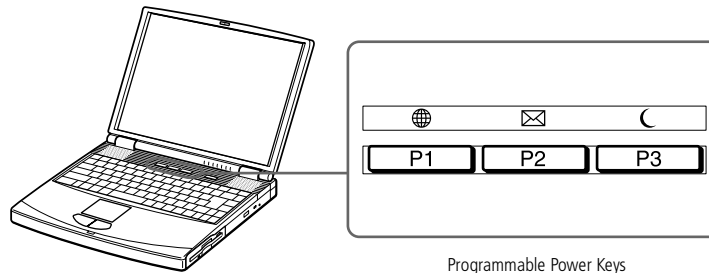

### PPK default options

Use a programmable key by simply pressing it, or in combination with other keys on your keyboard: Shift + PPK, Ctrl + PPK or Alt + PPK.

When your computer is off, press PPK, and the system will be powered and launch the appropriate application.

The factory settings for the buttons are:

<i>Key or combination</i>	<i>To open or access...</i>
P1	The Club VAIO Web site
P2	E-mail (Outlook Express)
P3	System Suspend Mode (Sleep)

## Using Programmable Power Keys (PPK)

<i>Key or combination</i>	<i>To open or access...</i>
Alt + P1	The VAIO-Link Web site
Shift + P1	The VAIO Web site
Ctrl + P1	Internet Explorer
Ctrl + P3	The EULA



 \* A country-specific phone plug is supplied with your VAIO notebook computer, allowing you to plug the phone line into the wall jack.

 Your computer cannot be connected to a coin-operated telephone, and may not work with multiple phone lines or a private branch exchange (PBX). Some of these connections may result in excess electrical current and could cause a malfunction in the internal modem.

 Phone cable and connectors are TNV (Telecommunications Network Voltage), according to EN60950.

Only DTMF (Dual Tone Multi Frequency) signalling (tone dialling) is supported.

## Using the Modem

Your notebook computer is equipped with an internal modem. Before using your modem, please read the instructions in **Configuring the Modem for use** in your Software Guide.

### Connecting a Phone Line

You need to connect a phone line to take advantage of online services and the Internet, to register your computer and software online, and to contact VAIO-Link.

- 1 Plug one end of the phone cable into the phone line jack on the computer.

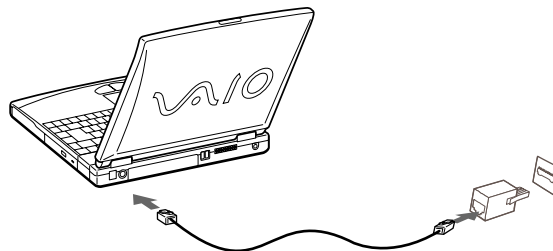

- 2 Plug the other end into the wall jack. \*

✎ When you use Smart Connect to connect two VAIO computers, you must assign each computer a unique name by which it can be identified when the two computers are networked.

✎ i.LINK™ cables compatible with your VAIO notebook include cables with the following part numbers: VMC-IL4415 (a 1.5 meter cable with a 4-pin connector at each end), VMC-IL4408Series (a 0.8 meter cable with a 4-pin connector at each end).

✎ See the Compatibility table to verify which peripheral devices are compatible with your notebook.

## Using Smart Connect and Smart Connect Monitor

With Smart Connect you can copy, edit or delete files on another VAIO computer (equipped with Smart Connect) connected to your computer with an i.LINK™ cable.

You can also print a document on a printer connected to another VAIO computer.

See the online documentation of Smart Connect and Smart Connect Monitor for more information.

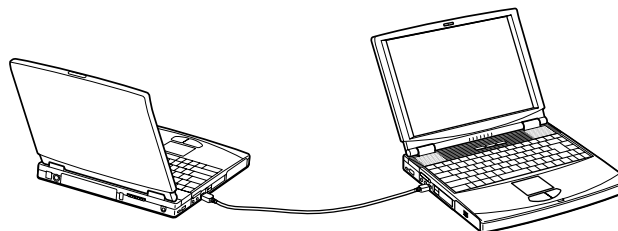

i.LINK™ cable  
(not supplied)

 If the battery level falls to below 10 percent, you should either attach the AC adapter to recharge the battery or shut down your computer and insert a fully charged battery.

## Using Power Saving Modes

When you use a battery as the source of power for your computer, you can take advantage of power management settings to conserve battery life. In addition to the normal operating mode, which allows you to turn off specific devices, your computer has three distinct power saving modes: **System Idle**, **System Suspend** and **System Hibernation**.

When using battery power, you should be aware that the computer automatically enters System Hibernation mode when the remaining battery charge drops below 7 percent, regardless of the power management setting you select. See your Software guide, in **Controlling Power Management** for more information.

### Normal Mode

This is the normal state of your computer when it is in use. The green power indicator light is on in this mode. To save power, you can turn off a specific device such as the LCD or the hard disk.

### System Idle Mode

This mode is convenient if you don't need to use your computer for a short period. The hard disk and the video display enter a low power state and the CPU clock and processor stop. The power indicator light is amber in this mode.

#### *To activate System Idle mode*

Press **Fn+S**. You can also enter system Idle mode by using the PowerPanel utility.

#### *To return to normal mode*

Press any key.



 If you press the power button for more than four seconds, the computer will turn off.

 When the computer is in **System Suspend** or **System Hibernation** mode, you cannot insert a disk.

### System Suspend Mode

The computer saves the current state of the system in RAM and switches off power to the CPU. The amber power light flashes in this mode.

#### To activate System Suspend mode

Press **Fn+Esc**, or press the power button quickly. You can also use the PowerPanel utility to enter **System Suspend** mode.

#### To return to normal mode

Press any key.

### System Hibernation Mode

The state of the system is saved on the hard disk and power is turned off. The power indicator light is off in this mode.

#### To activate System Hibernation mode

Press **Fn+F12**. You can also use the PowerPanel utility to **enter System Hibernation** mode.

#### To return to normal mode

Turn on the computer by pressing the power button. The computer returns to its previous state.

- Steps to return to normal mode:
- System hibernation → System suspend → System Idle
- System suspend requires less time than System hibernation.
- Power consumption:
- System idle → System suspend → System hibernation
- System idle uses more power than System hibernation.

✎ To determine the time the battery lasts, see **Displaying Battery information** in your Software Guide.

✎ If you attach two battery packs, you can remove either of them without shutting down the computer. When removing one battery pack, make sure that the other battery pack's indicator is on. If the indicator of the battery pack you are going to remove is on, right-click  on the task tray and click the **switch discharge battery** menu.

## Using a Second Battery Pack

You can purchase a second rechargeable battery pack. With two battery packs, you can extend the time that you use your computer with battery power. When using two battery packs, the battery pack you insert first charges first. The battery pack you insert second charges when the first battery pack is 85 percent full. You can monitor which battery pack is charging by observing the battery indicator lights.

### To insert a second battery pack

- 1 If the floppy disk drive is in the multi-purpose bay, remove the device.
- 2 See **Using the Floppy Disk Drive** on [page 35](#)
- 3 Insert the battery pack into the multi-purpose bay.
- 4 The battery 2 indicator light turns on.

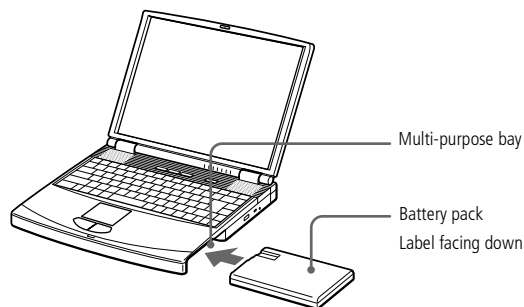

- 5 Attach the Weight Saver to the computer to stabilize the battery pack. Slide the eject lever on the bottom of the Weight Saver toward the front of the computer to lock it. See **Using the Weight Saver** on [page 53](#).

## Using a Second Battery Pack

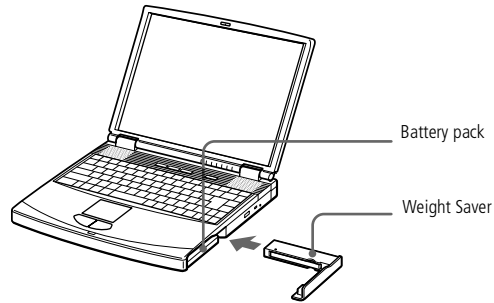

To charge the second battery pack

Keep the battery pack in the computer while it is connected to AC power. The battery indicator flashes while the battery is charging.

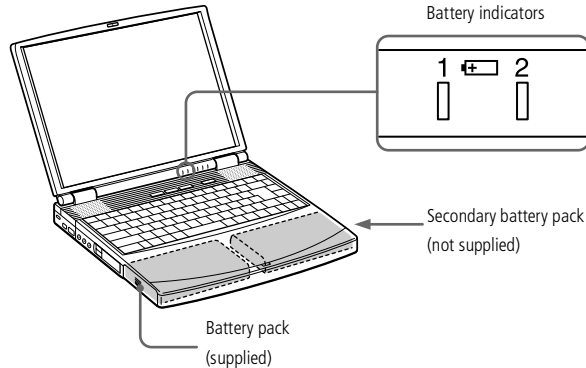

### To remove the second battery pack

- 1 There is an Eject lever on the bottom of the weight saver. To remove the battery pack, slide this lever in the direction of the arrow 1, then slide the RELEASE lever on the bottom of the computer in the direction of the arrow 2.

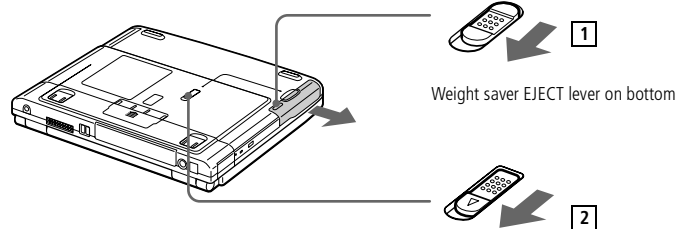

- 2 Remove the weight saver, and then pull out the battery pack.
- 3 Reinsert the weight saver.



## Using the Weight Saver

The weight saver protects the multi-purpose bay when it is empty.

### To attach the Weight Saver

- 1 If another device is in the multi-purpose bay, remove the device.
- 2 Pull out the guide of the multi-purpose bay and slide the weight saver in the direction of the arrow until it clicks.

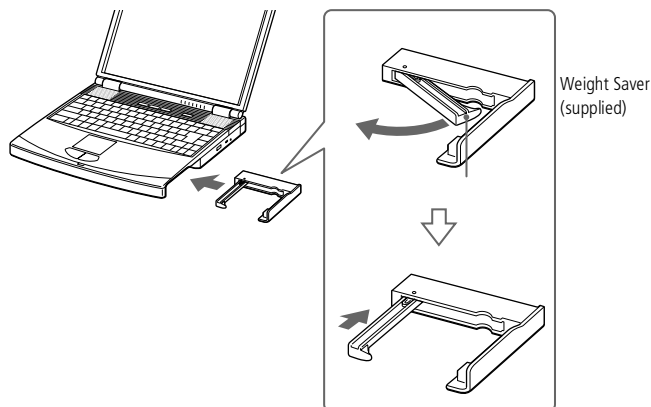

## Using the Weight Saver

### To remove the Weight Saver

To remove the weight saver, slide the Eject lever of the weight saver in the direction of the arrow 1, then slide the RELEASE lever on the bottom of the computer in the direction of the arrow 2.

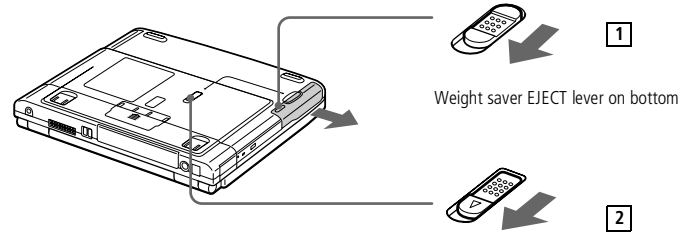

 Before you connect peripherals, turn off the computer and all peripherals.

Connect the power cord only after connecting all cables.

Turn on the computer only after turning on all peripherals.

## Connecting peripheral devices

You can add functionality to your computer by connecting or using any of these peripherals and enjoy the software described in the **About the Software** user guide:

- Port Replicator ([page 56](#))
- Printer ([page 60](#))
- External Display ([page 62](#))
- AV Devices ([page 65](#))
- Memory Sticks™ ([page 66](#))
- Digital Video Camera Recorder ([page 67](#))
- MiniDisc® deck with MD Player ([page 70](#))
- Universal Serial Bus (USB) Device ([page 73](#))
- External Speakers ([page 74](#))
- External Microphone ([page 75](#))

## Port Replicator

 The port replicator can be powered only with the AC adapter supplied with your notebook or the optional PCGA-AC19V AC adapter. Do not remove the AC adapter from the port replicator or the AC outlet while using the port replicator; this may cause data damage or hardware malfunctions.

All connectors are SELV (Safety Extra Low Voltage) according to EN60950.

To disconnect your port replicator completely from the mains voltage, unplug the AC adapter.





When attaching your computer to the port replicator, do not attempt to insert or remove the battery pack. Lifting and turning the computer with the attached port replicator may cause a temporary loss of power.

Please make sure that the socket outlet is easily accessible.

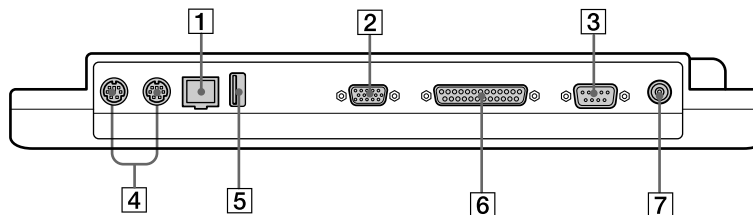
## Port Replicator

Your notebook computer supports the use of an optional port replicator. Attaching a port replicator enables you to connect additional peripherals to your computer.



- |   |  |
|---|--|
| <b>1</b> Network (ethernet)   | <b>5</b>  USB <a href="#">(page 73)</a>     |
| <b>2</b>  Monitor <a href="#">(page 62)</a>        | <b>6</b>  Printer <a href="#">(page 60)</a> |
| <b>3</b> IO/IO Serial   | <b>7</b>  DC In <a href="#">(page 57)</a>   |
| <b>4</b>  Mouse/Keyboard <a href="#">(page 72)</a> |  |

*To attach your computer to the port replicator*

To supply power to your computer while it is connected to the port replicator, you must connect the AC adapter directly to the port replicator.

- 1 Turn off your computer and disconnect all peripherals.
- 2 On the bottom of the computer, lift the port replicator port cover.



## Port Replicator

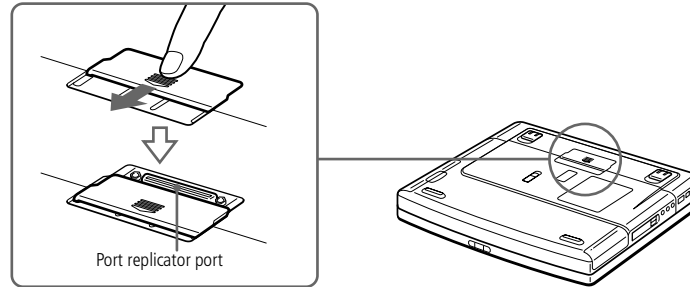

- 3 Attach the bottom of the computer to the port replicator connector until it clicks.

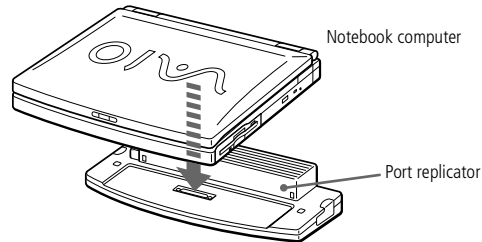

- 4 Plug the cable attached to the AC adapter into the DC IN connector on the port replicator. Plug the power cord into the AC adapter and an AC outlet.

## Port Replicator

When you use the port replicator for the first time, the installation of the network driver starts automatically.

The floppy disk supplied with your Port Replicator is useless.

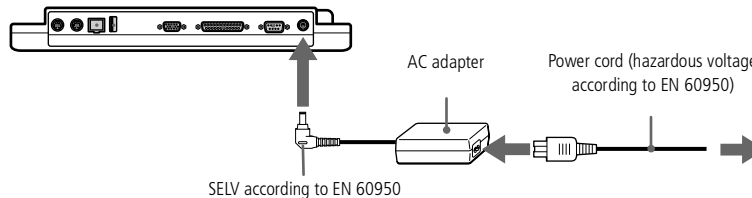

5 The power indicator light turns green.

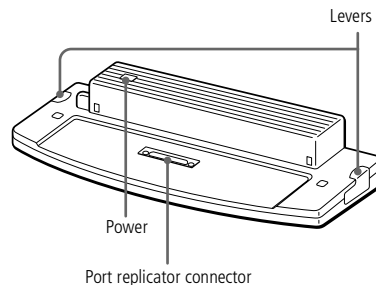

6 Turn on the computer.

## Port Replicator

### *To disconnect your computer from the port replicator*

- 1 Turn off your computer and the connected peripherals.
- 2 Pull the levers on each side of the port replicator to disengage the computer from the port replicator.
- 3 Lift the computer away from the port replicator.
- 4 Close the port replicator connector cover on the bottom of your computer.

 It is extremely important to close the port replicator connector cover after removing your computer from the port replicator. If the cover is left open, dirt may get inside and damage the computer.



## Printer

You can connect a Windows-compatible printer to your computer to print documents.

### To connect a printer using the USB connector

You can connect a USB printer compatible with your version of Windows® to your computer.

- ❑ Use the  symbol to locate the USB port on your computer and printer.
- ❑ Plug an optional USB printer cable into the USB connector.

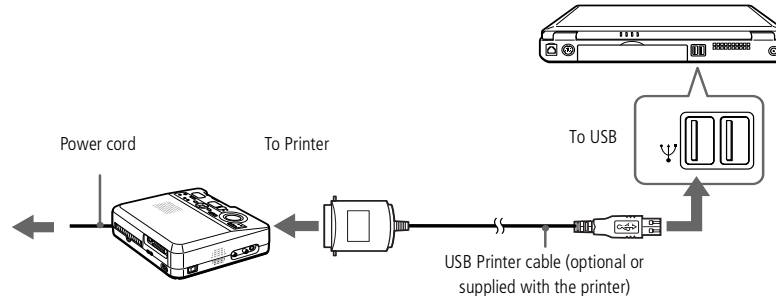

### To connect a printer using the Printer connector

- ❑ Use the  symbol to locate the Printer connector. Plug the printer cable (supplied with the printer) into this port on the computer.

## Printer

- ✎ See the manual supplied with your printer for more information on installation and use.
- ✎ Before using the printer, you may need to change the Printer setting in the Sony Notebook Setup software. Please refer to **Sony Notebook Setup** in the Software Guide for further details.

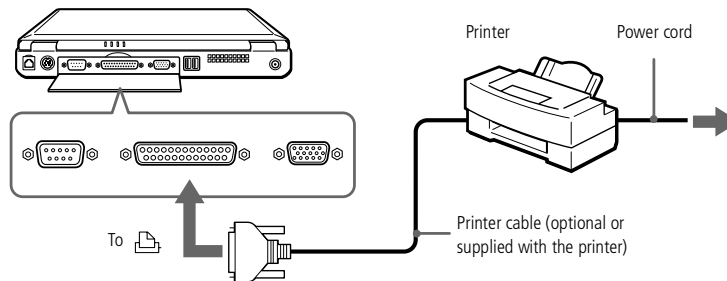

See the manual supplied with your peripheral for more information on installation and use.

## External Display

You can connect an external display to your notebook computer. For example, you can use the computer with any of the following:

- ❑ Computer display (monitor),
- ❑ Multimedia computer display,
- ❑ Projector.

Connected external displays are used as second screens.

On Windows® systems only, you can also use an external display to set up a virtual desktop (Please refer to **Using the Dual Display Function** in your Software Guide for further details).

### To connect a computer display

- 1 Use the  symbol on the computer to locate the Monitor connector. Plug the display cable into this connector.
- 2 If necessary, plug one end of the display power-cord into the display, and the other end into an AC outlet.

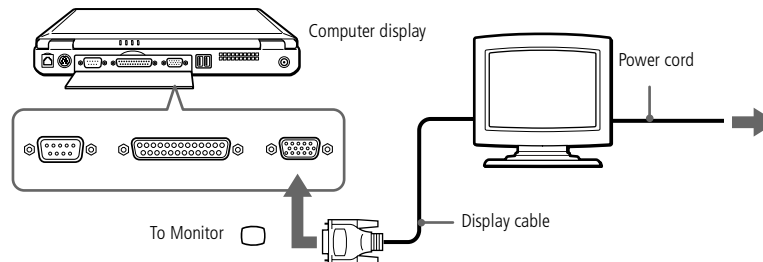

*To connect a multimedia computer display*

You can connect the notebook computer to a multimedia computer display that includes built-in speakers and a microphone.

- 1 Use the □ symbol to locate the Monitor connector. Plug the display cable into this connector.
- 2 Use the 🎧 symbol to locate the Headphone connector. Plug the speaker cable into this connector.
- 3 Use the 🎤 symbol to locate the Microphone connector. Plug the microphone cable into this connector.

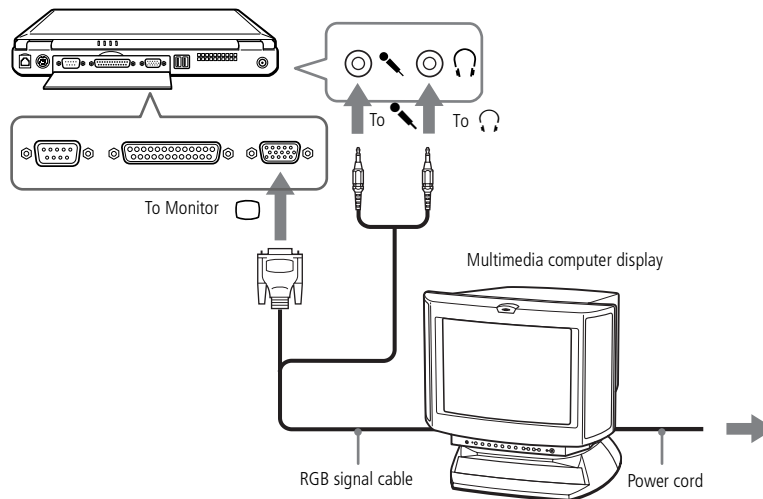

## External Display

✎ See the manual supplied with your projector for more information on installation and use.

You may not be able to display the computer's LCD and the external display together, depending on the types of computer display and projector used.

### Connecting a projector

You can use a projector such as the Sony LCD Projector as an external display.

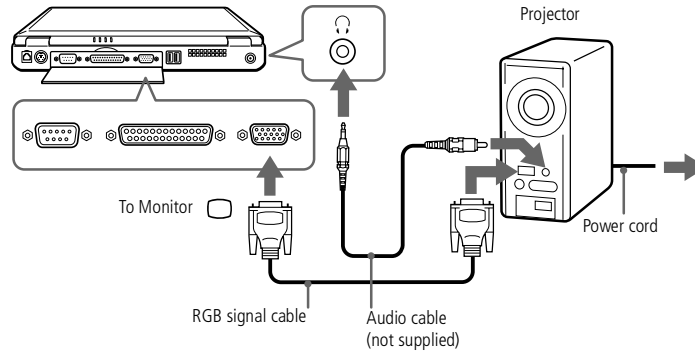

### To select a display

When you connect an external display to the monitor connector, you can toggle the output between the notebook LCD-screen, the external monitor, or both devices.

Use the **Fn+F7** keys to select a display. Please refer to **Selecting the Display Mode** in your Software guide for more information.

To	Press	Result
Switch to an external display	Fn+F7	Toggles between the LCD, the external display connected to the Monitor connector, and both the LCD and external display.



See the manual supplied with your peripheral for more information on installation and use.

If you insert a DVD in your DVD drive to watch a video on your TV, the **Fn+F8** key combination might not activate the function to toggle between your LCD and TV.

Solution:

1. Eject your DVD from your computer.
2. Once the DVD is ejected, toggle between your LCD and your TV with the combination **Fn+F8**.

Your image displays now on both LCD and TV. Re-insert your DVD to launch your DVD software.

## AV Devices

You can enjoy playing audio/video by connecting AV devices to your computer. See also the manuals supplied with your AV devices.

### To connect a TV

Connect the computer to a TV using audio/video cables. Switch the input channel of the TV to external input. You also need to set up the TV configuration system.

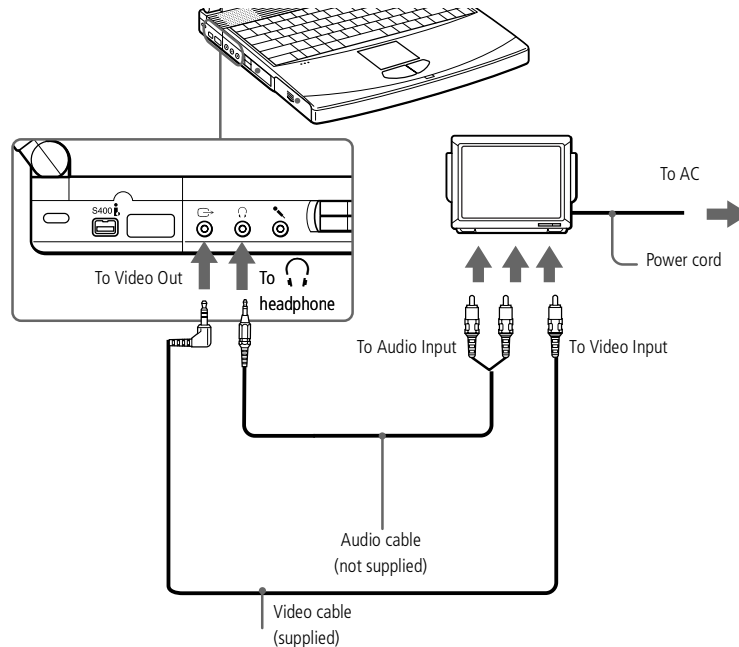

## Memory Sticks™

You can enhance the memory of your digital camera or other digital device with Memory Sticks™. To transfer your data to your computer, insert the Memory Stick™ into the PC Card slot:

- 1 Once you have stored your data from your digital device, insert the Memory Stick™ into the optional PC Card Adapter.
- 2 Insert the PC Card into the slot on your computer (label facing up), push it gently until the release button ejects completely and put back the release button.
- 3 The Memory Stick™ is automatically detected by your system and appears in your **My Computer** window as a local drive, under the appropriate letter (depending on the configuration of your computer).

Please refer to your Memory Stick™ user guide for precautions and specifications.

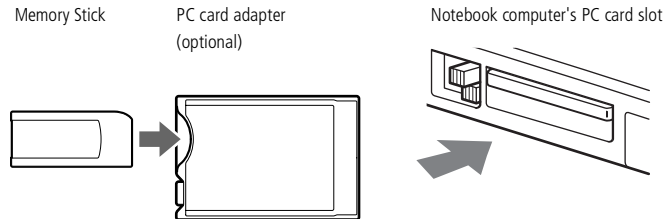

## Digital Video Camera Recorder

You can connect a digital video camera recorder to the i.LINK™ (IEEE1394) connector and use the editing features of the DVgate application.

### To connect a digital video camera recorder

- 1 Plug one end of the i.LINK™ cable into the i.LINK™ connector of the computer and the other end into the DV Out connector on the digital video camera recorder.

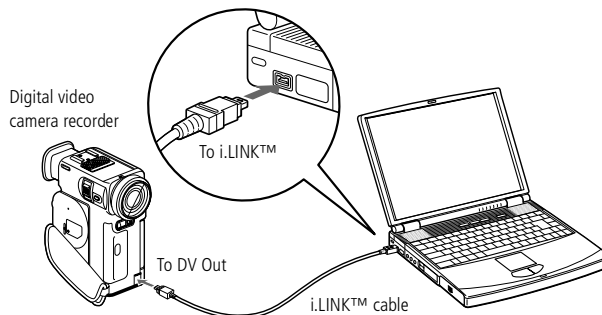

- 2 Launch the DVgate application. Please refer to **DVgate** in your Software Guide for further details.

 The Sony digital video camera recorder is taken as example; your digital video camera recorder may need to be connected differently.

See the manual supplied with your digital video camera recorder for more information on installation and use.

Do not connect more than one digital video camera at a time. The software supplied with your computer will not recognize multiple cameras.

The software limits the use of more than one digital video camera recorder or i.LINK™ device at the same time.

On Sony digital video cameras, connectors labeled “DV Out”, “DV In/Out” or “i.LINK™” are i.LINK™-compatible.

The i.LINK™ connector of your notebook computer does not supply power to external devices generally powered by i.LINK™ connectors.

The i.LINK™ connector supports transfer rates up to 400 Mbps; however, the actual transfer rate depends on the transfer rate of the external device.

The i.LINK™ features available may vary depending on the software applications you use. Please refer to the documentation that came with your software for more information.

 See the Compatibility table to verify which peripheral devices are compatible with your notebook.

See the manual supplied with your peripheral for more information on installation and use.

### To use diskettes with the Digital Mavica

The Digital Mavica provides you still images you can copy and edit on your computer, using PictureGear software.

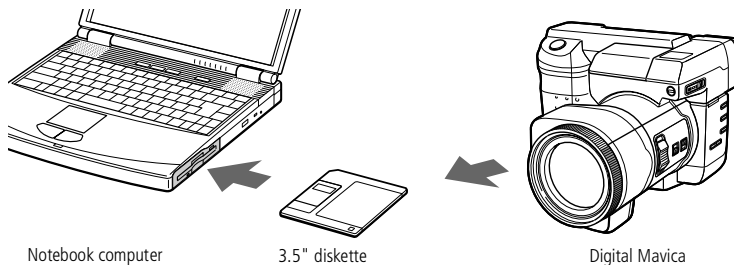

Follow these steps to transfer the images from your Digital Mavica:

- 1 Insert the diskette of the Mavica in the FDD drive of your computer and copy them into a dedicated folder.
- 2 Launch the application and open the image to edit or drag and drop it onto the application shortcut. Make the changes you want to the image.
- 3 Save it under the new name and format, if needed.

### Using Memory Sticks

If your digital camera includes a Memory Stick slot, you can copy images from it to your computer via a Memory Stick.

Copy images on the Memory Stick and insert it into the optional Memory Stick/PC Card Adaptor, then insert the adaptor into the PC card slot of your computer.

✎ See the manual supplied with your peripheral for more information on installation and use.

✎ Refer to your MD deck and CD player manuals to check the specifications.

For further information or if you are not sure of the connection capabilities of your devices, please contact your dealer.

To perform a copy using your computer, you need two CONTROL A1 or Control A1 II and one optical cables, which are maybe sold separately. To purchase them, please contact your dealer.

## MiniDisc® deck with MD Player

Use the inter-connectivity and common protocols between Sony audio equipment and your VAIO computer to enjoy the high quality of sound and recordings through optical data transfer.

When you connect a Sony MD deck equipped with a CONTROL A1 or Control A1 II terminal to a Sony CD player (equipped with both digital optical output and CONTROL A1 connector), you can record and edit your MiniDiscs® via your computer. Please refer to MD Player in your Software Guide for a description of the software.

### MD Player features

To enjoy the MD Player of Media Bar features, you need to connect your computer to the Control A1 connection of your MiniDisc® recorder.

Link your MD deck and CD player with the optical cable and the CONTROL A1 or Control A1 II cable to enjoy:

- ❑ Complete editing and assembly functions: change the order of the numbers on your MD;
- ❑ Use the touchpad or mouse to play and edit MDs, and the keyboard to enter disc and track titles to display on your MD deck while playing;
- ❑ Digital output and input without any noise or loss of data;
- ❑ Drag-and-drop, copy and paste and other functions: your computer is the visual interface of the MiniDisc® recorder.

## MiniDisc® deck with MD Player

✎ The Control A1 or Control A1 II features only work with Sony devices. For further information, please refer to your Sony Dealer.

✎ See the Compatibility table to verify which peripheral devices are compatible with your notebook.

## To connect the MD recorder to your computer

- 1 Plug the CONTROL A1 or Control A1 II connecting jack to the MD deck using the CONTROL A1 or Control A1 II connector and the other end to the Serial connector on your computer.

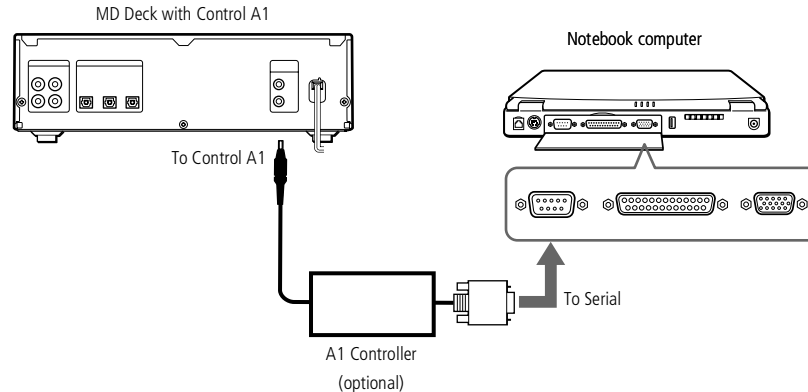

- 2 Plug the optical cable into the Digital Optical output / input of your MD desk.
- 3 Turn on all the devices.
- 4 Launch MD Player to edit the tracks on your MiniDisc®.

For more information on using the keyboard, See **Using the Keyboard** on [page 28](#).

See the manual supplied with your mouse or keyboard for more information on installation and use.

Before you connect or disconnect the mouse or keyboard, turn off the computer.



Before connecting a mouse to the Serial port, make sure the mouse is compatible with a serial port.

## External Mouse or Keyboard

You can connect an external mouse or keyboard to your computer. To connect both a mouse and a keyboard, use the port replicator (See **Port Replicator** on [page 56](#)).

The Mouse/Keyboard connector requires a PS/2-style plug or adapter.

### To connect an external mouse or keyboard

- Use the  symbol to locate the Mouse/Keyboard connector. Plug the keyboard cable or mouse cable into this connector with the  mark facing up.

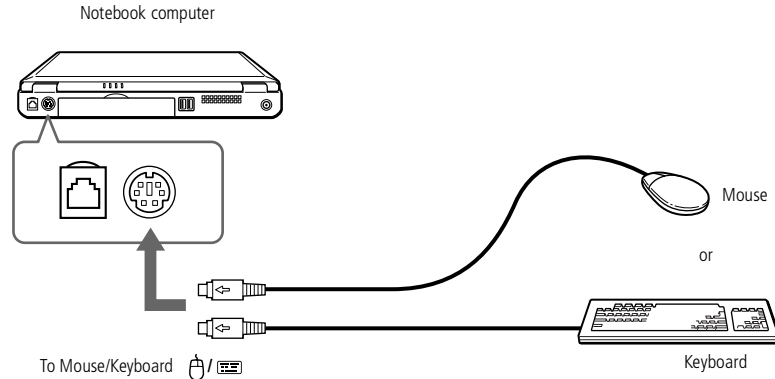



✎ You may need to install software (device drivers) supplied with your USB device before using the USB device.

Read the manual supplied with your USB device carefully for more information on installation and use.

✎ You can connect the optional Sony USB mouse (PCGA-UMS1). As the driver for PCGA-UMS1 is preinstalled on your computer, you can use this PCGA-UMS1 USB mouse by just connecting it.

✎ See the Compatibility table to verify which peripheral devices are compatible with your notebook.

## Universal Serial Bus (USB) Device

You can connect a USB device to your computer.

### To connect a USB device

- ❑ Use the  symbol to locate the USB connector. Plug one end of the USB cable into this port and the other end into the USB device.

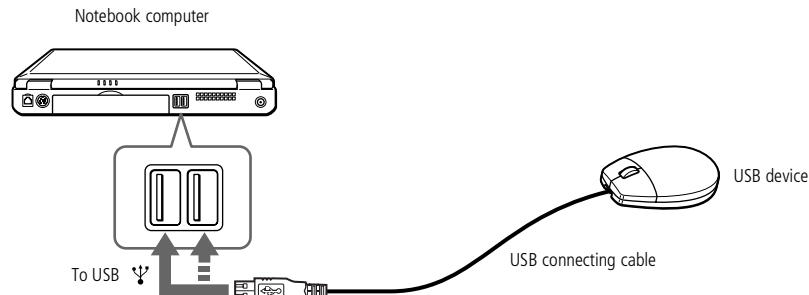

📖 See the manual supplied with your peripheral for more information on installation and use.

Make sure your speakers are designed for computer use.

Turn down the volume of the speakers before you turn them on.

Do not place diskettes on the speakers; the speaker's magnetic field may damage the data on the diskettes.

See the manual supplied with your speakers for more information on installation and use.

## External Speakers

You can enhance the sound quality of your computer by connecting external speakers.

### To connect external speakers

- ❑ Use the 🎧 symbol to locate the Headphone connector. Plug the speaker cable into this connector.

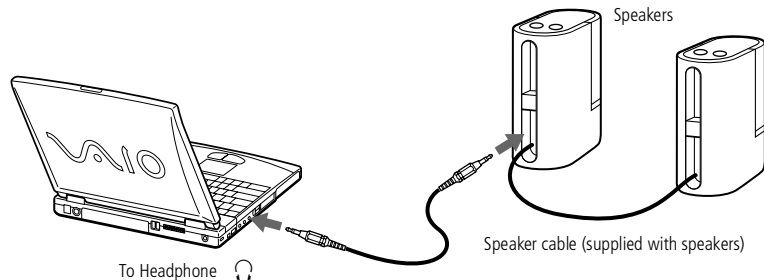

- ✎ Make sure your microphone is designed for computer use.  
See the manual supplied with your peripheral for more information on installation and use.

## External Microphone

Your VAIO notebook does not contain an internal microphone. If you need to use a sound input device, for example to chat on the Internet, you need to plug in an external microphone.

### To connect an external microphone

- Use the  to locate the Microphone connector. Plug the microphone cable into this connector.

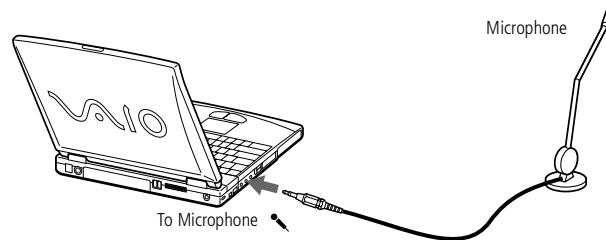

## Getting Help

This section describes how to get help and support from Sony, as well as troubleshooting tips for your computer.

See also the online FAQ provided on your Documentation CD-ROM.

### About Sony's Support Options

Sony provides several support options for your computer. When you have questions about your computer and the pre-installed software, check these places for answers:

#### *Printed documentation supplied with your computer*

- ❑ The **Customer Guide** explains how to start your computer and use the basic functions. This guide gives you the information to access VAIO-Link.
- ❑ The **Setting Up Poster** gives you a list of the contents you find in the box, a summary of the bundled applications and the list of specifications of your computer and accessories.

#### *Online user guides supplied with your Documentation CD-ROM*

- ❑ **This guide** explains how to use your computer, connect peripheral devices. It gives you a packing list and the list of specifications of your computer and accessories.
  - ❑ The **Software guide** lists the pre-installed software titles and explains how to use the utility programs and perform basic computer tasks.
  - ❑ The **Customer Service Guide** gives you complete information on the VAIO-Link Services.
-

 You need to plug the phone line into the modem to use the communication features described in this manual.

### *Other sources of information*

- ❑ The **online help files** that accompany your pre-installed software contain instructions on using the software.
- ❑ **VAIO-Link website:** if you have any problem with your computer, you can access the VAIO-Link web site (see your Customer Service Guide for the address).
- ❑ The **Sony e-mail support service** answers your questions by electronic mail. Just send your question in an e-mail message and a Customer Service Analyst will send you a reply with the answer. To send a question to Sony e-mail support, please refer to the instructions in your Customer Service Guide.
- ❑ **VAIO-Link Response Centre:** Before contacting VAIO-Link Response Centre, try to solve the problem by reading your User Guide (troubleshooting chapter) or the manuals and helpfiles for the peripherals or software (See your Customer Service Guide for the phone numbers).



 When you reconnect devices (other than USB devices), be sure to turn off the computer as described in **Shutting down your computer**. If you turn off the computer in other ways, it may result in data loss.

## Troubleshooting

This section describes how to solve common problems you may encounter when using your computer. Many problems have simple solutions, so try these suggestions before you contact VAIO-Link.

- ❑ About the computer and software, see [page 78](#)
- ❑ About the display, see [page 82](#)
- ❑ About CD-ROMs and diskettes, see [page 82](#)
- ❑ About sound, see [page 84](#)
- ❑ About the modem, see [page 85](#)
- ❑ About peripherals, see [page 86](#)

See also the online FAQ provided on your Documentation CD-ROM.

### *About the computer and software*

#### *My computer does not start*

- ❑ Check that the computer is plugged into a power source and that it is turned on.
- ❑ Check that the power indicator on the front panel of the computer indicates that the power is on.
- ❑ Check that the battery packs are inserted properly and that they are charged.
- ❑ Make sure there is no diskette in the floppy disk drive.
- ❑ Confirm that the power cord and all cables are connected firmly.
- ❑ If you have plugged the computer into an UPS, make sure the UPS is turned on and working.

- ❑ If you are using an external display, check that it is plugged into a power source and turned on. Check that you have switched to the external display and that the brightness and contrast controls are adjusted correctly. Please refer to the manual supplied with your display for details.
- ❑ Moisture condensation may have occurred. Do not use the computer for at least one hour and then turn it on.
- ❑ When the internal backup battery is low on power, it may not be able to start your system properly.
- ❑ The message **Press <F1> to resume, <F2> to setup** would appear at the bottom of the display. Should this happen, you need to initialize the BIOS.
- ❑ Follow the steps in **The message 'Press <F1> to resume, <F2> to setup' appears at startup**.

*The message **Press <F1> to resume, <F2> to setup** appears at startup*

- ❑ If the floppy disk drive is empty, follow the steps below to initialize the BIOS:
    - 1 Remove any peripheral devices connected to the computer,
    - 2 Turn the computer off and then turn it on again,
    - 3 Turn on the computer and press the **F2** key when the Sony logo appears. The BIOS setup menu screen appears.
    - 4 Press the arrow keys to select the **Exit** menu.
    - 5 Press the arrow keys to select **Get Default Values** and then press the **Enter** key. The message **Load default configuration now?** appears.
    - 6 Check that **[Yes]** is selected and then press the **Enter** key.
    - 7 Press the arrow keys to select **Exit** (Save Changes) and then press **Enter**.
-

The message **Save configuration changes and exit now?** appears.

8 Check that **[Yes]** is selected, then press the **Enter** key. The computer will restart.

#### *My computer does not shut down*

It is best to shut down your computer using the **Shut Down** command on the Windows® Start menu. Using other methods, including those listed here, may result in loss of unsaved data. If the **Shut Down** command does not work properly, follow these steps:

- ❑ Restart the computer by pressing **Ctrl + Alt + Delete** and by choosing **Shut Down**.
- ❑ If this does not work, press the power button and hold it for at least four seconds, this turns off the power.
- ❑ Unplug the computer from the AC adapter and remove the battery pack from your computer.

#### *My computer locks up*

- ❑ If you suspect one application is locking your system, you can try to stop it. To do this, press **Ctrl+Alt+Delete** once, click **Task Manager**, select the application or the process that you think is locking your system in the list, and then click **End Task**.
- ❑ If the above method does not work or you do not know which application is locking your system, try restarting the computer. On the Windows® taskbar, click the **Start** button, click **Shut Down**, and then select **Shut down** in the list and click **OK**.
- ❑ If the above method does not work, press the power switch and hold it for at least four seconds. This turns off the power.
- ❑ If your computer locks up while playing a CD-ROM, stop the CD-ROM, and shutdown the computer by pressing **Ctrl+Alt+Delete**, and then click **Shut Down**.



*My software program **locks up** or crashes*

Contact the software publisher or designated provider for technical support. Please refer to your Software guide for information on how to contact them.

*My mouse does not work*

- ❑ If you are using an external mouse, check that the mouse is plugged into the mouse connector.
- ❑ If you have connected an external mouse while your computer is on, you must restart your computer.

*My touchpad interprets a single tap as a double-click*

Open the **Mouse** icon in the **Control Panel** and change the button assignments in the **Mouse Properties** dialog box. One of the buttons is assigned to the double-click action.

*About Digital Video Captures and DVgate*

*While I'm recording images to a digital video device using DVgate, my system displays the message **Recording to DV device failed. Check the power and cable connections to the DV device and try the operation again...***

Close all open applications and restart your computer. Frequent recording of images to a digital video device while using DVgate sometimes causes this to occur. For more information on DVgate, see the DVgate online help.



## About the display

### *My LCD does not display anything*

- ❑ Check that the computer is plugged into a power source and that it is turned on.
- ❑ Check that the power indicator on the front panel of the computer is on.
- ❑ Check that the battery packs are inserted properly and that they are charged.
- ❑ Adjust the brightness of the LCD.
- ❑ The computer may be in LCD (video) standby mode. Press any key to activate the display.

### *The screen image on my external display is not centered or sized properly*

Use the controls on your external display to adjust the image. Please refer to the manual supplied with your display for more information.

## About CD-ROMs and diskettes

### *My DVD-ROM drive tray does not open*

- ❑ Make sure the computer is turned on.
- ❑ Press the Eject button on the DVD-ROM drive.
- ❑ If the Eject button does not work, you can open the tray by inserting a sharp, pointed object into the hole to the right of the Eject button.

### *I cannot play a CD-ROM disk*

- ❑ Make sure the label of the CD-ROM is facing up.
  - ❑ If the CD-ROM disk requires software, make sure the software is installed according to the program's instructions.
-

 DVD Region Code Change

On your computer, the default DVD region code is "2". Do not change this setting using the region code change function in Windows®, or using any other software applications. System malfunctions originating from the user changing the DVD region code are beyond the scope of your warranty and will result in service charges for repair.

- ❑ Check the volume of your speakers.
- ❑ Clean the CD-ROM disk.
- ❑ Moisture condensation may have occurred. Leave the computer for at least 1 hour while it is turned on.

*I cannot play a DVD-ROM disk*

- ❑ If a region code warning appears when you are using the DVD player, it could be that the DVD-ROM disk you are trying to play is incompatible with the DVD-ROM drive in your notebook computer. The region code is listed on the disk's packaging.
- ❑ If you hear sound but cannot see video, your computer's video resolution may be set too high. For best results, change the resolution in Windows **Control Panel/Display/Settings** to 800 x 600 using 8-bit color.
- ❑ If you see video but cannot hear sound, check all of the following:
  - 1 Make sure the mute setting is off in your DVD player.
  - 2 Check the master volume setting in the audio Mixer. If you have connected speakers externally, check the volume settings in your computer speakers and check the connections between your speakers and the computer.
  - 3 In the Device Manager, check that the DVD/CD-ROM drivers are installed properly. To display the **Device Manager**, click **Start**, point to **Settings** and click **Control Panel**. Double-click the **System** icon. On the Hardware tab, click on the **Device Manager** button.
- ❑ A dirty or damaged disk may cause the computer to "hang" while it tries to read the disk. If necessary, reboot the computer, remove the disk, and then check that it is not dirty or damaged.

*When I double-click an application icon a message such as **You must insert the application CD into your CD-ROM drive** appears and the software does not start.*

- ❑ Some titles require specific files that are located on the application's DVD-ROM / CD-ROM disk. Insert the disk and try starting the program again.
- ❑ Make sure you place the disk in the tray with the label side facing up.

*My floppy disk drive cannot write to a diskette*

- ❑ The diskette is write-protected. Disable the write-protect feature or use a diskette that is not write-protected.
- ❑ Check that the diskette is properly inserted into the floppy disk drive.

### *About sound*

*My speakers are not producing sound*

- ❑ The built-in speakers may be turned off. Press **Fn+F3** to turn on the speakers.
- ❑ The speaker volume may be turned to the minimum. Press **Fn+F4**, and then press **▲** or **▶** to increase the volume.
- ❑ If your computer is powered by battery, check that the battery is inserted properly and that it is charged.
- ❑ If you are using an application that has its own volume control, check that the volume is turned up.
- ❑ Check the volume controls in Windows®.
- ❑ If you use external speakers, check that the speakers are properly connected and the volume is turned up. If the speakers have a mute button, make sure it is off. If batteries power the speakers, check that the batteries are inserted properly and that they are charged.
- ❑ If you have connected an audio cable to the Headphone connector, disconnect the cable.

### *My microphone does not work*

If you are using an external microphone, check that the microphone is plugged into the Microphone connector.

### *About the modem*

#### *My internal modem does not work*

- ❑ Check that the phone line is plugged into your computer.
- ❑ Check that the phone line is working. You can check the line by plugging in an ordinary phone and listening for a dial tone.
- ❑ Check that the phone number the program is dialing is correct.
- ❑ In the **Phone and Modem Options** dialog box (**Control Panel / Phone and Modem Options**), check that your modem is listed on the **Modems** tab, and that the location information is correct on the **Dialing Rules** tab.

#### *My Modem Cannot Establish a Connection*

The modem dialing mode may be incompatible with your telephone line.

To verify the modem settings, see **Configuring the modem for use** in your Software Guide.

#### *My modem connection is slow*

Many factors influence modem connection speed, including telephone line noise or compatibility with telephone equipment (such as fax machines or other modems). If you think your modem is not connecting properly to other PC-based modems, fax machines, or your Internet Service Provider, check the following:

- ❑ Have your phone company check that your phone line is free from any line noise.

- ❑ If your problem is fax-related, check that there are no problems with the fax machine you are calling and that it is compatible with fax modems.
- ❑ If you are having a problem connecting with your Internet Service Provider, check that the ISP is not experiencing technical problems.
- ❑ If you have a second phone line available, try connecting the modem to that line.

### About peripherals

*I cannot use DV devices. The message **DV equipment seems to be disconnected or turned off** appears.*

- ❑ Check that the DV device is turned on and that the cables are properly connected.
- ❑ If you are using multiple i.LINK™ devices, the combination of the connected devices may cause unstable operation. In this case, turn off the power to all connected devices and disconnect unused devices. Check the connection and then turn on the power again.

### *My PC card is not working*

- ❑ Make sure the PC card is compatible with your version of Windows®.

### *I cannot print.*

- ❑ Check that all the cables of the printer are correctly connected.
- ❑ Check that your printer is correctly configured and that you have up to date drivers. If needed, contact your dealer.
- ❑ The default setting for the printer port mode is correct for most printers. If you cannot print, try changing the printer port mode. In **Sony Notebook Setup**, select the **Printer** tab. If the printer port mode is set to ECP, change it to bi-directional. If the printer port mode is set to bi-directional, change it to ECP. Please refer to **Sony Notebook Setup** in your Software Guide for details on how to configure the system.

## Notes on Use

This section describes safety guidelines and precautions to help protect your computer from potential damage.

### *On Upgrading the System*

Your notebook computer and memory modules use high precision components and electronic connectors' technology. To avoid the invalidation of your Guarantee by mishandling, it is recommended that:

- ❑ You contact your dealer to install a new memory module,
- ❑ You do not install it yourself, if you are not familiar with upgrading memory on a notebook computer,
- ❑ You do not touch the connectors or open the memory panel.

Please call VAIO-Link if you need assistance.

### *Adding Memory*

In the future you may want to install memory modules to expand the functionality of your computer. You can increase the memory by installing optional memory modules.



### Precautions

#### On handling

Be careful when adding memory. Mistakes on installation or removal of the memory module may cause a malfunction.

Electrostatic discharge can damage electronic components. Before touching a memory expansion board, ensure the following:

- ❑ Handle the Memory Module gently.
- ❑ The procedures described in this instruction manual assume familiarity with the general terminology associated with personal computers and with the safety practices and regulatory compliance required for using and modifying electronic equipment.
- ❑ Disconnect the system from its power source and from any telecommunications links, networks, or modems before you open the system or do any of the procedures described in **Installing the memory Module**. Failure to do so may result in personal injury or equipment damage.
- ❑ Electrostatic Discharge (ESD) can damage Memory Modules and other components. Perform the procedures described in **Installing the memory Module** only at an ESD workstation. If such a station is not available, do not work in a carpeted area, and do not handle materials that produce or hold static electricity (cellophane wrappers, for example). Ground yourself by maintaining contact with an unpainted metal portion of the chassis while performing the procedure.
- ❑ Do not open the memory module package until you are ready to install the module. The package protects the module from ESD.



*On keeping*

Use the special bag delivered with the memory module or wrap the module in aluminium foil to protect it from electrostatic discharge.

Do not place the memory module in places subject to:

- ❑ Heat sources such as radiators or air ducts,
- ❑ Direct sunlight,
- ❑ Excessive dust,
- ❑ Mechanical vibration or shock,
- ❑ Strong magnets or speakers that are not magnetically shielded,
- ❑ Ambient temperature of more than +35°C or less than +5°C,
- ❑ High humidity.

*To remove a memory module*

- 1 Shut down your computer and disconnect all peripheral devices.
  - 2 Unplug your computer and remove the battery pack.
  - 3 Turn your computer upside down and open the cover on the bottom.
  - 4 Remove the memory module.
  - 5 Close the cover.
-

### To install a memory module

- 1 Shut down your computer and disconnect all peripheral devices, such as your printer.
- 2 Unplug your computer and remove the battery pack(s).
- 3 Wait until the computer cools down. Then turn your computer upside down and open the cover on the bottom by unscrewing the screw.

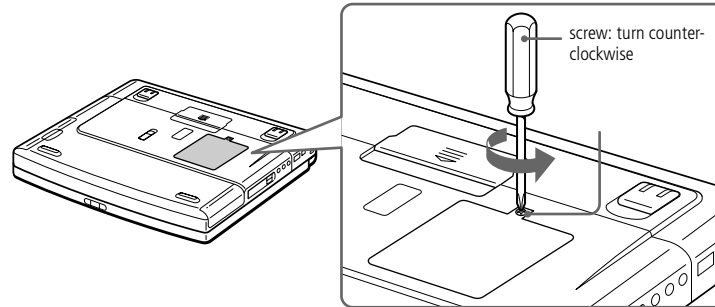

- 4 Remove the memory module from its packaging.
- 5 Install the memory module.

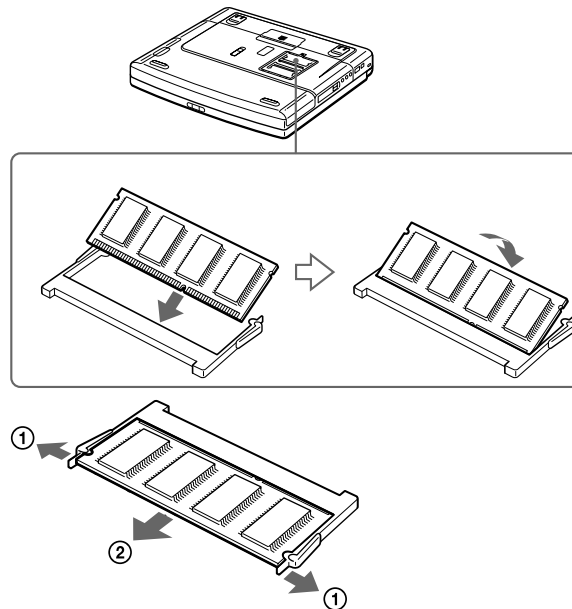

- ① Pull the tabs in the direction of the arrows.  
The memory module is released.
- ② Pull the memory module in the direction of the arrow.

6 Close the cover and gently tighten the screw.

7 Turn on the computer.

To verify if the installation of the additional memory succeeded, click **Start**, select **VAIO**, select **Assistance** and click **Sony Notebook Setup**. Select the **About This Computer** tab. If the additional memory is not shown, repeat steps 1-7.

## Other precautions

### *On Handling the Hard Disk*

The hard disk has a high storage density and reads or writes data in a short time. On the other hand, it may be easily damaged by mechanical vibration, shock or dust. Keep the hard disk away from magnets.

Although the hard disk has the safety device in itself to prevent losing data due to mechanical vibration, shock or dust, you should be careful when handling your computer. To avoid damaging data:

- ❑ Do not give a shock to your computer.
- ❑ Do not place your computer in a location subject to mechanical vibration or in unstable situation.
- ❑ Do not move your computer while the power is on.
- ❑ Do not turn off the power or restart the computer while reading or writing data.
- ❑ Do not use your computer in a place subject to extreme change of temperature.
- ❑ If the hard disk is damaged, the data cannot be restored.

### *Back up data*

As you may lose important data once your computer is damaged, you should back up your data regularly.

Restore the original application programs from the Product Recovery CD-ROM.

See the Windows® help for more information on back-up data.

### *On Handling the LCD Screen*

- ❑ Do not leave the LCD facing the sun as it can damage the LCD. Be careful when using the computer near a window.

*Other precautions*

- ❑ Do not scratch the LCD or exert pressure on it. This could cause malfunction.
- ❑ Using the computer in low temperature conditions may produce a residual image on the screen. This is not a malfunction. When the computer returns to normal temperature, the screen returns to normal.
- ❑ A residual image may appear on the screen if the same image is displayed for a lengthy period of time. The residual image disappears in a while. You can use a screen saver to prevent residual images.
- ❑ The screen becomes warm during operation. This is normal and does not indicate a malfunction.
- ❑ The LCD is manufactured using high-precision technology. You may, however, see tiny black points and/or bright points (red, blue, or green) that continuously appear on the LCD. This is a normal result of the manufacturing process and does not indicate a malfunction.

*On the Power Source*

- ❑ Your computer operates on 100V-240V AC 50/60 Hz.
  - ❑ Do not share the AC outlet with other power-consuming equipment, such as a copying machine or shredder.
  - ❑ You can purchase a power strip with a surge protector. This device prevents damage to your computer caused by sudden power surges such as those that may occur during an electrical storm.
  - ❑ Do not place heavy objects on the power cord.
  - ❑ To disconnect the cord, pull it out by the plug. Never pull the cord itself.
  - ❑ Unplug your computer from the wall outlet if you will not be using the computer for a long time.
  - ❑ When the AC adapter is not used, unplug it from the AC outlet.
  - ❑ Use only the AC adapter supplied. Do not use any other AC adapter.
-

*On Handling*

- ❑ Clean the cabinet with a soft, dry cloth or a soft cloth lightly moistened with a mild detergent solution. Do not use any type of abrasive pad, scouring powder, or solvent such as alcohol or benzine, as these may damage the finish of your computer.
- ❑ Should any solid object or liquid fall into the computer, shut down your computer and then unplug it. You may want to have the computer checked by qualified personnel before operating it any further.
- ❑ Do not drop the computer or place heavy objects on top of the computer.

*On Installation*

- ❑ Do not place your computer in a location subject to:
    - ❑ Heat sources, such as radiators or air ducts,
    - ❑ Direct sunlight,
    - ❑ Excessive dust,
    - ❑ Moisture or rain,
    - ❑ Mechanical vibration or shock,
    - ❑ Strong magnets or speakers that are not magnetically shielded,
    - ❑ Ambient temperature of more than 35° C or less than 10° C,
    - ❑ High humidity.
  - ❑ Do not place electronic equipment near your computer. The computer's electromagnetic field may cause a malfunction.
  - ❑ Provide adequate air circulation to prevent internal heat build-up. Do not place your computer on porous surfaces such as rugs or blankets, or near material such as curtains or draperies that may block its ventilation slots.
-

- ❑ The computer uses high-frequency radio signals and may cause interference to radio or TV reception. Should this occur, relocate the computer a suitable distance away from the set.
- ❑ Use only specified peripheral equipment and interface cables; otherwise, problems may result.
- ❑ Do not use cut or damaged connection cables.
- ❑ Your computer cannot be connected to a coin-operated telephone, and may not work with a private branch exchange (PBX).

#### *On Moisture Condensation*

If the computer is brought directly from a cold location to a warm one, moisture may condense inside your computer. In this case, allow at least an hour before turning on your computer. If any problem occurs, unplug your computer and contact VAIO-Link.

#### *On Handling Diskettes*

- ❑ Do not open the shutter manually and touch the surface of the diskette.
- ❑ Keep diskettes away from magnets.
- ❑ Keep diskettes away from direct sunlight and other heat sources.

#### *On Handling CD-ROM and DVD-ROM Disks*

- ❑ Do not touch the surface of the disk.
- ❑ Do not drop or bend the disk.

#### *On Cleaning CD-ROM and DVD-ROM Disks*

- ❑ Fingerprints and dust on the surface of a disk may cause read errors. Proper care of the disk is essential to maintain its reliability. Do not use solvents such as

benzine, thinner, commercially available cleaners or anti-static spray, as they may cause damage to the disk.

- ❑ For normal cleaning, hold the disk by its edge and use a soft cloth to wipe the surface from the center out.
- ❑ If the disk is badly soiled, moisten a soft cloth with water, wring it out well, and use it to wipe the surface of the disk from the center out. Wipe off any remaining moisture with a dry soft cloth.

#### *On Using Batteries*

- ❑ Never leave the battery pack in temperatures above 60° C, such as in a car parked in the sun or under direct sunlight.
  - ❑ Battery life is shorter in a cold environment. This is due to decreased battery efficiency at low temperatures.
  - ❑ Charge the batteries at temperatures between 10° C to 30° C. Lower temperatures require a longer charging time.
  - ❑ While the battery is in use or being discharged, the battery pack heats up. This is normal and is not cause for concern.
  - ❑ Keep the battery pack away from all sources of heat.
  - ❑ Keep the battery pack dry.
  - ❑ Do not open or try to disassemble the battery pack.
  - ❑ Do not expose the battery pack to any mechanical shock.
  - ❑ If you are not using the computer for an extended period of time, remove the battery pack from the computer to prevent damage to the battery.
  - ❑ If, after fully charging the battery pack, the battery power is still low, the battery pack may be reaching the end of its life and should be replaced.
  - ❑ You do not need to discharge the battery before recharging.
-



*Other precautions*

- ❑ If you have not used the battery pack for a considerable amount of time, recharge the battery.

*On Using earphones*

- ❑ **Road safety** – Do not use earphones while driving, cycling, or operating any motorized vehicle. It may create a traffic hazard and is illegal in some areas. It can also be potentially dangerous to play your earphones at high volume while walking, especially at pedestrian crossings. You should exercise extreme caution or discontinue use in potentially hazardous situations.
- ❑ **Preventing hearing damage** – Avoid using earphones at high volume. Hearing experts advise against continuous, loud and extended play. If you experience a ringing in your ears, reduce the volume or discontinue use.

*On Maintenance*

- ❑ Make sure to disconnect the power cord before cleaning the computer.
- ❑ Avoid rubbing the LCD screen, as this can damage the screen. Use a soft, dry cloth to wipe the LCD screen.
- ❑ Clean the computer with a soft cloth lightly moistened with a mild detergent solution. Do not use any type of abrasive pad, scouring powder or solvent such as alcohol or benzene.

# Specifications

<i>Model Number</i>	<i>PCG-F807K</i>	<i>PCG-F808K</i>	<i>PCG-F809K</i>
<i>Processor</i>	Mobile Intel® Pentium® III processor 650 MHz featuring Intel® SpeedStep™ technology	Mobile Intel® Pentium® III processor 750 MHz featuring Intel® SpeedStep™ technology	Mobile Intel® Pentium® III processor 850 MHz featuring Intel® SpeedStep™ technology
<i>Hard Disk Drive</i>	12.0GB	20.0GB	30.0GB
<i>Standard RAM</i>	64 MB SDRAM 100 MHz (PC100 compatible)	128 MB SDRAM 100 MHz (PC100 compatible)	128 MB SDRAM 100 MHz (PC100 compatible)
<i>Maximum RAM</i>	256 MB		
<i>LCD Screen</i>	14.1" XGA (1024x768) TFT	15.0" XGA (1024x768) TFT	15.0" SXGA+ (1400x1050) TFT
<i>L2 Cache Memory</i>	256 KB (CPU integration)	256 KB (CPU integration)	256 KB (CPU integration)
<i>MPEG</i>	MPEG 2 Digital Video Supports full-screen playback		
<i>Graphics</i>	ATI Rage Graphics chip with 8 MB Video RAM and 3D accelerator		
<i>Sound Capabilities</i>	16-bit CD-quality stereo sound		
<i>Diskette Drive</i>	3.5" 1.44 MB (removable)		

<i>Model Number</i>	<i>PCG-F807K</i>	<i>PCG-F808K</i>	<i>PCG-F809K</i>
<i>DVD-ROM / CD-ROM Drive</i>	DVD-ROM up to 8x Laser Diode properties: Wave Length : 780 and 650 nm Laser Output: 77.5 μW		
<i>Internal modem</i>	Built-in modem V90/K56Flex (56 Kbps) data/fax		
<i>Telecommunication Capabilities</i>	PSTN data connectivity		
<i>Expansion Capabilities</i>	Two PCMCIA type II or one type III Cards and Card Bus support		
<i>Built-In Capabilities</i>	Stereo speakers, Touchpad		
<i>Special Buttons</i>	PPK (Programmable Power Keys)		
<i>Connection Capabilities on Notebook</i>	Port replicator, Printer, Monitor, External speakers or Headphone, Serial, PS/2, 2 x USB, Type II & III PC Cards, i.LINK™ (IEEE1394) S400		
<i>Connection Capabilities on Port Replicator</i>	LAN (Ethernet), Printer, VGA monitor, Mouse and Keyboard (USB or PS/2-style), Serial, USB.		
<i>Supplied Accessories</i>	DVD-ROM drive, Floppy disk drive, Rechargeable battery, AC adapter, Video cable, Phone cable, Phone plug, Weight saver		
<i>Service</i>	1 year free VAIO-Link Service‡		
<i>Guarantee</i>	1 year guarantee (parts and labour) ‡		
<i>Power Requirement</i>	49.5 watts maximum (19.5 V DC/ AC100-240V)		
<i>Power Management</i>	Energy Star compliant ACPI (Advanced Configuration & Power Interface).		

<i>Model Number</i>	<i>PCG-F807K</i>	<i>PCG-F808K</i>	<i>PCG-F809K</i>
<i>Battery</i>	Lithium ion		
<i>Dimensions</i>			
<i>Width</i>	324 mm	324 mm	324 mm
<i>Height</i>	38.5 mm → 46.9 mm	38.5 mm → 54.1 mm	38.5 mm → 54.1 mm
<i>Depth</i>	265.5 mm	265.5 mm	265.5 mm
<i>Weight</i>			
<i>with weight saver and battery</i>	3.0 kg	3.24 kg	3.24 kg
<i>with FDD and battery</i>	3.23 kg	3.42 kg	3.42 kg
<i>Operating Temperature</i>	+5°C → +35°C (temperature gradient less than 10°C/hour)		
<i>Storage Temperature</i>	-20°C → +60°C (Temperature gradient less than 10°C/hour)		
<i>Operating Humidity</i>	20% → 80% (Not condensed), provided that humidity is less than 65% at +35°C (hygrometer reading of less than 29°C)		
<i>Storage Humidity</i>	10% → 90% (Not condensed) provided that humidity is less than 20% at +60°C ( hygrometer reading of less than 35°C)		

‡ See our special Guarantee extension conditions.

Specifications are subject to change without notice.

## Compatibility table

This table contains an overview of the devices that are compatible or not with your notebook.

<i>Devices</i>	<i>Compatible</i>	<i>Not compatible</i>
<i>USB</i>	Sony USB mouse PCGA-UMS1	
<i>AC adapter</i>	Only with the PCGA-AC19V AC adapter.	
<i>i.LINK cables</i>	VMC-IL4415 VMC-IL4408Series	
<i>Port Replicator</i>	- with the supplied PCGA-AC19V AC adapter - optional PCGA-AC19 AC adapter	
<i>i.LINK</i>	- On Sony Digital video cameras - On connectors labeled : DV Out, DV in/out, i.LINK	This notebook has no supply power to external devices generally powered by i.LINK connectors.
<i>Control A1 or Control A1 II</i>	Only with Sony devices.	

# Index

## A

- AC adapter **19**
- AC power **19**
- adding
  - hardware **55**
  - peripherals **55**
  - printers **60**
- air circulation **94**
- Alt key **29**
- Applications key **30**
- attaching port replicator **56**

## B

- battery bay **15**
- battery packs **20, 96**
  - charging **21, 51**
  - indicator lights **16, 21, 31, 50**
  - inserting **20**
  - inserting into battery bay **20**
  - loading **20**
  - power status **22**
  - rechargeable **19**
  - removing **24, 50, 52**
- brightness
  - adjusting **25**
- buttons
  - Eject **38**
  - left **16**
  - right **16**

Start (Windows®) **26**

## C

- cables
  - power cord **19**
- cameras
  - digital video recorder **67**
- canceling commands **29**
- Caps Lock **16**
  - indicator light **31**
- CD drive tray
  - troubleshooting **82**
- CD-ROM discs
  - troubleshooting **82**
- CD-ROM drive
  - troubleshooting **82**
- CD-ROM/DVD-ROM discs
  - cleaning **96**
  - ejecting **38**
  - handling **95, 96**
  - inserting **38**
- CD-ROM/DVD-ROM drive
  - closing tray **38**
- charge status indicator light **21**
- charging battery packs **21, 51**
- choosing
  - power source **20**
- cleaning computer **94**
- computer
  - cleaning **94**
  - condensation **95**
  - lithium ion battery **7**
  - starting **25**

troubleshooting **78, 80, 81**

connecting

- digital video recorder **67**
- external keyboard **56, 72**
- external mouse **72**
- external speakers **74**
- microphone **75**
- monitor **56, 62**
- mouse **56**
- multimedia computer display **63**
- port replicator **56**
- power source **19**
- printer **60**
- projector **64**
- weight saver **53**

connectors

- DC In **17, 19, 56**
- i.LINK **15**
- keyboard **16, 56**
- microphone **15**
- monitor **17, 56**
- mouse **17, 56**
- Printer **60**
- printer **60**
- Serial port **17, 56**
- USB **17, 56**

Correction keys **29**

correction keys **29**

Ctrl key **29**

cursor-movement keys **29**

Customer Service Guide **76**

customer support **77**

See also VAIO-Link **8**

## D

DC In **17, 19, 56**

digital video camera **67**

disconnecting

- port replicator **59**

diskettes

- ejecting **36**
- handling **95**
- inserting into drive **35**
- troubleshooting **84**

display

- options **64**
- See also monitor **17**
- selecting **64**

drive bay **14**

DV In/Out **15, 67**

DVD-ROM drive

- opening tray **38**
- using **38**

## E

earphones

- precautions **97**

Eject button **36, 38**

Eject lever **52, 54**

ejecting

- battery packs **52**
- CD-ROM/DVD-ROM discs **38**
- diskettes **36**
- weight saver **54**

ergonomic considerations **12, 13**

Escape key **29**  
External **74**  
external devices  
    display **13, 64**  
        See also monitor **62**  
    keyboard **72**  
    mouse **72**  
    speakers **74**

## F

floppy disk drive  
    bay **14**  
    disconnecting **36**  
    troubleshooting **84**  
Fn key **29**  
    combination commands **32**  
Function keys **29**  
function keys **30**

## G

Guarantee **27**  
Guarantee card **27**

## H

handling  
    audio CDs **96**  
    CD-ROM/DVD-ROM discs **95, 96**  
    diskettes **95**  
hard drives  
    indicator light **16, 31**  
headphones **63**  
Help  
    Mouseware **34**

online **77**

## I

i.LINK **15, 67**  
IEEE1394 **15, 67**  
indicator lights  
    battery **16, 21, 31, 50**  
    Caps Lock **16, 31**  
    charge status **21**  
    hard drive **16, 31**  
    Num Lock **16, 31**  
    power **16**  
    Scroll Lock **16, 32**  
Insert key **29**  
inserting  
    battery pack **20**  
    CD-ROM/DVD-ROM discs **38**  
    diskettes into drive **35**  
installing  
    hardware **55**  
    peripherals **55**  
interference **94**

## K

keyboard **29, 56**  
    connecting **72**  
    connector **16**

## L

LCD **92**  
    lock lever **25**  
    selecting to display output **64**



troubleshooting **82**

left button **16**

lever

- eject **52, 54**
- LCD **25**
- release **36**

lithium ion battery

- disposal **7**
- safety precautions **7**

loading

- battery pack **20**

**M**

maintenance **94, 97**

microphone **15**

- connecting **75**
- connector **63**
- troubleshooting **85**

modem

- troubleshooting **85**

moisture condensation **95**

monitor **17, 56**

- connecting **62**
- connector **63**
- selecting **64**

mouse

- connecting **72**
- connector **17**
- troubleshooting **81**

Mouse Properties screen **34**

multimedia computer display **63**

Multi-purpose bay

- weight saver **53**

My **80**

**N**

Navigation keys **28**

navigation keys **29**

Num Lock **16**

- indicator light **31**

numeric keypad area **28**

**O**

online help **77**

opening

- DVD-ROM drive tray **38**

operator keys **29**

output devices

- adding **60**

**P**

packing list **76**

PC card **86**

- inserting **41**
- slots **15, 41**
- troubleshooting **86**
- Type III **41**

port replicator

- connecting **56**
- disconnecting **59**

power

- cord **19**
- indicator light **16**
- programmable keys **44**
- switch **25**

power saving modes **48**

System Hibernation **49**  
System Suspend **49**  
power sources **20, 93**  
    connecting **19**  
PPK **44**  
precautions **94**  
pre-installed software **76**  
Print Screen key **29**  
printer  
    connecting **17, 56, 60**  
    connector **60**  
    port **60**  
Printer connector **17, 56, 60**  
programmable power keys **44**  
projector **64**

**R**

radio interference **94**  
rechargeable battery packs **19, 20**  
recharging battery packs **21**  
registering  
    your computer **27**  
Registering Your Computer **27**  
Release lever **36**  
removing  
    battery packs **24**  
    diskettes **36**  
    floppy disk drive **36**  
removing port replicator **59**  
replacing  
    battery packs **50**  
right button **16**

**S**

Scroll Lock **16**  
    indicator light **32**  
second battery pack **20, 50**  
selecting  
    display **64**  
    LCD **64**  
    monitor **64**  
    power source **20**  
Serial connector **17, 56**  
Shift key **30**  
Shut Down Windows dialog box **26**  
Smart Connect **47**  
Software guide **76**  
Sony e-mail support service **77**  
speakers  
    external **74**  
    troubleshooting **84**  
Start button **26**  
starting  
    computer **25**  
startup problems **26**  
System Hibernation mode **49**  
System Suspend mode **49**

**T**

technical specifications **76**  
technical support **76, 77**  
Touchpad  
    accessing **34**  
    features **34**  
touchpad **16, 34, 81**  
troubleshooting **78**

- startup **26, 78**
- turning on
  - computer **25**
- TV
  - interference **94**
- U**
- USB
  - connecting **73**
  - connector **17, 56, 73**
- V**
- VAIO-Link **77**
  - response center **77**
  - software **77**
- ventilation **94**
- video camera **67**
- W**
- weight saver
  - attaching **50**
  - connecting **53**
  - removing **54**
- Windows®
  - key **29**
  - key combinations **30**
  - Start button **26**
  - taskbar **26, 80**