

SONY

Sony Notebook Computer
User Guide

VAIO

Notice to Users

© 1999 Sony Corporation. All rights reserved. This manual and the software described herein, in whole or in part, may not be reproduced, translated, or reduced to any machine-readable form without prior written approval.

SONY CORPORATION PROVIDES NO WARRANTY WITH REGARD TO THIS MANUAL, THE SOFTWARE, OR OTHER INFORMATION CONTAINED HEREIN AND HEREBY EXPRESSLY DISCLAIMS ANY IMPLIED WARRANTIES OR MERCHANTABILITY OR FITNESS FOR ANY PARTICULAR PURPOSE WITH REGARD TO THIS MANUAL, THE SOFTWARE OR SUCH OTHER INFORMATION. IN NO EVENT SHALL SONY CORPORATION BE LIABLE FOR ANY INCIDENTAL, CONSEQUENTIAL, OR SPECIAL DAMAGES, WHETHER BASED ON TORT, CONTRACT, OR OTHERWISE, ARISING OUT OF OR IN CONNECTION WITH THIS MANUAL, THE SOFTWARE, OR OTHER INFORMATION CONTAINED HEREIN OR TO USE THEREOF.

Sony Corporation reserves the right to make any modification to this manual or the information contained herein at any time without notice. The software described herein is governed by the terms of a separate user license agreement.

Sony, DVgate, i.LINK™, Mavica, PictureGear, Memory Stick and the Memory Stick logo, VAIO and the VAIO logo are trademarks of Sony Corporation. Windows and the Windows 98 logo are registered trademarks of Microsoft Corporation. Intel, MMX, Celeron and Pentium are trademarks of Intel Corporation.

All other trademarks are trademarks of their respective owners.

Specifications are subject to change without notice.

Safety Information

Owner's Record

The model number and serial number are located on the bottom of your Sony Notebook Computer. Record the serial number in the space provided here. Refer to the model and serial number when you call VAIO-Link.

Serial number: _____

Model number: _____

PCG-F250 / PCG-F270 / PCG-F290

WARNING

- Opening the unit, for whatever reason, could lead to damages that are not covered by the guarantee.
- To avoid electrical shock, do not open the cabinet. Refer servicing to qualified personnel only.
- Audio and picture distortion may occur if this equipment is positioned in close proximity to any equipment emitting electromagnetic radiation.
- To prevent fire or shock hazard, do not expose your Sony Notebook Computer to rain or moisture.
- Never install modem or telephone wiring during a lightning storm.
- Never install telephone jacks in wet locations unless the jack is specifically designed for wet locations.
- Never touch uninsulated telephone wire or terminals unless the telephone line has been disconnected at the network interface.
- Use caution when installing or modifying telephone lines.
- Avoid using the modem during an electrical storm.
- Do not use the modem or a telephone to report a gas leak in the vicinity of the leak.
- Use your notebook only with the supplied AC adapter. To disconnect your notebook completely from mains voltage, unplug the AC-adaptor.
- Please make sure that the socket outlet is easily accessible.

Regulatory Information

This product conforms to the following European Directives: 73/23/EEC (Low Voltage Directive) 89/336/EEC, 92/31/EEC (EMC Directives) 93/68/EEC (CE Marking Directive)

This product complies with EN 55022 Class B and EN 50082-1 for use in following areas: residential, commercial and light-industrial.

This product has been tested and found compliant with the limits set out in the EMC Directive for using connection cables shorter than 3 metres (9.8 feet)

According to the model: The DVD-ROM / CD-ROM is classified as a CLASS 1 LASER PRODUCT and complies with the Laser Product Safety Standard EN 60825-1. Repair and maintenance only by authorized Sony technicians. Improper repairs and use can create safety hazards.



As an ENERGY STAR Partner, Sony has determined that this product meets the ENERGY STAR guidelines for energy efficiency. Energy Star is an U.S. registered mark.

DISPOSAL OF LITHIUM ION BATTERY

- ! **Do not handle damaged or leaking Lithium ion batteries. Dispose of promptly and properly.**
- ! **Danger of explosion if battery is incorrectly replaced. Replace only with the same or equivalent type recommended by the manufacturer. Discard used batteries according to the manufacturer's instructions (see below).**
- ! **The battery pack used in this device may present a fire or chemical burn hazard if mistreated. Do not disassemble, heat above 100°C (212°F) or incinerate. Dispose of used battery promptly.**
- ! **Keep away from children.**
- ! **Your notebook is equipped with an internal backup memory battery. For changing this battery, please contact VAIO Link.**



Disposal of Lithium ion batteries

Dispose of properly at end-of-life. In some areas the disposal of lithium ion batteries in household or business waste may be prohibited. Please use the public collection system.

Contents

Welcome

| | |
|---------------------------------------|----|
| Unpacking Your Notebook Computer..... | 9 |
| Ergonomic Considerations..... | 10 |

Using Your Notebook Computer

| | |
|--|----|
| Locating the Controls and Connectors..... | 13 |
| Connecting a Power Source..... | 17 |
| Starting Your Computer..... | 22 |
| Shutting Down Your Computer..... | 23 |
| Registering Windows® 98..... | 24 |
| Registering Your Computer..... | 25 |
| Using the Keyboard..... | 26 |
| Using the Floppy Disk Drive..... | 33 |
| Using the DVD-ROM / CD-ROM Drive..... | 35 |
| Using PC Cards..... | 37 |
| Using the Programmable Power Keys (PPK)..... | 40 |
| Using Smart Connect..... | 42 |
| Using Infrared Communication Devices..... | 43 |
| Using Power Saving Modes..... | 45 |
| Using a Second Battery Pack..... | 47 |
| Using the Weight Saver..... | 49 |

Connecting peripheral devices

| | |
|---|----|
| PC card modem..... | 52 |
| Activating the functionality of your modem PC Card..... | 54 |

| | |
|---|----|
| Port Replicator..... | 56 |
| Printer | 59 |
| External Display..... | 60 |
| Digital Still Camera or Other Serial Device | 63 |
| To use Memory Sticks | 65 |
| Digital Video Camera Recorder..... | 66 |
| MiniDisc® deck with MD Player..... | 67 |
| External Mouse or Keyboard | 69 |
| External Speakers..... | 70 |
| External Microphone | 71 |
| Universal Serial Bus (USB) Device | 72 |

Getting Help

| | |
|---|----|
| About Sony's Support Options..... | 73 |
| Troubleshooting..... | 74 |
| Using the Product Recovery CD-ROMs..... | 82 |

| | |
|---------------------------|-----------|
| <i>Notes on Use</i> | <i>85</i> |
|---------------------------|-----------|

| | |
|-----------------------------|-----------|
| <i>Specifications</i> | <i>91</i> |
|-----------------------------|-----------|

| | |
|-------------------|-----------|
| <i>Index.....</i> | <i>93</i> |
|-------------------|-----------|

Welcome

Congratulations on purchasing a Sony VAIO Notebook Computer. Sony has combined leading-edge technology in audio, video, computing, and communications to provide you with state-of-the-art personal computing.

Here are just some of the features your Sony Notebook Computer has to offer (read the details in the Specifications chapter of this guide).

- ❑ Exceptional performance - Your PC includes a fast Intel[®] processor, a fast CD-ROM drive or a DVD-ROM drive (according to the model), and a PC card modem (according to the model).
- ❑ Portability - The rechargeable battery pack provides hours of use without AC power.
- ❑ Sony audio and video quality - A high-resolution LCD screen enables you to take advantage of today's advanced multimedia applications, games, and entertainment software.
- ❑ Communications - Access popular online services, send and receive e-mails, browse the Internet, and use the dialing and fax features.
- ❑ Excellent customer support - If you have any problem with your computer, you can contact VAIO-Link by telephone, fax or e-mail (see your Customer Service Guide for phone numbers and addresses). Before calling VAIO-Link, you may try to solve the problem by reading your User Guide (troubleshooting chapter) or the manuals and Help files of the peripherals or software.

About the User Guides

This User Guide :

- ❑ **Using Your VAIO Notebook Computer** shows you how to use the standard components of your system.
- ❑ **Connecting Peripheral Devices** explains how you can add functionality by connecting various peripherals.
- ❑ **Getting Help** explains the support options available to you, and offers basic troubleshooting tips.
- ❑ **Notes on Use** provides facts and advice about using your notebook computer.
- ❑ **Specifications** of your computer, drivers and accessories.

Refer to your **Software Guide** for information on the bundled software and the Sony applications:

- ❑ **About the Software** is a short description of the features of the software pre-installed on your system
- ❑ **Customizing your notebook** explains you how to set your system and power management with Sony Notebook Setup, PPK Setup, PowerPanel, BatteryScope...
Learn how to set your display with NeoMagic[®] and enjoy the Dual Screen Display option.

On-line User Guides are included with your computer as electronic documents.

Unpacking Your Notebook Computer

Remove the following hardware items from the box:

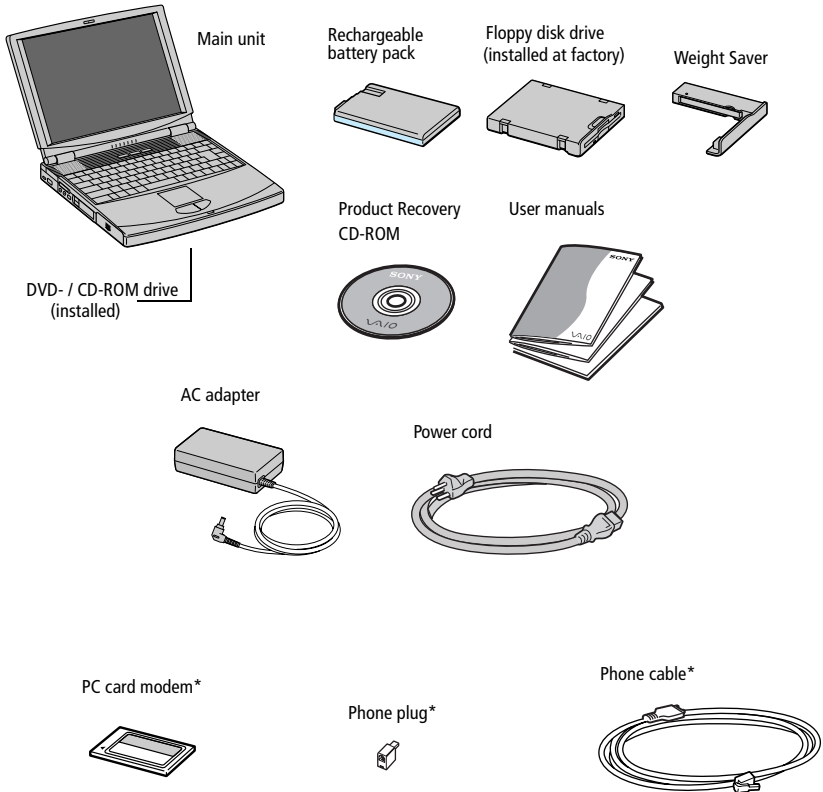

 *Depending on the type of Sony Notebook you purchased, the PC card modem (and accessories) may be optional. However, you need to have these peripherals to enjoy some of the features described in this manual.

Ergonomic Considerations

You will be using your notebook computer as a portable device in a variety of environments. Whenever possible, you should attempt to apply the following ergonomic considerations to both stationary and portable environments.

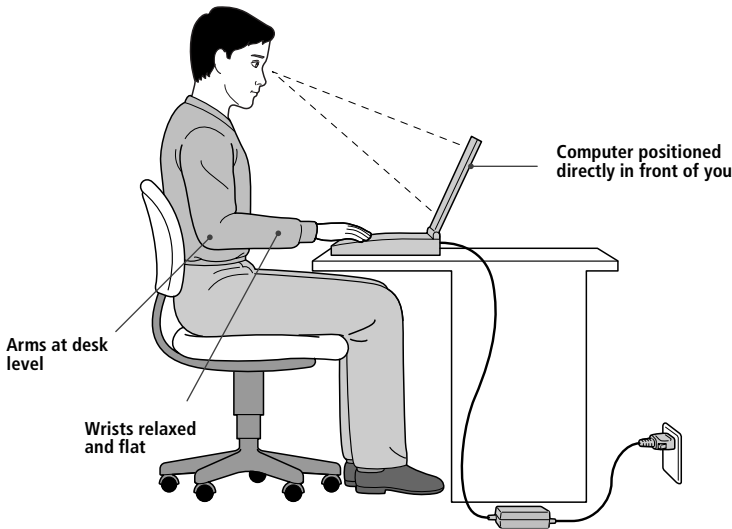

- ❑ **Position of your computer** – Place the computer directly in front of you as you work. Keep your forearms horizontal, with your wrists in a neutral, comfortable position while using the keyboard, touchpad, or external mouse. Let your upper arms hang naturally at your sides. Take breaks during sessions with your computer. Excessive use of the computer may strain muscles or tendons.
- ❑ **Furniture and posture** – Sit in a chair with good back support. Adjust the level of the chair so your feet are flat on the floor. A footrest may make you more comfortable. Sit in a relaxed, upright posture and avoid slouching forward or leaning far backward.
- ❑ **Viewing angle of the computer's display** – Use the display's tilting feature to find the best position. You can reduce eye strain and muscle fatigue by adjusting the tilt of the display to the proper position. Adjust the brightness setting of the display also.

- ❑ **Lighting** – Choose a location where windows and lights do not create glare and reflection on the display. Use indirect lighting to avoid bright spots on the display. You can also purchase accessories for your display that help reduce glare. Proper lighting adds to your comfort and work effectiveness.
- ❑ **Placement of an external display** – When using an external display, set the display at a comfortable viewing distance. Make sure the display screen is at eye level or slightly lower when you are sitting in front of the monitor.
- ❑ **Tilt stands** – You use the tilt stands to place the computer at an angle that allows comfortable typing.

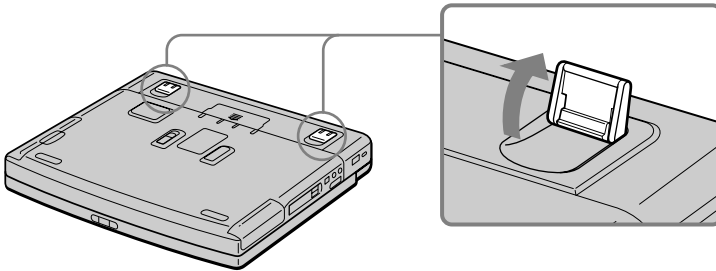

Using Your Notebook Computer

This section describes how to start using your computer and how to use your computer's internal devices, such as the touchpad, the disk drives, the battery...

Locating the Controls and Connectors

Front

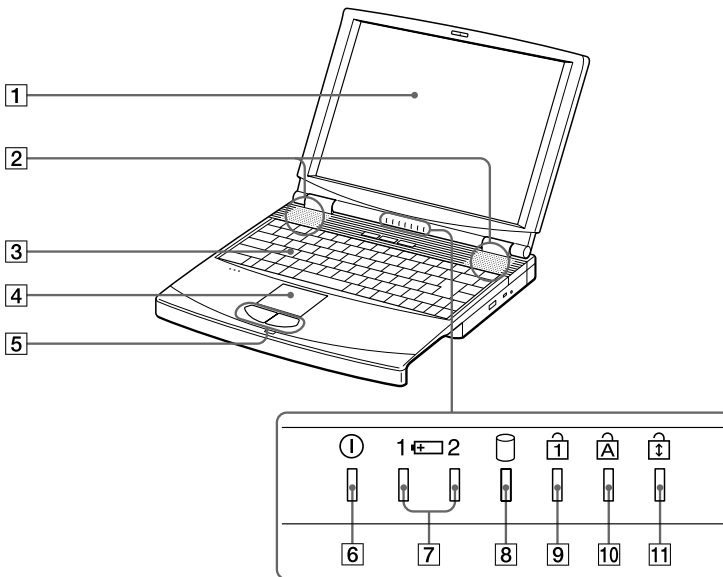

1 LCD screen (page 30)

2 Speakers (page 30)

3 Keyboard (page 26)

4 Touchpad (page 32)

5 Left/right buttons (page 32)

6 Power indicator (page 29)

7 Battery 1 and 2 indicators (page 29)

8 Hard disk drive indicator (page 29)

9 Num Lock indicator (page 29)

10 Caps Lock indicator (page 29)

11 Scroll Lock indicator (page 29)

Left

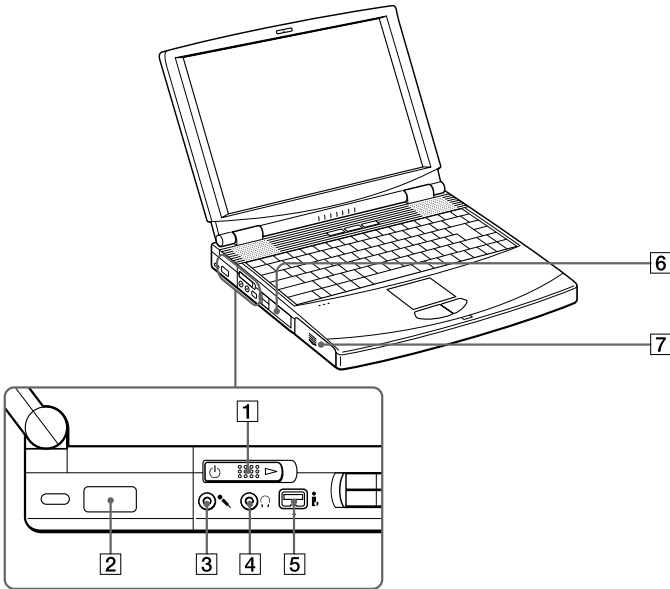

1 ⏻ Power switch (page 22)

2 Infrared port (page 43)

3 🎤 Microphone connector (page 71)

4 🎧 Headphone connector

5 📶 S200 i.LINK™ connector (page 66)

6 PC card slots (page 37)

7 Battery bay (page 18)

🔌 AC adapter mains connector and power cord: hazardous voltage, according to EN 60950.

All other connectors for this notebook are SELV (Safety Extra Low Voltage), according to EN 60950.

Right

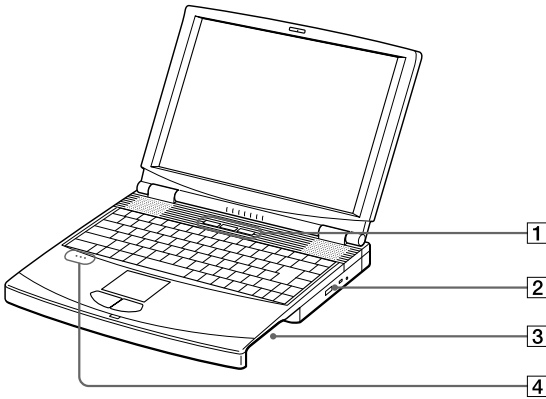

- 1 PPK buttons (page 40)
- 2 DVD-ROM / CD-ROM drive (page 35)
- 3 Multi-purpose bay (pages 33, 35)
- 4 Internal microphone

Back

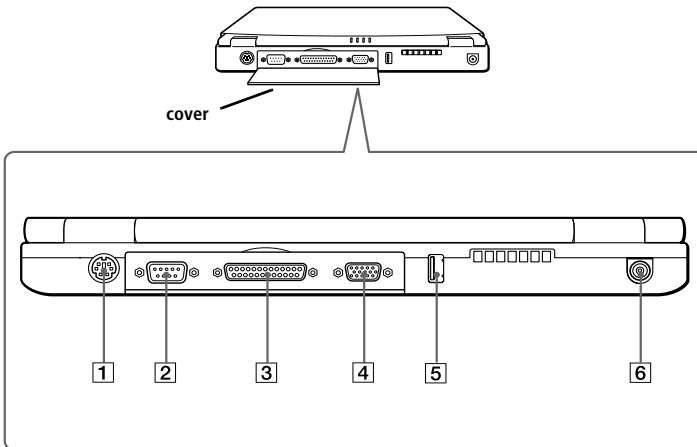

- 1 Mouse/Keyboard connector (page 69)
- 2 IO/Serial connector (page 63)
- 3 Printer (page 59)
- 4 Monitor connector (page 60)
- 5 USB connector (page 72)
- 6 DC In (page 17)

Bottom

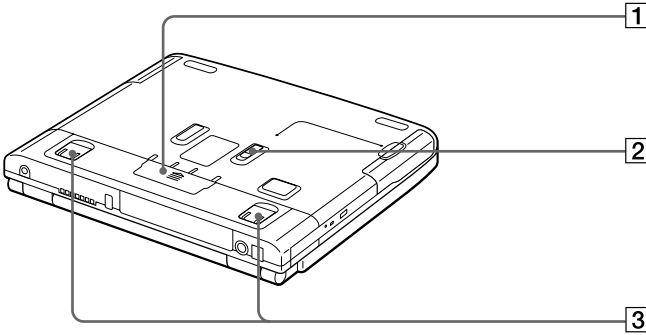

1 Port replicator connector cover

3 Tilt stands

2 Release lever



There is a ventilation slot located near the USB connector. Do not cover the ventilation slot when your computer is on.

Connecting a Power Source

You can use either AC power or a rechargeable battery pack as a power source.

Using the AC Adapter

- 1 Plug the cable attached to the AC adapter into the DC In connector on the computer.
- 2 Plug one end of the power cord into the AC adapter.
- 3 Plug the other end of the power cord into an AC outlet.

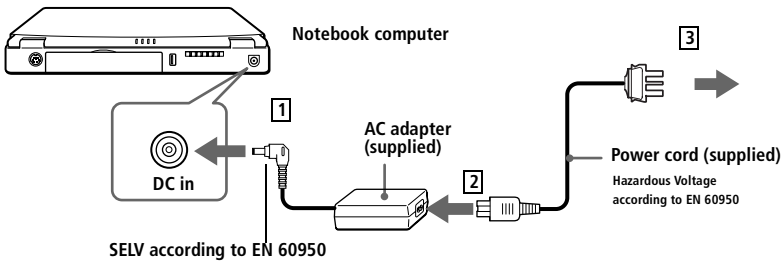

Use your notebook only with the supplied AC adapter.

To disconnect your notebook completely from mains voltage, unplug the AC adapter.

Please make sure that the socket outlet is easily accessible.

Using Battery Power

You can use one or two battery packs as a source of power. You can insert the second battery pack into the multi-purpose bay on the right side of the computer. (See "Using a Second Battery Pack" on page 47.). Additional battery packs are available as a separate option.

Additional battery packs are available as a separate option.

The battery pack supplied with your computer is not fully charged at the time of purchase. Follow the steps below to insert and charge the battery pack.

To insert the battery pack

- 1 Open the cover of the battery bay.

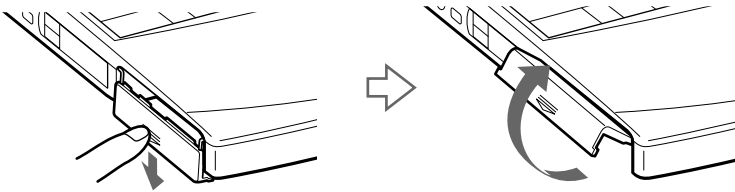

- 2 Insert the battery pack into the battery bay on the left side of the computer.

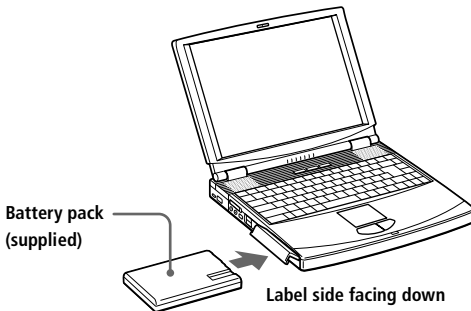

- 3 Close the cover of the battery bay until it clicks.

To charge the battery pack



- 1 Connect the AC adapter to the computer.
- 2 Insert the battery pack.

The computer automatically charges the battery (the battery indicator light flashes in a double blink pattern as the battery charges). When the battery is 85 percent full, the battery indicator light turns off. This process takes approximately two hours. To charge the battery completely, continue charging for an additional hour.

A fully charged battery pack supplies power for approximately 2 to 3 hours. The time varies according to your system configuration. See your Software guide, in "Displaying Battery Information" for information on checking the battery life.

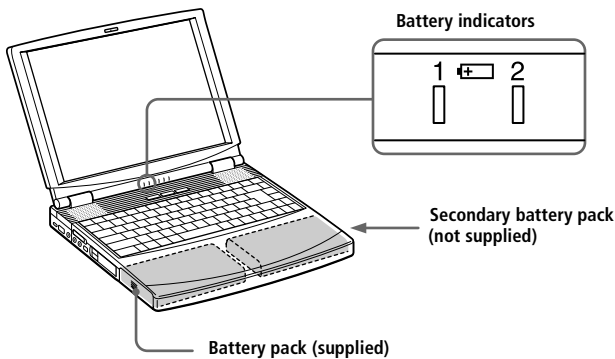
There are two battery indicator lights on the computer:



| <i>Battery Indicator</i> | <i>Meaning</i> |
|---|--|
| 1  | Indicates the status of the battery pack in the battery bay on the left side of the computer. |
|  2 | Indicates the status of the battery pack in the multi-purpose bay on the right side of the computer. |

*Battery Indicator
Light Status* *Meaning*

| | |
|--------------|--------------------------------------|
| On | The computer is using battery power. |
| Single blink | The battery is running out of power. |
| Double blink | The battery is charging. |
| Off | The computer is using AC power. |



For some software applications and some peripheral devices, your computer may not enter system hibernation mode when battery life is low. To avoid loss of data when using battery power, you should save your data frequently and manually activate a power management mode, such as system suspend or system hibernation.

When the battery is running out of power, both the battery and power indicators blink. To determine the time the battery lasts, see your Software guide, in "Displaying Battery information".

See "Using a second battery pack" for information on installing and charging a battery pack in the multi-purpose bay.

Keep the battery pack in the computer while it is directly connected to AC power. The battery pack continues to charge while you are using the computer.

If the battery level falls to below 10%, you should either attach the AC adapter to recharge the battery or shut down your computer and insert a fully charged battery.

You can extend battery life by changing the power management modes in the PowerPanel utility. See your Software guide, in "Controlling Power Management".

The battery pack supplied with your computer is a lithium ion battery and can be recharged at any time. Charging a partially discharged battery does not affect battery life.

The battery indicator light is on while you use the battery pack as a power source. When battery life is nearly depleted, the battery indicator starts flashing.

To remove the battery pack

- 1 Open the cover of the battery bay.
- 2 Pull out the battery pack.

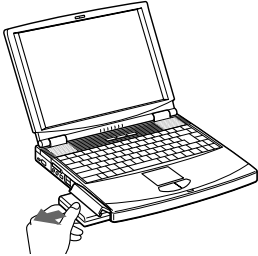

- 3 Close the cover of the battery bay.

! You may lose data if you remove the battery pack while the computer is on and not connected to the AC adapter or if you remove the battery while the computer is in system suspend mode.

Starting Your Computer

- 1 Slide the LCD lock lever in the direction of the arrow, and lift the cover.

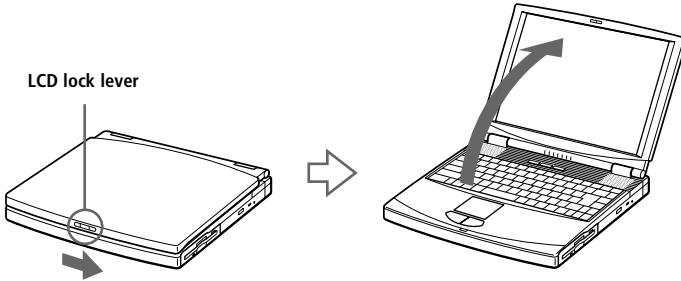

- 2 Slide the power switch on the left side toward the front of the computer until the green power indicator light turns on.

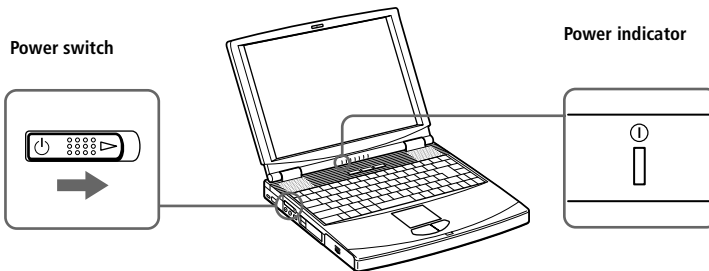

 If you hold the power switch in the on position for more than four seconds, the computer turns off.

- 3 If necessary, adjust the brightness controls for the LCD display with Fn+F5. To increase the brightness, use the up or right arrow keys. To decrease use the down or left arrow keys.

Shutting Down Your Computer

! To avoid potential loss of data, follow these steps to shut down your computer.

- 1 Click the Start button on the Windows® 98 taskbar.
- 2 Click Shut Down at the bottom of the Start menu to display the Shut Down Windows dialog box.

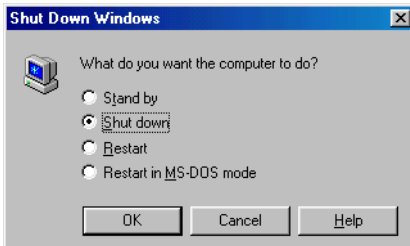

- 3 Select Shut down.
- 4 Click OK.

 Respond to any prompts warning you to save documents.

- 5 Wait for your computer to turn off automatically. The power indicator (green) turns off.
- 6 Turn off any peripherals connected to your computer.

 If you are unable to shut down your computer using the steps described previously, press the Ctrl+Alt+Delete keys at the same time to restart the computer. If you are unable to restart the computer in this way, you can slide the power switch forward and hold for four seconds. This operation may result in data loss.

During a period of inactivity, you can conserve battery life by using System Suspend mode. See your Software guide, in "Controlling Power Management".

Registering Windows® 98

 You must register Windows® 98 before you can use the computer.

The first time you turn on your computer, you need to complete a few steps to register and configure the Windows® 98 software that is already installed on your computer.

The on-screen instructions guide you through the registration and configuration process. The following is an overview of the process.

- 1 Gathering information:
 - Enter your name.
 - Read and accept the License Agreement.
 - Enter your Certificate of Authenticity number located on the cover of the Microsoft Windows® 98 *Getting Started* manual.
- 2 Windows® 98 setup:
 - Click the Finish button on the Windows® 98 Setup Wizard screen.
- 3 Selecting your computer settings:
 - If necessary, change the Time Zone, Date and Time on the Date/Time Properties screen.
- 4 Learning about Windows® 98:
 - If you want, take the tour of Windows® 98.

Registering Your Computer

You can take advantage of Sony's commitment to quality customer support and receive the following benefits by registering your computer with Sony:

- ❑ **VAIO-Link** – You can contact VAIO-Link by telephone, fax or e-mail (see your Customer Service Guide for phone numbers).
- ❑ **Guarantee** – Protect your investment. See the Guarantee Card for the terms and conditions and please refer to your Customer Service Guide for more information.

Follow these steps to use the Sony Notebook Computer's online registration service.



You must connect your phone line before using any online services, including the online registration service. See "Connecting to a phone line".

- 1 Enter the information requested in the online registration form.
- 2 Click the Register now button and complete the form.

Click the Send Directly Button to register your computer, via modem to modem connection. Your computer automatically transfers your registration information, using your PC Card modem and a preset phone number.



Click Send via Internet if you chose to send your information via the WWW.

Using the Keyboard

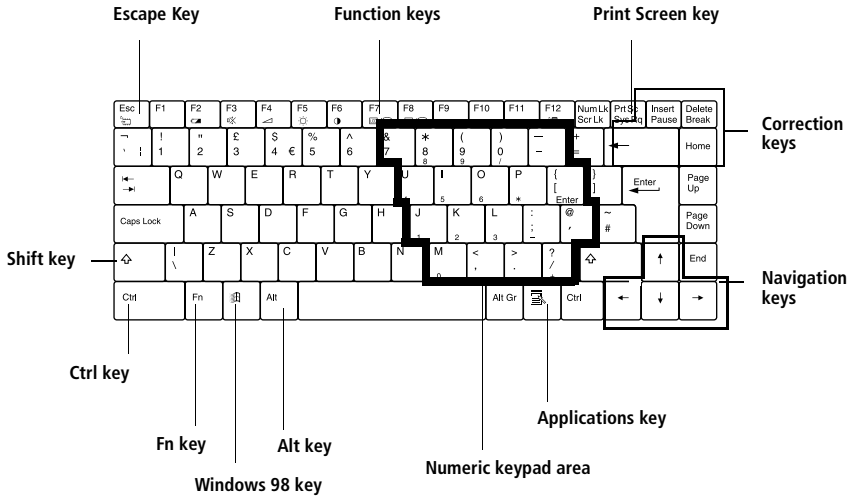
Your keyboard is very similar to a desktop computer's, but the keyboard has additional keys that perform specific notebook computer-related tasks.







| Keys | Descriptions |
|---------------------|---|
| Numeric keypad area | Contains the keys found on a typical calculator. Use the numeric keypad area to type numbers or to perform mathematical calculations such as addition and subtraction. Note that you must press the Num Lock key to activate the numeric keypad. (When you do so, the Num Lock light will be on.) |
| Navigation keys | Several keys are devoted to moving the cursor on the screen. |
| Correction keys | The Insert, Back Space, and Delete keys enable you to make corrections in your documents. |
| Function keys | The twelve function keys along the top of the keyboard are used to perform designated tasks. For example, in many applications, F1 is the Help key. The task associated with each function key may vary from one application to the next. |
| Escape key | The Esc (Escape) key is used to cancel commands. |

| <i>Keys</i> | <i>Descriptions</i> |
|--|---|
| Print Screen key | The Print Screen key takes an electronic snapshot of the screen and places it in the Windows Clipboard. You can then paste the screen shot into a document and print it. |
| Operator keys | Several keys are always used with at least one other key: Ctrl, Alt, and Shift. When held down with another key, the Ctrl (Control) and Alt (Alternate) keys offer another way to give commands. For example, in many applications, instead of choosing the Save command from a menu, you can hold down Ctrl and press S (referred to as Ctrl+S). The Shift key is used to produce capital letters or special symbols such as @ and \$. |
| Windows [®] 98 key  | The key with the Windows [®] logo displays the Windows [®] 98 Start menu; it's the equivalent of clicking the Start button on the task bar. See "Combinations and functions with the Windows [®] 98 key". |
| Fn key | The Fn key is used in combination with other keys to issue commands. See "Combinations and functions with the Fn key". |
| Applications key  | The Applications key displays a shortcut menu of context-sensitive choices; pressing this key is the equivalent of clicking the right mouse button. |

Combinations and Functions with the Windows® 98 Key



























| <i>Combinations</i> | <i>Functions</i> |
|-----------------------|--|
| Windows + F1 | Displays Windows Help |
| Windows + Tab | Switches the selected button on the taskbar. |
| Windows + E | Displays Windows Explorer. |
| Windows + F | Displays the Windows Find: All Files window to find a file or folder. This is the equivalent of selecting Find and then Files or Folders from the Start menu. |
| Windows + Ctrl + F | Displays the Windows Find: Computer window where you can locate other computers. This is the equivalent of selecting Find and then Computer from the Start menu. |
| Windows + M | Minimizes all displayed windows. |
| Shift + Windows + M | Returns all minimized windows to their previous size. |
| Windows + R | Displays the Run window. This is the equivalent of selecting Run from the Start menu. |
| Fn + Windows + Insert | Displays the Properties window. This is the equivalent of double-clicking the System icon in the Control Panel. |

Indicators

| <i>Indicator</i> | <i>Functions</i> | |
|--|--|---|
| Power  | Power on: lights green. System Idle mode: lights amber. System suspend mode: flashes amber. | |
| Battery 1 1  | Indicates the status of the battery inserted in the battery bay on the left side of the computer. | |
| Battery 2  2 | Indicates the status of the battery inserted in the multi-purpose bay on the right side of the computer. | |
| Hard disk  | Lights when data is read from or written to the hard drive. Do not enter System Suspend mode or turn off the computer when this indicator light is on. | |
| <i>Light</i> | <i>On</i> | <i>Off</i> |
| Num Lock | Turns on when the number keys area in the numeric keypad are active. | Turns off when the alphanumeric character keys in the key pad area are active. |
| Caps Lock | Turns on when the letters appear in uppercase as you type. The Shift key lowers the case of typed letters when Caps Lock is on. | Turns off when letters appear in lower case as you type (unless you hold down the Shift key). |
| Scroll Lock | Turns on when the screen scrolls differently. (Exactly how it scrolls depends on the specific application. It has no effect in many applications.) | Turns off when information moves across the display normally. |

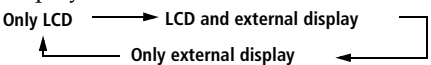
Combinations and Functions with the Fn Key

Combinations/Feature Functions

| | |
|--|--|
| Fn+  (ESC) System Suspend | Puts the system into System Suspend mode, a power management state. To return the system to the active state, press any key. |
| Fn+  (F2) Display power status | Displays the power status, as in the example below:  Using Ac power  Charging the battery |
| Fn+  (F3) Speaker switch | Toggles the built-in speaker off and on. |
| Fn+  (F4) Speaker volume | Adjusts the built-in speakers volume. To increase volume, press Fn+F4, then  or  To decrease volume, press Fn+F4, then  or  |
| Fn+  (F5) Brightness control | Adjusts the brightness of the LCD. To increase light intensity, press Fn+F5, then  or  To decrease light intensity, press Fn+F5, then  or  |
| Fn+  (F6) Contrast control | Only applicable for models equipped with an HPA display: To increase contrast, press Fn+F6, then  or  To decrease contrast, press Fn+F6, then  or  |
| Fn+  /  (F7) Switch to the external display | Toggles through the LCD, external display (connected to the Monitor connector) and both LCD and external display.  |
| Fn+  /  (F8) Not available on this model. | Not available on this model. |
| Fn+  (F12) System Hibernation | Provides for the lowest level of power consumption. When you execute this command, the state of the system and of the peripheral devices are written to the hard disk and the system power is turned off. |
| Fn+S System Idle | Puts the system into Idle mode, a power management state. To return to the active state, press any key. |
| Fn+D Video standby | Turns off the LCD in order to save power. |
| Fn+E Eject DVD- / CD-ROM | Ejects the DVD-ROM / CD-ROM tray. |

| <i>Combinations/Feature</i> | <i>Functions</i> |
|-----------------------------|---|
| Fn+F Change Display size | Zooms the display size in or out when the display is set to a low resolution. |

Using the Touchpad

The keyboard contains a cursor-pointing device called a touchpad. You can point to, select, drag, and scroll objects on the screen using the built-in touchpad.

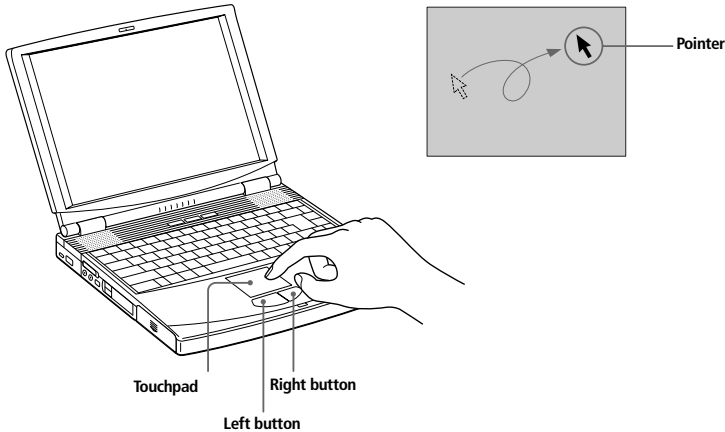

 See Mouse Properties (ALPS) for information on touchpad features, such as clicking both buttons, adjusting touchpad speed, and Easy Launcher functions. To access ALPS Properties, double-click the Mouse icon in the Control Panel (select ALPS Options for additional settings).

| <i>Action</i> | <i>Description</i> |
|---------------|---|
| Point | Slide one finger on the touchpad to place the pointer on an item or object. |
| Click | Press the left button once. |
| Double-click | Press the left button twice. |
| Right-click | Press the right button once. In many applications, this action displays a shortcut menu of context-sensitive choices. |
| Drag | Slide one finger while pressing the left button. |
| Scroll | Move your finger along the right edge of the touchpad to scroll vertically. Move your finger along the bottom to scroll horizontally. (The scroll function is available only with applications that support a touchpad scroll feature.) |

Using the Floppy Disk Drive

The computer comes with the floppy disk drive in the multi-purpose bay.

To insert a diskette

- 1 Hold the diskette with the label side facing up.
- 2 Gently push the diskette into the drive until it clicks into place.

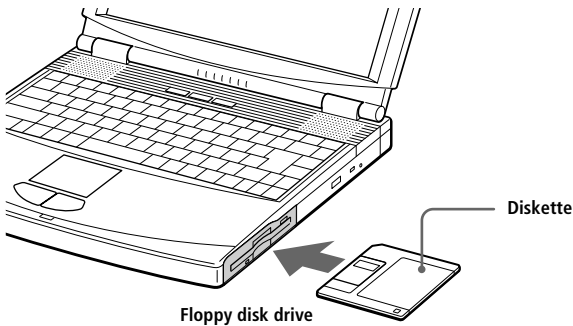

To remove a diskette

- When you finish using the diskette, wait until the LED indicator turns off and then press the Eject button to remove the diskette.

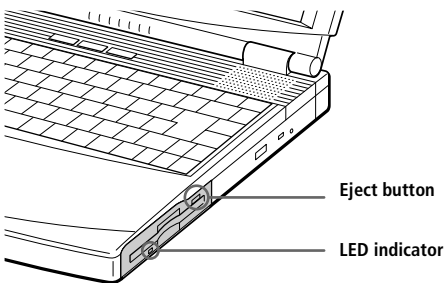

 If you have difficulty removing a diskette from the floppy disk drive, remove the floppy disk drive from the multi-purpose bay.

To remove the floppy disk drive

- 1 Turn off the computer.
- 2 There is a RELEASE lever on the bottom of the computer. Slide this lever in the direction of the arrow.

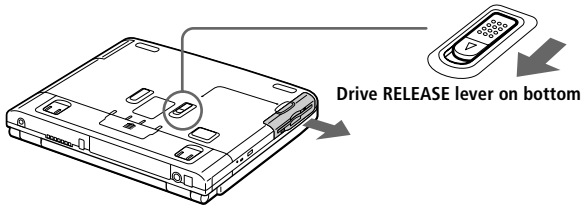

- 3 Slide the drive out of the multi-purpose bay.
- 4 Insert the weight saver. See “ Using the Weight Saver” on page 49.

To re-insert the floppy disk drive

- 1 Turn off the computer.
- 2 If another device is in the multi-purpose bay, remove the device. See To remove the second battery pack.
- 3 Insert the floppy disk drive into the multi-purpose bay with the metallic part up. Continue pushing the drive into the bay until the RELEASE lever locks into place.

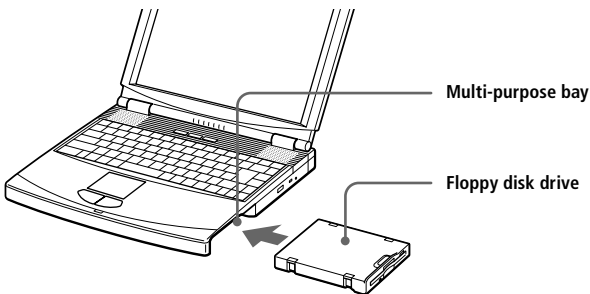

Using the DVD-ROM / CD-ROM Drive

Depending on the model you purchased, your computer is equipped with a DVD-ROM or a CD-ROM drive.

The DVD-ROM drive plays both DVD-ROM and CD-ROM discs.

To insert a disc

- 1 Turn on the computer.

 When the computer is in System Suspend or System Hibernation mode, you cannot insert a disc. See "Using Power Saving Modes" on page 45 for more information on System Suspend and System Hibernation modes.

- 2 Press the Eject button to open the DVD-/ CD-ROM drive. The tray slides out.

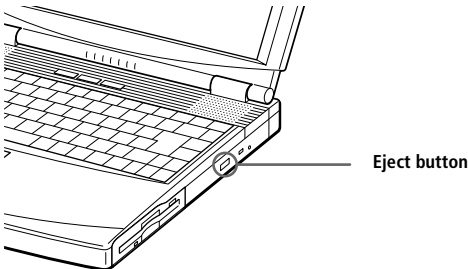

- 3 Place a DVD-/ CD-ROM disc in the tray with the label side facing up. For DVD discs, which can be played on both sides, the side of the disc facing up is the side that plays. Push the disc onto the hub until the disc clicks into place.

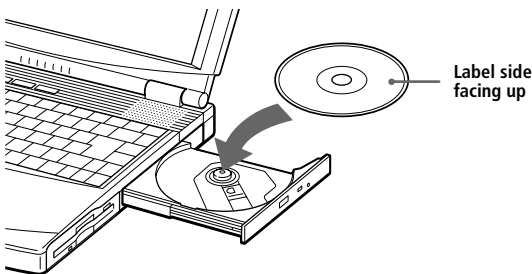

- 4 Close the tray by pushing it gently.

 Be sure to seat the disc firmly over the DVD-ROM / CD-ROM drive hub fingers. If you do not seat the disc firmly, you could damage your disk drive and you may not be able to open the tray.

When you finish using a disc, wait until the LED indicator turns off, then press the Eject button to remove the disc.

When the computer is in System Suspend or System Hibernation mode, you cannot remove a disc. See the chapter "System Suspend Mode" for more information about System Suspend and System Hibernation modes.

If the disc does not come out when you press the Eject button, turn off the computer and insert a thin, pointed object into the manual eject hole.

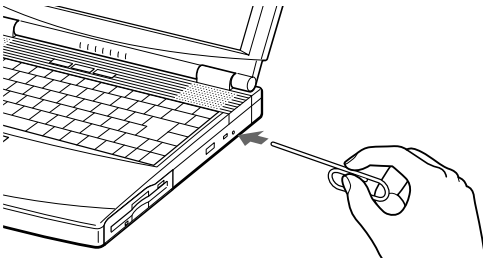

To play DVD-ROM discs

To achieve optimum performance when playing DVD-ROM discs, you should use the following recommendations.

- ❑ Your computer should not be connected to the port replicator while playing DVD movies or using DVD applications.
- ❑ Close any open applications before playing a DVD-ROM movie.

 When playing DVD movies on battery power, set the power management profile to Maximum Performance. With other profiles, the movies are choppy.

Depending on the display setup properties you selected, you may use Fn+F command to expand the screen to full screen size.

Region codes indicators, such as "2" (Europe) or "ALL" are labelled on some DVD discs to indicate what type of player can play the disc. Unless a "2" or "ALL" is labelled on your DVD disc or on the packaging, you cannot play the disc on this player.

Using PC Cards

Your computer includes two PC card slots. PC cards allow you to connect portable external devices, such as another hard disk drive, or to connect a network.



The PC card slots can accommodate (at the same time) two Type I, two Type II, or one Type III PC card. These slots are compatible with Card Bus port.

Some PC cards may require that you disable idle devices when using the PC card. You can use Sony Notebook Setup to disable devices. See your Software guide, in "Sony Notebook Setup" for details.

Be sure to use the most recent software driver provided by the PC card manufacturer.

If an "!" mark appears on the Device Manager tab in the System Properties dialog, remove the software driver and then reinstall it.

You may not be able to use some PC cards or some functions within the PC card with this computer.

You do not need to shut down the computer before inserting or removing a PC card.

To insert a PC Card Modem, refer to the chapter "PC card modem".

To insert a PC card

Use the lower slot for PC type III cards.

! Some devices may not function properly if you repeat returning to normal mode from System Suspend Mode or System Hibernation mode. The computer will return to its original state if you restart it.

- 1 Pull the PC card release button up away from the computer and push it in toward the computer.

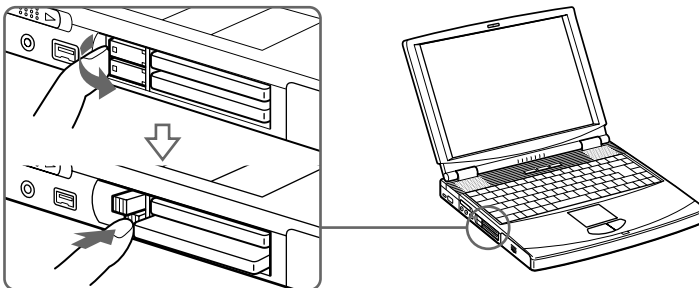

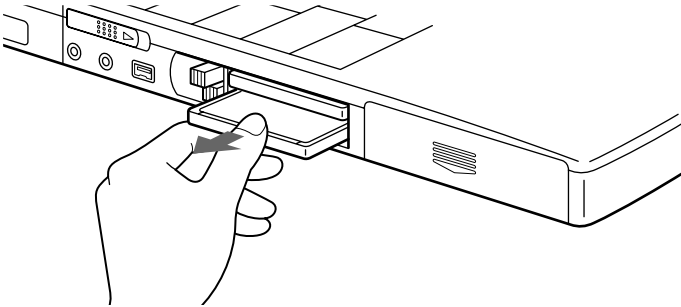

2 Remove the PC card slot protector.

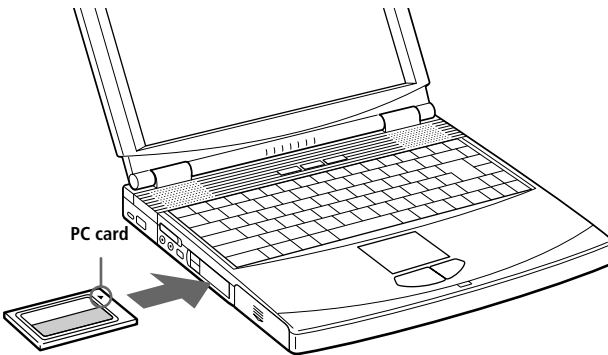

 When you use a Type III PC card, you need to remove both the top and bottom PC card slot protectors

3 Insert the PC card into the PC card slot, front label facing up. Gently push the card into the slot until the card is fixed into the connector. The release button comes out.



 Do not force a card into the slot. It may damage the connector pins. If you have difficulty inserting a card, check that you are inserting the card with the correct orientation. See the manual that came with your PC card for more information on use.

For some PC cards, if you alternate between normal power operation and the system suspend or system hibernation power management modes while the card is inserted, you may find that a device connected to your system is not recognized. Reboot your system to correct the problem.

To remove a PC card

- 1 Close any applications that are using the PC card.
- 2 Click the PC card icon in the taskbar and close the card.
- 3 Pull the PC card release button up and press it in toward the computer.
- 4 Gently grasp the card and pull it out.
- 5 Insert the PC card slot protector back into the empty slot.



Before you remove the PC card, click the PC card icon in the taskbar and close the card. Close any applications that use the PC card before removing the card otherwise data may be lost.

Using the Programmable Power Keys (PPK)

Press the programmable power keys on top of your keyboard to start your favorite software without having to click the shortcuts on the desktop.

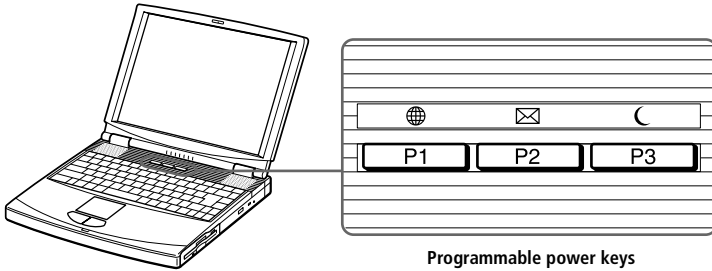

Programmable power keys

Default options of PPK

Use any programmable key by simply pressing it, or in combination with other keys on your keyboard: Shift + PPK, Ctrl + PPK or Alt + PPK. When your computer is off, press P1 or P2, and the system will be powered and launch the appropriate application. The factory settings for the buttons are:

| <i>Key or combination</i> | <i>To open or access...</i> |
|---------------------------|-----------------------------|
| P1 | The Club VAIO Website |
| P2 | E-mail (Outlook Express) |
| P3 | System Suspend Mode (Sleep) |
| Alt + P1 | The VAIO-Link web site |
| Shift + P1 | The VAIO web site |
| Ctrl + P1 | Internet Explorer |
| Ctrl + P3 | The VAIO Autodemo |

Using the Programmable Power Key with other software

You can also choose to start other applications by pressing the programmable power keys in combination with the Alt, Ctrl, or Shift keys. See your Software guide, in “Starting Your Favorite Software With PPK Setup” for further details.

Launching applications with the Timer

Use the PPK Timer to launch applications periodically or to let applications work while you don't use your computer. See your Software guide, in “Using the internal timer:” for details.

Using Smart Connect

With Smart Connect you can copy, edit or delete files on another VAIO computer (equipped with Smart Connect) connected to your computer with an i.LINK™ cable .

You can also print a document on a printer connected to another VAIO computer.

See the online user guide of Smart Connect for more information.

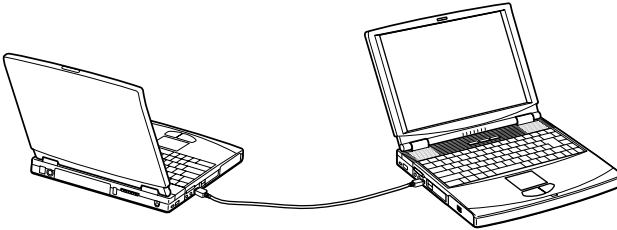

Using Infrared Communication Devices

Your computer includes an infrared port, located on the left side. You can use this port to communicate with other infrared-equipped devices with compatible protocols, such as a digital still camera or other computers.

 When performing a data transfer with any software using infrared, enable the IrDA in the Control panel of Windows, as follows:

1. In the Control panel, choose Infrared, then Options;
2. Check Enable infrared communication, then click OK.
3. As soon as your transfer is finished, disable Infrared, in the Control panel, to reduce the power consumption.

To use infrared communication with a digital still camera

Align the infrared ports on the computer and the digital camera so that they are in a direct line.

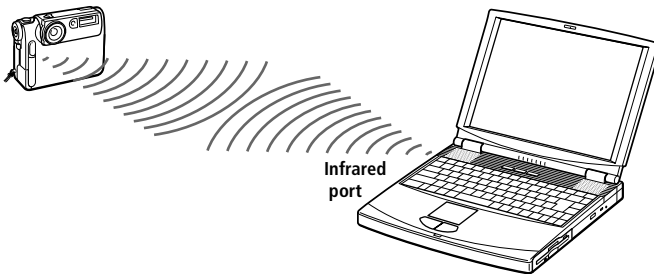

To use infrared communication with another computer

Align the infrared ports on the two computers so that they are in a direct line.

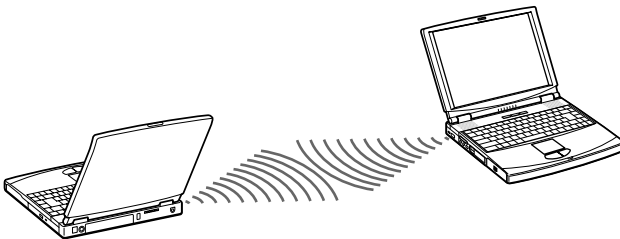

 Check the Status tag of the Infrared Monitor in the Windows Control Panel to determine if the infrared device is detected.

If the two devices are too far apart or too close together, data transfer may be interrupted or there may be noise in the transmission.

Do not cover the infrared ports with your hand or any other objects.

Avoid direct sunlight, fluorescent light, or flashing incandescent light near the infrared ports.

See the manual that came with your digital still camera or other infrared communication device for more information on installation and use.

The active area of infrared transmission extends about 1m (39 ³/₈ inches) with a radius of 15 degrees.

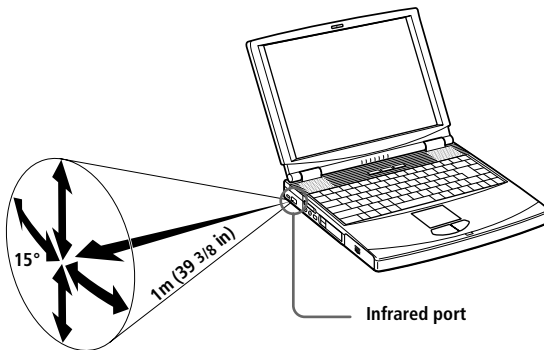

Using Power Saving Modes

When you use a battery as the source of power for your computer, you can take advantage of power management settings to conserve battery life. In addition to the normal operating mode, which allows you to turn off specific devices, your computer has three distinct power saving modes: System Idle, System Suspend and System Hibernation.

When using battery power, you should be aware that the computer automatically enters System Hibernation mode when the remaining battery charge drops below 7 percent, regardless of the power management setting you select. See your Software guide, in "Controlling Power Management" for more information.



If the battery level falls to below 10 percent, you should either attach the AC adapter to recharge the battery or shut down your computer and insert a fully charged battery.

Normal Mode

This is the normal state of your computer when it is in use. The green power indicator light is on in this mode. To save power, you can turn off a specific device such as the LCD or the hard disk.

System Idle Mode

This mode is convenient if you don't need to use your computer for a short period. The hard disk and the video display enter a low power state and the CPU clock and processor stop. The power indicator light is amber in this mode.

To activate System Idle mode

Press Fn+S. You can also enter system Idle mode by using the PowerPanel utility.

To return to normal mode

Press any key.



You cannot resume from System Idle by clicking with a mouse or the touchpad.

System Suspend Mode

The computer saves the current state of the system in RAM and switches off power to the CPU. The amber power light flashes in this mode.

To activate System Suspend mode

Press Fn+Esc, or slide the power switch forward quickly. You can also use the PowerPanel utility to enter System Suspend mode.



If you slide the power switch forward and hold for more than four seconds, the computer switches off automatically.

To return to normal mode

Press any key.

System Hibernation Mode

The state of the system is saved on the hard drive and power is turned off. The power indicator light is off in this mode.

To activate System Hibernation mode

Press Fn+F12. You can also use the PowerPanel utility to enter System Hibernation mode.

To return to normal mode

Turn on the computer by sliding the power switch forward. The computer returns to its previous state.

- Steps to return to normal mode:
System hibernation → System suspend → System Idle
System suspend requires less time than System hibernation.
- Power consumption:
System idle → System suspend → System hibernation
System idle uses more power than System hibernation.



When returning from System hibernation mode, the system status stored on the hard disk is erased and the computer starts normally if you slide the power switch forward and hold for more than four seconds.

Using a Second Battery Pack

You can purchase a second rechargeable battery pack. With two battery packs, you can extend the time that you use your computer with battery power. When using two battery packs, the battery pack you insert first charges first. The battery pack you insert second charges when the first battery pack is 85 percent full. You can monitor which battery pack is charging by observing the battery indicator lights.

To insert a second battery pack

- 1 If another device is in the multi-purpose bay, remove the device. See “To remove the floppy disk drive” on page 34.
- 2 Insert the battery pack into the multi-purpose bay. The battery 2 indicator light turns on.

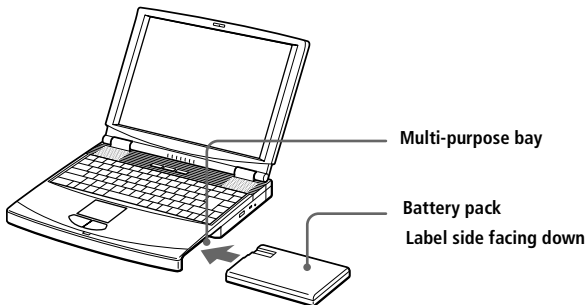

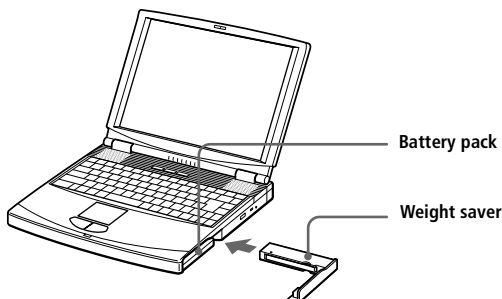

- 3 Attach the Weight Saver to the computer to stabilize the battery pack. Slide the eject lever on the bottom of the Weight Saver toward the front of the computer to lock it. See also “Using the Weight Saver” on page 49.

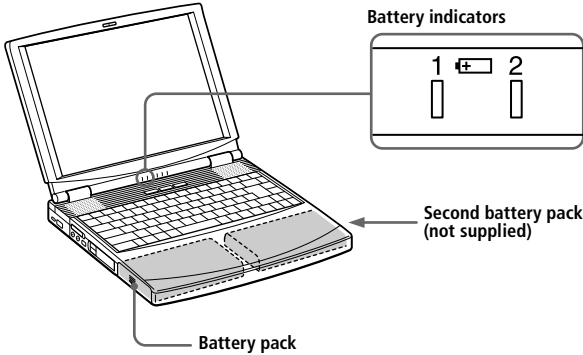

To charge the second battery pack

Keep the battery pack in the computer while it is connected to AC power. The battery indicator flashes while the battery is charging. See also “To charge the battery pack” on page 19 for more information.



 To determine the time the battery lasts, see your Software guide, in “Displaying Battery information”.

To remove the second battery pack

- 1 There is an Eject lever on the bottom of the weight saver. To remove the battery pack, slide this lever in the direction of the arrow 1, then slide the RELEASE lever on the bottom of the computer in the direction of the arrow 2.

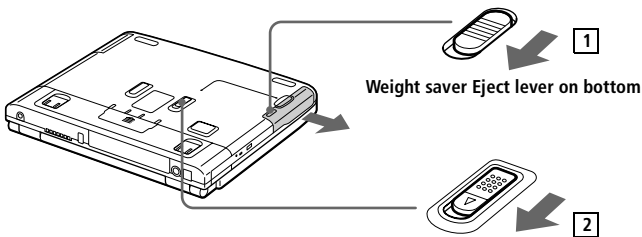

- 2 Remove the weight saver, and then pull out the battery pack.
- 3 Reinsert the weight saver. See “Using the Weight Saver” on page 49.

Using the Weight Saver

The weight saver protects the multi-purpose bay when it is empty.

To attach the Weight Saver

- 1 If another device is in the multi-purpose bay, remove the device. See “To remove the floppy disk drive” on page 34 or “To remove the second battery pack” on page 48.
- 2 Pull out the guide of the weight saver and slide the weight saver in the direction of the arrow until it clicks, then slide the Eject lever on the bottom of the Weight Saver toward the front of the computer to lock it.

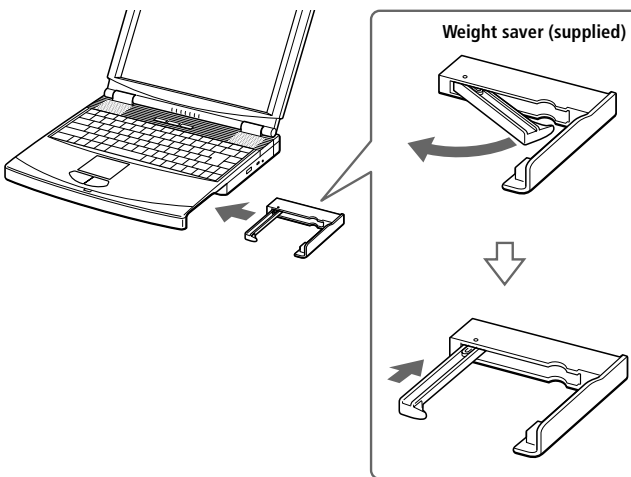

To remove the Weight Saver

To remove the weight saver, slide the Eject lever of the weight saver in the direction of the arrow 1, then slide the RELEASE lever on the bottom of the computer in the direction of the arrow 2.

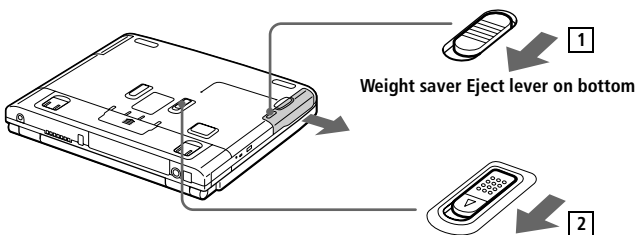

Connecting peripheral devices

You can add functionality to your computer by connecting or using any of these peripherals and enjoy the software described in the “About the Software” user guide:

- ❑ PC card modem (page 52)
- ❑ Port replicator (page 56)
- ❑ Printer (page 59)
- ❑ External display (page 60)
- ❑ Digital still camera or other serial device (page 63)
- ❑ Digital Mavica (page 64)
- ❑ Mini-disc recorder with MD Player (page 67)
- ❑ Digital video camera recorder (page 66)
- ❑ External mouse or keyboard (page 69)
- ❑ External speakers (page 70)
- ❑ External microphone (page 71)
- ❑ Universal Serial Bus (USB) device (page 72)



Before you connect peripherals, turn off the computer and all peripherals.

Connect the power cord only after connecting all cables.

Turn on the computer only after turning on all peripherals.

PC card modem

Use your PC card modem to connect to a network, a GSM or a phone line and access the WWW.

Connecting to a phone line

You need to connect a phone line to take advantage of online services, the Internet and to register your computer and software online.

- 1 Use any of both PC cards slots of your notebook computer. Pull the PC card release button away from the computer. Remove the PC card slot protector as described in "Using PC Cards" on page 37.
- 2 Insert the PC card modem in the slot of the computer (label facing up), push it gently until the release button ejects completely. Put back the release button.

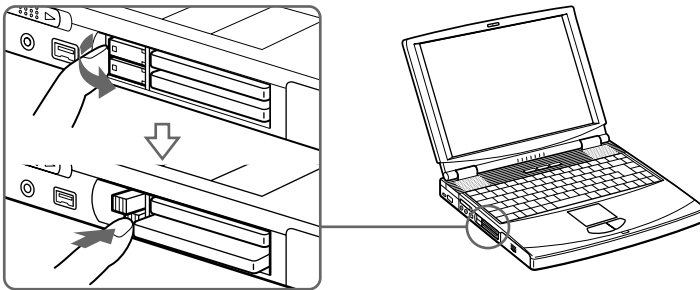

 When you insert the supplied PC card modem, the system automatically loads the LAN Ethernet driver, making the mouse inactive for 30 seconds (though the pointer still moves).

- 3 Plug the phone line jack into the left connector of the PC card.
- 4 Plug the other end into the wall jack (use a phone plug if needed).

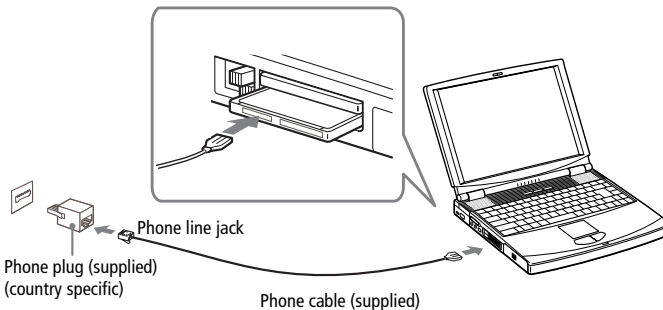



Phone cable and connectors are TNV (Telecommunication Network Voltage), according to EN60950.

Use the supplied communication tool which provides a full range of features: fax, data, telephone directory. See "About the Software" guide for details.

In order to register your Sony Notebook Computer, register your software online, and use VAIO-Link, you must connect to a phone line.

Other connections

This PC card modem can be connected to GSM, ISDN and LAN (Ethernet) networks.

Connecting to a GSM

Your PC card modem is ready for connection to the Sony CMD-Z1 GSM phone (cable not supplied). Plug the cable in the right connector of the PC card. Plug the other end into the GSM phone.

| <i>Models of GSM</i> | <i>Card programming</i> |
|------------------------------|---|
| Sony CMD-Z1 and Z1 Plus | Ready |
| Sony CM-DX1000 and CMD-X2000 | Ready to be re-programmed (program supplied on your Hard Disk and Recovery CD-ROM). |
| Other GSM phones | See your retailer. |

Connecting to an ISDN line

Your PC card modem is ready for connection to ISDN (Integrated Services Digital Network, offering transmission of voice, data, fax). See your retailer for information and accessories (adapter not supplied).

Connecting to a LAN (Ethernet)

Your PC Card modem is ready for LAN connection (LAN adapter not supplied). See your retailer for information and accessories.

Activating the functionality of your modem PC Card

Your PC Card modem is ready for LAN connection (LAN adapter not supplied), but the default LAN functionality of the COMOne Platinum Card is disabled.

To use the LAN functionality, please follow the procedure described below:

- 1 Press simultaneously the 3 keys: Windows  + Fn + Pause, to open the System Properties.
Click on the Device Manager tab and the following screen will appear:

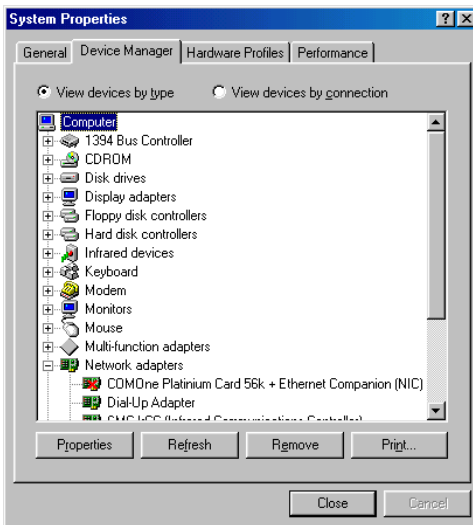

- 2 In the Device manager, under the heading Network adapters, double click on the COMOne Platinum Card 56k + Ethernet Companion (NIC), marked by a red-cross.

3 The following screen will appear:

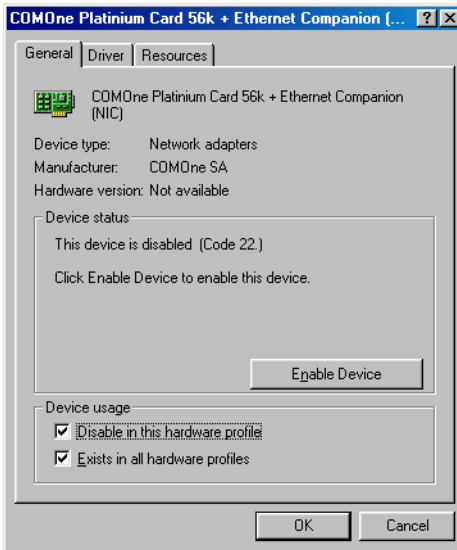

- 4 Under the General tab, in the Device status section, click on 'Enable Device' (the mouse will be inactive during 20 to 30 seconds).
- 5 In the 'Device Manager' tab, under Network adapters, the red cross next to the COMOne Platinum Card 56k + Ethernet Companion (NIC) will disappear.
- 6 Click on OK, click on Close.
- 7 After setting your network configuration, you will be able to use the LAN functionality.

Port Replicator

Your notebook computer supports the use of an optional port replicator. Attaching a port replicator enables you to connect additional peripherals to your computer.

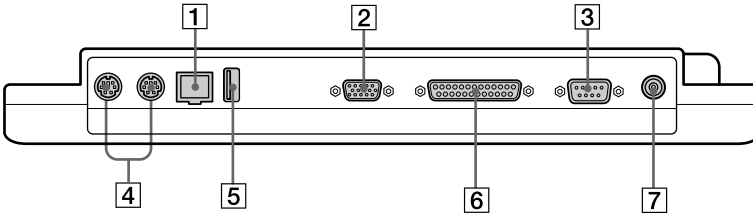

1  Network (ethernet)

5  USB (page 72)

2  Monitor (page 60)

6  Printer (page 59)

3  Serial (page 63)

7  DC In (page 17)

4  Mouse/Keyboard (page 69)

 The port replicator can be powered only with an AC adapter supplied with your notebook or the optional PCGA-AC71 AC adapter. Do not remove the AC adapter from the port replicator or the AC outlet while using the port replicator; this may cause data damage or hardware malfunctions.

All connectors are SELV (Safety Extra Low Voltage) according to EN60950.

To attach your computer to the port replicator

- Use the AC adapter supplied with your computer or the optional Sony PCGA-AC71 adapter. To disconnect your port replicator completely from mains voltage unplug the AC adapter. When attaching your computer to the port replicator, do not attempt to insert or remove the battery pack. Lifting and turning the computer with attached port replicator may cause a temporary loss of power. Please make sure that the socket outlet is easily accessible.

To supply power to your computer while it is connected to the port replicator, you must connect the AC adapter directly to the port replicator.

- 1 Turn off your computer and disconnect all peripherals.
- 2 On the bottom of the computer, lift the port replicator port cover.

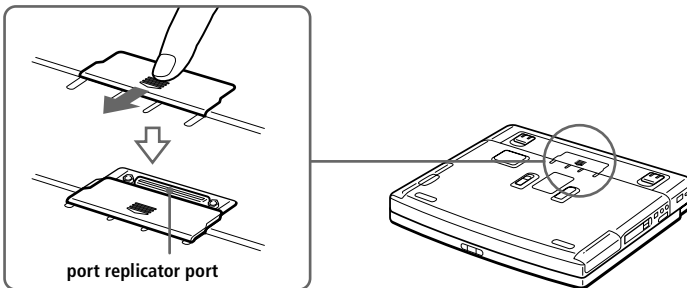

- 3 Attach the bottom of the computer to the port replicator connector until it clicks.

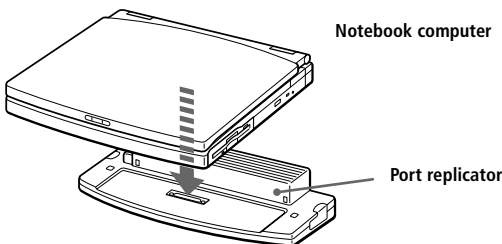

- 4 Plug the cable attached to the AC adapter into the DC IN connector on the port replicator. Plug the power cord into the AC adapter and an AC outlet.

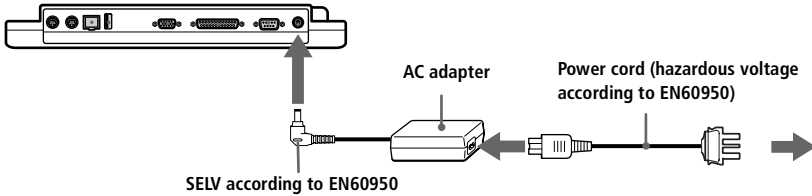

- 5 The power indicator light turns green.

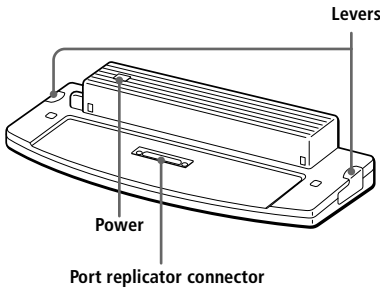

- 6 Turn on the computer.

 When you use the port replicator for the first time, the installation of the network driver starts automatically. When the installation is complete, a message: "Do you want to restart your computer?" will appear. Chose Yes.

The floppy disc supplied with your Port Replicator is useless.

Printer

You can connect a Windows-compatible printer to your computer to print documents.

To connect a printer

- ❑ Use the  symbol to locate the Printer connector. Plug the printer cable (supplied with the printer) into this port on the computer.

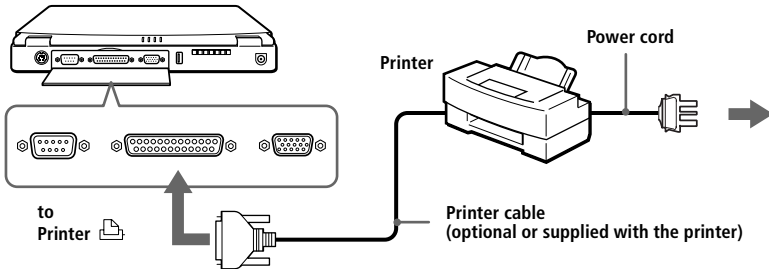

To connect a printer using the USB connector

You can connect a Windows[®] 98-compatible USB printer to your computer.

- ❑ Use the  symbol to locate the USB port of your computer and printer.
- ❑ Plug an optional USB printer cable into the USB connector.

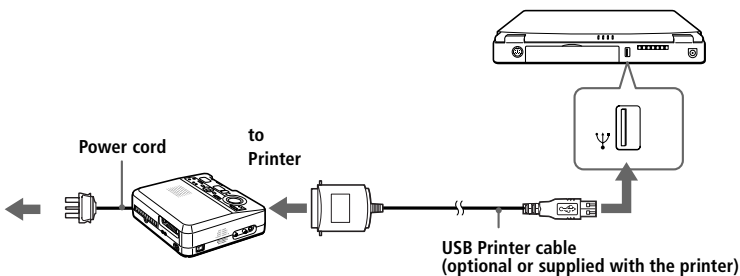

 See the manual supplied with your printer for more information on installation and use.

Before using the printer, you may need to change the Printer setting in the Sony Notebook Setup software. See your Software guide, in "Sony Notebook Setup".

External Display

You can connect an external display to your notebook computer. For example, you can use the computer with any of the following:

- ❑ Computer display (monitor)
- ❑ Multimedia computer display
- ❑ Projector

Use your external display as second screen, or get a virtual desktop (See your Software guide, in “Using the Dual Display Function”).

To connect a computer display

- ❑ Use the  symbol on the back of the computer to locate the Monitor connector. Plug the display cable into this connector on the back of the computer.
- ❑ If necessary, plug one end of the display power cord into the display, and the other end into an AC outlet.

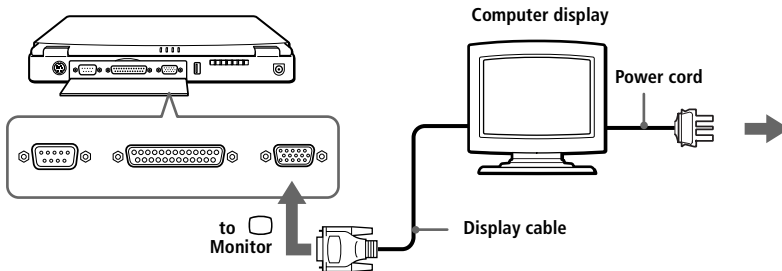

See the manual supplied with your computer display for more information on installation and use.

To connect a multimedia computer display

You can connect the notebook computer to a multimedia computer display that includes built-in speakers and a microphone.

- 1 Use the □ symbol to locate the Monitor connector. Plug the display cable into this connector.
- 2 Use the 🎧 symbol to locate the Headphone connector. Plug the speaker cable into this connector.
- 3 Use the 🎤 symbol to locate the Microphone connector. Plug the microphone cable into this connector.

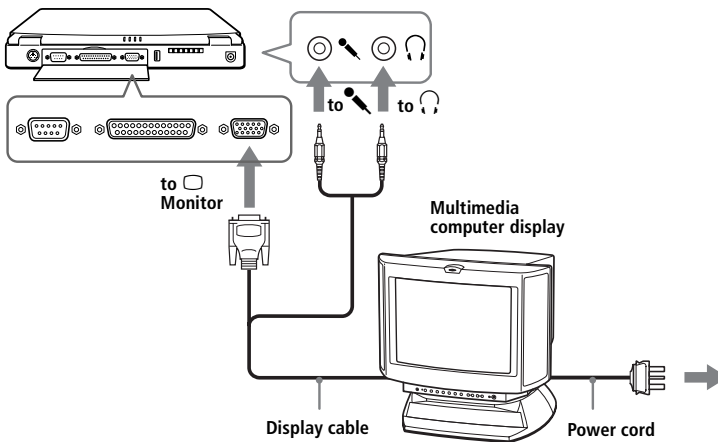

📖 See the manual supplied with your multimedia computer display for more information on installation and use.

To connect a projector

You can use a projector as an external display, such as the Sony LCD Projector.

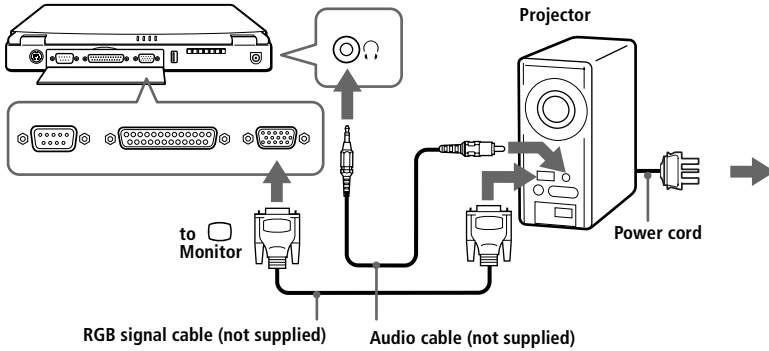

See the manual supplied with your projector for more information on installation and use. You may not be able to display the computer's LCD and the external display, depending on the types of computer display and projector.

To select a display

When you connect an external display to the monitor connector, you can toggle the output among the Liquid Crystal Display (LCD), the external monitor, or both devices.

Use the Fn+F7 keys to select a display. See your Software guide, in "Selecting the Display Mode" for more information.

| To | Press | Result |
|-------------------------------|-------|--|
| Switch to an external display | Fn+F7 | Toggles among the LCD, the external display connected to the Monitor connector, and both the LCD and external display. |

Only LCD → LCD and external display →
← Only external display ←

Digital Still Camera or Other Serial Device

You can connect other computer peripherals, such as a digital still camera, to the Serial connector on your computer.

To connect a digital still camera

- Use the  symbol to locate the Serial connector. Plug the connecting cable into this port on the computer and into the Digital I/O connector on the digital still camera.

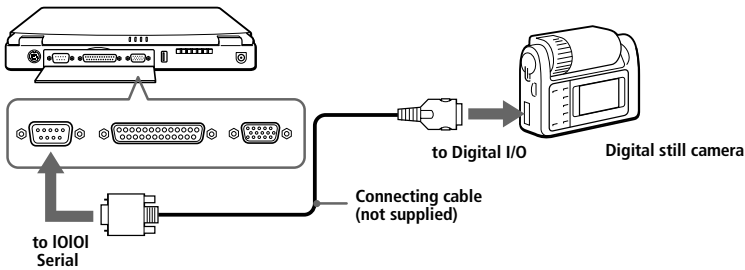

 See the manual supplied with your digital camera or other serial device for more information on installation and use.

If you use a digital camera that has an infrared data communication system or other infrared communication device, see "Using Infrared Communication Devices" on page 43.

To use diskettes with the Digital Mavica

The Digital Mavica provides you still images you can copy and edit on your computer, using PictureGear software.

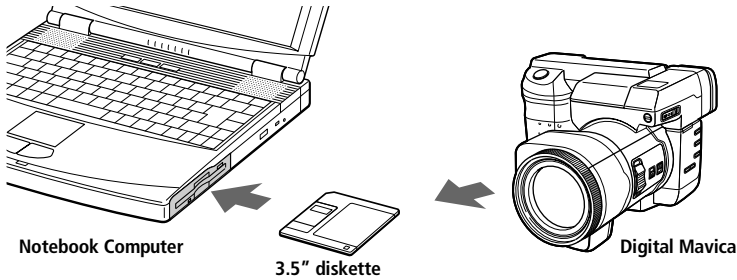

Follow these steps to transfer the images from your Digital Mavica:

- 1 Insert the diskette of the Mavica in the FDD drive of your computer and copy them in a dedicated folder.
- 2 Launch the application and open the image to edit or drag and drop it on the application shortcut. Make the changes you want to the image.
- 3 Save it under the new name and format if needed.

To use Memory Sticks

You can enhance the memory of your digital camera or other digital device with Memory Sticks of 4, 8 or 16 MB capacity. To transfer your data to your computer, insert the Memory Stick, into the PC Card slot:

- 1 Once you have stored your data from your digital device, insert the Memory Stick into the PC Card adapter.
- 2 Insert the PC Card in the slot of your computer (label facing up), push it gently until the release button ejects completely and put back the release button.
- 3 The Memory Stick is automatically detected by your system and will appear in your "My Computer" window as a local drive, under the appropriate letter (depending on the configuration of your computer).

Please refer to your Memory Stick user guide for precautions and specifications.

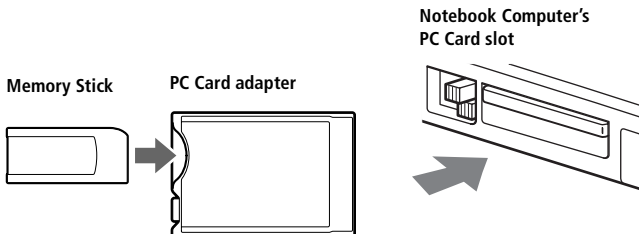

Digital Video Camera Recorder

You can connect a digital video camera recorder to the S200 i.LINK™ (IEEE-1394) connector and use the editing features of DVgate Motion software (supplied depending on the model).

To connect a digital video camera recorder

- 1 Plug one end of the i.LINK™ cable into the i.LINK™ connector on the left side of the computer and the other end into the DV Out connector on the digital video camera recorder.

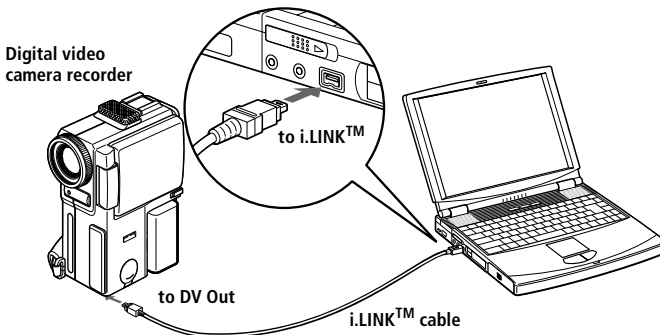

- 2 Launch DVgate Motion application. See your Software guide, in "DVgate Motion".



The Sony digital video camera recorder (DCR-PC1) is pictured; your digital video camera recorder may need to be connected differently.

See the manual supplied with your digital video camera recorder for more information on installation and use.

Do not connect more than one digital video camera at a time. The software supplied with your computer will not recognize multiple cameras.

On Sony digital video cameras, connectors labeled "DV Out", "DV In/Out" or "i.LINK™" are i.LINK™-compatible.

The i.LINK™ connector of your notebook computer does not supply power to external devices generally powered by i.LINK™ connectors.

The i.LINK™ connector supports transfer rates up to 200 Mbps; however, the actual transfer rate depends on the transfer rate of the external device.

The i.LINK™ features available may vary depending on the software applications you use. See the documentation that came with your software for more information.

MiniDisc® deck with MD Player

Use the inter-connectivity and common protocols between Sony audio equipment and your VAIO computer to enjoy the high quality of sound and recordings through optical data transfer.

When you connect a Sony MD deck equipped with a CONTROL A1 or CONTROL A1II terminal to a Sony CD player (equipped with both digital optical output and CONTROL A1 connector), you can record and edit your MiniDiscs® via your computer. See your Software guide, in “MD Player” for a description of the software.



Refer to your MD deck and CD player manuals to check the specifications.

For further information or if you are not sure of the connection capabilities of your devices, please contact your dealer.

To perform a copy using your computer, you need two CONTROL A1 or CONTROL A1II and one optical cables, which are maybe sold separately. To purchase them, please contact your dealer.

MD Player features

To enjoy the MD Player of Media Bar features, you need to connect your computer to the Control A1 connection of your MiniDisc® recorder.

Link your MD deck and CD player with the optical cable and the CONTROL A1 or CONTROL A1II cable to enjoy:

- ❑ Complete editing and assembly functions: change the order of the numbers on your MD;
- ❑ Use the touchpad or mouse to play and edit MDs, and the keyboard to enter disc and track titles to display on your MD deck while playing;
- ❑ Digital output and input without any noise or loss of data;
- ❑ Drag-and-drop, copy and paste and other functions: your computer is the visual interface of the MiniDisc® recorder.

To connect the MD recorder to your computer

- 1 Plug the CONTROL A1 or CONTROL A1II connecting jack to the MD deck using the CONTROL A1 or CONTROL A1II connector and the other end to the Serial connector of your computer.

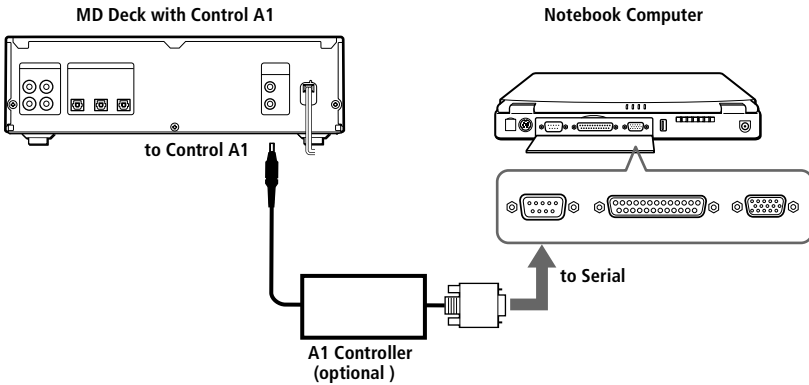

- 2 Plug the optical cable to the Digital Optical output / input of your MD desk.
- 3 Turn on all the devices.
- 4 Launch MD Player to edit the tracks on your MiniDisc[®].



 The Control A1 feature works only with Sony devices. For further information, please refer to your Sony Dealer.

External Mouse or Keyboard

You can connect an external mouse or keyboard to your computer. To connect both a mouse and a keyboard, use the port replicator (see “Port Replicator” on page 56).

The Mouse/Keyboard connector requires a PS/2®-style plug or adapter.

To connect an external mouse or keyboard

- Use the  symbol to locate the Mouse/Keyboard connector. Plug the keyboard cable or mouse cable into this connector with the  mark facing up.

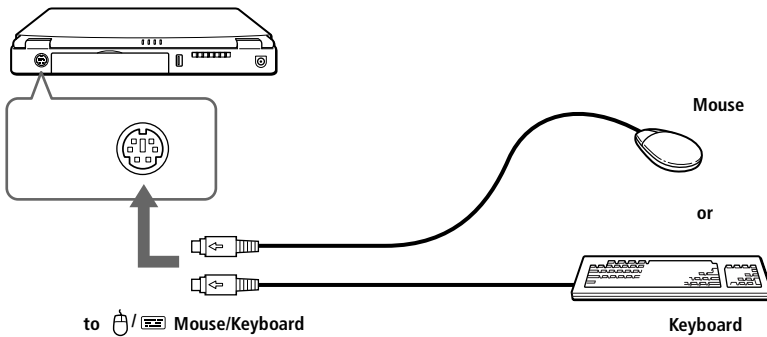

 See “Using the Keyboard” on page 26 for more information on using the keyboard.

See the manual supplied with your mouse or keyboard for more information on installation and use.

Before you connect or disconnect the mouse or keyboard, turn off the computer.

Before connecting a mouse to the Serial port, make sure the mouse is compatible with a serial port.

External Speakers

You can enhance the sound quality of your computer by connecting external speakers.

To connect external speakers

- Use the  symbol to locate the Headphone connector. Plug the speaker cable into this connector.

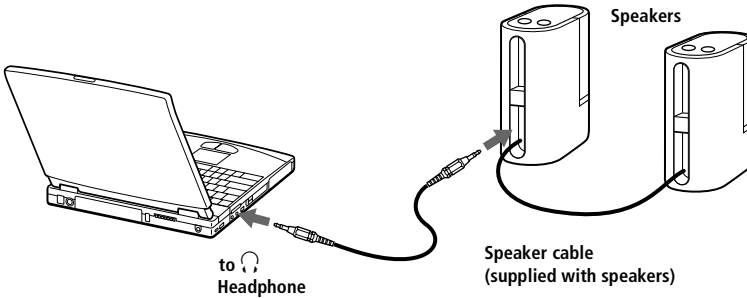

 Make sure your speakers are designed for computer use.

Turn down the volume of the speakers before you turn them on.

Do not place diskettes on the speakers; the speaker's magnetic field may damage the data on the diskettes.

See the manual supplied with your speakers for more information on installation and use.

External Microphone

You can enhance the quality of sound input by using an external microphone.

 Make sure your microphone is designed for computer use.

To connect an external microphone

- Use the  to locate the Microphone connector. Plug the microphone cable into this connector.

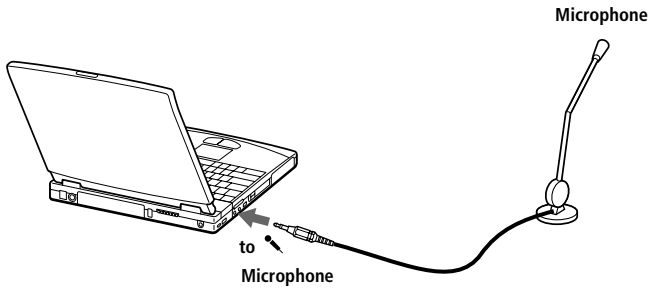

 See the manual supplied with your microphone for more information on installation and use.

Universal Serial Bus (USB) Device

You can connect a USB device to your computer.

To connect a USB device

- Use the  symbol to locate the USB connector. Plug one end of the USB cable into this port and the other end into the USB device.

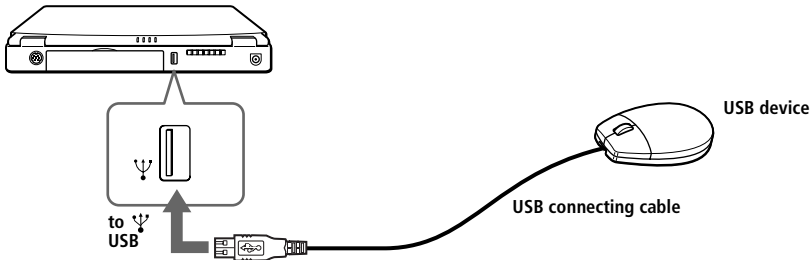

-  USB ports are included to provide state-of-the-art technology. You may need to install software (device drivers) supplied with your USB device before using the USB device. Read carefully the manual supplied with your USB device for more information on installation and use.

Getting Help

This section describes how to get help and support from Sony, as well as troubleshooting tips for your computer.

About Sony's Support Options

Sony provides several support options for your computer. When you have questions about your computer and the pre-installed software, check these places for answers:

- ❑ **This guide** explains how to use your computer, connect peripheral devices, use the utility programs, and perform basic computer tasks.
- ❑ The **online help files** that accompany your pre-installed software contain instructions on using the software.
- ❑ The **About the Software guide** lists the pre-installed software titles. This guide also includes a packing list and technical specifications for your notebook computer. It is included with your computer as an electronic document.
- ❑ The **Customer Service Guide** gives you complete information on communicating with VAIO-Link Response Centre.
- ❑ **VAIO-Link:** if you have any problem with your computer, you can contact VAIO-Link by telephone, fax or e-mail (see your Customer Service Guide for addresses and phone numbers). Before calling VAIO-Link, try to solve the problem by reading your User Guide (troubleshooting chapter) or the manuals and helpfiles of the peripherals or software.
- ❑ **The Sony e-mail support service** answers your questions by electronic mail. Just send your question in an e-mail message, and a Customer Service Analyst will send you a reply with the answer. To send a question to Sony e-mail support, please refer to the instructions in your Customer Service Guide.



You need to plug the PC Card Modem and the phone line to use the communication features described in this manual.

Troubleshooting

This section describes how to solve common problems you may encounter when using your computer. Many problems have simple solutions, so try these suggestions before you contact VAIO-Link.

Table of troubleshooting

- About the computer and software, see page 75
- About the display, see page 77
- About CD-ROMs and diskettes, see page 78
- About sound, see page 79
- About modem, see page 80
- About peripherals, see page 81
- Using the Product Recovery CD-ROMs, see page 82



When you reconnect devices, be sure to turn off the computer as described in page 23. If you turn off the computer in other ways, it may result in data loss.

About the computer and software

My computer does not start

- ❑ Check that the computer is plugged into a power source and that it is turned on. Check that the power indicator on the front panel of the computer indicates that the power is on.
- ❑ Check that the battery packs are inserted properly and that they are charged.
- ❑ Make sure there is no diskette in the floppy disk drive.
- ❑ Confirm that the power cord and all cables are connected firmly, as described in “Connecting peripheral devices” on page 51.
- ❑ If you plugged the computer into a UPS, make sure the UPS is turned on and working.
- ❑ If you are using an external display, check that it is plugged into a power source and turned on. Check that the brightness and contrast controls are adjusted correctly. See the manual that came with your display for details.
- ❑ Moisture condensation may have occurred. Do not use the computer for at least one hour and then turn on the computer.
- ❑ The internal backup battery of your computer is low on power. To change the backup battery located on the bottom please contact VAIO-Link.

When I turn on my computer, the message “Operating system not found” appears and Windows does not start

- ❑ Check the floppy disk drive to see if a non-bootable diskette is in the drive.
- ❑ If a non-bootable diskette is in the drive, eject it and press any key on your keyboard. Windows then start normally.
If Windows still does not start, follow the procedure below to initialize the BIOS.
- ❑ If the floppy disk drive is empty, follow the steps below to initialize the BIOS:
 - 1 Remove any peripheral devices connected to the computer.
 - 2 Turn the computer off and then turn it on again.
 - 3 Turn on the computer and press the F2 key when the Sony logo appears. The BIOS setup menu screen appears.
 - 4 Press the arrow keys to select the Exit menu.
 - 5 Press the arrow keys to select Get Default Values and then press the Enter key. The message “Load default configuration now?” appears.

- 6 Check that [Yes] is selected, then press the Enter key.
- 7 Press the arrow keys to select Exit (Save Changes) and then press Enter.

The message "Save configuration changes and exit now?" appears.

- 8 Check that [Yes] is selected, then press the Enter key. The computer restarts.
- 9 If your computer still displays the message "Operating system not found" and Windows does not start, contact VAIO-Link.

My computer does not shut down

It is best to shut down your computer using the Shut Down command on the Windows® 98 Start menu. Using other methods, including those listed here, may result in loss of unsaved data. If the Shut Down command does not work properly, follow these steps:

- ❑ Restart the computer by pressing Ctrl + Alt + Delete twice.
- ❑ If this does not work, slide the power switch forward and hold it for at least four seconds, this turns off the power.
- ❑ Unplug the computer from the AC adapter and remove the battery pack from your computer.

My computer "locks up"

- ❑ Try restarting the computer. On the Windows taskbar, click the Start button, click Shut Down, and then click Restart.
- ❑ If you cannot restart as described in the preceding step, you can restart the computer by pressing Ctrl+Alt+Delete twice (or by pressing Ctrl+Alt+Delete once, then clicking Shut Down in the Task manager of Windows).
- ❑ If the previous step does not work, slide the power switch toward the front and hold it for at least four seconds. This turns off the power.
- ❑ If your computer locks up while playing a DVD-ROM/ CD-ROM, stop the DVD-ROM/ CD-ROM, and restart the computer by pressing Ctrl+Alt+Delete twice.



Pressing Ctrl+Alt+Delete may result in data loss in files that are currently open.

My software program "locks up" or crashes

Contact the software publisher or designated provider for technical support. See your Software guide on how to contact them.

My mouse doesn't work

- ❑ If you are using an external mouse, check that the mouse is plugged into the mouse connector. See “External Mouse or Keyboard” on page 69 for details.
- ❑ If you connected an external mouse while your computer is on, you must restart your computer.
- ❑ If you are using an optional Sony USB mouse PCGA-UMS1, check that the mouse is plugged into the USB connector. See the chapter about “Universal Serial Bus (USB) Device” on page 72 for details.

My touchpad interprets a single tap as a double-click

Open the Mouse icon in the Control Panel and change the button assignments in the Mouse Properties dialog box. One of the buttons is assigned to the double-click action.

My computer's fan makes too much noise.

Use the Power Panel utility to make the fan silent. See the Power Panel help for more information.

About the display

My LCD does not display anything

- ❑ Check that the computer is plugged into a power source and that it is turned on. Check that the power indicator on the front panel of the computer is on.
- ❑ Check that the battery packs are inserted properly and that they are charged.
- ❑ Adjust the brightness of the LCD (See page 30.).
- ❑ The computer may be in LCD (video) standby mode. Press any key to activate the display.

The screen image on my external display is not centered or sized properly

Use the controls on your external display to adjust the image. See the manual supplied with your display for more information.

The video image on my screen is too dark

If an external display is connected to the Monitor connector, disconnect the display.

About CD-ROMs and diskettes

My DVD-ROM / CD-ROM drive tray does not open

- ❑ Make sure the computer is turned on.
- ❑ Press the Eject button on the DVD-ROM / CD-ROM drive.
- ❑ If the Eject button does not work, you can open the tray by inserting a sharp, pointed object into the hole to the right of the Eject button.

I can't play a CD-ROM disc

- ❑ Make sure the label of the CD-ROM is facing up.
- ❑ If the CD-ROM disc requires software, make sure the software is installed according to the program's instructions.
- ❑ Check the volume of your speakers.
- ❑ Clean the CD-ROM disc.
- ❑ Moisture condensation may have occurred. Leave the computer for at least 1 hour while the computer is turned on.

I can't play a DVD-ROM disc

- ❑ If a region code warning appears when you are using the DVD player, it could be that the DVD-ROM disc you are trying to play is incompatible with the DVD-ROM drive in your notebook computer. The region code is listed on the disc's packaging.
- ❑ If you hear audio but cannot see video, your computer's video resolution may be set too high. For best results, change the resolution in Windows Control Panel/Display/Settings to 800 x 600 using 8-bit color.
- ❑ If you see video but cannot hear audio, check all of the following:
 - 1 Make sure the mute setting is off in your DVD player.
 - 2 Check the master volume setting in the audio Mixer. If you have connected speakers externally, check the volume settings in your computer speakers and check the connections between your speakers and the computer.
 - 3 Check the Windows Control Panel/System/Device Manager to see that the drivers are installed properly.
- ❑ A dirty or damaged disc may cause the computer to "hang" while it tries to read the disc. If necessary, reboot the computer, remove the disc, and then check that it is not dirty or damaged. For cleaning instructions, see "On Handling CD-ROM and DVD-ROM Discs" on page 87.

When I double-click an application icon a message appears, such as “You must insert the application CD into your CD-ROM drive”, and the software does not start

- ❑ Some titles require specific files that are located on the application’s DVD / CD-ROM disc. Insert the disc and try starting the program again.
- ❑ Make sure you place the disc in the tray with the label side facing up.

My floppy disk drive can’t write to a diskette

- ❑ The diskette is write-protected. Disable the write-protect feature or use a diskette that is not write-protected.
- ❑ Check that the diskette is properly inserted into floppy disk drive.

About sound

My speakers have no sound

- ❑ The built-in speakers are turned off. Press Fn+F3 to turn on the speakers.
- ❑ The speaker volume is turned to the minimum. Press Fn+F4, and then press **▲** or **▶** to increase the volume.
- ❑ If your computer is powered by batteries, check that the battery packs are inserted properly and that they are charged.
- ❑ If you are using an application that has its own volume control, check that the volume is turned up.
- ❑ Check the volume controls in Windows® 98.
- ❑ If you connect external speakers, check that the speakers are properly connected and the volume is turned up. If the speakers have a mute button, make sure it is off. If the speakers are powered by batteries, check that the batteries are inserted properly and that they are charged.
- ❑ If you have connected an audio cable to the Headphone connector, disconnect the cable.

My microphone doesn’t work

If you are using an external microphone, check that the microphone is plugged into the Microphone connector. See “External Microphone” on page 71 for details.

About modem

My modem (PC card) doesn't work

- ❑ Check that your PC card is properly inserted in your computer (label side facing up).
- ❑ Check your PC card modem has been detected by the system. See “PC card modem” on page 52.
- ❑ Check that the phone line is plugged into your PC card. See “PC card modem” on page 52 for details.
- ❑ Check that the phone line is working. You can check the line by plugging in an ordinary phone and listening for a dial tone.
- ❑ Check that the phone number the program is dialing is correct.
- ❑ If you connect a GSM phone, make sure that the programming of the supplied PC card is compatible with it: use the supplied card loader to re-program it (refer to your card's user manual).
- ❑ Check that the software you are using is compatible with the provided PC card (refer to your software user manual).
- ❑ Make sure that the driver selected in your communication software is matching the programming of your PC card (refer to your communication software user manual).

My modem connection is slow

Many factors influence modem connection speed, including telephone line noise or compatibility with telephone equipment (such as fax machines or other modems). If you think your modem is not connecting properly to other PC-based modems, fax machines, or your Internet Service Provider, check the following:

- ❑ Have your phone company check that your phone line is free from any line noise.
- ❑ If your problem is fax-related, check that there are no problems with the fax machine you are calling and that it is compatible with fax modems.
- ❑ If you are having a problem connecting with your Internet Service Provider, check that the ISP is not experiencing technical problems.
- ❑ If you have a second phone line available, try connecting the modem to that line.

My PC card is detected as a 'Standard PCMCIA card'

If your PC card is detected as a "Standard PCMCIA card":

- 1 Uninstall the Platinum Card Loader program
- 2 Remove the PC Card from the PC Card slot
- 3 Re-install the Platinum Card Loader program from the recovery CD-ROM by checking 'GSM Upgrade Kit' and 'LAN Upgrade Kit' in addition to the already checked options.
- 4 Re-insert the PC card : it will be re-detected as a 'COMOne Platinum Card 56K Caller ID'

About peripherals

I cannot use DV devices. The message "DV equipment seems to be disconnected or turned off" appears.

- ❑ Check that the DV device is turned on and that the cables are properly connected.
- ❑ If you are using multiple i.LINK™ devices, the combination of the connected devices may cause unstable operation. In this case, turn off the power to all connected devices and disconnect unused devices. Check the connection, then turn on the power again.

My PC card is not working

- ❑ Make sure the PC card is compatible with Windows® 98.
- ❑ Use the Sony Notebook Setup utility to disable devices you are not currently using.

I cannot print.

- ❑ Check that all the cables of the printer are correctly connected.
- ❑ Check that your printer is correctly configured and that you have up to date drivers (See "Printer" on page 59. If needed, contact your dealer).
- ❑ The default setting for the printer port mode is correct for most printers. If you cannot print, try changing the printer port mode. In Sony Notebook Setup, select the Printer tab. If the printer port mode is set to ECP, change it to bi-directional. If the printer port mode is set to bi-directional, change it to ECP. See your Software guide, in "Sony Notebook Setup" for details on using configuration.

Using the Product Recovery CD-ROMs

The following sections describe how to use the Recovery CD-ROMs.

You will find a set of two Recovery CD-ROMs in your Product Recovery Pack :

- ❑ The System Recovery CD-ROM (vol. 1 of 2) allows you to perform a full system recovery;
- ❑ The Application Recovery CD-ROM (vol. 2 of 2) helps you to recover your pre-installed software and to manually reinstall the device drivers.

 Supplied (depending on the model): 1 CD-ROM with both application and system recovery data or 2 CD-ROMS (one application and one system recovery CD).

In case of a serious system crash, you may need to recover the whole contents of your hard drive. A system recovery is required.

Also, if you encounter a problem with your computer, probably caused by a badly configured system, reinstalling an individual device driver may solve the problem.

Another problem could be that a pre-installed application doesn't work properly any more. Reinstalling the appropriate application should fix the problem. Consequently, you should perform an application recovery.

Performing a system recovery.

Use this option only when your system is seriously damaged. For example: Windows[®] 98 does not work any more, or your PC behaves abnormally... The system recovery will completely reinstall the originally configured system on your PC.

! Applying a system recovery means that you will lose all your data stored on the hard drive. Therefore, before applying a system recovery, save your data stored on the hard disk to an external disk. If this is not possible under Windows[®] 98, try to save your data from the DOS-prompt to an external disk (floppy, zip or additional Hard Disk...).

! CAUTION: make sure that your computer is connected to AC (not the batteries) before you attempt a system recovery.

! CAUTION: when the recovery is performed, you must remove the recovery CD-ROM from the drive before restarting the computer. If the CD-ROM is still in the drive, you will restart a recovery process.



You can only use these Recovery CD-ROMs on the Sony notebook you purchased and not on any other Sony PC or other manufacturer's PC!

To perform a system recovery, the notebook should not be docked (port replicator).

You need to complete the Windows® 98 registration process when you use the system recovery. Make sure you have the product ID number located on the cover of your "Introducing Microsoft Windows® 98" guide. You will need this number to complete the recovery process.

For more information about using your DVD-ROM / CD-ROM drive, read "Using the DVD-ROM / CD-ROM Drive" on page 35.

Procedure for a system recovery

- 1 Take the System Recovery CD-ROM (vol. 1 of 2)
- 2 Turn on your computer (using AC power only) and insert the System Recovery CD-ROM vol.1 in the DVD-ROM/CD-ROM drive.
- 3 Shut down your computer (slide the power switch forward and hold it for more than four seconds).
- 4 Wait ten seconds and turn your computer back on.
- 5 Click "OK" to confirm that you have read and accepted the Microsoft End-User License Agreement.
- 6 The system recovery screen appears next. If you're really sure that you do not mind losing all your data, click "YES".
- 7 You will get a final warning. If you select "GO", all data will be removed permanently and the recovery process will start.



The recovery process takes between 10 to 20 minutes to complete.

If your computer does not start the system recovery utility.

Refer to your *Customer Service Guide* to contact VAIO-Link by phone or by fax.

Performing an Application Recovery.

The application recovery utility allows you to reinstall individual applications.

Reinstalling a program can fix the problems encountered if it does not run correctly any more.

Procedure for an application recovery

- 1 Take the Application Recovery CD-ROM (vol. 2 of 2).
- 2 Turn on your computer (using AC power only) and wait until Windows[®] 98 has booted up.
- 3 Insert the Application Recovery CD-ROM in the DVD-ROM / CD-ROM drive. The Install Manager will load automatically.
- 4 When the Install Manager menu appears, follow the on-screen instructions to select the application you want to recover.
- 5 Follow the installation instructions of the Install Manager.



You must run the Application Recovery CD (vol. 2 of 2) from Windows[®] 98. The application will not run from DOS.

When performing an application recovery, you do not lose data on your hard disk.

Reinstalling a device driver

Some applications or peripherals require specific drivers which you won't find in the Windows[®] 98 drivers folder. To help you finding or restoring typical drivers needed by your pre-installed applications, you can use the Application Recovery CD-ROM.

- 1 First check whether the driver you plan to reinstall is on the Application Recovery CD-ROM. Only device drivers that are not delivered with Windows[®] 98 can be found in the drivers directory (in G:\Drivers).
- 2 Check all underlying sub-directories for the appropriate driver.
- 3 Next, launch the "Add New Hardware" wizard (in the Windows[®] start menu, select "Settings", then "Control Panel") to install the appropriate device, by browsing the appropriate folders.

Notes on Use

This section describes safety guidelines and precautions to help protect your computer from potential damage.

On Upgrading the System

Due to the use of high precision components and the technology of the electronic connectors of your Notebook computer and memory modules, to avoid the invalidation of your Guarantee by mishandling, Sony Corporation recommends that:

- you contact your dealer to install a new memory module,
- you do not install it yourself,
- you do not open the unit or touch the connectors .

Please call VAIO-Link if you need assistance.

On Handling the LCD Screen

- Do not leave the LCD facing the sun as it can damage the LCD. Be careful when using the computer near a window.
- Do not scratch the LCD or exert pressure on it. This could cause malfunction.
- Using the computer in low temperature conditions may produce a residual image on the screen. This is not a malfunction. When the computer returns to normal temperature, the screen returns to normal.
- A residual image may appear on the screen if the same image is displayed for a lengthy period of time. The residual image disappears in a while. You can use a screen saver to prevent residual images.
- The screen becomes warm during operation. This is normal and does not indicate a malfunction.
- The LCD is manufactured using high-precision technology. You may, however, see tiny black points and/or bright points (red, blue, or green) that continuously appear on the LCD. This is a normal result of the manufacturing process and does not indicate a malfunction.

On the Power Source

- ❑ Your computer operates on 100V-240V AC 50/60 Hz.
- ❑ Do not share the AC outlet with other power-consuming equipment, such as a copying machine or shredder.
- ❑ You can purchase a power strip with a surge protector. This device prevents damage to your computer caused by sudden power surges such as those that may occur during an electrical storm.
- ❑ Do not place heavy objects on the power cord.
- ❑ To disconnect the cord, pull it out by the plug. Never pull the cord itself.
- ❑ Unplug your computer from the wall outlet if you will not be using the computer for a long time.
- ❑ When the AC adapter is not used, unplug it from the AC outlet.
- ❑ Use only the AC adapter supplied. Do not use any other AC adapter.

On Handling

- ❑ Clean the cabinet with a soft, dry cloth or a soft cloth lightly moistened with a mild detergent solution. Do not use any type of abrasive pad, scouring powder, or solvent such as alcohol or benzine, as these may damage the finish of your computer.
- ❑ Should any solid object or liquid fall into the computer, shut down your computer and then unplug it. You may want to have the computer checked by qualified personnel before operating it any further.
- ❑ Do not drop the computer or place heavy objects on top of the computer.

On Installation

- ❑ Do not place your computer in a location subject to:
 - ❑ Heat sources, such as radiators or air ducts
 - ❑ Direct sunlight
 - ❑ Excessive dust
 - ❑ Moisture or rain
 - ❑ Mechanical vibration or shock
 - ❑ Strong magnets or speakers that are not magnetically shielded
 - ❑ Ambient temperature of more than 35° C or less than 10° C
 - ❑ High humidity

-
- ❑ Do not place electronic equipment near your computer. The computer's electromagnetic field may cause a malfunction.
 - ❑ Provide adequate air circulation to prevent internal heat build-up. Do not place your computer on porous surfaces such as rugs or blankets, or near materials such as curtains or draperies that may block its ventilation slots. Leave a space of at least 8 inches behind the back panel of the computer.
 - ❑ The computer uses high-frequency radio signals and may cause interference to radio or TV reception. Should this occur, relocate the computer a suitable distance away from the set.
 - ❑ Use only specified peripheral equipment and interface cables; otherwise, problems may result.
 - ❑ Do not use cut or damaged connection cables.
 - ❑ Your computer cannot be connected to a coin-operated telephone, and may not work with a private branch exchange (PBX).
 - ❑ If the telephone company makes a service call to your home or office and determines that your computer is responsible for a problem, the telephone company may bill you for the service call. Also, if you do not disconnect your computer when it is adversely affecting the telephone line, the telephone company has the right to disconnect your service until you correct the problem.

On Moisture Condensation

If the computer is brought directly from a cold location to a warm one, moisture may condense inside your computer. In this case, allow at least an hour before turning on your computer. If any problems occur, unplug your computer, and contact VAIO-Link.

On Handling Diskettes

- ❑ Do not open the shutter manually and touch the surface of the diskette.
- ❑ Keep diskettes away from magnets.
- ❑ Keep diskettes away from direct sunlight and other heat sources.

On Handling CD-ROM and DVD-ROM Discs

- ❑ Do not touch the surface of the disc.
- ❑ Do not drop or bend the disc.

On Cleaning CD-ROM and DVD-ROM Discs

- ❑ Fingerprints and dust on the surface of a disc may cause read errors. Proper care of the disc is essential to maintain its reliability. Do not use solvents such as benzine, thinner, commercially available cleaners or anti-static spray, as they may cause damage to the disc.
- ❑ For normal cleaning, hold the disc by its edge and use a soft cloth to wipe the surface from the center out.
- ❑ If the disc is badly soiled, moisten a soft cloth with water, wring it out well, and use it to wipe the surface of the disc from the center out. Wipe off any remaining moisture with a dry soft cloth.

On Using Batteries

- ❑ Never leave the battery pack in temperatures above 60° C, such as in a car parked in the sun or under direct sunlight.
- ❑ Battery life is shorter in a cold environment. This is due to decreased battery efficiency at low temperatures.
- ❑ Charge the batteries at temperatures between 10° C to 30° C. Lower temperatures require a longer charging time.
- ❑ While the battery is in use or being discharged, the battery pack heats up. This is normal and is not cause for concern.
- ❑ Keep the battery pack away from all sources of heat.
- ❑ Keep the battery pack dry.
- ❑ Do not open or try to disassemble the battery pack.
- ❑ Do not expose the battery pack to any mechanical shock.
- ❑ If you are not using the computer for an extended period of time, remove the battery pack from the computer to prevent damage to the battery.
- ❑ If, after fully charging the battery pack, the battery power is still low, the battery pack may be reaching the end of its life and should be replaced.
- ❑ You do not need to discharge the battery before recharging.
- ❑ If you have not used the battery pack for a considerable amount of time, recharge the battery.

On Using earphones

- ❑ Road safety – Do not use earphones while driving, cycling, or operating any motorized vehicle. It may create a traffic hazard and is illegal in some areas. It can also be potentially dangerous to play your earphones at high volume while walking, especially at pedestrian

crossings. You should exercise extreme caution or discontinue use in potentially hazardous situations.

- ❑ Preventing hearing damage – Avoid using earphones at high volume. Hearing experts advise against continuous, loud and extended play. If you experience a ringing in your ears, reduce the volume or discontinue use.

On Maintenance

- ❑ Make sure to disconnect the power cord before cleaning the computer.
- ❑ Avoid rubbing the LCD screen as this can damage the screen. Use a soft, dry cloth to wipe the LCD screen.
- ❑ Clean the computer with a soft cloth lightly moistened with a mild detergent solution. Do not use any type of abrasive pad, scouring powder or solvent, such as alcohol or benzine.

Specifications

| <i>Model Number</i> | <i>PCG-F250</i> | <i>PCG-F270</i> | <i>PCG-F290</i> |
|---------------------------------------|--|--|--|
| <i>Processor</i> | Mobile Intel® Celeron™ 366 MHz | Intel® Mobile Pentium® II 333 MHz | Intel® Mobile Pentium® II 400 MHz |
| <i>Hard Disk Drive</i> | 4.3 GB | 6.4 GB | 6.4 GB |
| <i>Standard RAM</i> | 32 MB SDRAM | 64 MB SDRAM | 128 MB SDRAM |
| <i>Maximum RAM</i> | 160 MB | 192 MB | |
| <i>LCD Screen</i> | 13.0" XGA HPA | 14.1" XGA TFT | 15.0" XGA TFT |
| <i>L2 Cache Memory</i> | 128 KB (CPU integration) | 256 KB (CPU integration) | |
| <i>MPEG</i> | MPEG 1 Digital Video Supports full-screen playback | | MPEG 2 Digital Video Supports full-screen playback |
| <i>Graphics</i> | 128-bit accelerator with 2.5 MB Video RAM | | |
| <i>Sound Capabilities</i> | 16-bit CD-quality stereo sound | | |
| <i>Diskette Drive</i> | 3.5" 1.44 MB (removable) | | |
| <i>DVD-ROM / CD-ROM Drive</i> | CD-ROM 24x Laser Diode properties: Wave Length : 795 nm Laser Output: 16.5 μW | DVD-ROM up to 4x Laser Diode properties: Wave Length : 780 and 650 nm Laser Output: 4.59 μW | |
| <i>PC card modem</i> | V.90 56 kbps data | V.90 56 kbps data | |
| <i>Infrared</i> | Supports 4 Mbps, 1.1 Mbps, and 115 kbps IrDA Standard | | |
| <i>Expansion Capabilities</i> | Two PCMCIA type II or one type III Cards and Card Bus support | | |
| <i>Built-In Capabilities</i> | Microphone, Stereo speakers, Touchpad | | |
| <i>Telecommunication Capabilities</i> | GSM connectivity Fax send/receive (for accessories, please contact your dealer) | | |
| <i>Special Buttons</i> | PPK (Programmable Power Keys) | | |

| Model Number | PCG-F250 | PCG-F270 | PCG-F290 |
|---|--|-------------------|---|
| Connection Capabilities on Notebook | Port replicator, Printer, VGA monitor, External speakers or Headphone, Microphone, Serial, PS/2 [®] , USB, Type II & III PC Cards, Infrared, S200 i.LINK™ (IEEE 1394) | | |
| Connection Capabilities on Port Replicator | LAN (Ethernet), Printer, VGA monitor Mouse and Keyboard (USB or PS/2 [®] -style), Serial, USB | | |
| Supplied Accessories | V.90 56 kbps data PC Card modem, Floppy disk drive, Rechargeable battery, AC adapter, Phone cable, Weight saver | | |
| Service | 1 year free VAIO-Link Service‡ | | |
| Guarantee | 1 year guarantee (parts and labour) ‡ | | |
| Power Requirement | 80 watts maximum (19.5 V DC / AC100-240V) | | |
| Power Management | Energy Star compliant ACPI (Advanced Configuration and Power Interface). | | |
| Battery | Lithium ion | | |
| Dimensions | | | |
| Width | 324 mm | 324 mm | 324 mm |
| Height | 37.9 mm → 41.9 mm | 35.8 mm → 40.4 mm | 38.5 mm → 48.3 mm |
| Depth | 265.5 mm | 265.5 mm | 265.5 mm |
| Weight | 3.1 kg (with weight saver and battery) 3.3 kg (with FDD and battery) | | 3.3 kg (with weight saver and battery) 3.5 kg (with FDD and battery) |
| Operating Temperature | +5°C to +35°C | | |

‡ See your registration card for conditions.



For the models equipped with a DVD drive:

If a region code appears when you are using the DVD-player, it could happen that the DVD-ROM you are trying to play is incompatible with the DVD drive in your Sony Notebook. Region codes indicators, such as "2" or "ALL" are labelled on some DVD discs to indicate what type of player can play the disc. Unless a "2" (Europe) or "ALL" is labelled on your DVD disc or on the packaging, you cannot play the disc on this player.

Specifications are subject to change without notice.

Index

A

- About the Software guide **73**
- AC adapter **13, 17**
- AC power **17**
- adding
 - hardware **51**
 - peripherals **51**
 - printers **59**
- adjusting
 - brightness **30**
- air circulation **87**
- Alt key **27**
- Application Recovery **84**
- Applications key **27**
- attaching port replicator **57**

B

- battery bay **14**
- battery packs **13, 18, 88**
 - charging **19, 48**
 - indicator light status **20**
 - indicator lights **13, 19, 29, 47**
 - inserting **18**
 - inserting into battery bay **18**
 - loading **18**
 - power status **19**
 - rechargeable **17**
 - removing **21, 47, 48**
- brightness
 - adjusting **22, 30**
- built-in speakers
 - See also speakers **30**
- buttons
 - Eject **35**
 - Finish **24**

- left **13**
- right **13**
- Start (Windows 98) **23**

C

- cables
 - floppy disk drive **13**
 - phone **13**
 - power cord **17**
 - video **13**
- cameras
 - digital video recorder **66**
 - Sony Digital Still **63**
- canceling commands **27**
- Caps Lock **13**
 - indicator light **29**
- CD drive tray
 - troubleshooting **78**
- CD-ROM discs
 - troubleshooting **78**
- CD-ROM drive
 - troubleshooting **78**
- CD-ROM/DVD-ROM discs
 - cleaning **88**
 - ejecting **35**
 - handling **87, 88**
 - inserting **35**
- CD-ROM/DVD-ROM drive
 - closing tray **35**
 - opening tray **35**
 - using **35**
- charge status indicator light **19**
- charging battery packs **19, 48**
- choosing
 - power source **18**

cleaning computer **86**

computer

cleaning **86**

condensation **87**

lithium ion battery **4**

setting up **13**

starting **22**

troubleshooting **74, 76**

connecting

digital still camera **63**

digital video recorder **66**

external keyboard **56, 69**

external mouse **69**

external speakers **70**

GSM **53**

hard drives **37**

ISDN **53**

LAN **53**

microphone **71**

monitor **56, 60**

mouse **56**

multimedia computer display **61**

network **37**

phone line **52**

port replicator **56, 57**

power source **17**

printer **59**

projector **62**

serial device **63**

USB device **72**

weight saver **49**

connectors

DC In **15, 17, 56**

i.LINK **14**

infrared **14, 43**

keyboard **13, 15, 56**

microphone **14**

monitor **15, 56**

mouse **15, 56**

Printer **59**

printer **59**

Serial port **15, 56**

USB **15, 56**

Correction keys **26**

correction keys **27, 53**

Ctrl key **27**

cursor-movement keys **27**

Customer Service Guide **73**

customer support **73**

See also VAIO-Link **7**

D

DC In **15, 17, 56**

digital still camera **43**

connecting **63**

digital video camera **66**

diskettes

ejecting **33**

handling **87**

inserting into drive **33**

troubleshooting **79**

display

options **62**

See also monitor **15**

selecting **62**

drive bay **15**

drives

floppy disk **13**

installing additional hard disk **37**

DV In/Out **14, 66**

E

earphones

precautions **89**

Eject button **33, 35**

Eject lever **48, 49**

ejecting

battery packs **48**

CD-ROM/DVD-ROM discs **35**

diskettes **33**

weight saver **49**

ergonomic considerations **10, 11**

Escape key **26**

external devices

display **11, 62**

See also monitor **60**

keyboard **69**

mouse **69**

speakers **30, 70**

F

Finish button **24**

-
- floppy disk drive **13**
 - bay **15**
 - cable **13**
 - disconnecting **34**
 - troubleshooting **79**
 - Fn key **27**
 - combination commands **30**
 - Function keys **26**
 - function keys **27**
 - G**
 - GSM **53**
 - Guarantee **25**
 - Guarantee card **25**
 - H**
 - handling
 - audio CDs **88**
 - CD-ROM/DVD-ROM discs **87, 88**
 - diskettes **87**
 - hard drives
 - indicator light **13, 29**
 - installing additional **37**
 - headphone **13**
 - headphones **61**
 - Help
 - Mouseware **32**
 - online **73**
 - I**
 - i.LINK **14, 66**
 - IEEE-1394 **14, 66**
 - Indicator lights **29**
 - indicator lights
 - battery **13, 19, 29, 47**
 - Caps Lock **13, 29**
 - charge status **19**
 - hard drive **13, 29**
 - Num Lock **13, 29**
 - power **13**
 - Scroll Lock **13, 29**
 - infrared communication devices **43**
 - other computers **43**
 - infrared port **14, 43**
 - infrared transmission
 - active distance **44**
 - troubleshooting **44**
 - Insert key **27**
 - inserting
 - battery pack **18**
 - CD-ROM/DVD-ROM discs **35**
 - diskettes into drive **33**
 - installing
 - hard drives **37**
 - hardware **51**
 - peripherals **51**
 - interference **87**
 - ISDN **53**
 - K**
 - keyboard **27, 56**
 - connecting **69**
 - connector **13, 15**
 - L**
 - LAN **53**
 - LCD **85**
 - lock lever **22**
 - selecting to display output **62**
 - troubleshooting **77**
 - left button **13**
 - lever
 - eject **48, 49**
 - LCD **22**
 - release **34**
 - lithium ion battery
 - disposal **4**
 - safety precautions **4**
 - loading
 - battery pack **18**
 - M**
 - maintenance **86, 89**
 - microphone **14**
 - connecting **71**
 - connector **61**
 - troubleshooting **79**
 - modem
 - troubleshooting **80**
 - moisture condensation **87**
 - monitor **15, 56**
 - connecting **60**

- connector **61**
- selecting **62**
- switching among **30**
- mouse
 - connecting **69**
 - connector **15**
 - troubleshooting **77**
- Mouse Properties screen **32**
- multimedia computer display **61**
- Multi-purpose bay
 - weight saver **49**

N

- Navigation keys **26**
- navigation keys **27, 53**
- network
 - connecting **37**
- Notebook Computer **13**
- Num Lock **13**
 - indicator light **29**
- numeric keypad area **26**

O

- online help **73**
- opening
 - DVD-/CD-ROM drive tray **35**
- operator keys **27**
- output devices
 - adding **59**

P

- packing list **73**
- PC card **81**
 - inserting **37**
 - release button **37, 52**
 - removing **39**
 - slot protector **38**
 - slots **14, 37**
 - troubleshooting **81**
 - Type III **37**
- PC card modem **52**
- phone
 - cable **13**
 - connecting line **52**
- port replicator
 - connecting **56, 57**

- power **29**
 - cord **17**
 - indicator light **13**
 - programmable keys **40**
 - switch **14, 22**
- power saving modes **45**
 - System Hibernation **30, 46**
 - System Suspend **45**
 - Video Standby **30, 31**
- power sources **18, 86**
 - connecting **17**
- PPK **40**
- precautions **87**
- pre-installed software **73**
- Print Screen key **27**
- printer
 - connecting **15, 56, 59**
 - connector **59**
 - port **59**

- Printer connector **15, 56, 59**
- Product Recovery CD-ROM **82**
- programmable power keys **40**
- projector **62**

R

- radio interference **87**
- rechargeable battery packs **17, 18**
- recharging battery packs **19**
- registering
 - Windows 98 **24**
 - your computer **25**
- Registering Your Computer **25, 26**
- regulatory information **4**
- Release lever **34**
- removing
 - battery packs **21**
 - diskettes **33**
 - floppy disk drive **34**
- replacing
 - battery packs **47**
- right button **13**

S

- Scroll Lock **13**
 - indicator light **29**
- second battery pack **18, 47**

selecting
 display **62**
 LCD **62**
 monitor **62**
 power source **18**
Serial connector **15, 56, 63**
serial devices
 connecting **63**
 digital still camera **63**
setting up
 Windows 98 **24**
Shift key **27**
Shut Down Windows dialog box **23**
Smart Connect **42**
Sony e-mail support service **73**
Speakers
 volume **30**
speakers
 external **70**
 switching **30**
 troubleshooting **79**
Start button **23**
starting
 computer **22**
startup problems **23**
switching
 display **30**
 monitor **30**
System and Application Recovery CD
 82
System Hibernation mode **30, 46**
System Recovery **82**
System Suspend mode **30, 45**

T

technical specifications **73**
technical support **73**
Touchpad
 accessing **32**
 features **32**
touchpad **13, 32, 77**
troubleshooting **74**
 startup **23, 74**
turning on
 computer **22**
TV

interference **87**

U

USB
 connecting **72**
 connector **15, 56, 72**

V

VAIO-Link **73**
 response center **73**
 software **73**
ventilation **87**
video cable **13**
video camera **66**
Video Standby mode **30, 31**

W

weight saver **13**
 attaching **47**
 connecting **49**
 removing **49**
Windows 98
 Certificate of Authenticity **24**
 Control Panel **44**
 Finish button **24**
 key **27**
 License Agreement **24**
 registering **24**
 setup **24**
 Setup Wizard screen **24**
 Start button **23**
 taskbar **23, 76**
Windows® 98
 key combinations **28**