



# User Guide

**VGN-A series / PCG-K series**

## Contents

Read this first.....	5
Notice.....	5
ENERGY STAR.....	6
Owner's record .....	6
Welcome .....	7
Documentation pack .....	8
Ergonomic considerations .....	11
Using your VAIO computer .....	13
Connecting a power source .....	14
Using the battery pack .....	15
Setting the password .....	22
Setting up your computer with VAIO Control Center .....	26
Shutting down your computer safely.....	28
Using the keyboard.....	29
Using the touchpad.....	36
Using the TV function (VGN-A series) .....	37
Using the mouse (VGN-A series) .....	38
Using special buttons (VGN-A series) .....	42
Using the optical disc drive .....	45
Using the A/V port replicator (VGN-A series) .....	51
Using the external speakers (VGN-A series).....	58
Using the remote commander (VGN-A series).....	60

Using PC Cards .....	63
Using the Memory Stick.....	67
Using the modem.....	70
Using the Bluetooth functionality (VGN-A series).....	73
Using Wireless LAN (WLAN) .....	82
Using power saving modes.....	93
Managing power with VAIO Power Management .....	96
Connecting peripheral devices.....	99
Connecting a port replicator (VGN-A series) .....	100
Connecting an external display.....	106
Selecting display modes .....	116
Using the Multiple Monitors function.....	117
Connecting external speakers .....	122
Connecting an external microphone .....	124
Connecting a Universal Serial Bus (USB) device .....	127
Connecting a printer .....	133
Connecting an i.LINK device .....	137
Connecting to a network (LAN).....	141
Customising your computer .....	142
Setting up your language with Windows XP Professional .....	143
Configuring your modem .....	146
Setting a Sony wallpaper .....	148
Installing and updating applications.....	149
Managing drivers .....	154

Upgrading your VAIO computer.....	165
Adding and removing memory* .....	165
Changing the Video Memory Size .....	178
Getting help .....	180
Sony support options .....	180
Other sources of information .....	180
e-Support .....	181
Precautions.....	183
On handling the hard disk.....	184
On handling the LCD screen .....	185
On using the power source.....	186
On handling your computer .....	187
On handling floppy disks.....	188
On handling discs .....	189
On using the battery pack.....	190
On using headphones.....	190
On handling Memory Sticks.....	191
On handling the memory card adapter (VGN-A series).....	192
Trademarks.....	193

## *Read this first*

### *Notice*

© 2005 Sony Corporation. All rights reserved.

This manual and the software described herein, in whole or in part, may not be reproduced, translated, or reduced to any machine-readable form without prior written approval.

Sony Corporation provides no warranty with regard to this manual, the software, or other information contained herein and hereby expressly disclaims any implied warranties or merchantability or fitness for any particular purpose with regard to this manual, the software or such other information. In no event shall Sony Corporation be liable for any incidental, consequential, or special damages, whether based on tort, contract, or otherwise, arising out of or in connection with this manual, the software, or other information contained herein or the use thereof.

Macrovision: This product incorporates copyright protection technology that is protected by U.S. patents and other intellectual property rights. Use of this copyright protection technology must be authorized by Macrovision, and is intended for home and other limited viewing uses only unless otherwise authorized by Macrovision. Reverse engineering or disassembly is prohibited.

In the manual, the <sup>TM</sup> or ® marks are not specified.

Sony Corporation reserves the right to make any modification to this manual or the information contained herein at any time without notice. The software described herein is governed by the terms of a separate user licence agreement.

**Please note that the illustrations in this manual may not necessarily apply to your model. Please see the printed Specifications sheet for the specific configuration of your VAIO computer.**

## *ENERGY STAR*

As an ENERGY STAR Partner, Sony has determined that this product meets the ENERGY STAR guidelines for energy efficiency.

The International ENERGY STAR Office Equipment Program is an international program that promotes energy saving through the use of computers and their office equipment. The program backs the development and dissemination of products with functions that effectively reduce energy consumption. It is an open system in which business proprietors can participate voluntarily. The targeted products are office equipment such as computers, displays, printers, facsimiles and copiers. Their standards and logos are uniform among participating nations.

ENERGY STAR is a U.S. registered mark.



## *Owner's record*

The serial number, model number and product code are located on the bottom of your Sony computer. Record the numbers and refer to them if you call VAIO-Link. See also the printed **Specifications** sheet.

## Welcome

Congratulations on purchasing a Sony VAIO computer. Sony has combined leading-edge technology in audio, video, computing and communications to provide you with state-of-the-art personal computing.

Here are the main features you can enjoy:

- ❑ **Exceptional performance.**
- ❑ **Portability** – The rechargeable battery pack provides hours of use without AC power.
- ❑ **Sony audio and video quality** – The high-resolution LCD screen and high-quality stereo speakers\* enable you to take advantage of today's advanced multimedia applications, games, and entertainment software.
- ❑ **Multimedia features** – Enjoy audio and video CDs/DVDs.
- ❑ **Interconnectivity** – Your computer has Ethernet, Hi-Speed USB (USB2.0) and i.LINK functionalities. i.LINK is a bidirectional digital interface for exchanging data. With the Memory Stick you can easily exchange and share digital data with compatible products.
- ❑ **Wireless technology** – Thanks to the Bluetooth\* and the Wireless LAN (IEEE 802.11b/g) technology, you can communicate freely, without cables or wires.
- ❑ **Wireless setup** – Enjoy the freedom of having a mouse without cables\*.
- ❑ **VAIO Zone** – Take advantage of the new **VAIO Zone** technology, allowing you to watch TV and record your favourite programmes digitally and by remote control\*.
- ❑ **Windows** – Your system includes Microsoft's Windows XP Professional or Home Edition\* with Service Pack 2 operating system.
- ❑ **Communications** – Access popular online services, send and receive e-mails, browse the Internet.
- ❑ **Excellent customer support** – If you are experiencing any problems with your computer, please check the VAIO-Link website for a possible solution:

<http://www.vaio-link.com>

Before contacting VAIO-Link, please try to solve the problem by reading this guide, the printed **Troubleshooting Guide**, or the manuals and help files for the peripherals or software.

\* Depending on your model. See the printed **Specifications** sheet for more information.



## Documentation pack

Your documentation pack contains printed information and user guides to read on your VAIO computer.

Guides are provided in PDF format, which you can easily browse through and print out.

The **My Info Centre** portal is a perfect starting point to using your VAIO computer - a comprehensive collection of everything you need to get the most from your computer.

The user guides are collected under **My Documentation**, which can be shown as follows:

- 1 Go to **Start** and click the **My Info Centre** icon\* .
- 2 From the pictures at the top of the window click **My Documentation** .
- 3 Select your language from the drop-down box.
- 4 Select the guide you want to read.

\* The **My Info Centre** icon is only visible after you have performed the **Prepare your VAIO** setup. The **My Info Centre** icon is also available in **Start/All Programs** and can be used before you have performed the **Prepare your VAIO** setup.



You can manually browse to the user guides by going to **My Computer > VAIO (C:) (your C drive) > My Documentation > Documentation** and opening the folder for your language.

You may have a separate disc for the documentation of bundled accessories.



## *Printed documentation*

- A **Specifications** sheet, containing a table of specifications, a list of bundled software, an overview of all connectors and, on the reverse side, a guide to setting up your VAIO computer.
- Troubleshooting Guide**, where you will find solutions to common problems.
- Recovery Guide**, where you will find an explanation of how to recover your computer's system if you need to.
- Guarantee and End User Software License Agreement**
- Regulatory Booklet**
- Wireless Regulations Guide**

## *Non-printed documentation*

**My Documentation** contains the following VAIO user guides:

- The **User Guide** (this guide) explains the features of your VAIO computer in detail, how to use these features confidently and safely, connect peripheral devices, upgrade your computer, and more.
- The **VAIO Zone** guide explains the valuable features of VAIO's multimedia portal. If your computer has TV tuner functionalities, this is where you will find information about watching/recording TV on your VAIO computer.

**My Documentation** also gives you:

- Help files about reading the guides.
- Important information about your computer, in the form of notices and announcements.

In **My Info Centre** you can also find:



### **My Software**

Feeling creative? Click this icon for an overview of your software and check out our upgrade options.



### **My VAIO essentials**

Want to expand the capabilities of your VAIO computer? Click this icon and have a look at your compatible accessories.



### **My Websites**

Click this icon and check out our most popular websites.



### **My ISP**

Click this icon to find out about the preferential offers from our partners and access the world of the internet.

## *Further sources*

- 1 Go to **Start > Help and Support** for VAIO support information as well as tips and tricks.
- 2 Consult the **Online Help** files of the software you are using for detailed information on features and troubleshooting.
- 3 Go to [www.club-vaio.com](http://www.club-vaio.com) to find online tutorials about your favourite VAIO software.

## Ergonomic considerations

You will be using your computer as a portable device in a variety of environments. Whenever possible, you should attempt to take account of the following ergonomic considerations to both stationary and portable environments:

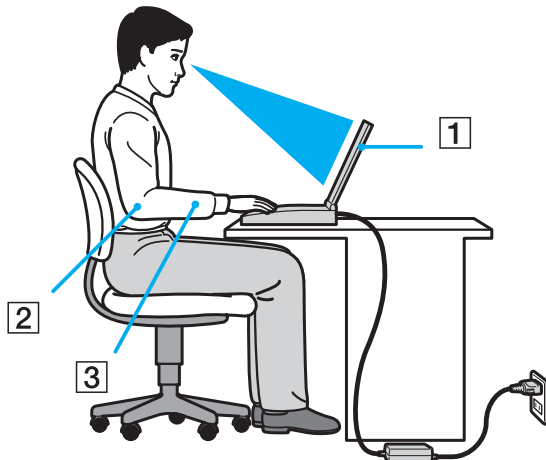

- ❑ **Position of your computer** – Place the computer directly in front of you (1). Keep your forearms horizontal (2), with your wrists in a neutral, comfortable position (3) while using the keyboard, touchpad, or external mouse. Let your upper arms hang naturally at your sides. Have breaks during sessions with your computer. Excessive use of the computer may strain muscles or tendons.
- ❑ **Furniture and posture** – Sit in a chair with good back support. Adjust the level of the chair so your feet are flat on the floor. A footrest may make you more comfortable. Sit in a relaxed, upright posture and avoid slouching forward or leaning far backwards.
- ❑ **Viewing angle of the computer's display** – Use the display's tilting feature to find the best position. You can reduce eye strain and muscle fatigue by adjusting the tilt of the display to the proper position. Adjust the brightness setting of the display as well.

- ❑ **Lighting** – Choose a location where windows and lights do not create glare and reflection on the display. Use indirect lighting to avoid bright spots on the display. You can also purchase accessories for your display that help reduce glare. Proper lighting adds to your comfort and work effectiveness.
- ❑ **Positioning an external display** – When using an external display, set the display at a comfortable viewing distance. Make sure the display screen is at eye level or slightly lower when you are sitting in front of the monitor.

## Using your VAIO computer

Once you have read and followed the information in the printed **Specifications** sheet, you can start using your computer safely and confidently.

Read on to get the most out of using your VAIO computer.

- Connecting a power source** ([page 14](#))
- Setting the password** ([page 22](#))
- Setting up your computer with VAIO Control Center** ([page 26](#))
- Shutting down your computer safely** ([page 28](#))
- Using the keyboard** ([page 29](#))
- Using the touchpad** ([page 36](#))
- Using the TV function** ([page 37](#))
- Using the mouse** ([page 38](#))
- Using special buttons** ([page 42](#))
- Using the optical disc drive** ([page 45](#))
- Using the A/V port replicator** ([page 51](#))
- Using the external speakers** ([page 58](#))
- Using the remote commander** ([page 60](#))
- Using PC Cards** ([page 63](#))
- Using the Memory Stick** ([page 67](#))
- Using the modem** ([page 70](#))
- Using the Bluetooth functionality** ([page 73](#))
- Using Wireless LAN (WLAN)** ([page 82](#))
- Using the power saving modes** ([page 93](#))
- Managing power with VAIO Power Management** ([page 96](#))

## Connecting a power source

You can use either an AC adapter or a rechargeable battery pack as a power source.

### Using the AC adapter

To use the AC adapter, proceed as follows:

- 1 Plug one end of the power cord (1) into the AC adapter.
- 2 Plug the other end of the power cord into an AC outlet (2).
- 3 Plug the cable attached to the AC adapter (3) into the DC In connector (4) on the computer.

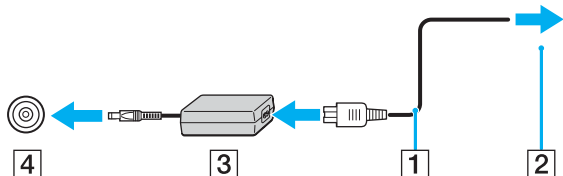

! The shape of the DC In plug varies depending on the AC adapter.



Use your computer only with the supplied AC adapter.

To disconnect your computer completely from mains voltage, unplug the AC adapter.

Make sure that the socket outlet is easily accessible.

If you do not use the AC adapter for a long period of time, put your computer into **Hibernate** mode. This power saving mode saves you the time of shutting down in the normal way.

## *Using the battery pack*

The battery pack supplied with your computer is not fully charged at the time of purchase.

## Installing the battery pack

### VGN-A series

To install the battery pack, proceed as follows:

- 1 Turn off your computer and close the LCD.
- 2 Slide the lock lever (1) on the bottom of the computer to the **UNLOCK** position.
- 3 Slide the release lever (2) on the bottom of the computer to the **RELEASE** position.

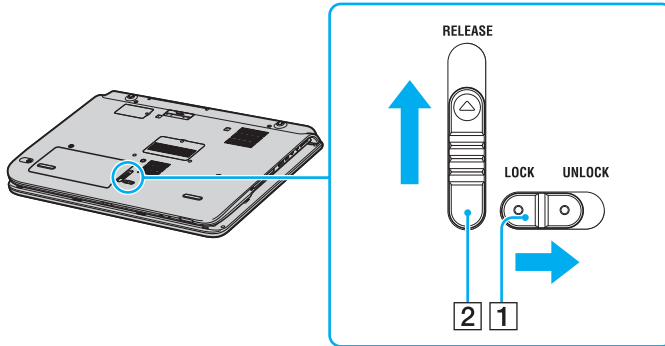

- 4 Remove the battery compartment cover.
- 5 Slide the battery pack in the battery compartment cover.

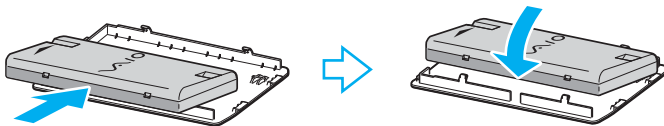



- 6 Turn over the battery pack attached to the battery compartment cover.
- 7 Insert the tab on the battery compartment cover into the notch, and push the battery pack down into the compartment until it clicks into place.
- 8 Slide the lock lever to the **LOCK** position to secure the battery pack on the computer.

### PCG-K series

To install the battery pack, proceed as follows:

- 1 Turn off your computer and close the LCD.
- 2 Open the cover of the battery bay.

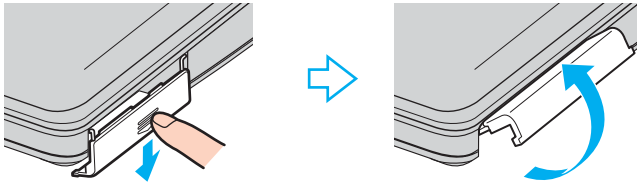

- 3 Insert the battery pack with the label facing up into the battery bay of the computer.
- 4 Close the cover of the battery bay until it clicks.



When the computer is directly connected to AC power and has a battery pack installed, it uses power from the AC outlet.

## Charging the battery pack

To charge the battery pack, proceed as follows:

- 1 Install the battery pack.
- 2 Connect the AC adapter to the computer.

The computer automatically charges the battery (the battery indicator flashes in a double blink pattern as the battery charges).

<i>Battery indicator status</i>	<i>Meaning</i>
On	The computer is using battery power.
Single blink	The battery is running out of power.
Double blink	The battery is charging.
Off	The computer is using AC power.



When the battery is running out of power, both the battery and power indicators blink.

Keep the battery pack installed in the computer while it is directly connected to AC power. The battery pack continues to charge while you are using the computer.

If the battery level falls below 10%, you should either attach the AC adapter to recharge the battery or shut down your computer and install a fully charged battery pack.

The battery pack supplied with your computer is a lithium ion battery and can be recharged any time. Charging a partially discharged battery pack does not affect battery life.

The battery indicator is on while you use the battery pack as a power source. When the battery life is nearly depleted, both the battery and power indicators start flashing.

For some software applications and some peripheral devices, your computer may not enter **Hibernate** mode even when battery life is low. To avoid loss of data when using battery power, you should save your data frequently and manually activate a power management mode, such as **Standby** or **Hibernate**. If the battery wears out when your computer enters **Standby** mode, you will lose any unsaved data. Going back to the previous work state is impossible. To avoid loss of data, you should save your data frequently.

When the computer is directly connected to AC power and has a battery pack installed, it uses power from the AC outlet.

## Removing the battery pack

### VGN-A series

To remove the battery pack, proceed as follows:

- 1 Turn off your computer and close the LCD.
- 2 Slide the lock lever (1) on the bottom of the computer to the **UNLOCK** position.
- 3 Slide the release lever (2) on the bottom of the computer to the **RELEASE** position.  
The right edge of the battery compartment cover is pushed up.

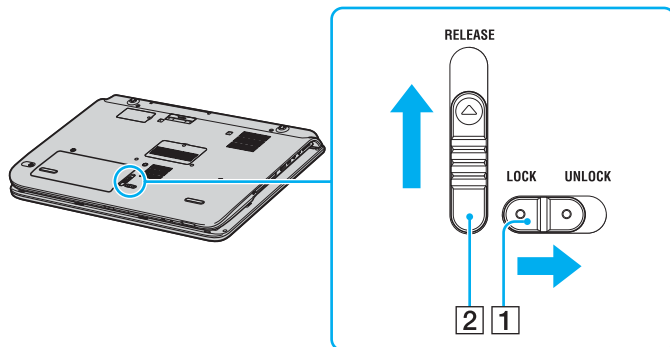

- 4 Raise the edge to remove the battery compartment cover.
- 5 Open the tabs on the battery compartment cover to release the battery pack and remove it from the battery compartment cover.
- 6 Insert the two tabs on the battery compartment cover diagonally into the notches and push the cover into the compartment until it clicks into place.

**PCG-K series**

To remove the battery pack, proceed as follows:

- 1 Turn off your computer and close the LCD.
- 2 Open the cover of the battery bay.
- 3 Pull out the battery pack.
- 4 Close the cover of the battery bay.



You may lose data if you remove the battery pack while the computer is on and not connected to the AC adapter or if you remove the battery pack while the computer is in **Standby** mode.

## Setting the password

Use one of the BIOS functions to set the password.

Once you have set the password, you will have to enter the password after the VAIO logo appears. In this way, you can protect your computer from unauthorized access.

**!** You cannot start your computer without entering the password. Make sure not to forget the password.

If you forget the password and need assistance to cancel it, a cancellation fee will be charged.

## Adding the password

### VGN-A series

To add the password, proceed as follows:

- 1 Turn on your computer.
- 2 Press **F2** when the **VAIO logo** appears.  
The BIOS setup screen appears. If not, press **F2** several times.
- 3 Use **←** or **→** to select **Security** and press **Enter**.  
The password entry screen appears.
- 4 Enter the password **twice** and press **Enter**.  
The password should be **up to 7 alphanumeric characters** long.
- 5 When **Password installed** appears, press **Enter**.



The following is to configure your computer to prompt password entry when you turn on your computer or display the BIOS setup screen.

- 6 Select **Password when Power ON** under **Security**.  
Press **Enter**, use **↑** or **↓** to select **Enabled**, and then press **Enter**.
- 7 Use **←** or **→** to select **Exit** and then **Exit (Save Changes)**; and press **Enter**.  
On the **Save configuration changes and exit setup?** screen, confirm that **OK** is selected and then press **Enter**.

### *PCG-K series*

To add the password, proceed as follows:

- 1 Turn on your computer.
- 2 Press **F2** when the **VAIO logo** appears.  
The BIOS setup screen appears.
- 3 Use **←** or **→** to select **Security** to display another screen, select **Set Machine Password**, and then press **Enter**.
- 4 On the password entry screen, enter the password **twice** and press **Enter**.  
The password should be **up to 7 alphanumeric characters** long.



The following is to configure your computer to prompt password entry when you turn on your computer or display the BIOS setup screen.

- 5 Select **Password When Power ON** under **Security**.  
Press the space bar to change the setting from **Disabled** to **Enabled**.
- 6 Use **←** or **→** to select **Exit** and then **Exit (Save Changes)**; and press **Enter**.  
On the **Setup Confirmation** screen, confirm that **Yes** is selected and then press **Enter**.

## Changing/removing the password

### VGN-A series

To change or remove the password, proceed as follows:

- 1 Turn on your computer.
- 2 Press **F2** when the **VAIO logo** appears.  
The BIOS setup screen appears. If not, press **F2** several times.
- 3 Enter the current password for **Enter CURRENT Password**:
- 4 Use **←** or **→** to select **Security** to display another screen, select **Set Machine Password**, and then press **Enter**.  
The password entry screen appears.
- 5 Enter a new password **twice** and press **Enter**.  
Enter a new password both for **Enter New Password** and **Confirm New Password**.  
When **Password installed** appears, press **Enter**.  
To remove the password, leave **Enter New Password** blank and press **Enter**.
- 6 Use **←** or **→** to select **Exit** and then **Exit (Save Changes)**; and press **Enter**.  
On the **Save configuration changes and exit setup?** screen, confirm that **OK** is selected and then press **Enter**.



## PCG-K series

To change or remove the password, proceed as follows:

- 1 Turn on your computer.
- 2 Press **F2** when the **VAIO logo** appears.  
The BIOS setup screen appears.
- 3 Enter the current password for **Enter Password**:
- 4 Use **←** or **→** to select **Security** to display another screen, select **Set Machine Password**, and then press **Enter**.
- 5 On the password entry screen, enter the **current password once** and then a **new password twice**; and press **Enter**.  
To remove the password, leave **Enter New Password** and **Confirm New Password** blank and press **Enter**.
- 6 Use **←** or **→** to select **Exit** and then **Exit (Save Changes)**; and press **Enter**.  
On the **Setup Confirmation** screen, confirm that **Yes** is selected and then press **Enter**.

## Setting up your computer with VAIO Control Center

The **VAIO Control Center** utility allows you to consult system information and specify preferences for system behaviour.

To use VAIO Control Center, proceed as follows:

- 1 Click the **Start** button on the **Windows** taskbar.
- 2 In **All Programs**, click **VAIO Control Center**.  
The **VAIO Control Center** window appears.

<i>Control item</i>	<i>Description</i>
System Information	Displays the information about your operating system and the hardware architecture.
Initial Setting	You can specify the order in which the system checks for devices containing a bootable system when it starts.
Built-in Pointing Device	You can enable or disable the built-in pointing device.
Printer Port (PCG-K series only)	You can specify settings to resolve resource conflicts when you add the hardware.
S Button (VGN-A series only)	You can change the Control items assigned to the computer's S button. Available pre-defined assignments are: <b>Stand by, Hibernate, External Display, Launch Application, VAIO Zone*</b> , <b>Multiple Monitors</b> * Default assignment
Plug and Display (VGN-A series only)	You can specify settings for automatic output to the external display.
Automatic Brightness (VGN-A series only)	You can specify settings for the auto luminance sensor. The auto luminance sensor senses the brightness from outside then the display brightness is adjusted accordingly.
Station and Port replicator (VGN-A series only)	You can specify the behaviour when station or port replicator is connected to your computer.
Wireless Switch Settings (VGN-A series only)	You can select the option of the wireless function that is activated when you set the WIRELESS switch on your computer to ON.

- 3 Select the desired control item.
- 4 Once finished, click **OK**.  
The item has been changed.



For more information about each option, click **Help** on the **VAIO Control Center** window to display the help file.

Some of the control items will not be visible if you open **VAIO Control Center** as a limited user.

## *Shutting down your computer safely*

It is important that you shut down your computer properly so you do not lose unsaved data.

To shut down your computer, proceed as follows:

- 1 Turn off any peripherals connected to your computer.
- 2 Click the **Start** button.
- 3 Click **Turn Off Computer**.  
The **Turn off computer** window appears.
- 4 Click **Turn Off**.
- 5 Respond to any prompts warning you to save documents or to consider other users and wait for your computer to turn off automatically.  
The power indicator turns off.



See the printed **Troubleshooting Guide** if you have problems shutting down your computer.















## Using the keyboard

Your keyboard is very similar to a desktop computer's, but has additional keys that perform model-specific tasks.

For more information on the standard keys, see Windows **Help and Support Center**.

The VAIO-Link website ([www.vaio-link.com](http://www.vaio-link.com)) also contains glossary information to help you use the keyboard.

## Combinations and functions with the <Fn> key

Combinations/Feature	Functions
<Fn> +  (F2): speaker switch (PCG-K series only)	Turns the built-in speakers on and off.
<Fn> +  (F3/F4): speaker volume (PCG-K series only)	Adjusts the built-in speaker volume. To increase volume, press <Fn>+<F4> and then  or  , or keep pressing <Fn>+<F4>. To decrease volume, press <Fn>+<F3> and then  or  , or keep pressing <Fn>+<F3>.
<Fn> +  (F5/F6): brightness control	Adjusts the brightness of the LCD. To increase lightness intensity, press <Fn>+<F6> and then  or  , or keep pressing <Fn>+<F6>. To decrease lightness intensity, press <Fn>+<F5> and then  or  , or keep pressing <Fn>+<F5>.
<Fn> +  /  (F7)*: switch to the external display	Toggles between the LCD, external device (monitor or TV depending on which device is connected) and both LCD and external device.
<Fn> +  (F12): Hibernate	Provides for the lowest level of power consumption. When you execute this command, the states of the system and of the peripheral devices are written to the hard disk and the system power is turned off. To return the system to its original state, use the power switch to turn on the power. For details on power management, see the section <b>Using the power saving modes</b> (page 93).













\* On PCG-K series, this function can only be used by the first user to log on. It will not work if you have switched to another user account. If another user wants to display on an external monitor or TV, use the monitor properties to switch to an external monitor or TV.



Some functions are not available until Windows is launched.

## Indicators

<i>Indicator</i>	<i>Functions</i>
Power 	<b>Power on:</b> lights green. <b>Standby mode:</b> flashes amber.
Battery 	Indicates the status of the battery.
Wireless LAN	Turns on when the Wireless LAN is activated. Turns off when the Wireless LAN is not activated.
Bluetooth  (VGN-A series only)	Turns on when the Bluetooth functionality is activated. Turns off when the Bluetooth functionality is not activated.
Memory Stick 	Turns on when the <b>Memory Stick</b> is in use. Turns off when the <b>Memory Stick</b> is no longer in use.
Optical disc drive  (VGN-A series only)	Turns on when the optical disc drive is in use. Turns off when the optical disc drive is no longer in use.
Mute  (VGN-A series only)	Turns on when the volume is turned off.
Brightness  (VGN-A series only)	Turns on when the screen brightness is maximized.
Hard disk 	Turns on when data is read from or written to the hard disk drive. Turns off when the hard disk drive is not being accessed.
Num Lock 	Turns on when the number keys in the numeric keypad area are active. Turns off when the alphanumeric character keys in the keypad area are active.
Caps Lock 	Turns on when the letters appear in uppercase as you type. The <Shift> key lowers the case of typed characters when <b>Caps Lock</b> is on. Turns off when the letters appear in lowercase as you type (unless you hold down the <Shift> key).
Scroll Lock 	Turns on when the screen scrolls differently (Not all applications support this function). Turns off when the information moves across the display normally.

## Troubleshooting the keyboard

### A key top has fallen off

- If any of the following keys falls off, replace the key top as shown below.

**VGN-A series:** Caps Lock, Shift, Backspace, Enter, or space bar

**PCG-K series:** Enter, Caps Lock, Ctrl, Tab, space bar, left Shift

If any other key top falls off, place it back into position and push it in from above until it clicks.

#### To replace a key top

Remove the wire (1) from the key top, then attach it to the hooks (2) on the key unit. Align the centre of the key top and press it from above (3) until it clicks.

#### VGN-A series

- Caps Lock key, Shift key, Backspace key

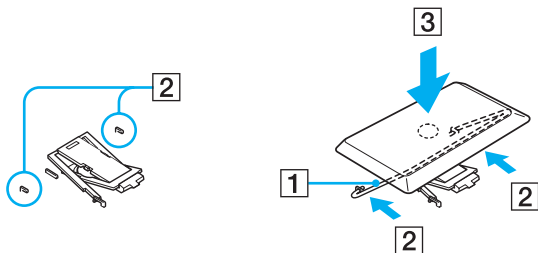

❑ Enter key

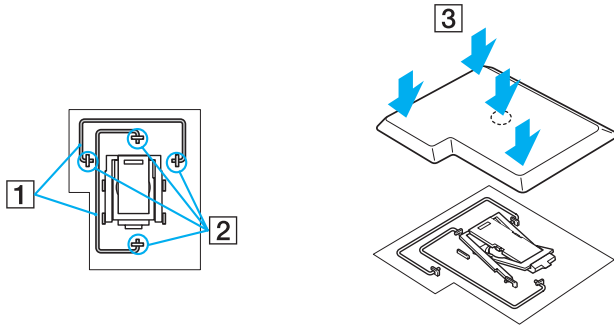



□ Space bar key

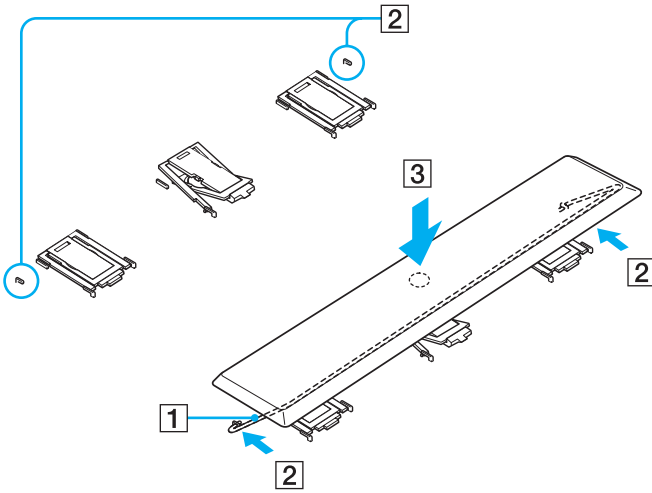

**PCG-K series**

- ❑ Caps Lock key, Ctrl key, Tab key

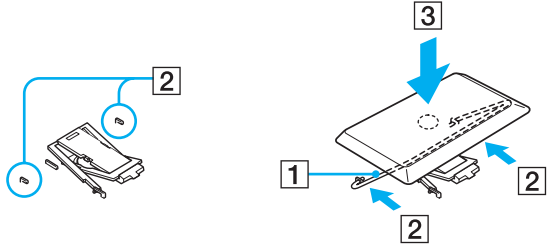

- ❑ Enter key

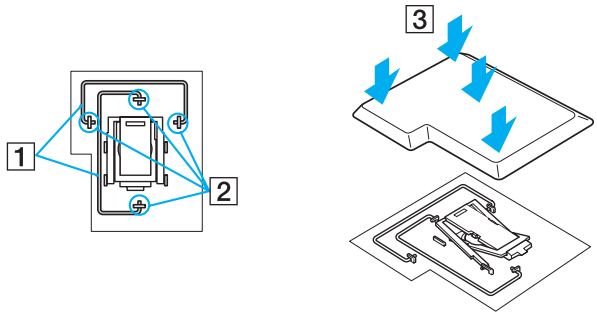

- ❑ Space bar key, left Shift key

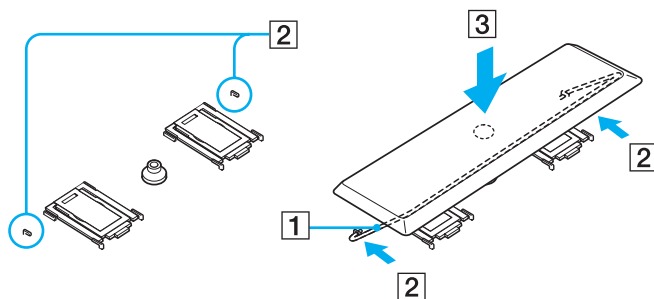

- ❑ If any key top other than the above keys falls off, see the figure below to place it back into position.

### To replace a key top

Hook the catches (1) on the key top onto the screen side corners of the key top support (2), place the key top back into position, and then press it from above (3) until it clicks.

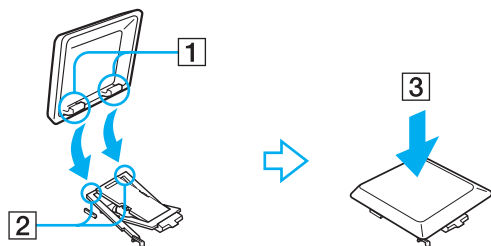

! Do not take off the key top intentionally, as it may cause a malfunction.

Do not push the key top excessively when you replace it, as it may cause a malfunction. Handle the key tops with care.

## Using the touchpad

The keyboard contains a cursor-pointing device, your touchpad (1). You can point to, select, drag, and scroll objects on the screen using the built-in touchpad.

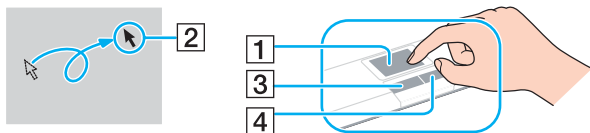

### Action

### Description

Point	Slide one finger on the touchpad to place the pointer (2) on an item or object.
Click	Press the left button (3) once.
Double-click	Press the left button twice.
Right-click	Press the right button (4) once. In many applications, this action displays a shortcut menu.
Drag	Slide one finger while pressing the left button.
Scroll	Move your finger along the right edge of the touchpad to scroll vertically. Move your finger along the bottom to scroll horizontally (the scroll function is available only with applications that support a touchpad scroll feature).

## Using the TV function (VGN-A series)

Your VAIO computer is equipped with a TV tuner board. The A/V port replicator delivered with a certain model\* features a TV tuner board. In combination with Sony's **VAIO Zone** software, it allows you to:

- Watch, record and play back analogue broadcasted cable and terrestrial TV programmes, all by remote control;
- Digitise analogue video and audio using the S-video or composite and audio inputs;
- Manage your video units (capsules), preview them and create multiple folders;
- Set up a timer to record channels at a repeated time;
- Suspend viewing TV (time-shifting);
- Stream your recorded TV contents via Ethernet (or WLAN) to connected PCs.

 Sony cannot guarantee the streaming of recorded content if it is beyond a certain level of high quality.

For details on using **VAIO Zone** and the remote control, please see the dedicated guide. Otherwise read the help files within the software itself.

tvTV takes your VAIO's TV functions to a new level. Never miss your favourite TV programme again, by remote-recording it via the internet onto your TV tuner-equipped VAIO. The tvTV Interactive Programme Guide gives you a comprehensive overview of what's on when and automatically synchronises it with your VAIO, wherever you happen to be at the time. For more information, read the **Welcome to TVTV** HTML files on your computer.

\* See the printed **Specifications** sheet for more information.

To connect terrestrial or cable TV to your computer, proceed as follows:

- 1 Plug one end of your antenna cable/cable-TV cable (not supplied) into the Antenna (VHF/UHF) connector on the computer.
- 2 Plug the other end into the TV wall socket.

## Using the mouse (VGN-A series)

Your VAIO computer is delivered with a wireless optical mouse, which has no cables to plug in and uses a light-emitting diode (LED) instead of a ball. You can use the mouse anywhere you feel comfortable within a range of approx. 80 cm\* of the main unit. Avoid using the mouse on a piece of glass or other transparent material, as this can interfere with smooth cursor movement on the screen.

\* Effective usage distance depends on the environment.

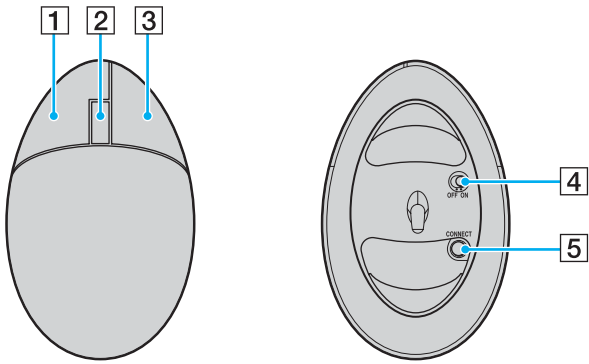

1	Left button	Click or double-click the left button to select items. To drag and drop items, hold the left button down while sliding the mouse, then release the button to drop the item.
2	Central wheel	Turn the central wheel to scroll up or down a page. Press the wheel once to lock the scroll action and control the movement by moving the entire mouse (the scroll function is available only with applications that support it).
3	Right button	Press the right button once to display a context-sensitive shortcut menu (not always an active function).
4	Power switch	Slide the switch to turn the mouse on and off. This will help you save battery power.
5	<b>CONNECT</b> button	Press to enable communication between your VAIO computer and the wireless mouse.

You can adjust the mouse pointer speed and other functions under **Mouse Properties**. To display **Mouse Properties**, go to the **Control Panel**, select **Printers and Other Hardware**, then select **Mouse**.

## Before you use the mouse

Before attempting to use the wireless mouse, you must enable communication between the computer and the mouse.

Two AA batteries, specific for use in the wireless mouse, are supplied with your computer. They are identified by a sticker "For mouse" on the packaging.

To connect the wireless mouse, proceed as follows:

- 1 Insert the two specific AA batteries into the wireless mouse as shown.

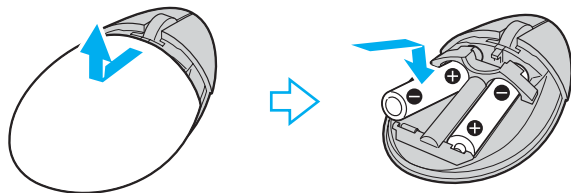

- 2 Turn on the computer.
- 3 Press the **CONNECT** button (1) on the computer.

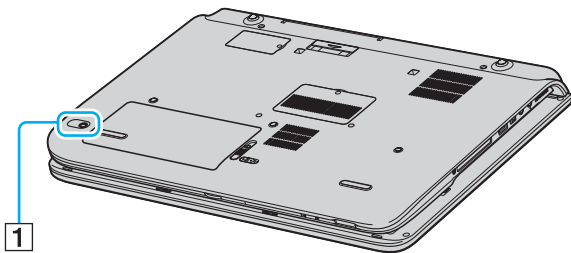



- Turn the wireless mouse over, slide the power switch to the **ON** position, and press the **CONNECT** button. Communication between the wireless mouse and the computer is now active.

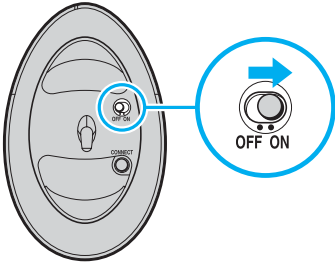

Step 3 and 4 must be carried out within 10 seconds of each other.

If your wireless mouse does not operate properly, the batteries may need to be replaced. If your wireless mouse is not being used for an extended period of time, remove the batteries to avoid possible damage from battery leakage.

## Setting up the mouse for left-handed users

To set up your mouse for left-handed users, proceed as follows:

- Go to **Start**, select **Control Panel**, then click the **Printers and Other Hardware** option.
- Click the mouse icon.  
The **Mouse Properties** dialog box appears.
- In the **Buttons** tab, select the option button next to **Switch primary and secondary buttons**.
- Click **OK**.  
The new mouse settings are now in place.

## Using special buttons (VGN-A series)

Your VAIO computer is provided with special buttons to help you use the computer.

- ❑ **Mute button** :

Turns on and off the speaker volume. The LED turns on when the volume is turned off.

- ❑ **Volume buttons (Volume up and Volume down)** :

Increase and decrease the volume.

- ❑ **Brightness button** :

You can increase and decrease the brightness intensity. When the screen is on maximum brightness intensity, the LED turns on.

### **Auto luminance sensor:**

By default, the light sensor senses the brightness from outside and the display brightness is adjusted accordingly. This setting only applies when the display is set to automatic brightness mode. Press the brightness button to set the display to automatic brightness mode. You can adjust the general level of the automatic brightness mode in **Setting up your computer with VAIO Control Center** ([page 26](#)).

❑ **Magnify** button (Zoom) :

Changes the image resolution in all applications, except in those that use the DVD player.

The default resolutions of the standard view and the magnified view depend on the model as listed below. For the type of LCD screen equipped with your computer, see **LCD screen** in the printed **Specifications** sheet.

- ❑ Models with the WUXGA LCD screen
  - Standard view:** 1920 x 1200 pixels
  - Magnified view:** 1280 x 768 pixels
- ❑ Models with the WXGA+ LCD screen
  - Standard view:** 1440 x 900 pixels
  - Magnified view:** 1024 x 600 pixels



When an external display is connected to your computer, the **Magnify** button is disabled.

The magnified view is not as clear as the standard view.

Pressing the **Magnify** button changes the resolution, thus may cause a defect to any running software that does not support change in resolution. Make sure to quit such software before pressing the **Magnify** button.

The **Magnify** button may not work with graphic images as it magnifies the screen view by changing the resolution.

The location and size of software windows may change when the screen view is magnified or the standard view is restored because pressing the **Magnify** button changes the resolution.

When the LCD screen view is magnified, switching the view to the external display disables the function and restores the standard view.

❑ **S1** button :

The **S1** button, by default, launches **VAIO Zone**. You also can link another action that you execute often to this shortcut button. See **Setting up your computer with VAIO Control Center** ([page 26](#)).

### *Troubleshooting special buttons (VGN-A series)*

#### *Pressing the **Magnify** button does not change the screen resolution*

- ❑ If the default resolution has been changed using the **Display Properties** window, pressing the **Magnify** button may not work. Change the resolution to the default one in the **Display Properties** window, and then use the **Magnify** button.
- ❑ When the software that places high load to the CPU is running, pressing the **Magnify** button may cause a malfunction. It is strongly recommended that you should not use the **Magnify** button while such software is running.

## Using the optical disc drive

Your VAIO computer is equipped with an optical disc drive.

To insert a disc, proceed as follows:

- 1 Turn on the computer.
- 2 Press the eject button (1) to open the drive.  
The tray slides out.
- 3 Place a disc in the middle of the tray with the label side facing up until the disc clicks into place.

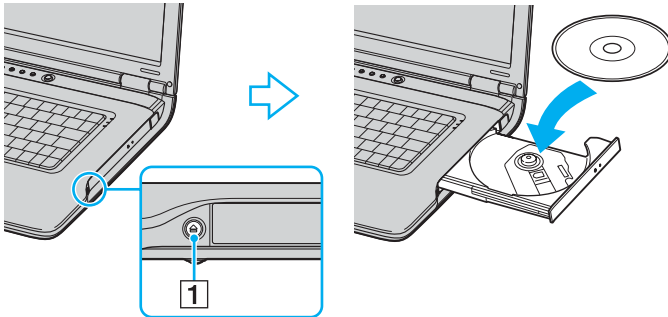

- 4 Close the tray by pushing it gently.



See the printed **Troubleshooting Guide** if you have problems using discs.

The location of the eject button depends on the model of your computer. See the printed **Specifications** sheet for details on your model.

## Reading and writing CDs and DVDs

To achieve optimum performance when writing data on to disc (also called "burning"), follow these recommendations:

- To make the data on a disc readable on an optical disc drive, you need to close the session when you eject it. To complete this process, follow the instructions included with your software.
- Only use circular discs. Do not use discs in any other shape (star, heart, card, etc.), as this may damage the disk drive.
- Do not strike or shake the computer while writing data to a disc.
- For optimal writing speed, deactivate the screensaver before writing data to a disc.
- Memory-resident disc utilities may cause unstable operation or data loss. Deactivate these utilities before writing data to a disc.
- When using your software application to burn discs, make sure you exit and close all other applications.
- Never touch the surface of the disc. Fingerprints and dust on the surface of a disc may cause writing errors.
- Do not put your VAIO computer into a power saving mode while using the pre-installed software and while using the CD burning software.
- Never put stickers on discs. This will affect the use of the disc irreparably.
- In rare cases, some DVD players and computer's DVD drives may not be able to play DVDs created with **VAIO Zone**.



Ultra-speed CD-RW is supported on VGN-A series but not on PCG-K series.

Supports writing to DVD-RW discs compliant with DVD-RW version 1.1/1.2.\*

Supports 8cm disc reading, but does not support 8cm disc writing.

Because the maximum writing speed to DVD+R DL (Double Layer) discs is 2.4x speed, it may take a while to finish writing to such discs. See the printed **Specifications** sheet for more information on the optical disc drive.

\* Depending on your model. See the printed **Specifications** sheet to see whether your model is equipped with the optical disc drive capable of DVD writing.

## Playing DVDs

To achieve optimum performance when playing DVDs, you should follow these recommendations.

- You can play DVDs using the optical disc drive and the **VAIO Zone** software. See the help file on the **VAIO Zone** software for details.
- Close all open applications before playing a DVD movie.
- Do not use resident disc utilities or resident utilities to speed up the access of discs, because they may cause the system to become unstable.
- Make sure that the screensaver is deactivated.
- Region codes indicators are labelled on the DVDs to indicate in which region and on what type of player you can play the disc. Unless a "2" (Europe belongs to region "2") or "all" (this means that you can play this DVD everywhere in the world) is labelled on your DVD disc or on the packaging, you cannot play the disc on this player.
- Do not try to change the region code settings of the DVD drive. Any difficulties caused by changing the region code settings of the DVD drive are out of warranty.
- If your computer has Wireless LAN and Wireless LAN is activated, playing DVDs may cause some interruptions in audio and video.

## Troubleshooting the optical disc drive

### *I cannot switch from LCD display to TV and vice versa (PCG-K series)*

If a DVD disc is inserted in the optical disc drive, remove the disc.

### *My optical disc drive tray does not open*

- Make sure the computer is turned on and press the disc eject button\*.



On VGN-A series, try first the disc eject button\*. If this button does not work, then press the substitute disc eject button\* on the optical disc drive. The disc eject button is disabled until you start your computer and log on to Windows.

- Go to **Start > My Computer**. Right-click the optical disc drive and select **Eject**.
- Make sure the computer is not in **Standby** or **Hibernate** mode.
- If this does not work, try the following:

Turn off the computer and insert a sharp, pointed object (for example a paperclip) into the manual eject hole\* on the optical disc drive to slide out the tray.

\* The location of the eject button and hole depends on the model of your computer. See the printed **Specifications** sheet for details on your model.

### *I cannot play a disc*

- After inserting the disc, wait for a few seconds for the system to detect it before you try to access it.
- Make sure the label of the disc is facing up.
- If the disc requires software, make sure the software is installed according to the instructions of the program.
- Check the volume of your speakers.
- Clean the disc with an appropriate cleaner.
- Make sure your computer is running on AC power supply only and try the disc again.
- There may be condensation in the drive. Remove the disc and leave the drive open for approximately one hour. Remove the battery while you wait for the condensation to disappear.



## *I cannot play a DVD*

- If a region code warning appears when you are using your DVD player, it could be that the DVD you are trying to play is incompatible with the optical disc drive on your computer. The region code is listed on the packaging of the disc.
- Change the resolution under **Control Panel - Display** to a lower resolution.
- If you see video but cannot hear sound, check all of the following:
  - Make sure the mute setting is off on your DVD player.
  - Check the **Master Volume** settings of the **Sounds and Audio Device Properties**.
  - If you have connected speakers externally, check the volume settings of your computer speakers and check the connections between your speakers and the computer.
  - In the **Device Manager**, check that the correct drivers are installed properly. To display the **Device Manager**, go to **Start > Control Panel > Performance and Maintenance**. Click the **System** icon and then the **Device Manager** button on the **Hardware** tab.
- A dirty or damaged disc may cause the computer to "hang" while it tries to read the disc. If necessary, reboot the computer, remove the disc and then check that it is not dirty or damaged.
- Check your PG settings (Parental Guidance) in the DVD software as they might be preventing you from playing certain DVDs when they are activated.



On your computer, the default DVD region code is 2. Do not change this setting using the **Region Code Change** function in Windows, or using any other software applications. System malfunctions originating from the user changing the DVD region code are beyond the scope of your warranty and will result in service charges for repair.

If you do not immediately see the **Display** icon after clicking **Control Panel**, click **Switch to Classic View** on the left.

### *I cannot play a DVD when using two screens*

- On PCG-K series, the following errors will occur when you use two screens at the same time (LCD and TV / LCD and CRT):
  - When you play a DVD with **Windows Media Player 10** or **VAIO Zone**, you can only watch the content on the primary display.
- You will not have a problem in the following situations:
  - When you use a CRT or an LCD display on its own.
  - When you play MPEG files which are recorded on the hard disk drive with **Windows Media Player 10** or **VAIO Zone**.

### *The reading speed of CD/DVD-RWs is very slow*

Generally, the reading speed of a CD/DVD-RW is slower than that of a -ROM or -R. The reading speed can also vary depending on the type of format.

### *The disc tray does not eject even when the eject button is pressed*

- Check that the computer is turned on.
- The CD-writing application software may be stopping the disc from being ejected.
- Make sure the computer is not in **Standby** or **Hibernate** mode.

### *The disc tray ejects even when it has been locked into place*

- Ensure that the disc is placed with the label side facing up.
- Clean the disc and the optical disc drive lens with an appropriate cleaner.
- The disc may be scratched. Place another disc to see if that is the reason.
- There may be condensation in the drive. Remove the disc and leave the drive open for approximately one hour. Remove the battery while you wait for the condensation to disappear.

## Using the A/V port replicator (VGN-A series)

Your VAIO computer comes with an A/V port replicator. Attaching the A/V port replicator\* enables you to connect additional peripherals to your computer, such as a printer and an external display.

\* Depending on your model. See the printed **Specifications** sheet for more information.

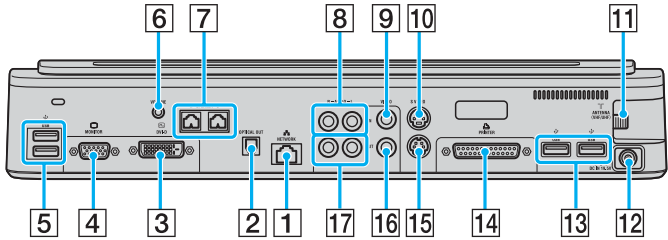

1	Network connector	<a href="#">(page 141)</a>	2	Optical out connector	<a href="#">(page 111)</a>	3	DVI-D connector	<a href="#">(page 107)</a>
4	Monitor/VGA connector	<a href="#">(page 107)</a>	5	2 Hi-Speed USB (USB2.0) connectors	<a href="#">(page 127)</a>	6	Volume connector	<a href="#">(page 58)</a>
7	Right/Left speaker connectors	<a href="#">(page 58)</a>	8	Right/Left audio in connectors	<a href="#">(page 52)</a>	9	Video in connector	<a href="#">(page 52)</a>
10	S-Video in connector	<a href="#">(page 52)</a>	11	Antenna (VHF/UHF) connector	<a href="#">(page 37)</a>	12	DC In connector	<a href="#">(page 14)</a>
13	2 Hi-Speed USB (USB2.0) connectors	<a href="#">(page 127)</a>	14	Printer connector	<a href="#">(page 133)</a>	15	S-Video out connector	<a href="#">(page 111)</a>
16	Video out connector	<a href="#">(page 111)</a>	17	Right/Left audio out connectors	<a href="#">(page 111)</a>			



The A/V port replicator can be powered only with the AC adapter supplied with your computer. Do not remove the AC adapter from the A/V port replicator or the AC outlet when using the A/V port replicator; this may cause data damage or hardware malfunctions.

When video cables are connected to S-Video out and Video out simultaneously, only the S-Video out connector can be used.

To connect an external video/audio source (such as a video camera, VCR or DVD player), proceed as follows:

- 1 Connect your video/audio device's video cable to the composite S-Video in (10) or Video in (9) connector, depending on the type of cable you are using\*.
- 2 Connect the left and right audio cables into the right (8) and left (8) audio in connectors.

\* You may have to purchase specific cables to connect specific devices like a VCR, Set top box or video camera to your computer.

## Attaching your computer to the A/V port replicator

To attach your computer to the A/V port replicator, proceed as follows:

- 1 Disconnect all peripherals from the computer.
- 2 Plug the power cord (1) into the AC adapter and an AC outlet.
- 3 Plug the cable attached to the AC adapter (2) into the DC In port (3) on the A/V port replicator (4).

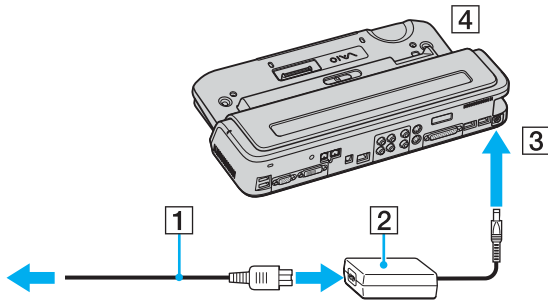

- 4 Open the A/V port replicator cover.

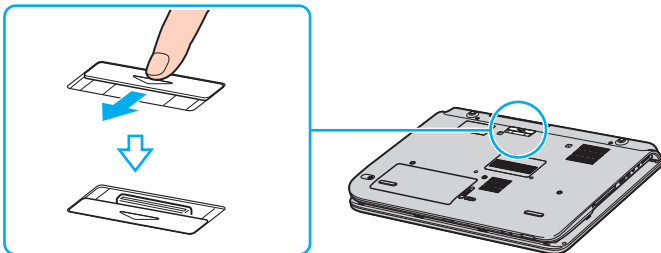

- 5 Align the bottom connector of the computer with the connector on the A/V port replicator and push down until it clicks into place.

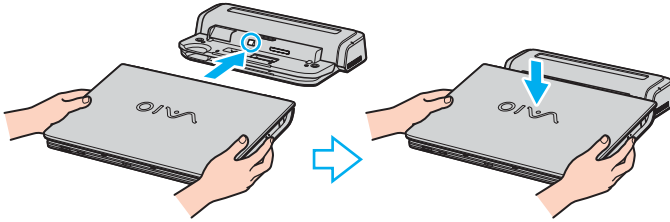

- 6 Slide the lock lever to **LOCK**.

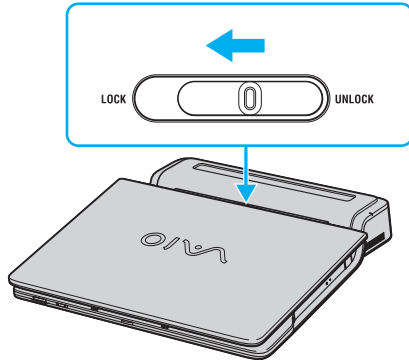

## 7 Turn on the computer.



When attaching your computer to the A/V port replicator, do not attempt to insert or remove the battery pack. Lifting and turning the computer with the attached A/V port replicator may cause a temporary loss of power.

Use the AC adapter that comes with your computer or the optional Sony adapter.



Do not move your computer while attached to the port replicator, as it may detach the port replicator and cause damage to the port replicator and the computer.

## Disconnecting your computer from the A/V port replicator

! Make sure to turn off your computer before disconnecting it from the port replicator to prevent loss of unsaved data.

To disconnect your computer from the A/V port replicator, proceed as follows:

- 1 Stop the connected peripherals.
- 2 Slide the lock lever to **UNLOCK**.

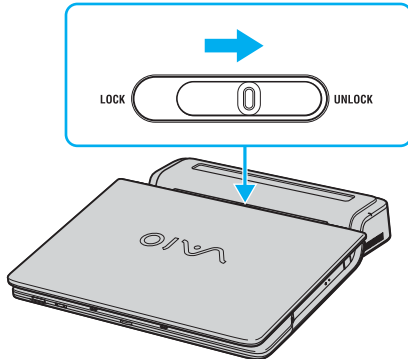

- 3 Lift the computer away from the A/V port replicator.

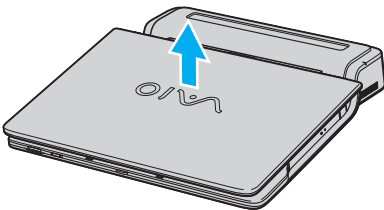



- 4 Close the A/V port replicator connector cover on the bottom of your computer.



It is extremely important to close the A/V port replicator connector cover after disconnecting your computer from the A/V port replicator. If the cover is left open, dust may get inside and damage the computer.

To disconnect your A/V port replicator completely from the mains voltage, unplug the AC adapter.

## Using the external speakers (VGN-A series)

Your VAIO computer comes with a pair of external speakers\* in order to make great use of the **VAIO Zone** software.

\* Depending on your model. See the printed **Specifications** sheet for more information.

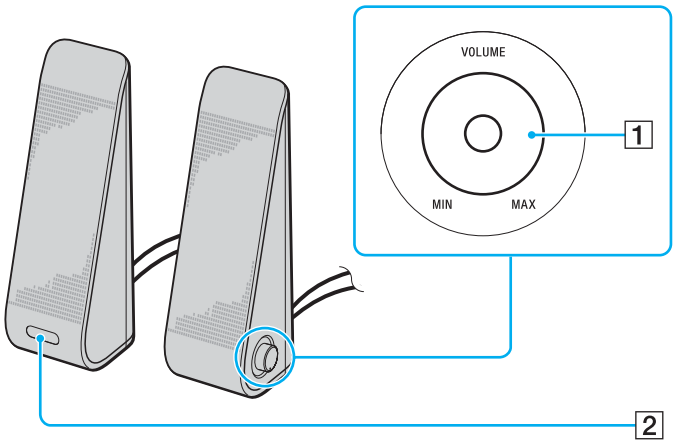

1	Volume control	The right speaker is equipped with the volume control. Turn this control clockwise or anticlockwise to adjust the speaker volume.	2	Infrared sensor for remote commander 	The left speaker is equipped with the infrared sensor for the remote commander. Point your remote commander to this sensor for operations.
---	----------------	---	---	---	--

## Connecting the supplied external speakers to the audio port replicator

Connect the supplied external speakers to the audio\* or AV\* port replicator attached to your computer.

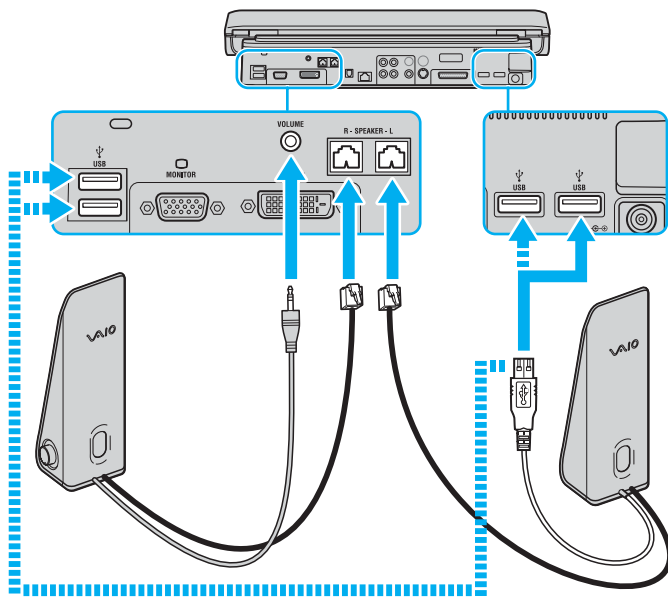

To use the supplied remote commander to control the volume, make sure to connect the USB cable from the left speaker to one of the USB connectors on the audio\* or AV\* port replicator.

Make sure to place the external speakers on a flat location with sufficient space to keep them from falling and dropping.

Do not grasp the depression on the front of the speaker to take hold of it.

\* Depending on your model. See the printed **Specifications** sheet for more information.

## *Using the remote commander (VGN-A series)*

Your VAIO computer comes with a remote commander\* in order to make great use of the **VAIO Zone** software.



The infrared sensor for the remote commander is located on the left external speaker. Make sure to attach your computer to the supplied A/V port replicator and connect the supplied speakers to your computer before using the remote commander.

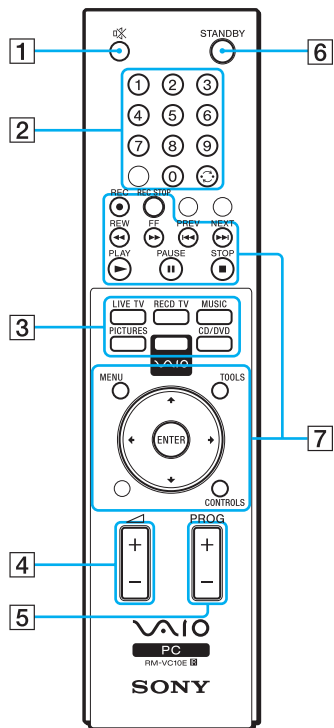

1	MUTING button	Turns off the external speakers. Press the MUTING button to turn on the speakers.	2	Channel buttons	Select the respective channels.
3	Direct buttons	Activate individual features of <b>VAIO Zone</b> .	4	Volume button	Increases** or decreases the speaker volume.
5	Channel control button	Switches the channel in the ascending or descending order.	6	STANDBY button	Puts the system into Standby mode.
7	Operation buttons	Use these buttons for <b>VAIO Zone</b> operations.			

\* Depending on your model. See the printed **Specifications** sheet for more information.

\*\* With the remote commander, you can increase the volume only up to the level set by the volume control on the external speaker.

## Using PC Cards

Your VAIO computer is equipped with a PC Card slot. PC Cards allow you to connect portable external devices. You do not need to shut down your computer before inserting or removing a PC Card.

### Inserting a PC Card

To insert a PC Card, proceed as follows:

- 1 Insert the PC Card into the PC Card slot with the front label facing upwards.
- 2 Gently push the PC Card into the connector.  
The PC Card is automatically detected by your system.  
The **Safely Remove Hardware** icon appears in the system tray.

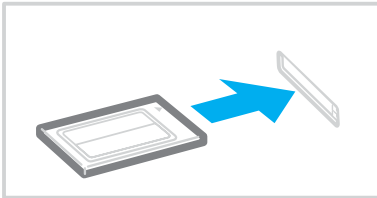



Some devices may not function properly if you repeat returning to Normal mode from Standby mode or Hibernate mode.

The computer will return to its original state if you restart it.

Make sure you use the most recent software driver provided by the PC Card manufacturer.

If an "!" mark appears on the **Device Manager** tab in the **System Properties** dialog box, remove the software driver and then reinstall it.

Do not force a PC Card into the slot. It may damage the connector pins. If you have difficulty inserting a PC Card, check that you are inserting the PC Card in the correct direction. See the manual supplied with your PC Card for more information on use.

For some PC Cards, if you alternate between **Normal** power operation and **Standby** or **Hibernate** power management modes while the card is inserted, you may find that a device connected to your system is not recognised. Restart your system to correct the problem.

Do not carry your computer while touching the head of a PC Card, as pressure or shock may damage the connector pins.



## Removing a PC Card

Follow the steps below to remove the PC Card while your computer is on. If it is not removed properly, your system may not work properly. If you want to remove a PC Card when your computer is off, skip steps 1 to 7.

To remove a PC Card, proceed as follows:

- 1 Double-click the **Safely Remove Hardware** icon in the system tray.  
The **Safely Remove Hardware** dialog box appears.
- 2 Select the hardware you want to unplug.
- 3 Click **Stop**.
- 4 In the **Stop a Hardware Device** dialog box, confirm that the device can be safely removed from the system.
- 5 Click **OK**.  
A dialog box appears, explaining that it is safe to remove the device.
- 6 Click **OK**.
- 7 Click **Close**.
- 8 Push the PC Card release button so that the release button pops out.
- 9 Push the PC Card release button a second time so that the PC Card pops out.
- 10 Gently take hold of the Card and pull it out of the slot.
- 11 If the PC Card release button is still out, push it back in.



If you remove the PC Card from the computer when it is still turned on, your system might crash and you might lose data that you did not save before.

Before you remove the PC Card, click the PC Card icon on the taskbar and close the card. Close any applications that use the PC Card before removing the card. Otherwise, data may be lost.

While the card is inserted, your computer may not enter the **Hibernate** power management mode. It may enter **Standby** mode. It is recommended that you remove the card before your computer enters **Hibernate** mode by pressing the <Fn>+<F12> keys, and when it is set to enter **Hibernate** automatically while using a battery as the source of power.

Some PC Cards or their functions may not be compatible with your computer.

## *Troubleshooting PC Cards*

### *My PC Card is not working*

Make sure the PC Card is compatible with your version of Windows.

## Using the Memory Stick

Your VAIO computer is designed to support the Memory Stick. The Memory Stick is a compact, portable, and versatile device especially designed for exchanging and sharing digital data with compatible products, such as digital cameras and mobile phones. Because it is removable, it can be used for external data storage.

Use the flash memory technology to download anything that can be converted into digital data, such as pictures, music, words, sounds, movies and photographs. The Memory Stick family ranges in capacity and compatibility.

See the printed **Specifications** sheet to see which Memory Stick types are compatible with your VAIO and if there are any limitations.

- You can purchase Memory Sticks from the Sony Style website ([www.sonystyle-europe.com](http://www.sonystyle-europe.com)), or from your local Sony dealer.
- Detailed information about which VAIO computers are compatible with which Memory Sticks can be found here: [www.vaio-link.com](http://www.vaio-link.com).

## Write-protecting a Memory Stick

**Some Memory Sticks** are designed with an erasure prevention switch to protect valuable data from accidental erasure or overwriting.

Move the tab horizontally or vertically\* to set or release write-protection. When the erasure prevention switch is off, data can be saved on the Memory Stick. When the erasure prevention switch is on, data can be read from but not saved on the Memory Stick.

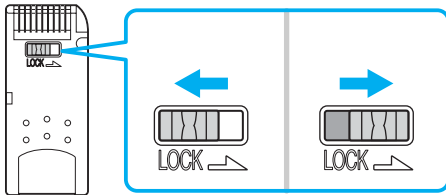

\* Some kinds of Memory Stick do not have an erasure prevention switch.

## Inserting a Memory Stick

There are two ways you can insert a Memory Stick in your computer:

- Using the Memory Stick slot;
- Using a PC Card slot. To do this, you need an optional PC Card adapter.

You can only insert one Memory Stick at a time.

To insert a Memory Stick using the Memory Stick slot, proceed as follows:

- 1 Once you have stored your data from your digital device, insert the Memory Stick with the arrow facing up and toward the Memory Stick slot.
- 2 Carefully slide the Memory Stick into the slot until it clicks in place.  
The Memory Stick is automatically detected by your system and appears in your **My Computer** window as a local drive, under the appropriate letter (depending on the configuration of your computer).

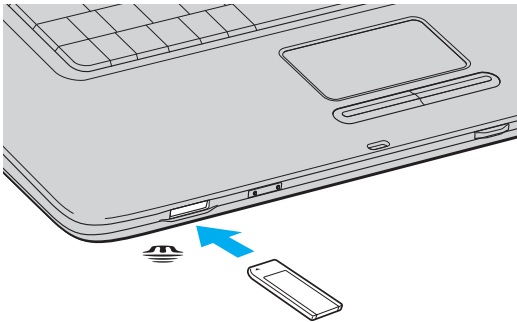



The location of the Memory Stick slot depends on the model of your computer. See the **Specifications** sheet for details on your model.



Hold the Memory Stick with the arrow pointing in the correct direction when you insert it into the slot. To avoid damaging the computer or the Memory Stick, do not force the Memory Stick into the slot if it does not insert smoothly.



VGN-A series supports Memory Stick Duo. For more information on Memory Stick Duo, visit the [Memory Stick](#) website.



Do not insert the Memory Stick and the Memory Stick Duo together into the Memory Stick slot of your computer, as it may damage the slot as well as the Memory Stick and the Memory Stick Duo.

## Removing a Memory Stick

To remove a Memory Stick using the Memory Stick slot, proceed as follows:

- 1 Check that the Memory Stick indicator is off.
- 2 Push in the Memory Stick towards the computer.  
The Memory Stick ejects.
- 3 Pull the Memory Stick out of the slot.



Always remove the Memory Stick gently, or it may pop out unexpectedly.

Do not remove the Memory Stick while the Memory Stick indicator is turned on. If you do, you may lose data. Loading large volumes, for example, image clips, may take a while.

## Using the modem

Your VAIO computer is equipped with an internal modem.

You need to connect to a phone line to take advantage of online services and the Internet, as well as to register your computer and software online, and to contact VAIO-Link.

To connect a phone line, proceed as follows:

- 1 Plug one end of the phone cable (1) into the modem connector  on the computer.
- 2 Plug the other end into the wall jack (2).

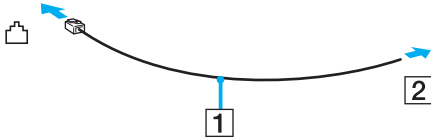

## Troubleshooting the modem

### *My modem does not work or cannot establish a connection*

- Check that the phone line is plugged into your computer.
- Make sure that the modem is the only device connected to your phone line.
- Check that the phone line is working. You can check the line by plugging in an ordinary phone and listening for a dial tone.
- Check that the phone number the program is dialling is correct. The modem dialling mode may be incompatible with your telephone line.
- The modem may not work properly if you are with a Private Automatic Branch eXchange (PABX).
- In the **Phone and Modem Options** dialog box (**Control Panel / Printers and Other Hardware / Phone and Modem Options**), check that your modem is listed on the **Modems** tab, and that the location information is correct on the **Dialing Rules** tab. If you do not see the **Phone and Modem Options** icon, click **Switch to Classic View** on the left side.
- We recommend you use country-specific phone plug to plug the phone line into the wall jack, because use of any other phone plug can decrease the connection quality.
- Your computer cannot be connected to a coin-operated telephone, and may not work with multiple phone lines or a private branch exchange (PBX). If you connect the modem to a parallel connected phone line, the modem or the other connected device may not function properly. Some of these connections may result in excess electrical current and could cause a malfunction in the internal modem.
- Only DTMF (Dual Tone Multi Frequency) signalling (tone dialling) is supported.
- The internal modem is intended to be used for data and fax communications using DTMF (Dual Tone Multi Frequency) signalling (tone dialling) on the PSTN (Public Switched Telephone Network) networks in the following countries: Austria, Belgium, Czech Republic, Denmark, Finland, France, Greece, Germany, Iceland, Ireland, Italy, Luxembourg, Norway, Portugal, Spain, Sweden, Switzerland, the Netherlands and the United Kingdom.
- Before using the modem, it will be necessary to select the country where you are actually using it. The detailed procedure for selecting your present location is explained in **Configuring your modem** ([page 146](#)).
- If your computer is equipped with the flexible modem connector cover, do not pull it too forcefully.

### *My modem connection is slow*

Many factors influence modem connection speed, including telephone line noise or compatibility with telephone equipment (such as fax machines or other modems). If you think your modem is not connecting properly to other PC-based modems, fax machines, or your Internet Service Provider, check the following:

- Have your phone company check that your phone line is free from any line noise.
- If your problem is fax-related, check that there are no problems with the fax machine you are calling and that it is compatible with fax modems.
- If you are having a problem connecting with your Internet Service Provider, check that the ISP is not experiencing technical problems.
- If you have a second phone line available, try connecting the modem to that line.



## Using the Bluetooth functionality (VGN-A series)

If your VAIO computer is equipped with the Bluetooth functionality\*, you can establish wireless communication between your computer and other Bluetooth devices such as another computer or a mobile phone. You can transfer data between these devices without cables and up to 10 metres range in open space.

\* Depending on your model. See the printed **Specifications** sheet for more information.

To connect to a Bluetooth device, proceed as follows:

- 1 Turn on the **Wireless** switch.  
The **Switch wireless devices** dialog box appears.
- 2 Select the **Bluetooth** option.
- 3 Click **OK**.



Read the **Regulations Guide** before using the Bluetooth functionality.

The 2.4 GHz band with which Bluetooth devices or wireless LAN devices work, is used by various devices. Bluetooth devices use the technology to minimize the interference from other devices that use the same wave length. Communication speed and distances can be inferior to the standard values. Interference from other devices may also stop communications. Do not simultaneously use the Bluetooth function and wireless communication devices which use the 2.4 GHz band, such as a wireless LAN PC Card.



The Bluetooth functionality may not work depending on the third party devices or the software version used by third party companies.



When you purchase Bluetooth devices, check their operating conditions.

## *Bluetooth security*

The Bluetooth wireless technology has an authentication function, which allows you to make sure with whom you communicate. With the authentication function, you can avoid any anonymous Bluetooth device to access your computer.

The first time two Bluetooth devices communicate, a common **Paskey** (a password required for authentication) should be determined for both devices to be registered. Once a device is registered, there is no need to re-enter the **Paskey**.

You can change your settings in order not to be discovered by other Bluetooth devices or you can set a limit.

## Communicating with another Bluetooth device

You can connect your computer to a Bluetooth device such as another computer or a mobile phone without any cables.

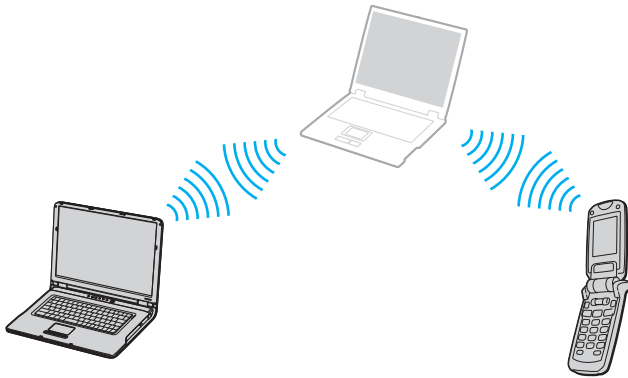

To communicate with another Bluetooth device, proceed as follows:

- 1 Turn on the **Wireless** switch.
- 2 Choose **Start > Control Panel > Network and Internet Connections > Bluetooth Devices**.  
The **Bluetooth Device** dialog appears.
- 3 Click **Add**.  
The **Add Bluetooth Device Wizard** appears.
- 4 Select the check box **My device is set up and ready to be found** and then click **Next**.
- 5 Select the remote device you want to connect to. If necessary, scroll up and down in the **Bluetooth Device List** to make your selection. Then click **Next**.
- 6 Choose one of the following options:
  - If you want Windows to provide you with a password, select **Choose a Passkey for me**.

- If the documentation of the other bluetooth device contains a password, click **Use the passkey found in the documentation** and enter the passkey.
- If you want to create your own passkey, click **Let me use my own passkey** and enter a passkey.
- If your device does not use a passkey, click **Don't use a passkey**.

7 Click **Next** to continue.

8 Once the remote device has been successfully authenticated, click **Finish**.



Do not simultaneously use the Bluetooth functionality and wireless communication devices which use the 2.4 GHz band such as a wireless LAN PC Card.

The passkey can be different each time, but must be the same at both ends.

For certain devices, such as a mouse, no passkey can be entered.

## *Communicating with another Bluetooth device using the Bluetooth File Transfer Wizard*

You can easily transfer data, such as files or pictures, to another Bluetooth device.

To transfer data from or to another Bluetooth device, proceed as follows:

- 1 Choose **Start > All Programs > Accessories > Communications > Bluetooth File Transfer Wizard**. The **Bluetooth File Transfer Wizard** appears.
- 2 Click **Next** to continue.
- 3 Follow the steps in the **Bluetooth File Transfer Wizard** to communicate with another Bluetooth device.



Do not simultaneously use the Bluetooth functionality and wireless communication devices which use the 2.4 GHz band such as a wireless LAN PC Card.

The passkey can be different each time, but must be the same at both ends.

For certain devices, such as a mouse, no passkey can be entered.

## *Connecting to a network with Bluetooth device*

With Bluetooth connections, you can join a personal area network (PAN), which is an Internet Protocol (IP)-based network.

- 1 Turn on the **Wireless** switch.
- 2 Choose **Start > Control Panel > Network and Internet Connections > Network Connections > Bluetooth Network Connection**. The **Bluetooth Personal Area Network Device** dialog appears.
  - If you wish to connect to a Bluetooth device that is not displayed, click **Add**.
  - If you wish to connect to a displayed Bluetooth device, select the device's icon and click **Connect**.
- 3 Follow the wizard to set up the connection.

## Stopping the Bluetooth connection

To stop the Bluetooth connection, turn off the **Wireless** switch. The Bluetooth LED turns off.

### Additional information

- The data transfer rate varies, depending on the following conditions:
  - Obstacles, such as walls, located between devices
  - Distance between devices
  - Material used in walls
  - Proximity to microwaves and cordless telephones
  - Radio frequency interference and other environmental conditions
  - Device configuration
  - Type of software application
  - Type of operating system
  - Use of both Wireless LAN and Bluetooth functionalities at the same time on the computer
  - Size of file being exchanged
- The 2.4 GHz radio frequency used by Bluetooth<sup>®</sup> and wireless LAN devices is also used by other devices. Bluetooth devices incorporate technology that minimizes interference from other devices using the same wavelength, however, communication speed and connection range may be reduced. Interference from other devices may also stop communication altogether.
- Please note that due to limitations of the Bluetooth standard, large files may occasionally be corrupted during continuous transfer due to electromagnetic interference from the environment.
- All Bluetooth devices must be certified to make sure that the applicable standard requirements are maintained. Even if standards are met, individual device performance, specifications, and operation procedures can vary. Data exchange may not be possible in all situations.

## *Troubleshooting the Bluetooth functionality*

### *I cannot use the Bluetooth functionality*

- If the Bluetooth LED is off, turn on the **Wireless** switch.
- You cannot use the Bluetooth functionality when the computer is in a power saving mode. Return to normal mode, then turn on the **Wireless** switch located on your computer.

### *The connected device does not appear in the Bluetooth Device List*

If the connected device is also connected to other devices, it may not appear on the **Devices** tab in the **Bluetooth Device** dialog or you may not be able to communicate with the device.

### *I cannot find the Bluetooth device with which I want to communicate*

- Check that the Bluetooth functionality of the device with which you want to communicate is on. See the other device's manual for more details.
- If the device with which you want to communicate is already communicating with another Bluetooth device, it may not be found or it may not be able to communicate with your computer.
- To allow other Bluetooth devices to communicate with your computer, go to the **Options** tab in the **Bluetooth Device** dialog and select the check box **Allow Bluetooth devices to connect to this computer**.  
For more information on the Bluetooth Device dialog, see **Communicating with another Bluetooth device (page 75)**.

### *The data transfer speed is slow*

The data transfer speed depends on the obstacles and/or the distance between the two devices, but also on the radio wave quality, the operating system or the software used. Try to move your computer or try to place the two devices closer.

### *I cannot communicate with the other device although the distance between both devices is within 10 metres*

- The data transfer distance can be shorter than 10 metres depending on existing obstacles between the two devices, on radio wave quality, on the operating system or the software used. Try to move your computer or to place both devices closer.
- If the device with which you want to communicate is already communicating with another Bluetooth device, it may not be found or it may not be able to communicate with your computer.
- Check that the Bluetooth functionality of the device with which you want to communicate is on. See the other device's manual for more details.

### *File transmission and reception fail.*

When transmitting a file with the **Bluetooth File Forwarding Wizard**, the receiving device must be set beforehand to receive incoming transmissions.

To set a device to receive incoming transmissions, proceed as follows:

- 1 Start the computer and turn on the Bluetooth device.
- 2 Choose **Start > All programs > Accessories > Communications > Bluetooth File Forwarding Wizard**.
- 3 Click **Next**, select the check box next to **Receive files**, and click **Next** again.



*The message The Bluetooth device requires authentication appears in the notification area.*

The target Bluetooth enabled device is requesting connection authentication. Mutual authentication is required to enable Bluetooth communications with this device.

*Cannot connect to service supported by target Bluetooth device.*

Connection is only possible for services also supported by the computer equipped with the Bluetooth functionality. For more details, refer to the **Bluetooth Device** Help in Windows XP and/or the operating instructions or electronic manual for the targeted Bluetooth device.

*Unable to exchange business card data with a cellular phone.*

The business card exchange function is not supported.

## Using Wireless LAN (WLAN)

Thanks to Sony's Wireless LAN (WLAN), all your digital devices with built-in WLAN functionality communicate freely with each other through a powerful network. A WLAN is a network in which a mobile user can connect to a local area network (LAN) through a wireless (radio) connection. So there is no need anymore to pull cables or wires through walls and ceilings.

The Sony WLAN supports all normal Ethernet activities, but with the added benefits of mobility and roaming. You can still access information, internet/intranet and network resources, even in the middle of a meeting, or as you move from one place to another.

PCG-K series is provided with the wireless LAN functionality that complies with the IEEE 802.11b/g standards and the Super G technology developed by Atheros Communications, Inc. for faster wireless LAN communications among compatible devices.

You can communicate **without an Access Point**, this means that you can communicate between a limited number of computers (**ad-hoc**), or you can communicate **through an Access Point**, which allows you to create a full infrastructure network (**infrastructure**).



In some countries, using WLAN products may be restricted by the local regulations (e.g. limited number of channels). Therefore, before activating the WLAN functionality, read the **Wireless LAN Regulation** carefully. Channel selection is explained further in this manual (see **Wireless LAN channel selection (page 89)**).

WLAN uses the IEEE 802.11b/g standard, which specifies the used technology. The standard includes the encryption method: **Wired Equivalent Privacy (WEP)**, which is a security protocol and **WiFi Protected Access (WPA - Proposed jointly by the IEEE and Wi-Fi Alliance, WiFi Protected Access is a specification of standards based, interoperable security enhancements that increase the level of data protection and access control for existing WiFi networks. WPA has been designed to be forward compatible with the IEEE 802.11i specification. It utilizes the enhanced data encryption TKIP (Temporal Key Integrity Protocol) in addition to user authentication using 802.1X and EAP (Extensible Authentication Protocol)). Data encryption protects the vulnerable wireless link between clients and Access Points. Besides that, there are other typical LAN security mechanisms to ensure privacy, such as: password protection, end-to-end encryption, virtual private networks, and authentication.**

Wireless LAN devices using the IEEE 802.11a standard and the ones using the IEEE 802.11b or g standard cannot communicate because the frequencies are different. Wireless LAN devices using the IEEE 802.11g standard can only communicate with a device using the IEEE 802.11b standard, not with the IEEE 802.11a standard.

IEEE 802.11b: The standard speed is 11 Mbps, or about 30 to 100 times faster than a standard dial up.

IEEE 802.11g: The standard speed is 54 Mbps, or about 5 times faster than a Wireless LAN device using the IEEE 802.11b standard. (On PCG-K series, you will only achieve this speed when working exclusively on 802.11g mode and not in a mixed b/g mode).

## Communicating without Access Point (ad-hoc)

An ad-hoc network is a network in which a local network is created only by the wireless devices themselves, with no other central controller or Access Point. Each device communicates directly with other devices in the network. You can set up an ad-hoc network easily at home.

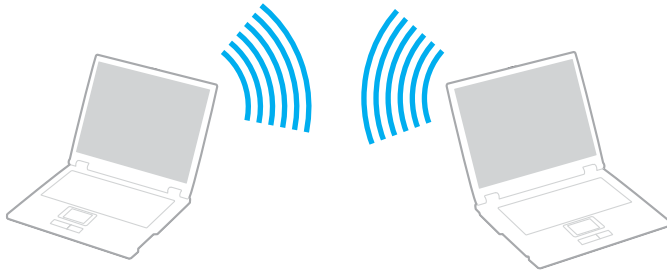

To communicate without Access Point (ad-hoc), proceed as follows:

- 1 Turn on the **Wireless** (VGN-A series) or **Wireless LAN** (PCG-K series) switch.  
On VGN-A series, the **Wireless Device Switch** dialog box appears.  
Select the **Enable 2.4 GHz Wireless LAN** check box and deselect the **Enable Bluetooth Device** check box, then click the **OK** button.
- 2 Double-click the network icon on the taskbar displaying **Wireless Network Connection**.  
The **Wireless Network Connection** dialog box appears.
- 3 Click the **Change advanced settings** button.  
The **Wireless Network Connection Properties** dialog box appears.
- 4 Select the **Wireless Networks** tab.
- 5 Click the **Add...** button.  
The **Wireless network properties** dialog box appears.

- 6** Enter a **Network name (SSID)\***.  
You can choose a **32-digit** alphanumeric name.
- 7** Select **Open** from the **Network Authentication** drop-down box.
- 8** Select **WEP** from the **Data Encryption** drop-down box.
- 9** Deselect the **The key is provided for me automatically** option button.  
Some information becomes visible.
- 10** Fill in the **Network key\***.  
The network key should be **5 or 13 alphanumeric characters** or **10 or 26 hexadecimal\*\* characters** long. You can choose whatever you want.
- 11** Fill in exactly the same **Network key** again, for confirmation.
- 12** Select the check box **This is a computer-to-computer (ad hoc) network; wireless access points are not used** at the bottom of the screen.
- 13** Click **OK**.  
Your **Network name** appears in the **Preferred networks**.
- 14** Click **Advanced**.  
The **Advanced** dialog box appears.
- 15** Select the **Computer-to-computer (ad hoc) networks only** option button.
- 16** Click **Close**.
- 17** Click **OK**.  
Your computer is ready to communicate with another computer.

\* If you want to communicate between two or more computers, you need to configure all these computers the exact same way. This means that you need to enter the same **Network name** and the same **Network key** on all computers as on the first computer you configure.

\*\* **Hexadecimal**: A number representation using the digits 0-9, with their usual meaning, plus the letters A-F (or a-f) to represent hexadecimal digits with values of (decimal) 10 to 15.



An ad-hoc network does not support WPA.

The Super G technology on PCG-K series is not available in Ad hoc mode.



In France, only certain channels are legally allowed when using WLAN outdoors. For more information, see the **Wireless LAN Regulations**.

## Communicating with an Access Point (infrastructure)

An infrastructure network is a network that extends an existing wired local network to wireless devices by providing an Access Point, for example the **Sony Access Point**. The Access Point bridges the wireless and wired LAN and acts as a central controller for the Wireless LAN. The Access Point coordinates transmission and reception from multiple wireless devices within a specific range.

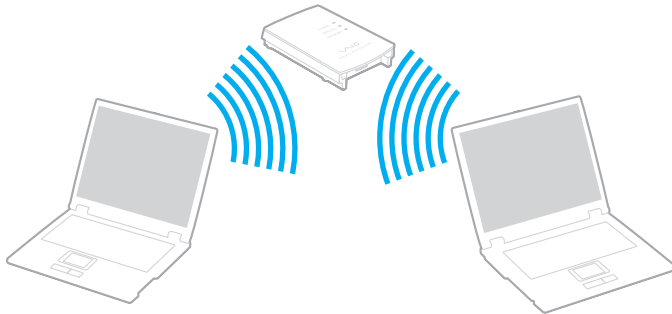

If the destination wireless LAN access point complies with the Super G technology and is configured for it, the Super G technology is automatically activated on PCG-K series when a connection is established with the wireless LAN access point.

To communicate with an Access Point (infrastructure), proceed as follows:

- 1 Turn on the **Wireless** (VGN-A series) or **Wireless LAN** (PCG-K series) switch.  
On VGN-A series, the **Wireless Device Switch** dialog box appears.  
Select the **Enable 2.4 GHz Wireless LAN** check box and deselect the **Enable Bluetooth Device** check box, then click the **OK** button.
- 2 Right-click the network icon  on the taskbar displaying the **Wireless Network Connection** message.
- 3 Click **View Available Wireless Networks**.  
The **Wireless Network Connection** dialog box appears.

- 4 Select the network you want to use.
- 5 Type the **Network Key**.  
If you are using the **Sony Access Point**, by default, you don't need to enter any encryption key (WEP/WPA). To be able to communicate, you must select the box **Allow me to connect to the selected wireless network, even though it is not secure**.
- 6 Click **Connect**.  
After 30 seconds, the connection is established.

For more information about setting up an access point, see the documentation supplied with your **Access Point**.



The WPA key needs to contain at least 8 characters.

## Using the WiFi protected access (WPA)

WPA is a wireless security enhancement that allows you to transfer data in a highly secure way\*.

\* For more information on the access point, refer to the documentation that came with your access point.

To use WPA on your computer, proceed as follows:

- 1 Turn on the **Wireless** (VGN-A series) or **Wireless LAN** (PCG-K series) switch.  
On VGN-A series, the **Wireless Device Switch** dialog box appears.  
Select the **Enable 2.4 GHz Wireless LAN** check box and deselect the **Enable Bluetooth Device** check box, then click the **OK** button.
- 2 Right-click the network icon on the taskbar displaying **Wireless Network Connection**.
- 3 Select **View available network connections**.  
The **Wireless Network Properties** dialog box appears.
- 4 Select the wireless network to which you want to connect.
- 5 Fill in the **Network key**.  
The network key should be at least 8 characters long. You can choose whatever you want.
- 6 Fill in exactly the same **Network key** again, for confirmation.
- 7 Click **Connect**.  
The connection is established.



In Ad-hoc mode, WPA security cannot be used (specifications in the standard itself).



In France, only certain channels are legally allowed when using WLAN outdoors. For more information, see the **Wireless LAN Regulations**.



## Wireless LAN channel selection

In a 802.11b/g configuration, channel 1 to 13 can be used.

### (a) With an access point ("Infrastructure")

- The channel used will be the channel selected by the access point.

! For details on how to select the channel that will be used by the access point, refer to the documentation that came with your access point.

### (b) Without access point ("Ad-Hoc")

- If the Wireless connection is initiated by the VAIO computer, channel 11 will be selected.

! In France, only certain channels are legally allowed when using WLAN outdoors. For more information, see the **Wireless LAN Regulations**.

- If the Wireless connection is initiated by a peer Wireless LAN equipment, the Wireless LAN communication will make use of the channel selected by the peer Wireless LAN equipment.

! The 2.4 GHz bandwidth used by wireless LAN compatible devices is also used by other various devices. Although technologies to minimize interference from other devices that uses the same bandwidth are employed on wireless LAN compatible devices, such interference may cause lower communication speed, narrower communication range, or broken wireless connections.

The communication speed varies depending on the distance between communication devices, existence of obstacles between such devices, the device configuration, the radio conditions, and the software in use. In addition, communications may be cut off depending on the radio conditions.

The communication range varies depending on the actual distance between communication devices, existence of obstacles between such devices, the radio conditions, the ambient environment that includes existence of walls and materials of such walls, and the software in use.

Deploying IEEE 802.11b and IEEE 802.11g products on the same wireless network may reduce the communication speed due to radio interference. Taking this into consideration, the IEEE 802.11g products are designed to reduce the communication speed to ensure communications with IEEE 802.11b products. When the communication speed is not as fast as expected, changing the wireless channel on the access point may increase the communication speed.

## Troubleshooting Wireless LAN

### *I cannot use the Wireless LAN functionality*

Check if the **Wireless** (VGN-A series) or **Wireless LAN** (PCG-K series) switch is turned on.

### *The Wireless LAN Access Point and your computer cannot communicate*

- Check if the **Wireless** (VGN-A series) or **Wireless LAN** (PCG-K series) switch is turned on.
- Check if the power of the Access Point is turned on.
- Check if the Access Point is displayed in the **Available networks** window.
  - To check this, click Start and then **Control Panel**.
  - Click **Network and Internet Connections**.
  - Click the **Network Connections** icon.
  - Right-click the **Wireless Network Connection** icon and select **Properties**.
  - Select the **Wireless Networks** tab.
  - Check if the Access Point is displayed in **Available networks**.
  - Connection availability is affected by distance and obstructions. You may need to move your computer away from obstructions or neared to any Access Point you may be using.

### *The data transfer speed is slow*

- ❑ The maximum communication speed can vary depending on the obstacles or the distance between the communication devices, the radio waves, the operating system or the software you use. Remove the obstacle or make the distance between the Access Point and your machine smaller.
- ❑ It is possible that your Access Point communicates at the same time with another Access Point. Read the manual of the Access Point.
- ❑ If several computers communicate with the same Access Point, the concentration may be too high. Wait a few minutes and try to access again.
- ❑ If a Wireless LAN device using the IEEE 802.11g standard communicates with a device using the IEEE 802.11b standard, then it is normal that the speed reduces. In general, devices using the IEEE 802.11g standard are 5 times faster than the ones using the IEEE 802.11b standard, but this does not apply to PCG-K series.

### *I cannot access the Internet*

- ❑ Check the settings of the Access Point. See the manual of the Access Point.
- ❑ Check if your computer and the Access Point are communicating.
- ❑ Make the distance between the Access Point and your machine smaller.

## *I cannot use a Wireless LAN network*

Check if the **Wireless Zero Configuration** service is active.

To check the status of the **Wireless Zero Configuration service**, proceed as follows:

- 1 Click **Start** and then **Control Panel**.  
The **Control Panel** window appears.
- 2 Click the **Performance and Maintenance** icon.
- 3 Click the **Administrative Tools** icon.
- 4 Double-click the **Services** icon.  
The **Services** window appears.
- 5 Check **Status** and **Startup Type** for **Wireless Zero Configuration**.  
When **Started** and **Automatic** are shown under **Status** and **Startup Type**, respectively, the **Wireless Zero Configuration** service is active.

To activate the **Wireless Zero Configuration service**, proceed as follows:

- 1 On the **Services** window, right-click **Wireless Zero Configuration** and click **Properties**.  
The **Wireless Zero Configuration Properties** window appears.
- 2 Select **Automatic** for **Startup type** and click **Apply**.
- 3 Click **Start** under **Service status**.
- 4 Click **OK** to close the window.

## Using power saving modes

When you use a battery as the source of power for your computer, you can take advantage of power management settings to conserve battery life. In addition to the normal operating mode, which allows you to turn off specific devices, your computer has two distinct power saving modes: **Standby** and **Hibernate**. When using battery power, you should be aware that the computer automatically enters **Hibernate** mode when the remaining battery charge becomes short, regardless of the power management setting you select.



If the battery level falls below 10 percent, you should either attach the AC adapter to recharge the battery or shut down your computer and insert a fully charged battery.

### Using Normal mode

This is the normal state of your computer when it is in use. The green power indicator light is on in this mode. To save power while not working, you can turn off a specific device such as the LCD or the hard disk.

### Using Standby mode

Standby mode turns off the LCD screen and sets the hard disk and the CPU to a low power consumption mode. The amber power light flashes in this mode.

To activate Standby mode, proceed as follows:

Go to **Start/Turn Off Computer** and click **Stand By**.

To return to **Normal** mode, press any key.



If you press the power button for more than four seconds, the computer will switch off automatically. You will lose any unsaved data.

When the computer is in **Standby** mode, you cannot insert a disc.

The computer comes out of **Standby** mode quicker than out of **Hibernate** mode.

**Standby** mode uses more power than **Hibernate** mode.

If the battery runs down when your computer enters **Standby** mode, you will lose any unsaved data. Going back to the previous work state is impossible. To avoid loss of data, you should save your data frequently.

If the computer is not used for 25 minutes, it will enter System Standby mode when running on AC power. When running on batteries, the computer also will enter **System Standby** mode after 25 minutes if unused. To avoid this, you can change the settings in the **Power Options Properties** screen (right-click the **power status** icon on the taskbar - select **Adjust Power Properties** - select the **Power Schemes** tab and change the settings in **Settings for VAIO optimized power scheme**).

## *Using Hibernate mode*

The state of the system is saved on the hard disk and power is turned off. Even when the battery runs down, no data will be lost. The power indicator light is off in this mode.

To activate Hibernate mode, proceed as follows:

Press <Fn>+<F12>.

The **Hibernating** screen appears and the computer enters **Hibernate** mode.

Alternatively,

Click **Start**, and then **Turn Off Computer**.

In the **Turn off computer** screen, hold down the <Shift> key and click **Hibernate**.

To return to Normal mode, proceed as follows:

Turn on the computer by pressing the power button.

The computer returns to its previous state.



If you press the power button for more than four seconds, the computer will switch off automatically.

If you do not use the AC adapter for a long period of time, put your computer into **Hibernate** mode. This power saving mode saves you the time of shutting down in the normal way.

When the computer is in **Hibernate** mode, you cannot insert a disc.

**Hibernate** mode requires more time than **Standby** mode to be activated.

It takes more time to return to **Normal** mode from **Hibernate** mode than from **Standby** mode.

**Hibernate** mode uses less power than **Standby** mode.

Do not move the computer until its power indicator turns off.

## *Troubleshooting power management*

### *The power management setting is not responding*

Your computer's operating system may become unstable if a lower power state, such as **Hibernate** is initiated, and then changed before the computer completely enters the lower power state.

To restore the computer to its normal operating stability, proceed as follows:

- 1 Close all open applications.
- 2 Press <Ctrl>+<Alt>+<Delete> simultaneously and select **Restart** from the shut down menu drop-down list.  
The computer restarts.
- 3 If the procedure does not work, press and hold the power button for four seconds or longer to shut down the computer.

## *Managing power with VAIO Power Management*

Power management helps you to set up power schemes of your computer that is running on AC power or batteries to suit your requirements for power consumption.

VAIO Power Management is a software application developed exclusively for VAIO computers. With this software application, you can enhance the Windows power management functions to ensure better operations of your computer and for longer battery life.

### *Activating VAIO Power Management*

When you start the computer, a **power status** icon appears on the taskbar. This icon indicates what kind of power source you are using at that time, e.g., AC power. If you double-click this icon, the **Power Meter** screen appears showing you the power status.

VAIO Power Management functionalities are added to the Windows **Power Options Properties**.

To activate VAIO Power Management, proceed as follows:

- 1 Right-click the **power status** icon on the taskbar.
- 2 Select **Adjust Power Properties**.  
The **Power Options Properties** window appears.
- 3 Select the **VAIO Power Management** tab.



## Activating VAIO Power Management power schemes

VAIO Power Management provides several predefined **power schemes**. Each power scheme consists of a group of power management settings that are designed to meet specific power management goals, ranging from maximum power management to no power management.

To activate a VAIO Power Management power scheme, proceed as follows:

- 1 Open **Adjust Power Properties**.
- 2 Select the **Power Schemes** tab.
- 3 Select a power scheme from the **Power schemes** drop-down list.
- 4 If you now select the **VAIO Power Management** tab, you see that the selected power scheme appears to the right of **Power Scheme**.
- 5 If necessary, you can change the items in the list, e.g., the brightness of the LCD.
- 6 Click **OK**.

The power scheme has been activated.



You must have computer administrator rights on your computer to set up a power scheme.

For more information on **VAIO Power Management** and **Power Schemes**, see the software's online help files.

<i>Power Scheme</i>	<i>Description</i>
Power Management Off	Turns off all power management features such as Standby and Hibernate modes.
VAIO Optimized	The default power management state for either power source.
VAIO Maximum Battery	Provides power saving features to give you maximum battery life and good performance when battery power is in use. It reduces the brightness of the display and puts the system into <b>Standby</b> mode after a specified time period.
VAIO Ultimate Battery	Provides longer battery life than <b>VAIO Maximum Battery</b> .



If you have a computer with a mobile CPU (see the printed **Specifications** sheet), a CPU control icon may appear on the taskbar. The CPU control icon indicates the CPU control status (Performance, Adaptive, Battery Life, Degrade). To make the icon appear, click the **Advanced** button on the **VAIO Power Management** tab. Select the **Show CPU status icon in the taskbar** box and then click **OK**.

If you want to know more about the CPU control icon, read the online help file (**Other Information - Icons on the Notification Area**).

## *Restoring the default settings*

The power scheme settings that you changed on the **VAIO Power Management** tab can be restored to the default settings.

To restore the default settings, proceed as follows:

- 1 Select the **VAIO Power Management** tab in the **Power Options Properties** window.
- 2 Click the **Advanced** button.  
The **VAIO Power Management** window appears.
- 3 Click the **Reset by default** button.  
The **Confirm** window appears.
- 4 Select the **Restore all power schemes to the original factory default settings**.
- 5 Click **OK**.  
The **Confirm** window closes and the default settings are restored for all the power scheme options.

## Connecting peripheral devices

You can add functionality to your computer by using the various ports on your unit.

- ❑ **Connecting a port replicator (page 100)**
- ❑ **Connecting an external display (page 106)**
- ❑ **Selecting display modes (page 116)**
- ❑ **Using the Multiple Monitors function (page 117)**
- ❑ **Connecting external speakers (page 122)**
- ❑ **Connecting an external microphone (page 124)**
- ❑ **Connecting a Universal Serial Bus (USB) device (page 127)**
- ❑ **Connecting a printer (page 133)**
- ❑ **Connecting an i.LINK device (page 137)**
- ❑ **Connecting to a network (LAN) (page 141)**



To identify and locate the ports on your computer, see the printed **Specifications** sheet.

Sony computer supplies, accessories and peripherals can be purchased from your local retailer or from the Sony website: [www.sonystyle-europe.com](http://www.sonystyle-europe.com)

For more information about connection compatibility, go to the VAIO-Link website: [www.vaio-link.com](http://www.vaio-link.com)

## Connecting a port replicator (VGN-A series)

Your computer supports the use of an optional port replicator. Attaching a port replicator enables you to connect additional peripherals to your computer, such as a printer and an external display.

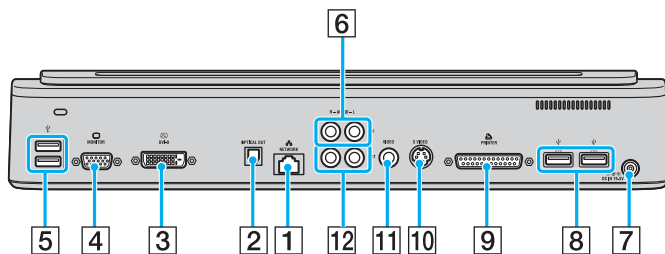

1	Network connector	<a href="#">(page 141)</a>	2	Optical out connector	<a href="#">(page 111)</a>	3	DVI-D connector	<a href="#">(page 107)</a>
4	Monitor/VGA connector	<a href="#">(page 107)</a>	5	2 Hi-Speed USB (USB2.0) connectors	<a href="#">(page 127)</a>	6	Right/Left audio in connectors	<a href="#">(page 100)</a>
7	DC In connector	<a href="#">(page 14)</a>	8	2 Hi-Speed USB (USB2.0) connectors	<a href="#">(page 127)</a>	9	Printer connector	<a href="#">(page 133)</a>
10	S-Video out connector	<a href="#">(page 111)</a>	11	Video out connector	<a href="#">(page 111)</a>	12	Right/Left audio out connectors	<a href="#">(page 111)</a>



The port replicator can be powered only with the AC adapter supplied with your computer. Do not remove the AC adapter from the port replicator or the AC outlet when using the port replicator; this may cause data damage or hardware malfunctions.

When video cables are connected to S-Video out and Video out simultaneously, only the S-Video out connector can be used.

To connect an external audio source (such as a CD player), proceed as follows:

Connect your audio device's left and right audio cables into the right (6) and left (6) audio in connectors.

## Attaching your computer to the port replicator

To attach your computer to the port replicator, proceed as follows:

- 1 Disconnect all peripherals from the computer.
- 2 Plug the power cord (1) into the AC adapter and an AC outlet.
- 3 Plug the cable attached to the AC adapter (2) into the DC In port (3) on the port replicator (4).

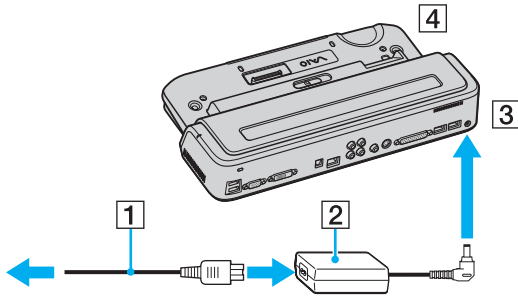

- 4 Slide open the port replicator cover on the bottom of your computer.

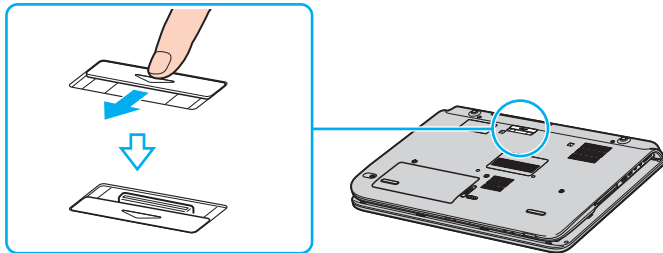

- 5 Align the bottom connector of the computer with the connector on the port replicator and push down until it clicks into place.

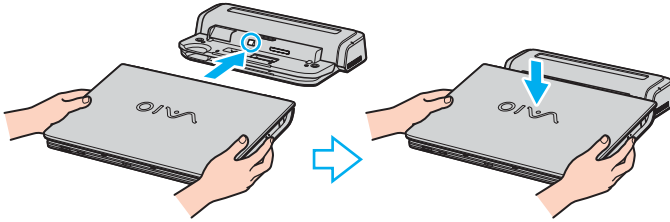

- 6 Slide the lock lever to **LOCK**.

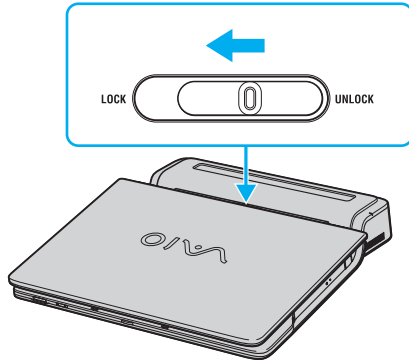

## 7 Turn on the computer.



When attaching your computer to the port replicator, do not attempt to insert or remove the battery pack. Lifting and turning the computer with the attached port replicator may cause a temporary loss of power.

Use the AC adapter that comes with your computer or the optional Sony adapter.



Do not move your computer while attached to the port replicator, as it may detach the port replicator and cause damage to the port replicator and the computer.

## Disconnecting your computer from the port replicator

**!** Make sure to turn off your computer before disconnecting it from the port replicator to prevent loss of unsaved data.

To disconnect your computer from the port replicator, proceed as follows:

- 1 Turn off the computer and the connected peripherals.
- 2 Slide the lock lever to **UNLOCK**.

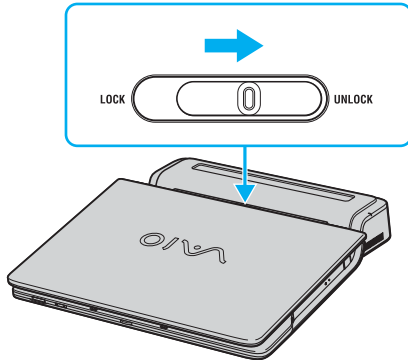

- 3 Lift the computer away from the port replicator.

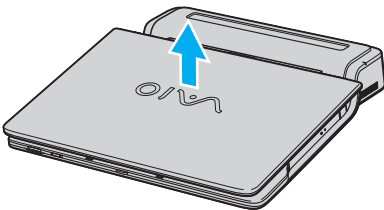



- 4 Close the port replicator connector cover on the bottom of your computer.



It is extremely important to close the port replicator connector cover after disconnecting your computer from the port replicator. If the cover is left open, dust may get inside and damage the computer.

To disconnect your port replicator completely from the mains voltage, unplug the AC adapter.

## Connecting an external display

You can connect an external display to your VAIO computer. For example, you can use your computer with a computer display or a projector.



Connect the power cord after connecting all other cables.

Connected external displays are used as second screens.

On Windows systems only, you can also use an external display to set up multiple monitors.

## Connecting a computer display

You can connect a computer display (monitor) either directly to your computer or via the (optional) port replicator\*.

\* Depending on your model. See the printed **Specifications** sheet for more information.

### VGN-A series

To connect a computer display, proceed as follows:

- 1 If necessary, plug one end of the display's power cord (1) into the display, and the other end into an AC outlet.
- 2 If you want to connect a VGA monitor, plug the display cable (2) (not supplied) into the monitor/VGA connector (3) □ on the computer or the port replicator.
- 3 If you want to connect a TFT/DVI monitor, plug the display cable (not supplied) into the DVI-D connector on the port replicator.

### PCG-K series

To connect a computer display, proceed as follows:

- 1 If necessary, plug one end of the display's power cord (1) into the display, and the other end into an AC outlet.
- 2 Plug the display cable (2) (not supplied) into the monitor/VGA connector (3) □ on the computer.

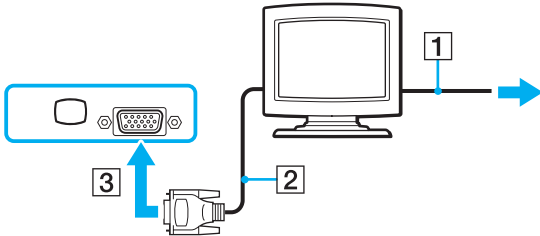



VGN-A series is equipped with the DVI-D connector.

**DVI-D** stands for **Digital Visual Interface - Digital**. It is a kind of DVI connector that only supports digital video signals, so no analogue video signals. It has 24 pins.

A **DVI-I** connector (**Digital Visual Interface - Integrated**) supports digital video and analogue video signals. It has 29 pins.





You can not connect a DVI-I to VGA cable to a DVI-D connector!

## Connecting a multimedia computer display

You can connect a multimedia computer display that includes built-in speakers and a microphone either directly to your computer or via the (optional) port replicator\*.

\* Depending on your model. See the printed **Specifications** sheet for more information.

To connect a multimedia computer display, proceed as follows:

- 1 Plug the power cord of the multimedia computer display (1) into an AC outlet.
- 2 Plug the display cable (2) (not supplied) into the monitor/VGA connector (3)  on the computer or the port replicator.
- 3 Plug the speaker cable (4) into the headphone connector (5)  on the computer.
- 4 Plug the microphone cable (6) into the microphone connector (7)  on the computer.

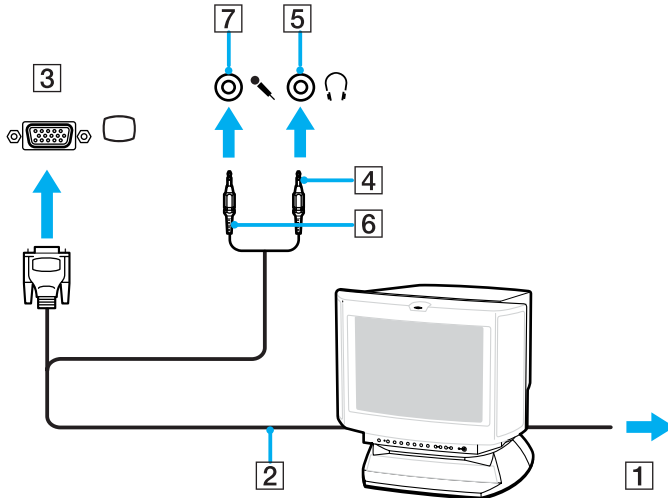

## Connecting a TV

You can connect a TV directly or via the (optional) port replicator\*.

\* Depending on your model. See the printed **Specifications** sheet for more information.

To connect a TV to the computer, proceed as follows:

- 1 Plug the power cord of the TV (1) into an AC outlet.
- 2 Plug one end of an audio/video cable (2) into the AV Out connector (3)  on the computer and the other to the TV.
- 3 Switch the input channel of the TV to external input.
- 4 Set up the TV configuration system.

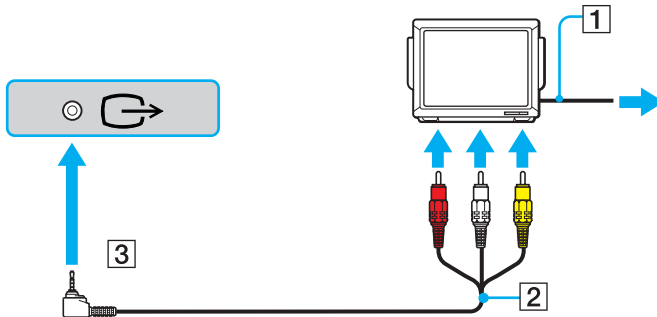



See the manual supplied with your peripheral for more information on installation and use.

If you insert a DVD in your DVD-ROM drive to watch a video on your TV, the <Fn>+<F7> key combination might not activate the function to toggle between your LCD and TV.

**Solution:**

1. Eject your DVD from your computer.
2. Once the DVD is ejected, toggle between your LCD and your TV with the combination <Fn>+<F7>.

Your image appears now on both the LCD and the TV. Re-insert your DVD to launch your DVD software.

If the display resolution of your computer is more than 1024 x 768 pixels, a part of the image cannot be displayed on your TV. The hidden area on your TV can be seen by moving the cursor on your computer. If you want to display the full image, change the display resolution of your computer to **1024 x 768** pixels or lower.

To connect a TV to the port replicator, proceed as follows: (VGN-A series)

- 1 Attach the port replicator to your computer.
- 2 Plug one end of an audio/video cable (1) into the Audio out (R - L) and Video out connectors (2) on the port replicator and the other into the Audio (R - L) and Video connectors on the TV.
- 3 Plug one end of an S-Video cable (3) into the S-Video out connector (4) on the port replicator and the other into the S-Video connector on the TV.
- 4 Switch the input channel of the TV to external input.
- 5 Set up the TV configuration system.

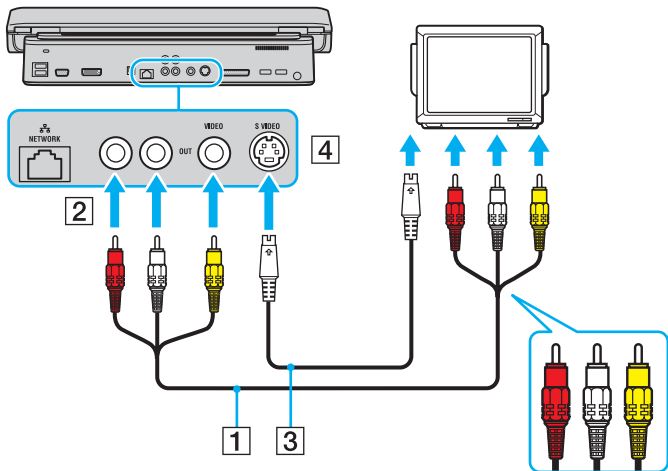

**Which cable can I use to connect my VAIO equipped with an Audio/Video port to a TV?** You need to use an AV cable which has a minijack connector on one end and 3 RCA (also called cinch) connectors on the other end. For example, the Sony **VMC-20FR** which is available via direct sales and various retailers. Note that not all TVs have RCA in, if your TV does not have RCA in, you need an RCA to Scart converter (provided of course that your TV has a Scart in). If your VAIO has an S-video port, you can use this port as an alternative means of connection. Please have a look at the **Knowledge Bases** on the [VAIO-Link](#) website.



## Connecting a projector

You can connect a projector (such as the Sony LCD projector) either directly to your computer or via the (optional) port replicator\*.

\* Depending on your model. See the printed **Specifications** sheet for more information.

To connect a projector, proceed as follows:

- 1 Connect the power cord (1) of the projector into an AC outlet.
- 2 Plug the RGB signal cable (2) into the monitor/VGA connector (3) □ on the computer or the port replicator.
- 3 Plug the audio cable (4) (not supplied) into the earphone connector (5) ♯.
- 4 Plug the RGB signal cable and the audio cable into the connectors on the projector (6).

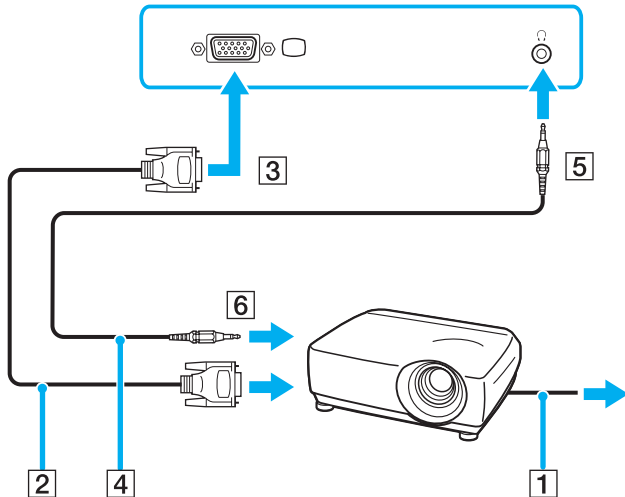

## *Troubleshooting external displays*

### *I cannot use the Plug and Display function (VGN-A series)*

Depending on the external display or the way it is connected, the Plug and Display function may not be available. Use the shortcut key with the Fn key to select the output destination.

### *I cannot display contents on two or more displays at the same time*

You cannot display contents on multiple external displays at the same time. Select one of the external displays.

### *The external display with the DVI-D connector does not display properly (VGN-A series)*

See the printed **Troubleshooting Guide** first to solve your problems. If the problem persists, proceed as follows:

- 1 Click **Start** and then **Control Panel**.  
The **Control Panel** window appears.
- 2 Click the **Appearance and Themes** icon.
- 3 Click the **Display** icon.  
The **Display Properties** window appears.
- 4 Click the **Settings** tab.
- 5 Click **Advanced**.  
The properties window appears.
- 6 Click **Options**.
- 7 Confirm that the button for **Alternate DVI operational mode** is selected. If not, click to check the button.
- 8 Click to check the button for **Reduce DVI frequency on high-resolution displays**.  
The warning message window appears.
- 9 Click **Yes**.

**10** Click **Yes** once again.

**!** Click to check the above button only if the external display with the DVI-D connector does not display properly with the default settings.

The external display with the DVI-D connector does not display the boot-up screen and the BIOS setup screen at startup. To change the BIOS settings, use your computer's screen.

## Selecting display modes

Your VAIO computer uses the ATI video controller. You can select which display to be used as the primary monitor when an external display (desktop monitor, TV, etc.) is connected to the computer. If you want to work on your computer's LCD and the external display at the same time, see **Using the Multiple Monitors function** ([page 117](#)) for more information.

To change the primary monitor, proceed as follows:

- 1 Click the **Start** button, and then **Control Panel**.  
The **Control Panel** appears.
- 2 Click **Appearance and Themes**.
- 3 Click **Display**.  
The **Display Properties** dialog box appears.
- 4 Click the **Settings** tab.
- 5 Click **Advanced**.
- 6 Click the **Displays** tab to select a display.
- 7 Click **Apply** and then **OK**.

## Using the Multiple Monitors function

The Multiple Monitors function allows you to distribute portions of your desktop across separate displays. For example, if you have an external display attached to the monitor/VGA connector, your computer's LCD and the external display can function as a single desktop.

You can move the cursor from one display to the other. This allows you to drag objects, such as an open application window or a toolbar, from one display to the other.

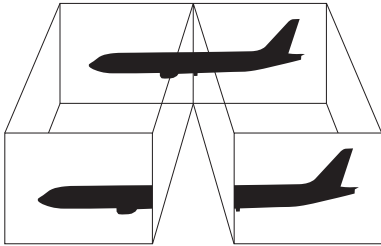

Your monitor or TV hardware may not support the Multiple Monitors function.

Certain software applications may not be compatible with Multiple Monitors settings.

Make sure that your computer does not enter **Standby** or **Hibernate** mode while you are using Multiple Monitors mode, otherwise your computer may not return to **Normal** mode.

If you set different colours on each display, do not divide one single window on two displays, otherwise your software may not work properly.

Set fewer colours or a lower resolution for each display.

## Selecting the Multiple Monitors mode

To select the Multiple Monitors mode, proceed as follows:

- 1 Click the **Start** button on the **Windows** taskbar.
- 2 Click **Control Panel**.
- 3 Click **Appearance and Themes**.
- 4 Click the **Display** icon.
- 5 Select the **Settings** tab.
- 6 Click the monitor icon marked **2**.
- 7 Select the **Extend my Windows desktop onto this monitor** check box.
- 8 Click **Apply** and then **OK**.  
If the **Monitor Settings** dialog box appears, click **YES**.



Your external display or TV may not support the Multiple Monitors function.

On VGN-A series, you can also switch the view between your computer's LCD and the external display with the **S1** button if you change the default button assignment. For details on changing the button assignment, **Setting up your computer with VAIO Control Center** ([page 26](#)).

## *Setting the colours and resolution for each display*

You can set the display colours and resolution for each display that is part of multiple monitors.

To set the display colours and resolution for each display, proceed as follows:

- 1 Click the **Start** button on the **Windows** taskbar.
- 2 Click **Control Panel**.
- 3 Click **Appearance and Themes**.
- 4 Click the **Display** icon.
- 5 Select the **Settings** tab.
- 6 Click the display you want to change (1 or 2).
- 7 Select an option from the **Color quality** list to change colours.
- 8 Use the slider in the **Screen resolution** to adjust the resolution.
- 9 Click **Apply** and then **OK**.  
If the **Monitor Settings** dialog box appears, click **YES**.

## *Customising the multiple monitors*

You can customise the Multiple Monitors mode by changing the position of the two monitors comprising the multiple monitors.

To customize Multiple Monitors mode, proceed as follows:

- 1 Click the **Start** button on the **Windows** taskbar.
- 2 Click **Control Panel**.
- 3 Click **Appearance and Themes**.
- 4 Click the **Display** icon.
- 5 Click the **Settings** tab.
- 6 Drag the monitor icons to match the physical arrangement of your monitors. The two monitor icons must be connected to create multiple monitors.
- 7 Click **Apply** and then **OK**.  
If the **Monitor Settings** dialog box appears, click **YES**.



## *Deactivating the Multiple Monitors function*

To deactivate the Multiple Monitors function, proceed as follows:

- 1 Click the **Start** button on the **Windows** taskbar.
- 2 Click **Control Panel**.
- 3 Click **Appearance and Themes**.
- 4 Click the **Display** icon.
- 5 Click the **Settings** tab.
- 6 Click the monitor icon **2**.
- 7 Deselect the **Extend my Windows desktop onto this monitor** check box.
- 8 Click **Apply** and then **OK**.  
If the **Monitor Settings** dialog box appears, click **YES**.



For switching from Primary to Secondary display, see **Selecting display modes** ([page 116](#)).

On VGN-A series, you can also switch the view between your computer's LCD and the external display with the **S1** button if you change the default button assignment. For details on changing the button assignment, **Setting up your computer with VAIO Control Center** ([page 26](#)).

## Connecting external speakers

You can enhance the sound quality of your computer by connecting external speakers.

To connect external speakers, proceed as follows:

- 1 Plug one end of a speaker cable (1) into the headphone connector (2)  on the computer.
- 2 Plug the other end of the speaker cable to the external speakers (3).
- 3 Turn down the volume of the speakers before you turn them on.

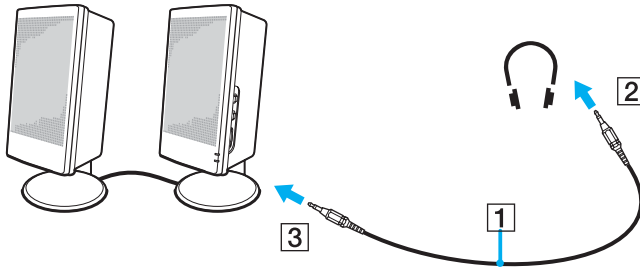

Make sure your speakers are designed for computer use.

Do not place floppy disks on the speakers; their magnetic field may damage the data on the disks.

## Troubleshooting sound

### My speakers are not producing sound

#### ❑ VGN-A series

- ❑ The built-in speakers may be turned off (the Mute  $\text{m}\times$  indicator is on). Press the **Mute** button to turn on the speakers.
- ❑ The speaker volume may be turned to the minimum. Press the **Volume up** button to increase the volume.

#### ❑ PCG-K series

- ❑ The built-in speakers may be turned off. Press <Fn>+<F2> to turn on the speakers.
- ❑ The speaker volume may be turned to the minimum. Press <Fn>+<F4> and then  $\uparrow$  or  $\rightarrow$  or keep pressing <Fn>+<F4> to increase the volume.
- ❑ If you use external speakers, check that the speakers are properly connected and the volume is turned up. If the speakers have a mute button, make sure it is off. If batteries power the speakers, check that the batteries are inserted properly and that they are charged.
- ❑ If you have connected an audio cable to the headphone connector, disconnect the cable.
- ❑ If your computer is powered by battery, check that the battery pack is properly installed and charged.
- ❑ If you are using an application that has its own volume control, check that the volume is turned up.
- ❑ Check the volume controls in Windows.

## Connecting an external microphone

If you need to use a sound input device, for example to chat on the Internet, you need to plug in an external microphone.

To connect an external microphone, proceed as follows:

Plug the microphone cable (1) into the microphone connector (2) on the computer.

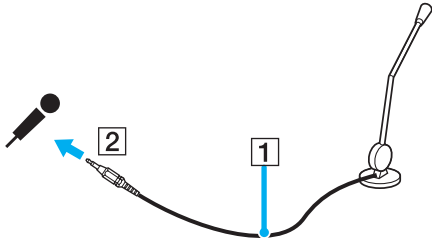

Make sure your microphone is designed for computer use.

## *Troubleshooting sound*

### *My microphone does not work*

If you are using an external microphone, check that the microphone is plugged into the microphone connector correctly.

### *My microphone volume is too high or too low*

Proceed as follows to adjust the volume.

- 1 Click **Start** and then **Control Panel**.  
The **Control Panel** window appears.
- 2 Click **Sounds, Speech, and Audio Devices** and then **Sounds and Audio Devices**.
- 3 Click **Volume** under **Sound recording** on the **Audio** tab.
- 4 See if the **Select** check box for **Microphone Balance** is selected. If not, click the check box.
- 5 Move the slider up or down to adjust the volume.
- 6 If the volume is still too high or too low, select **Advanced Controls** from the **Options** menu.  
The **Advanced** button appears for **Microphone Balance**.
- 7 Click the **Advanced** button and select/deselect **Microphone Boost** or **+20db Gain** under **Other Controls** to adjust the volume.

### *Only left-channel audio is recorded with a monaural microphone (VGN-A series)*

Proceed as follows to change the audio channel setting.

- 1 Click **Start** and then **Control Panel**.  
The **Control Panel** window appears.
- 2 Click **Sounds, Speech, and Audio Devices** and then **Sounds and Audio Devices**.
- 3 Click **Volume** under **Sound recording** on the **Audio** tab.
- 4 Select **Advanced Controls** from the **Options** menu.  
The **Advanced** button appears for **Microphone Balance**.
- 5 Click the **Advanced** button and select the **Mono Mic** check box under **Other Controls**.

! This audio channel setting is only applied to sound recording with a microphone.

### *Stereo sound is not recorded with a stereo microphone (VGN-A series)*

Proceed as follows to change the audio channel setting.

- 1 Click **Start** and then **Control Panel**.  
The **Control Panel** window appears.
- 2 Click **Sounds, Speech, and Audio Devices** and then **Sounds and Audio Devices**.
- 3 Click **Volume** under **Sound recording** on the **Audio** tab.
- 4 Select **Advanced Controls** from the **Options** menu.  
The **Advanced** button appears for **Microphone Balance**.
- 5 Click the **Advanced** button and deselect the **Mono Mic** check box under **Other Controls**.

## Connecting a Universal Serial Bus (USB) device

You can connect a USB device (for example, a mouse, floppy disk drive, keyboard, printer) to your computer.

USB devices are hot plug and play devices. You do not need to shut down your computer prior to connecting these devices unless the manual supplied with the device states otherwise.

For some USB devices you need to install the software before you connect the device. Not following this procedure might cause the device not to work properly. For more information, check the manual provided with the USB device.

When you are playing a DVD (video or audio) and you want to remove a USB device, such as USB-compatible speakers, make sure you stop the DVD first. Removing a USB-compatible device during DVD (video or audio) playback may cause a malfunction.

To prevent your computer and/or USB devices from damage, observe the following:

- When moving your computer with USB devices connected, avoid any shock or force to the USB connectors.
- Do not put your computer into a bag or carrying case when it has USB devices connected.
  
- Connecting a USB mouse** ([page 128](#))
- Connecting a USB floppy disk drive** ([page 129](#))

## Connecting a USB mouse

To connect a USB mouse, proceed as follows:

- 1 Choose the USB connector (1)  you prefer to use.
- 2 Plug the USB mouse cable (2) into the USB connector.
- 3 You can now use your USB mouse (3).

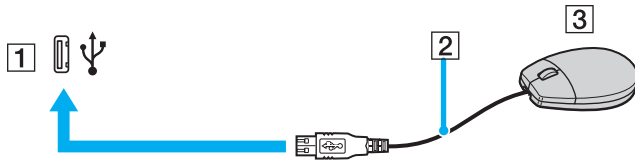

The VAIO USB mouse software driver is preinstalled on your computer, therefore, you only need to plug the USB mouse into the USB connector and you can start working.



## Connecting a USB floppy disk drive

As an optional extra, you can purchase a USB floppy disk drive and connect it to your computer.

To connect a USB floppy disk drive, proceed as follows:

- 1 Choose the USB connector  you prefer to use.
- 2 Plug the USB floppy disk drive cable into the USB connector. The VAIO logo on the disk drive should be facing up. Your USB floppy disk drive is now ready for use.

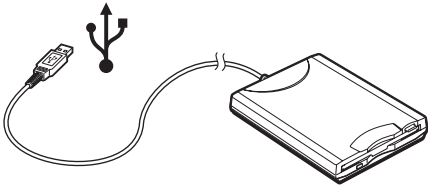

When using a USB floppy disk drive, do not apply force on the USB connector. This may cause a malfunction.

To remove a USB floppy disk drive, proceed as follows:

- If your computer is on, wait until the floppy drive LED indicator turns off and then unplug the USB cable. If the floppy disk drive is not removed properly, your system may crash and you may lose any unsaved data.
- If your computer is off, you can unplug the USB cable directly from the computer.

## Inserting a floppy disk

To insert a floppy disk, proceed as follows:

- 1 Hold the disk (1) with the label side facing up.
- 2 Gently push the disk into the drive (2) until it clicks into place.

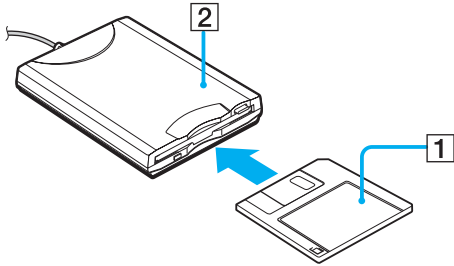

## Removing a floppy disk

To remove a floppy disk, proceed as follows:

When you have finished using the floppy disk, wait until the LED indicator (1) turns off and then press the eject button (2) to remove the disk.

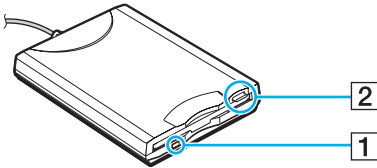

Before pressing the eject button, make sure that the LED indicator is turned off.

If the disk does not come out by pressing the eject button, disconnect the floppy disk drive from the computer.



Do not press the eject button while the LED indicator is on. It may damage the floppy disk.

## *Troubleshooting floppy disks*

### *My USB floppy disk drive cannot write to a floppy disk*

- The floppy disk is write-protected. Disable the write-protect feature or use a floppy disk that is not write-protected.
- Check that the disk is properly inserted into the floppy disk drive.
- Your disk may be corrupt. Try to insert another floppy disk.

### *The optional USB floppy disk drive is not recognised as drive A*

To set the floppy disk drive to A, proceed as follows:

- 1 Turn the system power on.
- 2 Connect the floppy disk drive.
- 3 Select **Control Panel** from the **Start** menu.
- 4 Click **Performance and Maintenance**.
- 5 Click **System**.
- 6 Select the **Hardware** tab, then click **Device Manager**.
- 7 Select **Universal Serial Bus controllers**, then **Y-E Data USB Floppy**.
- 8 From the Action menu, click **Uninstall**.
- 9 Keep clicking **OK** until the **Confirmation of deletion of device** message appears.
- 10 Select **Scan for hardware changes** from the **Action** menu.  
The floppy disk drive is recognised as drive A.

## Connecting a printer

You can connect a Windows-compatible printer to your computer to print documents.

### Connecting a printer using the USB connector

You can connect a USB printer compatible with your version of Windows to your computer.

To connect a printer using the USB connector, proceed as follows:

- 1 Plug the printer power cord into an AC outlet (1).
- 2 Choose the USB connector (3) you prefer to use.
- 3 Plug one end of a USB printer cable (2) into the USB connector and the other to your printer.

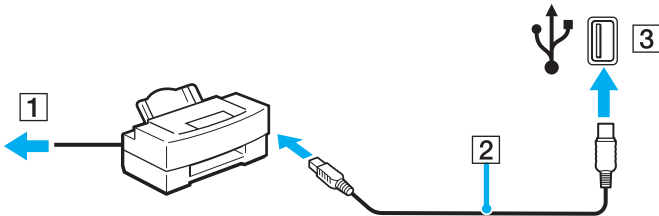

## Connecting a printer using the printer connector

To connect a printer using the printer connector, proceed as follows:

- 1 Plug the printer power cord (1) into an AC outlet.
- 2 Plug the printer cable (2) supplied with your printer into the printer connector (3)  on the computer or the (optional) port replicator\*.

\* Depending on your model. See the printed **Specifications** sheet for more information.

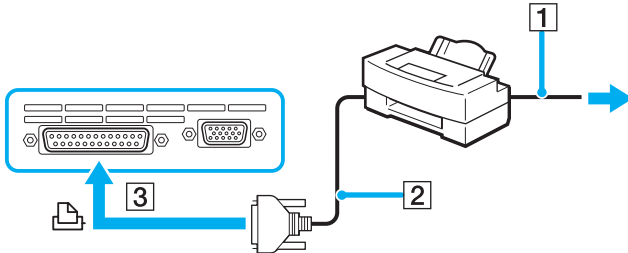

Turn off your computer and the printer, unplug the AC adapter and the power cord before connecting the printer.

## Troubleshooting printers

- ❑ Make sure that the printer driver supports Windows XP.  
Ask the manufacturer of your printer for the driver that supports Windows XP.
- ❑ The printer connector  on the port replicator is internally connected to the USB. If your printer is connected to the printer connector on the port replicator, proceed as follows to check the printer port settings.
  - 1 Click **Start** and then **Control Panel**.
  - 2 Click the **Printers and Other Hardware** icon.
  - 3 Click the **Printers and Faxes** icon.
  - 4 Right-click the printer to select **Properties**.
  - 5 Click the **Ports** tab.
  - 6 Check if the check box for **USB001** is selected. If another check box is selected, click the box for **USB001**.
  - 7 Click **OK**.

If the above procedure does not work, right-click the printer and selected "Delete" on the window in step 3 above to delete the printer. Then, install the printer driver once again.

- ❑ If the bidirectional communication functions are provided with your printer, disabling the functions on your computer may enable printing. Proceed as follows:
  - 1 Click **Start** and then **Control Panel**.
  - 2 Click the **Printers and Other Hardware** icon.
  - 3 Click the **Printers and Faxes** icon.
  - 4 Right-click the printer to select **Properties**.
  - 5 Click the **Ports** tab.
  - 6 Click the check box for **Enable bidirectional support** to deslect it.
  - 7 Click **OK**.



This change to the settings will disable the bidirectional communication functions of your printer, such as data transfer, status monitoring, and remote panel.

- ❑ Check the physical connections between your computer and printer, the AC adapter and the power cord, and the power cord and an AC outlet, and then restart your computer.



## Connecting an i.LINK device

Your computer includes an i.LINK (IEEE1394) connector, which you can use to connect to an i.LINK device such as a digital video camera recorder or to connect two VAIO computers in order to copy, delete or edit files.

The i.LINK connector of your computer does not supply power to external devices generally powered by i.LINK connectors.

The i.LINK connector supports transfer rates up to 400 Mbps; however, the actual transfer rate depends on the transfer rate of the external device.

The i.LINK features available may vary depending on the software applications you use. Refer to the documentation that came with your software for more information.

i.LINK cables compatible with your VAIO computer include cables with the following part numbers:

VMC-IL4415A (a 1.5 meter cable with a 4-pin connector at each end), VMC-IL4408 Series (a 0.8 meter cable with a 4-pin connector at each end).

- ❑ **Connecting a digital video camera recorder (page 138)**
- ❑ **Connecting two VAIO computers (page 139)**



An i.LINK connection with other compatible devices is not fully guaranteed.

The i.LINK connection varies depending on the software applications, operating system and i.LINK compatible devices you use. Refer to the documentation that came with your software for more information.

Check the working conditions and OS compatibility of i.LINK-compatible PC peripherals (HDD, CD-RW drive etc.) before you connect them to your computer.

## Connecting a digital video camera recorder

To connect a digital video camera recorder, proceed as follows:

- 1 Plug one end of the i.LINK cable (1) into the i.LINK connector (2) of the computer and the other end into the DV In/Out connector (3) on the digital video camera recorder.
- 2 Launch **DVgate Plus**.

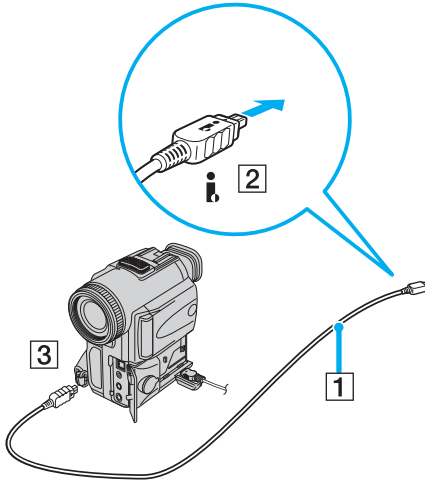

 On Sony digital video cameras, connectors labelled **DV Out**, **DV In/Out** or **i.LINK** are i.LINK-compatible.

The Sony digital video camera recorder is an example; your digital video camera recorder may need to be connected differently.

If your digital video camera recorder includes a Memory Stick slot, you can copy images from it to your computer via a Memory Stick. To do so, simply copy images on the Memory Stick, then use a special PC Card adapter to insert it into your computer.

You cannot access the pictures stored on a Memory Stick when using an i.LINK connection.

## *Connecting two VAIO computers*

You can copy, edit or delete files on another VAIO computer to your computer with an optional i.LINK cable.

You can also print a document on a printer connected to another VAIO computer.

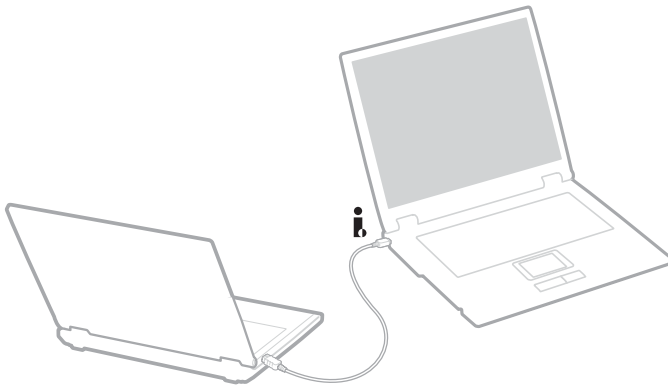

## *Troubleshooting i.LINK devices*

### *I cannot establish an i.LINK connection between two VAIO computers*

- You must have administrator rights on your computer to be able to link the two.
- Disconnect then reconnect the i.LINK cable.
- If you still have no connection after waiting for a while, restart both computers.
- If either computer has just returned from a power saving mode, the connection may be affected. In this case, make sure you perform a full restart before connecting them.

### *When I record images to a digital video device using **DVgate Plus**, I see an error message*

- Close all open applications and restart your computer. Frequent recording of images to a digital video device while using **DVgate Plus** sometimes causes this error.
- Your DV device will need to have DV In/Out in order to be able to transfer your files to the DV device.

### *I cannot use digital devices*

- Check that the DV device is turned on and that the cables are properly connected.
- If you are using multiple i.LINK devices, the combination of the connected devices may cause unstable operation. If this is the case, turn off all connected devices and disconnect unused devices. Check the connection and then turn on the power again.
- You are strongly advised to use only Sony i.LINK cables, as using other brands may cause problems with the i.LINK devices.

## Connecting to a network (LAN)

You can connect your computer to 10BASE-T/100BASE-TX/1000BASE-T-type networks\* via an Ethernet network cable. For the detailed settings and devices needed to connect to the network, consult your Network Administrator.

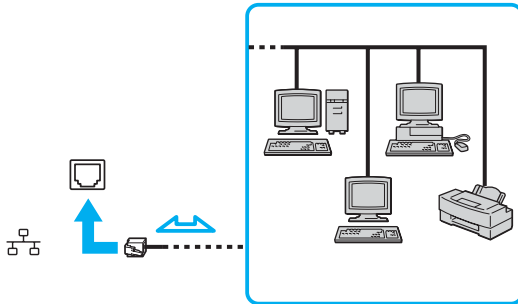

The default settings make your computer able to connect to the network.

If the VGN-A series main unit is docked, you can only use the Ethernet network connector on the (optional) port replicator\*.

\* Depending on your model. See the printed **Specifications** sheet for more information.



Telephone lines cannot be connected to the network (LAN) connector on your computer. If the network (LAN) connector is connected to the telephone lines mentioned below, high electric current to the connector may cause damage, overheating or fire.

- Home (intercom speakerphone) or business-use telephone lines (multi-line business telephone);
- Public telephone subscriber line;
- PBX (private branch exchange).



Do not plug a phone cable into your computer network jack.

## *Customising your computer*

The following sections briefly describe how to change the main settings of your computer. Among other things, you will learn how to prepare your modem for use, how to use and customise the look of your Sony software and utilities, etc.

- Setting up your language with Windows XP Professional ([page 143](#))**
- Configuring your modem ([page 146](#))**
- Setting a Sony wallpaper ([page 148](#))**
- Installing and updating applications ([page 149](#))**
- Managing drivers ([page 154](#))**

## Setting up your language with Windows XP Professional

Windows XP Professional computers are equipped with the **Multilingual User Interface (MUI)** feature. It allows you to change the English operating system, some software applications and the keyboard layout into the language of your choice: **French, German, Japanese, Dutch, Italian, Spanish, Czech, Finnish, Greek, Portuguese and Swedish.**

It is important that you select the correct keyboard settings during the Windows Setup.

To select the correct keyboard settings during Windows Setup, proceed as follows:

- 1 At first boot, click **Next**, then **Next** again in the **Windows XP Setup Wizard** window. The **Select Your System Settings** dialog box appears.
- 2 Fill in these three questions:
  - I live the closest to this region.
  - I type mostly in this language.
  - I use this type of keyboard.
- 3 In the **End User License Agreement**, accept the License Agreement and click **Next**.
- 4 Continue your Windows setup until it is finished.

You can also change the country and language settings into your language as soon as Windows has been restarted.

To change the country and language settings, proceed as follows:

- 1 Click **Start** and then **Control Panel**.
- 2 In the **Control Panel** window, double-click the **Regional and Language Options** icon. If you do not see this icon, click **Switch to Classic View** on the left side.
- 3 In the **Regional Options** tab of the **Regional and Language Options** window, select **your language** from the **Standards and formats** drop-down menu.

- 4 In the **Advanced** tab of the **Regional and Language Options** window, select **your language** from the **Language for non-Unicode programs** drop-down menu.
- 5 To change the language of the Windows menus, dialog boxes and online help files provided by Microsoft Windows, select the **Languages** tab of the **Regional and Language Options** window.  
 Non-Microsoft Windows applications stay in English, even if you change these settings.
- 6 Select your language from the drop-down list.
- 7 Click **Apply** to apply the changes.  
You are prompted to log off and log on again. Only then, the changes to the new language will take effect.
- 8 Click **Start**, and select **Log Off**.
- 9 Click **Log Off** in the **Log Off Windows** window. If necessary, enter your password to log on again. All the menus, help files and icons are then displayed in your selected language. However, some parts may remain in English.



To change the keyboard layout, proceed as follows:

- 1 Click **Start** and then **Control Panel**.
- 2 In the **Control Panel** window, double-click the **Regional and Language Options** icon.  
If you do not see this icon, click **Switch to Classic View** on the left side.
- 3 In the **Languages** tab of the **Regional and Language Options** window, click the **Details** button.  
The **Text Services and Input Languages** window appears.
- 4 In the **Settings** tab of the **Text Services and Input Languages** window, select your keyboard from the **Default input language** drop-down menu.
- 5 If your keyboard is not available, click the **Add** button.  
The **Add Input Language** window appears.
- 6 Select the input language and keyboard from the drop-down menu.
- 7 Click the **OK** button to close the **Add Input Language** window.
- 8 Click the **OK** button to close the **Regional and Language Options** window.

## Configuring your modem

Before you can start using your internal modem (not all modems are built-in), or each time you use your modem while travelling, make sure that the country of the active location defined in the **Phone and Modem Options** dialog box matches the country you are dialling from. You may notice a **Country Selector** tab under your current modem driver options. As the **Country Selector** tab is not a constant feature, do not use this tab to change the country settings. Only the following procedure is reliable.

To change your modem country settings, proceed as follows:

- 1 Click **Start** and then **Control Panel**.
- 2 Double-click **Phone and Modem Options**.  
The **Phone and Modem Options** dialog box appears.  
If you do not see the **Phone and Modem Options** dialog box, click **Switch to Classic View** on the left side.
- 3 Select your location on the **Dialing Rules** tab.
- 4 Click the **Edit** button to change the current configuration.  
The **Edit Location** dialog box appears.  
Or  
Click the **New** button to configure your modem.  
The **New Location** dialog box appears.
- 5 Check the country/region settings, and make sure it matches the place you are dialling from.



Pulse dial may not be supported in some countries and/or regions.

- 6 If you modified your location settings, click **Apply**, and then **OK**.  
The **Phone and Modem Options** dialog box appears.
- 7 Check that your modem is listed in the **Modems** tab.  
If your modem is not listed, click **Add** and follow the wizard.
- 8 Click **Apply/OK**. Your modem is configured.



Before applying new country settings, please make sure your phone line is disconnected from your VAIO computer.

## Updating the modem driver

If you need to update the modem driver for any reason, proceed as follows:

- 1 Click the **Start** button and open **Control Panel**.  
The **Control Panel** window appears.
- 2 Click the **Printers and Other Hardware** icon.  
The **Printers and Other Hardware** window appears.
- 3 Click the **Phone and Modem Options** icon.  
The **Phone and Modem Options** dialog box appears.
- 4 Click the **Modems** tab and then click **Properties** to view the properties of your modem.  
The **Modem Properties** dialog box appears.
- 5 On the **Driver** tab, click **Update driver**.  
The **Hardware Update Wizard** window appears.  
Follow the instructions that appear on your screen. You can perform a Windows search for the driver, or point to the driver's location yourself.

## Setting a Sony wallpaper

Your Sony VAIO computer offers you, among many other features, a choice of wallpapers. You can change the wallpaper, the background of your desktop, as many times as you like. There are several VAIO-specific wallpapers to choose from.

To set another VAIO wallpaper, proceed as follows:

- 1 Go to **Control Panel**, click the **Appearance and Themes** icon and then the **Display** icon. The **Display Properties** dialog box appears.
- 2 Click the **Desktop** tab.  
A list of Windows and VAIO wallpapers is displayed.
- 3 Select a wallpaper from the **Background** list.  
You can see a preview of this wallpaper in the monitor above the **Background** list.
- 4 Adjust the position of the wallpaper with the **Position** drop-down list.
- 5 Click **Apply** when you have found the appropriate wallpaper.
- 6 Click **OK** to close the **Display Properties** dialog box.  
The wallpaper is applied to your computer.



A higher screen resolution reduces the size of items on your screen and increases the relative space on your desktop.

You may not be able to increase the screen resolution above a certain level. Your monitor and video adapters, for example, determine to which extent you can change the resolution.

## *Installing and updating applications*

This section explains how to install, run or uninstall a software.

Furthermore, you will learn how to download the latest updates from our website.

- Installing software** ([page 150](#))
- Changing or removing software** ([page 151](#))
- Caution** ([page 152](#))
- Downloading software** ([page 153](#))

## Installing software

To install bundled software from the supplied **Recovery Disc** or your hard disk drive, see the printed **Recovery Guide** for details. For software bundled with accessories, check first the installation procedure that comes with the accessory.

To install other software, use the following procedure.

Before installing the applications:

- Install and connect a hardware device, if necessary (see the **Managing drivers (page 154)** section);
- Close all open applications.

To install an application, proceed as follows:

- 1** Click **Start** and then **Control Panel**.  
The **Control Panel** window appears.
- 2** Click **Add or Remove Programs**.  
The **Add or Remove Programs** dialog box appears.
- 3** Click **Add New Programs**, and then click **CD or Floppy**.  
The **Install Program From Floppy Disk or CD-ROM** window appears.
- 4** Insert the first installation floppy disk or CD-ROM and click **Next**.  
The **Run Installation Program** appears.
- 5** For the rest of the procedure, follow the on-screen instructions.



When using **Add or Remove Programs**, you can only install programs that were written for Windows operating systems.

## Changing or removing software

You can remove or change a software application any time you like. Before proceeding, close the application you want to change/remove.

To change or remove software, proceed as follows:

- 1 From the **Start** menu, click **Control Panel**.  
The **Control Panel** window appears.
- 2 Click the **Add or Remove Programs** icon.  
The **Add or Remove Programs** dialog box appears.
- 3 Select the software you want to change or remove.
  - To change a program, click **Change/Remove** or **Change** and follow the on-screen instructions.
  - To uninstall a program, click **Change/Remove** or **Remove**, then click **Next** followed by **OK**.  
If the **Locked file detected** dialog box appears, click **Reboot**. The computer restarts once uninstallation is completed and all previously used files are deleted.  
If the **Shared file detected** dialog box appears, it is recommended that you click **No** to keep shared files.  
Click **Close**.  
The software is uninstalled.

**!** When you click **Change or Remove**, some programs may be removed without any further warning. **Make sure you are certain you want to remove it beforehand.**



You can sort programs by selecting different options in **Sort by**.

**Add or Remove Programs** will only remove programs that were written for Windows operating systems. For other programs, check the documentation to see if other files (such as .ini files) should be removed.

## Caution

### Windows File protection

Installing a program might overwrite shared system files such as **dynamic-link libraries** (DLL files)\* and executable files (EXE files). When system files are overwritten, system performance becomes unpredictable, programs behave erratically, and the operating system can fail.

Never delete files with the following extensions: SYS, DLL, OCX, TTF, or FON.

In Windows XP, **Windows File Protection** prevents the replacement of protected system files such as SYS, DLL, OCX, TTF, FON, and EXE files. **Windows File Protection** runs in the background and protects all files installed by the **Windows Setup** program.

**Windows File Protection** detects attempts by other programs to replace or move a protected system file. It also checks the file's digital signature.

\* This is an operating system feature that allows executable routines (generally serving a specific function or set of functions) to be stored separately as files with DLL extensions. These routines are loaded only when needed by the program that calls them.

### File Signature verification

When you install a new application on your computer, you might overwrite system files and device driver files with unsigned or incompatible versions, which provokes system instability.

The system files and device driver files provided with Windows XP have a Microsoft digital signature, which indicates that the files are original, unaltered system files or that they have been approved by Microsoft for use with Windows.



## Downloading software

Please note it is possible to download the latest upgrades of software for your computer from our website.

To download the latest upgrades, proceed as follows:

- 1 Go to [www.vaio-link.com](http://www.vaio-link.com) and choose your language.
- 2 Select **Drivers and Updates** and follow the procedure.



To install your application, see the **Installing software (page 150)** section.

## Managing drivers

A driver is a software enabling you to use hardware devices. For example, in order for you to be able to use a printer, you must first install its driver. Many drivers, such as the mouse driver, come with the operating system.

This section explains how to install, check, update or uninstall a driver.

The Windows XP Rollback feature is also explained.

Finally, you will learn how to download the latest drivers from our site.

- Installing a driver ([page 155](#))**
- Checking the driver's installation ([page 157](#))**
- Updating a driver ([page 159](#))**
- Uninstalling a driver ([page 160](#))**
- Restoring a driver ([page 162](#))**
- Downloading drivers ([page 164](#))**

## Installing a driver

For more information on (re)installing drivers, see the printed **Recovery Guide** for details.

To install a driver that is stored on the C: drive, proceed as follows:

- 1 Go to the folder **C:\Drivers**.
- 2 Select the correct folder.  
If you need to update a modem driver, for example, select the **Modem** folder.
- 3 If there is an .exe file, double-click the .exe file and follow the online procedure.  
If there is no .exe file, you need to go through the **Device Manager** to update the driver (see the second option in the **Updating a driver (page 159)** chapter).

If the driver comes on a CD-ROM or disk accompanying an accessory and the driver does not come with a specific installation procedure, proceed as follows to install it:

- 1 Insert the installation CD-ROM or disk accompanying the device into the optical disc drive.
- 2 Connect the device that needs a driver, to your computer.  
The **Found New Hardware Wizard** screen appears.
- 3 Select **Specify a location**, then click **Next**.
- 4 When installing a driver from the provided CD-ROM (or disk) by using a CD-ROM (or disk) drive connected to the computer, select the **Drivers** folder on the optical disc drive.
- 5 When installing a driver after having copied the contents of the provided CD-ROM (or disk) to your hard disk, browse to the appropriate subdirectory containing the driver. The subdirectory should be found in the folder you copied from the CD-ROM (or disk).
- 6 Click **OK** to begin the search procedure.
- 7 Click **Next** to install the driver.  
A new window appears when the driver has been installed.

- 8 Click **Finish**.  
You may be asked to restart your machine.
- 9 Click **Yes**.  
The driver is installed.



To install your device driver, you must log on to your computer as a user with administrator rights.

## Checking the driver's installation

When the computer restarts, check that the device is working properly.

To check the driver's installation, proceed as follows:

- 1 From the **Start** menu, click **Control Panel**.  
The **Control Panel** window appears.
- 2 Click **Performance and Maintenance**.
- 3 Click the **System** icon.  
The **System Properties** dialog box appears.
- 4 Click the **Hardware** tab, then click **Device Manager**.
- 5 Double-click the option corresponding to the device you installed, then double-click your device.  
The **Properties** dialog box appears.
- 6 Make sure that the **This device is working properly** message is displayed under **Device status**.
- 7 Click **OK**.  
Close all the opened windows, your device is ready for use.

The device is not working properly in the following cases:

- Your device is shown in **Device Manager** with a yellow question or exclamation mark.  
Right-click your device and click **Uninstall**. Then repeat from step 2 in **Installing a driver (page 155)**.
- Double-clicking the category of your device in the device manager list does not display your device.  
You have to remove your device. See **Uninstalling a driver (page 160)** to remove it. Then repeat from step 2 in **Installing a driver (page 155)**.
- Double-clicking **Other devices** displays your device.  
You have to right-click your device, then click **Uninstall**. Repeat from step 2 in **Installing a driver (page 155)**.

- ❑ If the **This device is working properly** message is not displayed, the device is not working properly. Click **OK** to close the **Properties** dialog box, then reinstall the driver as follows:
  - ❑ Right-click **Uninstall**.
  - ❑ When the **Confirm Device Removal** dialog box appears, click **OK**.
  - ❑ Click **Yes** and restart the computer.
  - ❑ When the computer restarts, repeat from step 2 in **Installing a driver (page 155)**.
- ❑ If your device is not displayed in the **Properties** dialog box, the device is not working properly. Repeat steps 1 through 4 in the previous sections to check the driver's installation. Click your device, then click **Uninstall** to remove the driver. Click **Yes** to restart the computer. When the computer restarts, repeat from step 2 in **Uninstalling a driver (page 160)**.

## Updating a driver

To update the driver, proceed as follows:

- 1 Click **Start** on the taskbar.
- 2 Click **Control Panel**.
- 3 Click the **Printers and Other Hardware** icon.  
And then click the device you want to revert.
- 4 On the **Hardware** tab, click **Properties**.
- 5 On the **Driver** tab, click **Update Driver**.
- 6 Follow the instructions that appear on your screen. You can have Windows search for the driver, or point to the driver's location yourself.

Or:

- 1 Click **Start** on the taskbar.
- 2 Click **My Computer** from the menu.
- 3 Click **View system information** on the left of the window.
- 4 Click the **Hardware** tab, then click **Device Manager**.
- 5 Double-click the option corresponding to the device you installed, then double-click your device.  
The **Properties** dialog box appears.
- 6 Click the **Driver** tab.
- 7 Click **Update driver**.  
The driver is updated.



To install your device driver, you must log on to your computer as a user with administrator rights.

## Uninstalling a driver

Leave the device connected to your computer while uninstalling the driver.

To uninstall the driver, proceed as follows:

- 1 Click **Start** on the taskbar.
- 2 Click **Control Panel**.
- 3 Click the **Printers and Other Hardware** icon.  
And then click the device you want to revert.
- 4 On the **Hardware** tab, click **Properties**.
- 5 On the **Driver** tab, click **Uninstall**.
- 6 When the **Confirm Device Removal** dialog box appears, click **OK**.
- 7 If you are prompted to restart your computer, click **Yes**.  
The **Uninstall** button is unavailable if removing the driver would make your device unusable.

Or:

- 1 Click **Start** on the taskbar.
- 2 Click **My Computer** from the menu.
- 3 Click **View system information** on the left of the window.
- 4 Click the **Hardware** tab, then click **Device Manager**.
- 5 Double-click the option corresponding to the device you installed, then double-click your device.  
The **Properties** dialog box appears.
- 6 Click the **Driver** tab.
- 7 Click **Uninstall**.



- 8 When the **Confirm Device Removal** dialog box appears, click **OK**.  
The driver is uninstalled.



To uninstall your device driver, you must be logged on to your computer with administrator rights.

## Restoring a driver

System Restore is a feature of Microsoft Windows XP that restores your computer to a previous state, if a problem occurs, without losing your personal data files.

System Restore monitors changes to the system, and it automatically creates easily identified restore points. These restore points allow you to revert the system to a previous time. They are created daily and at the time of significant system events (such as when an application or driver is installed).

To revert to your previous driver, proceed as follows:

- 1 Open the device that is not working correctly in **Control Panel**.

To open the device:

- Click **Start** on the taskbar.
- Click **Control Panel**.  
The **Control Panel** window appears.
- Click the **Printers and Other Hardware** icon.
- And then click the device you want to revert.

- 2 On the **Hardware** tab, click **Properties**.

- 3 Click the **Driver** tab.

- 4 On the **Driver** tab, click **Roll Back Driver**.

Or:

- 1 Click **Start** on the taskbar.
- 2 Click **My Computer** from the menu.
- 3 Click **View system information** on the left of the window.
- 4 Click the **Hardware** tab, then click **Device Manager**.
- 5 Double-click the option corresponding to the device you installed, then double-click your device. The **Properties** dialog box appears.
- 6 Click the **Driver** tab.
- 7 On the **Driver** tab, click **Roll Back Driver**.  
You have your previous driver back.



You must be logged on to your computer with administrator rights in order to complete this procedure.

Restoring your computer does not affect or change your personal data files.

For more information about System Restore, see the Windows **Help and Support Centre**.

## Downloading drivers

Note that it is possible to download the latest versions of drivers for your computer on our website.

To download the latest drivers, proceed as follows:

- 1 Go to [www.vaio-link.com](http://www.vaio-link.com) and choose your language.
- 2 Select **Drivers and Updates** and follow the procedure.

For more information, follow the instructions you received with the device, or see the printed **Recovery Guide**.



Downloading or installing drivers not provided by VAIO-Link might cause compatibility issues.

## Upgrading your VAIO computer

Your computer and memory modules use high precision components and electronic connectors technology. To avoid the invalidation of your guarantee by mishandling, it is recommended that:

- You contact your dealer to install a new memory module.
- You do not install it yourself, if you are not familiar with upgrading memory on a computer.
- You do not touch the connectors or open the memory panel.

Contact VAIO-Link if you need assistance.

### *Adding and removing memory\**

In the future you may want to change or add memory modules in order to expand the functionality of your computer. You can increase the memory by installing optional memory modules.

Be careful when changing memory. Mistakes on installation or removal of the memory module may cause a malfunction.

Only use memory modules that are compatible with your computer. If a memory module is not detected by your computer or Windows presents unstable operation, contact your sales dealer or the manufacturer of your memory module.

Electrostatic discharge can damage electronic components. Before touching a memory module, ensure the following:

- Handle the memory module gently.
- The procedures described in this document assume familiarity with the general terminology associated with personal computers and with the safety practices and regulatory compliance required for using and modifying electronic equipment.
- Disconnect the system from its power source (that is, battery or AC adapter) and from any telecommunication links, networks, or modems before you open the system. Failure to do so may result in personal injury or equipment damage.

- ❑ Electrostatic Discharge (ESD) can damage memory modules and other components. Install the memory module only at an ESD workstation. If such a station is not available, do not work in a carpeted area, and do not handle materials that produce or hold static electricity (cellophane wrappers, for example). Ground yourself by maintaining contact with an unpainted metal portion of the chassis while performing the procedure.
- ❑ Do not open the memory module package until you are ready to change the module. The package protects the module from ESD.

! Use the special bag delivered with the memory module or wrap the module in aluminium foil to protect it from electrostatic discharge.

Introducing any liquids or any foreign substances or objects into the memory slots, or other internal components of the computer, will result in damage to the computer and any repairs will be out of warranty.

! Do not place the memory module in places subject to:

- Heat sources such as radiators or air ducts,
- Direct sunlight,
- Excessive dust,
- Mechanical vibration or shock,
- Strong magnets or speakers that are not magnetically shielded,
- Ambient temperature of more than 35°C (95°F) or less than 5°C (41°F),
- High humidity.

! Handle the memory module with care. To avoid injuries to your hands and fingers, do not touch the edges of the components and circuit boards inside your computer.

\* Depending on the configuration of your computer, the number of available slots varies.

## Removing and installing a memory module

### VGN-A series

To change or add a memory module to the memory module slot on the bottom of the computer, proceed as follows:

- 1 Shut down your computer and disconnect all peripheral devices.
- 2 Unplug the computer and remove the battery pack.
- 3 Wait until the computer cools down.
- 4 Unscrew the central screw on the bottom of the computer and remove the memory module compartment cover.

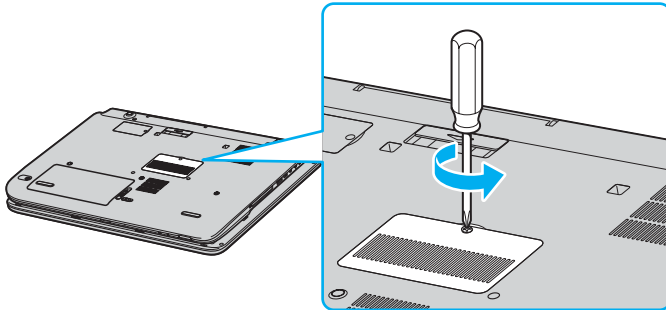

- 5 Touch a metal object (such as the connector panel on the back of the computer) to discharge static electricity.

**6** Remove the memory module:

- Pull the tabs in the direction of the arrows (1).  
The memory module is released.

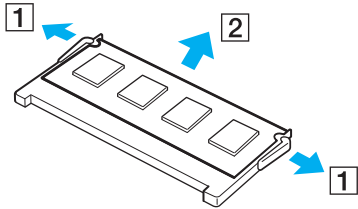

- Make sure that the memory module tilts up and then pull it out in the direction of the arrow (2).

**7** Remove the new memory module from its packaging.**8** Install the memory module.

- Slide the memory module into the slot.

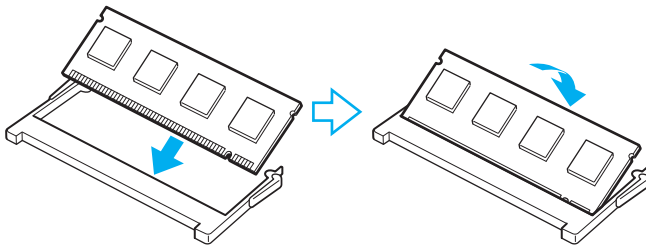

- Push in the memory module until it clicks into place.

**!**  
Do not touch any other components on the motherboard.



- 9 Close the memory module compartment cover and then tighten the screws on the bottom of the computer.
- 10 Reinstall the battery pack and turn on the computer.

To change or add a memory module to the memory module underneath the keyboard, proceed as follows:

- 1 Shut down your computer and disconnect all peripheral devices.
- 2 Unplug the computer and remove the battery pack.
- 3 Wait until the computer cools down.
- 4 Unscrew the two screws next to the memory slot.

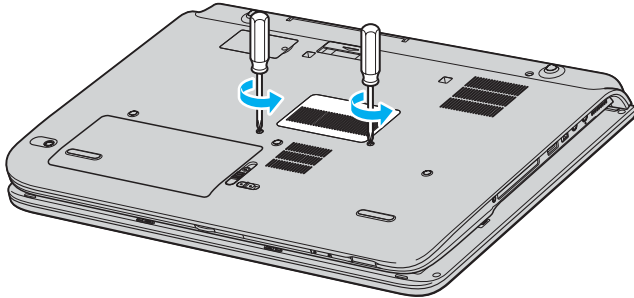

- 5 Turn over the computer upside down and lift open the LCD.

- 6 Introduce a sharp object (such as a fine screwdriver) between the keys indicated on the picture (1) and push gently upwards.

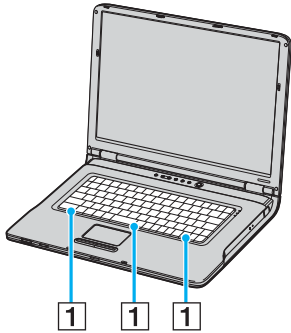

- 7 Lift the keyboard from the touchpad side, turn it over the indicators, and gently prop it up against the LCD display. Be careful not to detach the cable when lifting the keyboard.

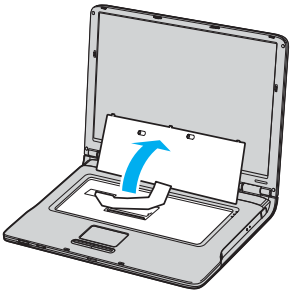

- 8 Touch a metal object (such as the connector panel on the back of the computer) to discharge static electricity.

**9** Remove the memory module:

- Pull the tabs in the direction of the arrows (1).  
The memory module is released.

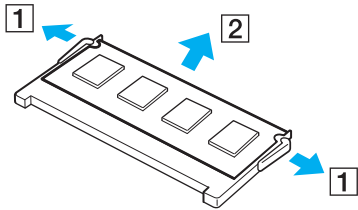

- Make sure that the memory module tilts up and then pull it out in the direction of the arrow (2).

**10** Remove the new memory module from its packaging.

**11** Install the memory module.

- ❑ Slide the memory module into the slot.

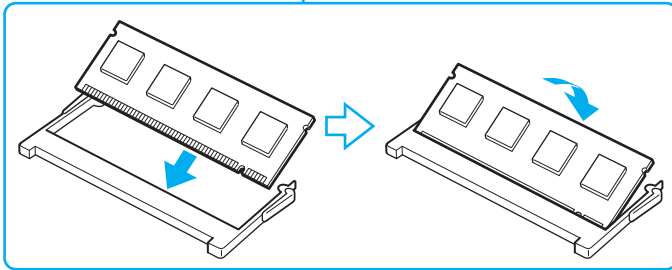
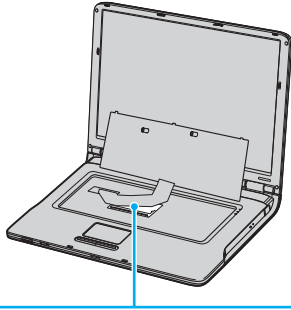

- ❑ Push in the memory module until it clicks into place.

**!** Do not touch any other components on the motherboard.

**12** Gently replace the keyboard and then press it into the computer.

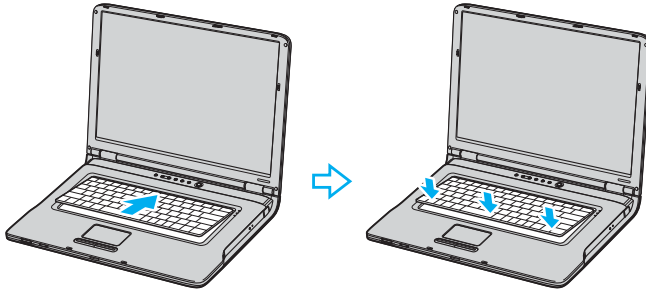

**13** Close the LCD and turn over the computer upside down.

**14** Close the memory module compartment cover and then tighten the screws on the bottom of the computer.

**15** Reinstall the battery pack and turn on the computer.

## PCG-K series

To change or add a memory module, proceed as follows:

- 1 Shut down your computer and disconnect all peripheral devices.
- 2 Unplug the computer and remove the battery.
- 3 Wait until the computer cools down.
- 4 Unscrew the screw on the bottom of the computer and remove the memory module compartment cover.

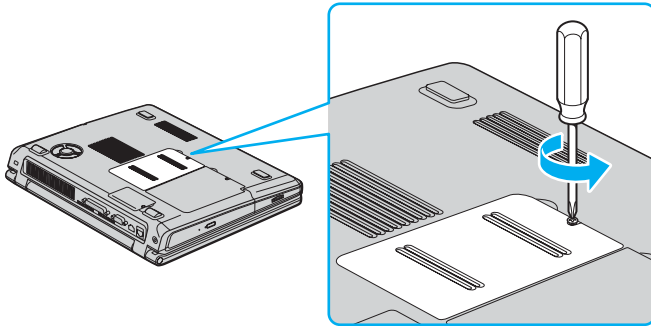

- 5 Touch a metal object (such as the connector panel on the back of the computer) to discharge static electricity.

**6** Remove the memory module:

- Pull the tabs in the direction of the arrows (1).  
The memory module is released.

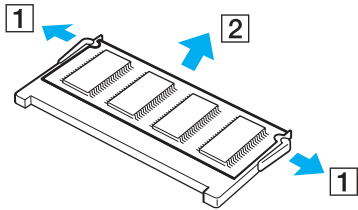

- Make sure that the memory module tilts up and then pull it out in the direction of the arrow (2).

**7** Remove the new memory module from its packaging.

- 8 Slide the memory module into the memory module slot and push it in until it clicks into place.

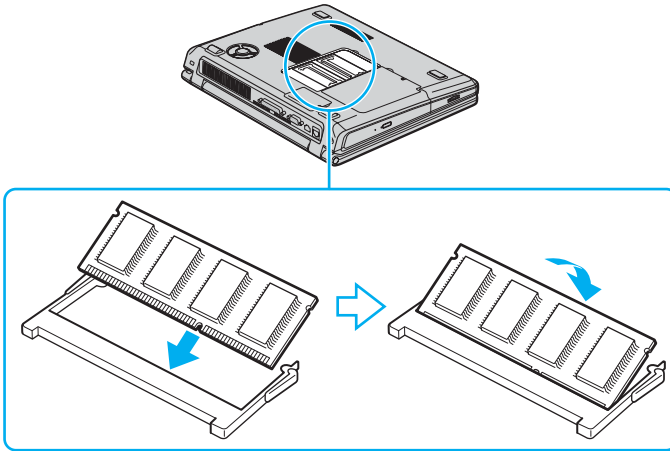

**!** Do not touch any other components on the motherboard.

- 9 Replace the memory module compartment cover.
- 10 Tighten the screw on the bottom of the computer.
- 11 Reinstall the battery pack and turn on the computer.



## *Viewing the amount of memory*

To view the amount of memory, proceed as follows:

- 1 Turn on the computer.
- 2 Go to **VAIO Control Center** via the **Start** menu.
- 3 Double-click the **System Information** folder in the **VAIO Control Center** window.
- 4 Double-click the **System Information** icon in the **System Information** folder.

You can view the amount of system memory. If the additional memory does not appear, repeat the whole procedure and restart the computer.

## Changing the Video Memory Size

If your computer is the PCG-K415B model, you can change the video memory size.

**!** Disconnect all peripheral devices but the AC adapter before changing the video memory size. When the change is complete, connect all the peripheral devices back again.

The video memory shares the overall memory with the standard RAM. Thus, changing the video memory size will also change the standard RAM size.

Changing the video memory size may degrade performance of some software applications.

To change the video memory, proceed as follows:

- 1 Click **Start** and then **Turn Off Computer** to display the **Turn off computer** window. Click **Turn Off** to shut down your computer. If Windows is not running properly, press and hold the power button for at least four seconds to shut down your computer.
- 2 Turn on your computer.
- 3 Press the <F2> key while the **VAIO** logo is on the screen.  
After the message "Entering SETUP..." appears at the bottom left of the screen, the BIOS setup screen appears. If the message "Entering SETUP..." does not appear, press the <F2> key a few times.
- 4 Press the right arrow key to select **Advanced** on the upper menu tab.
- 5 Press the down arrow key to select **UMA Video Memory Size** and press the <Enter> key.
- 6 When **32MB/64MB/128MB** appears, press the up arrow key to select a desired value and press the <Enter> key.
- 7 Press the <Esc> key.
- 8 Confirm that **Exit (Save Changes)** is selected and then press the <Enter> key. If not selected, press the up or down arrow key to select the option.

- 9 When the message "Save configuration changes and exit now?" appears, select **Yes** and press the <**Enter**> key. Your computer restarts.
- 10 Check the video memory size.
  - 1 Click **Start**, point to **All Programs**, then click **VAIO Control Center**. The **VAIO Control Center** window appears.
  - 2 Click **System Information** to see the value indicated for **Video Memory**.

## Getting help

This section describes how to get help and support if something goes wrong with your computer.

Sony offers you many support options for your computer.

### *Sony support options*

See **Documentation pack (page 8)** for details on the printed and online documentation delivered with your computer, as well as further sources of reference.

### *Other sources of information*

- Go to the online **help files** that accompany your software for instructions on using the software.
- VAIO-Link website:** if you have any problem with your computer, you can access the VAIO-Link website for troubleshooting. Go to <http://www.vaio-link.com>.
- e- Support:** This interactive part of our website <http://www.vaio-link.com> allows you to get in contact with our dedicated support team over the internet. Using a personalised account, you can log your technical queries with ease.
- VAIO-Link help lines:** Before contacting VAIO-Link by telephone, try to solve the problem by reading the online and printed documentation.
- Visit the other Sony websites:
  - [www.club-vaio.com](http://www.club-vaio.com) if you want to know more about VAIO and become part of the growing VAIO community.
  - [www.sonystyle-europe.com](http://www.sonystyle-europe.com) for online purchases.
  - [www.sony.net](http://www.sony.net) for other Sony products.



You need to set up an Internet connection before you can access the online features described here.

## *e-Support*

### *What is e-Support?*

You have searched our user guides and website ([www.vaio-link.com](http://www.vaio-link.com)) but have not found an answer to your question/issue? e-Support is the ideal solution for you!

Our e-Support Web Portal is an interactive website on which you can submit any technical query you may have regarding your VAIO and receive answers from our dedicated support team.

Every submitted query will result in a unique 'case number' to ensure smooth communication between yourself and the e-Support Team.

### *Who can use e-Support?*

All registered VAIO customers are entitled to unlimited access to the VAIO-Link e-Support Web Portal.

### *How can I access the e-Support portal?*

When you register your VAIO computer online at Club-VAIO ([www.club-vaio.com](http://www.club-vaio.com)), you will automatically receive an email with the link to the e-Support Web Portal, your Customer ID and some basic explanation a few hours later.

All you need to do is activate your account by clicking on the provided link in the email.

You are now ready to create your first case!

You can access the e-Support Web Portal from any computer with an active Internet connection.

A complete help file is available on the e-Support Web Portal to help you use our e-Support Service.

### *Can I submit questions in my native language?*

Since you are interacting with our e-Support Team through a portal, which connects you directly to our central database, e-Support will only accept and deal with queries submitted in English.

### *Can I submit my questions at any time?*

Yes, you can submit your questions 24/7, but please keep in mind that our e-Support Team can only treat your queries from Monday till Friday between 8am and 6pm.

### *Is there a cost involved for using e-Support?*

No, this is a complete free of charge service offered to all registered VAIO customers!

How do I know when the e-Support Team has handled my query/case?

As soon as your case has been dealt with by our e-Support Team, you will receive an email, notifying you that your case has been updated.

## Precautions

This section describes safety guidelines and precautions to help you protect your computer from potential damage.

- On handling the hard disk ([page 184](#))**
- On handling the LCD screen ([page 185](#))**
- On using the power source ([page 186](#))**
- On handling your computer ([page 187](#))**
- On handling floppy disks ([page 188](#))**
- On handling discs ([page 189](#))**
- On using the battery pack ([page 190](#))**
- On using headphones ([page 190](#))**
- On handling Memory Sticks ([page 191](#))**
- On handling the memory card adapter ([page 192](#))**

## *On handling the hard disk*

The hard disk has a high storage density and reads or writes data in a short time. However, it can be easily damaged by mechanical vibration, shock or dust.

Although the hard disk has the internal safety device to prevent losing data due to mechanical vibration, shock or dust, you should be careful when handling your computer.

To avoid damaging your hard disk:

- Do not subject your computer to sudden movements.
- Keep the computer away from magnets.
- Do not place your computer in a location subject to mechanical vibration or in an unstable position.
- Do not move your computer while the power is on.
- Do not turn off the power or restart the computer while reading or writing data to disk.
- Do not use your computer in a place subject to extreme changes in temperature.



If the hard disk is damaged, the data cannot be restored.



## *On handling the LCD screen*

- Do not leave the LCD facing the sun as it can damage the LCD. Be careful when using the computer near a window.
- Do not scratch the LCD or exert pressure on it. This could cause a malfunction.
- Using the computer in low temperature conditions may produce a residual image on the screen. This is not a malfunction. When the computer returns to normal temperature, the screen returns to normal.
- A residual image may appear on the screen if the same image is displayed for a lengthy period of time. The residual image disappears in a while. You can use a screensaver to prevent residual images.
- The screen becomes warm during operation. This is normal and does not indicate a malfunction.
- The LCD is manufactured using high-precision technology. You may, however, see tiny black points and/or bright points (red, blue, or green) that continuously appear on the LCD. This is a normal result of the manufacturing process and does not indicate a malfunction.
- Avoid rubbing the LCD screen, as this can damage the screen. Use a soft, dry cloth to wipe the LCD screen.

## *On using the power source*

- See the printed **Specifications** sheet to check the power operation of your VAIO.
- Do not share the AC outlet with other power-consuming equipment, such as a photocopier or shredder.
- You can purchase a power strip with a surge protector. This device prevents damage to your computer caused by sudden power surges, in an electrical storm, for example.
- Do not place heavy objects on the power cord.
- To disconnect the cord, pull it out by the plug. Never pull the cord itself.
- Unplug your computer from the wall outlet if you are planning to not use the computer for a long time.
- Make sure that the socket outlet is easily accessible.
- When the AC adapter is not used, unplug it from the AC outlet.
- Use the AC adapter that comes with your computer or genuine Sony products. Do not use any other AC adapter as it may cause a malfunction.

## *On handling your computer*

- Clean the cabinet with a soft cloth, which is either dry or lightly moistened with a mild detergent solution. Do not use any type of abrasive pad, scouring powder, or solvent such as alcohol or benzine, as these may damage the finish of your computer.
- Should you drop a solid object or any liquid onto the computer, shut down your computer and then unplug it. You may want to have the computer checked by qualified personnel before operating it again.
- Do not drop the computer or place heavy objects on top of the computer.
- Do not place your computer in a location subject to:
  - Heat sources, such as radiators or air ducts,
  - Direct sunlight,
  - Excessive dust,
  - Moisture or rain,
  - Mechanical vibration or shock,
  - Strong magnets or speakers that are not magnetically shielded,
  - Ambient temperature of more than 35°C (95°F) or less than 5°C (41°F),
  - High humidity.
- Do not place electronic equipment near your computer. The electromagnetic field of your computer may cause a malfunction.
- Provide adequate air circulation to prevent internal heat from building up. Do not place your computer on porous surfaces such as rugs or blankets, or near material such as curtains or draperies that may block its ventilation slots.
- The computer uses high-frequency radio signals and may cause interference to radio or TV reception. Should this occur, relocate the computer a suitable distance away from the set.
- Use only specified peripheral equipment and interface cables; otherwise, problems may occur.
- Do not use cut or damaged connection cables.

- If the computer is brought directly from a cold location to a warm one, moisture may condense inside your computer. In this case, allow at least one hour before turning on your computer. If any problems occur, unplug your computer and contact VAIO-Link.
- Make sure you disconnect the power cord before cleaning the computer.
- As you may lose important data once your computer is damaged, you should back up your data regularly. You can restore most of the original application programs from the supplied disc (see the printed **Recovery Guide** for details).

### *On handling floppy disks*

- Do not open the shutter manually or touch the surface of the floppy disk.
- Keep floppy disks away from magnets.
- Keep floppy disks away from direct sunlight and other sources of heat.
- Keep the floppy disk away from any liquid. Do not let the floppy disk get wet. When you are not using the floppy disk, always remove it from the floppy disk drive and use a storage case.
- If the floppy disk comes with a label, make sure that the label is properly attached. If the edge of the label is curled up, the label may stick to the inside of the floppy disk drive and cause a malfunction or damage your floppy disk.

## On handling discs

- Do not touch the surface of the disc.
- Do not drop or bend the disc.
- Fingerprints and dust on the surface of a disc may cause read errors. Always hold the disc by its edges and central hole, as shown:

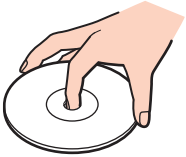

- Proper care of the disc is essential to its continuous reliability. Do not use solvents such as benzine, thinning agents, commercially available cleaners or anti-static spray, as they may cause damage to the disc.
- For normal cleaning, hold the disc by its edge and use a soft cloth to wipe the surface from the centre out.
- If the disc is badly soiled, moisten a soft cloth with water, wring it out well, and use it to wipe the surface of the disc from the centre out. Wipe off any remaining moisture with a dry soft cloth.
- Never put stickers on discs. This will affect the use of the disc irreparably.

## *On using the battery pack*

- Never leave the battery pack in temperatures above 60°C (140°F), such as in a car parked in the sun or under direct sunlight.
- Battery life is shorter in a cold environment. This is due to decreased battery efficiency at low temperatures.
- Charge the batteries at temperatures between 10°C to 30°C (18°F to 86°F). Lower temperatures require a longer charging time.
- While the battery is in use or being discharged, the battery pack heats up. This is normal and is not cause for concern.
- Keep the battery pack away from all sources of heat.
- Keep the battery pack dry.
- Do not open or try to disassemble the battery pack.
- Do not expose the battery pack to any mechanical shock.
- If you are not using the computer for an extended period of time, remove the battery pack from the computer to prevent damage to the battery.
- If, after fully charging the battery pack, the battery power is still low, the battery pack may be reaching the end of its life and should be replaced.
- You do not need to discharge the battery before recharging.
- If you have not used the battery pack for a considerable amount of time, recharge the battery.

## *On using headphones*

- Road safety** – Do not use headphones while driving, cycling, or operating any motorized vehicle. It may create a traffic hazard and is illegal in some areas. It can also be potentially dangerous to play loud music while walking, especially at pedestrian crossings.
- Preventing hearing damage** – Avoid using headphones at high volume. Hearing experts advise against continuous, loud and extended play. If you experience a ringing in your ears, reduce the volume or discontinue use.

## *On handling Memory Sticks*

- Do not touch the Memory Stick connector with your finger or metallic objects.
- Use only the label supplied with the Memory Stick as a label.
- Do not bend, drop, or apply strong shock to the Memory Stick.
- Do not disassemble or modify Memory Sticks.
- Do not let Memory Sticks get wet.
- Do not use or store Memory Sticks in a location subject to:
  - Extremely high temperatures, such as in a car parked in the sun,
  - Direct sunlight,
  - High humidity or,
  - Corrosive substances.
- Use the storage case supplied with the Memory Stick.

## *On handling the memory card adapter (VGN-A series)*

- Do not touch the memory card adapter connector with your finger or metallic objects.
- Use only the label exclusively designed for the memory card adapter as a label.
- Do not bend, drop, or apply strong shock to the memory card adapter.
- Do not disassemble or modify the memory card adapter.
- Do not let the memory card adapter get wet.
- Do not use or store the memory card adapter in a location subject to:
  - Extremely high temperatures, such as in a car parked in the sun,
  - Direct sunlight,
  - High humidity or,
  - Corrosive substances.
- Use the storage case supplied with the memory card adapter.



## Trademarks

Sony, Battery Checker, Click to DVD, DVgate Plus, HotKey Utility, Keyboard Utility, Memory Stick Formatter, PictureGear Studio, Prepare your VAIO, SonicStage, SonicStage Mastering Studio, VAIO Control Center, VAIO Edit Components, VAIO Launcher, VAIO Media, VAIO Power Management, VAIO System Information, VAIO Zone, Memory Stick, the Memory Stick logo, VAIO and the VAIO logo are trademarks of Sony Corporation.

All ATI product and product feature names and logos are trademarks and/or registered trademarks of ATI Technologies Inc.

Microsoft, Internet Explorer, Windows Movie Maker, Windows Media Player, Windows XP Professional, Windows XP Home Edition, Microsoft Works and the Windows logo are trademarks or registered trademarks of Microsoft Corporation in the U.S. and other countries.

i.LINK is a trademark of Sony used only to designate that a product contains an IEEE1394 connection.

Adobe, Adobe Acrobat Elements, Adobe Acrobat Professional, Adobe Photoshop Album, Adobe Reader, Adobe Premiere Standard and Adobe Photoshop Elements are trademarks of Adobe Systems Incorporated.

MoodLogic is a trademark of MoodLogic, Inc.

Norton Internet Security 2004 and Norton Password Manager 2004 are trademarks or registered trademarks of Symantec Corporation.

RecordNow! is a trademark of Sonic.

WinDVD for VAIO is a trademark of InterVideo, Inc.

Sun Java VM is a trademark of Sun Microsystems, Inc.

Google Toolbar is a trademark of Google.

Yahoo! Messenger is a trademark of Yahoo!.

SafeGuard PrivateDisk is a trademark of Utimaco Software.

My Info Centre contains Macromedia Flash™ Player software by Macromedia, Inc., Copyright © 1995-2003 Macromedia, Inc. All rights reserved. Macromedia and Flash are trademarks of Macromedia, Inc.

ATHEROS and Atheros Driven are trademarks of Atheros Communications, Inc. The Atheros and Atheros Driven logos are registered trademarks of Atheros Communications, Inc.

All other names of systems, products and services are trademarks of their respective owners. In the manual, the ™ or ® marks are not specified.

Specifications are subject to change without notice. All other trademarks are trademarks of their respective owners.

**Please see the printed Specifications sheet to see what software is available for your model.**