

# Sony Notebook Computer User Guide

PCG-735/PCG-737



**SONY®**

## Notice to Users

© 1998 Sony Corporation. All rights reserved. This manual and the software described herein, in whole or in part, may not be reproduced, translated, or reduced to any machine-readable form without prior written approval.

SONY CORPORATION PROVIDES NO WARRANTY WITH REGARD TO THIS MANUAL, THE SOFTWARE, OR OTHER INFORMATION CONTAINED HEREIN AND HEREBY EXPRESSLY DISCLAIMS ANY IMPLIED WARRANTIES OR MERCHANTABILITY OR FITNESS FOR ANY PARTICULAR PURPOSE WITH REGARD TO THIS MANUAL, THE SOFTWARE OR SUCH OTHER INFORMATION. IN NO EVENT SHALL SONY CORPORATION BE LIABLE FOR ANY INCIDENTAL, CONSEQUENTIAL, OR SPECIAL DAMAGES, WHETHER BASED ON TORT, CONTRACT, OR OTHERWISE, ARISING OUT OF OR IN CONNECTION WITH THIS MANUAL, THE SOFTWARE, OR OTHER INFORMATION CONTAINED HEREIN OR TO USE THERE.

Sony Corporation reserves the right to make any modification to this manual or the information contained herein at any time without notice. The software described herein is governed by the terms of a separate user license agreement.

Sony and VAIO are registered trademarks of Sony Corporation. Windows and the Windows 98 logo are registered trademarks of Microsoft Corporation. Intel, MMX, and Pentium are trademarks of Intel Corporation.

All other trademarks are trademarks of their respective owners.

As an ENERGY STAR Partner, Sony has determined that this product meets the ENERGY STAR guidelines for energy efficiency.

Energy Star is an U.S. registered mark.

## Safety Information

### Owner's Record

The model number and serial number are located on the bottom of your Sony Notebook Computer. Record the serial number in the space provided here. Refer to the model and serial number when you call your Sony Service Center.

Model Number: PCG-735/PCG-737

Serial Number: \_\_\_\_\_

### WARNING

- Audio and picture distortion may occur if this equipment is positioned in close proximity to any equipment emitting electromagnetic radiation.
- To prevent fire or shock hazard, do not expose your Sony Notebook Computer to rain or moisture.
- To avoid electrical shock, do not open the cabinet. Refer servicing to qualified personnel only.
- Never install modem or telephone wiring during a lightning storm.
- Never install telephone jacks in wet locations unless the jack is specifically designed for wet locations
- Never touch uninsulated telephone wire or terminals unless the telephone line has been disconnected at the network interface.
- Use caution when installing or modifying telephone lines.
- Avoid using the modem during an electrical storm.
- Do not use the modem or a telephone to report a gas leak in the vicinity of the leak.
- Plugable equipment: the socket-outlet shall be installed near the equipment and shall be easily accessible.
- Use your notebook only with the supplied AC adapter.

## Regulatory Information

This product conforms with the following European Directives:  
73/23/EEC (Low Voltage Directive)  
89/336/EEC (EMC Directive)  
93/68/EEC (CE-Marking Directive)

This equipment complies with EN 55022 Class B and EN 50082-1 for use in following areas: residential, business and light-industrial.

This equipment has been tested and found to comply with the limits set out in the EMC Directive for using a connection cable shorter than 3 metres (9,8 feet).

The CD-ROM is classified as a CLASS 1 LASER PRODUCT and complies with the Laser Products Safety Standard EN 60825-1. Repair and maintenance only by authorized Sony technicians. Improper repairs can create a safety hazard.

**CLASS 1  
LASER PRODUCT  
TO EN 60825-1**

## DISPOSAL OF LITHIUM ION BATTERY.



In some areas the disposal of lithium ion batteries in household or business trash may be prohibited. Please use the public collection system.  
Dispose of properly at end-of-life.



**Danger of explosion if battery is incorrectly replaced. Replace only with the same or equivalent type recommended by the manufacturer.**



**The battery pack used in this device may present a fire or chemical burn hazard if mistreated. Do not disassemble, heat above 100°C (212 °F) or incinerate. Dispose of used battery promptly. Keep away from children.**



# Contents

## **Welcome**

Unpacking Your Notebook Computer .....	2
Ergonomic Considerations .....	3

## **Using Your Notebook Computer**

Locating the Controls and Connectors .....	5
Connecting a Power Source .....	8
Starting Your Computer .....	12
Shutting Down Your Computer .....	13
Registering Windows® 98.....	14
Registering Your Computer .....	15
Using the Keyboard.....	16
Using the Touchpad .....	22
Using the Floppy Disk Drive .....	23
Using the CD-ROM Drive .....	26
Using the Headphone with Remote Control .....	29
Using PC Cards .....	32
Using Infrared Communication Devices.....	34
Using Power Saving Modes .....	36
Using a Second Battery Pack.....	38
Using the Weight Saver .....	40

## **Connecting Peripheral Devices**

Connecting a PC card modem .....	42
Connecting the Docking Station.....	44
Connecting a Printer.....	51
Connecting an External Display .....	52
Connecting an External Mouse or Keyboard.....	55

# Contents

Connecting External Speakers.....	56
Connecting an External Microphone.....	57
Connecting a Digital Still Camera or Other Serial Device.....	58
Connecting a Digital Video Camera Recorder.....	59
Connecting a Universal Serial Bus (USB) Device .....	60
<b>Using the Mediabar</b>	
Mediabar Functions .....	62
<b>Customizing Your Notebook Computer</b>	
Displaying the Sony Notebook Setup Screen .....	63
Controlling Power Management.....	65
Displaying Battery Information .....	67
Selecting the Display Mode .....	70
<b>Getting Help</b>	
About Sony's Support Options .....	73
Troubleshooting .....	75
Using the System and Application Recovery CD .....	79
<b>Notes on Use.....</b>	<b>83</b>
Adding Memory.....	88
<b>Index.....</b>	<b>91</b>

# Welcome

Congratulations on your purchase of the Sony Notebook Computer. Sony has combined leading-edge technology in audio, video, computing, and communications to provide you with state-of-the-art personal computing.

Here are just some of the features your Sony Notebook Computer has to offer (read the details in your *About Your Sony Notebook Computer* guide).

- ❑ **Exceptional performance** –Your PC includes a fast Intel® Pentium® processor with MMX™ technology, a 24x (maximum performance) CD-ROM drive, and a 56 kbps PC card modem.
- ❑ **Portability** – The rechargeable battery pack provides two to five hours of use without AC power.
- ❑ **Sony audio and video quality** – High-quality, “Sony Tuned” MPEG1 video, which supports full-screen display (12.1-inch Active Matrix LCD screen for the PCG-737 and 12.1-inch Passive Matrix LCD screen for the PCG-735) and enables you to take advantage of today’s advanced multimedia applications, games, and entertainment software.
- ❑ **Multimedia features** – Enjoy the stereo speakers or use the supplied headphone to listen to audio and video CDs. The headphone includes a remote control. You can even listen to audio CDs when your computer is in suspend (sleep) mode.
- ❑ **Windows® 98** –Your system includes the latest operating system from Microsoft.
- ❑ **Communications** – Access popular online services, send and receive e-mails, browse the Internet, and use the built-in speakerphone, answering machine, and fax features.
- ❑ **Excellent customer support: VAIO Link** – If you have some problems with your computer, you can contact VAIO Link by telephone, fax or e-mail (see your *Customer Service Guide*). Before calling VAIO Link, try to solve the problem by reading your User Guide (troubleshooting chapter) or the manuals and helpfiles of the peripherals or software.

# Unpacking Your Notebook Computer

Remove the following hardware items from the box:

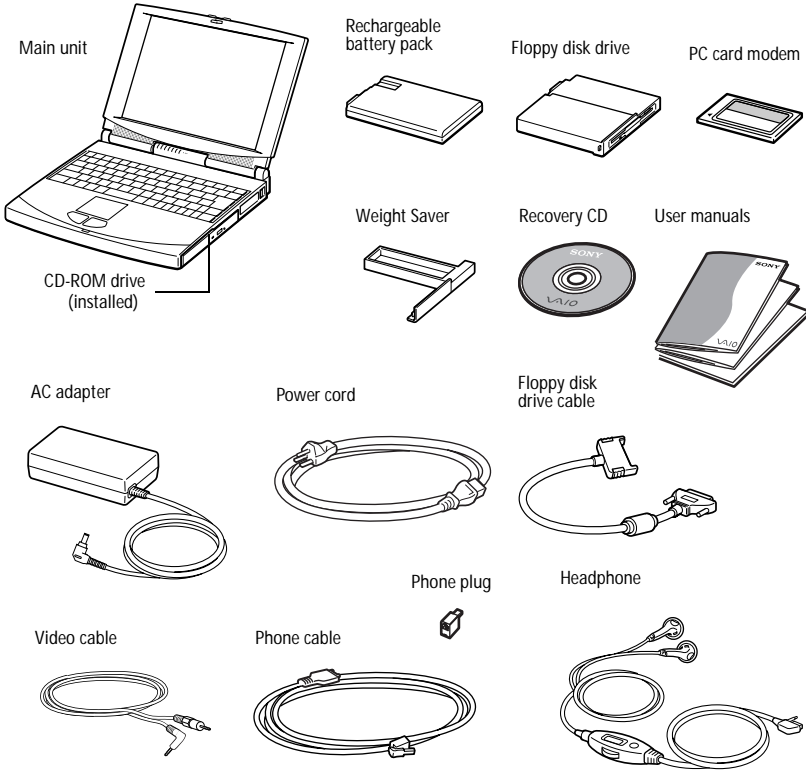

You can find the complete list of the items that come with your computer in the *About Your Sony Notebook Computer* guide.



## Ergonomic Considerations

You will be using your notebook computer as a portable device in a variety of environments. Whenever possible, you should attempt to apply the following ergonomic considerations to both stationary and portable environments.

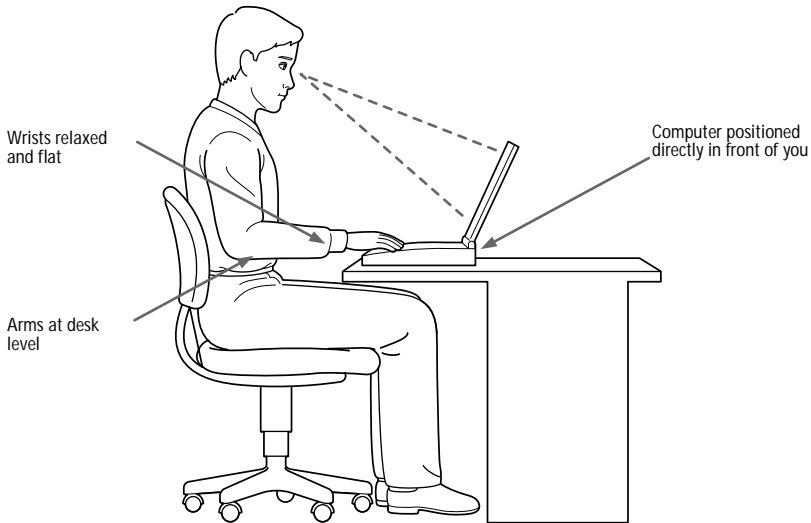

- ❑ **Position of your computer** – Place the computer directly in front of you as you work. Keep your forearms horizontal with your wrists in a neutral, comfortable position while using the keyboard, touchpad, or external mouse. Let your upper arms hang naturally at your sides. Take breaks during sessions with your computer. Excessive use of the computer may strain muscles or tendons.
- ❑ **Furniture and posture** – Sit in a chair with good back support. Adjust the level of the chair so your feet are flat on the floor. A footrest may make you more comfortable. Sit in a relaxed, upright posture and avoid slouching forward or leaning far backward.
- ❑ **Viewing angle of the computer's display** – Use the display's tilting feature to find the best position. You can reduce eye strain and muscle fatigue by adjusting the tilt of the display to the proper position. Adjust the contrast or brightness settings of the display also.

- ❑ **Lighting** – Choose a location where windows and lights do not create glare and reflection on the display. Use indirect lighting to avoid bright spots on the display. You can also purchase accessories for your display that help reduce glare. Proper lighting adds to your comfort and work effectiveness.
- ❑ **Tilt stand** – You use the tilt stand to place the computer at an angle that allows comfortable typing.

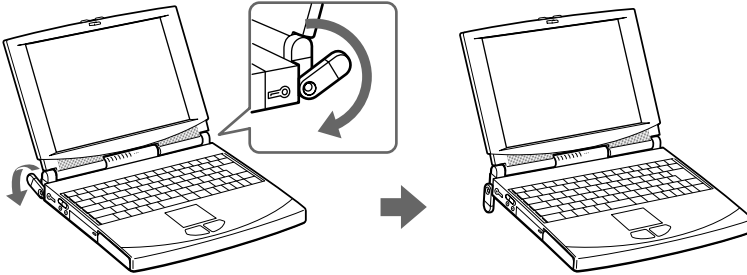

- ❑ **Placement of an external display** – When using an external display, set the display at a comfortable viewing distance. Make sure the display screen is at eye level or slightly lower when you are sitting in front of the monitor.

# Using Your Notebook Computer

This section describes how to start using your computer and how to use your computer's internal and external devices, such as the touchpad, floppy disk drive, and CD-ROM drive.

## Locating the Controls and Connectors

### Front

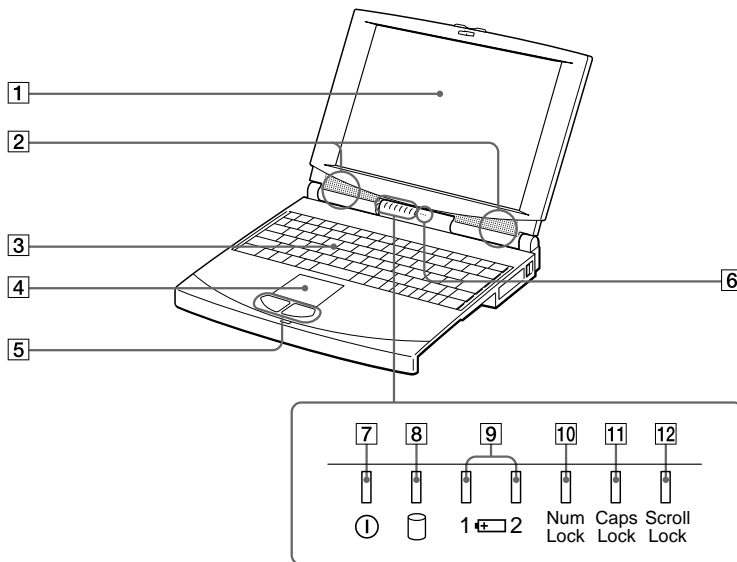

- 1 LCD screen (pages 20, 83)
- 2 Speakers (page 56)
- 3 Keyboard (page 16)
- 4 Touchpad (page 22)
- 5 Left/right button (page 22)
- 6 Microphone (page 57)

- 7 Power indicator (pages 12, 18)
- 8 Hard disk drive indicator (page 18)
- 9 Battery 1/2 indicators (pages 18, 67)
- 10 Num Lock indicator (page 19)
- 11 Caps Lock indicator (page 19)
- 12 Scroll Lock indicator (page 19)

## Left

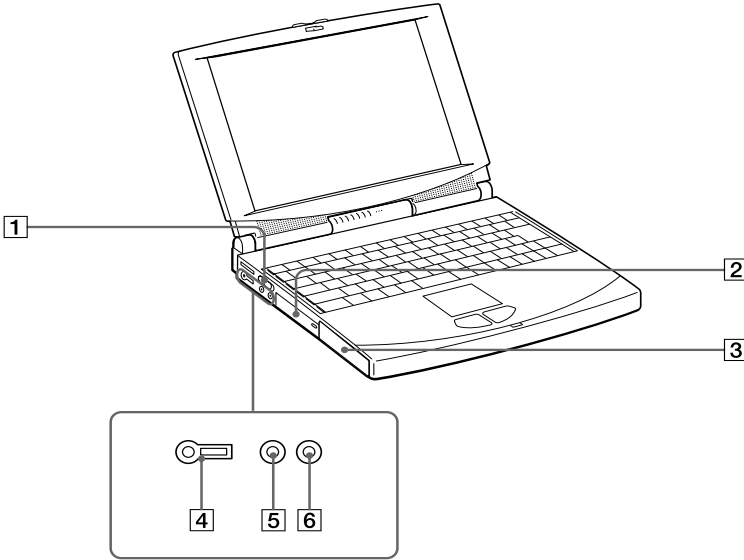

- |   |                           |   |                                    |
|---|---------------------------|---|------------------------------------|
| 1 | Power switch (page 12)    | 4 | Headphone connector (pages 29, 56) |
| 2 | Hard disk drive           | 5 | Microphone connector (page 57)     |
| 3 | Battery bay (pages 9, 47) | 6 | Line In connector                  |

 There is a ventilation slot located directly above the headphone connector. Do not cover the ventilation slot when your computer is on.

 All connectors for this notebook are: SELV (Safety Extra Low Voltage), according to EN60950.

## Right

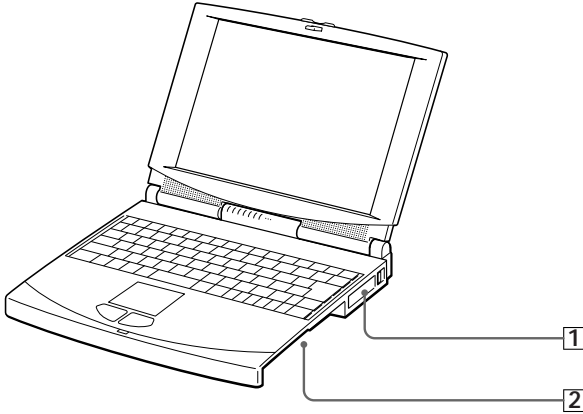

- 1 PC card slots (page 32)
- 2 Multi-purpose bay (page 23)

## Back

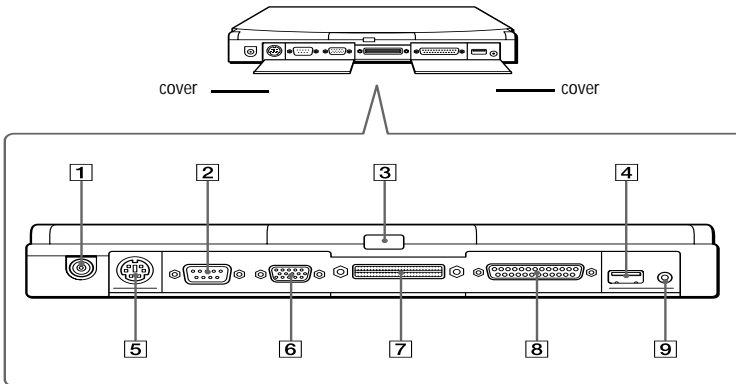

- 1 DC In (page 8)
- 2 IO/IO Serial COM1 connector (page 58)
- 3 Infrared port (page 34)
- 4 USB connector (page 60)
- 5 Mouse/Keyboard connector (page 55)
- 6 Monitor connector (page 52)
- 7 Docking station (page 44)
- 8 FDD/Printer connector (page 51)
- 9 Video Out connector (page 54)

## Connecting a Power Source

You can use either AC power or a rechargeable battery pack as a power source.

### Using the AC Adapter

- 1 Plug the cable attached to the AC adapter into the DC In connector on the computer.
- 2 Plug one end of the power cord into the AC adapter.
- 3 Plug the other end of the power cord into an AC outlet.

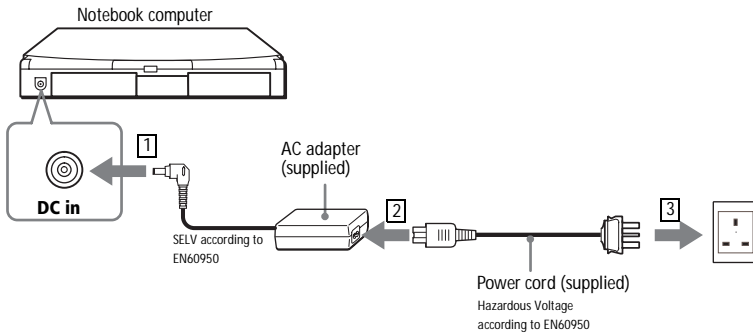

## Using Battery Power

You can use one or two battery packs as a source of power. The second battery pack inserts into the multi-purpose bay on the right side of the computer. (See “Using Power Saving Modes” on page 36.) Additional battery packs are available as a separate option.

The battery pack that comes with your computer is not fully charged at the time of purchase. Follow the steps below to insert and charge the battery pack.

### To insert the battery pack

- 1 Open the cover of the battery bay.

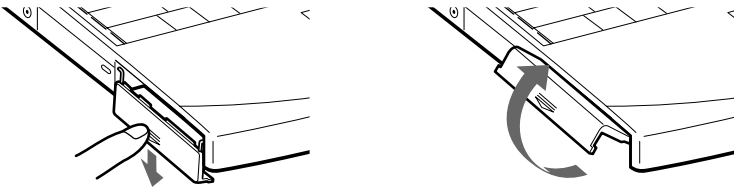

- 2 Insert the battery pack into the battery bay on the left side of the computer.

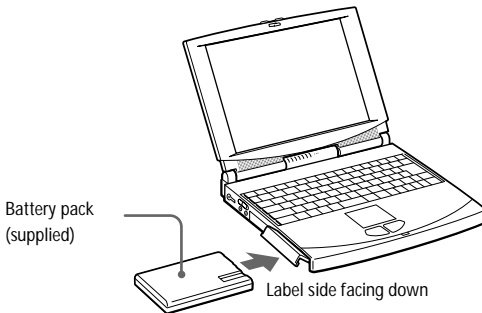

- 3 Close the cover of the battery bay.

### To charge the battery pack

- 1 Connect the AC adapter to the computer.
- 2 Insert the battery pack if needed.

The computer automatically charges the battery (the battery indicator light flashes twice at a slow interval as the battery charges). When the battery is 85% full, the battery indicator light turns off. This process takes approximately two hours. To charge the battery completely, continue charging for an additional hour.

A fully charged battery pack supplies power for approximately 2.5 to 5.5 hours. The time may differ according to the conditions of use. See “Displaying Detailed Battery Information” on page 68 for information on checking the battery life.

There are two battery indicator lights on the computer:

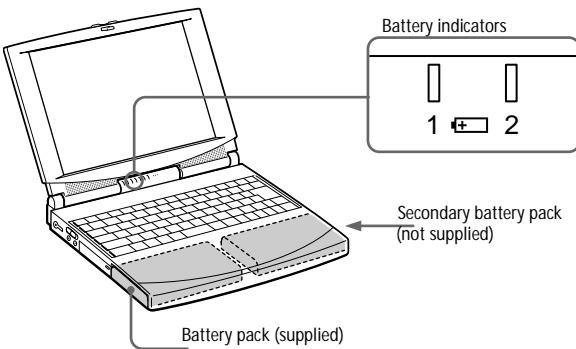

Battery Indicator	Meaning
1	Indicates the status of the battery pack in the battery bay on the left side of the computer.
2	Indicates the status of the battery pack in the multi-purpose bay on the right side of the computer.

Battery Indicator Light Status	Meaning
On	The computer is using battery power.
Flashing with the power indicator	The battery is running out of power.
Flashing twice at a slow interval	The battery is charging.
Off	The computer is using AC power.



 See “Using a Second Battery Pack” on page 38 for information on installing and charging a battery pack in the multi-purpose bay.

Keep the battery pack in the computer while it is directly connected to AC power. The battery pack continues to charge while you are using the computer.

When the remaining battery charge drops to 7%, the computer automatically enters System Hibernation mode. This may result in data loss as the system changes modes.

You can extend battery life by changing the power management modes in the PowerPanel utility. See “Using Power Saving Modes” on page 36.

The battery pack supplied with your computer is a lithium ion battery and can be recharged at any time. Charging a partially discharged battery does not affect battery life.

The battery indicator light is on while you use the battery pack as a power source. When battery life is nearly over, the battery indicator starts flashing.

### To remove the battery pack

- 1 Open the cover of the battery bay.
- 2 Pull out the battery pack.

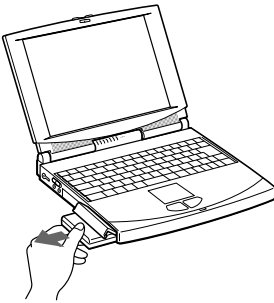

- 3 Close the cover of the battery bay.

## Starting Your Computer

- 1 Slide the LCD lock lever in the direction of the arrow, and lift the cover.

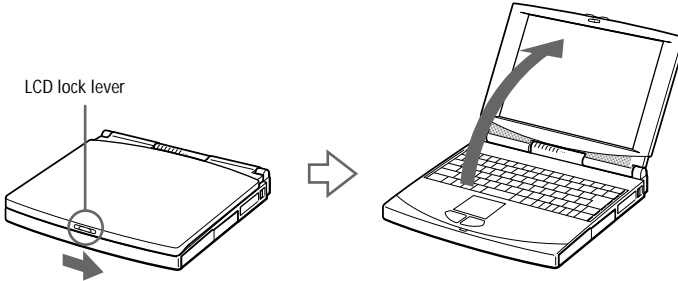

- 2 Slide the power switch on the left side toward the front of the computer until the power indicator light turns on (green).

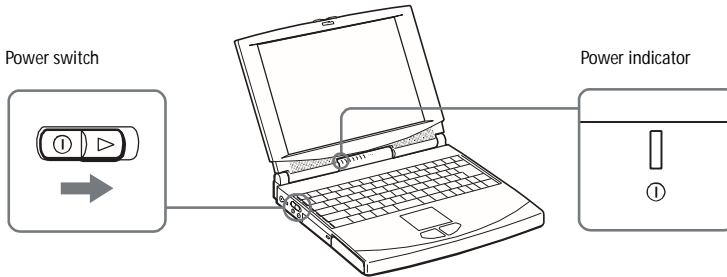

 If you slide the power switch for more than four seconds, the computer turns off.

 Note on contrast (PCG-735 only): as the contrast of a LCD is variable, adjust the contrast as follows:

To increase contrast, press Fn+F6 and then ↓ or ←

To decrease contrast, press Fn+F6 and then ↑ or →.

# Shutting Down Your Computer

**!** To avoid potential loss of data, follow these steps to shut down your computer.

- 1 Click the Start button on the Windows 98 taskbar.
- 2 Click Shut Down at the bottom of the Start menu to display the Shut Down Windows dialog box.



- 3 Select Shut Down.
  - 4 Click OK.
- 5 Wait for your computer to turn off automatically.
- 6 Turn off any peripherals connected to your computer.

 Respond to any prompts warning you to save documents.

 If you are unable to shut down your computer using the steps described above, press the Ctrl+Alt+Delete keys at the same time and select Shut Down in the Task manager window to restart the computer. If you are unable to restart the computer in this way, you can slide the power switch forward and hold for four seconds. This operation may result in data loss.

During a period of inactivity, you can conserve battery life by using system suspend mode. See “Controlling Power Management” on page 65.

## Registering Windows® 98

The first time you turn on your computer, you need to complete a few steps to register and configure the Windows 98 software that is already installed on your computer.



You must register Windows 98 before you can use the computer.

The on-screen instructions guide you through the registration and configuration process. The following is an overview of the process.

### 1 Gathering information:

- Enter your name.
- Read and accept the License Agreement.
- Enter your Certificate of Authenticity number located on the cover of the *Introducing Windows 98* manual.

### 2 Windows 98 setup:

- Click the Finish button on the Windows 98 Setup Wizard screen.

### 3 Selecting your computer settings:

- If necessary, change the Time Zone, Date and Time on the Date/Time Properties screen.

### 4 Learning about Windows 98:

- If you want, take the tour of Windows 98.

## Registering Your Computer

You can take advantage of Sony's commitment to quality customer support and receive the following benefits by registering your computer with Sony:

- ❑ **VAIO Link** – You can contact VAIO Link by telephone, fax or e-mail (see your *Customer Service Guide*).
- ❑ **Extended Warranty** – Protect your investment. See the Limited Warranty Card for details. See your “Service Guide” for extended warranty conditions.

Follow these steps to use the Sony Notebook Computer's online registration service.



You must connect your phone line before using any online services, including the online registration service. See “Connecting a PC card modem” on page 42.



- 1** Enter the information requested on the first online registration form.
- 2** Complete the remaining forms by clicking the Next button each time you complete a form.
- 3** Click the Register Now button to register your computer. Your computer automatically transfers your registration information using your PC card modem and a preset telephone number.

# Using the Keyboard

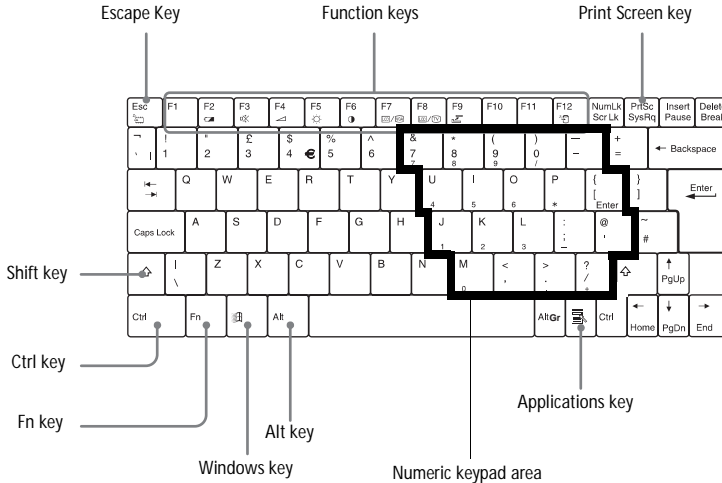







Your keyboard is very similar to a desktop computer's, the keyboard has additional keys that perform specific computer-related tasks.







Keys	Descriptions
Numeric keypad area	Contains the keys found on a typical calculator. Use the numeric keypad area to type numbers or to perform mathematical calculations such as addition and subtraction. Note that you must press the Num Lock key to activate the numeric keypad. (When you do so, the Num Lock light will be on.)
Navigation keys	Several keys are devoted to moving the cursor on the screen (the four arrow keys which also function as the Home, End, Page Up, and Page Down keys).
Correction keys	The Insert, Back Space, and Delete keys enable you to make corrections in your documents.

Keys	Descriptions
Function keys	The twelve function keys along the top of the keyboard are used to perform designated tasks. For example, in many applications, F1 is the Help key. The task associated with each function key may vary from one application to the next.
Escape key	The Esc (Escape) key is used to cancel commands
Print Screen key	The Print Screen key takes an electronic snapshot of the screen and places it in the Windows Clipboard. You can then paste the screen shot into a document and print it.
Operator keys	Several keys are always used with at least one other key: Ctrl, Alt, and Shift. When held down with another key, the Ctrl (Control) and Alt (Alternate) keys offer another way to give commands. For example, in many applications, instead of choosing the Save command from a menu, you can hold down Ctrl and press S (referred to as Ctrl+S). The Shift key is used to produce capital letters or special symbols such as @ and \$.
Windows key 	The key with the Windows logo displays the Windows 98 Start menu; it's the equivalent of clicking the Start button on the task bar. See "Combinations and Functions with the Windows Key" on page 18.
Fn key	The Fn key is used in combination with other keys to issue commands. See "Combinations and Functions with the Fn Key" on page 20.
Applications key 	The Applications key displays a shortcut menu of context-sensitive choices; pressing this key is the equivalent of clicking the right mouse button.

## Combinations and Functions with the Windows Key

Combinations	Functions
 + F1	Displays Windows Help.
 + Tab	Switches the selected button on the taskbar.
 + E	Displays Windows Explorer.
 + F	Displays the Windows Find window to find a file or folder. This is the equivalent of selecting Find from the Start menu.
 + Ctrl + F	Displays Find window. This is the equivalent of selecting Find from the Start menu.
 + M	Minimizes all displayed windows.
Shift +  + M	Returns all minimized windows to their previous size.
 + R	Displays the Run window. This is the equivalent of selecting Run from the Start menu.
 + Pause + Fn+Break	Displays the Properties window. This is the equivalent of double-clicking the System icon in the Control Panel.















## Indicators



Indicators	Functions
Power 	Lights when the power to the computer is turned on. Flashes in system suspend mode. Turns off when the computer is in System Hibernation mode or powered off.
Hard disk 	Lights when data is being read from or written to the hard drive. Do not enter system suspend mode or turn off the computer when this indicator light is on.
Battery 1 1 	Indicates the status of the battery inserted in the battery bay on the left side of the computer.
Battery 2  2	Indicates the status of the battery inserted in the multi-purpose bay on the right side of the computer.

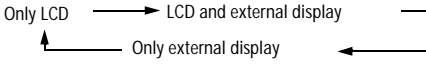

<b>Light</b>	<b>On</b>	<b>Off</b>
Num Lock	Turns on when the number keys area in the numeric keypad are active.	Turns off when the alphanumeric character keys in the keypad area are active.
Caps Lock	Turns on when the letters appear in uppercase as you type. The Shift key lowers the case of typed letters when Caps Lock is on.	Turns off when letters appear in lower case as you type (unless you hold down the Shift key).
Scroll Lock	Turns on when the screen scrolls differently. (Exactly how it scrolls depends on the specific application. It has no effect in many applications.)	Turns off when information moves across the display normally.

## Combinations and Functions with the Fn Key

Combinations/ Feature	Functions
Fn+  (ESC) System suspend mode	Puts the system into system suspend mode, a power management state. To return the system to the active state, press any key or press the power switch on your computer.
Fn+  (F2) Display power status	Displays the power status, as in the two examples below:  Using AC power  Charging the battery
Fn+  (F3) Speaker switch	Toggles the built-in speaker between off and on.
Fn+  (F4) Speaker volume	Adjusts the built-in speaker volume. To increase volume, press Fn+F4, then ↑ or →. To decrease volume, press Fn+F4, then ↓ or ←.
Fn+  (F5) Brightness control	Adjusts the brightness of the LCD. To increase light intensity, press Fn+F5 and then ↑ or →. To decrease light intensity, press Fn+F5 and then ↓ or ←.
Fn+  (F6) Contrast control	(For PCG-735) Adjusts the contrast control on the LCD display. To increase contrast, press Fn+F6, then ↓ or ←. To decrease contrast, press Fn+F6, then ↑ or →.  (For PCG-737) The contrast control is not currently used on the LCD display.
Fn+  /  (F7) Switch to the external display	Toggles between LCD, external display (connected to the  Monitor connector) and both LCD and external display. 
Fn+  /  (F8) Select video out	Toggles between LCD and TV connected to the  Video Out connector.

Combinations/ Feature	Functions
Fn+  (F9)	Disconnects from the docking station when the power is on, in case that the charged battery is inserted in the computer.
Fn+  (F12) System hibernation mode	Provides for the lowest level of power consumption. When you execute this command, the state of the system and state of the peripheral devices are written to the hard disk and the system power is turned off. To return the system to the original state, use the power switch to turn on the power.
Fn+E Eject CD-ROM	Ejects the CD-ROM tray. This command is active only when the CD-ROM tray is in the multi-purpose bay; it is inactive when the drive is in the docking station.
Fn+F Change the display size	Zooms the display size in or out when the display is set to VGA mode.
Fn+D Video standby	Turns off the LCD in order to save power.
Fn+S System idle	Puts the system in idle mode, a power management state. When the system enters idle mode, the hard disk and video enter a low power state, and the CPU clock and the processor are not active.

## Using the Touchpad

The keyboard contains a cursor-pointing device called a touchpad. You can point to, select, drag, and scroll objects on the screen using the built-in touchpad.

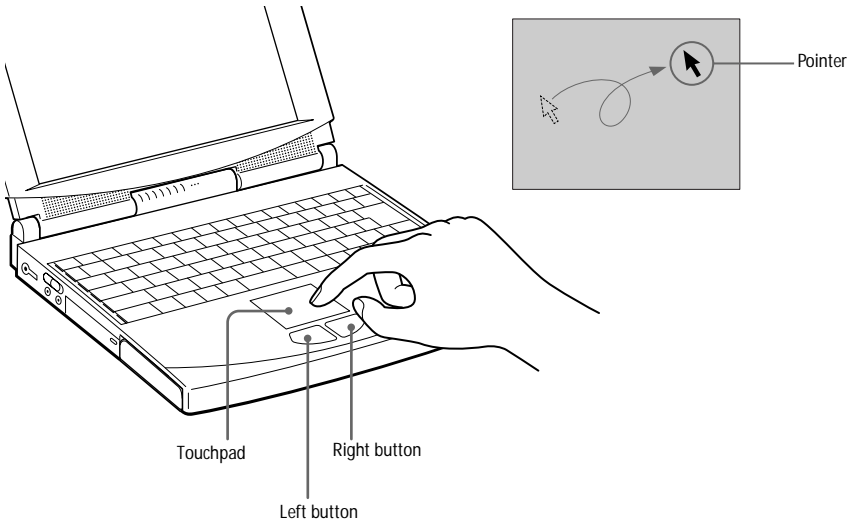

Actions	Descriptions
Point	Slide one finger on the touchpad to place the pointer on an item or object.
Single-click	Press the left button once.
Double-click	Press the left button twice.
Right-click	Press the right button once. In many applications, this action displays a shortcut menu of context-sensitive choices.
Drag	Slide one finger while pressing the left button. When your finger reaches a touchpad edge, the pointer keeps moving until you lift your finger. Use this action to select and move objects.
Scroll	Move your finger along the right edge of the touchpad.

 See Mouseware Help for information on touchpad features, such as middle button click, adjusting touchpad speed, and Wheel Mouse functions. To access Mouseware Help, double-click the Mouse icon in the Control Panel and click the Help button.

## Using the Floppy Disk Drive



There are two ways to connect the floppy disk drive to your computer:

- ❑ Externally, by connecting it to the computer's FDD/Printer connector.
- ❑ Internally, by inserting it into the multi-purpose bay.

The computer comes with the CD-ROM drive in the multi-purpose bay. If you want to use both the CD-ROM and the floppy disk drive at the same time, use the floppy disk drive as an external drive.

If you connect the floppy disk drive externally while your computer is on, use the Sony Notebook Setup utility to select Floppy Disk Drive. See "Displaying the Sony Notebook Setup Screen" on page 63 for details.

### To connect the floppy disk drive externally

- ❑ Connect the floppy disk drive to the  /  FDD/Printer connector using the external floppy disk drive cable.

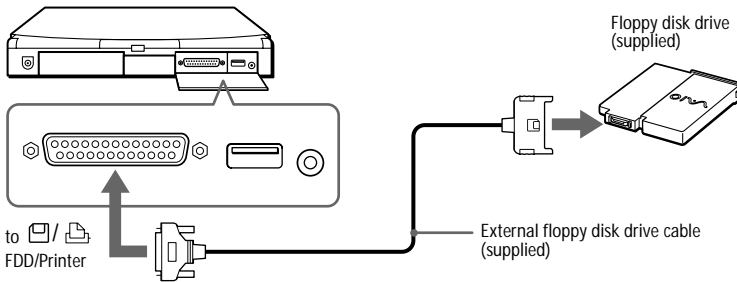

### To insert the floppy disk drive

- 1 Turn off the computer.
- 2 If another device is in the multi-purpose bay, remove the device. See “To remove the CD-ROM drive” on page 28 or “To remove the second battery pack” on page 39.
- 3 Insert the floppy disk drive into the multi-purpose bay with the VAIO label facing up. Continue pushing the drive into the bay until the Eject lever locks into place.

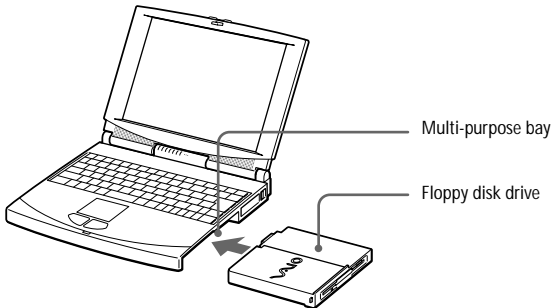

### To insert a diskette

- 1 Hold the diskette with the label side facing up.
- 2 Gently push the diskette into the drive until it clicks into place.

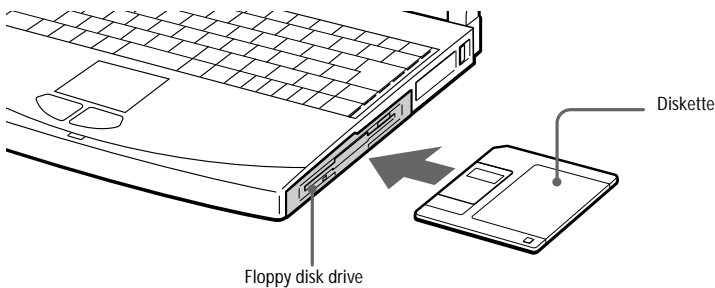

### To remove a diskette

- ❑ When you finish using the diskette, press the Eject button to remove the diskette.



 If you have difficulty removing a diskette from the floppy disk drive, remove the floppy disk drive from the multi-purpose bay.

### To remove the floppy disk drive

- 1 Turn off the computer.
- 2 There is an Eject lever on the bottom of the floppy disk drive. Slide this lever in the direction of the arrow.

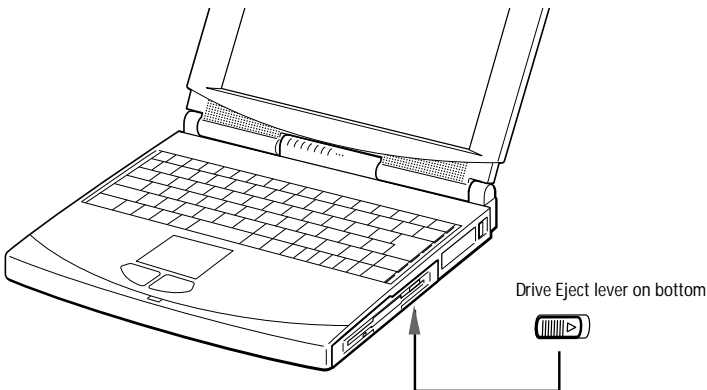

- 3 Slide the drive out of the multi-purpose bay.
- 4 Insert the weight saver. See "Using the Weight Saver" on page 40.

## Using the CD-ROM Drive

Your computer comes with the CD-ROM drive in the multi-purpose bay. You can remove it so that you can use other devices in the multi-purpose bay.

### To insert a CD-ROM disc

- 1 Turn on the computer.

 When the computer is in System Suspend or System Hibernation mode, you cannot insert a CD-ROM disc. See “Controlling Power Management” on page 65 for more information on System Suspend and System Hibernation modes.

- 2 Press the Eject button to open the CD-ROM drive.

The CD tray slides out.

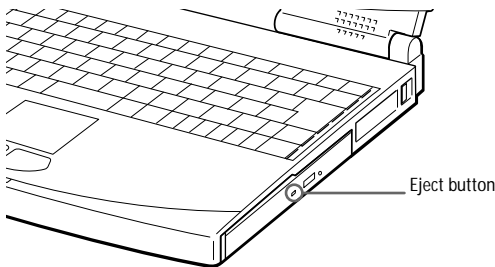

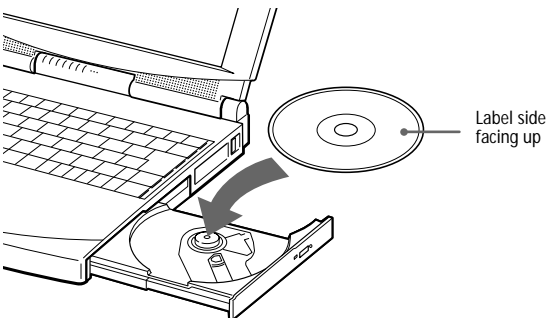

- 3 Place the CD-ROM disc in the tray with the label side facing up. Push the disc onto the hub until the disc clicks into place.





### 4 Close the tray by pushing it gently.

-  Be sure to seat the CD-ROM disc firmly over the CD-ROM drive hub fingers. Failure to do so could damage your CD-ROM drive. You may not be able to open the CD tray properly if you do not seat the disk firmly.
-  When you finish using the CD-ROM, press the Eject button to remove the CD-ROM disc.

When the computer is in system suspend or system hibernation mode, you cannot remove a CD-ROM disc. See “Controlling Power Management” on page 65 for more information about system suspend and system hibernation modes.

If the CD-ROM disc does not come out when you press the Eject button, turn off the computer and insert a sharp, pointed object into the manual eject hole.

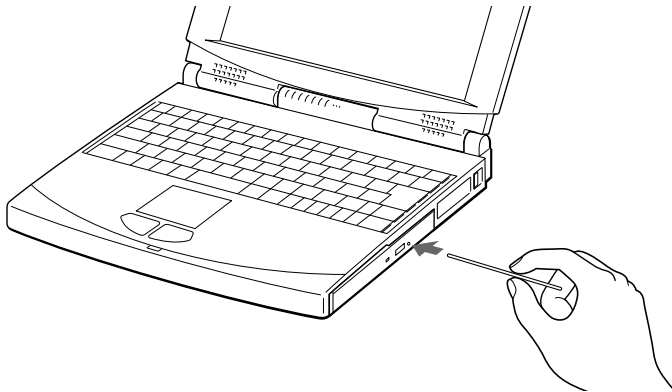

### To remove the CD-ROM drive

- 1 Turn off the computer before removing the CD-ROM drive.
- 2 There is an Eject lever on the bottom of the CD-ROM drive. Slide this lever in the direction of the arrow.

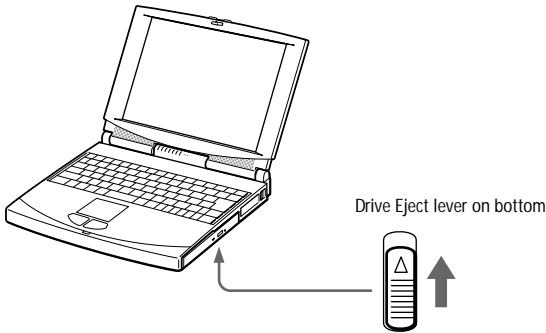

- 3 Slide the drive out of the multi-purpose bay.
- 4 Insert the weight saver. See “Using the Weight Saver” on page 40.

### To re-insert the CD-ROM drive

- 1 Turn off the computer.
- 2 If another device is in the multi-purpose bay, remove the device. See “To remove the floppy disk drive” on page 25 or “To remove the second battery pack” on page 39.
- 3 Insert the CD-ROM drive into the multi-purpose bay with the label side facing up.

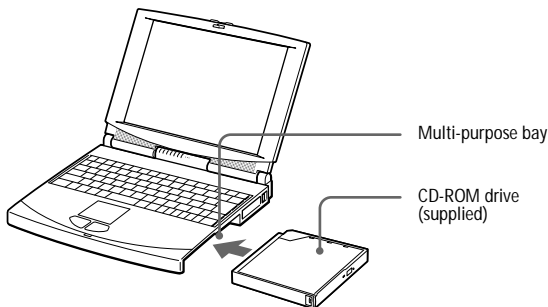

## Using the Headphone with Remote Control

Your computer includes a headphone, which you can use to listen to audio and video CDs. You can listen to audio CDs even when your computer is in system suspend mode.

To use the remote control when your computer is active, you must use the Music/Movie Player software. To use the remote control when your computer is in system suspend mode, follow the directions below.

 See "Using the Mediabar" on page 61 for more information on how to play audio CDs.

### To use the remote control in system suspend mode

- 1 Connect the micro-plug of the headphone to the headphone remote control connector, not to the  Headphone connector of the computer.

 Connect the headphone firmly to the remote control. A loose connection may cause noise during playback.

- 2 Connect the headphone remote control to the  Headphone connector on the computer.

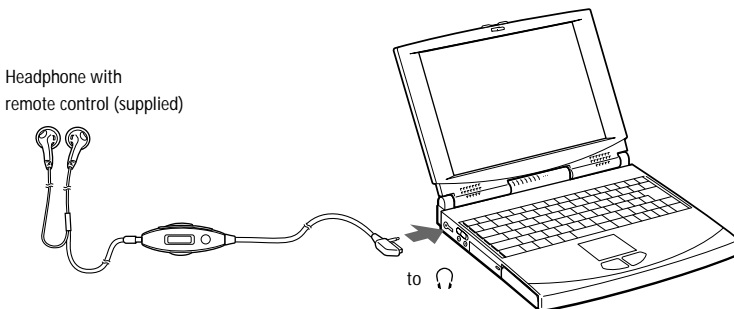

- 3 While holding down the Fn key, press Esc.  
The computer enters system suspend mode.
- 4 Press the  Stop button on the remote control.

**5** Press the Eject button to open the CD-ROM drive.

The CD Tray slides out.

**6** Place the audio CD in the tray and close the tray by gently pushing the tray.

**7** Press the **▶** Play button on the remote control.

Playback begins.

To stop playback, press the **■** Stop button and press the Eject button on the CD-ROM drive. Then remove the CD.



See "Controlling Power Management" on page 65 for more information about System Suspend mode.

To recover from system suspend mode, press any key on the keyboard.

Use only the supplied headphone remote control. You cannot operate this feature with the remote control supplied with other models.

To remove an audio CD from the CD-ROM drive, remove the CD within one minute after pressing the **■** Stop button on the remote control. If the CD tray does not open, press the **■** Stop button and try again.

Your headphone with remote control may look different from the pictures illustrated on pages 29 and 31.

## Using the Remote Control to Play an Audio CD

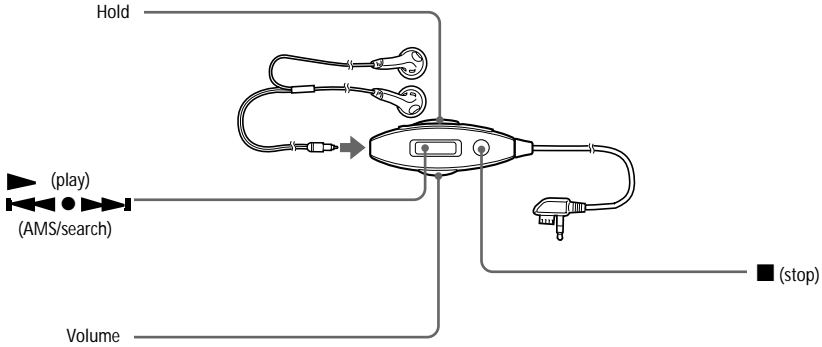

To	Press
Find the beginning of the current track (AMS*)	⏮ ( ⏮ side of ▶ ) once**
Find the beginning of previous tracks (AMS)	⏮ ( ⏮ side of ▶ ) repeatedly**
Find the beginning of the next track (AMS)	▶▶ ( ▶▶ side of ▶ ) once**
Find the beginning of succeeding tracks (AMS)	▶▶ ( ▶▶ side of ▶ ) repeatedly**
Go forward quickly	Hold down ▶▶ ( ▶▶ side of ▶ ) **
Go backwards quickly	Hold down ⏮ ( ⏮ side of ▶ ) **

\*AMS = Automatic Music Sensor

\*\*These operations are possible in both the play and pause modes.

## Using the Hold Switch

You can use the Hold switch to lock the controls of the headphone remote control. When you are not using the headphone remote control, slide Hold in the direction of the arrow. To unlock, slide Hold back.

## Using PC Cards

Your computer includes two PC card slots. PC cards allow you to connect portable external devices, such as a PCMCIA Modem Card, another hard disk drive, additional memory, or to connect a network.

 The PC card slots can accommodate (at the same time) two Type I, two Type II, or one Type III PC card. These slots are compatible with Card Bus. Both upper and lower slots are compatible with ZV (Zoomed Video) port.

### To insert a PC card

Use the lower slot for Type III PC cards.

 To insert the supplied PC card modem, refer to "Connecting a PC card modem" on page 42.

You do not need to shut down the computer before inserting or removing a PC card.

- 1** Pull the PC card release button towards the outside of the computer and push it in.

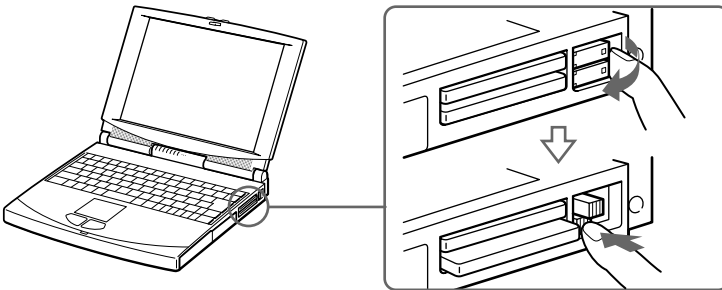

- 2** Remove the PC card slot protector.  
When you use a Type III PC card, you need to remove both the top and bottom PC card slot protectors.

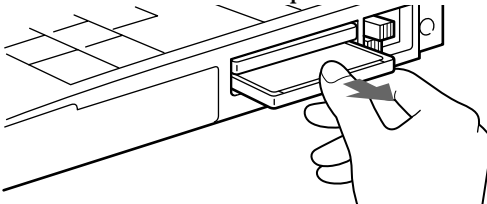

- 3 Insert the PC card into the PC card slot, front label facing up. Gently push the card into the slot until the card is fixed into the connector. The release button comes out.

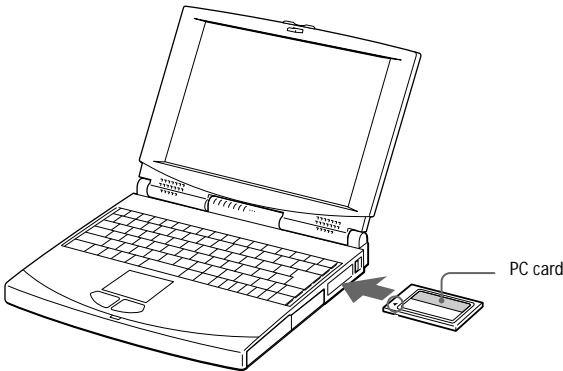

 Do not force a card into the slot. It may damage the connector pins.

If you have difficulty inserting a card, check that you are inserting the card with the correct orientation (see PC card label).

Some PC cards may require you to disable unused devices using Sony Notebook Setup (See "Displaying the Sony Notebook Setup Screen" on page 63.).

Use the latest driver software provided by the PC card's manufacturer.

If you see the "!" mark on the PC card in "Device Manager" tab of "System Properties", remove the driver software and reinstall it.

#### To remove a PC card

- 1 Pull the PC card release button up and press it.
- 2 Gently grasp the card and pull it out.
- 3 Insert the PC card slot protector back into the empty slot.

## Using Infrared Communication Devices

Your computer includes an infrared port, located on the back panel. You can use this port to communicate with other infrared-equipped devices with compatible protocols, such as a digital still camera or other computers.

### To use infrared communication with a digital still camera

Align the infrared ports on the computer and the digital camera so that they are in a direct line.

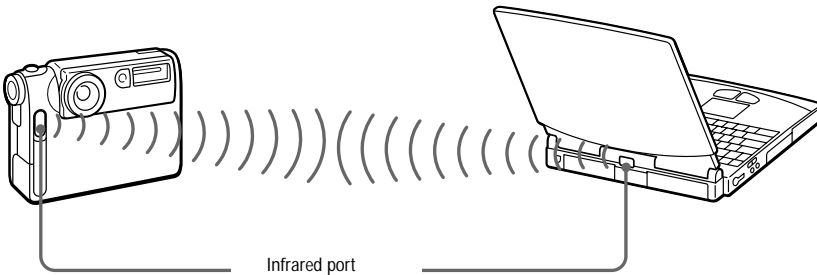

### To use infrared communication with another computer

Align the infrared ports on the two computers so that they are in a direct line.

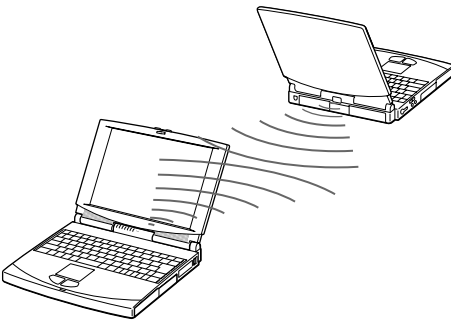



- ☞ Check the Status tag of the Infrared Monitor in the Windows Control Panel to determine if the infrared device is detected.

If the two devices are too far apart or too close together, data transfer may be interrupted or there may be noise in the transmission.

Do not cover the infrared ports with your hand or any other objects.

Avoid direct sunlight, fluorescent light, or flashing incandescent light close to the infrared ports.

See the manual that came with your digital still camera or other infrared communication device for more information on installation and use.

The active area of infrared transmission extends about 1m (39 inches) with a radius of 15 degrees.

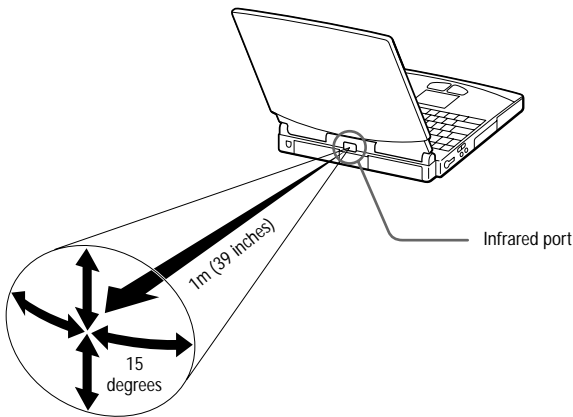

## Using Power Saving Modes

When you use a battery as the source of power for your computer, you can take advantage of power management settings to conserve battery life. In addition to the normal operating mode, which allows you to turn off specific devices, your computer has three distinct power saving modes: System Idle, System Suspend, and System Hibernation. When using battery power, you should be aware that the computer automatically enters System Hibernation mode when the remaining battery charge drops below 7%, regardless of the power management setting you select.

### Normal Mode

This is the normal state of your computer when it is in use. To save power, you can turn off a specific device such as the LCD or the hard disk. The power indicator light is on (green) in this mode.



For details, see "Controlling Power Management" on page 65.

### System Idle Mode

This mode is convenient if you do not need to use your computer for a brief period. The hard disk and video display enter a low power state, and the processor and CPU clock stop. The power indicator light is on (amber) in this mode.

#### To activate system idle mode

Press Fn+S. You can also enter system idle mode using the PowerPanel utility.

#### To return to normal mode

Press any key.

### System Suspend Mode

The computer saves the current state of the system in RAM and switches off power to the CPU. The power indicator light flashes (amber) in this mode.

### To activate System Suspend Mode

Press Fn+Esc, or slide the power switch forward and hold it for three seconds. You can also use the PowerPanel utility to enter system suspend mode.

### To return to Normal Mode

Press any key.

## System Hibernation Mode

The state of the system is saved on the hard drive and power is turned off. The power indicator light is off in this mode.

### To activate system hibernation mode

Press Fn+F12. You can also use the PowerPanel utility to enter system hibernation mode.

### To return to normal mode

Turn on the computer by sliding the power switch forward. The computer returns to its previous state.



When returning from system hibernation mode, the system status stored on the hard disk is erased if you slide the power switch forward and hold for more than four seconds.

- ❑ Steps to return to normal mode:  
Normal mode ← System idle ← System suspend ← System hibernation
- ❑ Steps to reduce Power consumption:  
Normal mode → System idle → System suspend → System hibernation

## Using a Second Battery Pack

You can purchase a second rechargeable battery pack. With two battery packs, you can extend the time that you use your computer with battery power. When using two battery packs, the battery pack you insert first charges first. The battery pack you insert second charges when the first battery pack is 85% full. You can determine which battery pack is charging by the battery indicator light status.

### To insert a second battery pack

- 1 If another device is in the multi-purpose bay, remove the device. See “To remove the floppy disk drive” on page 25 or “To remove the CD-ROM drive” on page 28.
- 2 Insert the battery pack into the multi-purpose bay.

The battery 2 indicator light turns on.

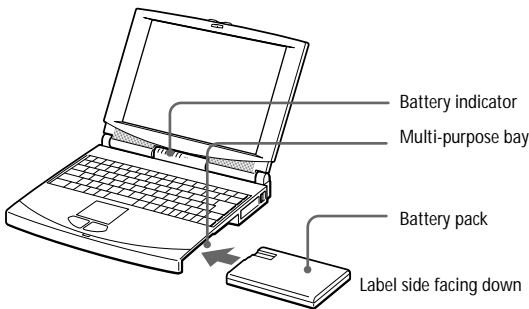

- 3 Attach the Weight Saver to the computer to stabilize the battery pack. See also “Using the Weight Saver” on page 40.

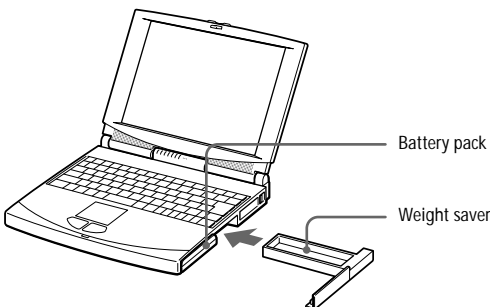

### To charge the second battery pack

Keep the battery pack in the computer while it is connected to AC power. The battery indicator flashes while the battery is charging. See also “To charge the battery pack” on page 9 for more information.

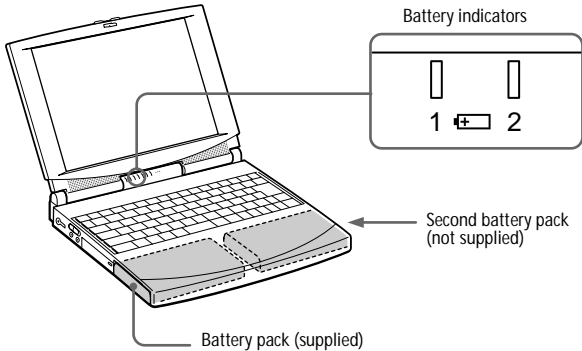

To determine the amount of time the battery lasts, see “Displaying Battery Information” on page 67.

### To remove the second battery pack

- 1 There is an Eject lever on the bottom of the weight saver. To remove the battery pack, slide this lever in the direction of the arrow.

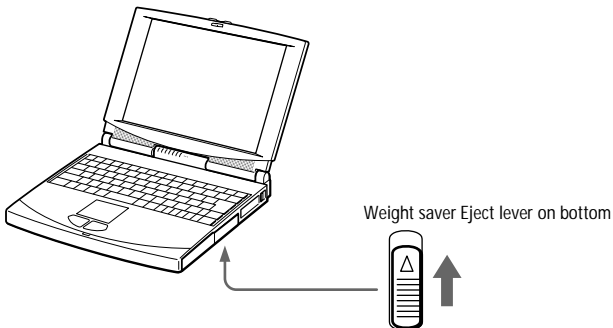

- 2 Remove the weight saver, and then pull out the battery pack.
- 3 Re-insert the weight saver. See “Using the Weight Saver” on page 40.

## Using the Weight Saver

The weight saver protects the multi-purpose bay when it is empty.

### To attach the Weight Saver

- 1 If another device is in the multi-purpose bay, remove the device. See “To remove the floppy disk drive” on page 25, “To remove the CD-ROM drive” on page 28, or “To remove the second battery pack” on page 39.
- 2 Slide the weight saver in the direction of the arrow until it clicks.

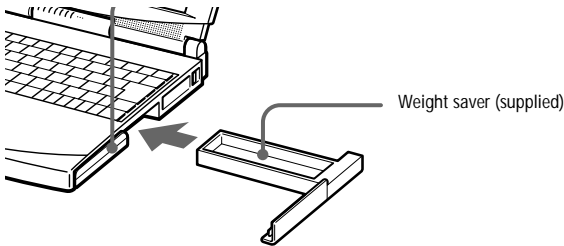

### To remove the Weight Saver

There is an Eject lever on the bottom of the weight saver. To remove the weight saver, slide this lever in the direction of the arrow.

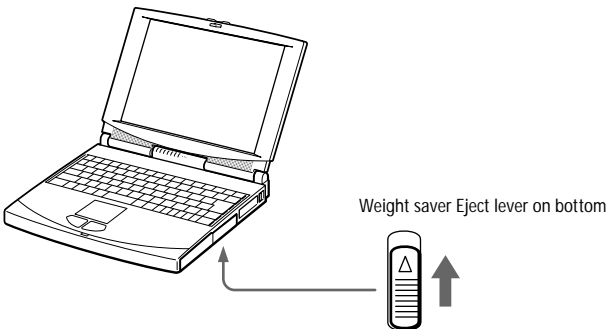

# Connecting Peripheral Devices

You can add functionality to your computer by connecting any of these peripherals:

- ❑ PC card modem (page 42)
- ❑ Docking station (page 44)
- ❑ Printer (page 51)
- ❑ External display (page 52)
- ❑ External mouse or keyboard (page 55)
- ❑ External speakers (page 56)
- ❑ External microphone (page 57)
- ❑ Digital still camera or other serial device (page 58)
- ❑ Digital video camera recorder (page 59)
- ❑ Universal serial bus (USB) device (page 60)



Before you connect peripherals, turn off the computer and all peripherals.

Connect the power cord only after connecting all cables.

Turn on the computer only after turning on all peripherals.

## Connecting a PC card modem

Use your PC card modem to connect to a phone line and access the WWW.

### Connecting to a phone line

You need to connect a phone line to take advantage of online services, the Internet, and VAIO Link. The phone line also enables you to register your computer and software online.

- 1 Use any of both PC cards slots of your notebook computer. Pull the PC card release button away from the computer. Remove the PC card slot protector as described in the “Using PC cards” chapter, page 32. Insert the PC card modem (supplied) in the slot of the computer (label facing up), push it gently until the release button ejects completely. Put back the release button.

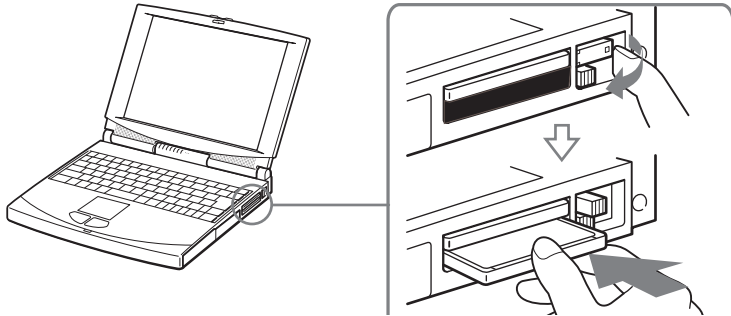

- 2 Plug the phone line jack into the left connector of the PC card.
- 3 Plug the other end into the wall jack (use the phone plug supplied).

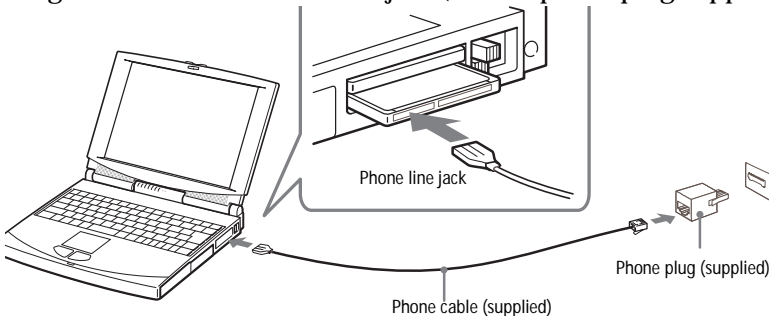

 Phone cables and connectors: TNV (Telecommunication Network Voltage), according to EN60950.



## Other connections

This PC card modem can be connected to GSM and ISDN networks.

### Connecting to a GSM

Your PC card modem is ready for connection to the Sony CMD-Z1 GSM phone (cable not supplied). Plug the cable in the right connector of the PC card. Plug the other end into the GSM phone.

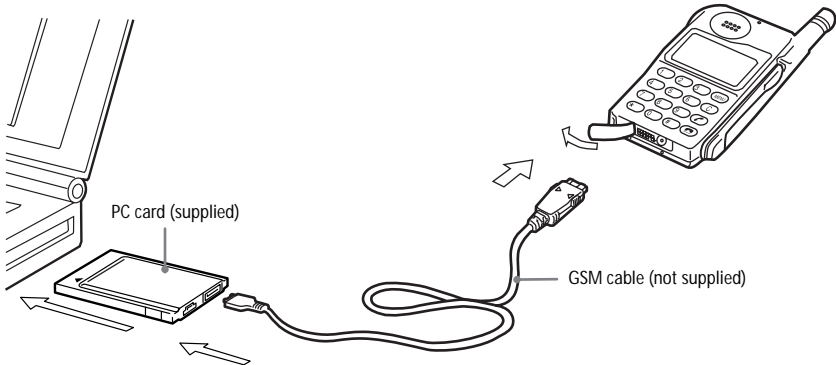

Models of GSM	Card programming
Sony CMD-Z1 and Z1 Plus	Ready
Sony CM-DX1000 Sony CMD-X2000	Ready to be re-programmed (program supplied on your Hard Disk and Recovery CD).
Other GSM phones	See your retailer.

### Connecting to an ISDN line

Your PC card modem is ready for connection to ISDN (Digital Network offering transmission of voice, data, fax). See your retailer for all information and accessories.

# Connecting the Docking Station

Attaching an optional docking station enables you to connect additional peripherals as shown below. There are two types of docking stations: the Personal Docking Station and the Network Docking Station. The Personal Docking Station does not include the SCSI, Network (ethernet), and i.LINK (IEEE 1394 interface) connectors.

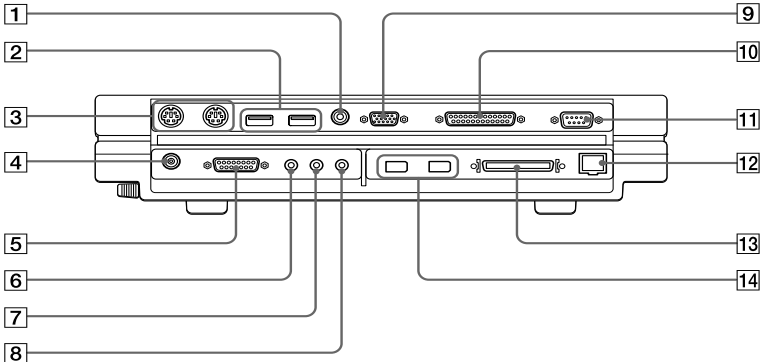

- |  |   |
|--|---|
| <ul style="list-style-type: none"> <li>1  Video Out (page 54)</li> <li>2  USB * (page 60)</li> <li>3  Mouse/Keyboard (page 55)</li> <li>4  DC In (page 8)</li> <li>5  Joystick</li> <li>6  Microphone (page 57)</li> <li>7  Line In</li> </ul> | <ul style="list-style-type: none"> <li>8  Line Out</li> <li>9  Monitor (page 52)</li> <li>10  Printer (page 51)</li> <li>11  IO/IO Serial COM1 (page 58)</li> <li>12  Network (ethernet)<sup>†</sup></li> <li>13  SCSI (ULTRA SCSI compliant)<sup>†</sup></li> <li>14  i.LINK (IEEE 1394 interface)(page 59)<sup>†</sup></li> </ul> |
|--|---|

\* USB ports are included to provide state-of-the-art technology. Your operating system supports a limited number of USB devices. You may need to install device drivers supplied with your USB device before using the USB device.

<sup>†</sup> Network docking station only.

When your computer is connected to the docking station, you cannot use the system suspend or system hibernation power saving modes.

To listen to audio CDs through the computer's built-in speakers, insert the CD-ROM drive into the computer's multi purpose bay. Audio from a CD in the docking station's multi purpose bay cannot be heard through the built-in speakers.

### To attach your computer to the docking station

To supply power to your computer while it is connected to the docking station, you can connect the AC adapter directly to the docking station.

- 1 Turn off your computer and disconnect all peripherals.
- 2 On the back of the computer, lift the cover that protects the docking station port.

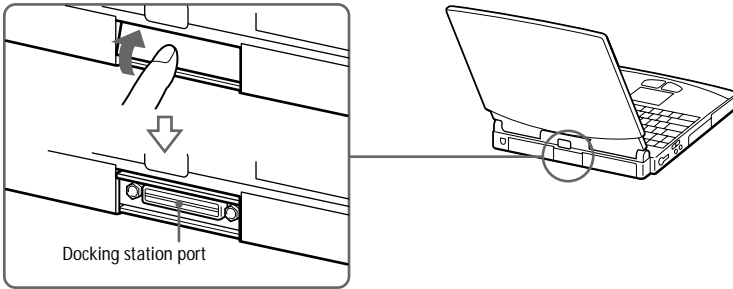

- 3 Align the indentation on the bottom of the computer with the guide post on the docking station.

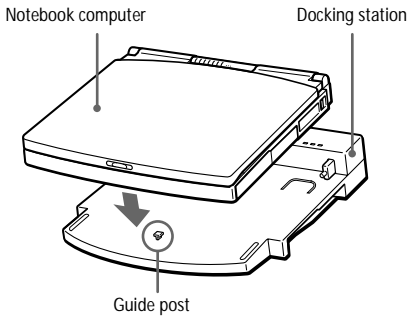

- 4** Make sure the docking station lever is in the **RELEASE** position.

Align the guide posts on the docking station with the openings on the back of the computer, and then slide the computer in the direction of the arrow until it stops.

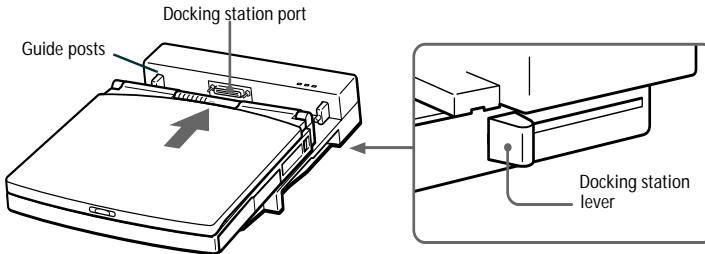

- 5** Slide the docking station lever into the **LOCK** position to secure your computer in the docking station.

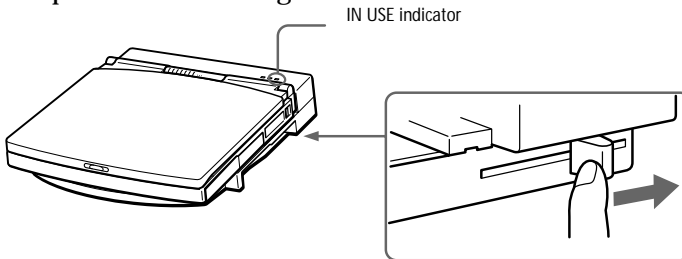

- 6** Plug the cable attached to the AC adapter into the **DC IN** connector on the docking station. Plug the power cord into the AC adapter and an AC outlet.

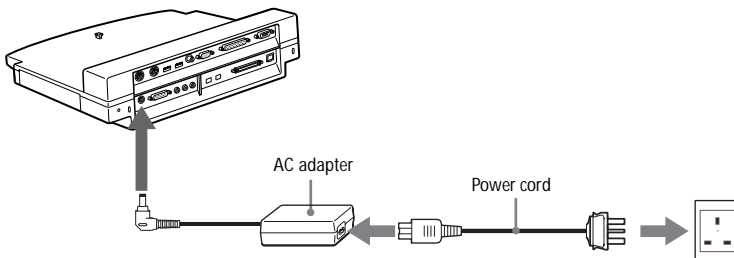

The  $\Phi$  power indicator light turns green.

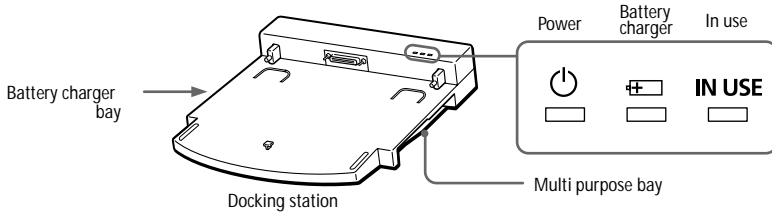

**7** Turn on the computer.

The **IN USE** indicator light turns on.

### To charge a battery pack using the docking station

**1** Open the cover of the battery charger bay.

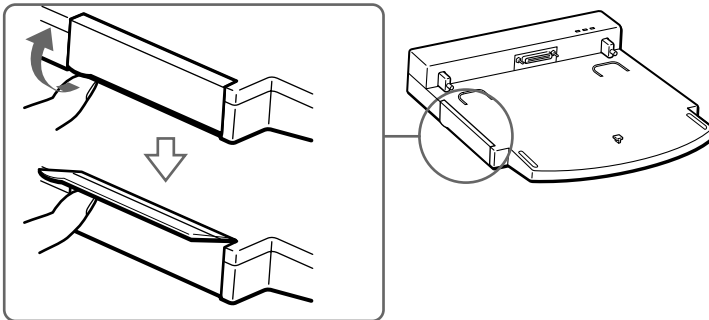

**2** Insert the battery pack.

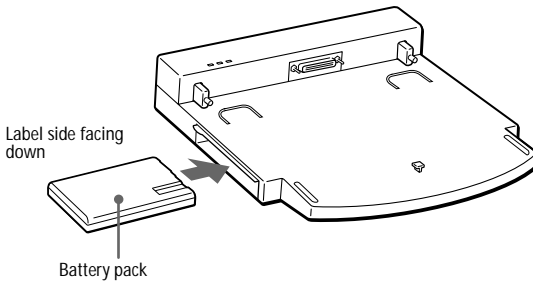

- 3 When the battery pack is fully inserted, close the cover.

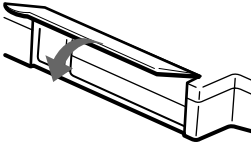

- 4 Connect the docking station to an AC outlet.

The docking station automatically charges the battery. The  battery charger indicator light is on while the battery is charging. When the battery is fully charged, the battery charger indicator light turns off.



Do not move the docking station or place it on a slant while the battery is in the docking station charger bay.

To operate your computer using battery power, you must insert the battery in the computer's battery bay. The docking station bay is designed to charge batteries and cannot be used as a power source for your computer or docking station.

The battery inserted in the computer's battery bay has priority over the battery inserted in the docking station's battery bay when charging the batteries at the same time. Use the computer's battery bay to charge the battery if you are in a hurry.





When your computer is attached to the docking station, you cannot charge your battery and operate the computer at the same time.

### To remove the battery pack

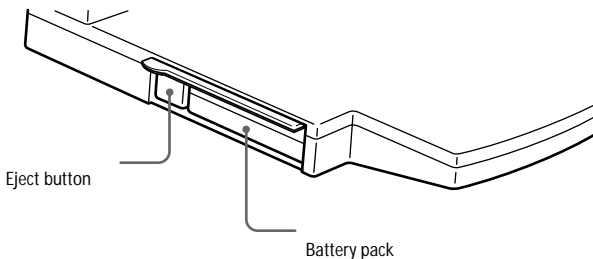
- 1 Open the cover of the battery charger bay.
- 2 Press the Eject button.





- 3 Pull out the battery pack.
- 4 Close the cover of the battery charger bay.

 The  battery charger indicator is a reference for the battery charge. To check the accurate charging amount, insert the charged battery in the computer and use BatteryScope (See “Displaying Battery Information” on page 67.).

### To insert the CD-ROM or floppy disk drive into the docking station

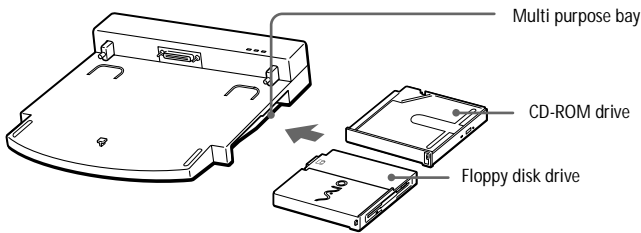
You can use the CD-ROM drive or the floppy disk drive in the docking station. By using the multi purpose bays in both the computer and the docking station, you can use the CD-ROM drive and the floppy disk drive at the same time.



 Turn off the computer before inserting or removing the drive.

### To remove the drive

There is an Eject lever on the bottom of the drive. Slide the lever in the direction of the arrow, and then pull the drive out of the bay. Insert another drive or the weight saver into the multi purpose bay. See “Using the Weight Saver” on page 40. Do not leave the multi purpose bay empty.

### To remove your computer from the docking station when the power is on

- 1 Check that the charged battery is inserted in the computer.
- 2 On the Start menu, select Eject. Alternatively, press Fn+F9.

The **IN USE** indicator turns off. If you press Fn+F9, the computer beeps.

 Do not remove the computer before the **IN USE** indicator light turns off. Removing the computer before the light turns off may cause malfunction.

- 3 Slide the docking station lever forward into the **RELEASE** position to disengage the computer from the docking station.

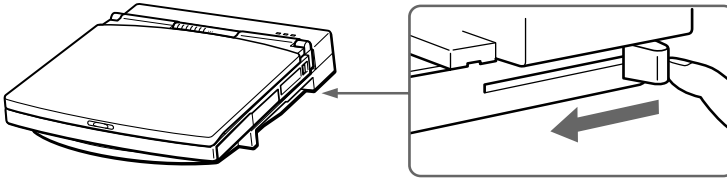

- 4 Lift the computer away from the docking station.

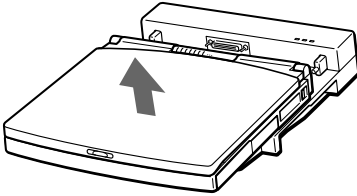

- 5 Close the docking station port cover on the back of your computer.



You cannot remove your computer from the docking station when the power is on, unless the charged battery is inserted in the computer.

### To remove your computer from the docking station when the power is off

- 1 Turn off your computer and the connected peripherals.
- 2 Slide the docking lever forward into the **RELEASE** position to disengage the computer from the docking station.
- 3 Lift the computer away from the docking station.
- 4 Close the docking station port cover on the back of your computer.



If the docking station lever does not move, insert a sharp, pointed object into the manual eject hole on the rear of the docking station.

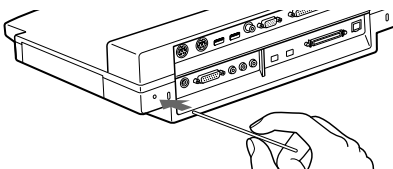





## Connecting a Printer

You can connect a Windows-compatible printer to your computer to print documents.

### To connect a printer

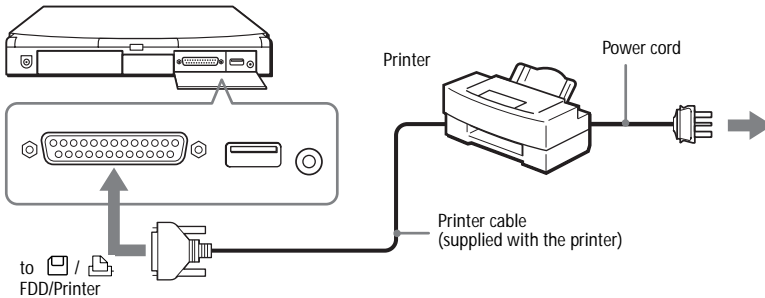
- ❑ Use the  symbol to locate the FDD/Printer connector. Plug the printer cable (supplied with the printer) into this port on the computer.



-  See the manual that came with your printer for more information on installation and use.

Before using the printer, you may need to change the FDD/Printer setting in the Sony Notebook Setup software. See "Displaying the Sony Notebook Setup Screen" on page 63.

## Connecting an External Display

You can connect an external display to your notebook computer. For example, you can use the computer with a:

- ❑ Computer display (monitor) (page 52)
- ❑ Multimedia computer display (page 52)
- ❑ Projector (page 53)
- ❑ TV (page 54)

### To connect a computer display

- ❑ The  symbol on the back of the computer shows the location of the Monitor connector. Plug the display cable into this connector on the back of the computer.
- ❑ If necessary, plug one end of the display power cord into the display, and the other end into an AC outlet.

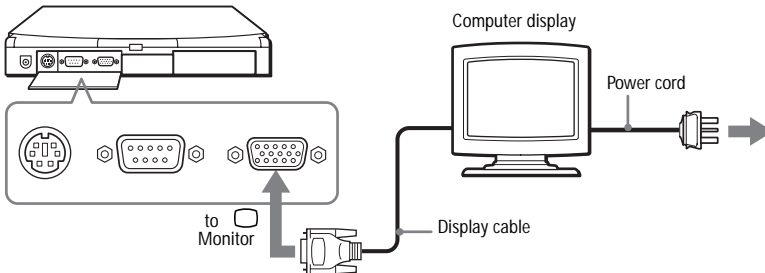



See the manual that came with your computer display for more information on installation and use.

You may not be able to display images on the connected TV or the screen image may flicker when the resolution is 1024x768 pixels. If it happens, lower the resolution.

### To connect a multimedia computer display

You can connect the notebook computer to a multimedia computer display that includes built-in speakers and a microphone.

- 1 Use the  symbol to locate the Monitor connector. Plug the display cable into this connector.

- 2 Use the  symbol to locate the Headphone connector. Plug the speaker cable into this connector.
- 3 Use the  symbol to locate the Microphone connector. Plug the microphone cable into this connector.

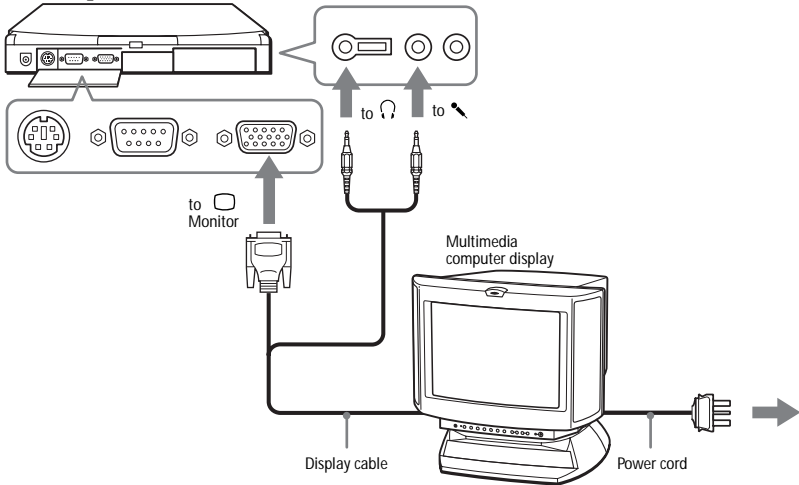

## To connect a projector

You can use a projector as an external display, such as the Sony LCD Projector.

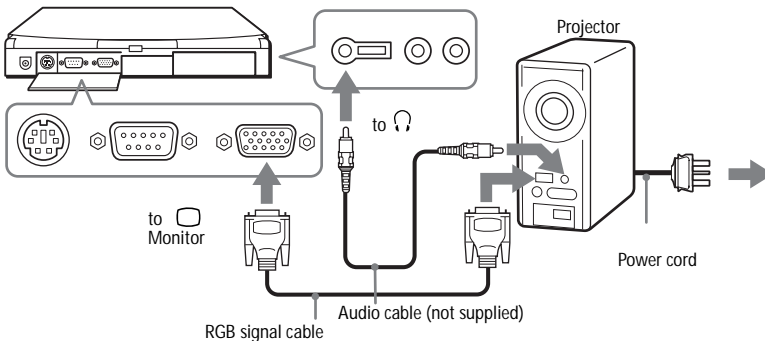

See the manual that came with your displays for more information on installation and use.

You may not be able to display the computer's LCD and external display according to the types of computer display and projector.

## To connect a TV

You can connect a TV that has audio and video connectors by using optional A/V connecting cables.

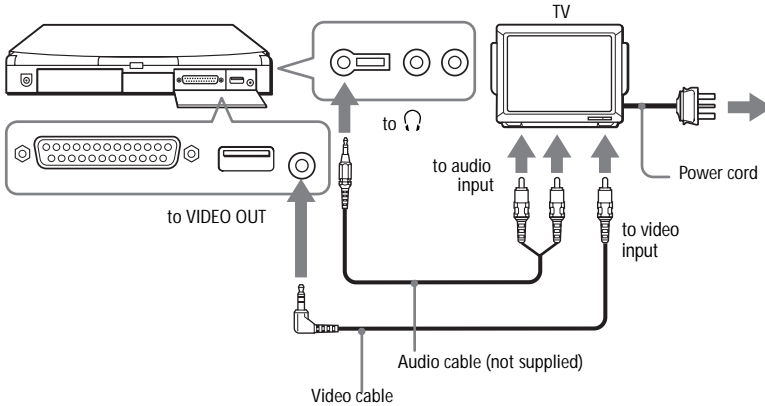

See the manual that came with your TV for more information on installation and use.

## To select a display

When you connect an external display to the monitor connector, you can toggle the output between the Liquid Crystal Display (LCD), the external monitor, or both devices. When you use the Video Out connector to send the output to a TV, you can toggle between the LCD and the TV.



Use the following keys to select a display. See also “Selecting the Display Mode” on page 70 for more information.

To	Press	Result
Switch to the VGA monitor	Fn+F7	Toggles between the LCD, the external display connected to the Monitor connector, and both the LCD and external display together. <div style="text-align: center;"> </div>
Select LCD or TV	Fn+F8	Toggles between the LCD and TV (the display connected to the Video Out connector). <div style="text-align: center;"> </div>

## Connecting an External Mouse or Keyboard

You can connect an external mouse or keyboard to your computer. To connect both a mouse and a keyboard, use the docking station (see “Connecting the Docking Station” on page 44). The Mouse/Keyboard connector requires a PS/2-style plug or adapter.

### To connect an external mouse or keyboard

- Use the  /  symbol to locate the Mouse/Keyboard connector. Plug the keyboard cable or mouse cable into this connector with the  mark facing up.

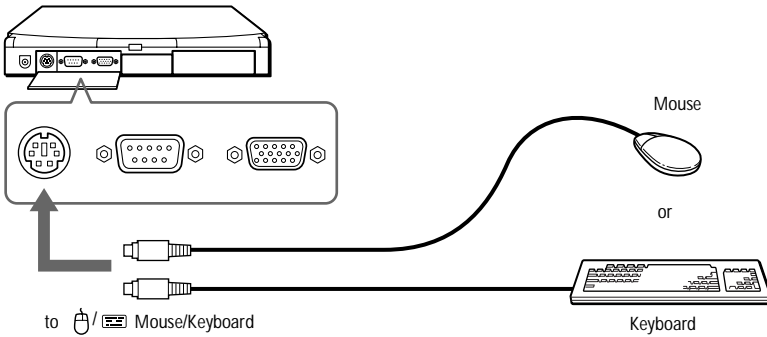

-  See the manual that came with your mouse or keyboard for more information on installation and use.

Before you connect or disconnect the mouse or keyboard, turn off the computer. After connection, restart.

To use a mouse connected to the Serial port, make sure the mouse is compatible with the Serial port.

# Connecting External Speakers

You can enhance the sound quality of your computer by connecting external speakers.

 Make sure your speakers are designed for computer use.

Turn down the volume of the speakers before you turn them on.

### To connect external speakers

- Use the  symbol to locate the Headphone connector. Plug the speaker cable into this connector.

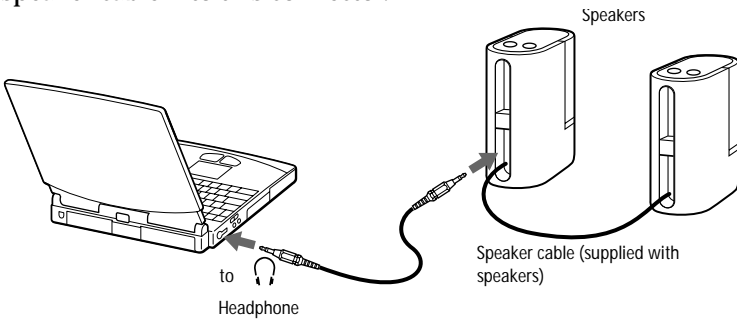

 See the manual that came with your speakers for more information on installation and use.

# Connecting an External Microphone

You can enhance the quality of sound input by using an external microphone.

 Make sure your microphone is designed for computer use.

### To connect an external microphone

- ❑ Use the  to locate the Microphone connector. Plug the microphone cable into this connector.

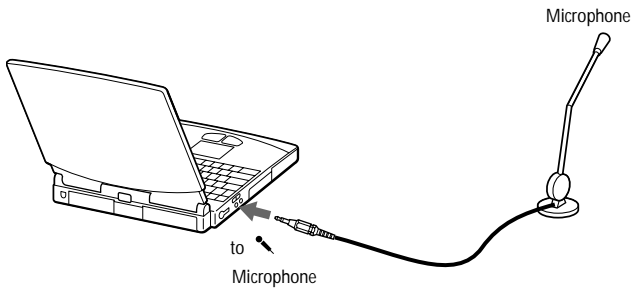

 See the manual that came with your microphone for more information on installation and use.

## Connecting a Digital Still Camera or Other Serial Device

You can connect other computer peripherals, such as the Sony Digital Still Camera, to the Serial COM1 connector on your computer.

### To connect a digital still camera

- ❑ Use the IOIO symbol to locate the Serial COM1 connector. Plug the connecting cable into this port on the computer and into the Digital I/O connector on the digital still camera.

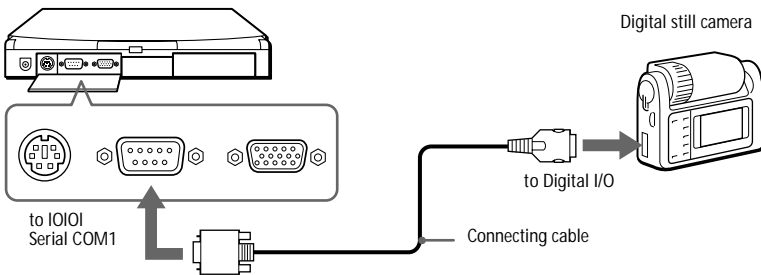

 The Sony Digital Still Camera (DSC-F1) is pictured; your camera may need to be connected differently.

See the manual that came with your digital camera or other serial device for more information on installation and use.

You can connect the DSC-F1 either to the Serial port or by using an infrared communication.

If you use a digital camera that has an infrared data communication system or other infrared communication device, see "Using Infrared Communication Devices" on page 34.





## Connecting a Digital Video Camera Recorder

You can connect a digital video camera recorder to the i.LINK connector on the network docking station. See “Connecting the Docking Station” on page 44.

### To connect a digital video camera recorder

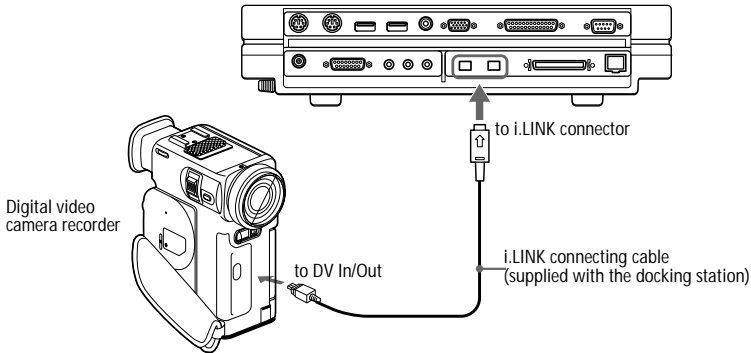
- ❑ Plug the DV connecting cable into the i.LINK connector on the rear of the network docking station and the i.LINK connector on the digital video camera recorder.



 Sony's digital video camera recorder (DCR-PC7) is pictured; your digital video camera recorder may need to be connected differently.

See the manual that came with your digital video camera recorder for more information on installation and use.

### What is IEEE1394?

IEEE1394 is a high-speed digital serial interface suitable for transmitting and receiving audio and video signals. A transmission speed of up to 400Mbps is possible under the currently agreed specifications. IEEE1394 has been regarded as the most suitable interface for inter-connecting digital AV equipment and personal computers. As a member of the 1394 Trade Association, Sony Corporation has worked extensively to promote IEEE1394 in the marketplace. It plans to provide AV products and computer peripherals equipped with the IEEE1394 interface and bearing the i.LINK name and logo.

## Connecting a Universal Serial Bus (USB) Device

You can connect a USB device to your computer.

### To connect a USB device

- ❑ Use the  $\Psi$  symbol to locate the USB connector. Plug the USB cable into this port.

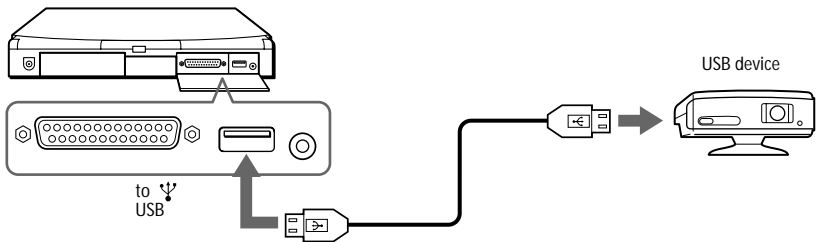

 USB ports are included to provide state-of-the-art technology. You may need to install software (device drivers) supplied with your USB device before using the USB device.

To use your USB device, you must install the USB supplemental software using your Sony Application Recovery utility.

See the manual that came with your USB device for more information on installation and use.

# Using the Mediabar

The Mediabar allows you to play audio and video from a CD in the CD-ROM drive, or from audio or video files in various formats on your hard drive.

To start the Mediabar

- 1 Click the Windows 98 Start menu.
- 2 In the Programs menu, select Mediabar. The Player bar appears as a single control bar across the top of the screen, with buttons similar to the controls on a VCR or CD-player remote control.



To expand the Mediabar

You can expand the bar to double-height to access more functions by clicking the Expand button ( ▼ ) at the far right. To return to single height, click the Restore button ( ▲ ).



To change the Player bar to a floating window

To change the bar into a floating window, drag the bar to the center of the screen. The bar opens into a window with File, Control, and Help menus.

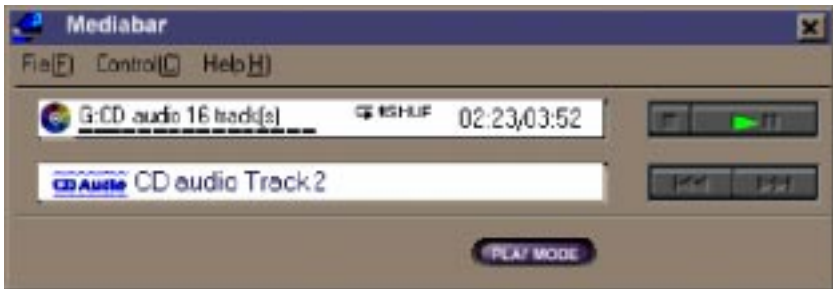

## Mediabar Functions

You can use the Mediabar to:

- ❑ Start and stop the playback of audio or video CDs or files.
- ❑ Navigate through files or selections on a CD.
- ❑ Pause and resume playback at the point where play left off.
- ❑ Set up automatic playback modes, including:
  - ❑ Repeat all of the selections in order.
  - ❑ Repeat a single selection.
  - ❑ Play all of the selections in a random order.

Video images display in a separate Movie window, which you can move and resize (to full screen). If the CD supports PlayBack Control (for example, Video CD-ROM format), you can select specific scenes or still images by their assigned numbers.



The Mediabar features extensive and detailed in online help. To access online help, right-click the Player Bar and select Help from the shortcut menu.

# Customizing Your Notebook Computer

You can customize the settings of your notebook computer. The following sections briefly describe how to change your computer's default settings. You can also refer to the Sony Notebook Setup Help for more detailed information.

## Displaying the Sony Notebook Setup Screen

To display the Sony Notebook Setup screen:

- 1 Click the Start button on the Windows 98 taskbar.
- 2 Point to Tool Center and click Sony Notebook Setup.

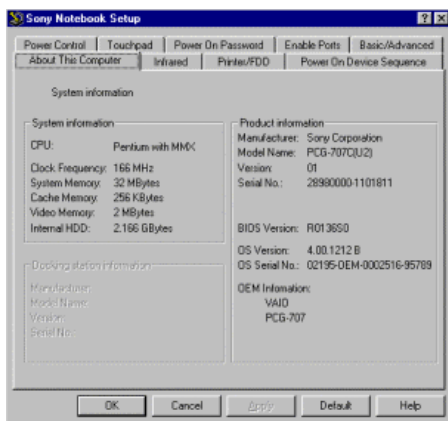

- 3 Select the tab for the item you want to change. See “Notebook Setup Tabs” on page 64.
- 4 After you finish, click OK.

## Notebook Setup Tabs

Tab	Descriptions
About This Computer	Display system information, including memory capacity, serial number, and BIOS version.
Infrared	Change the infrared communication settings depending on the infrared equipment your computer is using to communicate.
Printer/FDD	Switch between connecting a printer or floppy disk drive without turning off the power. Change printer port mode settings.
Power On Device Sequence	Select the order of drives and devices from which you want to load the operating system. You can specify the hard drive inserted into the docking station as well as other drives inserted into your computer.
Power Control	Conserve battery power by selecting a power control mode.
Touchpad	When you connect an optional mouse to the Serial port of your computer, you can make your touchpad inactive. You can also customize the settings of your mouse using the mouse utility.
Power On Password	Set the password to secure your computer.
Enable Ports	Change the hardware resources such as I/O address, IRQ, or DMA depending on the optional hardware or software you use. Disabling ports releases resources to the system. To change the serial, audio, click Advanced on the Basic/Advanced tab.
Basic/Advanced	Toggle between Advanced mode (additional screens with advanced settings) and Basic mode of display. Advanced mode includes Serial, Audio, Enable Ports, and View Resources tabs.



For more information about each option, click Help on the Notebook Setup screen to display the help file.

# Controlling Power Management

The PowerPanel utility allows you to control the power management of your notebook computer and provides key information about system activity and battery life. The following sections briefly describe how to conserve your computer's battery power. You can also refer to the PowerPanel Help for more detailed information.

## Power Management Settings

PowerPanel provides settings ranging from maximum power management to no power management. The available settings include:



---

**Maximum Performance** – Provides the best system performance while still conserving power.



---

**Maximum Battery Life** – Provides power saving features to give you maximum battery life and good performance. It sets a slower clock speed and puts the system into system suspend mode after a specified time period.



---

**Power Management Off** – Turns off all power management features such as system idle, system suspend, and system hibernation modes. This is the normal state of the system. If you disable power management, the system remains in this state until you turn off the power.



---

**AC Profile** – The power management state when AC power is in use. Similar to the Power Management Off setting. PowerPanel automatically loads the AC profile unless you disable this feature.



---

**System Idle** – Puts the system into standby mode, a power management state. When the system enters idle mode, the hard disk and video display enter a low power state. The CPU clock and the processor stop.





---

**System Suspend** – Puts the system into suspend mode, a power management state that saves the state of the system and peripheral devices in memory (RAM). Power consumption reduces to a minimum, and the system remains on. To return the system to the active state, press any key or the power switch on your computer.

---

---

 **System Hibernation** – Provides for the lowest level of power consumption. The system writes the state of the system and peripheral devices to the hard disk and turns off the system power. To return the system to the original state, use the power switch to turn on power. The system saves the data in the Save to Disk Partition on the hard drive.

---

 **Video Standby** – Turns off the LCD to save power. If you turn off video power management, the display remains active except when the system enters system standby or system suspend mode. The video display system is one of the largest consumers of power in the system.

---

 **Hard Disk Standby** – Turns off the hard disk spindle motor. Although you can manually turn off the power to the hard disk through this command, any system request to the hard disk turns on the power to the hard disk. During the power management states of system standby and system suspend, the system can turn off idle peripheral devices to conserve power.

---

 **PC Cards Control** – Controls the PC card sockets. Double-click this button to open the PC Card (PCMCIA) Properties dialog box. You can view the properties for the PC cards.

---

### To activate PowerPanel

- 1 Double-click the PowerPanel icon on the taskbar.

The Power Management toolbar appears. When you move the pointer over the atom icon on the taskbar, a tooltip with the name of the active power management profile appears.



- 2 Click the button you want to set.

The appropriate power management function will be activated.

### To customize the PowerPanel toolbars

You can customize the PowerPanel toolbar to suit your portable computing needs. You can add any one of the pre-defined Power Management buttons or create your own buttons. Refer to PowerPanel Help for more information.



# Displaying Battery Information

You can display detailed information for the batteries used in your computer and docking station. The following sections briefly describe how to display your computer's general battery information. You can also refer to the BatteryScope Help for more detailed information.

## Activating BatteryScope

### To activate BatteryScope

- 1 Click the Start button on the Windows 98 taskbar.
- 2 Point to Tool Center and click BatteryScope.





When you move the pointer over the battery icon on the taskbar, a tooltip appears indicating the total capacity remaining in the battery and the estimated time until the battery fully discharges.

You can also view battery gauges on the shared PowerPanel and BatteryScope toolbar.



- Percentage indicator**  
Displays the percentage of the remaining capacity.
- Time indicator**  
Displays estimated time (hours/minutes) remaining before the battery fully drains, also referred to as the time-to-empty.

## Battery Icon Descriptions

Battery icon	Battery status
	Discharging
	Charging
	Not in use
	No battery

## Displaying Detailed Battery Information

You can obtain detailed information about the batteries.

- ❑ Click the battery icon on the application bar to display the BatteryScope window.

The screen appears displaying the General tab, which contains information such as the estimated time-to-empty and charging time.

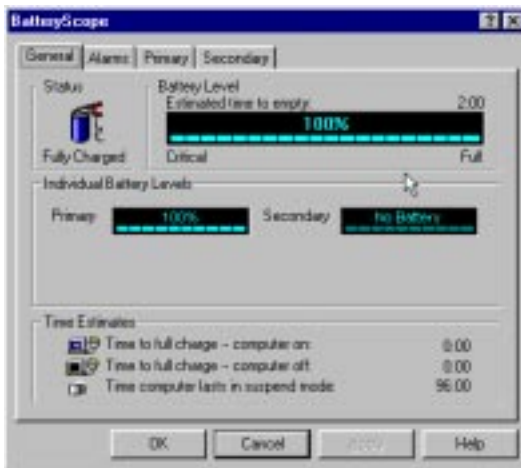

**To display information on individual batteries**

- 1 Click the Primary battery tab to display information for the battery in the bay on the left side.
- 2 Click the Secondary battery tab to display information for the battery in the bay on the right side.

You can display the information about each battery, such as estimated time-to-empty or product information.

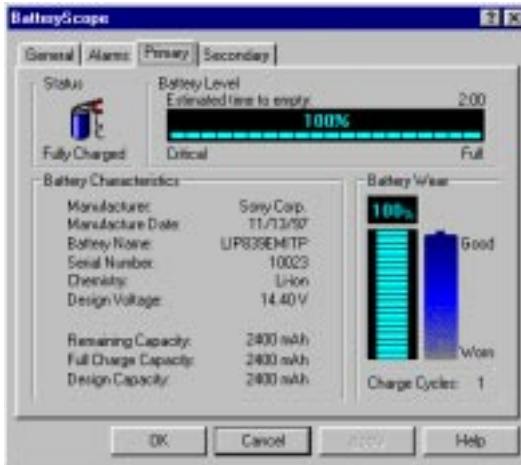
**To customize the BatteryScope application bar and alarm system**

You can customize the BatteryScope application bar to suit your portable computing needs as well as to modify the alarm settings. Refer to the BatteryScope Help for more information.

## Selecting the Display Mode

When you connect an external display, you can switch the display mode between the LCD on your computer and external displays:

- 1 Click the Start button to open the Start menu.
- 2 Point to Settings and click Control Panel.
- 3 Double-click Display.
- 4 Click the NeoMagic tab.



- 5 Click Display Options.

## 6 Select one of the options under Display Mode.

Display modes	Functions
Monitor	Displays only an external display connected to the Monitor connector on your computer.
LCD	Displays only the Liquid Crystal Display (LCD) on your computer.
Monitor/LCD	Simultaneously displays both an external display connected to the Monitor connector on your computer and the LCD.
TV	Displays only a TV or projector connected to the Video Out connector on your computer.

## 7 Click OK.



You cannot use the following displays simultaneously:

- The computer's LCD and an external display using the Video Out connector.
- External displays using the Monitor connector and the Video Out connector.

You can adjust the refresh rate when you select Monitor as the display mode.

If you want to display images on the TV that is connected to the Video Out connector, do not connect any equipment to the Monitor connector.

## When You Select TV

When you select TV as the display mode, you can adjust the TV display position and select the TV system you want to use.

### To select TV options

After you select TV in Step 6, select TV options.

TV Options	Function
Image Filter	Adjusts the flicker.
Optimal TV Setting	Adjusts the resolution for optimal TV viewing.
PAL/SECAM	Selects the PAL/SECAM TV system.
NTSC	Selects the NTSC TV system.

### To select the TV system

You can select the TV system using TV options. After you select TV in Step 6, select the TV system from the TV options. Color systems are different in each country. Use the country names below to select the appropriate color system for your location.

TV System	Country
PAL system	Australia, Austria, Belgium, China, Czech Republic, Denmark, Finland, Germany, Great Britain, Holland, Hong Kong, Italy, Kuwait, Malaysia, New Zealand, Norway, Portugal, Singapore, Slovak Republic, Spain, Sweden, Switzerland, Thailand
NTSC system	Bahama Islands, Bolivia, Canada, Central America, Chile, Colombia, Ecuador, Jamaica, Japan, Korea, Mexico, Peru, Surinam, Taiwan, the Philippines, U.S.A., Venezuela



You cannot display images on the TV or video monitor with the SECAM system even if you select PAL/SECAM.

# Getting Help

This section describes how to get help and support from Sony, as well as troubleshooting tips for your computer.

## About Sony's Support Options

Sony provides several support options for your computer. When you have questions about your computer and the pre-installed software, check these places for answers:

- ❑ **This guide** explains how to use your computer, connect peripheral devices, use the utility programs, and perform basic computer tasks.
- ❑ **The online help files** that accompany your pre-installed software contain instructions on using the software.
- ❑ **The *About Your Sony Notebook Computer*** guide lists the pre-installed software titles. This guide also includes a packing list and technical specifications for your notebook computer. It is included with your computer as an electronic document.
- ❑ **The *Sony Service Guide*** gives you complete information on communicating with VAIO Link Response Centre. Please also refer to this guide to get extended warranty conditions.
- ❑ **The *VAIO Channel*** offers on-line information about your notebook computer and other Sony products that work with your computer. Just click the VAIO Channel button on your Channel Bar to access the WWW.
- ❑ **The Sony e-mail support service** answers your questions by electronic mail. Just send your question in an e-mail message, and a Customer Service Analyst will send you a reply with the answer. To send a question to Sony e-mail support, please refer to the instructions in your *Sony Service Guide*.

- ❑ **The VAIO Link:** for operating hours, see your *Customer Service Guide*. You can contact VAIO Link by telephone, fax or mail. The representative may call you back, using your modem to access your system if necessary. Be sure to connect your modem before you call, so that the representative can access your system. Before calling VAIO Link, try to solve the problem by reading your User Guide (troubleshooting chapter) or the manuals and helpfiles of the peripherals or software.



# Troubleshooting

This section describes how to solve common problems you may encounter when using your computer. Many problems have simple solutions, so try these suggestions before you call VAIO Link.

My computer does not start

- ❑ Check that the computer is plugged into a power source and that it is turned on. Check that the power indicator on the front panel of the computer indicates that the power is on.
- ❑ Check that the battery packs are inserted properly and that they are charged.
- ❑ Make sure a diskette is not in the floppy disk drive.
- ❑ Confirm that the power cord and all cables are connected firmly, as described in “Connecting Peripheral Devices” on page 41.
- ❑ If you plugged the computer into a UPS, make sure the UPS is turned on and working.
- ❑ If you are using an external display, check that it is plugged into a power source and turned on. Check that the brightness and contrast controls are adjusted correctly. See the manual that came with your display for details.
- ❑ Moisture condensation may have occurred. Do not use the computer for at least one hour and then turn on the computer.

My LCD does not display anything

- ❑ Check that the computer is plugged into a power source and that it is turned on. Check that the power indicator on the front panel of the computer is on.
- ❑ Check that the battery packs are inserted properly and that they are charged.
- ❑ Adjust the brightness of the LCD (page 18).
- ❑ The computer may be in video standby mode. Press any key to activate the display.
- ❑ The video output may be directed to an external display. Press Fn+F7 until video output appears on the LCD.
- ❑ The video output may be directed to a TV. Press Fn+F8 until video output appears on the LCD.

The screen image on my external display is not centered or sized properly

Use the controls on your external display to adjust the image. See the manual supplied with your display for more information.

The video image on my screen is too dark

If an external display is connected to the Monitor connector, disconnect the display.

My computer "locks up"

- ❑ Try restarting the computer. On the Windows taskbar, click the Start button, click Shut Down, and then click Restart.
- ❑ If you cannot restart as described in the preceding step, you can restart the computer by pressing Ctrl+Alt+Delete twice (or by pressing Ctrl+Alt+Delete once, then clicking Shut Down in the Task manager of Windows).
- ❑ If the previous step does not work, slide the power switch toward the front and hold it for at least four seconds. This turns off the power.
- ❑ If your computer locks up while playing a CD-ROM, stop the CD-ROM, and restart the computer by pressing Ctrl+Alt+Delete twice.



Pressing Ctrl+Alt+Delete may result in data loss in files that are currently open.

My CD-ROM drive tray will not open

- ❑ Check that the CD-ROM drive is properly inserted.
- ❑ Make sure the computer is turned on.
- ❑ Press the Eject button on the CD-ROM drive.
- ❑ If the Eject button does not work, you can open the CD tray by inserting a sharp, pointed object into the hole to the right of the Eject button.

I can't play a CD-ROM disc

- ❑ Make sure the label of the CD-ROM is facing up.
- ❑ If the CD-ROM disc requires software, make sure the software is installed according to the program's instructions.
- ❑ Moisture condensation may have occurred. Leave the computer for at least 1 hour while the computer is turned on.

When I double-click an application icon a message appears, such as “You must insert the application CD into your CD-ROM drive”, and the software does not start

- ❑ Some titles require specific files that are located on the application’s CD-ROM disc. Insert the disc and try starting the program again.
- ❑ Make sure you place the disc in the tray with the label side facing up.

My floppy disk drive can’t write to a diskette

- ❑ The diskette is write-protected. Disable the write-protect feature or use a diskette that is not write-protected.
- ❑ Check that the diskette is properly inserted into floppy disk drive.

My software program “locks up” or crashes

Contact the software publisher or designated provider for technical support. See the *About Your Sony Notebook Computer* guide for a list of phone numbers.

My speakers have no sound

- ❑ The built-in speakers are turned off. Press Fn+F3 to turn on the speakers.
- ❑ The speaker volume is turned to the minimum. Press Fn+F4, and then press ↑ or → to increase the volume.
- ❑ If your computer is powered by batteries, check that the battery packs are inserted properly and that they are charged.
- ❑ If you are using an application that has its own volume control, check that the volume is turned up.
- ❑ Check the volume controls in Windows.
- ❑ If you connect external speakers, check that the speakers are properly connected and the volume is turned up. If the speakers have a mute button, make sure it is off. If the speakers are powered by batteries, check that the batteries are inserted properly and that they are charged.
- ❑ If you have connected a headphone or an audio cable to the Headphone connector, disconnect the cable.
- ❑ If the CD-ROM drive is in the docking station’s drive bay, you cannot hear sound from your computer’s built-in speakers.

When I press Fn+F3, I see the message “Muting”

Click the Volume icon in the Windows 98 taskbar. When the Volume cursor appears, disable “Mute” by clicking this option. You can also disable “Muting” by pressing Fn+F3 again.

My modem (PC card) doesn't work

- Check that your PC card is properly inserted in your computer (label side facing up).
- Check that the phone line is plugged into your PC card. See “Connecting a PC card modem” on page 42 for details.
- Check that the phone line is working. You can check the line by plugging in an ordinary phone and listening for a dial tone.
- Check that the phone number the program is dialing is correct.
- Check that the software you are using is compatible with the provided PC card. (All pre-installed programs are compatible.)
- For further information, please refer to your PC card user manual.

My microphone doesn't work

If you are using an external microphone, check that the microphone is plugged into the Microphone connector. See “Connecting an External Microphone” on page 57 for details.

My mouse doesn't work

If you are using an external mouse, check that the mouse is plugged into the mouse connector. See “Connecting an External Mouse or Keyboard” on page 55 for details.

My touchpad interprets a single tap as a double-click

Open the Mouse icon in the Control Panel and change the button assignments in the Mouse Properties dialog box. One of the buttons is assigned to the double-click action.

My computer does not shut down

Slide the power switch forward and hold for at least four seconds.

My PC card is not working

- Make sure the PC card is compatible with Windows 98
- Use the Sony Notebook Setup utility to disable devices you are not currently using.

# Using the System and Application Recovery CD

The following sections describe how to use the Recovery CD.

The Recovery CD allows you to perform:

- ❑ A full system recovery
- ❑ An application recovery
- ❑ A manual reinstallation of device drivers

You may need to recover the entire contents of your hard drive, in case of a serious system crash. In this instance, perform a system recovery.

If you encounter a problem with your computer, probably caused by a badly configured system, reinstalling an individual device driver may solve the problem.

Another problem could be that a pre-installed application doesn't work properly anymore. Reinstalling the appropriate application should fix the problem. Consequently, you should perform an application recovery.

## Performing a System Recovery.

Use this option only when your system is seriously damaged. For example: Windows 98 does not work anymore, or your PC behaves abnormally... The system recovery will completely reinstall the originally configured system on your PC.



You can only use this Recovery CD on the Sony notebook you purchased and not on any other Sony PC or other manufacturer's PC!



Applying a system recovery means that you will lose all your data stored on the hard drive. Therefore, before applying a system recovery, save your data stored on the hard disk to an external disk. If this is not possible under Windows 98, try to save your data from the DOS-prompt to a floppy.



**CAUTION:** ensure that your computer is connected to AC (not the batteries) before you attempt a System Recovery.

 The CD-ROM drive must be inserted in the computer — not the docking station — to perform a system recovery.

You need to complete the Windows® 98 registration process when you use the system recovery. Make sure you have the product ID number located on the cover of your “Introducing Microsoft Windows 98” guide. You will need this number to complete the recovery process.

### Procedure for a System Recovery

- 1 Turn on your computer (using AC power only) and insert the Sony Recovery CD in the CD-ROM drive.
- 2 Shut down your computer (to do this, slide the power switch forward and hold it for more than four seconds).
- 3 Wait ten seconds and turn on your computer again.
- 4 Choose OK to confirm that you have read and accepted the Microsoft End-User License Agreement.
- 5 The system recovery screen appears next. If you're really sure that you do not mind losing all your data, choose 'yes'.
- 6 You will get a final warning. If you choose 'Go', all data will be removed permanently and the recovery process will start.

 The recovery process takes between 10 to 15 minutes to complete.

**If your computer does not start the system recovery utility.**

Refer to your *Customer User Guide* to call VAIO-Link by phone or by fax.

## Performing an Application Recovery.

The application recovery utility allows you to reinstall individual applications.

Reinstallation of a program can fix the problems encountered in a program that does not run correctly anymore.

 You must run the Recovery CD from Windows 98.  
The application will not run from DOS.

### Procedure for an application recovery

- 1 Turn on your computer (using AC power only) and wait until Windows 98 is booted up.
- 2 Insert the Recovery CD. The Application Recovery utility now loads automatically.
- 3 When the Application Recovery menu appears, follow the on-screen instructions to choose the application you want to recover.

 When performing an application recovery, you do not lose data.

## Reinstalling a device driver

First check whether the driver you plan to reinstall is on the Recovery CD. Only device drivers that are not delivered with Windows 98 can be found in the directory drivers ( in G:\Drivers). Check all underlying sub-directories for the appropriate driver. Next, launch the 'Add New Hardware' wizard (in the Windows start menu, select settings, then control panel) to install the appropriate device.





# Notes on Use

This section describes safety guidelines and precautions to help protect your computer from potential damage.

## On Handling the LCD Screen

- ❑ Do not leave the LCD facing the sun as it can damage the LCD. Be careful when using the computer near a window.
- ❑ Do not scratch the LCD or exert pressure on it. This could cause a malfunction.
- ❑ Using the computer in low temperature conditions may produce a residual image on the screen. This is not a malfunction. When the computer returns to normal temperature, the screen returns to normal.
- ❑ A residual image may appear on the screen if the same image is displayed for a lengthy period of time. The residual image disappears in a while. You can use a screen saver to prevent residual images.
- ❑ The screen becomes warm during operation. This is normal and does not indicate a malfunction.
- ❑ The LCD is manufactured using high-precision technology. You may, however, see tiny black points and/or bright points (red, blue, or green) that continuously appears on the LCD. This is a normal result of the manufacturing process and does not indicate a malfunction.

## On the Power Source

- ❑ Your computer operates on 100V-240V AC 50/60 Hz.
- ❑ Do not share the AC outlet with other power-consuming equipment, such as a copying machine or shredder.
- ❑ You can purchase a power strip with a surge protector. This device prevents damage to your computer caused by sudden power surges such as those that may occur during an electrical storm.
- ❑ Do not place heavy objects on the power cord.
- ❑ To disconnect the cord, pull it out by the plug. Never pull the cord itself.
- ❑ Unplug your computer from the wall outlet if you will not be using the computer for a long time.

- ❑ When the AC adapter is not used, unplug it from the AC outlet, to save energy.
- ❑ Use only the AC adapter supplied. Do not use any other AC adapter.

#### On Handling

- ❑ Clean the cabinet with a soft, dry cloth or a soft cloth lightly moistened with a mild detergent solution. Do not use any type of abrasive pad, scouring powder, or solvent such as alcohol or benzine, as these may damage the finish of your computer.
- ❑ Should any solid object or liquid fall into the computer, shut down your computer and then unplug it. You may want to have the computer checked by qualified personnel before operating it again.
- ❑ Do not drop the computer or place heavy objects on top of the computer.

#### On Installation

- ❑ Do not place your computer in a location subject to:
  - ❑ Heat sources, such as radiators or air ducts
  - ❑ Direct sunlight
  - ❑ Excessive dust
  - ❑ Moisture or rain
  - ❑ Mechanical vibration or shock
  - ❑ Strong magnets or speakers that are not magnetically shielded
  - ❑ Ambient temperature of more than 35° C or less than 10° C
  - ❑ High humidity
- ❑ To avoid interference, do not place electronic equipment near your computer.
- ❑ Provide adequate air circulation to prevent internal heat build-up. Do not place your computer on porous surfaces such as rugs or blankets, or near materials such as curtains or draperies that may block its ventilation slots.
- ❑ The computer may cause interference to radio or TV reception. Should this occur, relocate the computer a suitable distance away from the set.
- ❑ Use only specified peripheral equipment and interface cables; otherwise, problems may result.

- ❑ Do not use cut or damaged connection cables.

#### On Moisture Condensation

If the computer is brought directly from a cold location to a warm one, moisture may condense inside your computer. In this case, allow at least an hour before turning on your computer. If any problems occur, unplug your computer, and contact your Sony Service Center.

#### On Upgrading the System

- ❑ The procedures described in “Adding Memory” on page 88 assume familiarity with the general terminology associated with personal computers and with the safety practices and regulatory compliance required for using and modifying electronic equipment.
- ❑ Disconnect the system from its power source and from any telecommunications links, networks, or modems before you open the system or do any of the procedures described in “Adding Memory” . Failure to do so may result in personal injury or equipment damage.
- ❑ Electrostatic discharge (ESD) can damage disk drives and other components. Perform the procedures described in “Adding Memory” only at an ESD workstation. If such a station is not available, do not work in a carpeted area, and do not handle materials that produce or hold static electricity (cellophane wrappers, for example). Ground yourself by maintaining contact with an unpainted metal portion of the chassis while performing the procedure.

#### On Handling Diskettes

- ❑ Do not open the shutter manually and touch the surface of the diskette.
- ❑ Keep diskettes away from magnets.
- ❑ Keep diskettes away from direct sunlight and other heat sources.

#### On Handling CD-ROM Discs

- ❑ Do not touch the surface of the disc.
- ❑ Do not drop or bend the disc.

#### On Cleaning CD-ROM Discs

- ❑ Fingerprints and dust on the surface of a disc may cause read errors. Proper care of the disc is essential to maintain its reliability. Do not

use solvents such as benzine, thinner, commercially available cleaners or anti-static spray, as they may cause damage to the disc.

- ❑ For normal cleaning, hold the disc by its edge and use a soft cloth to wipe the surface from the center out.
- ❑ If the disc is badly soiled, moisten a soft cloth with water, wring it out well, and use it to wipe the surface of the disc from the center out. Wipe off any remaining moisture with a dry soft cloth.

#### On Using Batteries

- ❑ Never leave the battery pack in temperatures above 60° C, such as in a car parked in the sun or under direct sunlight.
- ❑ Battery life is shorter in a cold environment. This is due to decreased battery efficiency at low temperatures.
- ❑ Charge the batteries at temperatures between 10° C to 30° C. Lower temperatures require a longer charging time.
- ❑ While the battery is in use or being discharged, the battery pack heats up. This is normal and is not a cause for concern.
- ❑ Keep the battery pack away from all sources of heat.
- ❑ Keep the battery pack dry.
- ❑ Do not open or try to disassemble the battery pack.
- ❑ Do not expose the battery pack to any mechanical shock.
- ❑ If you are not using the computer for an extended period of time, remove the battery pack from the computer to prevent damage to the battery.
- ❑ If, after fully charging the battery pack, the battery power is still low, the battery pack may be reaching the end of its life and should be replaced.
- ❑ You do not need to discharge the battery before recharging.
- ❑ If you have not used the battery pack for a considerable amount of time, recharge the battery.

#### On Using the Headphone

- ❑ **Road safety** – Do not use the headphone while driving, cycling, or operating any motorized vehicle. It may create a traffic hazard and is illegal in some areas. It can also be potentially dangerous to play your headphone at high volume while walking, especially at pedestrian

crossings. You should exercise extreme caution or discontinue use in potentially hazardous situations.

- ❑ **Preventing hearing damage** – Avoid using headphone at high volume. Hearing experts advise against continuous, loud and extended play.

On Maintenance

- ❑ Make sure to disconnect the power cord before cleaning the computer.
- ❑ Avoid rubbing the LCD screen as this can damage the screen. Use a soft, dry cloth to wipe the LCD screen.
- ❑ Clean the computer with a soft cloth lightly moistened with a mild detergent solution. Do not use any type of abrasive pad, scouring powder or solvent, such as alcohol or benzine.

# Adding Memory

In the future you may want to install memory modules to expand the functionality of your computer. You can increase memory to 128MB by installing optional memory modules. There are two memory module slots in your computer. A 32MB and a 64MB Expansion Memory Modules are available as optional memory modules.

**!** Make sure you observe the proper safety precautions when you install memory modules in your computer. See “On Upgrading the System” on page 85.

Be careful when adding memory. Mistakes when installing or removing a memory module may cause a malfunction.

 Electrostatic discharge can damage electronic components. Before touching a memory expansion board, ensure the following:

- You are discharged of static electricity by touching a grounded metal object.
- You do not work in a carpeted area.
- You do not open the package of the memory module until ready for use. The package protects the memory module from electrostatic discharge.
- You use the special bag for preventing electrostatic discharge or use aluminum foil when you store the memory module.

## Typical expansion memory configuration

<b>Total System Memory (MB)</b>	<b>Slot 1 (MB)</b>	<b>Slot 2 (MB)</b>
32*	32	Empty
64	32	32
96	32	64
128	64	64

\* 32MB is the default memory amount for PCG-735 and PCG-737.

The memory options in Slot 1 and Slot 2 are inter-changeable.

To install a memory module

- 1 Shut down your computer and disconnect all peripheral devices, such as your printer.
- 2 Unplug your computer and remove the battery packs.
- 3 Wait until the computer cools down. Then turn your computer upside down and open the cover on the bottom.

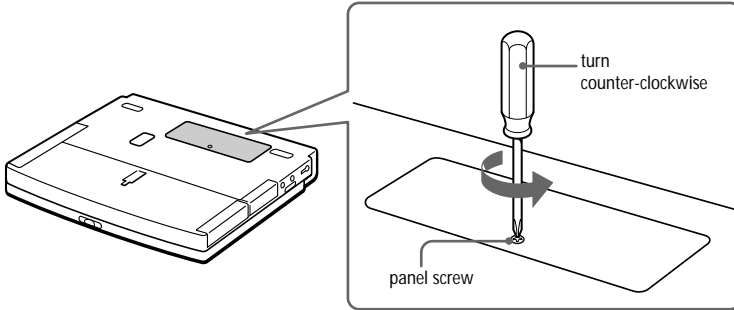

- 4 Remove the memory module from its packaging.
- 5 Install the memory module.

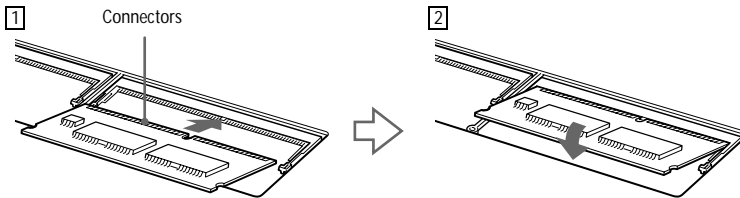

- 1 Slide the memory module into the slot.
  - 2 The connectors snap into place when the board is correctly seated.
- 6 Close the cover and tighten the screws.
  - 7 Turn on the computer.
  - 8 Click the My Computer icon with the right button and select Properties.

The System Properties screen appears.

- 9 Click the Performance tab to view memory.

If the additional memory is not shown, repeat steps 1-9.



To remove a memory module

- 1 Shut down your computer and disconnect all peripheral devices.
- 2 Unplug your computer and remove the battery packs.
- 3 Turn your computer upside down and open the cover on the bottom.
- 4 Remove the memory module.

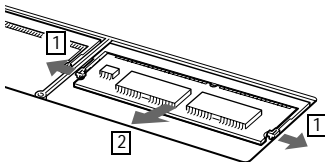

- 1 Pull the tabs in the direction of the arrows. The memory module is released.
- 2 Pull the memory module in the direction of the arrow.

- 5 Close the cover.