

SONY®

HOME AUDIO SYSTEM

Operating Instructions

Getting Started

Disc/USB Playback

USB Transfer

Tuner

BLUETOOTH

Sound Adjustment

Other Operations

Additional Information

WARNING

To reduce the risk of fire or electric shock, do not expose this apparatus to rain or moisture.

To reduce the risk of fire, do not cover the ventilation opening of the appliance with newspapers, tablecloths, curtains, etc.

Do not expose the appliance to naked flame sources (for example, lighted candles).

To reduce the risk of fire or electric shock, do not expose this appliance to dripping or splashing, and do not place objects filled with liquids, such as vases, on the appliance.

As the main plug is used to disconnect the unit from the mains, connect the unit to an easily accessible AC outlet. Should you notice an abnormality in the unit, disconnect the main plug from the AC outlet immediately. Do not install the appliance in a confined space, such as a bookcase or built-in cabinet.

Do not expose batteries or appliances with battery-installed to excessive heat, such as sunshine and fire.

The unit is not disconnected from the mains as long as it is connected to the AC outlet, even if the unit itself has been turned off.

The validity of the CE marking is restricted to only those countries where it is legally enforced, mainly in the countries EEA (European Economic Area).

This equipment has been tested and found to comply with the limits set out in the EMC regulation using a connection cable shorter than 3 meters.

CAUTION

The use of optical instruments with this product will increase eye hazard.



CLASS 1 LASER PRODUCT
LASER KLASSE 1
LUOKAN 1 LASERLAITE
KLASSE 1 LASERAPPARAT

This appliance is classified as a CLASS 1 LASER product under IEC 60825-1:2007. This marking is located on the rear exterior.

When unpacking or handling a big and/or heavy speaker, be sure to handle the speaker with two or more persons. Dropping the speaker may cause personal injury and/or property damage.

For customers in Europe



Disposal of waste batteries and electrical and electronic equipment (applicable in the European Union and other European countries with separate collection systems)

This symbol on the product, the battery or on the packaging indicates that the product and the battery shall not be treated as household waste. On certain batteries this symbol might be used in combination with a chemical symbol. The chemical symbols for mercury (Hg) or lead (Pb) are added if the battery contains more than 0.0005% mercury or 0.004% lead. By ensuring these products and batteries are disposed of correctly, you will help prevent potentially negative consequences for the environment and human health which could otherwise be caused by inappropriate waste handling. The recycling of the materials will help to conserve natural resources.

In case of products that for safety, performance or data integrity reasons require a permanent connection with an incorporated battery, this battery should be replaced by qualified service staff only. To ensure that the battery and the electrical and electronic equipment will be treated properly, hand over these products at end-of-life to the applicable collection point for the recycling of electrical and electronic equipment. For all other batteries, please view the section on how to remove the battery from the product safely. Hand the battery over to the applicable collection point for the recycling of waste batteries. For more detailed information about recycling of this product or battery, please contact your local Civic Office, your household waste disposal service or the shop where you purchased the product or battery.

Notice for customers: The following information is only applicable to equipment sold in countries applying EU Directives.

This product has been manufactured by or on behalf of Sony Corporation, 1-7-1 Konan Minato-ku Tokyo, 108-0075 Japan. Inquiries related to product compliance based on European Union legislation shall be addressed to the authorized representative, Sony Deutschland GmbH, Hedelfinger Strasse 61, 70327 Stuttgart, Germany. For any service or guarantee matters, please refer to the addresses provided in the separate service or guarantee documents.

Hereby, Sony Corp., declares that this equipment is in compliance with the essential requirements and other relevant provisions of Directive 1999/5/EC.

For details, please access the following URL:
<http://www.compliance.sony.de/>



This Home Audio System is intended for audio and video playback of discs or USB devices, music streaming from an NFC-compatible smartphone or a BLUETOOTH device, and FM/AM tuner. This system also supports karaoke.

For customers in Australia and India



Disposal of Old Electrical & Electronic Equipment (Applicable in the European Union and other European countries with separate collection systems)

For customers in United Arab Emirates

TRA
REGISTERED No:
ER0119223/13
DEALER No:
DA0063360/11

License and Trademark Notice

- **DVD** is a trademark of DVD Format/ Logo Licensing Corporation.
- "DVD+RW", "DVD-RW", "DVD+R", "DVD-R", "DVD VIDEO", and the "CD" logos are trademarks.
- MPEG Layer-3 audio coding technology and patents licensed from Fraunhofer IIS and Thomson.
- Windows Media is either a registered trademark or trademark of Microsoft Corporation in the United States and/ or other countries.
- This product is protected by certain intellectual property rights of Microsoft Corporation. Use or distribution of such technology outside of this product is prohibited without a license from Microsoft or an authorized Microsoft subsidiary.
- "WALKMAN" and "WALKMAN" logo are registered trademarks of Sony Corporation.
- This system incorporates Dolby* Digital.
* Manufactured under license from Dolby Laboratories. Dolby and the double-D symbol are trademarks of Dolby Laboratories.
- The BLUETOOTH® word mark and logos are registered trademarks owned by Bluetooth SIG, Inc. and any use of such marks by Sony Corporation is under license. Other trademarks and trade names are those of their respective owners.
- The N Mark is a trademark or registered trademark of NFC Forum, Inc. in the United States and in other countries.
- Android™ is a trademark of Google Inc.
- Google Play™ is a trademark of Google Inc.

- Apple, the Apple logo, iPhone, and iPod touch are trademarks of Apple Inc., registered in the U.S. and other countries. App Store is a service mark of Apple Inc.
- "Made for iPod" and "Made for iPhone" mean that an electronic accessory has been designed to connect specifically to iPod or iPhone, respectively, and has been certified by the developer to meet Apple performance standards. Apple is not responsible for the operation of this device or its compliance with safety and regulatory standards. Please note that the use of this accessory with iPod or iPhone may affect wireless performance.
- THIS PRODUCT IS LICENSED UNDER THE MPEG-4 VISUAL PATENT PORTFOLIO LICENSE FOR THE PERSONAL AND NON-COMMERCIAL USE OF A CONSUMER FOR
 - (i) ENCODING VIDEO IN COMPLIANCE WITH THE MPEG-4 VISUAL STANDARD ("MPEG-4 VIDEO")AND/OR
 - (ii) DECODING MPEG-4 VIDEO THAT WAS ENCODED BY A CONSUMER ENGAGED IN A PERSONAL AND NON-COMMERCIAL ACTIVITY AND/OR WAS OBTAINED FROM A VIDEO PROVIDER LICENSED TO PROVIDE MPEG-4 VIDEO.NO LICENSE IS GRANTED OR SHALL BE IMPLIED FOR ANY OTHER USE. ADDITIONAL INFORMATION INCLUDING THAT RELATING TO PROMOTIONAL, INTERNAL AND COMMERCIAL USES AND LICENSING MAY BE OBTAINED FROM MPEG LA, L.L.C.
[HTTP://WWW.MPEGLA.COM](http://www.mpegla.com)
- All other trademarks are trademarks of their respective owners.

- In this manual, ™ and ® marks are not specified.

About this manual

- The instructions in this manual are for models SHAKE-X7D and SHAKE-X3D. In this manual, the SHAKE-X7D is used for illustration purpose unless stated otherwise.
- This manual mainly explains operations using the remote control, but the same operations can also be performed using the buttons on the unit having the same or similar names.
- Icons, such as , listed at the top of each explanation indicate the type of media that can be used with the function being explained.
- Some illustrations are presented as conceptual drawings, and may be different from the actual products.
- The items displayed on the TV screen may vary depending on the area.
- The default setting is underlined.
- The text enclosed in bracket ([--]) appears on the TV screen, and the text enclosed in double quotation mark ("--") appears in the display panel.

Table of Contents

About this manual.....	5
Unpacking.....	8
Playable discs/files on Discs/ USB device	8
Guide to parts and controls	11

Getting Started

Hooking up the system securely.....	15
Positioning the speakers.....	17
Performing “QUICK” setup	17
Changing the color system (Except for Latin American, European, and Russian models).....	18
Setting the clock.....	18
Changing the display mode.....	18

Disc/USB Playback

Basic playback	19
Other playback operations	20
Using play mode	23
Restricting playback of the disc (Parental Control).....	25
Viewing information of a disc and USB device.....	26
Using the Setup Menu.....	27

USB Transfer

Transferring music	30
--------------------------	----

Tuner

Listening to the radio.....	33
-----------------------------	----

BLUETOOTH

About the BLUETOOTH wireless technology	34
One Touch BLUETOOTH Connection by NFC.....	36
Setting the BLUETOOTH audio codecs	37
Setting the BLUETOOTH standby mode	37
Setting the BLUETOOTH signal	38
Using “SongPal” via BLUETOOTH.....	38

Sound Adjustment

Adjusting the sound	39
Selecting the Virtual Football mode	39
Creating your own sound effect	40
Creating a party atmosphere (DJ EFFECT)	40

Other Operations

Using the Party Chain function	41
Singing along: Karaoke	42
Enjoying the Speaker Light.....	43
Using the timers.....	43
Using optional equipment	44
Deactivating the buttons on the unit (Child Lock).....	45
Setting the automatic standby function.....	45
Updating the software	45

Additional Information

Troubleshooting	46
Precautions	53
Specifications.....	55
Language code list	58
Index	60

Unpacking

- Remote control (1)
- R03 (size AAA) batteries (2)
- FM lead/AM loop antenna (1)

SHAKE-X7D only

- Unit: HCD-SHAKEX7 (1)
- Speaker system: SS-SHAKEX7 (2)
- AC power cord (mains lead)
 - Latin American, Middle East, and African models only (2)*
 - Other models (1)

* The quantity of the AC power cord (mains lead) supplied depends on the area.

SHAKE-X3D only

- Unit: HCD-SHAKEX3 (1)
- Speaker system: SS-SHAKEX3 (2)
- AC power cord (mains lead) (1)
- AC plug adaptor (1) (supplied only for certain areas)

The AC plug adaptor is not use in Chile. Use this plug adaptor in the countries where it is necessary.

Playable discs/files on Discs/USB device

Playable Discs

- DVD VIDEO
- DVD-R/DVD-RW in DVD VIDEO format or video mode
- DVD+R/DVD+RW in DVD VIDEO format
- VIDEO CD (Ver. 1.0, 1.1, and 2.0 discs)
- Super VCD
- CD-R/CD-RW/CD-ROM in VIDEO CD format or super VCD format
- AUDIO CD
- CD-R/CD-RW in AUDIO CD format

Playable files on Discs/USB device

- Music: MP3 files¹⁾²⁾ (.mp3), WMA files²⁾³⁾ (.wma), AAC files²⁾³⁾ (.m4a/.mp4/.3gp)

- Photo: JPEG files⁴⁾ (.jpg/.jpeg/.jpe)
- Video: MPEG4 files⁵⁾ (.mp4/.m4v), Xvid files (.avi)

Notes

- The discs must be in the following format:
 - CD-ROM/-R/-RW in DATA CD format that contains the MP3¹⁾²⁾, JPEG⁴⁾, MPEG4⁵⁾ and Xvid files, and conforms to ISO 9660⁶⁾ Level1/Level 2 or Joliet (extended format).
 - DVD-ROM/-R/-RW/+R/+RW in DATA DVD format that contains the MP3¹⁾²⁾, JPEG⁴⁾, MPEG4⁵⁾ and Xvid files, and conforms to UDF (Universal Disk Format).
- The system will attempt to play back any data with the extensions above, even if it is not in MP3/WMA/AAC/JPEG/MPEG4/Xvid format. Playing this data may generate a loud noise which could damage your speaker system.

¹⁾ MP3 (MPEG 1 Audio Layer 3) is a standard format defined by ISO/MPEG for compressed audio data. MP3 files must be in MPEG 1 Audio Layer 3 format.

²⁾ Files with copyright protection (Digital Rights Management) cannot be played back by the system.

³⁾ USB device only.

⁴⁾ JPEG files must conform to the DCF image file format. (DCF "Design rule for Camera File System": Image standards for digital cameras regulated by Japan Electronics and Information Technology Industries Association (JEITA).)

⁵⁾ MPEG4 files must be recorded in MP4 file format. Supported video codec and audio codec are as follows:

- Video codec: MPEG4 Simple Profile (AVC is not supported.)
- Audio codec: AAC-LC (HE-AAC is not supported.)

⁶⁾ A logical format of files and folders on CD-ROMs, defined by ISO (International Organization for Standardization).

Discs/files that cannot be played back

- You cannot play back the following discs
 - BDs (Blu-ray Discs)
 - CD-ROMs recorded in PHOTO CD format
 - Data part of CD-Extra or Mixed CDs*
 - CD Graphics disc
 - Super Audio CDs
 - DVD Audio
 - DATA CD/DATA DVD that is created in Packet Write format
 - DVD-RAM
 - DATA CD/DATA DVD which has not been correctly finalized
 - CPRM (Content Protection for Recordable Media) compatible DVD-R/-RW recorded in Copy-Once programs
 - A disc that has a non-standard shape (e.g., heart, square, star)
 - A disc that has adhesive tape, paper, or a sticker attached to it
- You cannot play back the following files
 - The JPEG file that is larger than 3,072 (width) × 2,048 (height) pixels in normal mode, or more than 3,300,000 pixels in Progressive JPEG mode which is mainly used on the Internet website.
 - The video files which is larger than 720 (width) × 576 (height) pixels.
 - The image and video files with a high ratio to length ratio.
 - A WMA file in WMA DRM, WMA Lossless, or WMA PRO format.
 - An AAC file in AAC DRM or AAC Lossless format.
 - The AAC files which is encoded at 96 kHz.
 - Files that are encrypted or protected by passwords.
 - Files with DRM (Digital Rights Management) copyright protection.
 - The MP3 PRO audio file can be played back as MP3 file.

- The system may not play back an Xvid file when the file has been combined from two or more Xvid files.
- The system cannot play back some Xvid files that are longer than 2 hours.

* Mixed CD: This format records data on the first track and audio (AUDIO CD data) on the second and subsequent tracks of a session.

Notes on CD-R/-RW and DVD-R/-RW/+R/+RW

- In some cases, a CD-R/-RW and DVD-R/-RW/+R/+RW cannot be played back on this system due to the recording quality or physical condition of the disc, or the characteristics of the recording device and authoring software. For more information, refer to the operating instructions of the recording device.
- Some playback functions may not work with some DVD+Rs/+RWs, even if they have been correctly finalized. In this case, view the disc by normal playback.

Notes on discs

- This product is designed to play back discs that conform to the Compact Disc (CD) standard.
- DualDisc and some music discs encoded with copyright protection technologies do not conform to the CD standard. Therefore, these discs may not be compatible with this product.

Note on multisession disc

This system can play back continuous sessions on a disc when they are recorded in the same format as the first session. However, the playback is not guaranteed.

Note on DVD VIDEO and VIDEO CD playback operations

Some playback operations for a DVD VIDEO or VIDEO CD may be intentionally restricted by software producers. Therefore, some playback features may not be available. Be sure to read the operating instructions of the DVD VIDEO or VIDEO CD.

Notes on playable files

- Playback may take a longer time to start when:
 - a DATA CD/DATA DVD/USB device is recorded with a complicated tree structure.
 - the audio files, image files, or video files in another folder have just been played back.
- The system can play back a DATA CD/DATA DVD or a USB device in the following conditions:
 - up to a depth of 8 folders
 - up to 300 folders
 - up to 999 files in a disc
 - up to 2,000 files in a USB device
 - up to 650 files in a folderThese numbers may vary depending on the file or folder configuration.
- Folders that have no audio files, image files, or video files are skipped.
- Files transferred by a device such as a computer may not be played back in the order in which they were transferred.
- The playback order may not be applicable depending on the software used for creating the audio file, image file, or video file.
- Compatibility with all MP3/WMA/AAC/MPEG4/Xvid encoding/writing software, recording devices, and recording media cannot be guaranteed.
- Depending on the Xvid file, the picture may be unclear or the sound may skip.

Notes about USB devices

- This system is not guaranteed to operate with all USB devices.
- Although there are a variety of complex functions for USB devices, the playable contents of USB devices connected to the system are music, photo, and video contents only. For details, refer to the operating instructions of the USB device.
- When a USB device is inserted, the system reads all the files on the USB device. If there are many folders or files on the USB device, it may take a long time to finish reading the USB device.
- Do not connect the system and the USB device through a USB hub.
- With some connected USB devices, there may be a delay before an operation is performed by this system.
- The playback order for the system may differ from the playback order of the connected USB device.
- Before using a USB device, make sure that no virus-ridden files are on the USB device.

Websites for compatible devices

Check the websites below for the latest information about compatible USB and BLUETOOTH devices.

For customers in Latin America:

<<http://esupport.sony.com/LA>>

For customers in Europe and Russia:

<<http://www.sony.eu/support>>

For customers in other countries/
regions:

<<http://www.sony-asia.com/support>>

Guide to parts and controls

Top panel

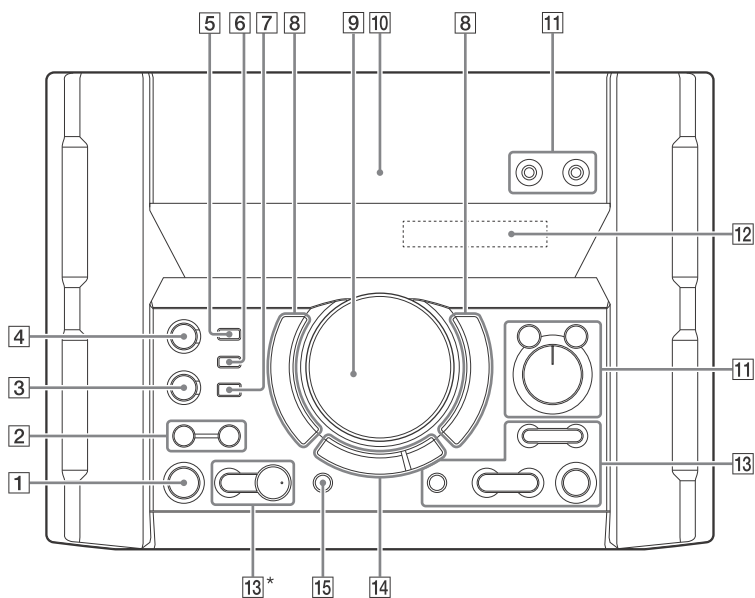

Front panel

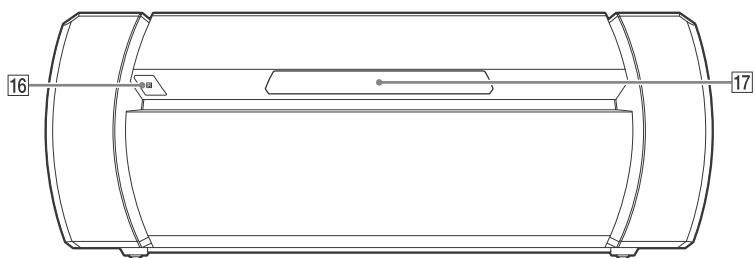

* The ► button has a tactile dot. Use the tactile dot as a reference when operating the system.

- 1** **I/⏻ (on/standby)**
Turns on the system, or sets it to standby mode.
- 2** **SPEAKER LIGHT (page 43)**
LIGHT MODE (page 43)
- 3** **BLUETOOTH**
Press to select BLUETOOTH function.
PAIRING
Hold down to activate BLUETOOTH pairing during BLUETOOTH function.
BLUETOOTH indicator (page 34)
- 4** **MEGA BASS (page 39)**
MEGA BASS indicator (page 39)
- 5** **🔌 (USB) 1 (PLAY) port**
Connects an optional USB device.
- 6** **🔌 (USB) 2 (REC/PLAY) port**
Connects and transfers to an optional USB device.
- 7** **REC TO USB**
Transfers music to the optional USB device which is connected to the 🔌 (USB) 2 port.
- 8** **FLANGER, ISOLATOR, SAMPLER, DJ OFF (page 40)**
- 9** **VOLUME/MULTI CONTROL**
Adjusts the volume.*
Adjusts the FLANGER and ISOLATOR effect level or outputs the SAMPLER sound effect continuously (page 40).
Selects a FUNCTION or SOUND FIELD.
* You cannot use this knob to adjust the volume when DJ EFFECT, FUNCTION, or SOUND FIELD is selected.
- 10** **📑 (N-Mark) (page 36)**
- 11** **MIC 1/2 jack**
Connects the microphone(s).
VOCAL FADER (page 43)

MIC ECHO (page 42)
MIC LEVEL (MIN/MAX)
Adjusts the microphone volume.

- 12** **Display panel**
- 13** **📁 +/- (select folder)**
Selects a folder on a data disc or a USB device.

S1, S2 (page 40)

▲ (open/close)

Inserts or ejects a disc.

◀◀/▶▶ (go backward/go forward) (page 19, 20, 22, 35)

TUNING+/- (page 33)

S3, S4 (page 40)

ENTER

Enters the settings.

▶ (play)

Starts playback.

Hold down ▶ on the unit for more than 2 seconds, the built-in sound demonstration will be played back on the system. Press ■ to stop the demonstration.

■ (stop)

Stops playback.

Press twice to cancel resume playback.

- 14** **FUNCTION***

SOUND FIELD*

FOOTBALL (page 39)

Press this button repeatedly to select "ON NARRATION" or "OFF NARRATION".

* Press this button, then turn the VOLUME/MULTI CONTROL knob to select the function or sound field you want, then press ENTER.

- 15** **PARTY CHAIN (page 41, 42, 51)**

- 16** **Remote control sensor**

- 17** **Disc tray**

Remote control

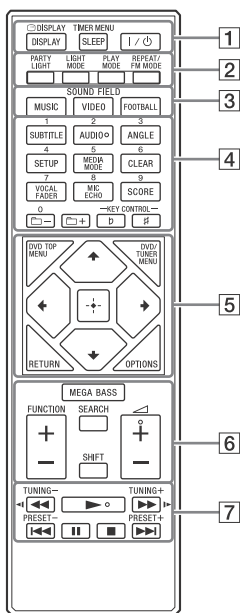

Notes

- The numeric button 2/AUDIO, \blacktriangleleft + and \blacktriangleright buttons have a tactile dot. Use the tactile dot as a reference when operating the system.
- To use the button printed in pink, hold down SHIFT ([6]), then press the button.

1 DISPLAY (page 18, 27, 33, 35)

[] DISPLAY (page 24, 26)

SLEEP (page 43)

TIMER MENU (page 18, 44)

I/O (on/standby)

Turns on the system, or sets it to standby mode.

2 PARTY LIGHT (page 43)

LIGHT MODE (page 43)

PLAY MODE (page 23, 24, 31)

REPEAT/FM MODE (page 25, 33)

3 SOUND FIELD buttons (page 39)

MUSIC, VIDEO, FOOTBALL

4 Numeric buttons

Selects a track, chapter or file. Tunes or presets a radio station. Enters a password.

SUBTITLE (page 21)

AUDIO (page 22, 26)

ANGLE (page 21)

SETUP (page 17, 25, 27, 51)

MEDIA MODE (page 19, 20, 24, 32)

CLEAR (page 21, 24)

VOCAL FADER (page 43)

MIC ECHO (page 42)

SCORE (page 43)

[] +/- (select folder)

Selects a folder on a data disc or a USB device.

KEY CONTROL b/\# (page 43)

5 DVD TOP MENU

Displays the DVD title on the TV screen.

DVD/TUNER MENU (page 20, 21, 34)

RETURN (page 20, 24)

OPTIONS

Enters or exits the options menu.

$\blacktriangleup/\blacktriangledown/\blacktriangleleft/\blacktriangleright$

Selects the menu items.

[+]

Enters the settings.

6 MEGA BASS (page 39)

FUNCTION +/-

Selects a function.

SEARCH (page 20, 21, 24)

SHIFT

Hold down to activate the buttons printed in pink.

 +/-

Adjusts the volume.

7 <<</>>> (rewind/fast forward) (page 20, 35)

<||/||> (page 20)

Watches the Slow-motion Play.

TUNING+/- (page 33)

▶ (play)

Starts playback.

⏮/⏭ (go backward/go forward) (page 19, 20, 22, 35)

PRESET+/- (page 34)

⏸ (pause) (page 19, 20, 35)

■ (stop)

Stops playback.

Press twice to cancel resume playback.

Stops the built-in sound demonstration.

Hooking up the system securely

SHAKE-X7D/SHAKE-X3D

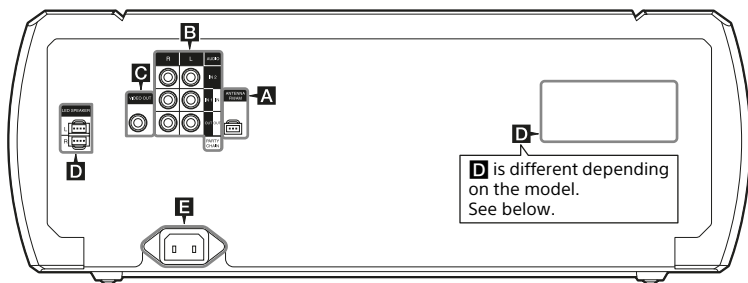

D

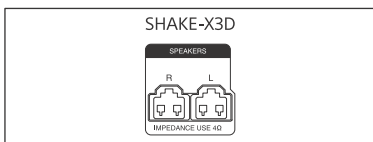
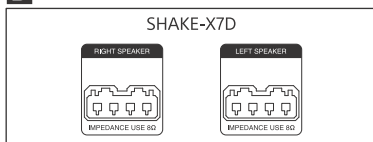

A Antennas

Find a location and an orientation that provide good reception when you set up the antennas.

Keep the antennas away from the speaker cords, the AC power cord (mains lead) and the USB cable to avoid picking up noise.

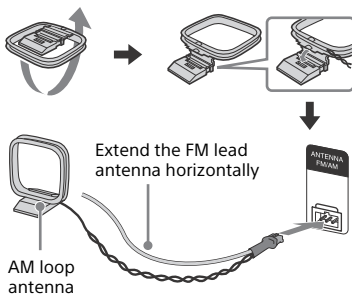

B Audio

Use an audio cord (not supplied) to make either connection as follows:

– AUDIO OUT/PARTY CHAIN OUT L/R jacks

- Connect to the audio input jacks of an optional equipment.
- Connect to another audio system to enjoy the Party Chain function (page 41).

– AUDIO IN 1/PARTY CHAIN IN L/R jacks

- Connect to the audio output jacks of a TV or an audio/video equipment. The sound is output through this system.
- Connect to another audio system to enjoy the Party Chain function (page 41).

– AUDIO IN 2 L/R jacks

Connect to the audio output jacks of a computer or gaming device. The sound is output through this system.

C VIDEO OUT jack

Use a video cord (not supplied) to connect to the video input jack of a TV or projector.

Note

Do not connect this unit to the TV through the video deck.

D Speakers

– LED SPEAKER terminals

Connect the LED SPEAKER connector of the speaker to this terminal. The lighting on the speakers will react according to the music source. You can select the Speaker Light according to your preference (page 43).

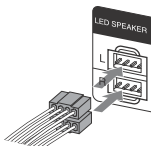

– LEFT SPEAKER and RIGHT SPEAKER terminals (SHAKE-X7D only)

– SPEAKERS terminals (SHAKE-X3D only)

Example:

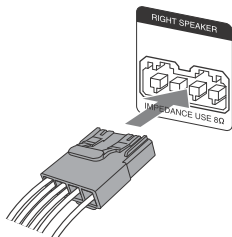

Notes

- Be sure to use only the supplied speakers.
- When connecting speaker cords, insert the connector straight into the terminals.

E Power

Connect the AC power cord (mains lead) (supplied) to the unit, then plug it into a wall outlet.

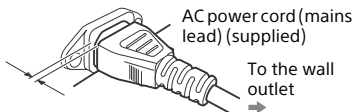

A several space is left between the plug and the rear panel even when the power cord (mains lead) is inserted firmly. The cord is supposed be connected this way. This is not a malfunction.

Notes

- If the AC plug of your unit does not fit into the wall outlet, attach the supplied AC plug adaptor (only for models supplied with the AC plug adaptor).
- The demonstration appears in the display panel. Press I/⏻ to turn on the system and the demonstration automatically ends.

Inserting batteries

Insert the two supplied R03 (size AAA) batteries by matching the polarities as shown below.

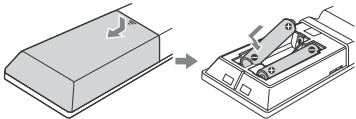

Notes

- Do not mix an old battery with a new one or mix different types of batteries.
- If you do not use the remote control for a long period of time, remove the batteries to avoid damage from battery leakage and corrosion.

Positioning the speakers

To obtain optimum performance from the system, we recommend you to place the speakers as shown below.

- Ⓐ Unit
- Ⓑ Speaker (left)
- Ⓒ Speaker (right)
- Ⓓ TV

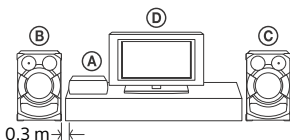

Performing "QUICK" setup

Before using the system, you can make the minimum basic adjustments in "QUICK" setup.

- 1 Turn on your TV and select the video input.
- 2 Press I/⏻ to turn on the system.

- 3 Press **FUNCTION** +/- repeatedly to select "DVD/CD", "USB 1", or "USB 2".

The guide message [Press ENTER to run QUICK SETUP.] appears at the bottom of the TV screen.

- 4 Press **[+]** without inserting a disc or connecting a USB device.

[LANGUAGE SETUP] appears on the TV screen. Displayed items may vary depending on country or region.

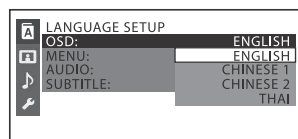

- 5 Press **↑/↓** repeatedly to select a language, then press **[+]**.

[VIDEO SETUP] appears on the TV screen.

- 6 Press **↑/↓** repeatedly to select the setting that matches your TV type, then press **[+]**.

After [QUICK SETUP is complete.] appears on the TV screen, the system is ready for playback.

To change the setting manually
See "Using the Setup Menu" (page 27).

To quit "QUICK" setup
Press SETUP.

Note

The guide message appears when you turn on the system for the first time or after performing "RESET" (page 51).

Changing the color system

(Except for Latin American, European, and Russian models)

Set the color system to PAL or NTSC depending on the color system of your TV.

Each time you perform the procedure below, the color system changes as follows:



NTSC ↔ PAL

Use the buttons on the unit to perform this operation.

- 1 Press I/⏻ to turn on the system.**
- 2 Press FUNCTION, then turn the VOLUME/MULTI CONTROL knob to select "DVD/CD", then press ENTER.**
- 3 Hold down DJ OFF and FOOTBALL for more than 3 seconds.**
"COLOR NTSC" or "COLOR PAL" appears in the display panel.

Setting the clock

You cannot set the clock in Power Saving Mode.

- 1 Press I/⏻ to turn on the system.**
- 2 Hold down SHIFT, then press TIMER MENU.**
"PLAY SET" appears in the display panel. Press ↑/↓ repeatedly to select "CLOCK SET", then press .
- 3 Press ↑/↓ repeatedly to set the hour, then press .**
- 4 Press ↑/↓ repeatedly to set the minutes, then press .**

Changing the display mode

Press DISPLAY repeatedly when the system is turned off.

Demonstration

The demonstration is turned on.

No display (Power Saving Mode)

The display is turned off to conserve power. The timer and clock continue to operate.

Clock

The clock is displayed for a few seconds, then enters the Power Saving Mode.

Disc/USB Playback

Basic playback

DVD-V VIDEO CD C D DATA CD DATA DVD USB

- 1 Press **FUNCTION +/-** repeatedly to select "DVD/CD", "USB 1", or "USB 2".

You can also use the buttons on the unit. Press **FUNCTION**, then turn the **VOLUME/MULTI CONTROL** knob to select "DVD/CD", "USB 1", or "USB 2", then press **ENTER**.

- 2 For DVD/CD function:

Press **▲** on the unit to open the disc tray and load a disc with the label facing up.

When you play back an 8 cm disc such as a CD single, place it on the inner circle of the tray



Press **▲** on the unit again to close the disc tray. Do not forcibly push the disc tray to close it as this may cause a malfunction.

For USB function:

Connect a USB device to the ψ (USB) 1 or ψ (USB) 2 port.

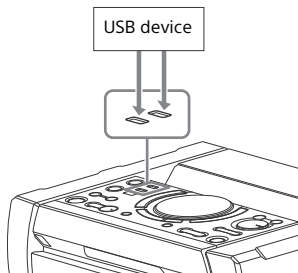

Notes

- You can use your iPhone/iPod with this system via BLUETOOTH connection only.
- You can use a USB adaptor (not supplied) to connect the USB device to the unit if the USB device cannot be plugged into the ψ (USB) port.

- 3 (**DATA CD** **DATA DVD** **USB** only) Press **MEDIA MODE** repeatedly to select the media ([**MUSIC**]/[**VIDEO**]/[**PHOTO**]) you want.

- 4 Press **▶** to start playback.

To	Press
Stop playback	■
Pause playback	
Resume playback or return to normal playback	▶
Cancel the resume point	■ twice
Select a track, file, chapter or scene	◀◀ or ▶▶ during playback. Or, hold down SHIFT , then press the numeric buttons, and then press + . (Operation might be prohibited by disc or USB device)

To select USB memory

You can select which memory to use as a playback source or transfer destination if the USB device has an internal memory and a memory card. Make sure to select a memory before starting playback or transfer.

- 1 Press **OPTIONS**.
- 2 Press **▲/▼** repeatedly to select "MEM SEL", then press **+**.
- 3 Press **▲/▼** repeatedly to select the memory you want, then press **+**.
To exit the options menu, press **OPTIONS**.

To play from a specific audio or video file

- 1 Press MEDIA MODE repeatedly to select [MUSIC] or [VIDEO].
- 2 Press SEARCH to display the Folder List.

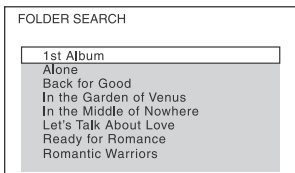

- 3 Press \uparrow/\downarrow repeatedly to select the folder you want.
- 4 Press $\boxed{+}$ to display the File List.

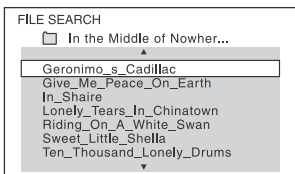

- 5 Press \uparrow/\downarrow repeatedly to select the file you want, then press $\boxed{+}$.

To play from a specific image file (slide show)

- 1 Press MEDIA MODE repeatedly to select [PHOTO].
- 2 Press DVD/TUNER MENU.

Thumbnail picture for the first 16 JPEG files in the selected folder is displayed on the TV screen.



If there are more than 16 JPEG files in the selected folder, the scroll bar appears at the right.

- 3 Press $\uparrow/\downarrow/\leftarrow/\rightarrow$ repeatedly to select the file you want, then press \blacktriangleright .

Other playback operations



Depending on the type of disc or file, the function may not work.

To	Press
View DVD menu	DVD/TUNER MENU
View Folder List or File List	SEARCH. Press the button again to turn off the Folder List or File List.
Return to Folder List when in File List	RETURN
Locate a point quickly in fast forward or fast reverse (Lock Search)	\lll or \ggg during playback. Each time you press the button, the playback speed changes.
Watch frame by frame (Slow-motion Play)	II , then press \lll or \ggg . Each time you press \lll or \ggg , the playback speed changes.
View images in thumbnail view	DVD/TUNER MENU
Navigate in thumbnail view	$\uparrow/\downarrow/\leftarrow/\rightarrow$
View single image	$\boxed{+}$ in thumbnail view.
Start image slide show	\blacktriangleright . You can change the interval of the slide show (page 28), and add effects to the slide show (page 28).
Stop image slide show	\blacksquare
View next or previous image during slide show	\lll or \ggg

To	Press
Rotate the image by 90 degrees	←/→ while viewing a picture. Press CLEAR to return to the original view.

Searching a specific track

CD

Hold down SHIFT, then press the numeric buttons to select the track you want to play back, then press .

To search using the SEARCH button

- 1 Press SEARCH to display the Track List.
- 2 Press ↑/↓ repeatedly to select the track you want to play back, then press .

Searching a specific title/ chapter/scene/track/index

DVD-V VIDEO CD

- 1 Press SEARCH repeatedly during playback to select the search mode.
- 2 Hold down SHIFT, then press the numeric buttons to enter the title, chapter, scene, track, or index number you want, then press . Playback starts.

Notes

- For VIDEO CD with PBC playback, press SEARCH to search the scene.
- For VIDEO CD without PBC playback, press SEARCH to search the track and index.

To search using the time code

DVD-V

- 1 Press SEARCH repeatedly during playback to select the time search mode.
- 2 Hold down SHIFT, then press the numeric buttons to enter the time code, then press .
Example: To find a scene at 2 hours, 10 minutes, and 20 seconds, hold down SHIFT, then press 2, 1, 0, 2, 0 ([2:10:20]).
Press CLEAR to cancel the number.

To search using the DVD menu

DVD-V

- 1 Press DVD/TUNER MENU.
- 2 Press ↑/↓/←/→ or hold down SHIFT, then press the numeric buttons to select the title or item you want to play back, then press .

Changing the angles

DVD-V

Press ANGLE repeatedly during playback to select the angle you want.

Displaying the subtitles

DVD-V

Press SUBTITLE repeatedly during playback to select the subtitle language you want or turn off the subtitle.

Changing the language/ sound

DVD-V

VIDEO CD

C D

DATA CD

DATA DVD

USB

Press **AUDIO** repeatedly during playback to select the audio format or mode you want.

DVD VIDEO

You can toggle audio format or language when the source contains multiple audio formats or multilingual audio.

When 4 digits are displayed, they indicate a language code. See “Language code list” (page 58) to confirm which language the code represents. When the same language is displayed two or more times, the DVD VIDEO is recorded in multiple audio formats.

VIDEO CD/AUDIO CD/DATA CD/ DATA DVD (MP3 file) or USB device (audio file)

You can change the sound track.

- [STEREO]: The stereo sound.
- [1/L]/[2/R]: The monaural sound of the left or right channel.

SUPER VIDEO CD

- [1:STEREO]: The stereo sound of audio track 1.
- [1:1/L]/[1:2/R]: The monaural sound of the left or right channel of audio track 1.
- [2:STEREO]: The stereo sound of audio track 2.
- [2:1/L]/[2:2/R]: The monaural sound of the left or right channel of audio track 2.

Playing a VIDEO CD with PBC functions

VIDEO CD

You can use the PBC (Playback Control) menu to enjoy the VIDEO CD's interactive software.

- 1 Press **▶** to play a VIDEO CD in PBC.
The PBC menu appears on the TV screen.
- 2 Hold down **SHIFT**, then press the numeric buttons to select the item number you want, then press **[+]**.
- 3 Continue playback according to the instructions on the menu.

Note

PBC playback is canceled when Repeat Play is activated.

To cancel PBC playback

- 1 Press **◀◀** or **▶▶**, or hold down **SHIFT**, then press the numeric buttons to select a track when playback is stopped.
- 2 Press **▶** or **[+]**.
Playback starts from the selected track.

To return to PBC playback

Press **■** twice, then press **▶**.

Multi-disc resume play

DVD-V VIDEO CD

This system can store playback resume points for up to 6 discs and resumes playback when you insert the same disc again. If you store a playback resume point for the 7th disc, the resume point for the first disc will be deleted.

To activate this function, set [MULTI-DISC RESUME] in [SYSTEM SETUP] to [ON] (page 29).

Note

To play back from the beginning of the disc, press ■ twice, then press ►.

Using play mode

Playing in original order (Normal Play)

CD DATA CD DATA DVD USB

When playback is stopped, press **PLAY MODE** repeatedly.

■ When playing a disc

- [DISC]: plays a disc.
- [FOLDER]*: plays all compatible files in the folder on the disc.

* Cannot be selected for AUDIO CD.

■ When playing a USB device

- [ALL USB DEVICES]: plays all USB devices.
- [ONE USB DEVICE]: plays a USB device.
- [FOLDER]: plays all compatible files in the folder on a USB device.

Playing in random order (Shuffle Play)

CD DATA CD DATA DVD USB

When playback is stopped, press **PLAY MODE** repeatedly.

■ When playing a disc

- [DISC (SHUFFLE)]: shuffles all audio files on a disc.
- [FOLDER (SHUFFLE)]*: shuffles all audio files in the folder on the disc.

* Cannot be selected for AUDIO CD.

■ When playing a USB device

- [ALL USB DEVICES (SHUFFLE)]: shuffles all audio files on all USB devices.
- [ONE USB DEVICE (SHUFFLE)]: shuffles all audio files on a USB device.
- [FOLDER (SHUFFLE)]: shuffles all compatible files in the folder on the USB device.

Notes

- Shuffle Play cannot be performed for image and video files.
- Shuffle Play is canceled when you:
 - turn off the system.
 - open the disc tray.
 - perform USB transfer (except REC1 Transfer).
 - transfer music from a disc to a USB device (except REC1 Transfer).
 - change MEDIA MODE.
 - change the selected USB memory.
- Shuffle Play may be canceled when you select a folder or a track to play back.

Creating your own program (Program Play)

CD DATA CD DATA DVD USB

You can make a program of up to 25 steps in the order you want them to be played back.

You can only program the audio tracks/files from the current disc or USB 1.

1 Press **FUNCTION +/-** repeatedly to select "DVD/CD" or "USB 1".

2 (DATA CD DATA DVD USB only)
Press **MEDIA MODE** repeatedly to select [MUSIC].

3 When playback is stopped, press **PLAY MODE** repeatedly to select [PROGRAM].

4 Press **SEARCH**.
The Folder List or Track List appears on the TV screen.

5 (DATA CD DATA DVD USB only)
Press **↑/↓** repeatedly to select the folder you want, then press **[+]**.
File List appears on the TV screen.

6 Press **↑/↓** repeatedly to select the track or file you want, then press **[+]**.
The program step number appears on the left side of the selected track or file.

7 To program other tracks or files in the same folder, repeat step 6.
To program files on other folders, press **RETURN** to return to Folder List and repeat steps 5 and 6.

8 Press **▶** to start Program Play.
Program List is displayed on the TV screen.
When the Program Play ends, you can restart the same program by pressing **▶**.

To delete a programmed step

- 1 Use the same procedure as in step 4 and step 5 of "Creating your own program".
- 2 Press **↑/↓** repeatedly to select the track or file you want to delete, then press **[+]**.
The program step number disappears.

To delete the last step from the Program List

Press **CLEAR**.

To display the Program List

Hold down **SHIFT**, then press **[DISP]** repeatedly.

To cancel Program Play

When playback is stopped, press **PLAY MODE** repeatedly to select other play modes.

Notes

- Program Play cannot be performed for image and video files.
- Program Play is canceled when you:
 - open the disc tray.
 - change MEDIA MODE.
 - change the selected USB memory.
- (DVD/CD function only) The program list is cleared when you open the disc tray.
- (USB function only) The program list is cleared when you:
 - perform the erase operation.
 - remove the USB device.
 - change the selected USB memory.

Playing repeatedly (Repeat Play)

DVD-V VIDEO CD C D DATA CD DATA DVD USB

Press REPEAT repeatedly.

Depending on the type of disc or file, some settings may not be available.

- [OFF]: does not play back repeatedly.
- [ALL]: repeats all tracks or files in the selected play mode.
- [DISC]: repeats all contents (DVD VIDEO and VIDEO CD only).
- [TITLE]: repeats the current title (DVD VIDEO only).
- [CHAPTER]: repeats the current chapter (DVD VIDEO only).
- [TRACK]: repeats the current track.
- [FILE]: repeats the current video file.

To cancel Repeat Play

Press REPEAT repeatedly to select [OFF].

Notes

- "⏮" lights up in the display panel when Repeat Play is set to [ALL] or [DISC].
- "⏮ 1" lights up in the display panel when Repeat Play is set to [TITLE], [CHAPTER], [TRACK] or [FILE].
- You cannot perform Repeat Play with VIDEO CD during PBC playback.
- Depending on the DVD VIDEO, you cannot perform Repeat Play.
- Repeat Play is canceled when you:
 - open the disc tray.
 - turn off the system (DVD VIDEO and VIDEO CD only).
 - change the function (DVD VIDEO and VIDEO CD only).
 - perform USB transfer (except REC1 Transfer).
 - transfer music from a disc to a USB device (except REC1 Transfer).
 - change MEDIA MODE.
 - change the selected USB memory.

Restricting playback of the disc

(Parental Control)

DVD-V

You can restrict playback of DVD VIDEOS according to a predetermined level. Scenes may be skipped or replaced with different scenes.

- 1 When playback is stopped, press SETUP.**
- 2 Press \uparrow/\downarrow repeatedly to select [SYSTEM SETUP], then press $\boxed{+}$.**
- 3 Press \uparrow/\downarrow repeatedly to select [PARENTAL CONTROL], then press $\boxed{+}$.**
- 4 Enter or re-enter your 4-digit password using the numeric buttons, then press $\boxed{+}$.**
- 5 Press \uparrow/\downarrow repeatedly to select [STANDARD], then press $\boxed{+}$.**
- 6 Press \uparrow/\downarrow repeatedly to select a geographic area as the playback limitation level, then press $\boxed{+}$.**
The area is selected.
When you select [OTHERS \rightarrow], enter the area code for the geographic area you want according to the "Parental Control area code list" on page 59 by using the numeric buttons.
- 7 Press \uparrow/\downarrow repeatedly to select [LEVEL], then press $\boxed{+}$.**
- 8 Press \uparrow/\downarrow repeatedly to select the level you want, then press $\boxed{+}$.**
The lower the value, the stricter the limitation.

To turn off the "PARENTAL CONTROL" function

Set [LEVEL] to [OFF] in step 8.

To play back a disc for which "PARENTAL CONTROL" is set

- 1 Load the disc and press ►.
The display for entering your password appears on the TV screen.
- 2 Enter your 4-digit password using the numeric buttons, then press [+].
The system starts playback.

If you forget your password

Remove the disc and repeat steps 1 to 3 of "Restricting playback of the disc" (page 25). Enter a password "199703" using the numeric buttons, then press [+]. Follow the on-screen instructions and enter a new 4-digit password. Then, reload the disc and press ►. You need to enter your new password again.

Viewing information of a disc and USB device

DVD-V VIDEO CD C D DATA CD DATA DVD USB

Information on the TV screen

Hold down SHIFT, then press [] DISPLAY repeatedly during playback.

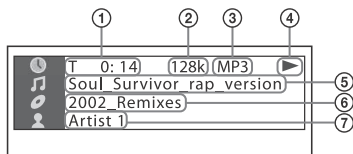

- ① **Playback information**
Playing time, remaining time and date information¹⁾.
- ② **Bit rate**
- ③ **File type**
- ④ **Playback status**
- ⑤ **Title²⁾/track/file name³⁾**
- ⑥ **Album²⁾/folder name³⁾/chapter/index number**
- ⑦ **Artist name²⁾³⁾**
Appears when playing an audio file.

¹⁾ Date information is displayed when the Exif (Exchangeable Image File Format) is recorded in the JPEG file. Exif is a digital camera image format defined by the Japan Electronics and Information Technology Industries Association (JEITA).

²⁾ If an audio file has an ID3 tag, the system will display an album name/title name/artist name from the ID3 tag information. The system can support ID3 ver 1.0/1.1/2.2/2.3.

³⁾ If the file or folder contains characters which cannot be displayed, those characters will be displayed as "_".

Notes

- Depending on the source being played, – some information may not be displayed.
– some characters cannot be displayed.
- Depending on the play mode, the information displayed may be different.

Displaying the audio information

(DVD VIDEO and video files only)
Press AUDIO repeatedly during playback.

Information in the display panel

Press **DISPLAY** repeatedly when the system is on.

You can view the information as follows:

- playing time, remaining time of track, title, chapter
- scene number
- file name, folder name
- title, artist and album information

Notes

- The disc name or track name may not be displayed depending on the text.
- Playing time of MP3 files and video files may not be displayed correctly.
- The elapsed playing time of an audio file encoded using a VBR (variable bit rate) is not displayed correctly.

Using the Setup Menu

You can make various adjustments to items such as picture and sound. Displayed items vary depending on the country or region.

Note

Playback settings stored in the disc take priority over the Setup Menu settings. Therefore, some of the Setup Menu settings may not be performed.

- 1** When playback is stopped, press **SETUP**.
The Setup Menu appears on the TV screen.
- 2** Press **↑/↓** repeatedly to select **[LANGUAGE SETUP]**, **[VIDEO SETUP]**, **[AUDIO SETUP]**, or **[SYSTEM SETUP]**, then press **[+]**.
- 3** Press **↑/↓** repeatedly to select the item you want, then press **[+]**.

- 4** Press **↑/↓** repeatedly to select the setting you want, then press **[+]**.

The setting is selected and setup is completed.

To exit the menu

Press **SETUP**.



Setting the language – [LANGUAGE SETUP]

[OSD]

Selects the language of the on-screen display.

[MENU]

DVD-V

Selects the language for the DVD menu.

[AUDIO]

DVD-V

Switches the language of the sound track.

When you select **[ORIGINAL]**, the language given priority in the disc is selected.

[SUBTITLE]

DVD-V

Switches the language of the subtitle recorded on the DVD VIDEO.

When you select **[AUDIO FOLLOW]**, the language for the subtitles changes according to the language you selected for the sound track.

Note

If you select **[OTHERS →]** in **[MENU]**, **[AUDIO]**, and **[SUBTITLE]**, enter a language code from the “Language code list” (page 58) using the numeric buttons.



Setting the TV screen – [VIDEO SETUP]

[TV TYPE]

DVD-V

[16:9]: Selects this when you connect a wide-screen TV or a TV with a wide mode function.

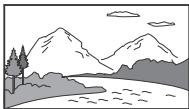

[4:3 LETTER BOX]: Selects this when you connect a 4:3 screen TV without a wide mode function. This setting displays a wide picture with black bands on the top and bottom.



[4:3 PAN SCAN]: Selects this when you connect a 4:3 screen TV without a wide mode function. This setting displays a full-height picture on the entire screen, with trimmed sides.



[COLOR SYSTEM (VIDEO CD)]

(Except for Latin American, European, and Russian models)

DVD-V

Selects the color system (PAL or NTSC).

[AUTO]: Outputs the video signal according to the color system of the disc. Select this setting if your TV uses a DUAL system.

[PAL]: Outputs the video signal in PAL.

[NTSC]: Outputs the video signal in NTSC.

For details, see “Changing the color system” (page 18).

[BLACK LEVEL]

(For Latin American models only)
Selects the black level (setup level) for the video signals output from the VIDEO OUT jack.

[ON]: Sets the black level of the output signal to the standard level.

[OFF]: Lowers the standard black level. Use this when the picture becomes too white.

[PAUSE MODE]

DVD-V

[AUTO]: The picture, including subjects that move dynamically, is output with no jitter. Normally select this setting.

[FRAME]: The picture, including subjects that do not move dynamically, is output in high resolution.

[PHOTO EFFECT]

DATA CD DATA DVD USA

(JPEG files only)

[MODE 1]: The image sweeps in from top to bottom.

[MODE 2]: The image sweeps in from left to right.

[MODE 3]: The image stretches out from the center.

[MODE 4]: The image randomly cycles through the effects.

[MODE 5]: The next image slides over the current image.

[OFF]: Off.

[PHOTO INTERVAL]

DATA CD DATA DVD USA

(JPEG files only)

[NORMAL]/[FAST]/[SLOW 1]/

[SLOW 2]: Selects the slide show duration. [SLOW 2] is slower than [SLOW 1].



Setting the audio options – [AUDIO SETUP]

[AUDIO DRC] (Dynamic Range Compression)

DVD-V

Useful for watching movies at low volume late at night.

[OFF]: Off.

[STANDARD]: The dynamic range is compressed as intended by the recording engineer.

[TRACK SELECTION]

DVD-V

[OFF]: Off.

[AUTO]: Gives priority to the sound track which contains the highest number of channels when you play back a DVD VIDEO on which multiple audio formats (PCM, MPEG, or Dolby Digital) are recorded.

[SCORE MODE]

**[BEGINNER 1]*/[BEGINNER 2]/
[EXPERT 1]*/[EXPERT 2]:** Selects the scoring mode to rate your singing when in Karaoke Mode.

[DEMO]: Demonstration mode. The score is displayed regardless of singing.

* The score is displayed while singing.

[A/V SYNC]

DVD-V VIDEO CD DATA CD DATA DVD

(Video files only)

[OFF]: Off.

[ON]: Adjusts the delay between picture and sound.

[DOWNMIX]

DVD-V

Selects the audio output signal for playing a multi-channel audio.

[NORMAL]: Outputs multi-channel audio into a 2-channel stereo signal.

[DOLBY SURROUND]: Outputs multi-channel audio into a 2-channel surround signal.



Setting the system – [SYSTEM SETUP]

[SCREEN SAVER]

Prevents damage on the TV. Press any button to cancel the screen saver.

[ON]: Turns on the screen saver function if you do not operate the system for about 15 minutes.

[OFF]: Off.

[BACKGROUND]

Selects the background color or picture to be displayed on the TV screen.

[JACKET PICTURE]: The jacket picture (still picture) that recorded on the disc appears in the background.

[GRAPHICS]: A preset picture stored in the system appears in the background.

[BLUE]: The background color is blue.

[BLACK]: The background color is black.

[PARENTAL CONTROL]

Sets the playback restrictions. For details, see "Restricting playback of the disc" (page 25).

[MULTI-DISC RESUME]

DVD-V VIDEO CD

[ON]: Stores the resume playback point in the memory for up to 6 discs.

[OFF]: Only stores the resume playback point for the current disc in the system.

[RESET]

Returns "SETUP" settings to the default settings. For details, see "Returning the "SETUP" settings to the default" (page 51).

USB Transfer

Transferring music

You can transfer music from a sound source to a USB device connected to the ψ (USB) 2 port.

The audio format of files transferred by this system is MP3. However, you can also transfer WMA and AAC files from USB 1.

Notes

- Do not remove the USB device during transfer or erase operations. Doing so may corrupt the data on the USB device or damage the USB device itself.
- MP3/WMA/AAC files are transferred with the same bit rate as the original files.
- When transferring from TUNER, AUDIO IN 1 or AUDIO IN 2 function, or an AUDIO CD, you may select the bit rate before transferring.
- USB transfer and erase operations are prohibited when the disc tray is opened.

Note on copyright-protected content

The transferred music is limited to private use only. Use of the music beyond this limit requires permission of the copyright holders.

To select USB memory

See page 19.

To select the bit rate

You can select a higher bit rate to transfer music with better quality.

- 1 Press **OPTIONS**.
- 2 Press \uparrow / \downarrow repeatedly to select "BIT RATE", then press $\boxed{+}$.
- 3 Press \uparrow / \downarrow repeatedly to select the bit rate you want, then press $\boxed{+}$.

- 128 KBPS: encoded MP3 tracks have smaller file size and lower audio quality.
- 256 KBPS: encoded MP3 tracks have bigger file size but higher audio quality.

To exit **OPTIONS** menu, press **OPTIONS**.

Transferring music from a disc, a USB device or an analog audio source

You can transfer music to a USB device connected to ψ (USB) 2 port as follows:

- Synchronized Transfer: Transfer all musics from a disc or USB 1 to USB 2.
- REC1 Transfer: Transfer a single track or audio file during playback.
- Analog Transfer: Transfer sound from TUNER, AUDIO IN 1, or AUDIO IN 2 function.

Use the buttons on the unit to perform this operation.

- 1 **Connect a transferable USB device to the ψ (USB) 2 port as shown below.**

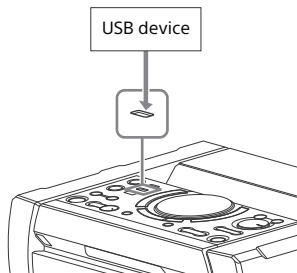

Note

You can use a USB adaptor (not supplied) to connect the USB device to the unit if the USB device cannot be plugged into the ψ (USB) port.

2 For Synchronized Transfer and REC1 Transfer:

(For disc)

Press FUNCTION, then turn the VOLUME/MULTI CONTROL knob to select "DVD/CD", then press ENTER. If the system starts playback automatically, press ■ twice to stop the playback.

(For USB)

Press FUNCTION, then turn the VOLUME/MULTI CONTROL knob to select "USB 1", then press ENTER. Connect a USB device you want to transfer to ψ (USB) 1 port.

For Analog Transfer:

Press FUNCTION, then turn the VOLUME/MULTI CONTROL knob to select the source ("TUNER FM"/"TUNER AM"/"AUDIO IN 1"/"AUDIO IN 2") you want to transfer, then press ENTER.

3 For Synchronized Transfer:

When playback is stopped, press PLAY MODE on the remote control repeatedly to select the play mode you want.

Notes

- If you start transferring in [FOLDER (SHUFFLE)], the selected play mode changes to [FOLDER] automatically.
- If you start transferring in Shuffle Play (except [FOLDER (SHUFFLE)]), Repeat Play or Program Play with no steps, the selected play mode changes to Normal Play automatically.

For REC1 Transfer:

Select the track or audio file you want to transfer, then start playback.

4 Press REC TO USB.

"PUSH ENTER" appears in the display panel.

5 For Synchronized Transfer and REC1 Transfer:

Press ENTER.

The transfer starts when "DO NOT REMOVE" appears in the display panel.

For Analog Transfer:

Press ENTER and start playing the source.

The transfer starts when "DO NOT REMOVE" appears in the display panel.

When the transfer is completed

The disc or the USB device stops automatically (for Synchronized Transfer) or continues to play (for REC1 Transfer).

To stop transfer

Press ■.

To create a new MP3 file (for Analog Transfer only)

Press REC TO USB during Analog Transfer.

"NEW TRACK" appears in the display panel.

A new MP3 file is also created automatically after approximately 1 hour of transfer.

Notes

- When a new MP3 file is created, transfer is disabled for the time being.
- If you press REC TO USB again after a few seconds, a new MP3 file can be created.

Notes on transfer

- While transferring (except Analog Transfer), no sound is output.
- CD-TEXT information is not transferred in the created MP3 files.
- The transfer stops automatically if:
 - the USB device runs out of space during transfer.
 - the number of audio files or folders on the USB device reaches the limit.

- If a folder or file that you are trying to transfer already exists on the USB device with the same name, a sequential number is added after the name without overwriting the original folder or file.
- You cannot perform the following operations during a transfer:
 - Eject the disc.
 - Select another track or file.
 - Pause playback or find a point in the track or file.
 - Change the function or tuner band.
- When transferring music to a Walkman® using "Media Manager for WALKMAN", be sure to transfer in MP3 format.
- When connecting a Walkman® to the system, be sure to connect after the display "Creating Library" or "Creating Database" on the Walkman® has disappeared.

Folder and file generation rules

Maximum number of MP3 files that can be generated

- 298 folders
- 650 files in a folder
- 650 files in REC1-CD or REC1-MP3 folder.

These numbers may vary depending on the file or folder configuration. When transferring onto a USB device, a "MUSIC" folder is created directly below "ROOT". Folders and files are generated within this "MUSIC" folder according to the transferring method and source.

Synchronized Transfer

Source	Folder name	File name
Audio files	Same as the source	
AUDIO CD	"CDDA0001"*	"TRACK001"*

REC1 Transfer

Source	Folder name	File name
Audio files	"REC1-MP3"	Same as the source
AUDIO CD	"REC1-CD"	"TRACK001"*

Analog Transfer

Source	Folder name	File name
FM	"TUFM0001"*	"TRACK001"*
AM	"TUAM0001"*	
AUDIO IN 1/ AUDIO IN 2	"EXAU0001"*	

* Folder and file numbers are assigned serially thereafter.

Erasing audio files or folders on the USB device

- 1 Press FUNCTION +/- repeatedly to select "USB 1" or "USB 2".**
- 2 Press MEDIA MODE repeatedly to select [MUSIC].**
- 3 When playback is stopped, press OPTIONS.**
- 4 Press \uparrow/\downarrow repeatedly to select "ERASE", then press $\boxed{+}$.**
The Folder List is displayed on the TV screen.
- 5 Press \uparrow/\downarrow repeatedly to select a folder, then press $\boxed{+}$.**
- 6 Press \uparrow/\downarrow repeatedly to select the audio file you want to erase, then press $\boxed{+}$.**
Select [ALL TRACKS] to select all audio files in the folder.
"FLDR ERASE" or "TRK ERASE" and "PUSH ENTER" appears in the display panel.
To cancel, press \blacksquare .
- 7 Press $\boxed{+}$.**
"COMPLETE" appears in the display panel.
To exit OPTIONS menu, press OPTIONS.

Notes

- A folder that contains non-MP3/WMA/AAC format audio files or sub folders cannot be erased.
- You cannot erase audio files or folders when Shuffle Play or Program Play has been selected. Set the play mode to Normal Play before erasing.
- Erase operation is prohibited when the disc tray is opened.

Tuner

Listening to the radio

- 1 Press FUNCTION +/- repeatedly to select "TUNER FM" or "TUNER AM".**

You can also use the buttons on the unit. Press FUNCTION, then turn the VOLUME/MULTI CONTROL knob to select "TUNER FM" or "TUNER AM", then press ENTER.

- 2 Select the radio station.
For automatic tuning:**

Hold down TUNING+/- until the frequency indication changes and then release.

Scanning stops automatically when a station is tuned in. "TUNED" and "STEREO" (for FM stereo programs only) light up in the display panel. If "TUNED" does not light up and scanning does not stop, press ■ to stop scanning. Then, perform manual tuning (below).

For manual tuning:

Press TUNING+/- repeatedly to tune to the station you want.

Note

When you tune to an FM station that provides RDS services, information such as the service name or station name is provided by broadcasts. You can check the RDS information by pressing DISPLAY repeatedly.

Tip

To reduce static noise on a weak FM stereo station, press FM MODE repeatedly until "MONO" lights up in the display panel.

To change the AM tuning interval (Except for European and Russian models)

The default setting for AM tuning interval is 9 kHz (or 10 kHz for some areas). You cannot change the AM tuning interval in Power Saving Mode. Use the buttons on the unit to perform this operation.

- 1 Press FUNCTION, then turn the VOLUME/MULTI CONTROL knob to select "TUNER AM", then press ENTER.
- 2 Press I/⏻ to turn off the system.
- 3 While holding down ENTER, press DJ OFF.
"9K STEP" or "10K STEP" appears in the display panel.
When you change the interval, all the AM preset stations are erased.

Presetting radio stations

You can store up to 20 FM and 10 AM stations as your favorite stations.

- 1 Tune to the station you want.
- 2 Press DVD/TUNER MENU.
- 3 Press ⬆ / ⬇ repeatedly to select the preset number you want, then press [+].
"COMPLETE" appears in the display panel. The station is stored.

To tune to a preset station

Press PRESET+/- repeatedly to select the preset number you want.

You can also hold down SHIFT, then press the numeric buttons, and then press [+] to select a preset station.

BLUETOOTH

About the BLUETOOTH wireless technology

BLUETOOTH wireless technology is a short-range wireless technology that enables wireless data communication between digital devices. BLUETOOTH wireless technology operates within a range of about 10 meters.

Supported BLUETOOTH version, profiles and codecs

For details, see "BLUETOOTH section" (page 56).

Compatible BLUETOOTH devices

For details, see "Websites for compatible devices" (page 10).

About the BLUETOOTH indicator

The BLUETOOTH indicator on the unit lights up or flashes in blue to show the BLUETOOTH status.

System status	Indicator status
BLUETOOTH standby	Flashes slowly
BLUETOOTH pairing	Flashes quickly
BLUETOOTH connection is established	Lights up

Pairing this system with a BLUETOOTH device

Pairing is an operation where BLUETOOTH devices register with each other beforehand. Once a pairing operation is performed, it does not need to be performed again.

- 1 Place the BLUETOOTH device within 1 meter from the system.

2 Press **BLUETOOTH** on the unit to select **BLUETOOTH** function.

“BLUETOOTH” appears in the display panel.

Note

If the system is connected to a BLUETOOTH device, press BLUETOOTH on the unit to disconnect the BLUETOOTH device.

3 Hold down **PAIRING** on the unit for 2 seconds or more.

“PAIRING” flashes in the display panel.

4 Perform the pairing procedure on the **BLUETOOTH** device.

For details, refer to the operating instructions of your BLUETOOTH device.

5 Select the system’s name (for example, “SHAKE-X7D”) on the device’s display.

Perform this step within 5 minutes, otherwise pairing will be canceled. In this case, repeat from step 1.

Note

If passkey is required on the BLUETOOTH device, enter “0000”. “Passkey” may be called “Passcode”, “PIN code”, “PIN number”, or “Password”.

6 Perform the **BLUETOOTH** connection on the **BLUETOOTH** device.

The BLUETOOTH device name appears in the display panel. Depending on the BLUETOOTH device, connection may start automatically after pairing is completed.

You can check the BLUETOOTH device address by pressing DISPLAY repeatedly.

Notes

- You can pair up to 9 BLUETOOTH devices. If the 10th BLUETOOTH device is paired, the oldest paired device will be deleted.
- If you want to pair with another BLUETOOTH device, repeat steps 1 to 6.

To cancel pairing operation

Hold down PAIRING on the unit for 2 seconds or more until “BLUETOOTH” appears in the display panel.

Playing music from a BLUETOOTH device

You can operate a BLUETOOTH device by connecting the system and the BLUETOOTH device using AVRCP. Once the system and BLUETOOTH device is connected, you can control playback by pressing **▶**, **||**, **■**, **◀◀/▶▶** and **I◀◀/▶▶I**.

Check the following before playing music:

- The BLUETOOTH function of the BLUETOOTH device is turned on.
- The pairing has been completed (page 34).

1 Press **BLUETOOTH** on the unit to select **BLUETOOTH** function.

“BLUETOOTH” appears in the display panel.

2 Establish connection with the **BLUETOOTH** device.

Press BLUETOOTH on the unit to connect to the last connected BLUETOOTH device.

Perform the BLUETOOTH connection from the BLUETOOTH device if the device is not connected.

Once the connection is established, the BLUETOOTH device name appears in the display panel.

3 Press ► to start playback.

Depending on the BLUETOOTH device,
– you may have to press ► twice.
– you may need to start playing an audio source on the BLUETOOTH device.

4 Adjust the volume.

Adjust the volume of the BLUETOOTH device first, if the volume level is still too low, adjust the volume level on the system.

Notes

- When the system is not connected to any BLUETOOTH device, the system will connect to the last connected BLUETOOTH device automatically when you press BLUETOOTH on the unit or ►.
- If you try to connect another BLUETOOTH device to the system, the current connected BLUETOOTH device will be disconnected.

To disconnect the BLUETOOTH device

Press BLUETOOTH on the unit. “BLUETOOTH” appears in the display panel.

Depending on the BLUETOOTH device, the BLUETOOTH connection may be canceled automatically when you stop playback.

To delete pairing information

Use the buttons on the unit to perform this operation.

1 Press BLUETOOTH to select BLUETOOTH function.

“BLUETOOTH” appears in the display panel.

If the system is connected to a BLUETOOTH device, the BLUETOOTH device name appears in the display panel. Press BLUETOOTH to disconnect the BLUETOOTH device.

2 Hold down DJ OFF and – for about 3 seconds.

“BT HISTORY CLEAR” appears in the display panel and all the pairing information is erased.

One Touch BLUETOOTH Connection by NFC

NFC (Near Field Communication) is a technology enabling short-range wireless communication between various devices, such as smartphones and IC tags.

When you touch the system with an NFC-compatible smartphone, the system automatically:

- turns on in BLUETOOTH function.
- completes the pairing and BLUETOOTH connection.

Compatible smartphones

Smartphones with a built-in NFC function (OS: Android 2.3.3 or later, excluding Android 3.x)

Notes

- The system only can recognize and connects to one NFC-compatible smartphone at a time. If you try to connect another NFC-compatible smartphone to the system, the current connected NFC-compatible smartphone will be disconnected.
- Depending on your NFC-compatible smartphone, you may need to perform the following items on your NFC-compatible smartphone in advance.
 - Turn on the NFC function. For details, refer to the operating instructions of the NFC-compatible smartphone.

- If your NFC-compatible smartphone is having an older OS version than Android 4.1.x, download and start the "NFC Easy Connect" application. "NFC Easy Connect" is a free application for Android smartphone that can be obtained from Google Play. (The application may not be available in some countries/regions.)

1 Touch the smartphone to the N-Mark on the unit until the smartphone vibrates.

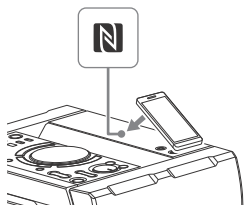

Complete the connection by following the instructions displayed on the smartphone.

When the BLUETOOTH connection is established, the BLUETOOTH device name appears in the display panel.

2 Start playback of an audio source on the smartphone.

For details, refer to the operating instructions of your BLUETOOTH device.

Tip

If pairing and the BLUETOOTH connection fail, do the following.

- Remove the case from the smartphone if using a commercially available smartphone case.
- Touch the smartphone to the N-Mark on the unit again.
- Relaunch "NFC Easy Connect" application.

To disconnect the smartphone

Touch the smartphone to the N-Mark on the unit again.

Setting the BLUETOOTH audio codecs

You can receive data in AAC or SBC codec format from a BLUETOOTH device.

- 1 Press **OPTIONS**.
- 2 Press **↑/↓** repeatedly to select "BT AAC", then press **[+]**.
- 3 Press **↑/↓** repeatedly to select the setting.
 - ON: Enable reception in AAC codec format.
 - OFF: Receive in SBC codec format.To exit the options menu, press **OPTIONS**.

Notes

- You can enjoy high quality sound if the AAC is selected. In case you cannot listen to AAC sound from your device or the sound is interrupted, select "OFF".
- If you change this setting when the system is connected to a BLUETOOTH device, the BLUETOOTH device will be disconnected. To connect to the BLUETOOTH device, perform the BLUETOOTH connection again.

Setting the BLUETOOTH standby mode

The BLUETOOTH standby mode enables the system to turn on automatically when you establish the BLUETOOTH connection from a BLUETOOTH device.

- 1 Press **OPTIONS**.
- 2 Press **↑/↓** repeatedly to select "BT STBY", then press **[+]**.

3 Press \uparrow / \downarrow repeatedly to select the setting.

- ON: The system turns on automatically when you establish a BLUETOOTH connection from a BLUETOOTH device.
 - OFF: Turns off this function.
- To exit the options menu, press **OPTIONS**.

Setting the BLUETOOTH signal

You can connect to the system from a paired BLUETOOTH device in all functions when BLUETOOTH signal is set to on. The BLUETOOTH signal is turned on by default.

Use the buttons on the unit to perform this operation.

Hold down DJ OFF and \square + for about 3 seconds.

"BT ON" or "BT OFF" appears in the display panel.

Notes

- You cannot perform the following operations when BLUETOOTH signal is set to off:
 - Pairing and/or connecting with BLUETOOTH device
 - Erasing the pairing information
 - Using "SongPal" via BLUETOOTH
 - Change the BLUETOOTH audio codecs
- If you touch the system with an NFC-compatible smartphone or set the BLUETOOTH standby mode to on, the BLUETOOTH signals will set to on automatically.

Using "SongPal" via BLUETOOTH

About App

A dedicated App for this model is available on both Google Play and App Store. Search for "SongPal" or scan the QR code below then download the free App to find out more about the convenient features.



BLUETOOTH technology works with iPhone 6 Plus, iPhone 6, iPhone 5s, iPhone 5c, iPhone 5, iPhone 4s, iPhone 4, iPhone 3GS, iPod touch (5th generation), iPod touch (4th generation).

Note

If "SongPal" application does not work properly, disconnect and connect the BLUETOOTH device by pressing BLUETOOTH on the unit (page 35).

Adjusting the sound

To	Do this
Reinforce the bass and create a more powerful sound	Press MEGA BASS on the unit.
Reduce the bass sound (BASS CUT)	Hold down MEGA BASS on the unit for 2 seconds or more. To cancel the BASS CUT effect, press MEGA BASS on the unit again.
	Notes <ul style="list-style-type: none">• The MEGA BASS indicator on the unit flashes when BASS CUT effect is turned on.• The BASS CUT effect is turned off automatically when you turn off the system or activate the Football mode (page 39).
Select a preset sound effect	Press MUSIC or VIDEO. You can also use the buttons on the unit. Press SOUND FIELD, then turn the VOLUME/MULTI CONTROL knob to select the sound effect you want, then press ENTER. To cancel preset sound effect, press MUSIC repeatedly to select "FLAT". You can also use the buttons on the unit to select "FLAT".

Selecting the Virtual Football mode

You can experience a feeling of presence in the stadium when watching the football match broadcast.

Press FOOTBALL repeatedly while watching a football match broadcast.

- **ON NARRATION:** You can enjoy an immersive feeling of being in a football stadium through enhanced stadium cheers.
- **OFF NARRATION:** You can enjoy a more immersive feeling of being in a football stadium by minimizing the volume level of narration in addition to the enhancement of cheers.

To cancel the Virtual Football mode

Press MUSIC repeatedly to select "FLAT".

Notes

- We recommend you to select the football mode when watching a football match broadcast.
- If you hear unnatural sound in the content when "OFF NARRATION" is selected, "ON NARRATION" is recommended.
- This feature does not support monaural sound.
- You can only select the Virtual Football mode during AUDIO IN 1 or AUDIO IN 2 function.

Creating your own sound effect

You can raise or lower the levels of specific frequency bands, then store the setting in the memory as "CUSTOM EQ".

- 1 Press **OPTIONS**.
- 2 Press \uparrow / \downarrow repeatedly to select "EQ EDIT", then press $\boxed{+}$.
- 3 Press \uparrow / \downarrow repeatedly to adjust the equalizer level, then press $\boxed{+}$.
- 4 Repeat step 3 to adjust the level of other frequency bands and surround effect.

To exit the options menu, press **OPTIONS**.

To select the custom equalizer setting

Press **MUSIC** repeatedly to select "CUSTOM EQ".

Creating a party atmosphere

(DJ EFFECT)

Use the buttons on the unit to perform this operation.

- 1 Press the following button to select the effect type.
 - **FLANGER**: Creates a deep flanging effect that is similar to the roar of a jet plane.
 - **ISOLATOR**: Isolates a specific frequency band by adjusting the other frequency bands. For example, when you want to focus on vocals.

- **SAMPLER**: Provides a series of special sound effects.

2 (For **SAMPLER** only)
Press **SAMPLER** repeatedly to select **SAMPLER** mode.

3 (For **SAMPLER** only)
Press **S1/S2/S3/S4** to output the **SAMPLER** sound effect. To output other **SAMPLER** sound effect continuously, turn the **VOLUME/MULTI CONTROL** knob.

(For **FLANGER** and **ISOLATOR** only)
Turn the **VOLUME/MULTI CONTROL** knob to adjust the effect level.

To turn off the effect

- Press **DJ OFF**.
- Press the selected effect button again (for **FLANGER** and **ISOLATOR** only).

Notes

- The **DJ EFFECT** is automatically turned off when you:
 - turn off the system
 - change the function
 - change the tuner band
 - activate or deactivate the **PARTY CHAIN** function
 - activate the **Football** mode
- If you activate the **DJ EFFECT** during transferring, the sound effect will not be transferred onto the USB device.
- You cannot use **VOLUME/MULTI CONTROL** on the unit to adjust the volume when the **DJ EFFECT** is activated. Press \triangleleft \pm on the remote control to adjust the volume.

Other Operations

Using the Party Chain function

You can connect multiple audio systems in a chain to create a more interesting party environment and to produce higher sound output. Activate a system in the chain to be the "Party Host" and share the music. Other systems will become "Party Guest" and play the same music as the "Party Host".

Setting up the Party Chain

Set up a Party Chain by connecting all the systems using audio cords (not supplied).

Before connecting cords, be sure to disconnect the AC power cord (mains lead).

A If all the systems are equipped with Party Chain function

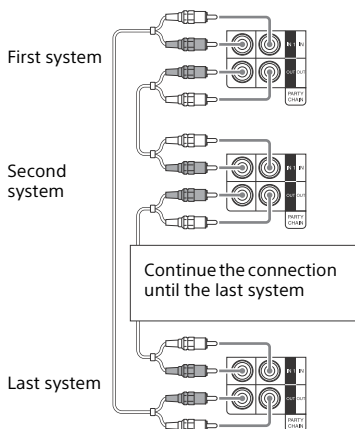

- The last system must be connected to the first system.
- Any system can become a Party Host.
- You can select a new Party Host when Party Chain function is activated. For details, see "To select a new Party Host" (page 42).

B If one of the system is not equipped with Party Chain function

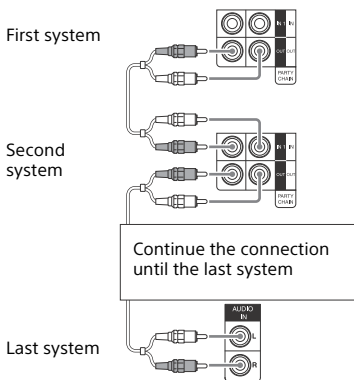

- The last system is not connected to the first system.
- Connect the system which is not equipped with Party Chain function at the last system. Be sure to select the audio in function on the last system.
- You must select the first system as Party Host so that all systems are playing the same music when Party Chain function is activated.

Enjoying the Party Chain

Use the buttons on the unit to perform this operation.

- 1 Plug in the AC power cord (mains lead) and turn on all the systems.

2 Adjust the volume on each system.

3 Activate the Party Chain function on the system which you want it to be the Party Host.

Press FUNCTION, then turn the VOLUME/MULTI CONTROL knob to select the function you want (except AUDIO IN 1 in connection **A** (page 41)), then press ENTER. Start playback the music, then press PARTY CHAIN.

"PARTY CHAIN" appears in the display panel. The system starts the party as Party Host and other systems will become Party Guest automatically. All systems play the same music as the Party Host.

Notes

- Depending on the total unit of systems you have connected, Party Guest may take some time to start playing the music.
- Changing the volume level and sound effect on the Party Host will not affect the output on the Party Guest.
- The Party Guest continues playing the music source as Party Host even when you change the function on Party Guest. However, you can adjust the volume and change the sound effect on Party Guest.
- When you use the microphone on Party Host, the sound will not be output from Party Guest.
- When one of the system in the connection is performing USB transfer, wait the system to complete or stop the transfer before you activate the Party Chain function.
- For detailed operation on other systems, refer to the operating instructions of the systems.

To select a new Party Host

Repeat step 3 of "Enjoying the Party Chain" on the system which you want it to be a new Party Host.

The current Party Host will become Party Guest automatically. All systems play the same music as the new Party Host.

Notes

- You can only select another system as the new Party Host after all the systems have completed the Party Chain function.
- Repeat the step above if the selected system does not change as a new Party Host after a few seconds.

To deactivate the Party Chain

On the Party Host, press PARTY CHAIN.

Note

Repeat the step above if the system does not deactivate the Party Chain after a few seconds.

Singing along: Karaoke

Preparing for karaoke

1 Turn MIC LEVEL on the unit to MIN to reduce the microphone volume level.

2 Connect an optional microphone to MIC 1 or MIC 2 jack on the unit. Connect another optional microphone if you want to sing in duet.

3 Start playing the music and adjust the microphone volume. Press MIC ECHO repeatedly to adjust the echo effect.

4 Start singing along with the music.

Notes

- Karaoke Mode is turned on when the microphone is connected during DVD/CD, USB 1, or USB 2 function.

- If howling occurs:
 - move the microphone away from the speakers.
 - change the direction of the microphone.
 - lower the MIC LEVEL.
 - press \triangleleft – to reduce the volume level or press MIC ECHO repeatedly to adjust the echo level.
- The sound from the microphone will not be transferred to the USB device during USB transfer.

Using Vocal Fader

You can reduce the sound of the vocal in stereo source.

Press **VOCAL FADER** repeatedly to select **"V. FADER ON"**.

To cancel Vocal Fader effect, press **VOCAL FADER** repeatedly to select **"V. FADER OFF"**.

Note

To use the Vocal Fader during DVD/CD, USB 1, or USB 2 function, be sure to turn on the Karaoke Mode by connecting the microphone.

Changing the key (Key Control)

Press **KEY CONTROL** \flat/\sharp to suit your vocal range in Karaoke Mode.

Selecting the scoring mode (Score Mode)

When Karaoke Mode is turned on, you can use the scoring mode. Your score is calculated from a scale of 0 to 99 by comparing your voice with the music source.

- 1 Start playing the music.
- 2 Press **SCORE** before singing a song in Karaoke Mode.
- 3 After singing for more than a minute, press **SCORE** again to view your score.

To select the rating of the Score Mode

See [SCORE MODE] in "Setting the audio options – [AUDIO SETUP]" (page 29).

Enjoying the Speaker Light

Press **LIGHT MODE** repeatedly to change the illumination color on the speakers.

To turn off the illumination, press **SPEAKER LIGHT** on the unit repeatedly or **PARTY LIGHT** on the remote control repeatedly to select **"LED OFF"**.

Note

If the illumination brightness is glaring, switch on the room lights or turn off the illumination.

Using the timers

The system offers three timer functions. You cannot activate both the Play Timer and the Recording Timer at the same time. If you use either with the Sleep Timer, the Sleep Timer has priority.

Sleep Timer

The system turns off automatically after the preset time.

Press **SLEEP** repeatedly.

To cancel Sleep Timer, press **SLEEP** repeatedly to select **"OFF"**.

Tip

To check the remaining time before the system turns off, press **SLEEP**.

Play Timer/Recording Timer

Make sure you have set the clock (page 18).

Play Timer:

You can set the system to turn on and play a disc, USB device, or radio station automatically at the preset time.

Recording Timer:

You can transfer music from a preset radio station to a USB device at a specified time.

1 For Play Timer:

Prepare the sound source, then press \triangleleft +/- to adjust the volume. To start from a specific track or file, create your own program (page 24).

For Recording Timer:

Tune to the preset radio station (page 34).

2 Hold down SHIFT, then press TIMER MENU.

3 Press \uparrow / \downarrow repeatedly to select "PLAY SET" or "REC SET", then press $\boxed{+}$.

4 Set the time to start playback or transfer.

Press \uparrow / \downarrow repeatedly to set the hour/minute, then press $\boxed{+}$.

5 Use the same procedure as in step 4 to set the time to stop playback or transfer.

6 Press \uparrow / \downarrow repeatedly to select the sound source you want, then press $\boxed{+}$.

For Recording Timer:

Connect a transferable USB device to the ψ (USB) 2 port.

7 Press I/ \odot to turn off the system.

To check the timer setting or activate the timer again

1 Hold down SHIFT, then press TIMER MENU.

"TIMER SEL" flashes in the display panel.

2 Press $\boxed{+}$.

3 Press \uparrow / \downarrow repeatedly to select "PLAY SEL" or "REC SEL", then press $\boxed{+}$.

To cancel the timer

Repeat the same procedure as above and select "TIMER OFF" in step 3, then press $\boxed{+}$.

Notes

- The system turns on before the preset time. If the system is turned on at the preset time or if "STANDBY" flashes in the display panel, the Play Timer and the Recording Timer will not play or transfer.
- Do not operate the system from the time the system turns on until the playback or transfer starts.

Using optional equipment

1 Press \triangleleft - repeatedly until "VOLUME MIN" appears in the display panel.

2 Connect an optional equipment (page 15).

3 Press FUNCTION +/- repeatedly to select the function which corresponds to the connected equipment.

4 Start playing the connected equipment.

5 Press \triangleleft + repeatedly to adjust the volume.

Note

The system may enter standby mode automatically if the volume level of the connected equipment is too low. Adjust the volume level of the equipment. To turn off automatic standby function, see "Setting the automatic standby function" (page 45).

Deactivating the buttons on the unit

(Child Lock)

You can deactivate the buttons on the unit (except I/⏻) to prevent misoperation, such as child mischief.

Hold down ■ on the unit for more than 5 seconds.

"CHILD LOCK ON" appears in the display panel.

You can only operate the system using the buttons on the remote control.

To cancel, hold down ■ on the unit for more than 5 seconds until "CHILD LOCK OFF" appears in the display panel.

Notes

- Child Lock function will be canceled when you disconnect the AC power cord (mains lead).
- Child Lock function cannot be activated when you open the disc tray.

Setting the automatic standby function

The system enters standby mode automatically in about 15 minutes when there is no operation or audio signal output.

By default, the automatic standby function is turned on.

1 Press **OPTIONS**.

2 Press \uparrow / \downarrow repeatedly to select "AUTO STBY", then press \square .

3 Press \uparrow / \downarrow repeatedly to select "ON" or "OFF".

To exit the options menu, press **OPTIONS**.

Notes

- "AUTO STBY" flashes in the display panel about 2 minutes before entering standby mode.
- The automatic standby function does not work in the following cases:
 - during tuner function.
 - when the timer is activated.
 - when microphone is connected.

Updating the software

The software of this system may be updated in the future. You can update the software from the websites below.

For customers in Latin America:

<<http://esupport.sony.com/LA>>

For customers in Europe and Russia:

<<http://www.sony.eu/support>>

For customers in other countries/
regions:

<<http://www.sony-asia.com/support>>

Follow the online instructions to update the software.

Troubleshooting

Should you encounter a problem with your system, find your problem in the troubleshooting checklist below and take the corrective action.

If the problem persists, consult your nearest Sony dealer.

Note that if the service personnel changes some parts during repair, these parts may be retained.

If "PROTECT XX" (X is a number) appears in the display panel

Immediately unplug the AC power cord (mains lead), and check the following items.

- Are you using only the supplied speakers?
- Is anything blocking the ventilation holes of the unit?

After checking the above items and fixing any problems, plug in the AC power cord (mains lead) again and turn on the system. If the issue persists, consult your nearest Sony dealer.

General

The power does not turn on.

- Check that the AC power cord (mains lead) is connected securely.

The system has entered standby mode.

- This is not a malfunction. The system enters standby mode automatically in about 15 minutes when there is no operation or audio signal output (page 45).

The clock or timer setting is canceled.

- The AC power cord (mains lead) is disconnected or a power failure occurred. Set the clock (page 18) and timer (page 43) again.

There is no sound.

- Adjust the volume.
- Check the speaker connections (page 16).
- Check the connection of the optional equipment, if any (page 15).
- Turn on the connected equipment.
- There is no audio output during Recording Timer.
- Unplug the AC power cord (mains lead), then plug in the AC power cord (mains lead) again and turn on the system.

There is no microphone sound.

- Adjust the microphone volume.
- Make sure the microphone is connected to the MIC 1 or MIC 2 jack on the unit correctly.
- Make sure the microphone is turned on.

There is severe hum or noise.

- Move the system away from sources of noise.
- Connect the system to a different wall outlet.
- Install a noise filter (commercially available) to the AC power cord (mains lead).
- Turn off surrounding electrical equipment.
- You can hear a noise from cooling fans when the system is in standby mode or playback at low volume. This is not a malfunction.

The timer does not function.

- Check the timer setting and set the correct time (page 43).
- Cancel the Sleep Timer function (page 43).

The remote control does not function.

- Remove the obstacles between the remote control and the unit.
- Move the remote control closer to the unit.
- Point the remote control at the unit's sensor.
- Replace the batteries (R03/size AAA).
- Move the unit away from the fluorescent light.

There is acoustic feedback.

- Reduce the volume.
- Move the microphone away from the speakers or change the direction of the microphone.

The color irregularity on a TV screen persists.

- Turn off the TV at once, then turn it on after 15 to 30 minutes. If the color irregularity still persists, place the speakers farther away from the TV.

"PLEASE CONNECT ALL SPK" appears.

- Check that all speakers are connected.

"CHILD LOCK" appears when you press any button on the unit.

- Set the Child Lock function to off (page 45).

Speakers

Sound comes from only one channel or the left and right volume is unbalanced.

- Place the speakers as symmetrically as possible.
- Check that the speakers are connected securely and correctly.
- The source being played back is monaural.

There is no sound from a specific speaker.

- Check that the speaker is connected securely and correctly.

Disc player

The disc tray does not open and "LOCKED" appears in the display panel.

- Consult your nearest Sony dealer or local authorized Sony service facility.

The disc tray does not close.

- Load the disc correctly.

The disc does not eject.

- You cannot eject the disc during CD-USB Synchronized Transfer or REC1 Transfer. Press ■ to cancel the transfer, then press ▲ on the unit to eject the disc.
- Consult your nearest Sony dealer.

Playback does not start.

- Wipe the disc clean (page 53).
- Reload the disc.
- Load a disc that this system can play back (page 8).
- Remove the disc and wipe away the moisture on the disc, then leave the system turned on for a few hours until the moisture evaporates.
- The region code on the DVD VIDEO does not match the system.

The sound skips.

- Wipe the disc clean (page 53).
- Reload the disc.
- Move the unit to a place with no vibration.
- Move the speakers away from the unit. When you listen to a track with bass sounds at high volume, the speaker vibration may cause the sound to skip.

Playback does not start from the first track.

- Set the play mode to Normal Play (page 23).
- Resume Play has been selected. Press ■ twice. Then, press ► to start playback.

You cannot perform some functions such as Stop, Lock Search, Slow-motion Play, Repeat Play, Shuffle Play, or Program Play.

- Depending on the disc, you may not be able to do some of the operations above. Refer to the operating instructions supplied with the disc.

The DATA CD/DATA DVD (MP3, JPEG or Xvid) cannot be played back.

- The data is not stored in the supported format.
- Make sure you have selected the correct Media Mode before playback.

The folder name, track name, file name and ID3 tag characters do not appear properly.

- The ID3 tag is not Version 1 (1.0/1.1) or Version 2 (2.2/2.3).
- The character codes that can be displayed by this system are as follows:
 - Upper cases (A to Z)
 - Numbers (0 to 9)
 - Symbols (< > * +, [] \ _)Other characters appear as “_”.

The sound loses stereo effect when you play back an AUDIO CD, VIDEO CD, audio file, video file, or DVD VIDEO.

- Unplug all the microphones. “” disappears from the display panel.
- Make sure the system is connected properly.
- Check the speaker connections (page 16).

USB device

Transferring results in an error.

- You are using an unsupported USB device. Check the information on the website about compatible USB devices (page 10).
- The USB device is not formatted correctly. Refer to the operating instructions of the USB device on how to format.

- Turn off the system and remove the USB device. If the USB device has a power switch, turn the USB device off and on again after removing it from the system. Then perform the transfer again.
- If the transfer and erase operations are repeated multiple times, the file structure within the USB device becomes fragmented. Refer to the operating instructions of the USB device on how to deal with this problem.
- The USB device was disconnected or the power was turned off during transfer. Delete the partially-transferred file, and perform the transfer again. If this does not fix the problem, the USB device may be broken. Refer to the operating instructions of the USB device on how to deal with this problem.

Audio files or folders on the USB device cannot be erased.

- Check if the USB device is write-protected.
- The USB device was disconnected or the power was turned off during the erase operation. Delete the partially-erased file. If this does not fix the problem, the USB device may be broken. Refer to the operating instructions of the USB device on how to deal with this problem.

There is no sound.

- The USB device is not connected correctly. Turn off the system and reconnect the USB device, then turn on the system and check if “USB 1” or “USB 2” appears in the display panel.

There is noise, skipping, or distorted sound.

- You are using an unsupported USB device. Check the information on the website about compatible USB devices (page 10).

- Turn off the system and reconnect the USB device, then turn on the system.
- The music data itself contains noise, or the sound is distorted. Noise may have entered during the transferring process. Delete the file, and try transferring again.
- The bit rate used when encoding audio files was low. Send audio files with higher bit rate to the USB device.

“READING” is displayed for an extended time, or it takes a long time before playback starts.

- The reading process can take a long time in the following cases.
 - There are many folders or files on the USB device (page 10).
 - The file structure is extremely complex.
 - The memory capacity is excessive.
 - The internal memory is fragmented.

“NO FILE” appears in the display panel.

- The system has entered the software update mode, all buttons (except I/⏻) are deactivated. Press I/⏻ on the unit to cancel the software update.

“OVER CURRENT” appears in the display panel.

- A problem has been detected with the level of electrical current from the ⏻ (USB) 1 port or ⏻ (USB) 2 port. Turn off the system and remove the USB device from the port. Make sure there is no problem with the USB device. If this display pattern persists, contact your nearest Sony dealer.

Erroneous display.

- The data stored in the USB device may have been corrupted, perform the transfer again.
- The character codes that can be displayed by this system are as follows:

- Upper cases (A to Z)
 - Numbers (0 to 9)
 - Symbols (< > * +, [] \ _)
- Other characters appear as “_”.

The USB device is not recognized.

- Turn off the system and reconnect the USB device, then turn on the system.
- Check the information on the website about compatible USB devices (page 10).
- The USB device does not work properly. Refer to the operating instructions of the USB device on how to deal with this problem.

Playback does not start.

- Turn off the system and reconnect the USB device, then turn on the system.
- Check the information on the website about compatible USB devices (page 10).

Playback does not start from the first file.

- Set the play mode to Normal Play (page 23).

Files cannot be played back.

- Make sure you have selected the correct Media Mode before playback.
- USB devices formatted with file systems other than FAT16 or FAT32 are unsupported.*
- If you use a partitioned USB device, only files on the first partition can be played back.

* This system supports FAT16 and FAT32, but some USB devices may not support all of these FAT. For details, refer the operating instructions of each USB device or contact the manufacturer.

Picture

There is no picture.

- Check that the system is connected securely.
- If the video cord is damaged, replace it with a new one.

- Make sure you connect the unit to the video input jack of your TV (page 16).
- Make sure you turn on the TV and operate the TV correctly.
- Make sure you select the video input on the TV so that you can view the pictures from the system.
- (Except for Latin American, European, and Russian models) Make sure you set the color system correctly, according to your TV's color system.

Picture noise appears.

- Wipe the disc clean (page 53).
- If video signal from your system has to go through your VCR to your TV, the copy-protection applied to some DVD VIDEO programs could affect the picture quality.
- (Except for Latin American, European, and Russian models) When you play back a VIDEO CD recorded in a different color system from the one you set to the system, the picture image may be distorted (page 18, 28).
- (Except for Latin American, European, and Russian models) Set the color system to match your TV (page 18, 28).

The aspect ratio of the TV screen cannot be changed.

- The aspect ratio is fixed on your DVD VIDEO and video file.
- Depending on the TV, you may not change the aspect ratio.

The language for the sound track cannot be changed.

- Multilingual tracks are not recorded on the DVD VIDEO being played back.
- The DVD VIDEO prohibits changing the language for the sound track.

The subtitles language cannot be changed.

- Multilingual subtitles are not recorded on the DVD VIDEO being played back.
- The DVD VIDEO prohibits changing the subtitles.

The subtitles cannot be turned off.

- The DVD VIDEO prohibits turning off subtitles.

The angles cannot be changed.

- Multi-angles are not recorded on the DVD VIDEO being played back.
- The DVD VIDEO prohibits changing the angles.

Tuner

There is severe hum or noise, or stations cannot be received. ("TUNED" or "STEREO" flashes in the display panel.)

- Connect the antenna properly.
- Change antenna location and its orientation to obtain good reception.
- Consult your nearest Sony dealer if the supplied AM antenna has come off from the plastic stand.
- Turn off surrounding electrical equipment.

BLUETOOTH device

Pairing cannot be performed.

- Move the BLUETOOTH device closer to the system.
- Pairing may not be possible if other BLUETOOTH devices are present around the system. In this case, turn off the other BLUETOOTH devices.
- Make sure the correct passkey was entered at the BLUETOOTH device.

The BLUETOOTH device cannot detect the unit, or "BT OFF" appears in the display panel.

- Set the BLUETOOTH signal to "BT ON" (page 38).

Connection is not possible.

- The BLUETOOTH device you attempted to connect does not support the A2DP profile, and cannot be connected with the system.
- Enable the BLUETOOTH function of the BLUETOOTH device.
- Establish a connection from the BLUETOOTH device.
- The pairing registration information has been erased. Perform the pairing operation again.
- Erase the pairing registration information of the BLUETOOTH device (page 36) and perform the pairing operation again (page 34).

The sound skips or fluctuates, or the connection is lost.

- The system and the BLUETOOTH device are too far apart.
- If there are obstacles between the system and your BLUETOOTH device, remove or avoid the obstacles.
- If there is equipment that generates electromagnetic radiation, such as a wireless LAN, other BLUETOOTH device, or a microwave oven nearby, move them away.

The sound of your BLUETOOTH device cannot be heard on this system.

- Increase the volume on your BLUETOOTH device first, then adjust the volume using \triangle +/-.

There is severe hum, noise, or distorted sound.

- If there are obstacles between the system and your BLUETOOTH device, remove or avoid the obstacles.
- If there is equipment that generates electromagnetic radiation, such as a wireless LAN, other BLUETOOTH device, or a microwave oven nearby, move them away.
- Turn down the volume of the connected BLUETOOTH device.

The sound from "Voice Playback" in "Fiestable" application does not output.

- The built-in sound demonstration is activated, press \blacksquare to stop the demonstration. Then, perform the playback again.

Party Chain**Party Chain function cannot be activated.**

- Check the connections (page 41).
- Make sure the audio cords are connected correctly.

"PARTY CHAIN" is flashing in the display panel.

- You cannot select AUDIO IN 1 function if you make connection **A** (page 41) during Party Chain function. Use the buttons on the unit to select other function (page 42).
- Press PARTY CHAIN on the unit.
- Restart the system.

Party Chain function does not operate properly.

- Turn off the system. Then, turn on the system to activate the Party Chain function.

To reset the system

If the system still does not operate properly, reset the system to factory default settings.

Use the buttons on the unit to perform this operation.

- 1 Unplug and plug the AC power cord (mains lead) back in.
- 2 Press I/⏻ to turn on the system.
- 3 Hold down DJ OFF and TUNING + for about 3 seconds.
"RESET" appears in the display panel.
All user-configured settings, such as preset radio stations, timer, and the clock are reset to factory default setting.

Returning the "SETUP" settings to the default

You can return the "SETUP" settings (except for "PARENTAL CONTROL" settings) to the default settings.

- 1 Press SETUP.

- 2 Press \uparrow/\downarrow repeatedly to select [SYSTEM SETUP], then press $\boxed{+}$.
- 3 Press \uparrow/\downarrow repeatedly to select [RESET], then press $\boxed{+}$.
- 4 Press \leftarrow/\rightarrow repeatedly to select [YES], then press $\boxed{+}$.
It takes a few seconds to complete. Do not press I/power when resetting the system.

Self-diagnosis Function

When letters/numbers appear on the TV screen or in the display panel

The self-diagnosis function is activated to prevent the system from malfunctioning, a 5-character service number (e.g. C 13 50) with a combination of a letter and 4 digits appears. In this case, check the following table.

First 3 characters of the service number	Cause and corrective action
C 13	This disc is dirty. <ul style="list-style-type: none"> • Clean the disc with a soft cloth (page 53).
C 31	The disc is not inserted correctly. <ul style="list-style-type: none"> • Restart the system, then re-insert the disc correctly.
E XX (XX is a number)	To prevent a malfunction, the system has performed the self-diagnosis function. <ul style="list-style-type: none"> • Contact your nearest Sony dealer or local authorized Sony service facility and give the 5-character service number. Example: E 61 10

Messages

One of the following messages may appear or flash in the display panel during operation.

CANNOT PLAY

- A disc that cannot be played back was inserted.
- A DVD VIDEO with unsupported region code was inserted.

DATA ERROR

- The file does not conform to the required format.
- The file extensions does not match the file format.

DEVICE ERROR

The USB device could not be recognized or an unknown device is connected.

DEVICE FULL

The memory of the USB device is full.

ERASE ERROR

Erase of audio files or folders on the USB device failed.

FATAL ERROR

The USB device was removed during transfer or erase operation, and may have been damaged.

FOLDER FULL

You cannot transfer onto the USB device because the number of folder has reached its maximum.

GUEST

The system becomes a Party Guest when Party Chain function is activated.

HOST

The system becomes a Party Host when Party Chain function is activated.

NO DEVICE

No USB device is connected.

NO DISC

There is no disc on the disc tray.

NO MEMORY

The memory selected for playback or transfer has no memory media inserted in the USB device.

NO MUSIC

MP3/WMA/AAC data does not exist in MUSIC playback mode.

NO PHOTO

JPEG data does not exist in PHOTO playback mode.

NO STEP

All of the programmed steps have been erased.

NO VIDEO

MPEG4/Xvid data does not exist in VIDEO playback mode.

NOT IN USE

You tried to perform a specific operation under conditions where that operation is prohibited.

NOT SUPPORTED

An unsupported USB device is connected or the USB device is connected through a USB hub.

OVER CURRENT

An over current from the ψ (USB) port was detected.

PROTECTED

The USB device is write-protected.

PUSH STOP

You tried to perform an operation that can be performed only when the playback is stopped.

READING

The system is reading information of the disc or USB device. Some operations are not available.

REC ERROR

The transfer did not start, stopped partway, or otherwise could not be performed.

STEP FULL

You tried to program more than 25 steps.

TIME NG

The on time and off time of Play Timer or Recording Timer is the same.

TRACK FULL

You cannot transfer onto the USB device because the number of file has reached its maximum.

Precautions

When carrying the unit

Perform the following procedure to protect the disc mechanism.

Use the buttons on the unit to perform this operation.

- 1 Press I/⏻ to turn on the system.
- 2 Press FUNCTION, then turn the VOLUME/MULTI CONTROL knob to select "DVD/CD", then press ENTER.
- 3 Remove the disc.
Press \blacktriangle to open and close the disc tray.
Wait until "NO DISC" appears in the display panel.
- 4 Unplug the AC power cord (mains lead).

Notes on discs

- Before playing, wipe the disc with a cleaning cloth from the center outward to the edge.
- Do not clean discs with solvents, such as benzene, thinner, or commercially available cleaners or anti-static spray intended for vinyl LPs.
- Do not expose discs to direct sunlight or heat sources such as hot air ducts, nor leave it in a car parked in direct sunlight.

On safety

- Completely disconnect the AC power cord (mains lead) from the wall outlet (mains) if it is not going to be used for an extended period of time. When unplugging the unit, always grip the plug. Never pull the cord itself.
- Should any solid object or liquid get into the system, unplug the system, and have it checked by qualified personnel before operating it again.
- AC power cord (mains lead) must be changed only at the qualified service shop.

On placement

- Do not place the system in an inclined position or in locations that are extremely hot, cold, dusty, dirty, or humid or lacking adequate ventilation, or subject to vibration, direct sunlight or a bright light.
- Be careful when placing the unit or speakers on surfaces that have been specially treated (for example, wax, oil, polish) as staining or discoloration of the surface may result.
- If the system is brought directly from a cold to a warm location or is placed in a very damp room, moisture may condense on the lens inside the unit, and cause the system to malfunction. In this situation, remove the disc, and leave the system turned on for about an hour until the moisture evaporates.

On heat buildup

- Heat buildup on the unit during operation is normal and is not a cause for alarm.
- Do not touch the cabinet if it has been used continuously at a high volume because the cabinet may have become hot.
- Do not obstruct the ventilation holes.

On the speaker system

This speaker system is not magnetically shielded, and the picture on nearby TV sets may become magnetically distorted. In this situation, turn off the TV, wait 15 to 30 minutes, and turn it back on. If there is no improvement, move the speakers far away from the TV.

IMPORTANT NOTICE

Caution: If you leave a still video image or on-screen display image displayed on your TV for an extended period of time via this system, you risk permanent damage to your TV screen. Projection TVs are especially susceptible to this.

Cleaning the cabinet

Clean this system with a soft cloth slightly moistened with a mild detergent solution.

Do not use any type of abrasive pad, scouring powder, or solvent, such as thinner, benzene, or alcohol.

On BLUETOOTH communication

- BLUETOOTH devices should be used within approximately 10 meters (unobstructed distance) of each other. The effective communication range may become shorter under the following conditions:
 - When a person, metal object, wall or other obstruction is between the devices with a BLUETOOTH connection.
 - Locations where a wireless LAN is installed.
 - Around microwave ovens that are in use.
 - Locations where other electromagnetic waves are generated.
- BLUETOOTH devices and wireless LAN (IEEE 802.11b/g) equipment use the same frequency band (2.4 GHz). When using your BLUETOOTH device near a device with wireless LAN capability, electromagnetic interference may occur. This could result in lower data transfer rates, noise, or inability to connect. If this happens, try the following remedies:
 - Use this system at least 10 meters away from the wireless LAN equipment.
 - Turn off the power to the wireless LAN equipment when using your BLUETOOTH device within 10 meters.
 - Use this system and BLUETOOTH device as closer to each other as possible.

- The radio waves broadcast by this system may interfere with the operation of some medical devices. Since this interference may result in malfunction, always turn off the power on this system and BLUETOOTH device in the following locations:
 - In hospitals, on trains, in airplanes, at gas stations, and any place where flammable gases may be present.
 - Near automatic doors or fire alarms.
- This system supports security functions that comply with the BLUETOOTH specification to ensure security connection during communication using BLUETOOTH technology. However, this security may be insufficient depending on the setting contents and other factors, so always be careful when performing communication using BLUETOOTH technology.
- Sony cannot be held liable in any way for damages or other loss resulting from information leaks during communication using BLUETOOTH technology.
- BLUETOOTH communication is not necessarily guaranteed with all BLUETOOTH devices that have the same profile as this system.
- BLUETOOTH devices connected with this system must comply with the BLUETOOTH specification prescribed by the Bluetooth SIG, Inc., and must be certified to comply. However, even when a device complies with the BLUETOOTH specification, there may be cases where the characteristics or specifications of the BLUETOOTH device make it impossible to connect, or may result in different control methods, display or operation.
- Noise may occur or the audio may cut off depending on the BLUETOOTH device connected with this system, the communications environment, or surrounding conditions.

Specifications

Amplifier section

The following are measured at AC 120 V – 240 V, 50/60 Hz

SHAKE-X7D

Power Output (rated):
800 W + 800 W (at 8 ohms, 100 Hz, 1% THD)

RMS output power (reference):
1,200 W + 1,200 W (per channel at 8 ohms, 100 Hz)

SHAKE-X3D

Power Output (rated):
400 W + 400 W (at 4 ohms, 100 Hz, 1% THD)

RMS output power (reference):
600 W + 600 W (per channel at 4 ohms, 100 Hz)

Inputs

AUDIO IN 1/PARTY CHAIN IN L/R
Voltage 2 V, impedance 47 kilohms

AUDIO IN 2 L/R
Voltage 2 V, impedance 47 kilohms

MIC 1, MIC 2
Sensitivity 1 mV, impedance 10 kilohms

⚡ (USB) 1, ⚡ (USB) 2 port: Type A

Outputs

AUDIO OUT/PARTY CHAIN OUT L/R
Voltage 2 V, impedance 1 kilohm

VIDEO OUT
Max. output level 1 Vp-p, unbalanced, Sync. negative load impedance 75 ohms

USB section

Supported bit rate
WMA: 48 kbps – 192 kbps, VBR, CBR
AAC: 48 kbps – 320 kbps, VBR, CBR

Sampling frequencies
WMA: 44.1 kHz
AAC: 44.1 kHz

Supported USB device
Mass Storage Class

Maximum current
1 A

Disc/USB section

Supported bit rate

MPEG1 Layer-3:
32 kbps – 320 kbps, VBR

Sampling frequencies

MPEG1 Layer-3:
32 kHz/44.1 kHz/48 kHz

Xvid

Video codec: Xvid
Bit rate: 4.854 Mbps (MAX)
Resolution/Frame rate:
720 × 480, 30 fps
720 × 576, 25 fps
Audio codec: MP3

MPEG4

File format: MP4 File Format
Video codec:
MPEG4 Simple Profile
(AVC is not compatible.)
Bit rate: 4 Mbps
Resolution/Frame rate:
720 × 576, 30 fps
Audio codec: AAC-LC
(HE-AAC is not compatible.)
DRM: Not compatible

Disc player section

System

Compact disc and digital audio and video system

Laser Diode Properties

Emission Duration: Continuous
Laser Output*: Less than 44.6 μ W
* This output is the value measurement at a distance of 200 mm from the objective lens surface on the Optical Pick-up Block with 7 mm aperture.

Frequency response

20 Hz – 20 kHz

Video color system format

NTSC and PAL

Tuner section

FM stereo, FM/AM superheterodyne tuner

Antenna

FM lead antenna
AM loop antenna

FM tuner section

Tuning range

87.5 MHz – 108.0 MHz (50 kHz step)

AM tuner section

Tuning range

European and Russian models only:
531 kHz – 1,602 kHz (9 kHz step)
Latin American and Australian models only:
531 kHz – 1,710 kHz (9 kHz step)
530 kHz – 1,710 kHz (10 kHz step)
Other models:
531 kHz – 1,602 kHz (9 kHz step)
530 kHz – 1,610 kHz (10 kHz step)

BLUETOOTH section

Communication system

BLUETOOTH Standard version 3.0

Output

BLUETOOTH Standard Power Class 2

Maximum communication range

Line of sight approx. 10 m¹⁾

Frequency band

2.4 GHz band (2.4000 GHz – 2.4835 GHz)

Modulation method

FHSS (Freq Hopping Spread Spectrum)

Compatible BLUETOOTH profiles²⁾

A2DP (Advanced Audio Distribution Profile)

AVRCP (Audio Video Remote Control Profile)

SPP (Serial Port Profile)

Supported codecs

SBC (Sub Band Codec)

AAC (Advanced Audio Coding)

¹⁾ The actual range will vary depending on factors such as obstacles between devices, magnetic fields around a microwave oven, static electricity, reception sensitivity, antenna's performance, operating system, software application, etc.

²⁾ BLUETOOTH standard profiles indicate the purpose of BLUETOOTH communication between devices.

Speakers

SS-SHAKEX7

Speaker system

3-way, Sound Pressure Horn

Speaker unit

Woofers: 150 mm, cone type

Tweeters: 25 mm, horn type

Subwoofers: 380 mm, cone type

Rated impedance

8 ohms

Dimensions (w/h/d) (Approx.)

510 mm × 773 mm × 458 mm

Mass (Approx.)

33.0 kg

SS-SHAKEX3

Speaker system

2-way, Sound Pressure Horn

Speaker unit

Tweeters: 25 mm, horn type

Subwoofers: 250 mm, cone type

Rated impedance

4 ohms

Dimensions (w/h/d) (Approx.)

368 mm × 585 mm × 358 mm

Mass (Approx.)

14.5 kg

General

Power requirements

AC 120 V – 240 V, 50/60 Hz

Power consumption

SHAKE-X7D: 375 W

SHAKE-X3D: 220 W

Power consumption (at the Power Saving mode)

0.5 W (When "BT STBY" is set to "OFF")

4 W (When "BT STBY" is set to "ON")

Dimensions (w/h/d) (excl. speakers) (Approx.)

455 mm × 165 mm × 330 mm

Mass (excl. speakers) (Approx.)

SHAKE-X7D: 6.3 kg

SHAKE-X3D: 5.9 kg

Design and specifications are subject to change without notice.

Language code list

The language spellings conform to the ISO 639:1988 (E/F) standard.

Code	Language	Code	Language	Code	Language	Code	Language
1027	Afar	1186	Scots Gaelic	1350	Malayalam	1513	Siswati
1028	Abkhazian	1194	Galician	1352	Mongolian	1514	Sesotho
1032	Afrikaans	1196	Guarani	1353	Moldavian	1515	Sundanese
1039	Amharic	1203	Gujarati	1356	Marathi	1516	Swedish
1044	Arabic	1209	Hausa	1357	Malay	1517	Swahili
1045	Assamese	1217	Hindi	1358	Maltese	1521	Tamil
1051	Aymara	1226	Croatian	1363	Burmese	1525	Telugu
1052	Azerbaijani	1229	Hungarian	1365	Nauru	1527	Tajik
1053	Bashkir	1233	Armenian	1369	Nepali	1528	Thai
1057	Byelorussian	1235	Interlingua	1376	Dutch	1529	Tigrinya
1059	Bulgarian	1239	Interlingue	1379	Norwegian	1531	Turkmen
1060	Bihari	1245	Inupiak	1393	Occitan	1532	Tagalog
1061	Bislama	1248	Indonesian	1403	(Afan) Oromo	1534	Setswana
1066	Bengali; Bangla	1253	Icelandic	1408	Oriya	1535	Tonga
1067	Tibetan	1254	Italian	1417	Punjabi	1538	Turkish
1070	Breton	1257	Hebrew	1428	Polish	1539	Tsonga
1079	Catalan	1261	Japanese	1435	Pashto; Pushto	1540	Tatar
1093	Corsican	1269	Yiddish	1436	Portuguese	1543	Twi
1097	Czech	1283	Javanese	1463	Quechua	1557	Ukrainian
1103	Welsh	1287	Georgian	1481	Rhaeto-Romance	1564	Urdu
1105	Danish	1297	Kazakh	1482	Kirundi	1572	Uzbek
1109	German	1298	Greenlandic	1483	Romanian	1581	Vietnamese
1130	Bhutani	1299	Cambodian	1489	Russian	1587	Volapük
1142	Greek	1300	Kannada	1491	Kinyarwanda	1613	Wolof
1144	English	1301	Korean	1495	Sanskrit	1632	Xhosa
1145	Esperanto	1305	Kashmiri	1498	Sindhi	1665	Yoruba
1149	Spanish	1307	Kurdish	1501	Sangho	1684	Chinese
1150	Estonian	1311	Kirghiz	1502	Serbo-Croatian	1697	Zulu
1151	Basque	1313	Latin	1503	Singhalese	1703	Not specified
1157	Persian	1326	Lingala	1505	Slovak		
1165	Finnish	1327	Laothian	1506	Slovenian		
1166	Fiji	1332	Lithuanian	1507	Samoa		
1171	Faroese	1334	Latvian; Lettish	1508	Shona		
1174	French	1345	Malagasy	1509	Somali		
1181	Frisian	1347	Maori	1511	Albanian		
1183	Irish	1349	Macedonian	1512	Serbian		

Parental Control area code list

Code	Area	Code	Area	Code	Area	Code	Area
2044	Argentina	2165	Finland	2362	Mexico	2149	Spain
2047	Australia	2174	France	2376	Netherlands	2499	Sweden
2046	Austria	2109	Germany	2390	New Zealand	2086	Switzerland
2057	Belgium	2248	India	2379	Norway	2528	Thailand
2070	Brazil	2238	Indonesia	2427	Pakistan	2184	United Kingdom
2079	Canada	2254	Italy	2424	Philippines		
2090	Chile	2276	Japan	2436	Portugal		
2092	China	2304	Korea	2489	Russia		
2115	Denmark	2363	Malaysia	2501	Singapore		

Index

A

A/V SYNC 29
AAC file 8
AM tuning interval 34
Angles 21
AUDIO 27
AUDIO DRC 29
AUDIO SETUP 29

B

BACKGROUND 29
BASS CUT 39
Batteries 16
BLACK LEVEL 28
BLUETOOTH 34

C

Child Lock 45
Clock 18
COLOR SYSTEM 18, 28

D

DATA CD 8
DATA DVD 8
Demonstration 18
DJ EFFECT 40
DOWNMIX 29
DVD VIDEO 8

F

FM MODE 33

J

JPEG file 8

K

Karaoke 42
 Key Control 43
 SCORE MODE 29, 43
 VOCAL FADER 43

L

Language code list 58
Language/sound 22
LANGUAGE SETUP 27

M

MEDIA MODE 19
MEGA BASS 39
MENU 27
MP3 file 8
MPEG4 file 8
MULTI-DISC RESUME 23, 29
Multisession disc 9

N

NFC 12, 36
NFC Easy Connect 37
Normal Play 23

O

OSD 27

P

PARENTAL CONTROL 25, 29
Party Chain 41
PAUSE MODE 28
PBC playback 22
PHOTO EFFECT 28
PHOTO INTERVAL 28
Playable discs/files 8
Power Saving Mode 18
Preset station 34
Program Play 24

Q

QUICK setup 17

R

Remote control 13
Repeat Play 25
RESET 29, 51

S

SCREEN SAVER 29
Setup Menu 27
Shuffle Play 23
Slide show 20
Sound effect 40
Speaker
 Positioning 17
SUBTITLE 21, 27
SYSTEM SETUP 29

T

Timer 43
TRACK SELECTION 29
TV TYPE 28

U

Update 45
USB devices 10, 19, 30
USB memory 19
USB Transfer 30
 Analog Transfer 31, 32
 Bit rate 30
 Erasing 32
 REC1 Transfer 30, 32
 Synchronized Transfer
 30, 32

V

VIDEO SETUP 28
Viewing information 26
 Display panel 27
 TV screen 26

W

WMA file 8

X

Xvid file 8

<http://www.sony.net/>



* 4 5 6 2 4 6 9 1 4 * (1)