



# Operating Instructions

*Wireless LAN  
Access Point*  
**PCWA-A100/A200**

## Owner's Record

The model and serial numbers are located on the bottom of the product. Record the serial number in the space provided below. Refer to them whenever you call upon your Sony dealer regarding this product.

Model No. PCWA-A100, PCWA-A200  
Serial No. \_\_\_\_\_

## NOTE

FCC Part 68 and INDUSTRY CANADA NOTICE are for PCWA-A100 only.

## CAUTION

You are cautioned that any changes or modifications not expressly approved in this manual could void your warranty.

FCC ID: IMRWLPCE24H

Exposure to Radio Frequency Radiation.  
The radiated output power of the Wireless LAN PC Card\* is far below the FCC radio frequency exposure limits.

Nevertheless, the Wireless LAN PC Card\* shall be used in such a manner that the potential for human contact during normal operation is minimized.

\* The Wireless LAN Access Point PCWA-A100/A200 contains a Wireless LAN Card. (FCC ID of the Wireless LAN PC card is IMRWLPCE24H.)

## NOTE:

This equipment has been tested and found to comply with the limits for a Class B digital device, pursuant to Part 15 of the FCC Rules. These limits are designed to provide reasonable protection against harmful interference in a residential installation. This equipment generates, uses, and can radiate radio frequency energy and, if not installed and used in accordance with the instructions, may cause harmful interference to radio or communications. However, there is no guarantee that interference will not occur in a particular installation. If this equipment does cause harmful interference to television reception, which can be determined by turning the equipment off and on, you are encouraged to try to correct the interference by one or more of the following measures:

- Reorient or relocate the receiving antenna.
- Increase the separation between the equipment and receiver.
- Connect the equipment into an outlet on a circuit different from that to which the receiver is connected.
- Consult the dealer or an experienced radio/TV technician for help.

You are cautioned that any changes or modifications not expressly approved in this manual could void your authority to operate this equipment.

## Declaration of Conformity

Trade Name: Sony

Model No: PCWA-A100/A200

Responsible Party: Sony Electronics Inc.

Address: 680 Kinderkamack Road,  
Oradell, NJ 07649 USA

Telephone: 201-930-6972

This device complies with part 15 of the FCC Rules.

Operation is subject to the following two conditions:

- (1) This device may not cause harmful interference, and
- (2) this device must accept any interference received, including interference that may cause undesired operation.

## Notes

- The power outlet should be near the equipment and easily accessible.
- This Class B digital apparatus complies with Canadian ICES-003.  
Cet appareil numérique de la classe B est conforme a la norme NMB-003 du Canada.

## Safety Information

### WARNING

- Opening the unit, for whatever reason, could lead to damages that are not covered by the guarantee.
- To prevent fire or shock hazard, do not expose your Sony Wireless LAN Access Point to rain or moisture.
- Never install modem or telephone wiring during a lightning storm.
- Never install telephone jacks in wet locations unless the jack is specifically designed for wet locations.
- Never touch uninsulated telephone wire or terminals unless the telephone line has been disconnected at the network interface.
- Use caution when installing or modifying telephone lines.
- Avoid using the modem during an electrical storm.
- Do not use the modem or a telephone to report a gas leak while in the vicinity of the leak.

- Use only the supplied AC adapter with your Sony Wireless LAN Access Point. To disconnect your Wireless LAN Access Point from the power supply, unplug the AC adapter.
- Make sure the power outlet is easily accessible.

#### **FCC Part 68 (PCWA-A100 only)**

This equipment complies with Part 68 of the FCC rules. The Ringer Equivalence Number (REN) and the FCC registration number are printed on the modem board. If requested, this information must be supplied to the telephone company.

The REN is used to determine the quantity of devices which may be connected to the phone line. Excessive REN on the telephone line may prevent incoming calls from ringing. In most, but not all areas, the sum of the RENs should not exceed five (5.0). To be certain of the number of devices you can connect to the line, contact the telephone company to determine the maximum REN for the calling area.

If this equipment causes harm to the telephone network, your local telephone company will, when practical, notify you in advance that a temporary discontinuance of service may be required. If advance notice is not practical, the telephone company will notify you as soon as possible. You will be advised of your right to file a complaint with the FCC.

The telephone company may make changes in its facilities, equipment, operations or procedures that could affect the operation of this equipment. If this happens, the telephone company will notify you in advance to make the necessary modifications to maintain uninterrupted service. For repair or warranty information, please contact 1-877-760-7669, or write to the Sony Customer Information Center, 12451 Gateway Boulevard., Fort Myers, FL 33913. This equipment cannot be used on telephone-company-provided coin service. Connection to party line service is subject to state tariffs.

Repair of the equipment should be made only by a Sony Service Center or Sony authorized agent. For the Sony Service Center nearest you, call 1-877-760-7669.

**Telephone Consumer Protection Act of 1991**  
The Telephone Consumer Protection Act of 1991 makes it unlawful for any person to use a computer or other electronic device to send any message via telephone facsimile machine unless such message clearly contains (in a margin at the top or bottom of each transmitted page or on the first page of the transmission), the date and time it is sent and an identification of the business, other entity, or individual sending the message, and the telephone number of the sending machine or such business, other entity, or individual.

In order to program this information into your facsimile machine, see your fax software documentation.

#### **Notes (PCWA-A100 only)**

- The modem uses an RJ-11 telephone jack.
- The Ringer Equivalence Numbers for this equipment is 0.5B.

#### **INDUSTRY CANADA NOTICE (PCWA-A100 only)**

The industry Canada label identifies certified equipment. This certification means that the equipment meets certain telecommunications network protective, operational and safety requirements as prescribed in the appropriate Terminal Equipment Technical Requirements document(s). The department does not guarantee the equipment will operate to your satisfaction.

Check with your local telephone company before installing this equipment. They can advise you of the acceptable connection method.

Be aware that compliance with the above conditions may not prevent degradation of service in some situations.

Repairs to certified equipment should be coordinated by a representative designated by the supplier. Equipment malfunctions or any repairs or alterations made by you to this equipment may give the telecommunications company cause to request that the user disconnect the equipment.

For your own protection, ensure that the power utility, telephone lines and internal metallic water pipe systems are grounded. This may be particularly important in rural areas.

**CAUTION:** Contact the appropriate electrical inspection authority or electrician, as appropriate. Do not attempt this yourself.

**NOTICE:** The REN assigned to each terminal device is used to calculate the maximum number of terminals allowed on a telephone interface.

An interface may have any combination of devices, but the sum of the REN for all devices cannot exceed 5.

#### **AVIS DE L'INDUSTRIE CANADA (PCWA-A100 seulement)**

**AVIS:** L'étiquette d'Industrie Canada identifie le matériel homologué.

Cette étiquette certifie que le matériel est conforme aux normes de protection, d'exploitation et de sécurité des réseaux de télécommunications, comme le prescrivent les documents concernant les exigences techniques relatives au matériel terminal. Le Ministère n'assure toutefois pas que le matériel fonctionnera à la satisfaction de l'utilisateur.

Avant d'installer ce matériel, l'utilisateur doit s'assurer qu'il est permis de le raccorder aux installations de l'entreprise locale de télécommunication. Le matériel doit également être installé en suivant une méthode acceptée de raccordement.

L'abonné ne doit pas oublier qu'il est possible que la conformité aux conditions énoncées ci-dessus n'empêche pas la dégradation du service dans certaines situations.

Les réparations de matériel homologué doivent être coordonnées par un représentant désigné par le fournisseur. L'entreprise de télécommunications peut demander à l'utilisateur de débrancher un appareil à la suite de réparations ou de modifications effectuées par l'utilisateur ou à cause de mauvais fonctionnement.

Pour sa propre protection, l'utilisateur doit s'assurer que tous les fils de mise à la terre de la source d'énergie électrique, des lignes téléphoniques et des canalisations d'eau métalliques, s'il y en a, sont raccordés ensemble. Cette précaution est particulièrement importante dans les régions rurales.

**Avertissement:** L'utilisateur ne doit pas tenter de faire ces raccordements lui-même; il doit avoir recours à un service d'inspection des installations électriques, ou à un électricien, selon le cas.

**AVIS:** L'indice d'équivalence de la sonnerie (IES) assigné à chaque dispositif terminal indique le nombre maximal de terminaux qui peuvent être raccordés à une interface.

La terminaison d'une interface téléphonique peut consister en une combinaison de quelques dispositifs, à la seule condition que la somme d'indices d'équivalence de la sonnerie de tous les dispositifs n'exécède pas 5.

If you have questions about this product, call the Sony Customer Information Center at 1-877-760-7669; or write to the Sony Customer Information Center at 12451 Gateway Boulevard., Fort Myers, FL 33913. The number below is for FCC-related matters only.

#### **About the supplied software**

**SUPPLIED SOFTWARE IS SUPPLIED PURSUANT TO THE APPLICABLE END USER LICENSE AGREEMENT.**

- Copyright laws prohibit reproducing the software or the software manual in whole or in part, or renting the software without the permission of the copyright holder.
- In no event will SONY be liable for any financial damage or loss of profits, including claims made by third parties, arising out of the use of the software supplied with this product.
- In the event a problem occurs with this software as a result of defective manufacturing, SONY will replace it at SONY's option or issue a refund; however, SONY bears no other responsibility.
- The software provided with this product cannot be used with equipment other than that which is designated for use with.
- Please note that, due to continued efforts to improve quality, the software specifications may be changed without notice.

Program © 2000 2001 Sony Corporation,  
© 2000 Lucent Technologies, Copyright 1998  
by Carnegie Mellon University.

CMU DISCLAIMS ALL WARRANTIES WITH REGARD TO THIS SOFTWARE, INCLUDING ALL IMPLIED WARRANTIES OF MERCHANTABILITY AND FITNESS, IN NO EVENT SHALL CMU BE LIABLE FOR ANY SPECIAL, INDIRECT OR CONSEQUENTIAL DAMAGES OR ANY DAMAGES WHATSOEVER RESULTING FROM LOSS OF USE, DATA OR PROFITS, WHETHER IN AN ACTION OF CONTRACT, NEGLIGENCE OR OTHER TORTIOUS ACTION, ARISING OUT OF OR IN CONNECTION WITH THE USE OR PERFORMANCE OF THIS SOFTWARE.

Documentation © 2000 Sony Corporation.

Sony, VAIO, and the VAIO logo are trademarks of Sony Corporation. Microsoft, Windows, and Windows NT are registered trademarks of Microsoft Corporation in the United States and other countries.

MMX and Pentium are registered trademarks of Intel Corporation.

All other trademarks are trademarks of their respective owners.

- In this manual, Microsoft® Windows® 98 Second Edition is referred to as Windows 98 Second Edition.
- In this manual, Microsoft® Windows® Me is referred to as Windows Me.
- In this manual, Microsoft® Windows® 2000 Professional is referred to as Windows 2000.
- In this manual, Microsoft® Windows® XP Professional and Microsoft® Windows® XP Home Edition are referred to as Windows XP.

---

# Table of contents

Overview .....	6
What you can do with your Wireless LAN Access Point ..	6
System requirements .....	9
About supplied manuals .....	10

## Getting started

Unpacking .....	11
Parts and indicators .....	12
Connections .....	13
Connecting the Access Point to the Internet .....	13
Connecting the Access Point to a power source .....	19
Attaching the unit stand .....	20
Setting up .....	21
Factory default configuration of the Access Point .....	21

## Additional information

Precautions .....	24
Specifications .....	25
Getting Help .....	26
Glossary .....	27
Troubleshooting .....	28
Limited Warranty Statement .....	29

# Overview

## What you can do with your Wireless LAN Access Point

The Wireless LAN Access Point PCWA-A100/A200 (hereinafter referred to as the Access Point) is designed for building a wireless LAN (Local Area Network) environment. Connect your Access Point to a power outlet, insert the Wireless LAN PC Card PCWA-C100 into your computer, and use the software supplied with your Wireless LAN PC Card to build a wireless LAN environment.

Using the wireless LAN for connecting computers requires no wiring which allows you to operate multiple computers more freely than ever. The Access Point is capable of building a wireless LAN environment including a maximum of 49 client computers (16 or fewer is recommended).

You can connect to an Integrated Services Digital Network (ISDN) router, cable modem, DSL modem, or (with the PCWA-A100) a telephone line to share access to the Internet among multiple computers, or just use the Access Point as the hub of your LAN without Internet access (hereafter referred to as a local network).

In a LAN environment, you can share files on other client computers and let others share files on your computer. The following four figures depict the various configurations you can implement.

### 1 Connecting to a telephone line and a network (see page 13) (PCWA-A100 only)

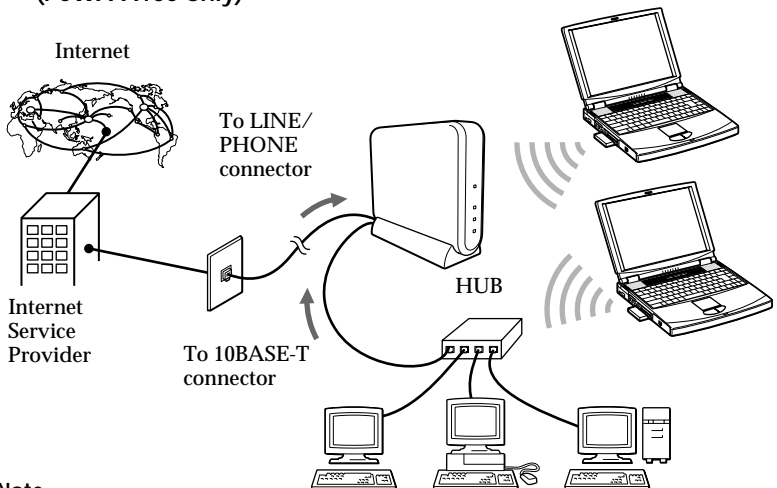

#### Note

You cannot connect the PCWA-A200 to an analog telephone line.

**2** Connecting to an ISDN router (see page 15)

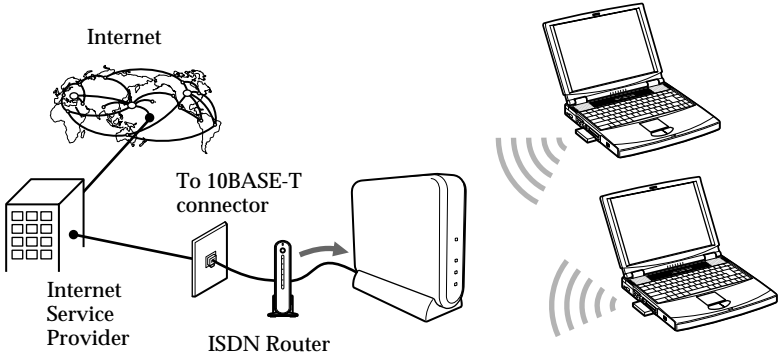

**3** Connecting to a cable modem (see page 16)

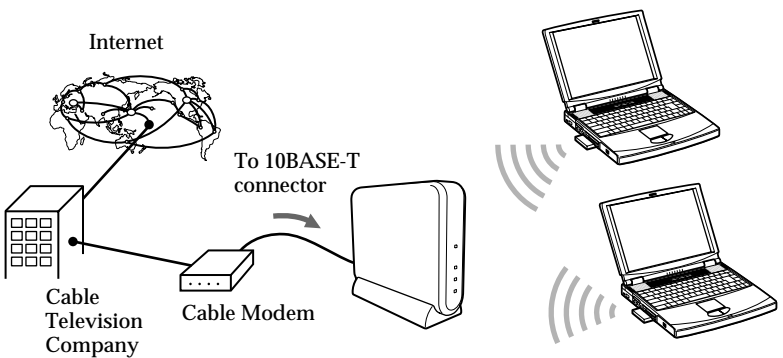

**4** Connecting to a DSL modem (see page 17)

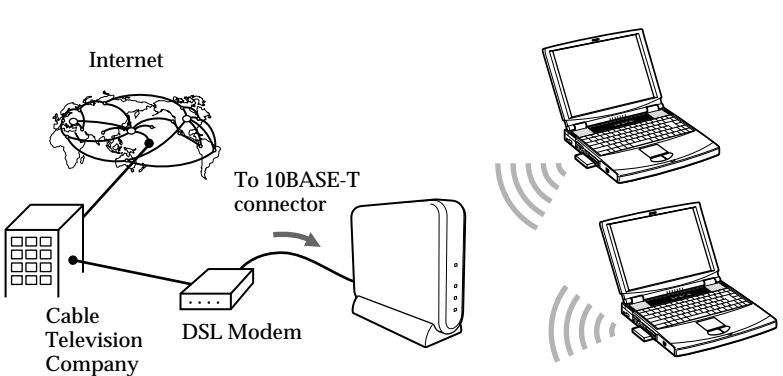

5 Using as the hub of your local network (see page 18)

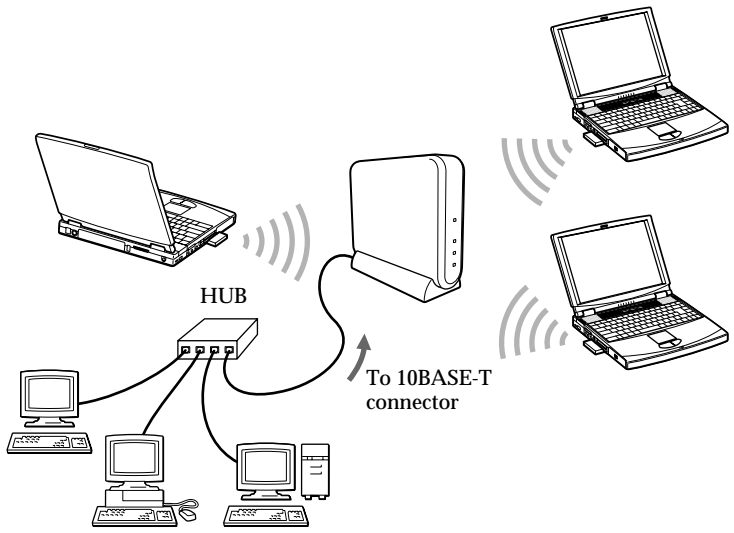



---

## System requirements

- A computer satisfying the following requirements.

CPU: MMX® Pentium® 233 MHz and above

RAM: 64 MB and above

With Windows 98 Second Edition, Windows Me, or Windows 2000:

64 MB or more

With Windows XP:

128 MB or more

CD-ROM drive

Default built-in PCMCIA Type II slot

- Operating system: For best results, use a computer with one of the preinstalled operating systems below.
  - Windows 98 Second Edition, English version
  - Windows Me, English version
  - Windows 2000
  - Windows XP

(Does not operate under the Windows 98, 95 or 3.1 versions or under the Windows NT version. Also, operation is not guaranteed under all upgraded environments.)

- Display: SVGA (800 x 600 pixels) and above, [supports High Color (16 bit) and above]

### Notes

- We do not assure trouble-free operation for all computers satisfying the system requirements.
- An agreement with an Internet Service Provider (ISP) is required for Internet access.

---

## About supplied manuals

Please read the Operating Instructions and Help information for the Access Point (PCWA-A100/A200) and Wireless LAN PC Card (PCWA-C100) in the following order.

- 1** Wireless LAN Access Point Operating Instructions (this document)  
Explains how to connect and install the Access Point. Please read this manual first.
- 2** Wireless LAN PC Card Operating Instructions (supplied with PCWA-C100)  
This describes the following topics.
  - Procedure for installing the Wireless LAN PC Card
  - Procedure for installing the supplied software, and making settings
  - Procedure for Access Point settings, using the Basic Access Point Setup Utility.
- 3** Help for each software (included on supplied CD-ROM)  
To learn in details the usage of a software, please read its Help.
  - **Wireless Palette Help**  
Online help explains how to set up and use the Wireless Palette software, monitor the connection status between the Access Point and the Wireless LAN PC Card, and switch the Access Point to use from a client computer when multiple Access Points are present.
  - **Custom Access Point Setup Utility Help**  
Online help that explains how to make advanced settings on the Access Point.
  - **Upgrade Manual**  
Online help that explains procedures for updating the Access Point's firmware, the Wireless LAN PC Card Driver, and the Basic/Custom Access Point Setup Utility. If you are already using our Wireless LAN product, please read this manual.

# Unpacking

Your Access Point comes with the following items.

- Wireless LAN Access Point

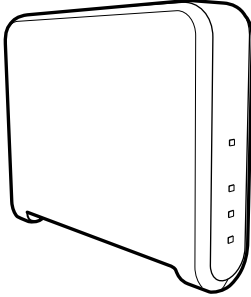

- Unit stand

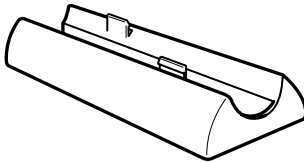

- AC power adapter

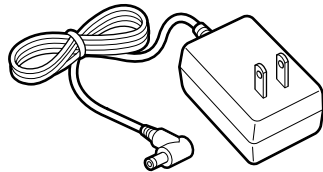

- Telephone cable  
(PCWA-A100 only)

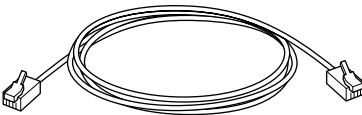

- Telephone jack splitter  
(PCWA-A100 only)



- CD-ROM (Setup disc)
- Wireless LAN Access Point Operating Instructions (This manual)
- Other printed materials

# Parts and indicators

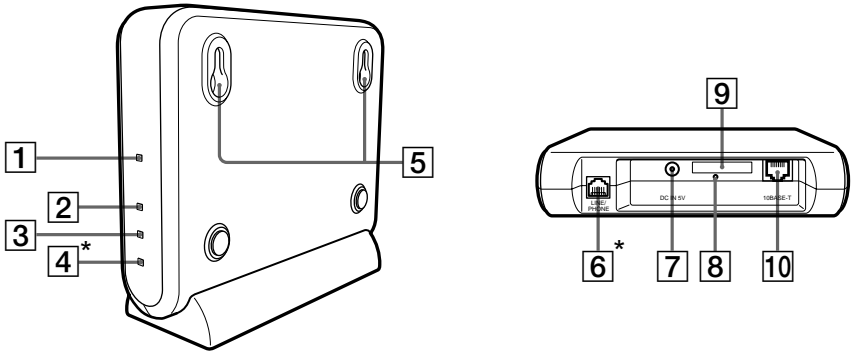

\* Not included with the PCWA-A200.

- 1 POWER indicator**  
Lights while power is supplied.
- 2 WIRELESS indicator**  
Lights when data is being exchanged on a wireless LAN.
- 3 ETHERNET indicator**  
Lights while data exchange is in progress through the 10BASE-T connector.
- 4 PHONE indicator (PCWA-A100 only)**  
Lights while data exchange is in progress through the LINE/PHONE connector.
- 5 Wall-mounting holes**
- 6 LINE/PHONE connector (RJ-11) (PCWA-A100 only) (page 14)**  
Connects to the telephone cable.
- 7 DC IN 9V jack (page 19)**  
Connects to the AC power adapter.
- 8 Reset switch**
- 9 ID label (page 20)**  
The Access Point ID and other information are printed on this label.
- 10 10BASE-T connector (RJ-45) (page 15)**  
Connects to a cable modem, DSL modem, ISDN router, or hub through an Ethernet cable.

# Connections

## Connecting the Access Point to the Internet

Connection to the Internet varies depending on your Internet environment. If you are using the Access Point for your local network only, and you do not need to connect it the Internet, proceed to page 18 and see “To use the Access Point for your local network only.”

**Note**

You must select Cable Modem or LAN connection mode before connecting the Access Point to a LAN that has a DHCP server. See the Wireless LAN PC Card Operating Instructions to configure the connection mode.

Under no circumstances should connection be made to a LAN that includes an active DHCP server if Phone or Local Only has been selected as the connection mode.

## To connect the Access Point to the telephone line (PCWA-A100 only)

The PCWA-A100 is equipped with a built-in modem for connection to an analog telephone line. When the Access Point is connected to a telephone line, multiple computers connected via Wireless LAN PC cards can connect to the Internet through this modem.

Up to 49 computers can simultaneously be connected to the Internet via a single telephone line (16 or fewer is recommended). However, note that connecting additional computers reduces the communication speed for each computer.

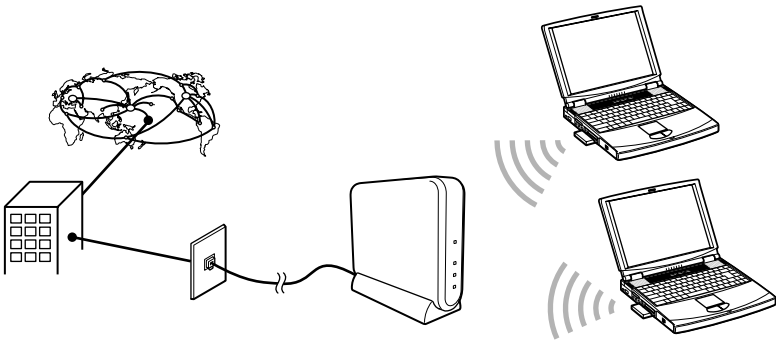

**Note**

You cannot connect the PCWA-A200 to an analog telephone line.

## 1 Connect the telephone cable to the LINE/PHONE connector.

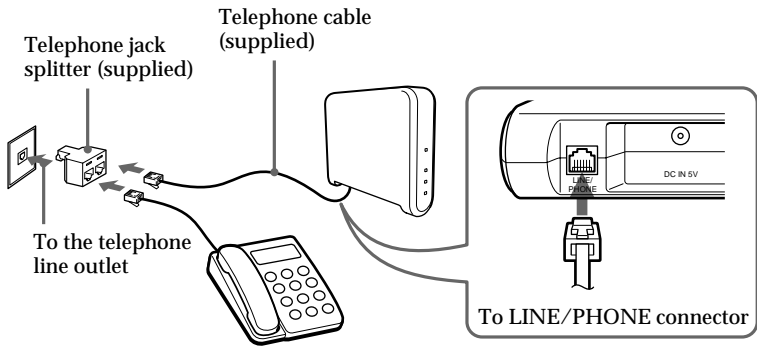

### Tip

You may also connect computers to the Access Point via a hub. Use the 10BASE-T connector to build a wired LAN environment in addition to a wireless LAN environment. This makes file sharing available among wireless and wired LAN clients.

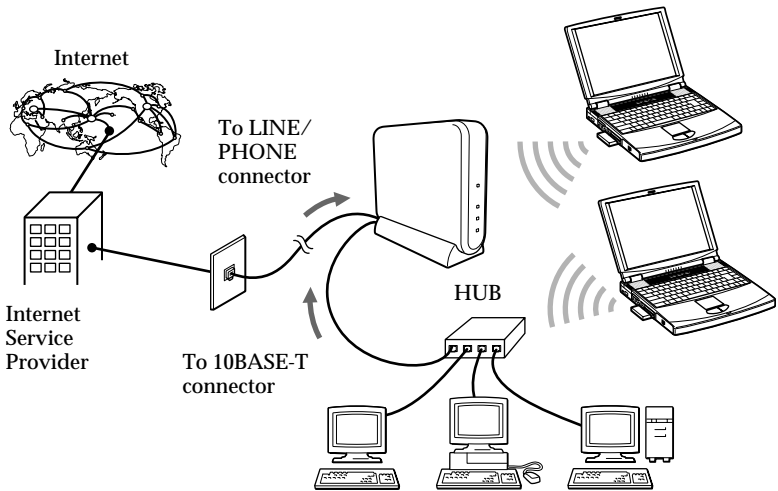

## 2 Connect the AC power adapter (page 19).

### Notes

- A category 5 Ethernet cable is recommended.
- Use a flexible Ethernet cable when attaching a unit stand to the Access Point. Using an inflexible cable will not allow you to attach the unit stand.
- To connect a hub to the 10BASE-T connector on the Access Point, use a straight-through Ethernet cable (same order color code when side by side).
- To connect a computer directly to the 10BASE-T connector on the Access Point, use a crossover Ethernet cable (reverse order color code when side by side).

## To connect the Access Point to the ISDN router

Connecting the Access Point to an ISDN router provides multiple computers containing a Wireless LAN PC Card with Internet access via the Access Point. No connection is required between the computer(s) and router.

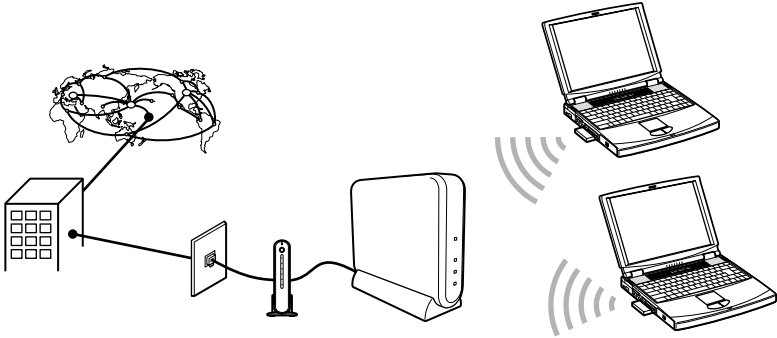

- 1 Connect the ISDN router and the Access Point with an Ethernet cable.

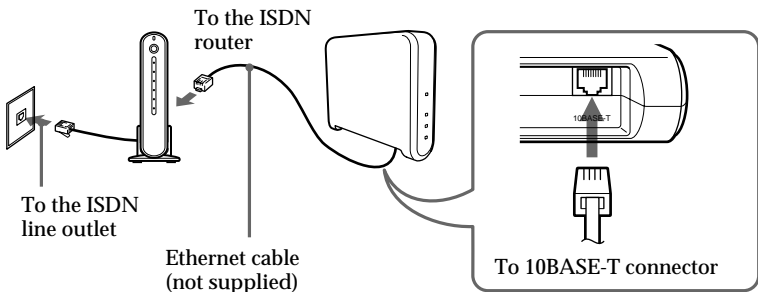

- 2 Connect the AC power adapter (page 19).

### Notes

- For ISDN router setup, refer to the manual supplied with your ISDN router.
- A category 5 Ethernet cable is recommended.
- Use a flexible Ethernet cable when attaching a unit stand to the Access Point. Using an inflexible cable will not allow you to attach the unit stand.

## To connect the Access Point to the cable modem

Connecting the Access Point to a cable modem provides multiple computers containing the Wireless LAN PC Card with Internet access via the Access Point.

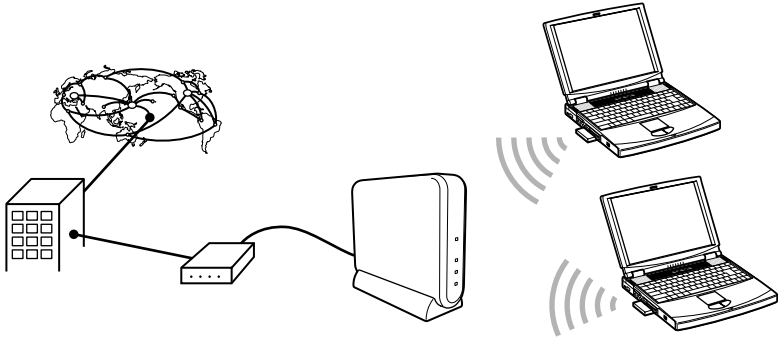

- 1 Connect the cable modem and the Access Point with an Ethernet cable.

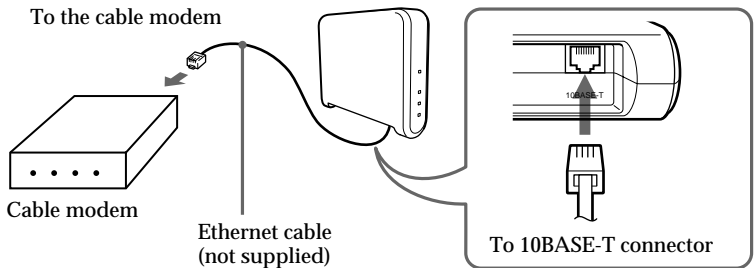

- 2 Connect the AC power adapter (page 19).

### Notes

- For cable modem setup, refer to the manual supplied with your device.
- A category 5 Ethernet cable is recommended.
- Use a flexible Ethernet cable when attaching a unit stand to the Access Point. Using an inflexible cable will not allow you to attach the unit stand.



## To connect the Access Point to a DSL modem

Connecting the Access Point to a DSL modem provides Internet access to computers that are using a Wireless LAN PC Card.

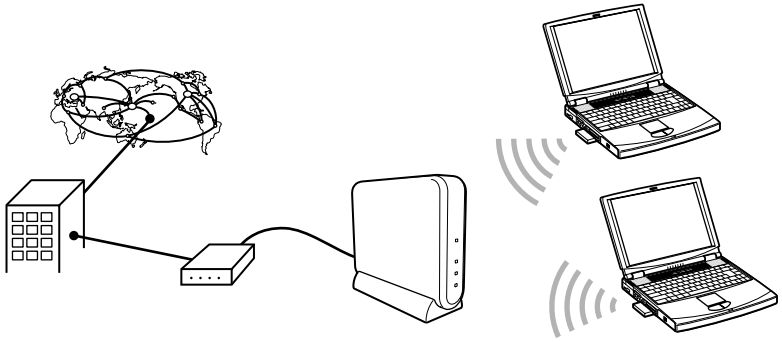

- 1 Connect the DSL modem and the Access Point with an Ethernet cable.

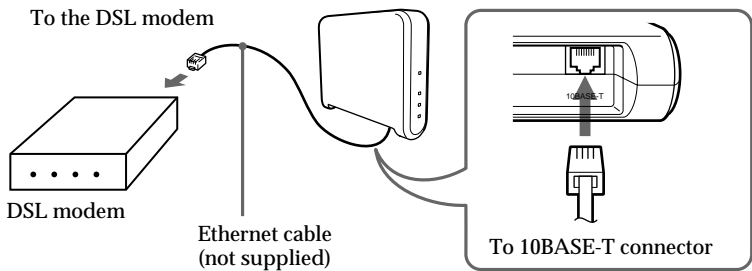

- 2 Connect the AC power adapter (page 19).

### Notes

- For DSL modem setup, refer to the manual supplied with your device.
- A category 5 Ethernet cable is recommended.
- Use a flexible Ethernet cable when attaching a unit stand to the Access Point. Using an inflexible cable will not allow you to attach the unit stand.

## To use the Access Point for your local network only

The Access Point may be used simply as a hub for wireless computers in your local network without Internet access. Use of the Access Point in this manner enables file sharing among client computers. In such a case, a power connection is the only requirement (Page 19).

You may also connect computers to the Access Point via a hub, using the 10BASE-T connector to make them wired LAN clients (bridging).

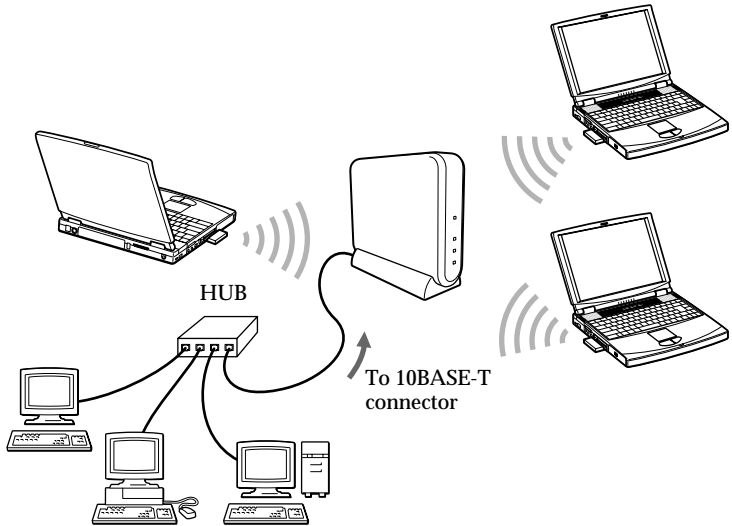

### Notes

- To connect a hub to the 10BASE-T connector on the Access Point, use a straight-through Ethernet cable (same order color code when side by side).
- To connect a computer directly to the 10BASE-T connector on the Access Point, use a crossover Ethernet cable (reverse order color code when side by side).
- A category 5 Ethernet cable is recommended.

## Connecting the Access Point to a power source

Use the supplied AC power adapter to connect to a power outlet.

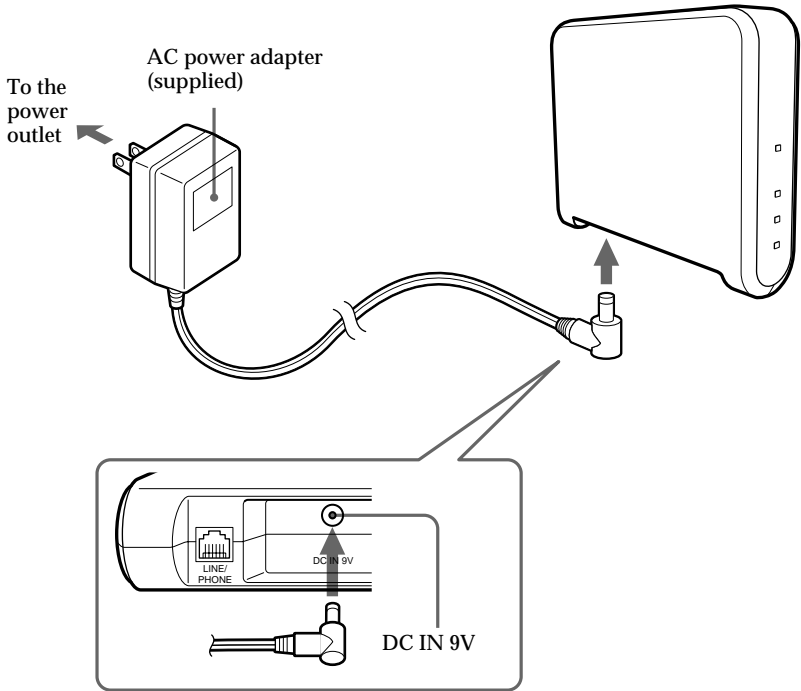

### To power on/off the Access Point

The Access Point is not equipped with a power switch.

To power on/off the Access Point, plug/unplug the AC power adapter.

Leave the AC power adapter plugged into the power outlet under normal use.

---

## Attaching the unit stand

The unit stand allows you to place your Access Point in an upright position.

When the unit stand is attached, cables are routed through the recessed groove.

### Before attaching the unit stand

Make sure to write down the six-digit Access Point ID on the label attached on the bottom surface of the Access Point.

Access Point ID

ID:123456	SN:00UT12345678
	PN:012756

### Note

Depending on the type of Ethernet cable used, it may be impossible to install the stand.

Attach the unit stand to the Access Point as shown in the figure below.

Engage Joint A with Joint B and slide the Access Point in the direction indicated by the arrow until it clicks.

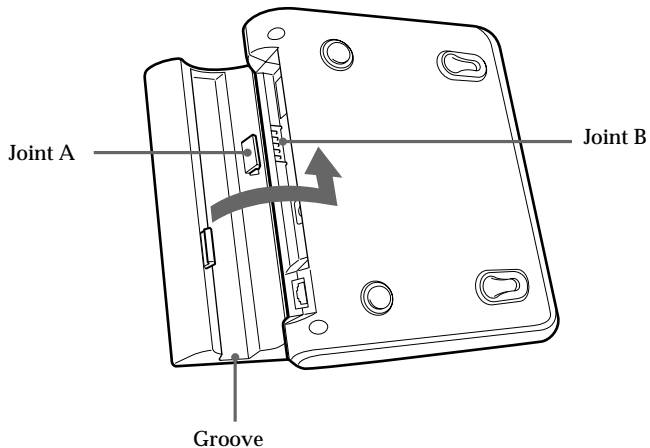

### Tip

The unit stand may be attached in either direction.

### To remove the unit stand

Slide the Access Point and unit stand in opposite directions to detach.

---

## Setting up

After you connect and install your Access Point, see the manual, *Wireless LAN PC Card Operating Instructions*. The manual provides instructions on how to insert the PC card into the computer, install and set up its software, and install the software needed to set up the Access Point.

## Factory default configuration of the Access Point

The Access Point is configured at shipment as follows:

### Connection mode

Cable Modem (Router Mode)

### IP settings

IP address in the WAN: automatically obtained. (The Access Point serves as a DHCP client.)

IP address in the wireless LAN: 10.0.1.1

### Wireless settings

Network Name (SSID): Access Point ID

Encryption Key: the last five digits of Access Point ID

The Access Point serves as the DHCP server for client computers on the LAN.

The number of IP addresses in the pool is set to 16.

The IP addresses to be assigned are 10.0.1.2 through 10.0.1.17.

The above settings can be changed using the Custom Access Point Setup Utility that is included on the provided CD-ROM. For further instructions, refer to the Custom Access Point Setup Utility Help.

## Ethernet MAC address

The Ethernet MAC Address can be verified by following the steps below:

- 1** Right-click the Wireless Palette icon on the Microsoft® Windows® taskbar.
- 2** Click Version in the pop-up menu.
- 3** Verify the number shown for Wireless Access Point Ethernet Address.

---

## If you forget the Access Point settings

If you forget the Access Point settings, so that you can no longer connect to the Access Point, use the following procedure to make the settings again.

### Note

When a static IP address is set to the Access Point, you cannot change the settings as in the following procedure. In this case, return the Access Point to the factory default settings using the Access Point Firmware Upgrade Utility. For details on how to upgrade the Access Point, refer to the Access Point Firmware Upgrade Utility Help.

- 1** Hold the reset switch using the tip of a paper clip for approximately one second while the power to the Access Point is ON. For information on reset switch position, see "Parts and indicators" on page 12.

The POWER indicator lights in orange. The Encryption Key will be disabled for approximately five minutes and the password for the Access Point Setup Utility will also be disabled. (Software Reset mode)

- 2** With Windows 98 Second Edition/Me/2000:

Select this Access Point using the Wireless Palette, delete the value of the Encryption Key on the setting menu, and click CONNECT.

The connection can require some time.

#### With Windows XP:

1. From the start menu, select Connect to, then click the Wireless Network Connection.

The Wireless Network Connection Status dialog box appears.

2. Select Properties.

The Wireless Network Connection Properties dialog box appears.

3. Select the Wireless Networks tab.
4. From Preferred Networks, select the desired Access Point, and click Properties.
5. Remove the checkmark from Data encryption (WEP enable), and click OK.

The screen returns to the Wireless Network Connection Properties dialog box.

6. Click OK.

- 3** Start either the Custom Access Point Setup Utility or the Basic Access Point Setup Utility.

---

The software reset will automatically set the password to its factory default setting of “public.” (You can now change the password to anything other than “public”.)

**4** Click SCAN.

Selection of communication mode and setup of common parameters dialog box appears.

**5** Delete the “\*\*\*\*\*” in the Encryption Key text box and retype it, then click NEXT.

The Information for Encryption Key dialog box appears.

**6** Click OK.

The Setup of the Connection Mode dialog box appears.

**7** Click NEXT.

The Connection Setup dialog box appears.

**8** Click UPLOAD.

The settings are uploaded to the Access Point. Please wait until the Access Point’s POWER indicator turns green. It takes approximately 30 seconds.

**9** Click FINISH to exit.

This completes the procedure with Windows 98 Second Edition, Windows Me, and Windows 2000.

**10** With Windows XP, you must go on to reestablish connection with the Access Point as follows.

1. From the start menu, select Connect to, then click the Wireless Network Connection.

The Wireless Network Connection Status dialog box appears.

2. Select Properties.

The Wireless Network Connection Properties dialog box appears.

3. Select the Wireless Networks tab.

4. From Preferred Networks, select the desired Access Point, and click Properties.

5. Apply a checkmark for Data encryption (WEP enabled), and enter the changed Encryption Key in Network key.

6. Click OK.

The Wireless Network Connection dialog box reappears.

7. Click OK.

This completes the procedure with Windows XP.

# Precautions

## AC power adapter

Be sure to use the supplied AC power adapter. Other AC power adapters may cause a failure to the Access Point.

## Safety

Do not drop the Access Point. Careful handling will help prevent damage.

## Installation

Do not place the Access Point where it will be exposed to the following conditions:

- Unstable surfaces.
- High humidity or poor ventilation.
- Excessive dust.
- Direct sunlight or extreme heat.
- Closed cars.
- Magnetized locations (near magnets, speakers, or televisions).
- Locations exposed to frequent vibration.
- Locations where the transmission of radio waves may be obstructed by metal plates or concrete walls

## Operation

Exposure to cold-to-hot temperature extremes or very damp environments may cause moisture to condense on internal parts. This may prevent the Access Point from operating properly.

If this should happen, unplug the AC power adapter from the power outlet and let the Access Point sit for two to three hours or until the moisture evaporates.

## Cleaning

Clean the casing with a soft cloth, lightly moistened with water or a mild detergent solution. Do not use any type of abrasive pad, scouring powder or solvent such as alcohol or benzene. This may damage the finish of the casing.



---

# Specifications

## Communication distance

Approx. 100 m (approx. 330 feet) with no obstacles  
(The communicable distance depends on the environment.)

## Maximum number of units connected

49 units (number of clients)  
(Recommended number of clients is 16 or less)

## Protocol support

TCP/IP, NetBEUI

## Standard

IEEE802.11b/IEEE802.11

## Radio frequency

2.4 GHz

## Modulation method

DS-SS (IEEE802.11 compliant)

## Encryption (WEP)

64-bit encryption  
(However the actual length of the key that can be entered is 40 bits, or 5 characters.)

## General

### Power requirements

100 to 240 V AC, 50/60 Hz

### Power consumption

Approx. 5 W

### Dimensions

With stand: Approx. 156 × 134.5 × 53 mm  
(approx. 6 ¼ × 5 ¾ × 2 ⅛ inches) (w/h/d)

Without stand: Approx. 156 × 125 × 35 mm  
(approx. 6 ¼ × 5 × 1 ⅙ inches) (w/h/d)

### Mass

PCWA-A100: Approx. 480 g (approx. 17 oz.)

PCWA-A200: Approx. 450 g (approx. 16 oz.)

(excluding the unit stand and the AC power adapter)

### Operating temperature

5°C to 35°C (41°F to 95°F) (not condensed)

### Environment temperature

-20°C to 60°C (-4°F to 140°F) (not condensed)

## Supplied accessories

See page 11.

Design and specifications are subject to change without notice.

---

# Getting Help

This section describes how to get help and support from Sony, as well as troubleshooting tips for your Access Point.

## About Sony's Support Options

Sony provides several support options for your Access Point. When you have questions about your Access Point and its related software, check these options for answers:

- **This guide** explains how to use your Access Point.
- **The Sony Access Point support Web site** <http://www.sony.com/wirelesslansupport/> provides the latest information on your Access Point. On this Web site, you will find:
  - Answers to Frequently Asked Questions (FAQs)
  - An electronic version of the Operating Instructions
  - Help files
  - Installation information
  - Software upgrades
- **The Sony e-mail support service** answers your questions by electronic mail. E-mail your question and a customer service representative will reply. To send a question to Sony e-mail support, fill out the e-mail form at <http://www.sony.com/wirelesslansupport/>
- **The Sony fax-back service** provides you with answers to commonly asked questions. You can use this automated service to request a list of available topics and then select the topics you want to receive. To contact the Sony fax-back service, call **1-877-760-7669**.
- **The Sony Customer Information Services Center** offers information about your Access Point and other Sony products that work with your computer. To contact the Sony Customer Information Services Center, call **1-877-760-7669**.  
**Open 24 hours/day, 7 days/week.**

---

# Glossary

## **Client**

A computer connected to a LAN (Local Area Network). Also called a client computer.

## **ISDN**

ISDN (Integrated Services Digital Network) is a set of standards for digital transmission over ordinary telephone copper wire and other media. Home and business users who install ISDN routers can access graphic-intense Web pages with greatly increased speed over that of modem users. ISDN requires routers at both ends. Your Internet Service Provider (ISP) also needs an ISDN router.

## **LAN**

Unlike the internet, which is a network that is used by unlimited number of people, LAN (Local Area Network) is a network that is used by limited number of people.

For example, there is LAN used only by those belonging to the company or the division, and there is LAN constructed in home by interconnecting computers.

---

# Troubleshooting

If you experience any of the following difficulties while using the Access Point, this troubleshooting guide may help you remedy the problem. Should a problem persist, consult the Sony Customer Information Service Center.

## On the Access Point

**The Access Point is not operating properly.**

- The Access Point is not supplied with power.  
Connect the Access Point to a power outlet with the supplied AC power adapter. (See page 19.)
- There is an obstacle between the Access Point and the computer containing the Wireless LAN PC Card, or they are too far apart from each other.  
Remove the obstacle between them, or place them within 100 m (approx. 330 feet) of each other. (The communicable distance depends on the environment.)
- The Access Point and the telephone line (for PCWA-A100 only), or the Access Point and the ISDN router/Cable modem/DSL modem, is not connected to each other with a proper cable.  
Make sure to use the cable described in this manual. (See page 14, 15, 16, 17.)

**The indicators do not come on.**

- Cables are not properly connected.
  - If you are using PCWA-A100, check if the modular plug is connected properly.
  - Check the cables for validity.

**I have forgotten the settings for the Access Point I am currently using, and cannot make a connection. This also means that I cannot connect to the Internet.**

- With the Wireless LAN PC Card (PCWA-C100) correctly installed in the computer, redo the Access Point settings. For details, see the section, “If you forget the Access Point settings” on page 22.

---

# Limited Warranty Statement

## Sony Wireless LAN Access Point/ Wireless LAN PC Card Warranty

The limited warranty on your hardware covers parts and labor against defects in material or workmanship for a period of three months from the original date of purchase. You can extend the warranty period for an additional nine months by registering your Wireless LAN Access Point/Wireless LAN PC Card. See “Registering your Wireless LAN Access Point/Wireless LAN PC Card” on page 53 of the Wireless LAN PC Card Operating Instructions. Once you register your Wireless LAN Access Point/Wireless LAN PC Card, the limited warranty period is twelve months from the original date of purchase.

For the purpose of this Limited Warranty “SONY” means SONY ELECTRONICS INC. for Products purchased in the United States of America. SONY warrants this Wireless LAN Access Point/Wireless LAN PC Card product (“the Product”) against defects in material or workmanship as follows:

1. Labor: For a period of ninety (90) calendar days from the original date of purchase from SONY or a SONY authorized reseller, SONY will repair defects in material or workmanship in the Product at no charge, or pay the associated labor charges to a SONY authorized service facility. The ninety (90) day warranty period is extendible only to the original purchaser, for an additional period of nine (9) months, for a total of twelve

(12) months from date of purchase when the Product is registered electronically prior to the expiry of ninety (90) days from the original date of purchase. After the applicable period, you must pay for all labor charges.

2. Parts: For a period of ninety (90) calendar days from the original date of purchase from SONY or a SONY authorized reseller, SONY will supply, at no charge, new or rebuilt, at SONY’s option, replacement parts in exchange for defective parts. Any replacement parts will be warranted for the remainder of the original warranty period or ninety (90) calendar days from installation by SONY’s authorized service facility, whichever is longer. The ninety (90) day warranty period is extendible only to the original purchaser, for an additional period of nine (9) months, for a total of twelve (12) months from date of purchase when the Product is registered within ninety (90) days from the original date of purchase. All defective parts replaced under this Limited Warranty will become the property of SONY.

This Limited Warranty covers only the hardware components packaged with the Product. It does not cover the technical assistance for hardware or software usage, and it does not cover any software products whether or not contained in the Product; SONY excludes all warranties express or implied in respect of any software provided with the product and any such software is provided “AS IS,”

---

unless expressly provided for in any enclosed software limited warranty. Please refer to the End User License Agreements included with the Product for your rights and obligations with respect to the software.

This Limited Warranty is non-transferable. Proof of purchase in the form of a bill of sale (which is evidence that the Product is within the warranty period) must be presented to obtain warranty service. In addition, if replacement parts are required and you wish to receive the most expedient service available, you will be required to provide SONY with a credit card authorization to bill your credit card in the event you fail to return the original parts in the postage-paid envelope we provide. The credit card will only be charged for SONY's list price for the part if the original part has not been returned within thirty (30) days.

With respect to certain components you may be entitled to express warranty service during the warranty period, subject to certain restrictions. Please contact SONY for further information.

SONY will not be responsible for any damage to or loss of any programs, data or other information stored on any media or any part of any Product serviced hereunder or any consequential damages resulting therefrom.

Be sure to remove all third party hardware, software, features, parts, options, alterations, and attachments

not warranted by SONY prior to sending the Product to SONY for service. SONY is not liable for any loss or damage to these items.

This Limited Warranty does not cover any consumable items supplied with this Product; cosmetic damages; damage or loss to any software programs, data, or media; or damage due to (1) acts of God, accident, misuse, abuse, negligence, commercial use or modifications of this Product; (2) improper operation or maintenance of this Product; (3) connection to improper voltage supply; or (4) attempted repair by any party other than a SONY authorized service facility. This Limited Warranty does not apply when the malfunction results from the use of this Product in conjunction with accessories, products or ancillary or peripheral equipment, or where it is determined by SONY that there is no fault with the Product itself. This Limited Warranty is valid only in the United States of America. This Limited Warranty is invalid if the factory-applied serial number has been altered or removed from the product.

Repair or replacement of defective parts or hardware as provided under this Limited Warranty is the exclusive remedy of the consumer. SONY SHALL NOT BE LIABLE FOR ANY INCIDENTAL OR CONSEQUENTIAL DAMAGES OR OTHER DAMAGES INCLUDING BUT NOT LIMITED TO, LOSS OF PROFITS, LOSS OF REVENUE, LOSS OF DATA, LOSS OF USE OF THE PRODUCT OR ANY ASSOCIATED EQUIPMENT, DOWNTIME AND PURCHASER'S

---

TIME. FOR BREACH OF ANY EXPRESS OR IMPLIED WARRANTY, BREACH OF CONTRACT, NEGLIGENCE, STRICT LIABILITY OR ANY OTHER LEGAL THEORY RELATED TO THIS PRODUCT. EXCEPT TO THE EXTENT PROHIBITED BY APPLICABLE LAW, ANY IMPLIED WARRANTY OF MERCHANTABILITY OR FITNESS FOR A PARTICULAR PURPOSE ON THIS PRODUCT IS LIMITED IN DURATION TO THE DURATION OF THIS WARRANTY.

Some states do not allow the exclusion or limitation of incidental or consequential damages, or allow limitations on how long an implied warranty lasts, so the above limitations or exclusions may not apply to you. This Limited Warranty gives you specified legal rights, and you may have other rights which vary from state to state.

Technical Support: Although technical support is not provided free of charge under this Limited Warranty, SONY has established a telephone number for technical support. Charges may apply for technical support, unless and to the extent that free technical support for a limited period is provided in writing as a feature of your Product. Prior to placing you call, please have available the model and serial numbers for your Product, date of purchase, a list of all options installed in your Product and a detailed description of the problem.

For Product support, online knowledge base, frequently asked questions, and free upgrades via the Internet: <http://www.sony.com/wirelesslansupport/>

For Product information, service assistance, resolution of a service problem, or technical assistance, call 1-877-760-7669.

Save this for future reference.

© 2000, 2001 Sony Corporation  
Reproduction in whole or in part without written permission is prohibited. All rights reserved. SONY is a registered trademark of Sony.

- 
- The Sony e-mail support service** answers your questions by electronic mail. Just send your question in an e-mail message and a customer service representative will reply. To send a question to Sony e-mail support, fill out the e-mail form at <http://www.sony.com/wirelesslansupport/>
  - The Sony fax-back service** provides you with answers to commonly asked questions. You can use this automated service to request a list of available topics and then select the topics you want to receive. To contact the Sony fax-back service, call 1-877-760-7669.
  - The Sony Customer Information Services Center** offers information about your Access Point, Wireless LAN PC Card, and other Sony products that work with your computer. To contact the Sony Customer Information Services Center, call 1-877-760-7669. Open 24 hours/day, 7 days/week.

<http://www.world.sony.com/>  
Printed on recycled paper