

# ***Sony Notebook User Guide***

**PCG-FR Series**

**W10**

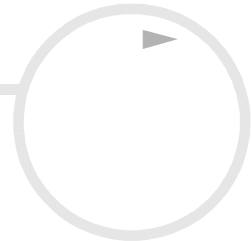



## *Read this first*

### *Notice*

© 2003 Sony Corporation. All rights reserved.

This manual and the software described herein, in whole or in part, may not be reproduced, translated, or reduced to any machine-readable form without prior written approval.

Sony Corporation provides no warranty with regard to this manual, the software, or other information contained herein and hereby expressly disclaims any implied warranties or merchantability or fitness for any particular purpose with regard to this manual, the software or such other information. In no event shall Sony Corporation be liable for any incidental, consequential, or special damages, whether based on tort, contract, or otherwise, arising out of or in connection with this manual, the software, or other information contained herein or the use thereof.

**Macrovision:** This product incorporates copyright protection technology that is protected by method claims of certain U.S. patents and other intellectual property rights owned by Macrovision Corporation and other rights owners. Use of this copyright protection technology must be authorized by Macrovision Corporation, and is intended for home and other limited viewing uses only unless otherwise authorized by Macrovision Corporation. Reverse engineering or disassembly is prohibited.

Sony Corporation reserves the right to make any modification to this manual or the information contained herein at any time without notice. The software described herein is governed by the terms of a separate user licence agreement.



## ENERGY STAR®

As an ENERGY STAR® Partner, Sony has determined that this product meets the ENERGY STAR® guidelines for energy efficiency.

The International ENERGY STAR® Office Equipment Program is an international program that promotes energy saving through the use of computers and their office equipment. The program backs the development and dissemination of products with functions that effectively reduce energy consumption. It is an open system in which business proprietors can participate voluntarily. The targeted products are office equipment such as computers, displays, printers, facsimiles and copiers. Their standards and logos are uniform among participating nations.

ENERGY STAR is a U.S. registered mark.



## Safety information

### Owner's record

The serial number and model number are located on the bottom of your Sony notebook. Record the serial number and the model number and refer to them if you call VAIO-Link. Read the printed **Specifications** document.

### Warnings

#### General

- Opening the unit, for whatever reason, could lead to damages that are not covered by the guarantee.
- To avoid electrical shock, do not open the cabinet. Refer servicing to qualified personnel only.
- To prevent fire or shock hazard, do not expose your VAIO notebook to rain or moisture.
- Avoid using the modem during a severe electrical storm.
- Do not use the modem or a telephone to report a gas leak in the vicinity of the leak.
- To change the backup battery, please contact your nearest Sony Service Center.
- Before you connect peripherals, turn off the computer and all peripherals.
- Connect the power cord only after connecting all cables.
- Turn on the computer only after turning off all peripherals.
- Do not move your computer while the system is in Standby mode.**
- The magnetic properties of some objects can have serious consequences for your hard disk drive. They can erase the data on the hard disk drive and cause the computer to malfunction. Do not place your computer near or on any objects which emit magnetic fields, mainly:
  - TV sets
  - Speakers
  - Magnets
  - Magnetic bracelets.

### *Audio/video*

- ❑ Audio and picture distortion may occur if this equipment is positioned in close proximity to any equipment emitting electromagnetic radiation.

### *Connectivity*

- ❑ Never install modem or telephone wiring during a severe lightning storm.
- ❑ Never install telephone jacks in wet locations unless the jack is specifically designed for wet locations.
- ❑ Be cautious when installing or modifying telephone lines.
- ❑ Use your notebook only with the supplied AC adapter. To disconnect your notebook completely from mains voltage, unplug the AC adapter.
- ❑ Please make sure that the socket outlet is easily accessible.
- ❑ Never touch uninsulated telephone wire or terminals unless the telephone line has been disconnected at the network interface.

### *Optical disc drive*

- ❑ Misuse of the optical instruments supplied with your notebook can cause eye hazard. As the laser beam used in this product is harmful to eyes, do not attempt any disassembling process. For servicing, refer to qualified personnel only.
- ❑ There are visible and invisible radiations when the optical disc drive is open: avoid direct exposure to the laser beam.

## Regulatory information

Sony hereby declares that this product is in compliance with the essential requirements and other relevant provisions of European Directive 1999/5/EC (radio equipment and telecommunications terminal equipment Directive).

### Declaration of Conformity

The European Union is targeting the free movement of goods for the internal market and to prevent technical barriers to trade. This effort has resulted in several EU Directives asking that manufacturers make their products comply with essential standards. Manufacturers are required to affix the "CE" mark on the products they sell and to draw up a "Declaration of Conformity" (DoC).

Primarily, the Declarations of Conformity are intended for the market surveillance authorities as proof that products satisfy the required standards. Additionally, Sony provides these EU DoC's on the website <http://www.compliance.sony.de> as a service to our customers.

You can search for all Declarations of Conformity available for a specific product by typing in the model name in the search box. A list of matching documents will be displayed and can be downloaded. Please note that the availability of declarations depends on the scope of the EU Directives and the individual product specifications.



This product complies with EN 55022 Class B and EN 55024 for use in following areas: residential, commercial and light-industrial.

This product has been tested and found compliant with the limits set out in the EMC Directive for using connection cables not longer than 3 metres (9.8 feet).

The optical disc drive is classified as a CLASS 1 LASER PRODUCT and complies with the Laser Product Safety Standard EN 60825-1. Repair and maintenance only by authorized Sony technicians. Improper repairs and use can create safety hazards.



Before activating the built-in modem, you are invited to read the **Modem Regulations flyer** leaflet.

## *Disposing of lithium ion batteries*

- ❑ Do not handle damaged or leaking lithium ion batteries. Dispose of promptly and properly at end-of-life.
- ❑ Danger of explosion if the battery is incorrectly replaced. Replace only with the same or equivalent type recommended by the manufacturer. Discard used batteries according to the manufacturer's instructions.
- ❑ The battery pack used in this device may present a fire or chemical burn hazard if mistreated. Do not disassemble, heat above 60°C (140°F) or incinerate.
- ❑ Dispose of used batteries promptly and properly.
- ❑ Keep away from children.
- ❑ In some areas the disposal of lithium ion batteries in household or business waste may be prohibited.
- ❑ Use the public collection system.

## *Disposing of internal memory backup battery*

- ❑ Your notebook is equipped with an internal memory backup battery that should not have to be replaced during the lifetime of the product. For changing this battery, please contact VAIO-Link.
- ❑ Danger of explosion if the battery is incorrectly replaced.
- ❑ Dispose of properly at end-of-life.
- ❑ In some areas the disposal of lithium ion and other non-hazardous batteries in household or business waste may be prohibited.
- ❑ Please use the public collection system.

## Welcome

Congratulations on purchasing a Sony VAIO notebook. Sony has combined leading-edge technology in audio, video, computing and communications to provide you with state-of-the-art personal computing.

Here are just some of the features your VAIO notebook has to offer.

- ❑ **Exceptional performance** - Your PC includes a fast processor, a fast CD-RW/DVD-ROM or DVD-RW\* drive and an internal modem.
- ❑ **Portability** - The rechargeable battery pack provides hours of use without AC power.
- ❑ **Sony audio and video quality** - A high-resolution LCD screen enables you to take advantage of today's advanced multimedia applications, games, and entertainment software.
- ❑ **Multimedia features** – Enjoy audio and video CDs.
- ❑ **Interconnectivity** – Your computer has Ethernet and i.LINK™ functionalities. i.LINK™ is a bidirectional digital interface for exchanging data. With the Memory Stick™ you can easily exchange and share digital data with compatible products.
- ❑ **Windows®** - Your system includes Microsoft's Windows® XP Professional or Home Edition\* with Service Pack 1 operating system\*.
- ❑ **Communications** - Access popular online services, send and receive e-mails, browse the Internet.
- ❑ **Excellent customer support** - If you are experiencing any problems with your computer, please check the VAIO-Link website for a possible solution:

<http://www.vaio-link.com>

Before contacting VAIO-Link, Before contacting VAIO-Link, you should try to solve the problem by reading this User Guide or the manuals and help files for the peripherals or software.

\* Depending on your model. Read the printed **Specifications** document for more information.



## Documentation pack

Your Documentation Pack contains printed information and user guides to read on your computer. The user guides are compiled in the **VAIO Info Centre** on the **VAIO Recovery and Documentation Disc**.

### Printed documentation

- ❑ A **Getting Started** brochure, where you will find a brief description of the items in your box, and how to setup your notebook;
- ❑ A **Specification** sheet, containing a table of specifications and a list of bundled software.
- ❑ A **Guide to Troubleshooting / Using the VAIO Recovery and Documentation Disc** booklet, where you will find troubleshooting, VAIO-Link information and an explanation of the purpose and use of the VAIO Recovery and Documentation Disc.
- ❑ A **Dual Language Operating System** leaflet\*;
- ❑ Your **Sony Guarantee** conditions;
- ❑ A **Safety Regulations** leaflet;
- ❑ A **Modem Regulations** leaflet.

\* Depending on your country. Dual Language Operating Systems are available in **Belgium, the Netherlands** and **Switzerland**.

## Documentation on disc

The online part of your documentation includes the following:

- 1 The **Hardware Guide** (this guide):
  - ❑ **Using your notebook** shows you how to use the standard components of your system. In this part of the manual you will also find out what you can do with a **Memory Stick™**.
  - ❑ **Connecting peripheral devices** explains how you can add functionality by connecting various peripherals.
  - ❑ **Getting help** explains the support options available to you, and offers basic troubleshooting tips.
  - ❑ **Precautions** provides facts and advice about using your notebook.
  - ❑ **Glossary** refers to terms used in this manual.
- 2 Refer to your **Software Guide** for information on the software and the Sony applications.
  - ❑ **About the Software delivered with your computer** is a short description of the features of the software delivered with your system.
  - ❑ **Using Video software** explains how to use Sony video software: DVgate, and Network Smart Capture.
  - ❑ **Managing audio files with SonicStage** explains how to convert your existing MP3, WMA and WAV format audio files into ATRAC3 format.
  - ❑ **Using PictureGear Studio** explains how to get the most enjoyment out of your photographs taken with a digital camera.
  - ❑ **Using Click to DVD** explains how to capture video images from a digital external device (camera, VCR, etc.) and write them to a DVD\*.
  - ❑ **Using VAIO Media** explains how to enjoy music, video and photos through your home networking environment.
  - ❑ **Customizing your computer** explains how to configure your modem, set a wallpaper or select a screensaver.

- ❑ **Installing and updating applications** explains how to install, run or uninstall a software application.
  - ❑ **Managing drivers** explains how to install, update or uninstall a driver.
- 3 In the **VAIO-Link Customer Service Guide** you will find all the VAIO-Link information you need, including specific contact numbers for each country.

\* Depending on your model. Read the printed **Specifications** document for more information.

### *Online documentation*

- 1 Consult the **Online Help** files of the software you are using for detailed information on features and troubleshooting.
- 2 Refer to the Microsoft **Quick Start** manual for more information on Windows®.
- 3 Go to <http://www.club-vaio.com> to find online tutorials about your favourite VAIO software.

## Your notebook and its accessories

The following hardware items are in the box:

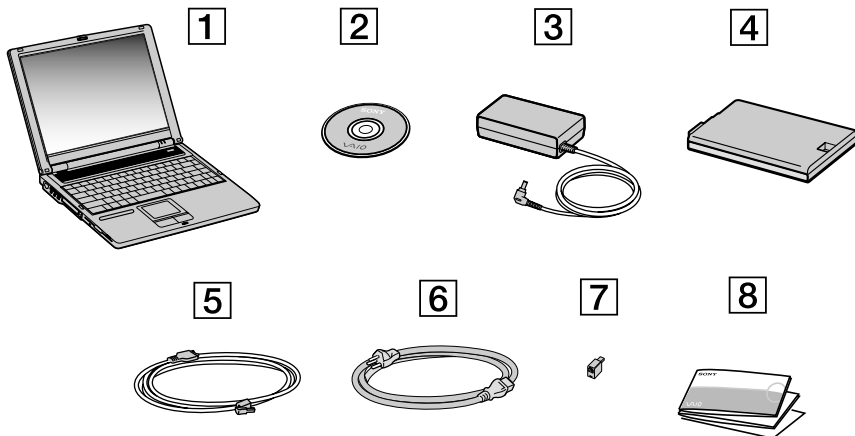

1	Main unit	5	Phone cable
2	VAIO Recovery and Documentation Disc*	6	Power cord
3	AC adapter	7	Phone plug**
4	Rechargeable battery pack	8	Documentation pack



If you find an extra phone plug in the box, see **Using the correct phone plug (page 56)**.

\*Not available with models sold in Belgium or Spain.

\*\*See the printed **Guide to Troubleshooting and Using the VAIO Recovery and Documentation Disc** for details.

## Ergonomic considerations

You will be using your notebook as a portable device in a variety of environments. Whenever possible, you should attempt to take account of the following ergonomic considerations to both stationary and portable environments:

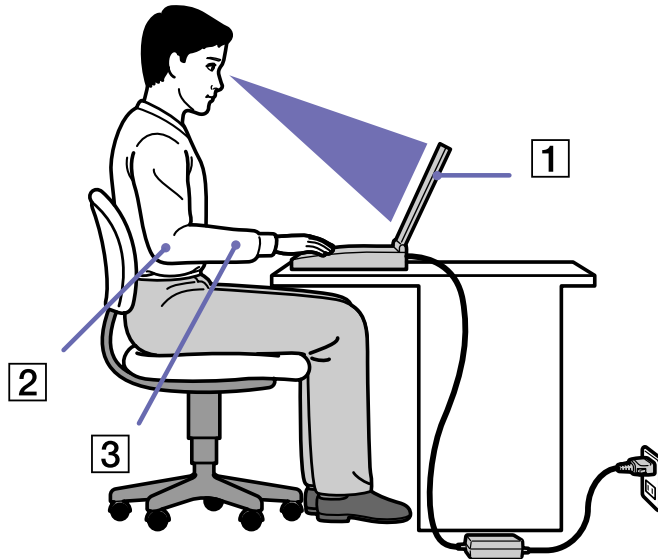

- ❑ **Positioning your computer** – Place the computer directly in front of you (1). Keep your forearms horizontal (2), with your wrists in a neutral, comfortable position (3) while using the keyboard, touchpad, or external mouse. Let your upper arms hang naturally at your sides. Have breaks during sessions with your computer. Excessive use of the computer may strain muscles or tendons.

- ❑ **Furniture and posture** – Sit in a chair with good back support. Adjust the level of the chair so your feet are flat on the floor. A footrest may make you more comfortable. Sit in a relaxed, upright posture and avoid slouching forward or leaning far backwards.
- ❑ **Viewing angle of the computer's display** – Use the display's tilting feature to find the best position. You can reduce eye strain and muscle fatigue by adjusting the tilt of the display to the proper position. Adjust the brightness setting of the display as well.
- ❑ **Lighting** – Choose a location where windows and lights do not create glare and reflection on the display. Use indirect lighting to avoid bright spots on the display. You can also purchase accessories for your display that help reduce glare. Proper lighting adds to your comfort and work effectiveness.
- ❑ **Positioning an external display** – When using an external display, set the display at a comfortable viewing distance. Make sure the display screen is at eye level or slightly lower when you are sitting in front of the monitor.

## Using your notebook

This section describes how to start using your computer and how to use your computer's internal and external devices.

- ❑ Locating controls and connectors ([page 15](#))
- ❑ Connecting a power source ([page 20](#))
- ❑ Starting your notebook ([page 24](#))
- ❑ Setting up your notebook with Sony Notebook Setup ([page 25](#))
- ❑ Changing the video memory size ([page 27](#))
- ❑ Shutting down your notebook ([page 28](#))
- ❑ Using the keyboard ([page 29](#))
- ❑ Using the touchpad ([page 34](#))
- ❑ Using the disc drive ([page 35](#))
- ❑ Using the floppy disk drive ([page 39](#))
- ❑ Using PC Cards ([page 41](#))
- ❑ Using Memory Stick™ ([page 44](#))
- ❑ Using the modem ([page 55](#))
- ❑ Using power saving modes ([page 57](#))

## Locating controls and connectors

### Right

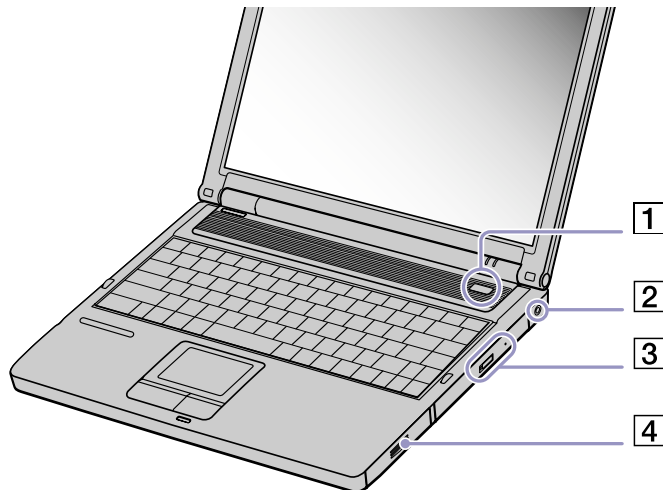

1	Power button	<a href="#">(page 24)</a>
2	DC In connector	<a href="#">(page 20)</a>
3	CD-RW/DVD-ROM or DVD-RW drive*	<a href="#">(page 35)</a>
4	Battery bay	<a href="#">(page 21)</a>

\* Depending on your model. Read the printed **Specifications** document for more information.



## Left

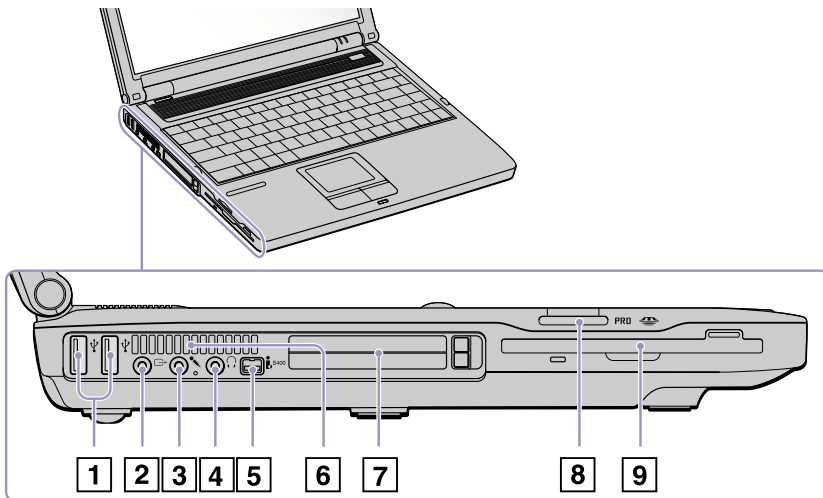

1	2 USB 2.0 ports (High-speed/Full-speed/Low-speed)*	<a href="#">(page 72)</a>
2	AV out jack (for TV and line out)	<a href="#">(page 63)</a>
3	Microphone connector	<a href="#">(page 71)</a>
4	Headphone connector	<a href="#">(page 70)</a>
5	i.LINK™ connector	<a href="#">(page 75)</a>
6	Ventilation slot	<a href="#">(page 16)</a>
7	PC Card slots	<a href="#">(page 41)</a>
8	Memory Stick slot	<a href="#">(page 44)</a>
9	Floppy disk drive	<a href="#">(page 39)</a>

 Do not cover the ventilation slot when the computer is on.

\* This USB connector supports USB 2.0 standard. USB 2.0 is a new USB (Universal Serial Bus) standard which supports higher data transfer speed than USB 1.1. Connectors which support USB 2.0 support products with USB 1.1.

There are 3 transfer modes:

- High-speed: 480Mbps, this is the highest speed.
- Full-speed: 12Mbps transfer mode.
- Low-speed: 1.5Mbps transfer mode. Used for low-speed devices such as mouse and keyboards.

## Front

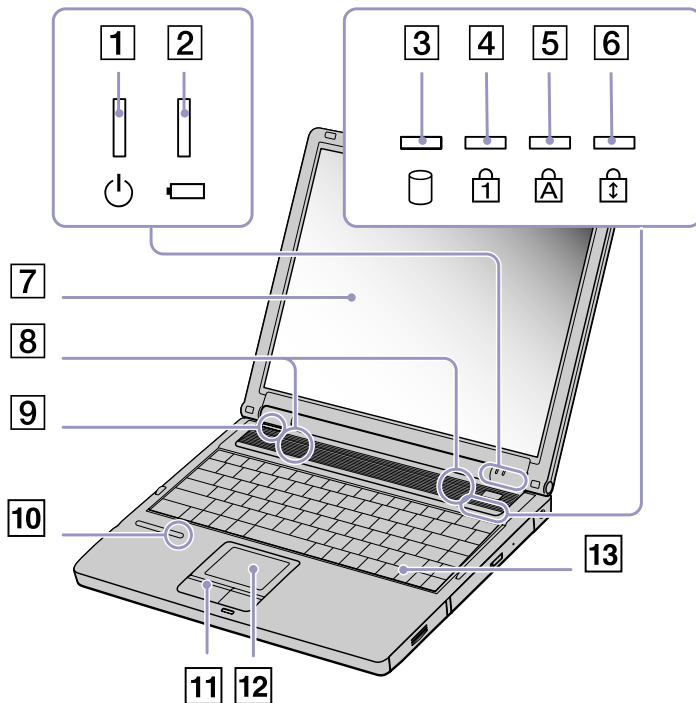

1	Power indicator	<a href="#">(page 32)</a>
2	Battery indicator	<a href="#">(page 32)</a>
3	Hard disk drive indicator	<a href="#">(page 32)</a>
4	Num Lock indicator	<a href="#">(page 32)</a>
5	Caps Lock indicator	<a href="#">(page 32)</a>
6	Scroll Lock indicator	<a href="#">(page 32)</a>
7	LCD screen	<a href="#">(page 33)</a>
8	Speakers	<a href="#">(page 33)</a>
9	Model name	/
10	Memory Stick indicator	<a href="#">(page 32)</a>
11	Left/right buttons	<a href="#">(page 34)</a>
12	Touchpad	<a href="#">(page 34)</a>
13	Keyboard	<a href="#">(page 29)</a>

## Back

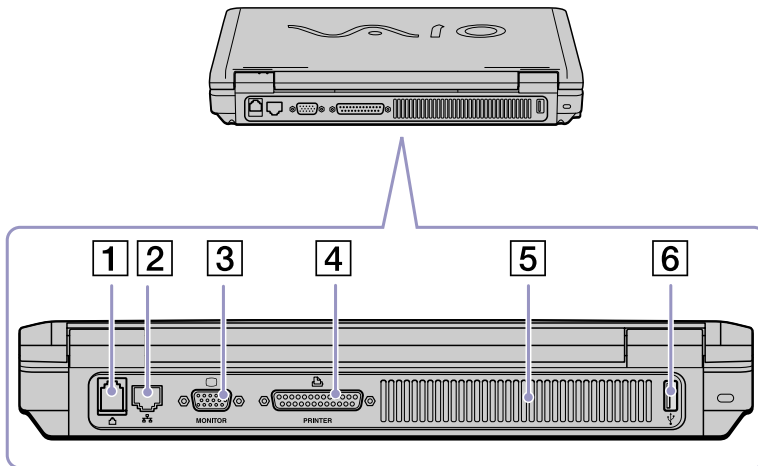

1	Ethernet connector	<a href="#">(page 77)</a>
2	Modem connector	<a href="#">(page 55)</a>
3	Monitor/VGA connector	<a href="#">(page 61)</a>
4	Printer connector	<a href="#">(page 73)</a>
5	Ventilation slot	<a href="#">(page 16)</a>
6	1 USB 2.0 port (High-speed/Full-speed/Low-speed)	<a href="#">(page 72)</a>

## Bottom

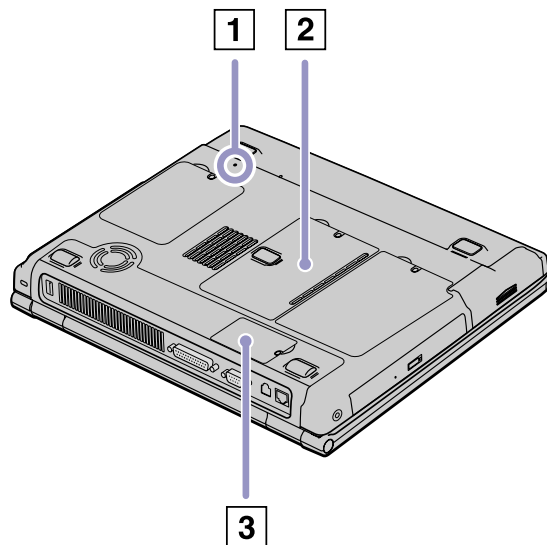

1	Reset button	/
2	Memory module cover	<a href="#">(page 96)</a>
3	Modem module cover	<a href="#">(page 55)</a>

## Connecting a power source

You can use either an AC adapter or a rechargeable battery pack as a power source.

### Using the AC adapter

To use the AC adapter, proceed as follows:

- 1 Plug the cable attached to the AC adapter (1) into the DC In connector (2) on the computer.
- 2 Plug one end of the power cord (3) into the AC adapter.
- 3 Plug the other end of the power cord into an AC outlet.

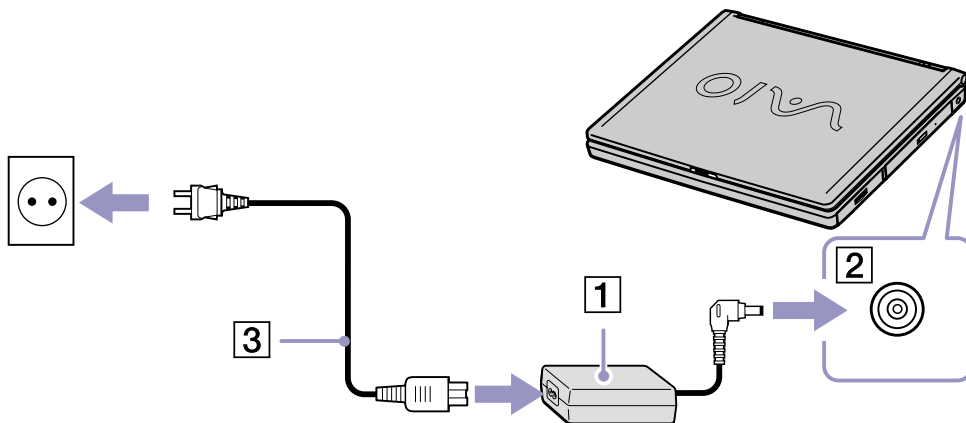

Use your notebook only with the supplied AC adapter.

To disconnect your notebook completely from mains voltage, unplug the AC adapter.

Make sure that the socket outlet is easily accessible.

## Using the battery pack

You can use one battery as a source of power.  
The battery pack supplied with your computer is not fully charged at the time of purchase.

### Inserting the battery pack

To insert the battery pack, proceed as follows:

- 1 Open the cover of the battery bay.

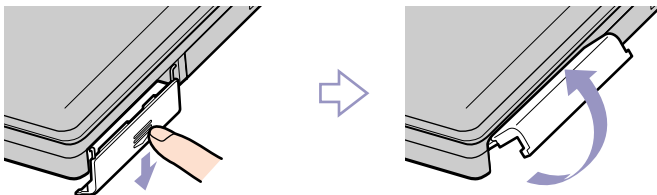

- 2 Insert the battery pack with the label facing down into the battery bay on the right side of the computer.

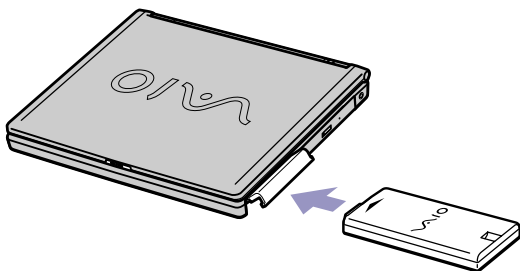

- 3 Close the cover of the battery bay until it clicks.

 When the computer is directly connected to AC power and has a battery pack inserted in the battery bay, it uses power from the AC outlet.

### Charging the battery pack

To charge the battery pack, proceed as follows:

- 1 Connect the AC adapter to the computer.
- 2 Insert the battery pack.

The computer automatically charges the battery (the battery indicator light flashes in a double blink pattern as the battery charges). When the battery is 85% full, the battery indicator light turns off. This process takes approximately 2.5 hours if your notebook is on. To charge the battery completely, continue charging for an additional hour.

 Indicates the status of the battery pack in the battery bay.

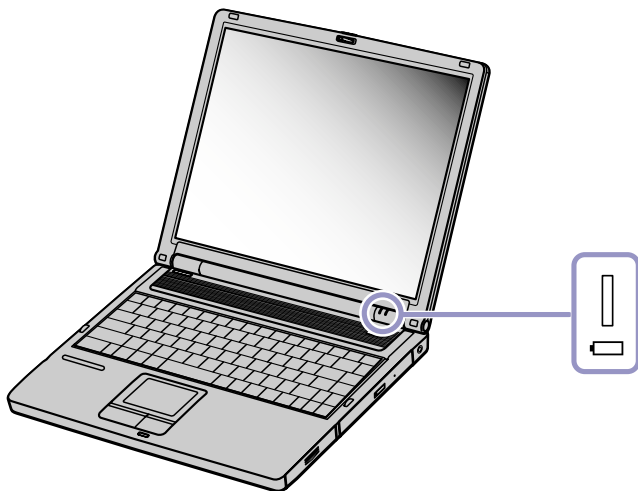

#### *battery indicator light status*    *meaning*

On	The computer is using battery power.
Single blink	The battery is running out of power.
Double blink	The battery is charging.
Off	The computer is using AC power.

 Keep the battery pack in the computer while it is directly connected to AC power. The battery pack continues to charge while you are using the computer.

If the battery level falls below 10%, you should either attach the AC adapter to recharge the battery or shut down your computer and insert a fully charged battery.

The battery pack supplied with your computer is a lithium ion battery and can be recharged any time. Charging a partially discharged battery does not affect battery life.

The battery indicator light is on while you use the battery pack as a power source. When the battery life is nearly depleted, both the battery and power indicators start flashing.

For some software applications and some peripheral devices, your computer may not enter **Hibernate** mode even when battery life is low. To avoid loss of data when using battery power, you should save your data frequently and manually activate a power management mode, such as **Standby** or **Hibernate**.

When the computer is directly connected to AC power and has a battery pack inserted in the battery bay, it uses power from the AC outlet.

### Removing the battery pack

To remove the battery pack, proceed as follows:

- 1 Turn off the computer.
- 2 Open the cover of the battery bay.
- 3 Pull out the battery pack.

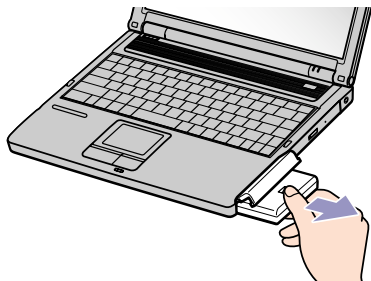

- 4 Close the cover of the battery bay.



You may lose data if you remove the battery pack while the computer is on and not connected to the AC adapter or if you remove the battery while the computer is in **Standby** mode.



## Starting your notebook

To start your computer, proceed as follows:

- 1 Slide the LCD lock lever (1) in the direction of the arrow, and lift the cover.
- 2 Press the power button (2) of the computer until the green power indicator (3) light turns on.
- 3 If necessary, adjust the brightness on the LCD display. To increase the brightness, hold down the **<Fn>** key and **<F5>** and press the up or right arrow key. To decrease brightness, hold down the **<Fn>** key and **<F5>** and press the left or down arrow key.

 If you press the power button for more than four seconds, the computer will turn off.

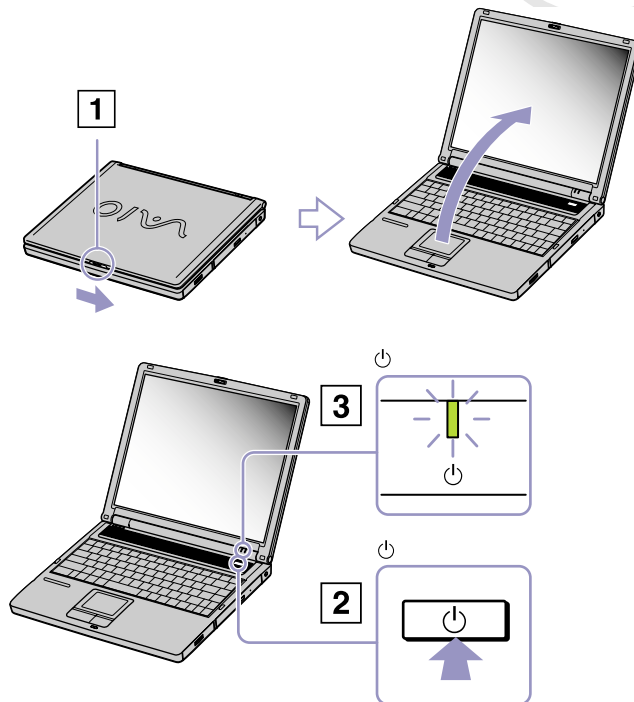

## Setting up your notebook with Sony Notebook Setup

The **Sony Notebook Setup** utility allows you to consult system information, specify preferences for system behaviour, and set up password protection for your VAIO notebook.

To use Sony Notebook Setup, proceed as follows:

- 1 Click the **Start** button on the **Windows®** taskbar.
- 2 In **All Programs**, select **Sony Notebook Setup** and then click **Sony Notebook Setup**. The **Sony Notebook Setup** window appears.

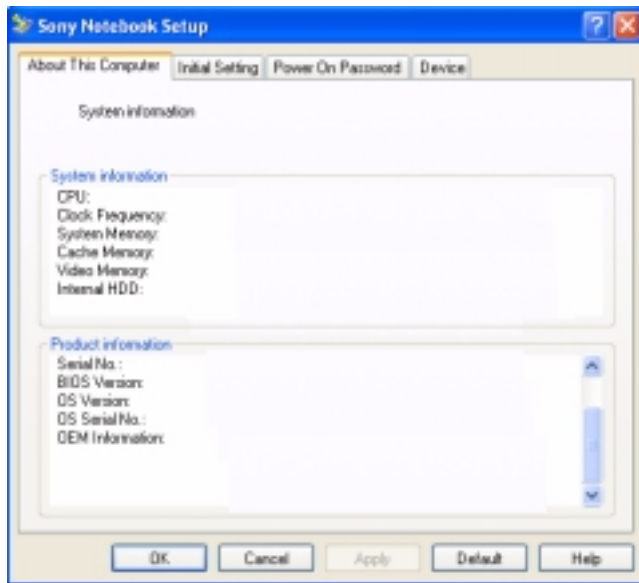

Tab	Description
About This Computer	Displays system information, including memory capacity, serial number, and BIOS version.
Initial Setting	Selects the drive and device order you wish to use for loading the operating system. You can specify the hard drive as well as other drives inserted into your computer. You can change the volume of the sounds played while the operating system is loading.
Power On Password	Sets the password to secure your computer. If you use this option, remember the password at all times. If you forget the password, you cannot change this setting anymore, and you will not be able to start your computer.
Device	Disables ports or devices to release resources to the system. To change the port settings, select a port and click <b>Settings</b> in the <b>Device</b> tab.

- 3 Select the tab for the item you want to change.
- 4 Once finished, click **OK**.  
The item has been changed.

 For more information about each option, click Help on the **Sony Notebook Setup** screen to display the help file.  
If you open **Sony Notebook Setup** as a limited user, then only the **About This Computer** tab will be visible.

## Changing the video memory size

You can change the video memory size of your computer in the BIOS (Basic Input/Output System). Changing the video memory size will automatically modify the main memory size of your computer.

Increasing the video memory size will speed up graphically intensive applications, such as image editors or computer games. However, the higher you choose to set the video memory, the less conventional memory you will have. Less conventional memory may slow down switching between open applications.

To change the video memory size of your computer, proceed as follows:

- 1 Turn on you computer.  
Make sure that no peripheral devices (apart from the AC adapter) are connected.
- 2 When the Sony logo appears, press the **<F2>** key.  
The BIOS setup window appears.
- 3 Choose the **Advanced** tab by using the right arrow key.
- 4 On the **Advanced** tab sheet, choose **UMA Video Memory size** by using the down arrow key.
- 5 Press **Enter**.  
A pop-up window appears, containing three memory sizes: 32 MB, 64 MB and 128 MB.
- 6 In the pop-up window, choose a memory size.
- 7 Press **Enter**.  
The memory size is changed.
- 8 To quit the BIOS setup window, press the **<Esc>** key.
- 9 Choose **Exit (save Changes)** and press **Enter**.  
A pop-up window appears, containing the question: **Save configuration and exit now?**
- 10 Choose **Yes** to save you changes and exit.  
Your computer will restart.  
-or-  
choose **No** to return to the BIOS setup window.



You can check the video memory size on the **About the Computer** tab sheet in VAIO Notebook Setup.

## Shutting down your notebook

It is important that you shut down your computer properly so you do not lose unsaved data.

To shut down your computer, proceed as follows:

- 1 Click the **Start** button on the Windows® taskbar.
- 2 Click **Turn Off Computer**.  
The **Turn off computer** dialog box appears.
- 3 Select **Turn Off**.  
Wait for your computer to turn off automatically.  
The power indicator turns off.
- 4 Turn off any peripheral connected to your computer.

 Respond to any prompts warning you to save documents or to consider other users.

If you are unable to shut down your computer:

- Close all software in use.
- If applicable, remove the PC Card. To do so, double-click the **Safely Remove Hardware** icon in the taskbar. Select the hardware you want to unplug and click **Stop**.
- Disconnect any USB devices.
- Press the <Ctrl>+<Alt>+<Delete> keys at the same time. If you have not changed the default settings, the **Task Manager** will appear. Select **Shut Down** then **Turn Off**.
- Press <Alt>+<F4> and select **Turn Off** from the screen that appears.



If this does not work, you can press the power button for more than four seconds. This will shut down the computer. This operation may result in data loss.

If you are not using the computer for a short period of time, you can save power by using the **Hibernate** mode. To enter **Hibernate** mode, press the <Fn> and <F12>-keys simultaneously. For more details on power management, see **Using power saving modes** (page 57).

## Using the keyboard

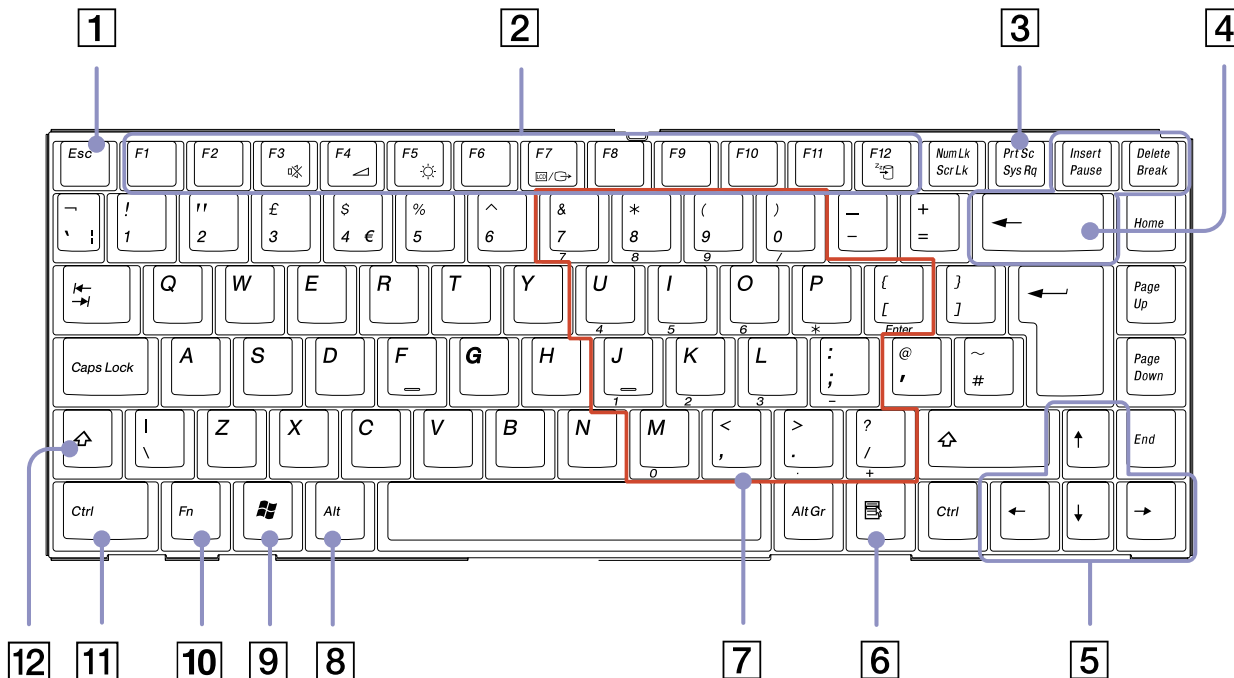
Your keyboard is very similar to a desktop computer's, but has additional keys that perform specific notebook-related tasks.













<i>Keys</i>	<i>Descriptions</i>
Escape key (1)	The <b>&lt;Esc&gt;</b> (Escape) key is used to cancel commands.
Function keys (2)	The twelve function keys along the top of the keyboard are used to perform designated tasks. For example, in many applications, <b>&lt;F1&gt;</b> is the <b>Help</b> key. The tasks associated with each function key may vary from one application to the other.
Print Screen key (3)	The <b>&lt;Print Screen&gt;</b> key takes an electronic snapshot of the screen and moves it to the Windows® <b>Clipboard</b> . You can then paste the screenshot into a document and print it.
Correction keys (4)	The <b>&lt;Insert&gt;</b> , <b>&lt;Back Space&gt;</b> and <b>&lt;Delete&gt;</b> keys enable you to make corrections.
Navigation keys (5)	These keys enable you to move the cursor on the screen.
Application key (6) 	The <b>Application</b> key displays a shortcut menu; pressing this key is equivalent to clicking the right mouse button.
Numeric keypad area (7)	Contains the keys found on a typical calculator. Use the numeric keypad area to type numbers or to perform mathematical calculations such as addition and subtraction. Note that you must press the <b>&lt;Num Lock&gt;</b> key to activate the numeric keypad. When you do so, the Num Lock light illuminates.
Operator keys (8-11-12)	Several keys are always used with at least one other key: <b>&lt;Ctrl&gt;</b> , <b>&lt;Alt&gt;</b> , and <b>&lt;Shift&gt;</b> . When held down with another key, the <b>&lt;Ctrl&gt;</b> (Control) and <b>&lt;Alt&gt;</b> (Alternate) keys offer another way to execute commands. For example, in many applications, instead of choosing the <b>Save</b> command from a menu, you can hold down <b>&lt;Ctrl&gt;</b> and press <b>&lt;S&gt;</b> (referred to as <b>&lt;Ctrl&gt;+&lt;S&gt;</b> ). The <b>&lt;Shift&gt;</b> key is used to produce capital letters or special symbols such as @ and \$.
Windows® key (9) 	The key with the <b>Windows®</b> logo displays the Windows® Start menu; it is equivalent to clicking the <b>Start</b> button on the taskbar.
<b>&lt;Fn&gt;</b> key (10)	The <b>&lt;Fn&gt;</b> key is used in combination with other keys to execute commands.

## Combinations and functions with the Windows® key



### Combinations





### Functions

 + <F1>	Displays the Windows® <b>Help and Support Center</b> .
 + <Tab>	Switches the selected button on the taskbar.
 + <D>	Displays the desktop.
 + <E>	Displays <b>My Computer</b> .
 + <F>	Displays the <b>Search Results</b> window to find a file or folder. This is equivalent to selecting <b>Search</b> from the <b>Start</b> menu.
 + <Ctrl> + <F>	Displays the <b>Search Results - Computers</b> window where you can locate other computers.
 + <M>	Minimizes all displayed windows.
<Shift> +  + <M>	Returns all minimized windows to their previous size.
 + <R>	Displays the <b>Run</b> window. This is equivalent to selecting <b>Run</b> from the <b>Start</b> menu.
<Fn> +  + <Insert>	Displays the <b>System Properties</b> window. This is equivalent to double-clicking the <b>System</b> icon in the <b>Control Panel</b> or right-clicking <b>My Computer</b> (then click <b>Properties</b> ) from the <b>Start</b> menu.

















## Indicators

Indicator	Functions
Power 	<b>Power on:</b> lights green. <b>Standby mode:</b> flashes amber.
Battery 	Indicates the status of the battery inserted in the battery bay on the left side of the computer.
Memory Stick™ 	Turns on when the <b>Memory Stick™</b> is in use. Turns off when the <b>Memory Stick™</b> is no longer in use.

Light	On	Off
Hard disk 	Data is read from or written to the hard drive.	The hard drive is not being accessed.
Num Lock 	Turns on when the number keys in the numeric keypad are active.	Turns off when the alphanumeric character keys in the keypad area are active.
Caps Lock 	Turns on when the characters appear in uppercase as you type. The <Shift> key lowers the case of typed letters when <b>Caps Lock</b> is on.	Turns off when the characters appear in lowercase as you type (unless you hold down the <Shift> key).
Scroll Lock 	Turns on when the screen scrolls differently (depends on the application, no effect in many applications).	Turns off when the information moves across the display normally.

## Combinations and functions with the <Fn> key

Combinations/ Feature	Functions
<Fn> +  (F3): speaker switch	Toggles the built-in speaker on and off.
<Fn> +  (F4): speaker volume	Adjusts the built-in speaker volume. To increase volume, press <Fn>+<F4> and then  or  . To decrease volume, press <Fn>+<F4> and then  or  .
<Fn> +  (F5): brightness control	Adjusts the brightness of the LCD. To increase lightness intensity, press <Fn>+<F5> and then  or  . To decrease lightness intensity, press <Fn>+<F5> and then  or  . You can see the brightness changing immediately on the screen.
<Fn> +  (F7)*: switch to the external display	Toggles between the LCD, external device (monitor or TV depending on which device is connected) and both LCD and external device. This function can only be used by the first user to log in. It will not work under a second user account.
<Fn> +  (F12): Hibernate	Puts the system into <b>Hibernate</b> mode, the lowest level of power consumption. To return the system to the active state, press the power button. For details on power management, see the section <b>Using power saving modes (page 57)</b> .

 \* This function can only be used by the first user to log on. It will not work if you have switched to another user account. If another user wants to display on an external monitor or TV, use the monitor properties to switch to an external monitor or TV.

Some functions are not available until Windows® is launched.

## Using the touchpad

The keyboard contains a cursor-pointing device, your touchpad (1). You can point to, select, drag, and scroll objects on the screen using the built-in touchpad.

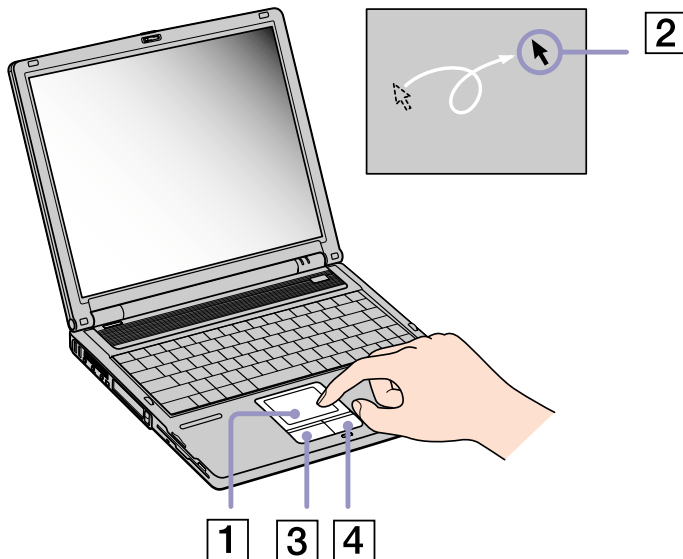

### Action

### Description

Point	Slide one finger on the touchpad to place the pointer (2) on an item or object.
Click	Press the left button (3) once.
Double-click	Press the left button twice.
Right-click	Press the right button (4) once. In many applications, this action displays a shortcut menu.
Drag	Slide one finger while pressing the left button.
Scroll	Move your finger along the right edge of the touchpad to scroll vertically. Move your finger along the bottom to scroll horizontally (the scroll function is available only with applications that support a touchpad scroll feature).

## Using the disc drive

Your computer is equipped with either a DVD-RW drive or a CD-RW/DVD-ROM combined drive. Check the printed **Specifications** sheet for details on your model.

See the glossary at the end of this guide for more information on CD-RW and DVD-RW.

To insert a disc, proceed as follows:

- 1 Turn on the computer.
- 2 Press the eject button (1) to open the drive.  
The tray slides out.

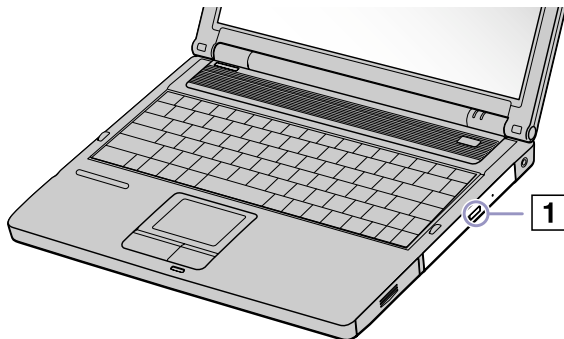

- 3 Place a disc in the middle of the tray with the label side facing up until the disc clicks into place.

4 Close the tray by pushing it gently.

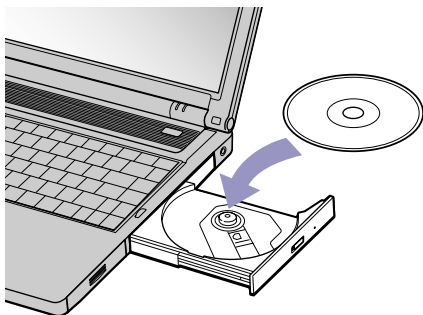

When the computer is in **Standby** or **Hibernate** mode, you cannot insert or remove a disc.

Be sure to seat the disc firmly over the disc drive hub fingers. If you do not seat the disc firmly, you could damage your disc drive and you may not be able to open the tray.

When you finish using a disc, wait until the LED indicator turns off and then press the eject button to remove the disc.

If the disc does not come out when you press the eject button, go to **Windows Explorer** or **My Computer**. Select the drive, click the right button of your mouse and select **Eject** to open the disk tray. If it still does not work, turn off the computer and insert a thin, pointed object (e.g. a paper clip) into the manual eject hole.

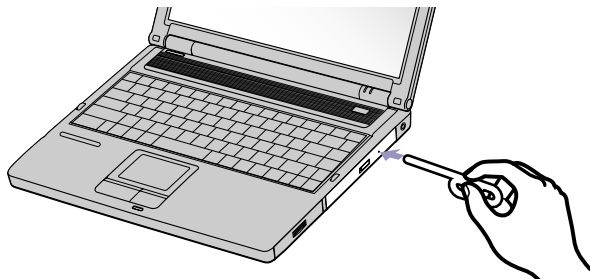

### Using the disc recording function\*

Your notebook is equipped with a CD-RW/DVD-ROM or a DVD-RW drive.

To burn CDs, you can use DVD/CD-RW and/or DVD/CD-Rs\*\*:

- ❑ The **-RW** (-ReWriteable) disc is a data memory medium that can be used to write, erase and rewrite a program or other data.
- ❑ The **-R** (-Recordable) disc is a data memory medium that can be used to write a program or other data, but once only.

To achieve optimum performance when writing data on a CD-RW disc, follow these recommendations :

- ❑ To make a CD-R's data readable on a CD-ROM drive, you need to close the session when you eject it. To complete this process, follow the instructions included with your software.
- ❑ Only use circular discs. Do not use discs with any other shape (star, heart, card, etc.), as this may damage the CD-RW drive.
- ❑ Do not strike or shake the computer while writing data to a disc.
- ❑ For optimal writing speed, deactivate the screensaver before writing data to a disc.
- ❑ Memory-resident disc utilities may cause unstable operation or data loss. Deactivate these utilities before writing data to a disc.
- ❑ Your VAIO notebook does not support 1x writing speed.
- ❑ When using your software application to burn CDs, be sure to exit and close all other applications.
- ❑ Never touch the surface of the disc. Fingerprints and dust on the surface of a disc may cause writing errors.
- ❑ Do not put your VAIO notebook into a power saving mode while using the pre-installed software and while using the CD burning software.

\* Ultra Speed CD-RW is not supported.

\*\* DVD or CD depends on your type of disc drive.

## Using the DVD function

To achieve optimum performance when playing DVD-ROM discs, you should follow these recommendations.

- ❑ You can play DVDs using the DVD-ROM or DVD-RW\* drive and the WinDVD for VAIO software. See the help file on the WinDVD for VAIO software for details.
- ❑ Close all open applications before playing a DVD-ROM movie.
- ❑ Do not use resident disc utilities or resident utilities to speed up the access of discs, because they may cause the system to become unstable.
- ❑ Make sure that the screensaver is deactivated.
- ❑ Region codes indicators are labelled on the DVD discs to indicate in which region and on what type of player you can play the disc. Unless a '2' (Europe belongs to region '2') or 'all' (this means that you can play this DVD everywhere in the world) is labelled on your DVD disc or on the packaging, you cannot play the disc on this player.
- ❑ Do not try to change the region code settings of the DVD-ROM or DVD-RW\* drive. Any difficulties caused by changing the region code settings of the DVD-ROM or DVD-RW\* drive are out of warranty.
- ❑ When a TV is connected, a part of the video screen will not appear with the factory settings. Adjust the display resolution to 800 x 600 or 1024 x 768.
- ❑ When playing a DVD movie, you can use the <Fn>+<F7>-combination to view the movie at the same time on the notebook display and a connected external display. See **Using the Dual Display function (page 67)** for more details on customizing the display.

\* Depending on your model. Read the printed **Specifications** document for more information.

## Using the floppy disk drive

Your computer is equipped with a floppy disk drive.

### Inserting a floppy disk

To insert a floppy disk, proceed as follows:

- 1 Hold the disk (1) with the label side facing up.
- 2 Gently push the disk into the floppy disk drive (2) until it clicks into place.

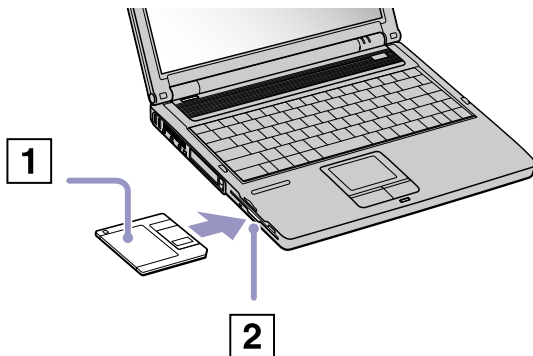



### Removing a floppy disk

To remove a floppy disk, proceed as follows:

- 1 Wait until the LED indicator (1) turns off.
- 2 Press the eject button (2) to remove the floppy disk.

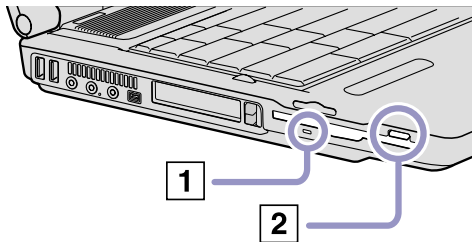

 Do not press the eject button when the LED indicator is turned on. Otherwise, data may be lost.

## Using PC Cards

This computer has a PC Card slot that supports Type I, II and III PC Cards. PC Cards allow you to connect portable external devices.

You do not need to shut down your computer when inserting a PC Card.

### Inserting a PC Card

To insert a PC Card, proceed as follows:

- 1 Insert the PC Card into one of the PC Card slots with the label facing upwards.

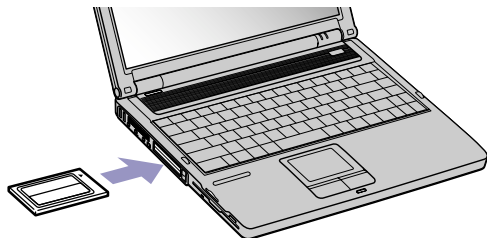

- 2 Gently push the PC Card slot into the connector.  
The PC Card is automatically detected by your system.  
The **Safely Remove Hardware** icon appears in the system tray.

 Some devices may not function properly if you repeat **Returning to Normal mode** from **Standby** mode or **Hibernate** mode.  
The computer will return to its original state if you restart it.

The PC Card slots can accommodate two Type I or II PC Cards (at the same time) or one Type III PC Card. These slots are compatible with CardBus ports.

Use the lower slot for Type III PC Cards.



Some PC Cards may require you to disable idle devices when using the PC Card.

Make sure you use the most recent software driver provided by the PC Card manufacturer.

If an "!" mark appears in the **Device Manager** dialog box, remove the software driver and then reinstall it.

You do not need to shut down the computer before inserting or removing a PC Card.

Do not force a PC Card into the slot. It may damage the connector pins. If you have difficulty inserting a PC Card, check that you are inserting the PC Card in the correct direction. See the manual supplied with your PC Card for more information on use.

For some PC Cards, if you alternate between **Normal** power operation and **Standby** or **Hibernate** power management modes while the card is inserted, you may find that a device connected to your system is not recognised. Reboot your system to correct the problem.

Do not carry your notebook while touching the head of a PC Card, as pressure or shock may damage the connector pins.

It is recommended that you always use the same slot for a PC Card as switching slots can cause problems with some PC Cards.

## Removing a PC Card

Follow the steps below to remove the PC card while your computer is on. If it is not removed correctly, your system may not work properly. If you want to remove a PC Card when your computer is off, skip steps 1 to 7.

To remove a PC Card, proceed as follows:

- 1 Double-click the **Safely Remove Hardware** icon in the taskbar.  
The **Safely Remove Hardware** dialog box appears.
- 2 Select the hardware you want to unplug.
- 3 Click **Stop**.
- 4 In the **Stop a Hardware device** dialog box, confirm that the device can be safely removed from the system.
- 5 Click **OK**.  
You get a message saying that it is safe to remove the device.
- 6 Click **OK**.
- 7 Click **Close**.
- 8 Press the PC Card release button so that it pops out.
- 9 Push the PC Card release button to eject the card.
- 10 Gently grasp the card and pull it out.
- 11 If the PC Card release button is still out, push it back in to close the front panel cover.

 If you unplug the PC Card from the computer when this is still turned on, your system might crash and you might lose data that you did not save before. Before you remove the PC Card, right-click the PC Card icon in the taskbar and close the card. Close any applications that use the PC Card before removing the card. Otherwise, data may be lost.

While the card is inserted, your computer may not enter the **Hibernate** power management mode. It may enter **Standby** mode. It is recommended that you remove the card before you manually enter **Hibernate** mode, or when your computer is set to enter **Hibernate** automatically while using a battery as the source of power.

Some PC Cards or their functions may not be compatible with this computer.

## Using Memory Stick™

Your VAIO computer is designed to support the Memory Stick™. The Memory Stick™ is a compact, portable, and versatile device especially designed for exchanging and sharing digital data with compatible products. Because it is removable, it can be used for external data storage.

Use the flash memory technology to download anything that can be converted into digital data, such as pictures, music, words, sounds, movies and photographs.

Foreseen as the universal data storage device of the future, the Memory Stick™ can already be used with an ever-increasing range of compatible products, including:

- ❑ Audio systems
- ❑ Visual devices
- ❑ VAIO products
- ❑ CLIE handhelds
- ❑ Mobile phones.

There are currently three different types of Memory Stick™ supported by your VAIO:

- ❑ The generic Memory Stick™, coloured blue.
- ❑ The MagicGate Memory Stick™, coloured white.
- ❑ The Memory Stick PRO™.

 You can purchase Memory Sticks™ from the Sony Style website (<http://www.sonystyle-europe.com>), or from your local Sony dealer.

## Why Memory Stick™?

Sony's vision is to expand the world of communication, promoting the portability of digital data. The Memory Stick™ is the resulting medium, through which digital devices can be instantly connected. With it, you can download data from any compatible device, then transfer it to another in a single and instant transfer.

The main advantages of the Memory Stick™ are its:

- ❑ **Compactness:** with dimensions of just 21.5 mm (W) x 2.8 mm (H) x 50 mm (D), compatible products can also be small, lightweight and attractive in their design.
- ❑ **Capacity:** Its data capacity far exceeds that of a floppy disk.
- ❑ **Security:** its lock option means you can protect your data from accidental erasure.
- ❑ **Versatility:** memory capacity ranges from 4 MB up to 128 MB (the equivalent capacity of 88 floppy disks) and up to 1GB for Memory Stick PRO™.
- ❑ **Reliability:** by way of protecting the hardware and its contents, the number of terminals is reduced to only 10 pins. This, and the overall robust structure of the stick, gives it a longer lifespan than other storage devices.
- ❑ **Durability:** the same Memory Stick™ can be used tens of thousands of times.
- ❑ **Forward compatibility:** the Memory Stick's™ current format is designed to be compatible with future products and higher capacity Memory Sticks™.

## Generic Memory Stick™

The original Memory Stick™, blue in colour, can be used to record image data taken with digital still cameras, etc. or data from the PC. With it, you can record, play back and transfer various kinds of data at any given time.



Because it is easy to remove and transport safely, you can use Memory Stick™ anywhere by inserting it into any compatible device to transfer and share the information you have saved.

For you, this means you can expand the capabilities of your VAIO computer in the following scenarios:

- ❑ With your still digital camera, share your holiday pictures instantly by e-mail.
- ❑ From your handycam to your VAIO, make the most of your captured moments with the VAIO's movie editing tools.
- ❑ Carry pictures on you by copying image files from the Internet to your VAIO or to your CLIE handheld.
- ❑ With your voice recorder, add your voice to e-mails so your tone is never misunderstood.

The blue Memory Stick™ is currently available with a 4, 8, 16, 32, 64 or a 128 MB memory (the equivalent capacity of 88 floppy disks).

 Generic Memory Sticks™ cannot be used with the Memory Stick™ Walkman, or with data that is protected by copyright.

## MagicGate Memory Stick™

The MagicGate Memory Stick™, white in colour, records PC and image data just like its blue counterpart; the difference is it uses the MagicGate copyright protection technology.



With this type of Memory Stick™, also called the MG Memory Stick™, you can enjoy the following features:

- 32, 64 and 128 MB capacity versions.
- Storage of up to 120 minutes of audio data.
- Download and save:
  - digital music
  - pictures
  - movies, and more.
- Combine data files to add music to your home movies, for example.
- Transfer and share data between several digital products.
- MagicGate Copyright Protection Technology.
- SDMI (Secure Digital Music Initiative) Compliance.
- SonicStage software.

So that you further distinguish a MagicGate Memory Stick™ from a generic one, look for:

- the **MAGICGATE** logo printed on it
- a protruding dot located on the back.



 MagicGate is a copyright protection technology that complies with the standards set by SDMI (Secure Digital Music Initiative, an organization working to draw up industry standard specifications in order to protect copyrights of digital music).

The **MAGICGATE** logo indicates the copyright protection system devised by Sony. It is not meant to guarantee compatibility with other media.

### *MagicGate*

MagicGate refers to the copyright protection technology used by the MagicGate Memory Stick™ and other MagicGate Memory Stick™ compatible devices.

The Memory Stick™ Walkman and MagicGate Memory Stick™ work together to check the data and ensure it complies with copyright protection.

If no problems are detected, the data is exchanged in encrypted form; if authentication is not passed, data cannot be exchanged or played back.

### *SonicStage*

SonicStage uses copyright protection technology designed to manage the digital music content downloaded to the PC from CDs, the Internet and/or other sources.

Software installed on the PC records music content in encrypted form onto the hard disk. As well as allowing you to enjoy music on the PC, this technology protects against unauthorized distribution on the Internet. Since it is compatible with MagicGate, you can use SonicStage to transfer music that you have downloaded onto your PC to your white MG Memory Stick™, and playback on other MagicGate-equipped devices and media.

### *Copyright protection*

People who create artistic works such as music are entitled to a "copyright", meaning that they have exclusive rights to dictate how their work is used. When they are created, artistic works are automatically protected by a copyright without having to submit notification or registration, and may not be used without the permission of the person who created the work.

In the music world, however, illegal acts of distributing music without the permission of the artist,

particularly on the Internet, have recently been on the increase. That is why the Recording Industry Association of America (RIAA) took the initiative to organize a forum called Secure Music Digital Initiative (SDMI) to study technology for protecting copyrights during the electronic distribution of music. Sony offers the MagicGate Memory Stick™ and Memory Stick™ Walkman with a copyright protection function that complies with SDMI standards, thereby providing an environment where individuals can record and enjoy third-party music data without worrying about copyright infringement.

 Literary works that are recorded by individuals are permitted for private usage only.

### *Compatible devices*

There are nearly 80 Memory Stick™-enabled products on the market or announced for introduction worldwide, ranging from camcorders and portable music players to voice recorders and many other electronic devices.

You can currently use Memory Sticks™ with the following Sony products:

#### **Visual:**

- Cybershot digital camera
- Mavica digital camera
- PC, TRV and VX series digital video cameras
- LC data projector

#### **Audio:**

- MS Walkman
- MS Hi-fi system
- Network Walkmans
- Voice recorders



**Other:**

- VAIO notebooks
- VAIO desktops
- CLIE Handheld Entertainment Organiser
- Sony mobile phones
- Digital printers
- AIBO the Sony Entertainment Robot

To find out more about the products available in your country, go to:

<http://www.sonystyle-europe.com>

## Memory Stick PRO™

The Memory Stick PRO™ records PC and image data just like its blue and white counterpart. However, the Memory Stick PRO™ provides you with a capacity of up to 1 GB. It also exists in 256MB and 512 MB.

A 1 GB Memory Stick PRO™ card enables users to enjoy a staggering 6 hours of MPEG4 (384 Kbps) moving images or 24 minutes of DVD quality MPEG2 video. This equates to around sixteen audio CDs, assuming 64 MB per CD, or 360 JPEG images in 5.0 Megapixel quality, more than ten rolls of 24/36 film.



### Compatible devices

You can currently use the Memory Stick PRO™ with the following Sony products:

#### Visual:

- Cyber-shot DSC-F717, -F77 and FX77 digital camera
- DPP-EX5 and -EX7 digital photo printers
- Digital camcorders DCR-TRV355, -TRV22, -TRV33, -TRV60 and -TRV80

#### Other:

- MSAC-US20 USB Memory Stick adapter
- MSAC-US70 USB optical mouse and Memory Stick adapter
- MSAC-PC3 PC Card Memory Stick adapter
- MSAC-US7 USB optical mouse and Memory Stick adapter
- MSAC-US2 USB Memory Stick adapter

Devices that can be upgraded to accept the Memory Stick PRO™ media via a software patch are:

- Sony CLIÉ PEG-NX70V handheld. Detailed information will be available on [www.clie-link.com](http://www.clie-link.com).
- Some VAIO models. Detailed information will be available on [www.vaio-link.com](http://www.vaio-link.com).

## Write-protecting a Memory Stick™

**Memory Sticks™** are designed with an erasure prevention switch to protect valuable data from accidental erasure or overwriting.

Move the tab to the right or left\* to set or release write-protection. When the erasure prevention switch is off, data can be saved on the Memory Stick™. When the erasure prevention switch is on, data can be read from but not saved on the Memory Stick™.

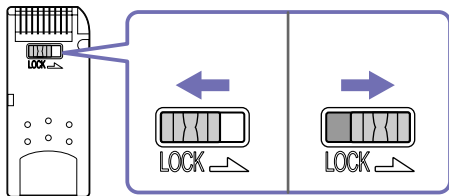

\* The 128 MB Memory Stick™ has a vertical lock.

## Inserting a Memory Stick™

There are 2 ways you can insert a Memory Stick™ in your notebook:

- ❑ Using the Memory Stick™ slot;
- ❑ Using one of the PC Card slots. To do this, you need an optional PC Card adapter.

You can only insert one Memory Stick™ at a time.

To insert a Memory Stick™ using the Memory Stick™ slot, proceed as follows:

- 1 Once you have stored your data from your digital device, insert the Memory Stick™ with the arrow facing up and toward the Memory Stick™ slot.
- 2 Carefully slide the Memory Stick™ into the slot until it clicks in place. The Memory Stick™ is automatically detected by your system and appears in your **My Computer** window as a local drive, under the appropriate letter (depending on the configuration of your computer).

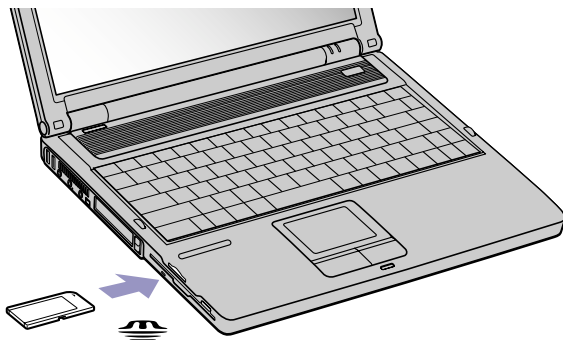

- ! Hold the Memory Stick™ with the arrow pointing in the correct direction when you insert it into the slot. To avoid damaging the computer or the Memory Stick™, do not force the Memory Stick™ into the slot if it does not insert smoothly.

### *Removing a Memory Stick™*

To remove a Memory Stick™ using the Memory Stick™ slot, proceed as follows:

- 1** Check that the access light is off.
- 2** Push the Memory Stick™ in towards the notebook.  
The Memory Stick™ ejects.
- 3** Pull the Memory Stick™ out of the slot.

 Always remove the Memory Stick™ gently, or it may pop out unexpectedly.

It is recommended that you remove the Memory Stick™ before shutting down the computer.

## Using the modem

Your notebook is equipped with an internal modem. You need to connect a phone line to take advantage of online services and the Internet, to register your computer and software online, and to contact VAIO-Link.

To connect a phone line, proceed as follows:

Plug one end of the phone cable (1) into the phone line jack on the computer and plug the other end into the wall jack (2).

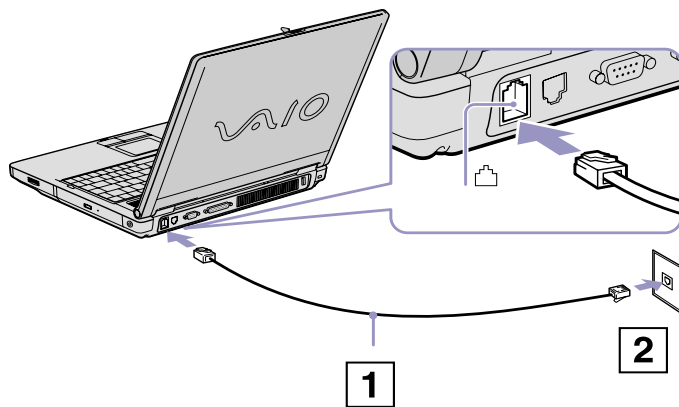

 Your computer cannot be connected to a coin-operated telephone, and may not work with multiple phone lines or a private branch exchange (PBX). If you connect the modem to a parallel connected phone line, the modem or the other connected device may not function properly. Some of these connections may result in excess electrical current and could cause a malfunction in the internal modem. Only DTMF (Dual Tone Multi Frequency) signalling (tone dialling) is supported.

A country-specific phone plug is supplied with your VAIO notebook, allowing you to plug the phone line into the wall jack. We recommend you to use the supplied plug, because the usage of any other phone plug can decrease the connection quality.

Before using the modem, it will be necessary to select the country where you are actually using it. The detailed procedure for selecting your present location is explained in **Configuring your modem** in the Software User Guide.



### Using the correct phone plug

If there are two phone plugs in the box, make sure you use the correct one for the country you are in, as follows:

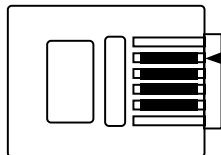
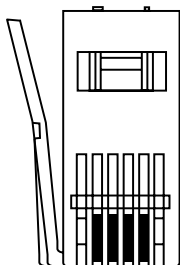

**UK:** The connector can be identified by its cuboid shape and flat pins.

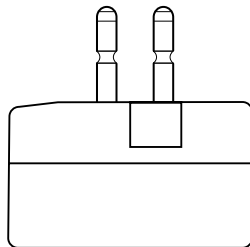
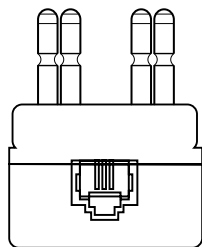

**The Netherlands:** The connector can be identified by its protruding pins.

## Using power saving modes

When you use a battery as the source of power for your computer, you can take advantage of power management settings to conserve battery life. In addition to the normal operating mode, which allows you to turn off specific devices, your computer has two distinct power saving modes: **Standby** and **Hibernate**. When using battery power, you should be aware that the computer automatically enters **Hibernate** mode when the remaining battery charge drops below 5 percent, regardless of the power option settings you select.



If the battery level falls to below 10 percent, you should either attach the AC adapter to recharge the battery or shut down your computer and insert a fully charged battery.

## Using Normal mode

This is the normal state of your computer when it is in use. The green power indicator light is on in this mode. To save power, you can turn off a specific device such as the LCD or the hard disk.

## Using Standby mode

**Standby** mode turns off the LCD screen and sets the hard disk and the CPU to a low power consumption mode. The amber power light flashes in this mode.

To activate Standby mode, proceed as follows:

Go to **Start/Turn Off Computer** and press **Stand By**.

To return to Normal mode, press any key.



If you press the power button for more than four seconds, the computer will switch off automatically.

When the computer is in **Standby** mode, you cannot insert a disc.

The computer comes out of **Standby** mode quicker than out of **Hibernate** mode.

**Standby** uses more power than **Hibernate**.

## Using Hibernate mode

The state of the system is saved on the hard disk and power is turned off. The power indicator light is off in this mode.

To activate Hibernate mode, proceed as follows:

- 1 Go to **Start** and click **Turn Off Computer**.
- 2 Hold down the **<Shift>** key and press **Hibernate**.

Alternatively,

Press **<Fn>+<F12>**.

To return to Normal mode, press the power button. The computer returns to its previous state.

 If you press the power button for longer than 4 seconds, the computer will turn off.

When the computer is in **Hibernate** mode, you cannot insert a disc.

It takes more time to return to normal mode from **Hibernate** mode than from **Standby** mode.

**Hibernate** mode uses less power than **Standby** mode.

Do not move the notebook until its power indicator turns off.

## Connecting peripheral devices

You can add functionality to your computer by connecting or using any of these peripherals. Before you connect peripherals, turn off the computer and all peripherals. Connect the power cord only after connecting all cables. Turn on the computer only after turning on all peripherals.

- ❑ Connecting an external display ([page 60](#))
- ❑ Selecting display modes ([page 66](#))
- ❑ Using the Dual Display function ([page 67](#))
- ❑ Connecting external speakers ([page 70](#))
- ❑ Connecting an external microphone ([page 71](#))
- ❑ Connecting a Universal Serial Bus (USB) mouse ([page 72](#))
- ❑ Connecting a printer ([page 73](#))
- ❑ Connecting an i.LINK™ device ([page 75](#))
- ❑ Connecting to a network (LAN) ([page 77](#))



Hot plug and play devices should be plugged when the computer is switched on.

USB devices are hot plug and play devices. You do not need to shut down your computer prior to connecting these devices unless the manual supplied with the device states otherwise.

## Connecting an external display

You can connect an external display to your notebook. For example, you can use your computer with the following devices:

- ❑ Computer display (monitor);
- ❑ Multimedia computer display;
- ❑ TV;
- ❑ Projector.

 Turn off your computer and the peripherals, unplug the AC adapter and the power cord before connecting the external display.

Connect the power cord after connecting all other cables.

Turn on the peripherals, then turn on your computer.

Connected external displays are used as second screens.

On Windows® systems only, you can also use an external display to set up a virtual desktop.

## Connecting a computer display

To connect a computer display, proceed as follows:

- 1 Plug the display cable (1) in the monitor (VGA) connector (2) on the computer.
- 2 If necessary, plug one end of the display's power cord (3) into the display, and the other end into an AC outlet.

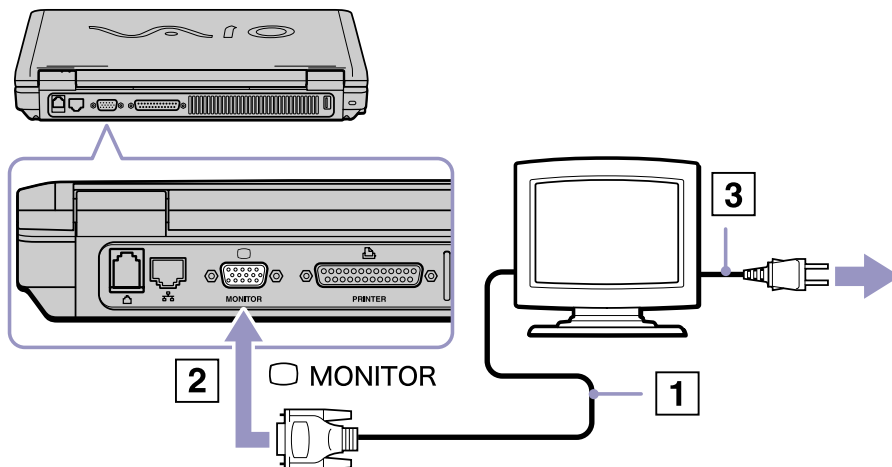

## Connecting a multimedia computer display

You can connect the notebook to a multimedia computer display that includes built-in speakers and a microphone.

To connect a multimedia computer display, proceed as follows:

- 1 Plug the display cable (1) into the monitor connector (2) on the computer.
- 2 Plug the speaker cable (3) into the headphone connector (4) on the computer.
- 3 Plug the microphone cable (5) into the microphone connector (6) on the computer.

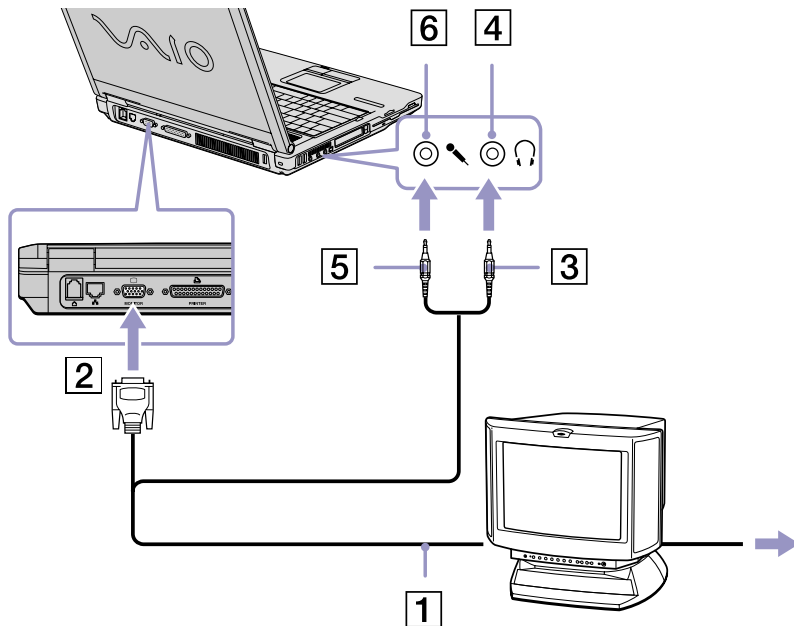

## Connecting a TV

To connect a TV, proceed as follows:

- 1 Plug one end of the audio/ video cable (1) (optional) into the AV out jack (for TV (NTSC/PAL) and line out) (2) and the other end into the TV.
- 2 Plug the power cord of the TV (3) into an AC outlet.
- 3 Switch the input channel of the TV to external input.
- 4 Set up the TV configuration system.

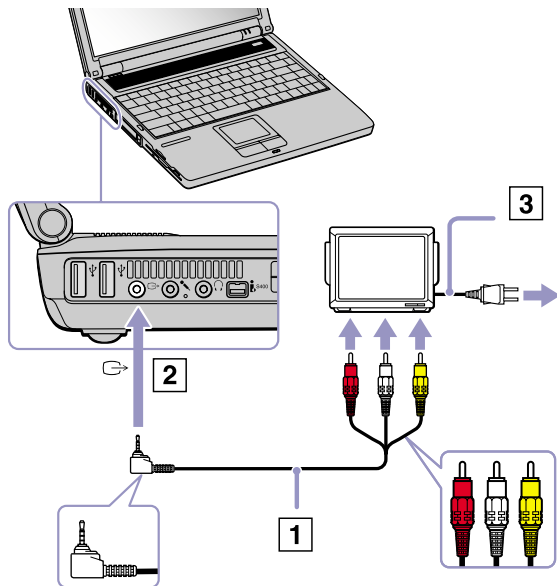

 See the manual supplied with your peripheral for more information on installation and use.

If the display resolution of your computer is more than **1024 x 768** dots, a part of the image cannot be displayed on your TV. The hidden area on your TV can be seen by moving the cursor on your computer. If you want to display the full image, change the display resolution of your computer to **800 x 600** or **1024 x 768** dots.



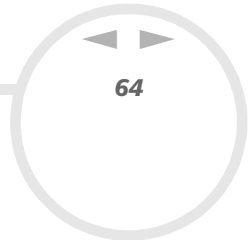



### *Connecting a projector*

You can use a projector as an external display, such as the Sony LCD Projector.

To connect a projector, proceed as follows:

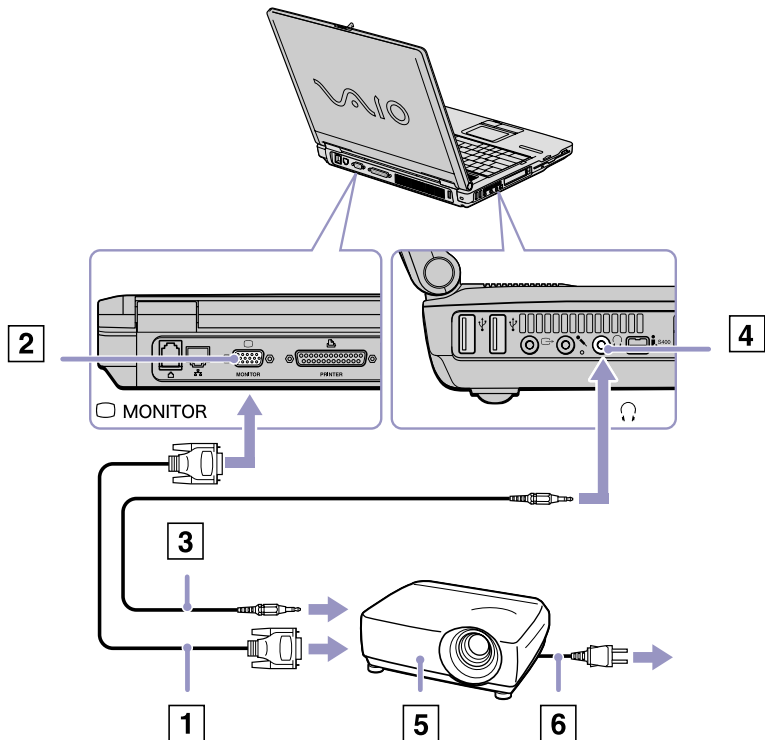
- 1 Plug the RGB signal cable (1) into the monitor connector (2) identified by the □ symbol.
- 2 Plug the audio cable (3) (not supplied) into the headphone connector (4) identified by the 🎧 symbol.
- 3 Plug the RGB signal cable and the audio cable into the connector of the projector (5).
- 4 Connect the power cord (6) of the projector into an AC outlet.



 Under certain circumstances, you may not be able to display the notebook LCD screen and an external display or a projector at the same time.

You can toggle the output between the notebook LCD screen and the external monitor by pressing the **<Fn>+<F7>** key combination.

## Selecting display modes

This notebook uses the ATI RADEON™ IGP 345M Chipset. You can select which display is used when the computer is connected to an external display.

To select a display, proceed as follows:

- 1 Click the **Start** button, and then **Control Panel**.  
The **Control Panel** appears.
- 2 Click **Appearance and Themes**.
- 3 Click **Display**.  
The **Display Properties** dialog box appears.
- 4 Click the **Settings** tab.
- 5 Click the **Advanced** button.  
The **ATI RADEON™ IGP 345M Properties** dialog box appears.
- 6 Click the **Displays** tab.  
Select the **Monitor, Panel** or **TV** icon.
- 7 Click **Apply** and then **OK**.

 Under certain circumstances, you may not be able to display the notebook LCD screen and an external display or a projector at the same time.  
Turn on the computer after you turned off the peripheral devices.

## Using the Dual Display function

The dual display function allows you to distribute portions of your desktop across separate displays. For example, if you have an external monitor attached to the monitor connector, your LCD display and the monitor can function as a single desktop.

You can move the cursor from one display to the other. This allows you to drag objects, such as an open application window or a toolbar, from one display to the other.

This configuration of a single desktop distributed across separate displays, is referred to as a virtual desktop.

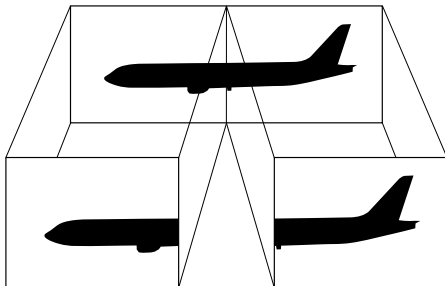

 Your monitor or TV hardware may not support the Dual Display function.

Certain software applications may not be compatible with Dual Display settings.

Make sure that your computer does not enter Standby or Hibernate mode while you are using Dual Display mode, otherwise your computer may not return to Normal mode.

If you set different colours on each display, do not divide one single window on two displays, otherwise your software may not work properly.

Set fewer colours or a lower resolution for each display.

### Selecting the Dual Display mode

To select the Dual Display mode, proceed as follows:

- 1 Click the **Start** button on the Windows® taskbar.
- 2 Click **Control Panel**.
- 3 Click **Appearance and Themes**.
- 4 Click the **Display** icon.
- 5 Select the **Settings** tab.
- 6 Click the display marked **2**.
- 7 Select the **Extend my Windows desktop onto this monitor** check box.
- 8 Click **Apply** and then **OK**.

 Your monitor or TV hardware may not support the Dual Display function.

### Setting the colours and resolution for each display

You can set the display colours and resolution for each display that is part of a virtual desktop.

To set the display colours and resolution for each display, proceed as follows:

- 1 Click the **Start** button on the Windows® taskbar.
- 2 Click **Control Panel**.
- 3 Click **Appearance and Themes**.
- 4 Click the **Display** icon.
- 5 Select the **Settings** tab.
- 6 Select the display you want to change (1 or 2).
- 7 Select an option from the **Color quality** list to change colours.
- 8 Use the slider in the **Screen resolution** to adjust the resolution.
- 9 Click **Apply** and then **OK**.

## Customizing the virtual desktop

You can customize the Dual Display mode by changing the position of the two monitors comprising the virtual desktop.

To customize Dual Display mode, proceed as follows:

- 1 Click the **Start** button on the Windows® taskbar.
- 2 Click **Control Panel**.
- 3 Click **Appearance and Themes**.
- 4 Click the **Display** icon.
- 5 Click the **Settings** tab.
- 6 Drag the monitor icons to match the physical arrangement of your monitors. The two monitor icons must be connected to create a virtual desktop.
- 7 Click **Apply** and then **OK**.

## Deactivating the Dual Display function

To deactivate the Dual Display function, proceed as follows:

- 1 Click the **Start** button on the Windows® taskbar.
- 2 Click **Control Panel**.
- 3 Click **Appearance and Themes**.
- 4 Click the **Display** icon.
- 5 Click the **Settings** tab.
- 6 Click the display 2.
- 7 Deselect the **Extend my Windows desktop onto this monitor** option.
- 8 This will disable the Dual Display.

 For switching from Primary to Secondary display, see the section **Selecting display modes**.

## Connecting external speakers

You can enhance the sound quality of your computer by connecting external speakers.

To connect external speakers, proceed as follows:

- 1 Plug the speaker cable (1) into the headphone connector (2).
- 2 Plug the other end of the speaker cable into the external speaker.
- 3 Turn down the volume of the speakers before you turn them on.

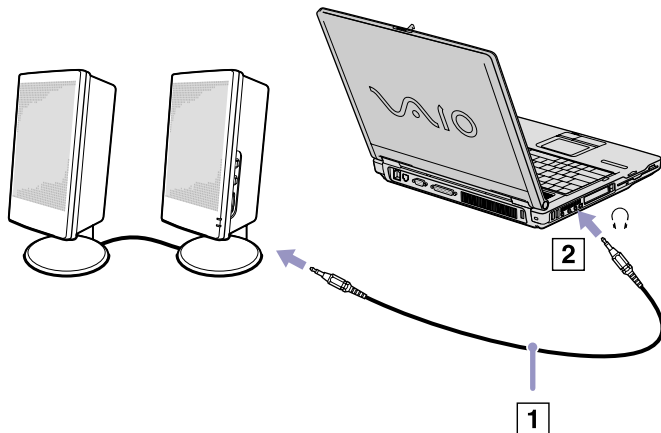

Make sure your speakers are designed for computer use.

Do not place floppy disks on the speakers; their magnetic field may damage the data on the disks.

## Connecting an external microphone

Your VAIO notebook does not contain an internal microphone. If you need to use a sound input device, for example to chat on the Internet, you need to plug in an external microphone.

To connect an external microphone, proceed as follows:

Plug the microphone cable (1) into the microphone connector (2) identified by the  symbol.

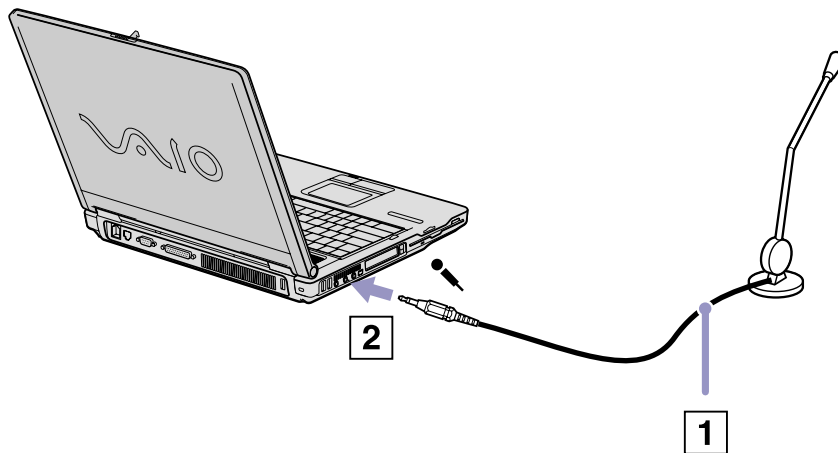

 Make sure your microphone is designed for computer use.





## Connecting a Universal Serial Bus (USB) mouse

You can connect a USB device (e.g. mouse, floppy disk drive, keyboard, printer, ...) to your computer. Before connecting or disconnecting a USB peripheral, you do not need to shut down the computer. You may need to install software (device drivers) supplied with your USB device before using the USB device. There are 3 2 USB 2.0 ports at the left of your notebook and 1 at the back.

To connect a USB mouse, proceed as follows:

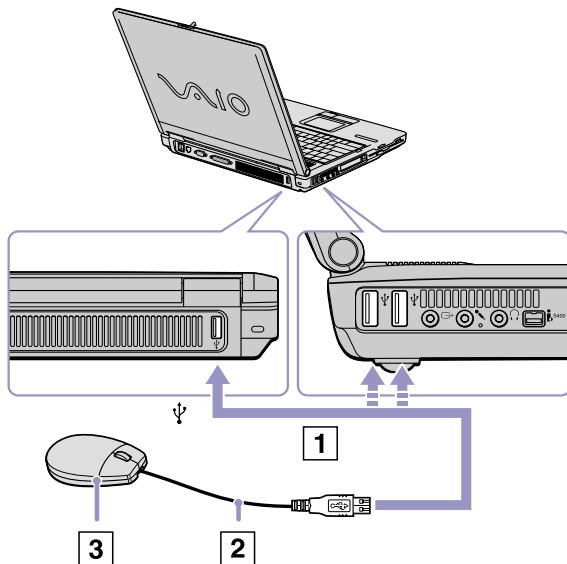
- 1 Select the USB port (1) of your choice.
- 2 Plug the USB mouse cable (2) into the USB connector.
- You can use your USB mouse (3).



 You do not need to shut down the computer before connecting or disconnecting a USB peripheral.

The USB mouse software driver is preinstalled on your notebook, therefore, you only need to plug the USB mouse into the USB connector and you can start working.

You may need to install software (device drivers) supplied with your USB device before using the USB device.

## Connecting a printer

You can connect a Windows<sup>®</sup>-compatible printer to your computer to print documents.

### Connecting a printer using the USB connector

You can connect a USB printer compatible with your version of Windows<sup>®</sup> to your computer.

To connect a printer using the USB connector, proceed as follows:

- 1 Plug an optional USB printer cable (1) into the USB connector (2) identified by the  symbol on your computer and printer.
- 2 Plug the printer (3) power cord into an AC outlet.

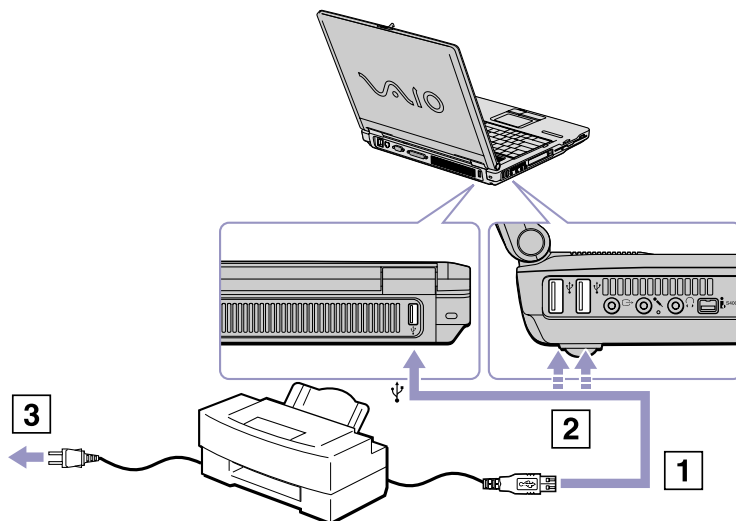

## Connecting a printer using the printer connector

To connect a printer using the printer connector, proceed as follows:

- 1 Plug the printer cable (1) supplied with the printer into the printer connector (2) identified by the  symbol.
- 2 Plug the printer power cord (3) into an AC outlet.

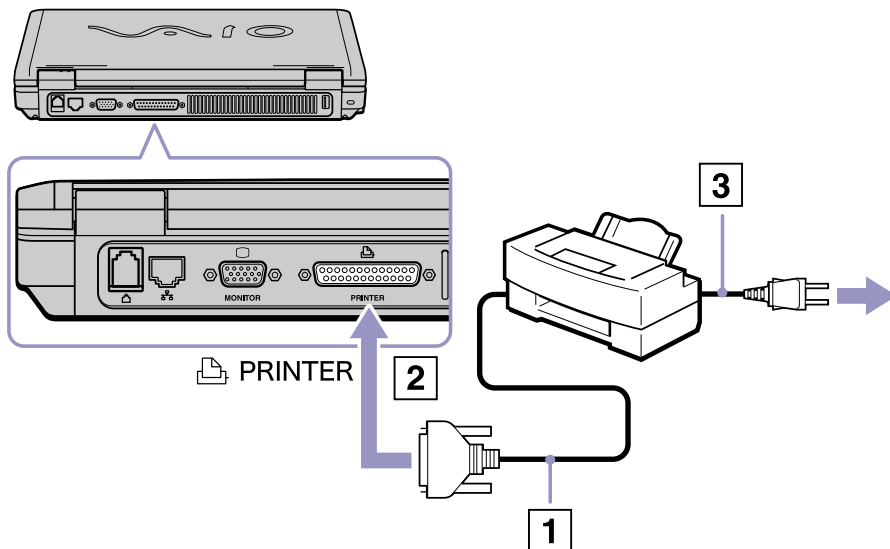

-  Before using the printer, you may need to change the **Printer** settings in the **Sony Notebook Setup** software. This does not apply for USB printers. Turn off your computer and the printer, unplug the AC adapter and the power cord before connecting the printer.

## Connecting an i.LINK™ device

Your computer includes an i.LINK™ (IEEE1394) connector, which you can use to connect to an i.LINK™ device such as a digital video camera recorder or to connect two VAIO notebooks in order to copy, delete or edit files.

The i.LINK™ connector of your notebook does not supply power to external devices generally powered by i.LINK™ connectors.

The i.LINK™ connector supports transfer rates up to 400 Mbps; however, the actual transfer rate depends on the transfer rate of the external device.

The i.LINK™ features available may vary depending on the software applications you use. Refer to the documentation that came with your software for more information.

i.LINK™ cables compatible with your VAIO notebook include cables with the following part numbers: VMC-IL4415 (a 1.5 meter cable with a 4-pin connector at each end), VMC-IL4408Series (a 0.8 metre cable with a 4-pin connector at each end).

- ❑ **Connecting two VAIO computers (page 76)**
- ❑ **Connecting a digital video camera recorder (page 76)**

 An i.LINK™ connection with other compatible devices is not fully guaranteed.

The i.LINK™ connection varies depending on the software applications, operating system and i.LINK™ compatible devices you use. Refer to the documentation that came with your software for more information.

Check the working conditions and OS compatibility of i.LINK™-compatible PC peripherals (HDD, CD-RW drive etc.) before you connect them to your notebook.

## Connecting two VAIO computers

You can copy, edit or delete files on another VAIO computer to your computer with an optional i.LINK™ cable. You can also print a document on a printer connected to another VAIO computer.

## Connecting a digital video camera recorder

To connect a digital video camera recorder, proceed as follows:

- 1 Plug one end of the optional i.LINK™ cable (1) into the i.LINK™ connector (2) of the computer and the other end into the DV Out connector (3) on the digital video camera recorder.
- 2 Launch the DVgate application.

 On Sony digital video cameras, connectors labelled **DV Out**, **DV In/Out** or **i.LINK™** are i.LINK™-compatible.

The Sony digital video camera recorder is an example; your digital video camera recorder may need to be connected differently. If your digital video camera recorder includes a Memory Stick™ slot, you can copy images from it to your computer via a Memory Stick™. To do so, simply copy images on the Memory Stick™, then insert it into the Memory Stick™ slot of your computer.

You cannot access the pictures stored on a Memory Stick™ when using an i.LINK™ connection.

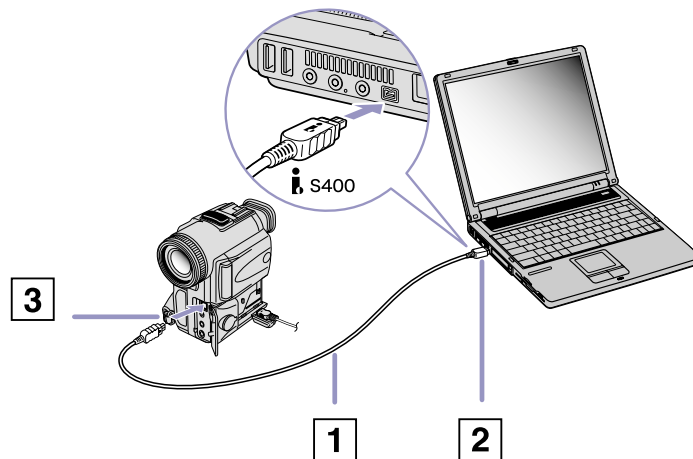

## Connecting to a network (LAN)

You can connect your computer to 10BASE-T/100BASE-TX-type networks via an Ethernet network cable. For the detailed settings and devices needed to connect to the network, consult your Network Administrator.

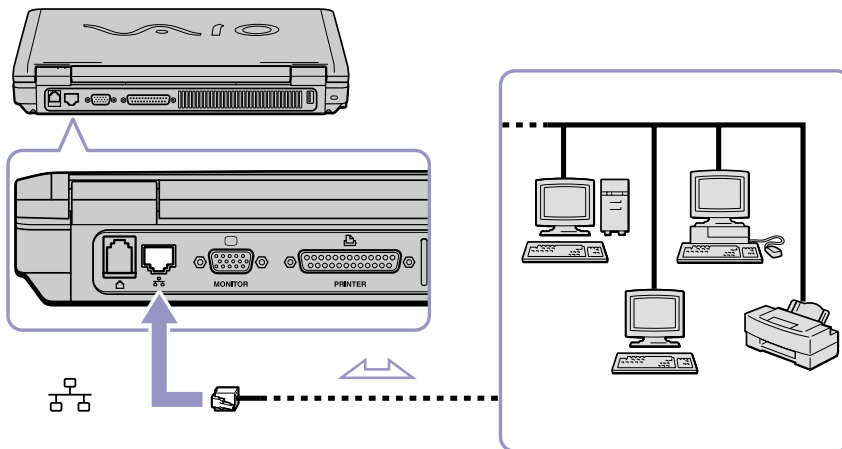

 The default settings make your computer able to connect to the network.

For more information about connecting your notebook to the network, please consult the Hardware troubleshooting section of the VAIO-Link website:

[How to troubleshoot network problems](#)

! Do not plug a phone cable into your computer network jack.

## Getting help

This section describes how to get help and support from Sony, as well as troubleshooting tips for your computer.

### *Sony support options*

Sony provides several support options for your computer.

Please see the section **Documentation pack (page 8)** for details on the printed and online documentation delivered with your computer, as well as further sources of reference.

### *Other sources of information*

- ❑ The **online help files** that accompany your pre-installed software contain instructions on using the software.
- ❑ **VAIO-Link website:** if you have any problem with your computer, you can access the VAIO-Link website. Go to:  
<http://www.vaio-link.com>
- ❑ **VAIO-Link:** Before contacting VAIO-Link, you should try to solve the problem by reading this User Guide or the manuals and help files.

 You need to plug in the phone line and configure your modem for use before using the communication features described in this manual.

## *e-Support*

### *What is e-Support?*

You have searched our user guides and website ([www.vaio-link.com](http://www.vaio-link.com)) but have not found an answer to your question/issue? e-Support is the ideal solution for you!

Our e-Support Web Portal is an interactive website on which you can submit any technical query you may have regarding your VAIO and receive answers from our dedicated support team.

Every submitted query will result in a unique 'case number' to ensure smooth communication between yourself and the e-Support Team.

### *Who can use e-Support?*

All registered VAIO customers are entitled to unlimited access to the VAIO-Link e-Support Web Portal.

### *How can I access the e-Support portal?*

When you register your VAIO computer online at Club-VAIO ([www.club-vaio.com](http://www.club-vaio.com)), you will automatically receive an email with the link to the e-Support Web Portal, your Customer ID and some basic explanation a few hours later.

All you need to do is activate your account by clicking on the provided link in the email.

You are now ready to create your first case!

You can access the e-Support Web Portal from any computer with an active Internet connection.

A complete help file is available on the e-Support Web Portal to help you use our e-Support Service.





*Can I submit questions in my native language?*

Since you are interacting with our e-Support Team through a portal, which connects you directly to our central database, e-Support will only accept and deal with queries submitted in English.

*Can I submit my questions at any time?*

Yes, you can submit your questions 24/7, but please keep in mind that our e-Support Team can only treat your queries from Monday till Friday between 8am and 6pm.

*Is there a cost involved for using e-Support?*

No, this is a complete free of charge service offered to all registered VAIO customers!

*How do I know when the e-Support Team has handled my query/case?*

As soon as your case has been dealt with by our e-Support Team, you will receive an email, notifying you that your case has been updated.

## Troubleshooting

This section describes how to solve common problems you might encounter when using your notebook. Many problems have simple solutions. Please try these suggestions before contacting VAIO-Link.

- ❑ About the computer and software ([page 82](#))
- ❑ About the display ([page 86](#))
- ❑ About discs and floppy disks ([page 87](#))
- ❑ About sound ([page 90](#))
- ❑ About the modem ([page 91](#))
- ❑ About peripherals ([page 92](#))
- ❑ About digital video captures and DVgate ([page 94](#))
- ❑ About power management ([page 94](#))

## About the computer and software

### *My computer does not start*

- ❑ Check that the battery pack is inserted properly and that it is charged. If it is and you still cannot start the computer, take out the battery and make sure your computer is running on the AC power supply only.
- ❑ Check that the computer is plugged directly into a power source (without an extension cord) and that it is turned on.
- ❑ Check the power socket is working by testing it with another device (e.g. a lamp or radio).
- ❑ Check that the power indicator on the front panel of the computer indicates that the power is on.
- ❑ Check that you are using the supplied Sony AC adapter.
- ❑ Check cables for signs of wear and tear (which can occur if the cable is twisted around the AC adapter during transport).
- ❑ If you cannot start Windows<sup>®</sup>, make sure there is no disk in the floppy disk drive.
- ❑ Confirm that the power cord and all cables are connected firmly.
- ❑ If you have plugged the computer into a UPS (Uninterruptible Power Supply), make sure the UPS is turned on and works.
- ❑ Unplug all external devices and cables, including the Internet connection.
- ❑ Remove any extra memory modules you may have inserted since purchase.
- ❑ If you are using an external display, check that it is plugged into a power source and turned on. Check that you have switched to the external display and that the brightness and contrast controls are adjusted correctly.
- ❑ Moisture condensation may have occurred. Do not use the computer for at least one hour and then turn it on.
- ❑ If the message **Press <F1> to resume, <F2> to set up** appears at the bottom of the display, you need to initialise the BIOS (Basic Input/Output System).

*When I turn on my computer, the message **Press <F1> to resume, <F2> to setup** appears*

This message is telling you to initialise the BIOS (Basic Input/Output System).

If the floppy disk drive is empty, proceed as follows to initialise the BIOS:

- 1 Turn off the computer.
- 2 Remove any peripheral devices connected to the computer.
- 3 Turn on the computer and press **<F2>** when the Sony logo appears.  
The BIOS setup menu screen appears.
- 4 Set the date (month/day/year).
- 5 Press **Enter**.
- 6 Press the arrow keys to select **System Time**.
- 7 Set the time (hour:minute:second).
- 8 Press **Enter**.
- 9 Press the arrow keys to select the **Exit** menu.
- 10 Press the arrow keys to select **Get Default Values** and then press **<Enter>**. The **Load default configuration now?** message appears.
- 11 Make sure that **Yes** is selected and then press **<Enter>**.
- 12 Press the arrow keys to select **Exit** (save changes) and then press **<Enter>**.  
The **Save configuration changes and exit now?** message appears.
- 13 Make sure that **Yes** is selected and then press **<Enter>**.

### *My computer does not shut down*

It is recommended that you shut down your computer using the **Turn Off Computer** command on the Windows® **Start** menu. Using other methods, including those listed here, may result in loss of unsaved data.

If the **Turn Off** command does not work properly, proceed as follows:

- 1 Turn off the computer by pressing **<Ctrl>+<Alt>+<Delete>**. If you have not changed the default settings, the **Windows Task Manager** dialog box appears.
- 2 Click **Shut Down** and then **Turn Off**.
  - ❑ If this does not work, press the power button and hold it for at least four seconds. This turns off the power.
  - ❑ Unplug the computer from the AC adapter and remove the battery pack from your computer.

### *My computer or software program is not responding*

If you suspect one application is locking your system, you can try to stop it, as follows:

- 1 Press **<Ctrl>+<Alt>+<Delete>** simultaneously.  
The **Windows Task Manager** screen appears.
- 2 Scroll down until you see an application with the status **Not responding**.
- 3 Select this application from the list and click **End Task**.  
Windows® tries to close the application.  
If it fails to do so, a second dialog box appears.
- 4 Select **End Task** again.
  - ❑ If the above method does not work or you do not know which application is locking your system, restart the computer:
    - 1 Click the **Start** button.
    - 2 Select **Turn Off Computer**, and then **Turn off** in the dialog box that appears.

- ❑ If the above method does not work, press the power button and hold it for at least four seconds. This turns off the power, risking the loss of unsaved data. Then unplug the notebook from the mains.
- ❑ If your computer locks up while playing a disc, stop the disc by pressing the eject button on the disc drive, then restart your computer.
- ❑ If the message **Application not responding** appears, click **End Now**. Please be warned that you will lose unsaved data.
- ❑ If this happens regularly:
  - ❑ Contact the software publisher or designated provider for technical support.
  - ❑ Make sure the software is compatible with your equipment and operating system.
  - ❑ Try reinstalling the software.

#### *My touchpad interprets a single tap as a double-click*

Open the **Mouse** icon in the **Control Panel** and change the button assignments in the **Mouse Properties** dialog box. One of the buttons is assigned to the double-click action.

#### *My mouse does not work*

- ❑ If you are using a USB mouse, check that the appropriate driver and software are properly installed.
- ❑ Check that the USB mouse is plugged into the USB connector.

## About the display

### *My screen does not display anything*

- ❑ Check that the power indicator on the front panel of the computer is on.
- ❑ Check that the battery pack(s) are inserted properly and that they are charged. If using AC power, check that the connection to the mains is secure.
- ❑ If you are using an external display, check that it is plugged into a power source and turned on.
- ❑ Adjust the brightness of the screen.
- ❑ The computer display may be in **Standby** mode. If so, press any key to activate the display. It will take a few seconds for the screen content to appear.
- ❑ The computer display may be in **Hibernate** mode. If so, press the power button to activate the system. It will take a few seconds for the screen content to appear.
- ❑ The display mode may be set to external display mode. Press and hold the **<Fn>** key while pressing **<F7>** several times.

### *The window I have just closed is still on the screen*

- ❑ Press **<F5>** to refresh the screen, or
- ❑ Press the Windows<sup>®</sup> key + **<D>** twice to clean up the screen.

### *The screen image on my external display is not centred or sized properly*

Use the controls on your external display to adjust the image.

## About discs and floppy disks

### *My disc drive tray does not open*

- ❑ Make sure the computer is turned on and press the eject button on the drive.
- ❑ Click **Start**, and select **My Computer**. Right-click the optical disc drive and select **Eject**.
- ❑ If this does not work, try the following:  
When the computer is OFF, open the tray by inserting a sharp, pointed object (for example a paperclip) into the hole next to the eject button.

### *I cannot play a disc*

- ❑ After inserting the disc, wait for a few seconds for the system to detect it before you try to access it.
- ❑ Make sure the label of the disc is facing up.
- ❑ If the disc requires software, make sure the software is installed according to the instructions of the program.
- ❑ Check the volume of your speakers.
- ❑ Clean the disc with an appropriate cleaner.
- ❑ Make sure your computer is running on AC power supply only and try the disc again.
- ❑ There may be condensation in the drive. Remove the disc and leave the drive open for approximately one hour. Remove the battery while you wait for the condensation to disappear.



### *I cannot play a DVD*

- ❑ If a region code warning appears when you are using the DVD player, it could be that the DVD you are trying to play is incompatible with the DVD drive on your notebook. The region code is listed on the packaging of the disc.
  - ❑ Change the resolution under **Control Panel - Display** to a lower resolution.
  - ❑ If you hear sound but cannot see video, the video resolution may be set too high. Choose a lower resolution under **Control Panel - Display**.
  - ❑ If you see video but cannot hear sound, check all of the following:
    - ❑ Make sure the mute setting is off on your DVD player.
    - ❑ Check the **Master Volume** settings of the **Sounds and Audio Device Properties**. If you have connected speakers externally, check the volume settings of your computer speakers and check the connections between your speakers and the computer.
    - ❑ In the **Device Manager**, check that the correct drivers are installed properly. To display the **Device Manager**, click **Start**, then **Control Panel**. Double-click the **System** icon. On the **Hardware** tab, click the **Device Manager** button.
  - ❑ A dirty or damaged disc may cause the computer to 'hang' while it tries to read the disc. If necessary, reboot the computer, remove the disc and then check that it is not dirty or damaged.
  - ❑ Check your PG settings (Parental Guidance) in the DVD software as they might be preventing you from playing certain DVDs when they are activated.
-  On your computer, the default DVD region code is 2. Do not change this setting using the Region Code Change function in Windows®, or using any other software applications. System malfunctions originating from the user changing the DVD region code are beyond the scope of your warranty and will result in service charges for repair.

If you do not immediately see the **Display** icon after clicking **Control Panel**, click **Switch to Classic View** on the left.

### *My floppy disk drive cannot write to a disk*

- The disk may be write-protected. Disable the write-protect feature or use a floppy disk that is not write-protected.
- Check that the disk is properly inserted into the floppy disk drive.
- Your floppy disk may be corrupt. Try to insert another disk.

### *The reading speed of CD/DVD-RWs is very slow*

Generally, the reading speed of a CD/DVD-RW is slower than that of a -ROM or -R. The reading speed can also vary depending on the type of format.

### *The disc tray ejects even when it has been locked into place*

- Ensure that the disc is placed with the label side facing up.
- Clean the disc and the disc drive lens with an appropriate cleaner.
- The disc may be scratched. Place another disc to see if that is the reason.
- There may be condensation in the drive. Remove the disc and leave the drive open for approximately one hour. Remove the battery while you wait for the condensation to disappear.

## About sound

### *My speakers are not producing sound*

- ❑ The built-in speakers may be turned off. Press **<Fn>+<F3>** to turn on the speakers.
- ❑ The speaker volume may be turned to the minimum. Press **<Fn>+<F4>** and then **↑** or **➡** to increase the volume. Press **<Fn>+<F4>** and then **↓** or **⬅** to decrease the volume.
- ❑ If your computer is powered by battery, check that the battery is inserted properly and that it is charged.
- ❑ If you are using an application that has its own volume control, check that the volume is turned up.
- ❑ Check the volume controls in Windows®.
- ❑ If you use external speakers, check that the speakers are properly connected and the volume is turned up. If the speakers have a mute button, make sure it is off. If batteries power the speakers, check that the batteries are inserted properly and that they are charged.
- ❑ If you have connected an audio cable to the headphone connector, disconnect the cable.

### *My microphone does not work*

Check that the external microphone (optional) is plugged into the microphone connector.

## About the modem

### *My internal modem does not work or cannot establish a connection*

- ❑ Check that the phone line is plugged into your computer.
- ❑ Make sure that the modem is the only device connected to your phone line.
- ❑ Check that the phone line is working. You can check the line by plugging in an ordinary phone and listening for a dial tone.
- ❑ Check that the phone number the program is dialling is correct.
- ❑ The modem dialling mode may be incompatible with your telephone line.
- ❑ The modem may not work properly if you are with a **Private Automatic Branch eXchange (PABX)**.
- ❑ In the **Phone and Modem Options** dialog box (**Control Panel / Phone and Modem Options**), check that your modem is listed in the **Modems** tab, and that the location information is correct on the **Dialing Rules** tab.



If you do not see the **Phone and Modem Options** icon, click **Switch to Classic View** on the left side.

### *My modem connection is slow*

Many factors influence modem connection speed, including telephone line noise or compatibility with telephone equipment (such as fax machines or other modems). If you think your modem is not connecting properly to other PC-based modems, fax machines, or your Internet Service Provider, check the following:

- ❑ Have your phone company check that your phone line is free from any line noise.
- ❑ If your problem is fax-related, check that there are no problems with the fax machine you are calling and that it is compatible with fax modems.
- ❑ If you are having a problem connecting with your Internet Service Provider, check that the ISP is not experiencing technical problems.
- ❑ If you have a second phone line available, try connecting the modem to that line.

## About peripherals

### *I cannot establish an i.LINK™ connection between two VAIO computers*

- ❑ Disconnect then reconnect the i.LINK™ cable. If you still have no connection after waiting for a while, restart both computers.
- ❑ If either computer has just returned from a power saving mode, the connection may be affected. In this case, make sure you perform a full restart before connecting them.

### *I cannot use DV devices. The message 'DV equipment seems to be disconnected or turned off' appears*

- ❑ Check that the DV device is turned on and that the cables are properly connected.
- ❑ If you are using multiple i.LINK™ devices, the combination of the connected devices may cause unstable operation. In this case, turn off the power of all connected devices and disconnect unused devices. Check the connection and then turn on the power again.
- ❑ Use the manual import/export in DVgate Motion if the problems occur with third party cameras.
- ❑ You are strongly advised to use only Sony i.LINK™ cables, as using other brands may cause problems with the i.LINK™ devices.

### *My PC Card is not working*

- ❑ Make sure the PC card is compatible with your version of Windows®.

### *I cannot print*

- ❑ Check that all the cables of the printer are properly connected.
- ❑ Check the cable to see if the pins/connectors are not bent or missing completely.
- ❑ Check the manual supplied with your printer for troubleshooting solutions.
- ❑ Try a printer self test (if available) to see if the printer itself is still working properly. For more information, please consult the manual supplied with your printer.

- ❑ Try reinstalling the printer. Some printers have a specific installation procedure. Please check the manual supplied with your printer.
- ❑ Check that your printer is correctly configured and that you have up-to-date drivers. If necessary, contact your dealer.
- ❑ The default setting for the printer port mode is correct for most printers. If you cannot print, try changing the printer port mode, as follows:
  - 1 Restart your computer.
  - 2 When you see the **Sony** logo, press **<F2>**.  
The BIOS setup menu screen appears.
  - 3 Use the keyboard's arrow keys to select the **Advanced** menu.
  - 4 The documentation delivered with your printer should give you the relevant port option.
  - 5 Notebooks: If the printer port mode is set to **ECP**, change it to **Bidirectional** (for HP printers).  
If the printer port is set to **Bidirectional**, change it to **ECP**.  
Desktops: **Select I/O Device Configuration** or **On board device Configuration**, then press the **<Enter>** key.
  - 6 Select **Parallel Port Mode**, then press the **<Enter>** key.
  - 7 Select a printer port option using the arrow keys, then press **<Enter>**.
  - 8 Press **<F10>** and save the new configuration.  
Your computer restarts.
- ❑ If you still cannot print, try resetting the printer connection, as follows:
  - 1 Click the icon of the printer installed on your computer.
  - 2 In the **Printer Tasks** menu, which has now expanded, click **Set printer properties**.
  - 3 Have a look through the different tabs and check for abnormalities that you may be aware of. If you are unsure, check with the printer manufacturer's support service about the correct installation for the printer.
  - 4 Restart your computer.

### *About digital video captures and DVgate*

*While I am recording images to a digital video device using DVgate, my system displays the message **Recording to DV device failed. Check the power and cable connections to the DV device and try the operation again...***

- ❑ Close all open applications and restart your computer. Frequent recording of images to a digital video device while using DVgate sometimes causes this error.
- ❑ Your DV device will need to have DV In/Out in order to be able to transfer your files to the DV device.

### *About power management*

*The power management setting is not responding*

Your notebook's operating system may become unstable if a lower power state, such as **Hibernate** is initiated, and then changed before the notebook completely enters the lower power state.

To restore the notebook to its normal operating stability, proceed as follows:

- 1 Close all open applications.
- 2 Push and hold the power button for four seconds or longer to shut down the notebook.

## Precautions

This section describes safety guidelines and precautions to help you protect your computer from potential damage.

Your notebook and memory modules use high precision components and electronic connectors technology. To avoid the invalidation of your guarantee by mishandling, it is recommended that:

- You contact your dealer to install a new memory module.
- You do not install it yourself, if you are not familiar with upgrading memory on a notebook.
- You do not touch the connectors or open the memory panel.

Please contact VAIO-Link if you need assistance.



## Changing or adding memory

In the future you may want to change or add memory modules in order to expand the functionality of your computer. You can increase the memory by installing optional memory modules.

Be careful when changing memory. Mistakes on installation or removal of the memory module may cause a malfunction.

For memory upgrades, use only DDR266 (CL=2.5) DDR-SDRAM SO-DIMM (gold leaf contacts).

Electrostatic discharge can damage electronic components. Before touching a memory expansion board, ensure the following:

- ❑ Handle the memory module gently.
- ❑ The procedures described in this document assume familiarity with the general terminology associated with personal computers and with the safety practices and regulatory compliance required for using and modifying electronic equipment.
- ❑ Disconnect the system from its power source (that is, battery or AC adapter) and from any telecommunication links, networks, or modems before you open the system. Failure to do so may result in personal injury or equipment damage.
- ❑ Electrostatic Discharge (ESD) can damage memory modules and other components. Install the memory Module only at an ESD workstation. If such a station is not available, do not work in a carpeted area, and do not handle materials that produce or hold static electricity (cellophane wrappers, for example). Ground yourself by maintaining contact with an unpainted metal portion of the chassis while performing the procedure.
- ❑ Do not open the memory module package until you are ready to change the module. The package protects the module from ESD.

! Use the special bag delivered with the memory module or wrap the module in aluminium foil to protect it from electrostatic discharge.

 Depending on the configuration of your notebook, the number of available slots can vary.

Introducing any liquids or any foreign substances or objects into the memory slots, or other internal components of the computer, will result in damage to the computer and any repairs will be out of warranty.

- ! Do not place the memory module in places subject to:
- Heat sources such as radiators or air ducts,
  - Direct sunlight,
  - Excessive dust,
  - Mechanical vibration or shock,
  - Strong magnets or speakers that are not magnetically shielded,
  - Ambient temperature of more than +35°C or less than +5°C,
  - High humidity.

### *Removing and installing a memory module*

To change or add a memory module, proceed as follows:

- 1 Shut down your computer and disconnect all peripheral devices.
- 2 Unplug the computer and remove the battery pack(s).
- 3 Wait until the computer cools down.
- 4 Turn the computer upside down.
- 5 Open the memory compartment cover on the bottom by unscrewing the screw (turn anti-clockwise), as shown.

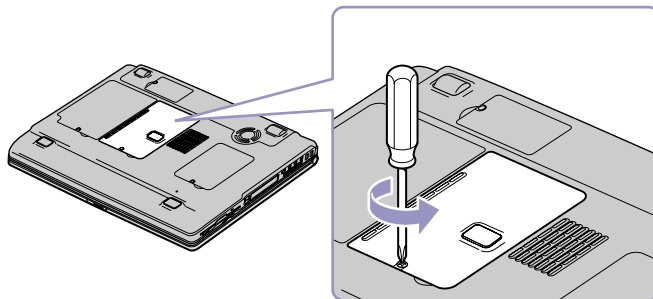

- 6 To remove the memory module, pull the tabs in the direction of the arrows numbered 1.  
The memory module is released.
- 7 Pull the memory module out in the direction of arrow 2.
- 8 To replace or add memory, remove the new memory module from its packaging.
- 9 Place the memory module carefully into the slots, as shown, making sure the notches are aligned properly.

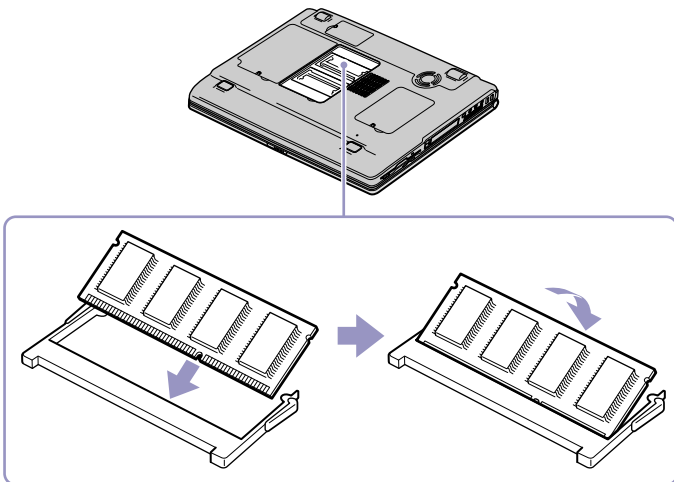
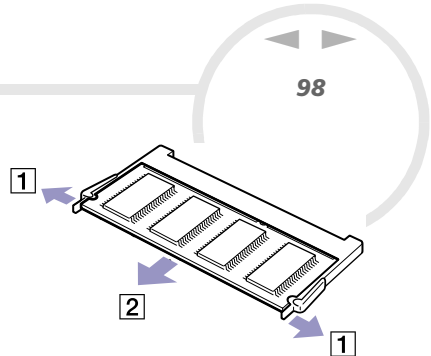

- 10 Close the memory compartment cover and tighten the screw.
- 11 Reinsert the battery pack(s) and turn on the computer.

### *Other precautions*

- ❑ On handling the hard disk ([page 100](#))
- ❑ On handling the LCD screen ([page 100](#))
- ❑ On using power source ([page 101](#))
- ❑ On handling your notebook ([page 101](#))
- ❑ On handling floppy disks ([page 103](#))
- ❑ On handling discs ([page 103](#))
- ❑ On using the battery pack ([page 103](#))
- ❑ On using headphones ([page 104](#))
- ❑ On handling the Memory Stick™ (optional accessory) ([page 105](#))

### *On handling the hard disk*

The hard disk has a high storage density and reads or writes data in a short time. On the other hand, it may be easily damaged by mechanical vibration, shock or dust.

Although the hard disk has the safety device in itself to prevent losing data due to mechanical vibration, shock or dust, you should be careful when handling your computer.

To avoid damaging your hard disk:

- Do not give a shock to your computer.
- Keep away from magnets.
- Do not place your computer in a location subject to mechanical vibration or in unstable situation.
- Do not move your computer while the power is on.
- Do not turn off the power or restart the computer while reading or writing data.
- Do not use your computer in a place subject to extreme change of temperature.
- If the hard disk is damaged, the data cannot be restored.
- Do not move your computer while the system is in **Standby** mode.

### *On handling the LCD screen*

- Do not leave the LCD facing the sun as it can damage the LCD. Be careful when using the computer near a window.
- Do not scratch the LCD or exert pressure on it. This could cause malfunction.
- Using the computer in low temperature conditions may produce a residual image on the screen. This is not a malfunction. When the computer returns to normal temperature, the screen returns to normal.
- A residual image may appear on the screen if the same image is displayed for a lengthy period of time. The residual image disappears in a while. You can use a screensaver to prevent residual images.
- The screen becomes warm during operation. This is normal and does not indicate a malfunction.

- ❑ The LCD is manufactured using high-precision technology. You may, however, see tiny black points and/or bright points (red, blue, or green) that continuously appear on the LCD. This is a normal result of the manufacturing process and does not indicate a malfunction.
- ❑ Avoid rubbing the LCD screen, as this can damage the screen. Use a soft, dry cloth to wipe the LCD screen.

### *On using power source*

- ❑ Your computer operates on 100V-240V AC 50/60 Hz.
- ❑ Do not share the AC outlet with other power-consuming equipment, such as a photocopier or shredder.
- ❑ You can purchase a power strip with a surge protector. This device prevents damage to your computer caused by sudden power surges such as those that may occur during an electrical storm.
- ❑ Do not place heavy objects on the power cord.
- ❑ To disconnect the cord, pull it out by the plug. Never pull the cord itself.
- ❑ Unplug your computer from the wall outlet, if you will not be using the computer for a long time.
- ❑ When the AC adapter is not used, unplug it from the AC outlet.
- ❑ Use only the supplied AC adapter. Do not use any other AC adapter.

### *On handling your notebook*

- ❑ Clean the cabinet with a soft, dry cloth or a soft cloth lightly moistened with a mild detergent solution. Do not use any type of abrasive pad, scouring powder, or solvent such as alcohol or benzene, as these may damage the finish of your computer.
- ❑ Should any solid object or liquid fall into the computer, shut down your computer and then unplug it. You may want to have the computer checked by qualified personnel before operating it any further.
- ❑ Do not drop the computer or place heavy objects on top of the computer.

- ❑ Do not place your computer in a location subject to:
  - ❑ Heat sources, such as radiators or air ducts,
  - ❑ Direct sunlight,
  - ❑ Excessive dust,
  - ❑ Moisture or rain,
  - ❑ Mechanical vibration or shock,
  - ❑ Strong magnets or speakers that are not magnetically shielded,
  - ❑ Ambient temperature of more than 35°C or less than 10°C,
  - ❑ High humidity.
- ❑ Do not place electronic equipment near your computer. The electromagnetic field of your computer may cause a malfunction.
- ❑ Provide adequate air circulation to prevent that internal heat builds up. Do not place your computer on porous surfaces such as rugs or blankets, or near material such as curtains or draperies that may block its ventilation slots.
- ❑ The computer uses high-frequency radio signals and may cause interference to radio or TV reception. Should this occur, relocate the computer a suitable distance away from the set.
- ❑ Use only specified peripheral equipment and interface cables; otherwise, problems may result.
- ❑ Do not use cut or damaged connection cables.
- ❑ Your computer cannot be connected to a coin-operated telephone, and may not work with a private branch exchange (PBX).
- ❑ If the computer is brought directly from a cold location to a warm one, moisture may condense inside your computer. In this case, allow at least one hour before turning on your computer. If any problem occurs, unplug your computer and contact VAIO-Link.
- ❑ Make sure to disconnect the power cord before cleaning the computer.
- ❑ As you may lose important data once your computer is damaged, you should back up your data regularly. Restore the original application programs from the **VAIO Recovery and Documentation Disc**.

### *On handling floppy disks*

- ❑ Do not open the shutter manually or touch the surface of the floppy disk.
- ❑ Keep floppy disks away from magnets.
- ❑ Keep floppy disks away from direct sunlight and other heat sources.

### *On handling discs*

- ❑ Do not touch the surface of the disc.
- ❑ Do not drop or bend the disc.
- ❑ Fingerprints and dust on the surface of a disc may cause read errors. Proper care of the disc is essential to maintain its reliability. Do not use solvents such as benzene, thinner, commercially available cleaners or anti-static spray, as they may cause damage to the disc.
- ❑ For normal cleaning, hold the disc by its edge and use a soft cloth to wipe the surface from the centre out.
- ❑ If the disc is badly soiled, moisten a soft cloth with water, wring it out well, and use it to wipe the surface of the disc from the centre out. Wipe off any remaining moisture with a dry soft cloth.

### *On using the battery pack*

- ❑ Never leave the battery pack in temperatures above 60°C, such as in a car parked in the sun or under direct sunlight.
- ❑ Battery life is shorter in a cold environment. This is due to decreased battery efficiency at low temperatures.
- ❑ Charge the batteries at temperatures between 10°C to 30°C. Lower temperatures require a longer charging time.
- ❑ While the battery is in use or being discharged, the battery pack heats up. This is normal and is not cause for concern.



- ❑ Keep the battery pack away from all sources of heat.
- ❑ Keep the battery pack dry.
- ❑ Do not open or try to disassemble the battery pack.
- ❑ Do not expose the battery pack to any mechanical shock.
- ❑ If you are not using the computer for an extended period of time, remove the battery pack from the computer to prevent damage to the battery.
- ❑ If, after fully charging the battery pack, the battery power is still low, the battery pack may be reaching the end of its life and should be replaced.
- ❑ You do not need to discharge the battery before recharging.
- ❑ If you have not used the battery pack for a considerable amount of time, recharge the battery.

### *On using headphones*

- ❑ **Road safety** – Do not use headphones while driving, cycling, or operating any motorized vehicle. It may create a traffic hazard and is illegal in some areas. It can also be potentially dangerous to play loud music while walking, especially at pedestrian crossings.
- ❑ **Preventing hearing damage** – Avoid using headphones at high volume. Hearing experts advise against continuous, loud and extended play. If you experience a ringing in your ears, reduce the volume or discontinue use.

### *On handling the Memory Stick™ (optional accessory)*

- ❑ Do not touch the connector with your finger or metallic objects.
- ❑ Use only the label supplied with the Memory Stick™ as a label.
- ❑ Do not bend, drop, or apply strong shock to the Memory Stick™.
- ❑ Do not disassemble or modify Memory Sticks™.
- ❑ Do not let cards get wet.
- ❑ Do not use or store Memory Sticks™ in a location subject to:
  - ❑ Extremely high temperatures, such as in a car parked in the sun,
  - ❑ Direct sunlight,
  - ❑ High humidity or near corrosive substances.
- ❑ Use the storage case supplied with the Memory Stick™.

## Glossary

This section refers to terms used in this manual and elsewhere in the VAIO world. These terms and definitions have been compiled to provide you with a better understanding of your VAIO computer.

<i>Term</i>	<i>Definition</i>
<i>&lt;F1&gt; key</i>	The <F1> key gives you access to the online help of most software.
<i>10BASE-T/100BASE-TX</i>	Ethernet system providing data transfer rates of 10 Mbps (megabits per second) and 100 Mbps. The 100BASE-TX is a very direct derivative of 10BASE-T. Its 100 Mbps speed is achieved by simply sending the signal 10 times faster.
<i>ACPI</i>	Short for Advanced Configuration and Power Interface, a power management specification. ACPI enables the operating system to turn peripherals on and off and to control the amount of power given to each device attached to the computer. With ACPI, a CD-ROM player can be turned off by the operating system if it is not in use.
<i>BIOS</i>	An acronym for Basic Input/Output System. The BIOS is a program that enables the computer to start when you turn it on. It monitors the data stream between the operating system and the computer's hardware devices.
<i>CardBus</i>	CardBus is the commercial name for an advanced PC Card. The CardBus technology allows computer users to enjoy higher performances as far as data transfer and operating speed are concerned. See PCMCIA.
<i>CD-ROM</i>	Abbreviation for Compact Disc Read-Only Memory. A high-capacity optical disc, usually 650 MB in size, capable of being read from but not written to.
<i>CD-RW</i>	Short for Compact Disc-ReWritable. Compact Disc that can be used to write or rewrite data to it. A CD-RW can be written to several times, a CD-R can only be written to once.

<i>Term</i>	<i>Definition</i>
<i>CPU</i>	The CPU (Central Processing Unit) is the brains of the computer; it processes the instructions of your system's programs. The CPU is also known as the processor or microprocessor and can be found on the motherboard of your computer.
<i>DC In</i>	The Direct Current interface to which you connect your computer's AC adapter.
<i>Driver</i>	A driver is software enabling you to use hardware devices. For example, in order for you to be able to use a printer, you must first install its driver. Many drivers, such as the mouse driver, come with the operating system.
<i>DVD</i>	Short for Digital Versatile Disc. A type of read-only CD with a minimum capacity of 4.7 GB (maximum capacity can reach 17 GB). This high storage power makes it the ideal medium for storing films.
<i>DVD-R</i>	A writable DVD, based on the DVD-R format, that can be used to write a program or other data.
<i>DVD+R</i>	A writable DVD, based on the DVD+R format, that can be used to write a program or other data.
<i>DVD-RW</i>	A rewritable DVD, based on the DVD-R format, that can be used to write, erase and rewrite a program or other data approximately 1,000 times. See <a href="http://www.dvdrw.com">http://www.dvdrw.com</a> for more information on the DVD-RW.
<i>DVD+RW</i>	The DVD+RW is a slightly different rewritable DVD format, backed by a group of companies known as the DVD+RW Consortium, which includes Sony. Its advantages include high-compatibility, high capacity and easy-to-use functionality. Like the DVD-RW, it can be rewritten about 1,000 times. However, a DVD+RW drive writes at a higher speed than a DVD-RW drive. See <a href="http://www.dvdplusrw.org">http://www.dvdplusrw.org</a> for more information on the DVD+RW.

<i>Term</i>	<i>Definition</i>
<i>Ethernet</i>	Ethernet is the most widely implemented local area network (LAN) technology. The Ethernet system called 10BASE-T provides data transfer rates of 10 Mbps (megabits per second). A more recent version of Ethernet, called 100BASE-T, provides data transfer rates of 100 Mbps. Gigabit Ethernet supports data rates of 1 gigabit (1,000 megabits) per second.
<i>EULA</i>	EULA (End-User Licence Agreement) is the name given to a licence governing the software on your computer. The EULA can be found in the <b>Read this first</b> section at the beginning of the software guide or directly on the VAIO desktop.
<i>i.LINK™</i>	i.LINK™ is Sony's version of the IEEE 1394 standard for high-speed digital serial interface. The standard is regarded in the audio/video and IT industries as the most suitable interface for connecting computers and digital audio/video devices (such as digital cameras etc.).
<i>ISP</i>	An ISP (Internet Service Provider) is a company which provides you with a user name, password and telephone number in order to connect to the Internet.
<i>L2 cache memory</i>	Cache memory is RAM-like memory that enables quick access to data that has already been read by the computer. L1 and L2 are levels of cache memory in a computer.
<i>LAN</i>	A LAN (Local Area Network) is a group of computers connected together within a limited geographical area. It enables users to share devices (such as printers) and information using one processor or server.
<i>LCD</i>	Short for Liquid Crystal Display. Flat notebook display technology using liquid crystals (and light polarisation) to provide sharp, flicker-free images on a screen comprised of millions of tiny cells. Colour can be produced by two basic techniques. Passive matrix is the less expensive of the two technologies. The active matrix technology (or TFT) produces better quality but is also more expensive.
<i>LED</i>	Short for Light-Emitting Diode. A semiconductor device that lights up when electricity passes through it.

<i>Term</i>	<i>Definition</i>
<i>Lithium-ion battery</i>	A lithium-ion battery uses lithium cobalt oxide and carbon as electrodes and ions move from one electrode to the other during charge and discharge. Lithium-ion batteries are the first choice for notebooks because of their light weight, high energy density and because they have no memory effect. In addition they do not use heavy metals like lead, mercury or cadmium.
<i>MAPI</i>	Short for Messaging Application Program Interface. A Microsoft Windows interface enabling you to send e-mail messages. It allows e-mail access and distribution among applications. MAPI-compatible applications include a Send Mail or Send in the File menu of the application.
<i>Maximum RAM</i>	The maximum amount of RAM that your computer can contain. Once this amount is reached, you can no longer add additional RAM to your computer.
<i>Motherboard</i>	The motherboard is the main circuit board inside your computer. It holds the CPU, the BIOS, the memory and so on.
<i>MPEG</i>	MPEG or Moving Pictures Experts Group is a standard for audio-visual compression of video sequences. MPEG achieves high compression rates by storing only the changes from one frame to another. The decrease in data is generally imperceptible to the human eye. MPEG-1 was developed for digital storage of video and audio data on CD-ROM. MPEG-2 achieves better image and audio quality and is more targeted to TV broadcasting and DVD.
<i>Operating system</i>	The operating system is software that manages all the other programs in a computer. It defines how the computer reads and writes information to its disks (and other hardware). Windows 2000, Windows Millennium Edition, Windows XP Professional or Home Edition* are examples of operating systems found on VAIOs.
<i>Partition</i>	A partition is a logical division of a computer's hard disk. A two-partition hard drive would typically contain C: and D: drives. Partitioning is particularly useful if you run more than one operating system or to clearly separate your data files from your installed software.

<i>Term</i>	<i>Definition</i>
<i>PBX</i>	A PBX (Private Branch Exchange) is a private telephone network within an enterprise. Under this system, the calls between the enterprise members are local and the phone numbers are made up of 3 or 4 digits. Companies generally choose this phone system for internal communication because it is less expensive than the regular network. The users can still share a number of outside lines for making calls external to the PBX.
<i>PC Card</i>	A PCMCIA card. The term PC Card is more widely used than PCMCIA. See PCMCIA.
<i>PCMCIA</i>	PCMCIA (Personal Computer Memory Card International Association) is the name of the group that produced the specification for the credit card-sized plug-in boards for laptop computers. The cards used to be called PCMCIA cards, but as this was rather unpronounceable, these cards are now termed PC cards. An example of a PC card is a credit card-sized modem.
<i>Pixel</i>	A pixel (Picture Element) is a part of your screen. Your screen is made up of thousands of pixels, enabling you to see colours and pictures on it. The more pixels, the higher the resolution and the better the image quality.
<i>Processor</i>	The processor is the brains of the computer; it processes the instructions of your system's programs. The processor is also known as the CPU or microprocessor and can be found on the motherboard (see this word) of your computer.
<i>PS/2</i>	A type of mouse or keyboard port.
<i>PSTN</i>	PSTN (Public Switched Telephone Network) refers to the plain old telephone service, the national telecommunication networks implementing voice transmission by using analog signals.

<i>Term</i>	<i>Definition</i>
<i>RAM</i>	Short for Random Access Memory, the memory used to run programs and store data in current use. RAM is the fastest kind of memory to read from and write to. Information stored in RAM is lost when you turn off the computer. The higher the RAM capacity, the faster your current data can be processed.
<i>Resolution</i>	The degree of sharpness and clarity of an image. Resolution is expressed in pixels. Frequent computer screen resolutions are 640 x 480 pixels (VGA resolution; appropriate for a 14-inch screen), 800 x 600 (appropriate for a 15-inch screen), 1,024 by 768 (appropriate for a 17-inch screen), and 1,280 by 1,024. LCD displays usually use a higher resolution than a CRT of the same size.
<i>RGB signal cable</i>	RGB stands for Red, Green, Blue. A cable that requires separate transmission types for the three colours on the display.
<i>SDRAM</i>	Synchronous DRAM is a kind of dynamic random access memory running at a much higher clock speed than regular memory.
<i>Standard RAM</i>	The amount of RAM that is available on your computer when you purchase it.
<i>System recovery</i>	A recovery process that enables you to recover the hard disk image initially available on the computer. Performing a system recovery is useful in the event of a serious system crash or if you want to modify the size of your partitions. You can find the system recovery on the VAIO Recovery and Documentation Disc. For more information, please refer to the <b>Guide to Troubleshooting and Using the VAIO Recovery Documentation Disc</b> .
<i>TFT</i>	Short for Thin Film Transistor. Top-of-the-range notebook display for excellent picture quality. The TFT technology offers the sharpest resolution for flat displays; each pixel is supported by one to four transistors.



<i>Term</i>	<i>Definition</i>
<i>UPS</i>	A UPS (Uninterruptible Power Supply) is a device including a battery that protects your computer from data loss in the event of a power failure. The battery takes over as soon as a power interruption is detected. If you are using the computer when the power failure occurs, you have time to save all unsaved data and to shut down your computer.
<i>USB</i>	USB (Universal Serial Bus) is a hardware interface for attaching devices (such as a keyboard, mouse, joystick, scanner or printer). You can connect up to 127 devices to a USB port. The USB standard is Hot Plug and Play.
<i>VAIO</i>	Short for Video Audio Integrated Operation. Brand name covering Sony's PC products, peripherals, accessories and software. VAIO-branded items are all designed to make the best use of Sony's Audio-Video (AV) and Information Technology (IT) skills.
<i>VAIO Recovery and Documentation Disc</i>	Disc that enables a VAIO computer user to recover the hard disk image that was available when the computer was purchased. It also contains the online documentation. The disc is delivered with your computer. For more information, please refer to the <b>Guide to Troubleshooting and Using the VAIO Recovery Documentation Disc</b> .
<i>WAN</i>	WAN (Wide Area Network) is a computer network connected together and covering a relatively large geographical area. This is in contrast to LAN, where the network is usually set up within one building or small geographical area. The largest existing WAN is the Internet.
<i>XGA</i>	Short for Extended Graphic Array, a graphics standard. An XGA board can provide up to 1,024 x 768 pixels and supports up to 65 thousand colours.

## Trademarks

Sony, BlueSpace NE, DVgate, Giga Pocket, HotKey Utility, Memory Stick Formatter, PicoPlayer, PictureGear Studio, Network Smart Capture, SonicStage, Sony Notebook Setup, Sony Style Imaging, UI Design Selector, VAIO Action Setup, VAIO Edit Components, VAIO Media, VAIO System Information, VAIO Web Phone, Memory Stick, the Memory Stick logo, VAIO and the VAIO logo are trademarks of Sony Corporation.

Microsoft, Internet Explorer, Windows Movie Maker, Windows Media Player, Windows XP Professional, Windows Home Edition and the Windows logo are trademarks or registered trademarks of Microsoft Corporation in the U.S. and other countries.

i.LINK is a trademark of Sony used only to designate that a product contains an IEEE1394 connection.

Adobe, Adobe Acrobat Reader, Adobe Premiere LE and Adobe Photoshop Elements are trademarks of Adobe Systems Incorporated.

QuickTime and the QuickTime logo are trademarks used under licence. QuickTime is registered in the U.S. and other countries.

RealOne Player is a trademark or registered trademark of RealNetworks, Inc. in the U.S. and other countries.

PowerPanel is a trademark of Phoenix Technologies Ltd.

Symantec Norton Antivirus is a trademark of Symantec Corporation.

EverQuest is a registered trademark of Sony Computer Entertainment America Inc.

Click to DVD is a trademark of Sony Electronics.

Drag'n Drop CD+DVD is a registered trademark of Easy Systems Japan Ltd.

WinDVD for VAIO is a trademark of InterVideo, Inc.

RecordNow is a trademark or registered trademark of VERITAS.

PowerDVD for VAIO is a trademark or registered trademark of CyberLink Corporation.

All other names of systems, products and services are trademarks of their respective owners. In the manual, the ™ or ® marks are not specified.

Specifications are subject to change without notice.

All other trademarks are trademarks of their respective owners.

**Please see the printed Specifications sheet to see what software is available for your model.**