

SONY

**Sony Mini Notebook Computer
User Guide**

PCG-505G



VAIO

Notice to Users

© 1998 Sony Corporation. All rights reserved. This manual and the software described herein, in whole or in part, may not be reproduced, translated, or reduced to any machine-readable form without prior written approval.

SONY CORPORATION PROVIDES NO WARRANTY WITH REGARD TO THIS MANUAL, THE SOFTWARE, OR OTHER INFORMATION CONTAINED HEREIN AND HEREBY EXPRESSLY DISCLAIMS ANY IMPLIED WARRANTIES OR MERCHANTABILITY OR FITNESS FOR ANY PARTICULAR PURPOSE WITH REGARD TO THIS MANUAL, THE SOFTWARE OR SUCH OTHER INFORMATION. IN NO EVENT SHALL SONY CORPORATION BE LIABLE FOR ANY INCIDENTAL, CONSEQUENTIAL, OR SPECIAL DAMAGES, WHETHER BASED ON TORT, CONTRACT, OR OTHERWISE, ARISING OUT OF OR IN CONNECTION WITH THIS MANUAL, THE SOFTWARE, OR OTHER INFORMATION CONTAINED HEREIN OR TO USE THEREOF.

Sony Corporation reserves the right to make any modification to this manual or the information contained herein at any time without notice. The software described herein is governed by the terms of a separate user license agreement.

Sony, DVgate, i.LINK, Mavica, PictureGear, VAIO and the VAIO logo are trademarks of Sony Corporation. Windows and the Windows 98 logo are registered trademarks of Microsoft Corporation. Intel, MMX, and Pentium are trademarks of Intel Corporation. All other trademarks are trademarks of their respective owners.

As an ENERGY STAR Partner, Sony has determined that this product meets the ENERGY STAR guidelines for energy efficiency.

Energy Star is an U.S. registered mark.

Specifications are subject to change without notice.

Safety Information

Owner's Record

The model number and serial number are located on the bottom of your Sony VAIO Mini Notebook Computer. Record the serial number in the space provided here. Refer to the model and serial number when you call your Sony Service Center.

Model Number: PCG-505G

Serial Number: _____

WARNING

- To prevent fire or shock hazard, do not expose your Sony Notebook Computer to rain or moisture.
- To avoid electrical shock, do not open the cabinet. Refer servicing to qualified personnel only.
- Audio and picture distortion may occur if this equipment is positioned in close proximity to any equipment emitting electromagnetic radiation.
- Never install modem or telephone wiring during a lightning storm.
- Never install telephone jacks in wet locations unless the jack is specifically designed for wet locations
- Never touch uninsulated telephone wire or terminals unless the telephone line has been disconnected at the network interface.
- Use caution when installing or modifying telephone lines.
- Avoid using the modem during an electrical storm.
- Do not use the modem or a telephone to report a gas leak in the vicinity of the leak.
- Use your notebook only with the supplied AC adapter. To disconnect your notebook completely from mains voltage, unplug the AC-adapter.
- Please make sure that the socket outlet is easily accessible.

Regulatory Information

This product conforms with the following European Directives: 73/23/EEC (Low Voltage Directive) 89/336/EEC, 92/31/EEC (EMC Directives) 93/68/EEC (CE-Marking Directive)

This equipment complies with EN 55022 Class B and EN 50082-1 for use in following areas: residential, business and light-industrial.

This equipment has been tested and found to comply with the limits set out in the EMC Directive for using a connection cable shorter than 3 metres (9,8 feet).

The CD-ROM is classified as a CLASS 1 LASER PRODUCT and complies with the Laser Products Safety Standard EN 60825. Repair and maintenance only by authorized Sony technicians. Improper repairs can create a safety hazard.

**CLASS 1
LASER PRODUCT
TO EN 60825**

DISPOSAL OF LITHIUM ION BATTERY.

- ! **Do not handle damaged or leaking lithium ion batteries.**
- ! **Danger of explosion if battery is incorrectly replaced. Replace only with the same or equivalent type recommended by the manufacturer. Discard used batteries according to the manufacturer's instructions.**
- ! **The battery pack used in this device may present a fire or chemical burn hazard if mistreated. Do not disassemble, heat above 212° (100°C) or incinerate. Dispose of used battery promptly. Keep away from children.**
- ! **Your notebook is equipped with an internal backup memory. For changing this battery, please contact VAIO Link.**

-  In some areas the disposal of lithium ion batteries in household or business trash may be prohibited. Please use the public collection system. Dispose of properly at end-of-life.

Contents

Welcome

Unpacking Your Notebook Computer	2
Ergonomic Considerations	3

Using Your Notebook Computer

Locating the Controls and Connectors	5
Connecting a Power Source	8
Using the AC Adapter.....	8
Starting Your Computer	12
Shutting Down Your Computer	13
Registering Windows [®] 98.....	14
Registering Your Computer	15
Using the Keyboard.....	16
Using the Touchpad	21
Using the Plastic Pen	22
Using the Floppy Disk Drive	24
Using PC Cards	26
Using Infrared Communication Devices.....	29
Using Power Saving Modes	31

Connecting Peripheral Devices

Connecting a PC card modem	34
Connecting the CD-ROM Drive	36
Connecting the Port Replicator.....	39
Connecting a Printer.....	41

Connecting an External Display.....	42
Connecting an External Mouse and Keyboard	44
Connecting a Desktop Computer or Serial Device.....	45
Connecting External Speakers.....	46
Connecting a Digital Video Camera Recorder.....	48
Connecting a Universal Serial Bus (USB) Device	49
<i>Using the Media Bar.....</i>	<i>51</i>
Media Bar Functions.....	52
<i>Customizing Your Notebook Computer</i>	
Displaying the Sony Notebook Setup Screen.....	53
Controlling Power Management.....	55
Displaying Battery Information	58
Starting Your Favorite Software With Programmable Power Key (PPK) Setup	60
Selecting the Display Mode	62
<i>Getting Help</i>	
About Sony's Support Options	65
Troubleshooting	67
Using the Product Recovery CD-ROM	72
<i>Notes on Use</i>	<i>75</i>
<i>Index.....</i>	<i>79</i>

Welcome

Congratulations on your purchase of the Sony VAIO® Mini Notebook Computer. Sony has combined leading-edge technology in audio, video, computing, and communications to provide you with state-of-the-art personal computing.

Here are just some of the features your Sony Notebook Computer has to offer (read the details in your *About Your Sony Mini Notebook Computer* guide):

- ❑ **Exceptional performance** –Your PC includes a fast Intel® Pentium® processor with MMX™ technology, a CD-ROM drive and a 56 kbps PC card modem.
- ❑ **Portability** – The rechargeable battery pack provides hours of use without AC power. See “To charge the battery pack” on page 10 for specific information on your model.
- ❑ **Sony audio and video quality** – High-quality MPEG1 video, which supports full-screen display (10.4-inch Active Matrix LCD screen) and enables you to take advantage of today’s advanced multimedia applications, games, and entertainment software.
- ❑ **Windows® 98** –Your system includes the latest operating system from Microsoft.
- ❑ **Communications** – Access popular online services, send and receive e-mails, browse the Internet, and use the built-in speakerphone, answering machine, and fax features.
- ❑ **Excellent customer support: VAIO Link** – If you have some problems with your computer, you can contact VAIO Link by telephone, fax or E-mail (see your *Customer Service Guide* and VAIO Space for numbers and addresses). Before calling VAIO Link, try to solve the problem by reading your User Guide (troubleshooting chapter) or the manuals and helpfiles of the peripherals or software.

Unpacking Your Notebook Computer

Remove the following hardware items from the box:

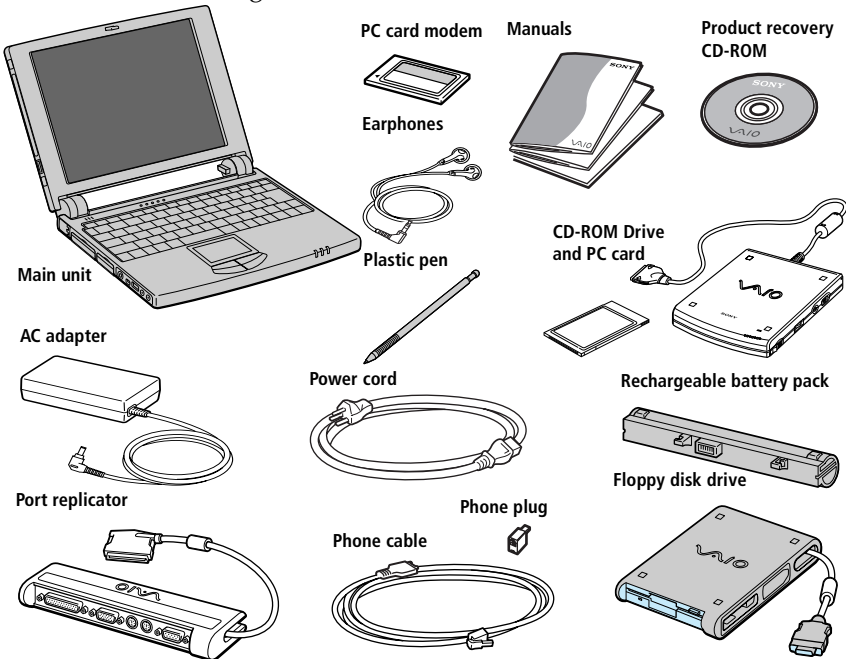

You can find the complete list of the items that come with your computer in the *About Your Sony Notebook Computer* guide.

Ergonomic Considerations

You will be using your notebook computer as a portable device in a variety of environments. Whenever possible, you should attempt to apply the following ergonomic considerations to both stationary and portable environments.

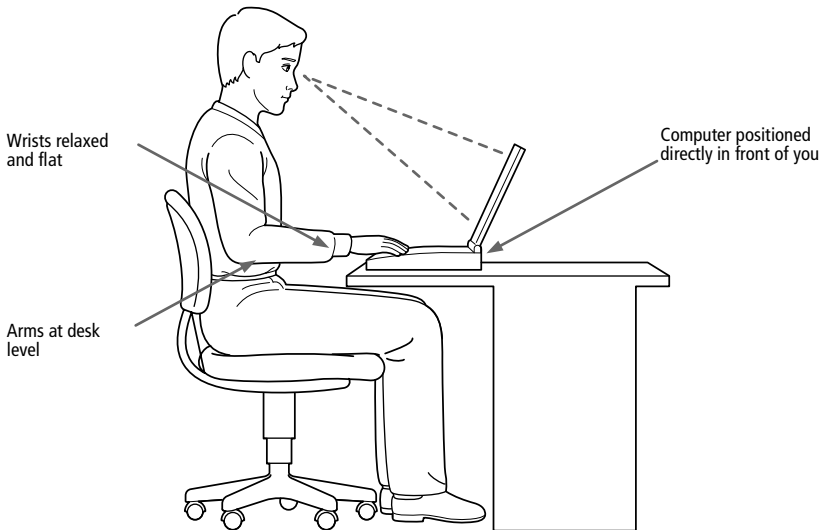

- ❑ **Position of your computer** – Place the computer directly in front of you as you work. Keep your forearms horizontal, with your wrists in a neutral, comfortable position while using the keyboard, touchpad, or external mouse. Let your upper arms hang naturally at your sides. Take breaks during sessions with your computer. Excessive use of the computer may strain muscles or tendons.
- ❑ **Furniture and posture** – Sit in a chair with good back support. Adjust the level of the chair so your feet are flat on the floor. A footrest may make you more comfortable. Sit in a relaxed, upright posture and avoid slouching forward or leaning far backward.
- ❑ **Viewing angle of the computer's display** – Use the display's tilting feature to find the best position. You can reduce eye strain and muscle fatigue by adjusting the tilt of the display to the proper position. Adjust the brightness settings of the display also.

- ❑ **Lighting** – Choose a location where windows and lights do not create glare and reflection on the display. Use indirect lighting to avoid bright spots on the display. You can also purchase accessories for your display that help reduce glare. Proper lighting adds to your comfort and work effectiveness.
- ❑ **Placement of an external display** – When using an external display, set the display at a comfortable viewing distance. Make sure the display screen is at eye level or slightly lower when you are sitting in front of the monitor.
- ❑ **Tilt stand** - You may use the optional extended PCGA-BP52 battery pack as a tilt stand to place the computer at an angle that allows comfortable typing.

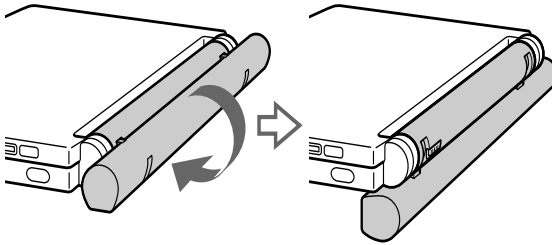

Using Your Notebook Computer

This section describes how to start using your computer and how to use your computer's internal and external devices, such as the touchpad, floppy disk drive, and CD-ROM drive.

Locating the Controls and Connectors

Front

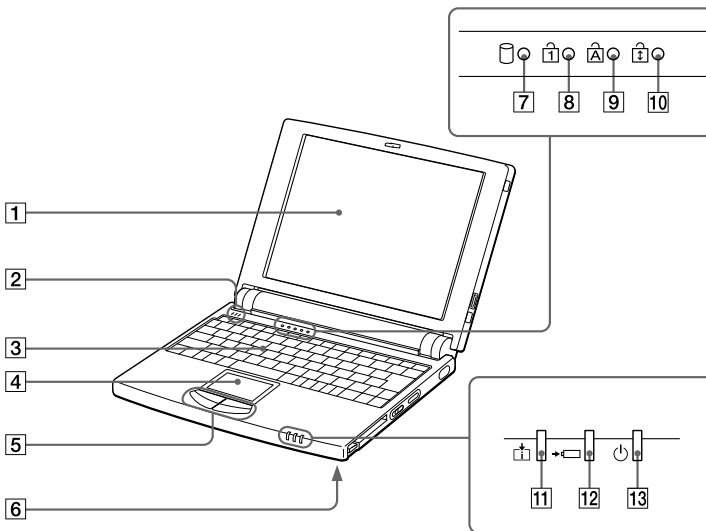

- 1 LCD screen (page 20)
- 2 Microphone
- 3 Keyboard (page 16)
- 4 Touchpad (page 21)
- 5 Left/right button (page 21)
- 6 Speaker
- 7 Hard disk drive indicator (page 19)

- 8 Num Lock indicator (page 19)
- 9 Caps Lock indicator (page 19)
- 10 Scroll Lock indicator (page 19)
- 11 Information indicator (page 19)
- 12 Battery indicator (pages 10, 19)
- 13 Power indicator (pages 12, 19)

Back

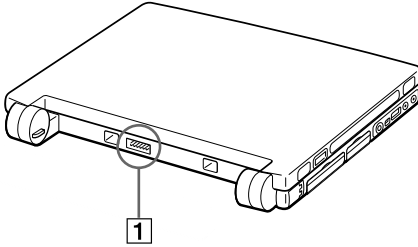

- 1 Battery connector (page 9)

Left

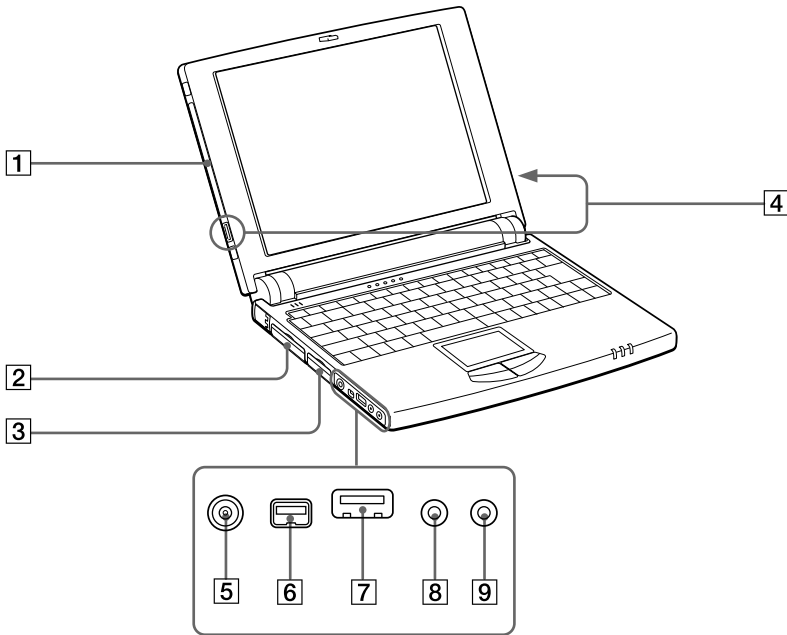

- | | |
|---|-----------------------------------|
| 1 Plastic pen compartment (page 22) | 6 200 i.LINK (IEEE1394) (page 48) |
| 2 I/O Port replicator connector (page 39) | 7 USB connector (page 49) |
| 3 Floppy Disk Drive connector (page 24) | 8 Line In connector |
| 4 External speaker connectors (page 46) | 9 Headphone connector |
| 5 DC In connector (page 8) | |

Right

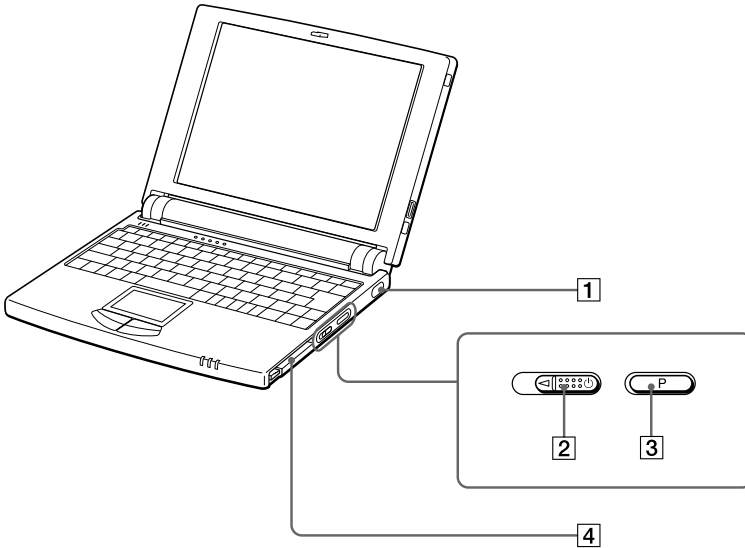

- | | | | |
|----------|-------------------------|----------|------------------------|
| 1 | Infrared port (page 29) | 3 | Programmable power key |
| 2 | Power switch (page 12) | 4 | PC card slot (page 26) |

Bottom

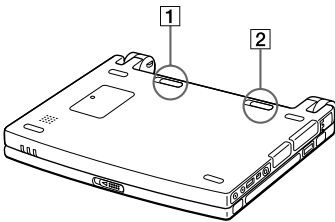

- | | |
|----------|-------------------------------------|
| 1 | Battery release lever (pages 9, 11) |
| 2 | Battery lock lever (pages 9, 11) |



All connectors for this notebook are: SELV (Safety Extra Low Voltage), according to EN60950.

Phone cable and phone cable connectors: TNV (Telecommunication Voltage), according to EN 60950.

AC adapter mains connector and power cord: hazardous voltage, according to EN 60950.

Connecting a Power Source

You can use either AC power or a rechargeable battery pack as a power source.

Using the AC Adapter

- 1 Plug the cable attached to the AC adapter into the DC In connector on the computer.
- 2 Plug one end of the power cord into the AC adapter.
- 3 Plug the other end of the power cord into an AC outlet.

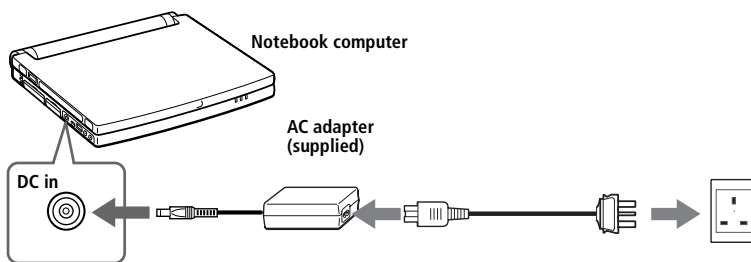

Use your notebook only with the supplied AC adapter. To disconnect your notebook completely from mains voltage, unplug the AC adapter.

Please make sure that the socket outlet is easily accessible.

Using Battery Power

You can use a battery pack as a source of power. The PCGA-BP51 battery pack that comes with your computer is not fully charged at the time of purchase. Follow the steps below to insert and charge the battery pack.

 You can also purchase the high-capacity PCGA-BP52 battery pack as a separate option. See "Using Power Saving Modes" on page 31 for power management information.

To insert the battery pack

- 1 Move the lock lever on the bottom of the computer to the **UNLOCK** position.

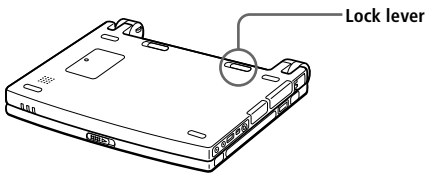

- 2 Align the grooves and tabs on the battery with the tabs and notches on the back of the computer, and then slide the battery towards the computer until it clicks into place.

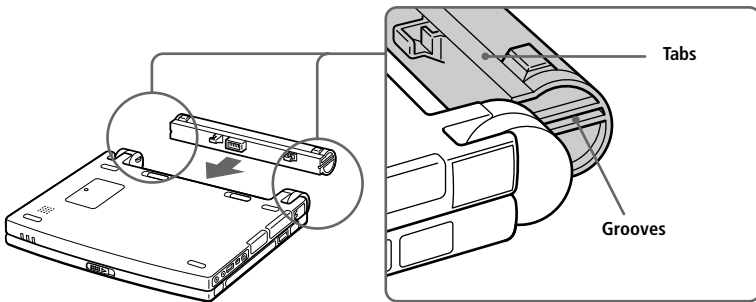

- 3 Slide the lock lever into the **LOCK** position to secure the battery on the computer.

To charge the battery pack

- 1 Connect the AC adapter to the computer.
- 2 Insert the battery pack.

The computer automatically charges the battery (the battery indicator light flashes in a double blink pattern as the battery charges). When the battery is 85% full, the battery indicator light turns off. This process takes approximately one and one half hours. To charge the battery completely, continue charging for an additional hour.

To remove the battery pack

A fully charged battery pack provides power for:

Model	PCGA-BP51	PCGA-BP52
PCG-505G	Approx. 3 hours	Approx. 5 hours

The time varies based on your system configuration. See “Displaying Battery Information” on page 58.

The  battery indicator light on the front of the computer indicates the status of the battery pack.

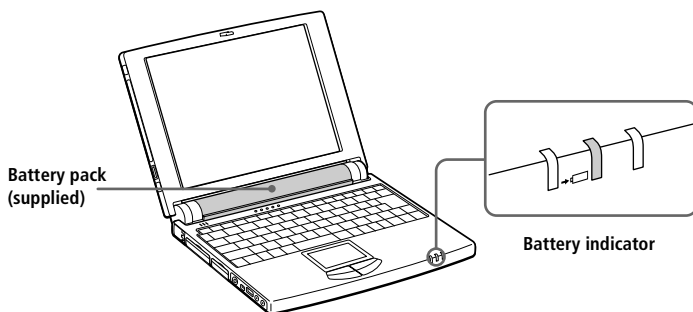

Battery Indicator

Light Status	Meaning
On	The computer is using battery power.
Battery and power indicators blink once	The battery is running out of power.
Double blink	The battery is charging.
Off	The computer is using AC power.

 Keep the battery pack in the computer while it is directly connected to AC power. The battery pack continues to charge while you are using the computer.

If your battery level falls to less than 10%, you should either attach the AC adapter to recharge the battery or shut down your computer and insert a fully charged battery.

You can extend battery life by changing the power management modes in the PowerPanel utility. See "Using Power Saving Modes" on page 31.

The battery pack supplied with your computer is a lithium ion battery and can be recharged at any time. Charging a partially discharged battery does not affect battery life.

The battery indicator light is on while you use the battery pack as a power source. When battery life is nearly depleted, the battery indicator starts flashing.

To remove the battery pack

- 1 Turn off the computer.
- 2 Slide the lock lever to the **UNLOCK** position.
- 3 Slide the release lever to the **UNLOCK** position and slide the battery away from the computer.

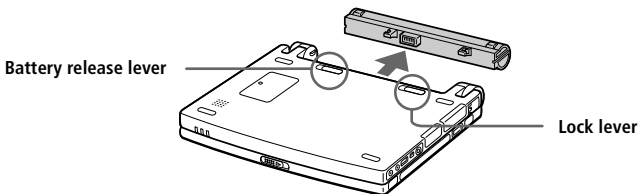

 You may lose data if you remove the battery pack while the computer is on and not connected to the AC adapter or if you remove the battery while the computer is in System Suspend mode.

Starting Your Computer

- 1 Slide the LCD lock lever in the direction of the arrow and lift the cover.

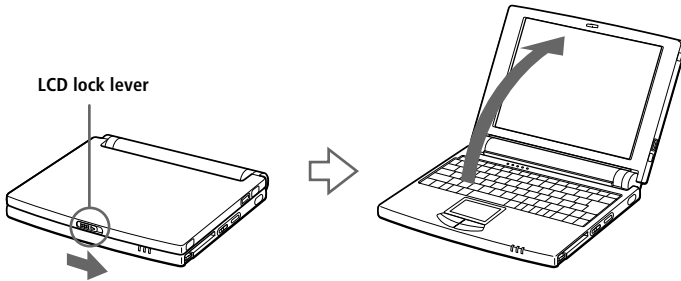

- 2 Slide the power switch on the right side toward the front of the computer until the green power indicator light turns on.

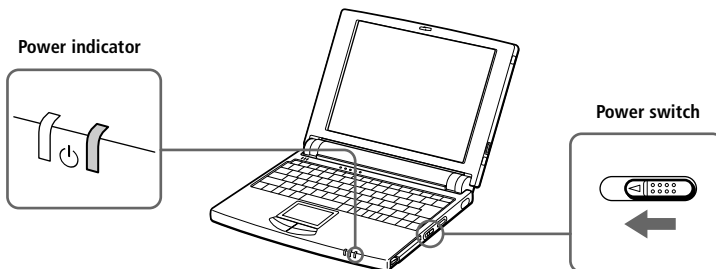

 If you hold the power switch in the on position for more than four seconds, the computer turns off.

- 3 If necessary, adjust the brightness controls for the LCD display. To decrease the brightness, press Fn+F5 and then the down or left arrow key. To increase the brightness, press Fn+F5 and then the up or right arrow key.

Shutting Down Your Computer

! To avoid potential loss of data, follow these steps to shut down your computer.

- 1 Click the Start button on the Windows 98 taskbar.
- 2 Click Shut Down at the bottom of the Start menu to display the Shut Down Windows dialog box.

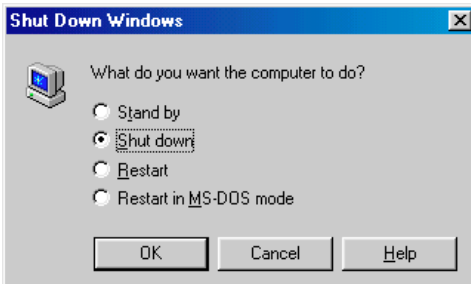

- 3 Select Shut down.
- 4 Click OK.

 Respond to any prompts warning you to save documents.

- 5 Wait for your computer to turn off automatically: the green indicator light turns off.
- 6 Turn off any peripherals connected to your computer.

 If you are unable to shut down your computer using the steps described above, press the Ctrl+Alt+Delete keys at the same time and select Shut Down in the Task manager window to restart the computer. If you are unable to restart the computer in this way, you can slide the power switch forward and hold for four seconds. This operation may result in data loss.

During a period of inactivity, you can conserve battery life by using System Suspend mode. See "Controlling Power Management" on page 55.

Registering Windows® 98

The first time you turn on your computer, you need to complete a few steps to register and configure the Windows 98 software that is already installed on your computer.



You must register Windows 98 before you can use the computer.

The on-screen instructions guide you through the registration and configuration process. The following is an overview of the process.

- 1 Gathering information:
 - Enter your name.
 - Read and accept the License Agreement.
 - Enter your Certificate of Authenticity number located on the cover of the Microsoft Windows 98 *Getting Started* manual.
- 2 Windows 98 setup:
 - Click the Finish button on the Windows 98 Setup Wizard screen.
- 3 Selecting your computer settings:
 - If necessary, change the Time Zone, Date and Time on the Date/Time Properties screen.
- 4 Learning about Windows 98:
 - If you want, take the tour of Windows 98.

Registering Your Computer

You can take advantage of Sony's commitment to quality customer support and receive the following benefits by registering your computer with Sony:

- ❑ **VAIO Link** – You can contact VAIO Link by telephone, fax or E-mail (see your *Customer Service Guide* and *VAIO Space* for phone numbers).
- ❑ **Extended Guarantee** – Protect your investment. See the Guarantee Card for details. See your *Customer Service Guide* for extended guarantee conditions.

Follow these steps to use the Sony Notebook Computer's online registration service.



You must connect your phone line before using any online services, including the online registration service. See "Connecting a PC card modem" on page 34.



- 1 Enter the information requested on the first online registration form. Press the Tab key to move from box to box.
- 2 Click the Register now button and complete the form.
- 3 Click the Send Directly Button to register your computer, via modem to modem connection. Your computer automatically transfers your registration information, using your PC Card modem and a preset phone number.
Click Send via Internet if you chose to send your information via the WWW.

Using the Keyboard

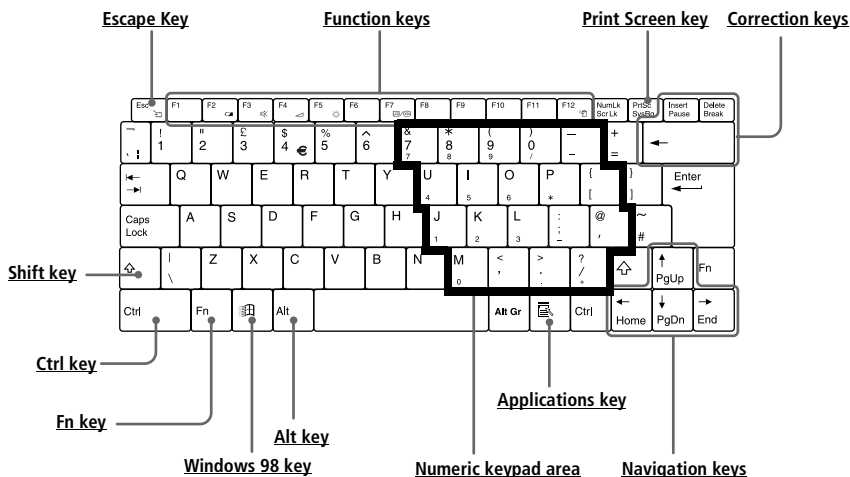







Your keyboard is very similar to a desktop computer's, the keyboard has additional keys that perform specific computer-related tasks.





<i>Keys</i>	<i>Descriptions</i>
Numeric keypad area	Contains the keys found on a typical calculator. Use the numeric keypad area to type numbers or to perform mathematical calculations such as addition and subtraction. Note that you must press the Num Lock key to activate the numeric keypad. (When you do so, the Num Lock light will be on.)
Navigation keys	Several keys are devoted to moving the cursor on the screen (the four arrow keys which also function as the Home, End, Page Up, and Page Down keys).
Correction keys	The Insert, Back Space, and Delete keys enable you to make corrections in your documents.
Function keys	The twelve function keys along the top of the keyboard are used to perform designated tasks. For example, in many applications, F1 is the Help key. The task associated with each function key may vary from one application to the next.





<i>Keys</i>	<i>Descriptions</i>
Escape key	The Esc (Escape) key is used to cancel commands
Print Screen key	The Print Screen key takes an electronic snapshot of the screen and places it in the Windows Clipboard. You can then paste the screen shot into a document and print it.
Operator keys	Several keys are always used with at least one other key: Ctrl, Alt, and Shift. When held down with another key, the Ctrl (Control) and Alt (Alternate) keys offer another way to give commands. For example, in many applications, instead of choosing the Save command from a menu, you can hold down Ctrl and press S (referred to as Ctrl+S). The Shift key is used to produce capital letters or special symbols such as @ and \$.
Windows 98 key 	The key with the Windows logo displays the Windows 98 Start menu; it's the equivalent of clicking the Start button on the task bar. See "Combinations and Functions with the Windows 98 Key" on page 18.
Fn key	The Fn key is used in combination with other keys to issue commands. The Fn keys at the left and right sides both work the same. See "Combinations and Functions with the Fn Key" on page 20.
Applications key 	The Applications key displays a shortcut menu of context-sensitive choices; pressing this key is the equivalent of clicking the right mouse button.

Combinations and Functions with the Windows 98 Key













<i>Combinations</i>	<i>Functions</i>
 + F1	Displays Windows Help.
 + Tab	Switches the selected button on the taskbar.
 + E	Displays Windows Explorer.
 + F	Displays the Windows Find: All Files window to find a file or folder. This is the equivalent of selecting Find and then Files or Folders from the Start menu.
 + Ctrl + F	Displays the Windows Find: Computer window where you can locate other computers. This is the equivalent of selecting Find and then Computer from the Start menu.
 + M	Minimizes all displayed windows.
Shift +  + M	Returns all minimized windows to their previous size.
 + R	Displays the Run window. This is the equivalent of selecting Run from the Start menu.
 + Fn + Pause	Displays the System Properties window. This is the equivalent of double-clicking the System icon in the Control Panel.

Indicators

<i>Indicators</i>	<i>Functions</i>
Information 	Turns on when the PPK Timer is set. Turns off when the timer is not set or the PPK Timer setting is inactive (such as when the computer's power is off or in System Hibernation Mode).
Battery 	Indicates the status of the battery attached at the rear of the computer.
Power 	Lights when the power to the computer is turned on. Flashes in System Suspend mode. Turns off when the computer is in System Hibernation mode or powered off.

<i>Light</i>	<i>On</i>	<i>Off</i>
Hard disk 	Lights when data is being read from or written to the hard drive. Do not enter System Suspend mode or turn off the computer when this indicator light is on.	Turns off when the hard drive is not being accessed.
Num Lock 	Turns on when the number keys area in the numeric keypad are active.	Turns off when the alphanumeric character keys in the keypad area are active.
Caps Lock 	Turns on when the letters appear in uppercase as you type. The Shift key lowers the case of typed letters when Caps Lock is on.	Turns off when letters appear in lower case as you type (unless you hold down the Shift key).
Scroll Lock 	Turns on when the screen scrolls differently. (Exactly how it scrolls depends on the specific application. It has no effect in many applications.)	Turns off when information moves across the display normally.

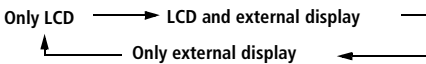
Combinations and Functions with the Fn Key

Combinations/ Feature	Functions
Fn+  (ESC) System Suspend	Puts the system into System Suspend mode, a power management state. To return the system to the active state, press any key or press the power switch on your computer.
Fn+  (F2) Display power status	Displays the power status, as in the example below: <div style="display: flex; justify-content: space-around; align-items: center;"> <div style="text-align: center;">  <p>Using AC power</p> </div> <div style="text-align: center;">  <p>Charging the battery</p> </div> </div>
Fn+  (F3) Speaker switch	Toggles the built-in speaker off and on.
Fn+  (F4) Speaker volume	Adjusts the built-in speaker volume. To increase volume, press Fn+F4, then ↑ or →. To decrease volume, press Fn+F4, then ↓ or ←.
Fn+  (F5) Brightness control	Adjusts the brightness of the LCD. To increase light intensity, press Fn+F5 and then ↑ or →. To decrease light intensity, press Fn+F5 and then ↓ or ←.
Fn+  /  (F7) Switch to the external display	Toggles through the LCD, external display (connected to the  Monitor connector on the port replicator) and both LCD and external display. <div style="text-align: center; margin-top: 10px;">  </div>
Fn+  (F12) System Hibernation	Provides for the lowest level of power consumption. When you execute this command, the state of the system and state of the peripheral devices are written to the hard disk and the system power is turned off. To return the system to the original state, use the power switch to turn on power.
Fn+D Video standby	Turns off the LCD in order to save power.
Fn+F Change Display size	Zooms the display size in or out when the display is set to 640 x 480 display mode.

Using the Touchpad

The keyboard contains a cursor-pointing device called a touchpad. You can point to, select, drag, and scroll objects on the screen using the built-in touchpad..

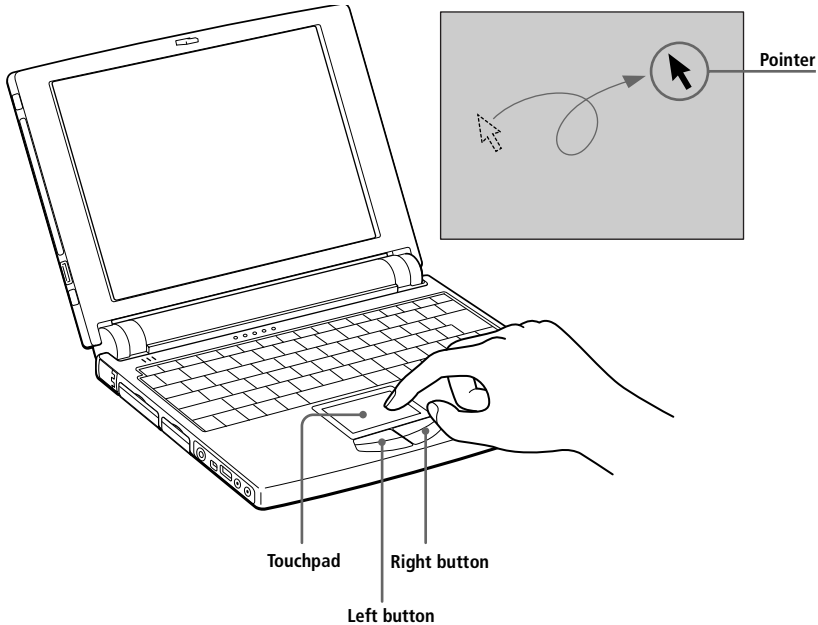

<i>Actions</i>	<i>Descriptions</i>
Point	Slide one finger on the touchpad to place the pointer on an item or object.
Single-click	Press the left button once.
Double-click	Press the left button twice.
Right-click	Press the right button once. In many applications, this action displays a shortcut menu of context-sensitive choices.
Drag	Slide one finger while pressing the left button.
Scroll	Move your finger along the right edge of the touchpad.



The scroll function is available only with applications that support a touchpad scroll feature.

Using the Plastic Pen

The plastic pen, located in the vinyl bag with your user manual, can be used on the touchpad for drawing or for signing your name with the ScribblePad software. You can store the pen in the pen compartment on the left side of the LCD screen.

To use the pen compartment

- 1 Press the bottom of the pen compartment to open it.

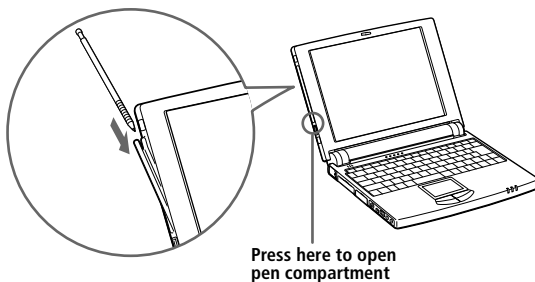

- 2 Slide the pen in or out of the compartment to store or remove it.
- 3 When you are ready to close the pen compartment, press the top of the compartment until it clicks into place.



The supplied plastic pen is designed to be used only on the touchpad.

Do not use this pen on any surface other than the touchpad including the computer's LCD; it may damage the LCD.

Store the pen in the pen compartment when you are not using it.

Using ScribblePad

ScribblePad is an application that lets you create memos by writing on the touchpad using the supplied plastic pen.

To use ScribblePad

- 1 Click the Start button on the Windows 98 taskbar.
- 2 Point to Software Center, point to Applications, and then click ScribblePad.
- 3 Press the F10 key.

ScribblePad enters tablet mode. In this mode the touchpad corresponds with the ScribblePad screen. This means that what you write on the touchpad appears on the screen in the corresponding location. For example, when you write letters on the left corner of the touchpad, the letters appear on the left corner of the screen.

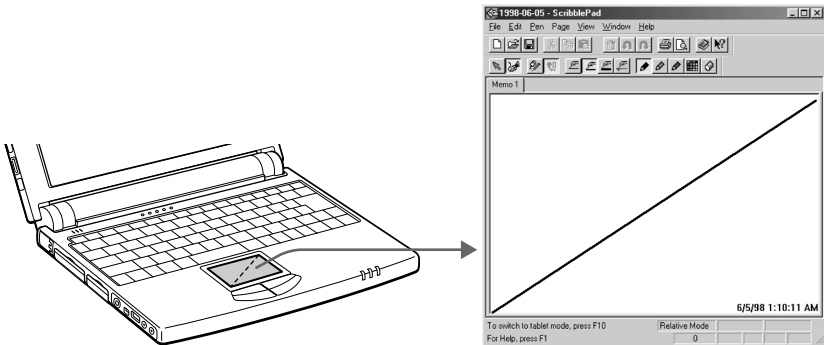

- 4 To write, move the pen slowly on the touchpad.

When you remove the pen from the touchpad, the letters you wrote on the touchpad appear on the screen.

You can also use the computer's keyboard to enter letters, and the BackSpace or Delete keys to delete letters.





To learn more about ScribblePad, click Help on the ScribblePad screen to display the online help file.

Using the Floppy Disk Drive

You can connect the floppy disk drive to the Floppy Disk Drive (FDD) connector on your computer:

To connect the floppy disk drive

- 1 Turn off the computer.
- 2 Open the cover of the  FDD connector.
- 3 Plug the floppy disk drive cable into the  FDD connector. The VAIO logo on the disk drive should be facing up.

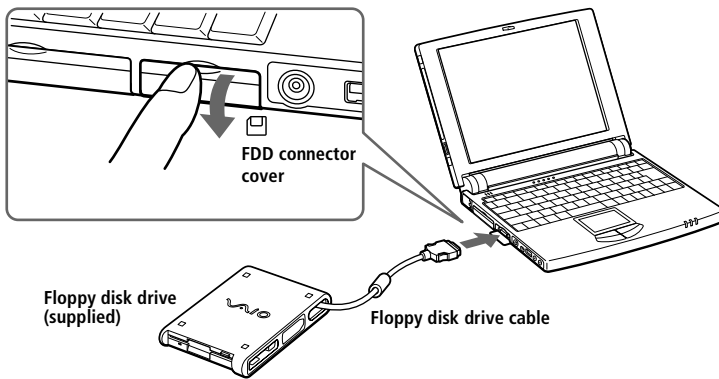

To insert a diskette

- 1 Hold the diskette with the label side facing up.
- 2 Gently push the diskette into the drive until it clicks into place.

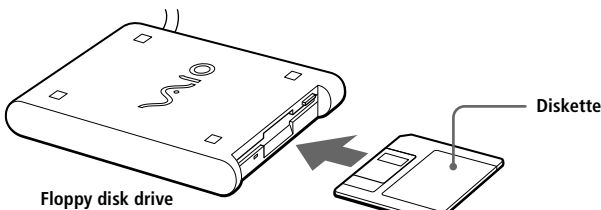

To remove a diskette

- When you finish using the diskette, wait until the LED indicator turns off and then press the Eject button to remove the diskette.

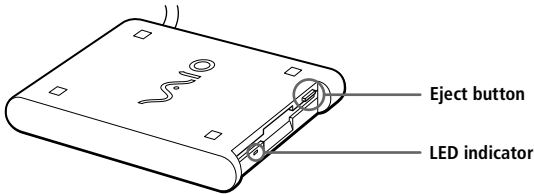

To remove the floppy disk drive

- 1 Turn off the computer.
- 2 Press both sides of the floppy disk drive cable and unplug the cable from the computer.

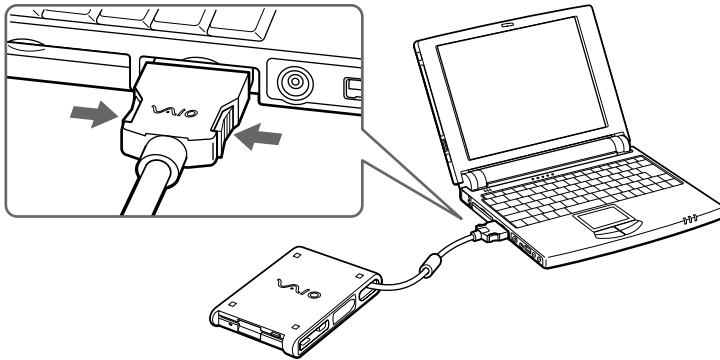

- 3 Fold the floppy disk drive cable into the compartment on the side of the floppy disk drive.

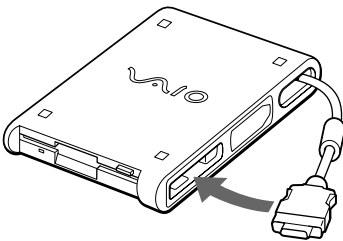

Using PC Cards

Your computer includes a PC card slot. PC cards allow you to connect portable external devices, such as a CD-ROM drive, additional memory, or to connect to a network.

 The PC card slot can accommodate one Type II PC card. This slot is compatible with Card Bus and ZV (Zoomed Video) port.

Some PC cards may require that you disable idle devices when using the PC card. You can use Sony Notebook Setup to disable devices. See "Displaying the Sony Notebook Setup Screen" on page 53.

Be sure to use the most recent software driver provided by the PC card manufacturer.

If an "!" mark appears on the Device Manager tab in the System Properties dialog, remove the software driver and then reinstall it.

To insert a PC card .

 You do not need to shut down the computer before inserting or removing a PC card.

To insert the supplied PC card modem, refer to "Connecting a PC card modem" on page 34.

- 1 Pull the PC card release button up away from the computer and push it in towards the computer.

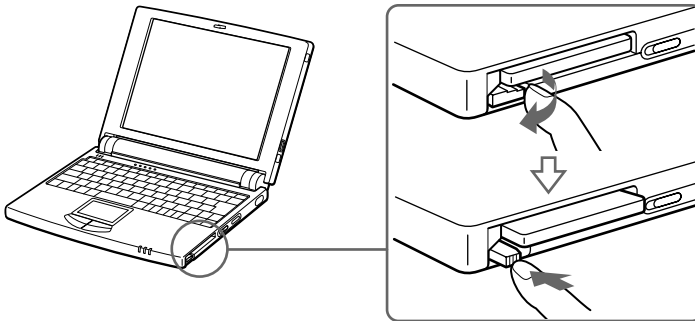

- 2 Remove the PC card slot protector.

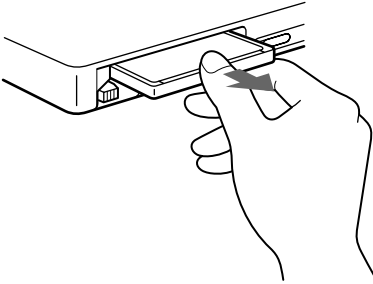

- 3 Insert the PC card into the PC card slot, front label facing up. Gently push the card into the slot until the card is fixed into the connector. The release button comes out.

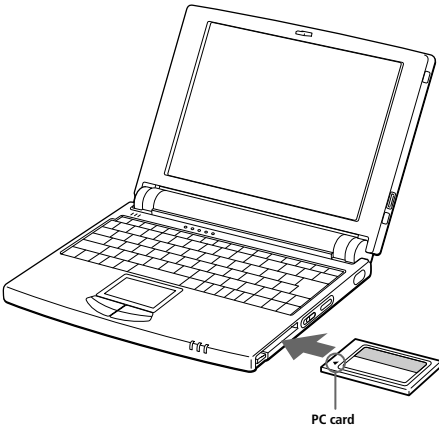

Do not force a card into the slot. It may damage the connector pins.

If you have difficulty inserting a card, check that you are inserting the card with the correct orientation (see PC card label)

Some PC cards may require you to disable unused devices using Sony Notebook Setup. See "Displaying the Sony Notebook Setup Screen" on page 53.

Use the latest driver software provided by the PC card's manufacturer.

If you see the "!" mark on the PC card in "Device Manager" tab of "System Properties", remove the driver software and reinstall it.

See the manual that came with your PC card for more information on its use.

To remove a PC card

- 1 Pull the PC card release button up and press it in towards the computer.

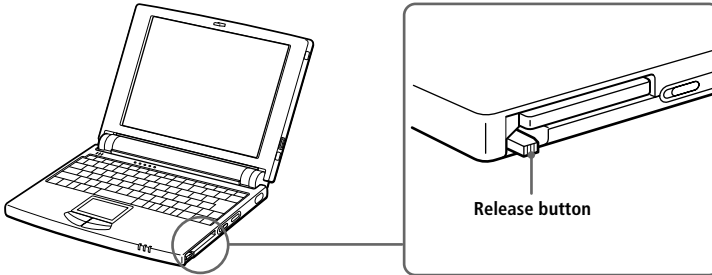

- 2 Gently grasp the card and pull it out.
- 3 Insert the PC card slot protector into the empty slot. Lock the release button.



Before you remove the PC card, click the PC card icon in the taskbar and close the card.

Close any applications that use the PC card before removing the card. Otherwise data may be lost.

Using Infrared Communication Devices

Your computer includes an infrared port, located on the right side of the computer. You can use this port to communicate with other infrared-equipped devices with compatible protocols, such as a digital still camera or other computers.

To use infrared communication with a digital still camera

Align the infrared ports on the computer and the digital camera so that they are in a direct line..

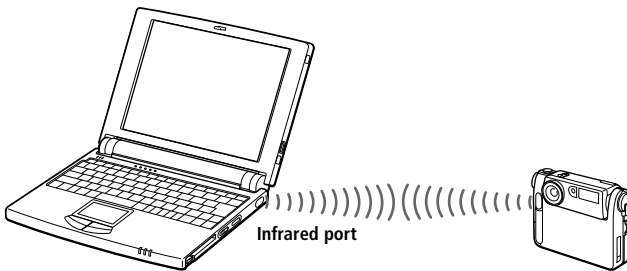

When performing a data transfer with any software using infrared, enable the IrDA in the Control panel of Windows, as follows (Do not use the icon in the taskbar):

1. In the Control panel, choose Infrared, then Options;
2. Check Enable infrared communication, then click OK.
3. As soon as your transfer is finished, disable Infrared, in the Control panel, to reduce the power consumption.

To use infrared communication with another computer

Align the infrared ports on the two computers so that they are in a direct line.

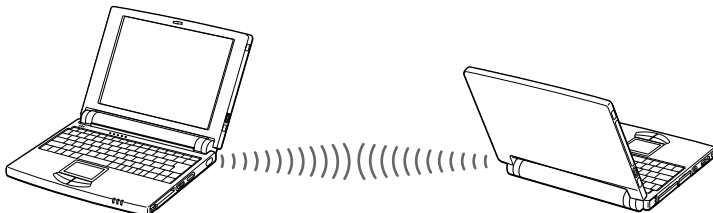

When you transfer files directly from devices other than the internal hard disk drive, such as a CD-ROM drive or hard disk drive on a network, set the System Suspend and System Hibernation timers to off.

Check the Status tag of the Infrared Monitor in the Windows Control Panel to determine if the infrared device is detected.

If the two devices are too far apart or too close together, data transfer may be interrupted or there may be noise in the transmission.

Do not cover the infrared ports with your hand or any other objects.

Avoid direct sunlight, fluorescent light, or flashing incandescent light near the infrared ports.

See the manual that came with your digital still camera or other infrared communication device for more information on installation and use.

The active area of infrared transmission extends about 1m (39 inches) with a radius of 15 degrees.

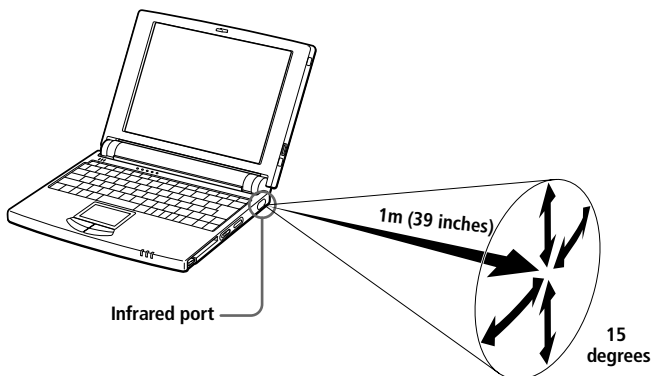

Using Power Saving Modes

When you use a battery as the source of power for your computer, you can take advantage of power management settings to conserve battery life. In addition to the normal operating mode, which allows you to turn off specific devices, your computer has two distinct power saving modes: System Suspend and System Hibernation. When using battery power, you should be aware that the computer automatically enters System Hibernation mode when the remaining battery charge drops below 7%, regardless of the power management setting you select.



If your battery level falls to less than 10%, you should either attach the AC adapter to recharge the battery or shut down your computer and insert a fully charged battery.

Normal Mode

This is the normal state of your computer when it is in use. The green power indicator light is on in this mode. To save power, you can turn off a specific device such as the LCD or the hard disk.



For details, see "Controlling Power Management" on page 55.

System Suspend Mode

The computer saves the current state of the system in RAM and switches off power to the CPU. The amber power indicator light flashes in this mode.

To activate System Suspend mode

Press Fn+Esc, or you can slide the power switch forward and release the switch immediately. You can also use the PowerPanel utility to enter System Suspend mode.

To return to normal mode

Press any key.

System Hibernation Mode

The state of the system is saved on the hard drive and power is turned off. The power indicator light is off in this mode.

To activate System Hibernation mode

Press Fn+F12. You can also use the PowerPanel utility to enter System Hibernation mode.

To return to normal mode

Turn on the computer by sliding the power switch forward. The computer returns to its previous state.



When returning from System Hibernation mode, the system status stored on the hard disk is erased and the computer starts normally if you slide the power switch forward and hold for more than four seconds.

- Steps to reduce Power consumption:
Normal mode → System suspend → System hibernation
System Suspend uses more power than System Hibernation
- Steps Time to return to normal mode:
System hibernation → System suspend → Normal mode
System Suspend requires less time than System Hibernation

Connecting Peripheral Devices

You can add functionality to your computer by connecting any of these peripherals:

- ❑ PC card modem (supplied) (page 34)
- ❑ CD-ROM drive (supplied) (page 36)
- ❑ Port replicator (supplied) (page 39)
- ❑ Printer (page 41)
- ❑ External display (page 42)
- ❑ External mouse or keyboard (page 44)
- ❑ Desktop computer or serial device (page 45)
- ❑ External speakers (page 46)
- ❑ Digital video camera recorder (page 48)
- ❑ Universal Serial Bus (USB) device (page 49)



Before you connect peripherals, turn off the computer and all peripherals.

Connect the AC adapter only after connecting all cables.

Turn on the computer only after turning on all peripherals.

Connecting a PC card modem

Connecting to a phone line

You need to connect a phone line to take advantage of online services, the Internet and to register your computer and software online

 In order to register your Sony VAIO Mini Notebook Computer, register your software online, and use Sony Online Support, you must connect to a phone line. Also, you must register your computer to receive the extended warranty.

- 1 Use the PC card slot of your notebook computer. Pull the PC card release button away from the computer. Remove the PC card slot protector as described in the "Using PC cards" chapter, page 26. Insert the PC card modem (supplied) in the slot of the computer (label facing up), push it gently until the release button ejects completely. Put back the release button.

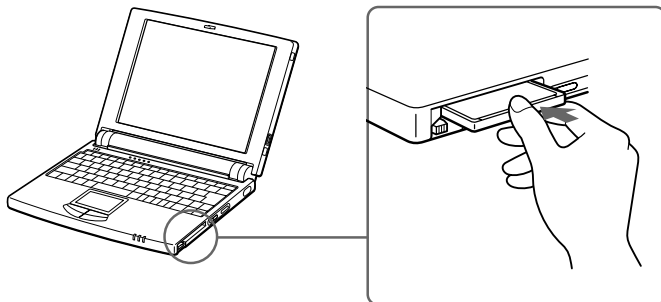

- 2 Plug the phone line jack into the left connector of the PC card.
- 3 Plug the other end into the wall jack (use the phone plug supplied)

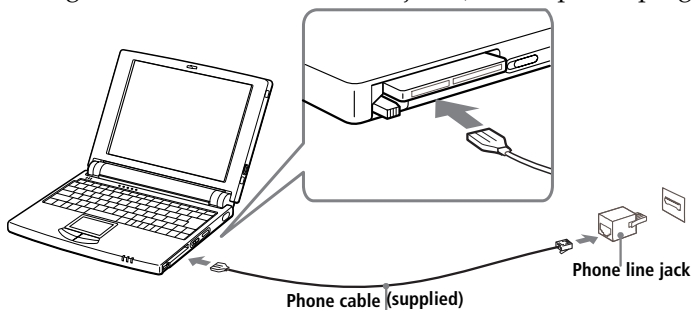

 Use the supplied communication tool which provides a full range of features: fax, data, telephone directory. See "About Your Sony Notebook Computer" for details. Phone cable and connectors: TNV (Telecommunication Network Voltage), according to EN60950.

Other connections

This PC card modem can be connected to GSM and ISDN networks.

Connecting to a GSM

Your PC card modem is ready for connection to the Sony CMD-Z1 GSM phone (cable not supplied). Plug the cable in the right connector of the PC card. Plug the other end into the GSM phone.

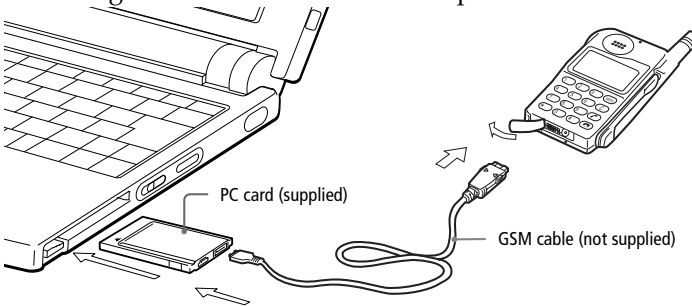

<i>Models of GSM</i>	<i>Card programming</i>
Sony CMD-Z1 and Z1 Plus	Ready
Sony CM-DX1000	Ready to be re-programmed (program supplied on your Hard Disk and Recovery CD-ROM).
Other GSM phones	See your retailer.

Connecting to an ISDN line

Your PC card modem is ready for connection to ISDN (Digital Network offering transmission of voice, data, fax). See your retailer for all information and accessories.

Connecting the CD-ROM Drive

You can use the supplied PCGA-CD5 CD-ROM drive with your notebook computer.

-  The pick-up cover is attached to the lens of the CD-ROM drive at the factory setting. Remove it before using the CD-ROM drive.

To connect the CD-ROM drive

- 1 Turn off your computer.
- 2 Remove the PC card slot protector from the PC card slot. See “Using PC Cards” on page 26 for details.
- 3 Connect the CD-ROM drive cable to the PC card supplied with the CD-ROM drive.

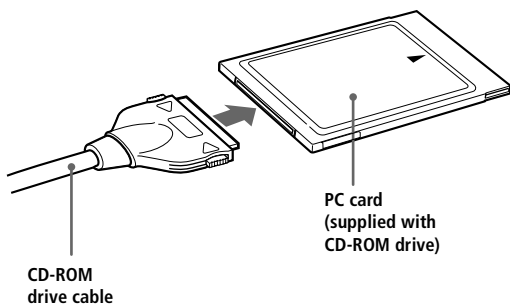

- 4 Insert the PC card into the PC card slot with the label side facing up. See “Using PC Cards” on page 26 for details.

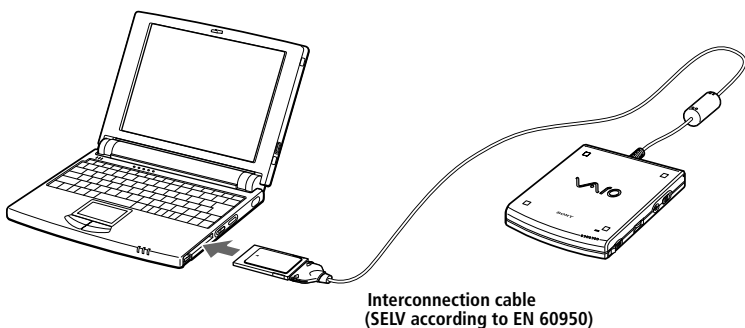

- 5 Connect the CD-ROM drive AC power adapter to the CD-ROM drive and plug the AC adapter into an AC outlet.

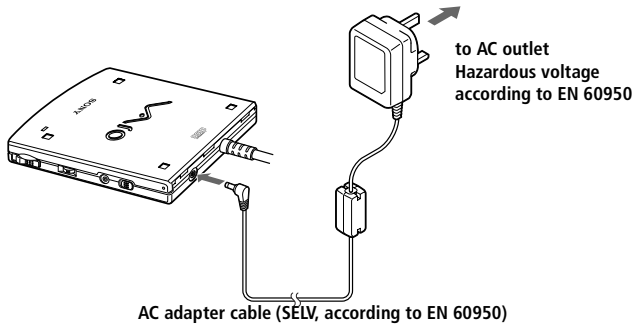

-  Use your CR-ROM drive only with the supplied AC adapter. To disconnect your notebook completely from mains voltage, unplug the AC adapter.
- Please make sure that the socket outlet is easily accessible.

To insert a CD-ROM disc

- 1 Slide the power switch to the on position.
- 2 Slide the Open button in the direction of the arrow to open the CD-ROM drive lid.

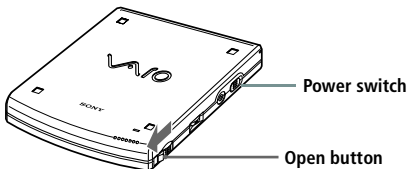

- 3 Place the CD-ROM disc in the tray with the label side facing up. Push the disc onto the hub until the disc clicks into place

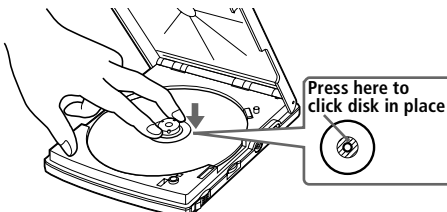

-  Be sure to seat the CD-ROM disc firmly over the CD-ROM drive hub fingers. If you do not seat the disc firmly, you could damage your CD-ROM drive.

- 4 Gently press on the CD-ROM drive lid until it clicks shut

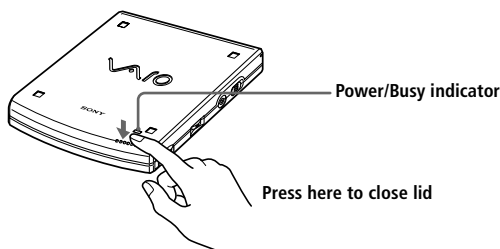

To play an audio CD in the CD-ROM drive

In addition to connecting the CD-ROM drive to your computer, you must connect the drive to the computer with a male-to-male stereo mini plug (not supplied).

- 1 Connect one end of the stereo mini plug to the headphone jack on the CD-ROM drive and the other end to the Line In jack on the left side of your computer.

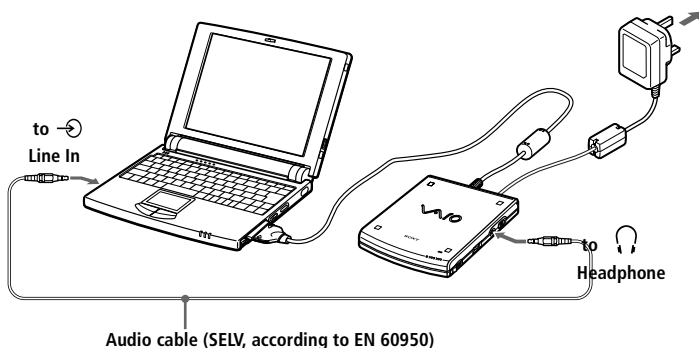

- 2 Right-click the speaker icon on the taskbar and select Open Volume Control from the shortcut menu. The Volume Control window opens.
- 3 Drag the Line In slider to adjust the volume.

To remove the CD-ROM drive

- Remove the PC card from the computer. See "Using PC Cards" on page 26 for details.

Connecting the Port Replicator

You can use the supplied PCGA-PR5 port replicator to connect peripheral devices such as a printer or external display.

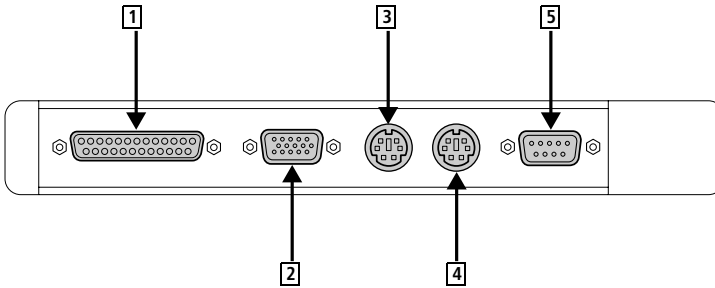

1 Printer (page 41)

2 Monitor (page 42)

3 Mouse (page 44)

4 Keyboard (page 44)

5 IOIO Serial (page 45)

To attach the port replicator

- 1 Turn off the computer.
- 2 Open the port replicator connector cover on the left side of the computer.

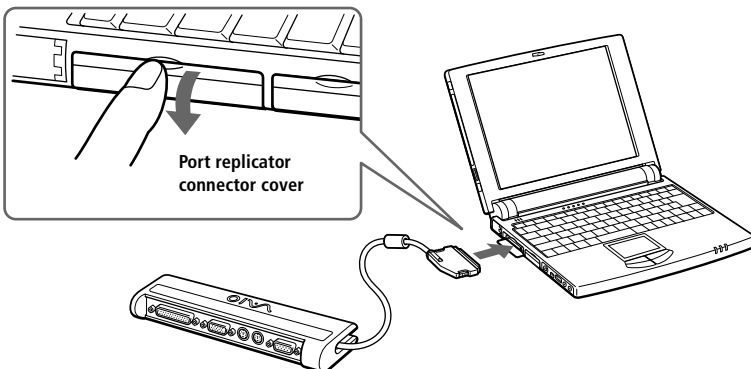

- 3 Plug the port replicator cable into the port replicator connector on the computer.



All connectors of this port replicator are SELV (Safety Extra Low Voltage) according to EN 60950.

To remove the port replicator

- 1 Turn off the computer.
- 2 Press both sides of the port replicator cable and unplug the cable from the computer.

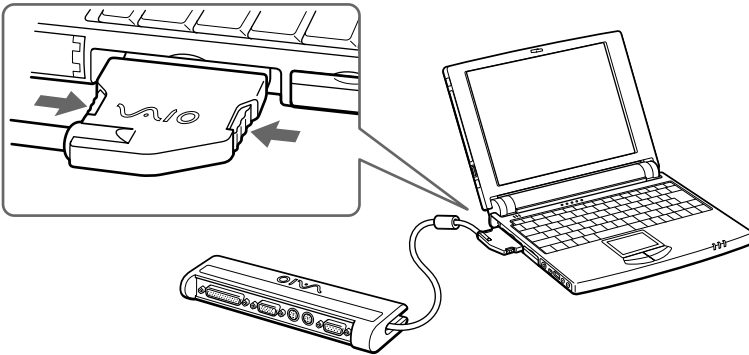

- 3 Fold the port replicator cable into the compartment on the side of the port replicator.

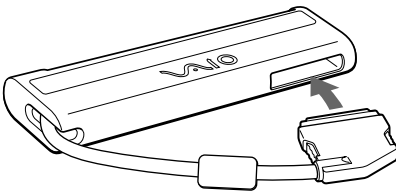

 If you do not turn off the computer before removing the port replicator, you must turn off the computer before reattaching the port replicator.

Connecting a Printer

You can use the port replicator to connect a Windows 98-compatible printer or other parallel port device to your computer.

To connect a printer

- Use the  symbol to locate the Printer connector on the port replicator. Plug the printer cable (supplied with the printer) into this connector.

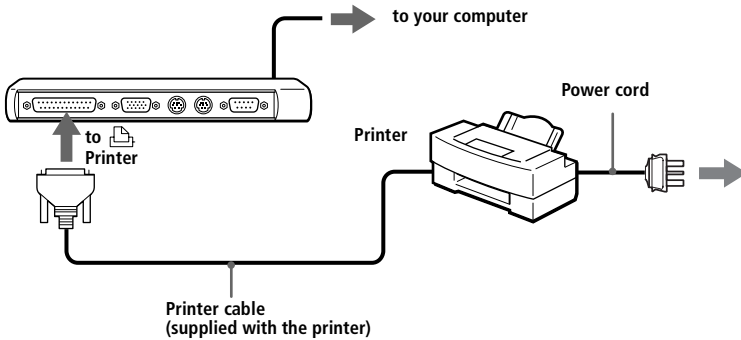

See the manual that came with your printer for more information on installation and use.

Before using the printer, you may need to change the Printer setting in the Sony Notebook Setup software. See Cross ref.

Connecting an External Display

You can use the port replicator to connect an external display to your notebook computer. For example, you can use the computer with any of the following:

- ❑ Computer display (monitor) (page 42)
- ❑ Multimedia computer display (page 43)
- ❑ Projector (page 43)

To connect a computer display

- ❑ Use the  symbol on the port replicator to locate the Monitor connector. Plug the display cable into this connector.
- ❑ If necessary, plug one end of the display power cord into the display, and the other end into an AC outlet.

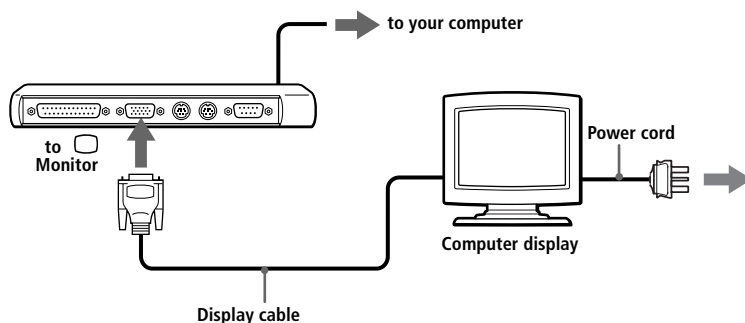

See the manual that came with your computer display for more information on installation and use.

To connect a multi media display or a projector

You can connect the notebook computer to a multimedia computer display that includes built-in speakers and a microphone.

You can use a projector as an external display, such as the Sony LCD Projector.

- 1 Use the □ symbol to locate the Monitor connector. Plug the display RGB signal cable into this connector.
- 2 Use the Ω symbol to locate the Earphone Headphone connector. Plug the speaker audio cable into this connector.

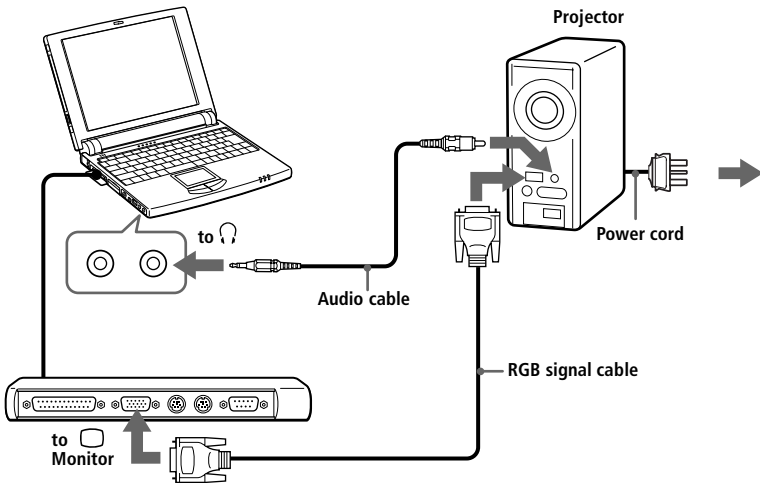

- 3 Use the ⦿ symbol to locate the Microphone connector. Plug the microphone cable into this connector.





See the manual that came with your displays for more information on installation and use.

Connecting an External Mouse and Keyboard

You can use the port replicator to connect an external mouse and keyboard to your computer. The Mouse and Keyboard connectors require a PS/2™-style plug or adapter.

To connect an external mouse and keyboard

- 1 Turn off the computer.
- 2 Use the  and  symbols to locate the Mouse and Keyboard connectors. Plug the mouse cable and keyboard cable into these connectors with the  mark facing up.

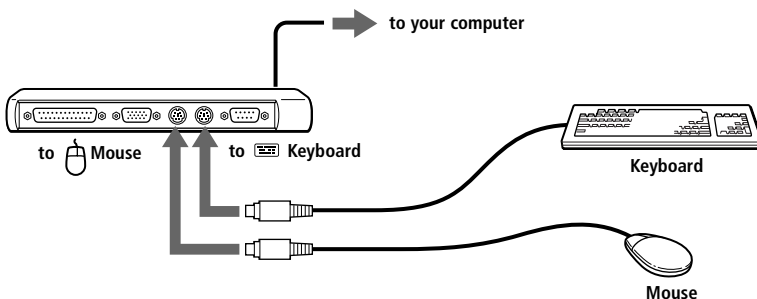

 See "Using the Keyboard" on page 16 for more information on using the keyboard.

See the manual that came with your mouse or keyboard for more information on installation and use.

Before you connect or disconnect the mouse or keyboard, turn off the computer.

Before connecting a mouse to the Serial port, make sure the mouse is compatible with a Serial port.

You cannot use the built-in touchpad and an external mouse at the same time.

Connecting a Desktop Computer or Serial Device

You can use the port replicator to connect your notebook computer to another computer, or to connect other peripherals, such as the Sony Digital Still Camera.

To connect a desktop computer

- ❑ Use the  symbol to locate the Serial connector. Plug the connecting cable into this port on the port replicator and into the serial port on the desktop computer.

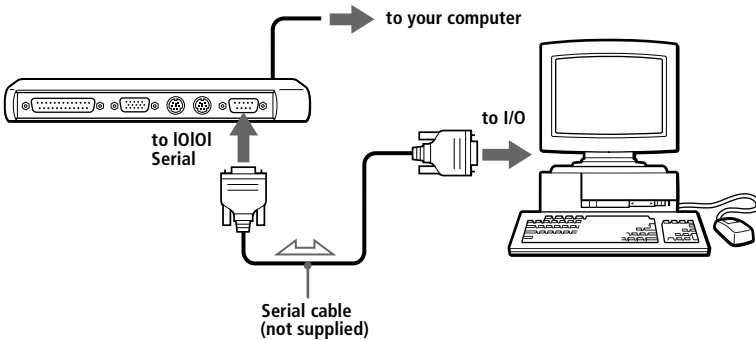

To connect a digital still camera

- ❑ Use the  symbol to locate the Serial connector. Plug the connecting cable into this port on the port replicator and into the Digital I/O connector on the digital still camera.

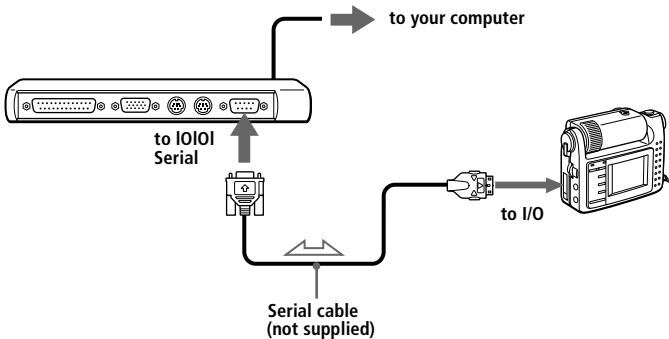

The Sony Digital Still Camera (DSC-F1) is pictured; you may need to connect your camera differently.

See the manual that came with your digital camera or other serial device for more information on installation and use.

You can connect the DSC-F1 to your computer either through the Serial port or by using infrared communication.

If you use a digital camera that has an infrared data communication system or other infrared communication device, see "Using Infrared Communication Devices" on page 29.

Connecting External Speakers

You can use the optional PCGA-SP5 stereo speakers with your computer or other speakers designed for computer use.



Turn down the volume of the speakers before you connect them.

To adjust the speaker volume, press Fn+F4. See "Combinations and Functions with the Windows 98 Key" on page 18 for details.

Do not place diskettes near the speakers: the speaker's magnetic field may damage the data on the diskettes.

The internal speaker does not work when the external speakers are connected.

To connect the PCGA-SP5 stereo speakers

- Insert the speakers into the slots on the sides of the display.

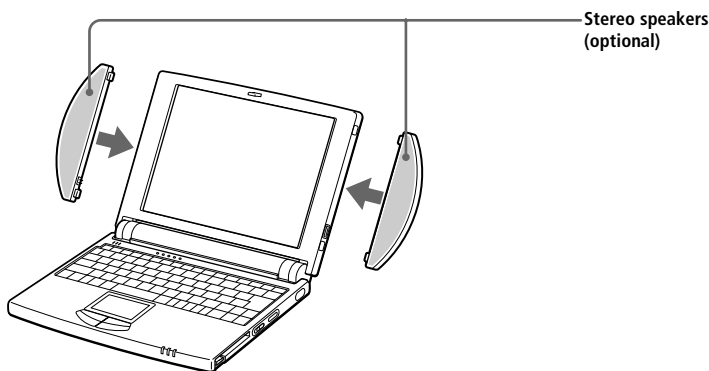

To connect other external speakers

- Use the  symbol to locate the Headphone connector. Plug the speaker cable into this connector.

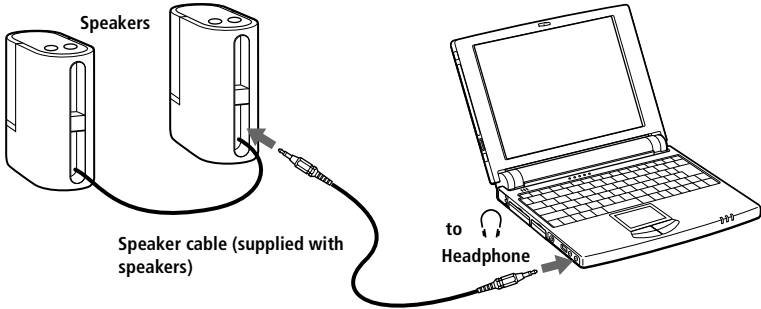

See the manual that came with your speakers for more information on installation and use.

Connecting a Digital Video Camera Recorder

You can connect a digital video camera recorder to the 200  i.LINK™ (IEEE1394) connector on your computer.

To connect a digital video camera recorder

Plug one end of an i.LINK cable into the 200  i.LINK connector on the left side of the computer and the other end into the DV-Out connector on the digital video camera recorder.

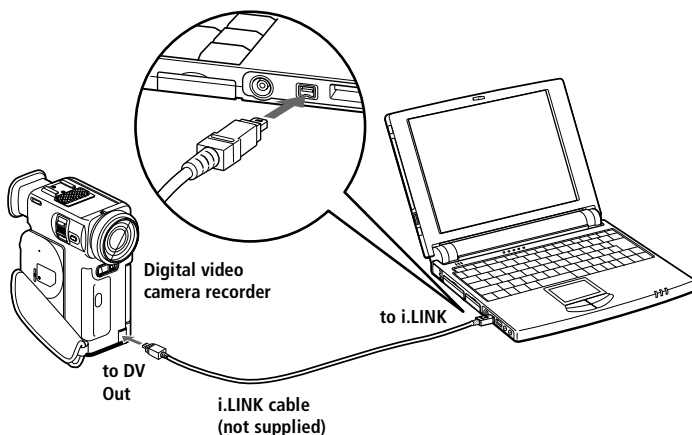

 The Sony digital video camera recorder (DCR-PC7) is pictured; your digital video camera recorder may need to be connected differently.

On Sony digital video cameras, connectors labeled "DV-Out" or "i.LINK" are i.LINK-compatible.

See the manual that came with your digital video camera recorder for more information on installation and use.

The i.LINK connector on the docking station does not supply power to external devices generally powered by i.LINK connectors.

The VAIO MicroNotebook Computer supports transfer rates up to 200 Mbps; however, the actual transfer rate is the lowest transfer rate of the external device.

The i.LINK features available may vary depending on the software applications you use. See the documentation that came with your software for more information.

Connecting a Universal Serial Bus (USB) Device

You can connect a USB device to your computer.

To connect a USB device

- Use the Ψ symbol to locate the USB connector on the left side of the computer. Plug one end of a USB cable into this port and the other end into the USB device.

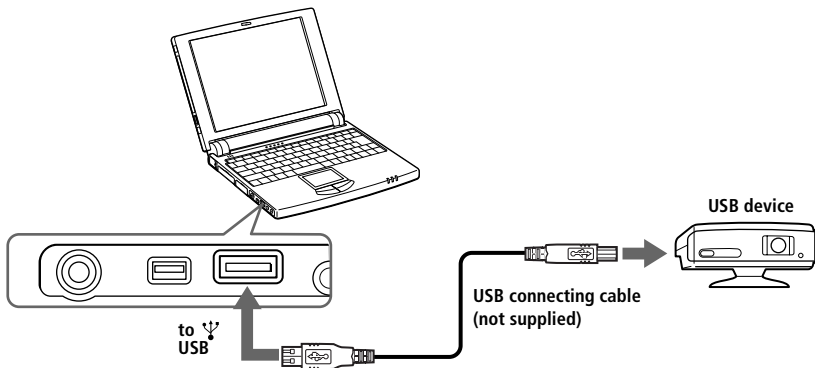

 See the manual that came with your USB device for more information on installation and use.

When you make the PowerPanel timer setting that allows your computer to enter system suspend or system hibernation mode, your computer may enter system suspend or system hibernation mode while you are using the USB device, such as a USB mouse or USB keyboard. Therefore, when using USB devices, select AC Profile or change the profile setting in PowerPanel so that the computer does not enter system suspend or system hibernation mode. In the factory preset setting, AC Profile does not allow the computer to enter system suspend or system hibernation mode. For details, refer to the PowerPanel Help.

Using the Media Bar

The Media Bar allows you to play audio and video from a CD in the CD-ROM drive, or from audio or video files in various formats on your hard drive.

To start the Media Bar

- 1 Click the Windows 98 Start menu.
- 2 In the Programs menu, select Media Bar. The Player bar appears as a single control bar across the top of the screen, with buttons similar to the controls on a VCR or CD-player remote control.



To expand the Media Bar

You can expand the bar to double-height to access more functions by clicking the Expand button (▼) at the far right. To return to single height, click the Restore button (▲).

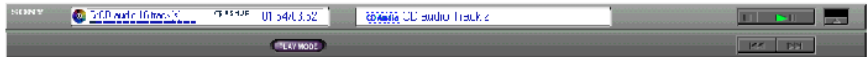

To change the Player bar to a floating window

To change the bar into a floating window, drag the bar to the center of the screen. The bar opens into a window with File, Control, and Help menus.

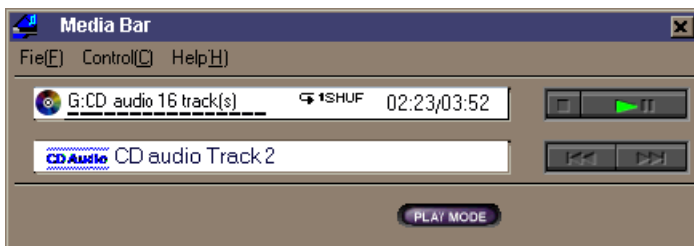

Media Bar Functions

You can use the Media Bar to:

- ❑ Start and stop the playback of audio or video CDs or files.
- ❑ Navigate through files or selections on a CD.
- ❑ Pause and resume playback at the point where play left off.
- ❑ Set up automatic playback modes, including:
 - ❑ Repeat all of the selections in order.
 - ❑ Repeat a single selection.
 - ❑ Play all of the selections in a random order.

Video images display in a separate Movie window, which you can move and resize (to full screen). If the CD supports PlayBack Control (for example, Video CD-ROM format), you can select specific scenes or still images by their assigned numbers.



The Media Bar features extensive and detailed in online help. To access online help, right-click the Player Bar and select Help from the shortcut menu.

Customizing Your Notebook Computer

You can customize the settings of your notebook computer. The following sections briefly describe how to change your computer's default settings. You can also refer to the Sony Notebook Setup Help for more detailed information.

Displaying the Sony Notebook Setup Screen

To display the Sony Notebook Setup screen:

- 1 Click the Start button on the Windows 98 taskbar.
- 2 Point to Sony Folder, then Assistance and click Sony Notebook Setup.

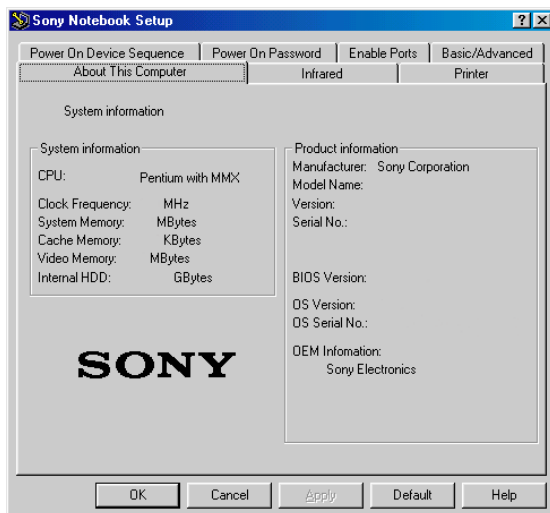

- 3 Select the tab for the item you want to change. See "Notebook Setup Tabs" on page 54.
- 4 After you finish, click OK.

Notebook Setup Tabs

<i>Tab</i>	<i>Descriptions</i>
About This Computer	Display system information, including memory capacity, serial number, and BIOS version.
Infrared	Change the infrared communication settings depending on the infrared equipment your computer is using to communicate.
Printer	Change printer port mode settings.
Power On Device Sequence	Select the order of drives and devices from which you want to load the operating system.
Power On Password	Set the password to secure your computer.
Enable Ports	Enabling or disabling ports releases resources to the system. To change the serial, audio, and modem settings, click Advanced on the Basic/Advanced tab.
Basic/Advanced	Toggle between Advanced mode (additional screens with advanced settings) and Basic mode of display. Advanced mode includes Serial, Audio and View Resources tabs.





For more information about each option, click Help on the Sony Notebook Setup screen to display the help file.

Controlling Power Management

The PowerPanel utility allows you to control the power management of your notebook computer and provides key information about system activity and battery life. The following sections briefly describe how to conserve your computer's battery power. You can also refer to the PowerPanel Help for more detailed information.



Power Management Profiles

PowerPanel provides several predefined power management profiles. Each profile consists of a group of specific power management settings that are designed to meet specific power management goals—ranging from maximum power management to no power management. You can change the settings for any of the predefined profiles or you can create your own profile to suit your portable computing needs. The predefined profiles are:

<i>Icon</i>	<i>Description</i>
	Maximum Performance – Provides the best system performance while still conserving power.
	Maximum Battery Life – Provides power saving features to give you maximum battery life and good performance. It reduces the brightness of the display, slows the computer, and puts it into System Suspend mode after a specified time period.
	AC Profile – The power management state when AC power is in use. Similar to the Power Management Off setting. PowerPanel automatically loads the AC profile unless you disable this feature.

Other available profiles

Configure PowerPanel with some other profiles: right click on the Toolbar and choose Customize:

	Power Management Off – Turns off all power management features such as System Suspend and System Hibernation modes.
	Games – Disables the display and the Hard Disk Spindle Down timer.



Presentation – Keeps the display on at all times while it conserves power. This option is ideal for slide show presentations. You can establish settings for LCD (Video) Standby, Hard Disk Sleep, and System Suspend to optimize power management for your system.



Word Processing – Optimizes power management with longer timeouts on the hard disk and display screen. You can also establish settings for LCD (Video) Standby, Hard Disk Sleep, and System Suspend to optimize power management for your system.



Communications – Extends battery life by initiating a quick display timeout. You can also establish settings for LCD (Video) Standby, Hard Disk Sleep, and System Suspend to optimize power management for your system.

Power Management Commands

PowerPanel also provides power management commands that you can use to activate specific power management functions and to control power for a specific device. You might use these commands when you want to override a profile setting or initiate an immediate action, such as putting the system into Video Standby mode before the Video Standby timer expires.



System Suspend – Puts the system into System Suspend mode, a power management state that saves the state of the system and peripheral devices in memory (RAM). Power consumption reduces to a minimum, and the system remains on. To return the system to the active state, press any key or the power switch on your computer.



System Hibernation – Provides for the lowest level of power consumption. The system writes the state of the system and peripheral devices to the hard disk and turns off the system power. To return the system to the original state, use the power switch to turn on power. The system saves the data in the Save to Disk Partition on the hard drive.



LCD (Video) Standby – Turns off the LCD to save power. If you turn off the Video Standby timer, the display remains active except when the system enters System Suspend mode. The video display system is one of the largest consumers of power in the system.



Hard Disk Sleep – Turns off the hard disk spindle motor. Although you can manually turn off the power to the hard disk through this command, any system request to the hard disk turns on the power to the hard disk.



PC Card – Controls the PC card sockets. Click this button to open the PC Card (PCMCIA) Properties dialog box. You can view the properties for the PC cards.



Speed Controller - Controls the speed at which the CPU performs. Click this button to open the Speed Controller dialog box. When you select the Auto checkbox, the CPU performs at full speed while the system is active and at 25% of full speed during periods of inactivity. Auto is the recommended option. You can also choose to run the CPU at 100%, 75%, 50%, or 25% of full speed regardless of whether the system is active or inactive. Using this command can help conserve battery power.

To activate PowerPanel

- 1 Double-click the  (PowerPanel) icon on the taskbar.

The Profiles toolbar appears. When you move the pointer over the atom icon on the taskbar, a tooltip with the name of the active power management profile appears.



- 2 Click the button you want to set.

The power management settings associated with the profile you select become active.



To display the Commands toolbar, right-click an empty portion of the toolbar and select Commands from the context menu. Refer to the PowerPanel Help for information on customizing the PowerPanel toolbars.

Displaying Battery Information

You can display detailed information for the battery in your computer. The following sections briefly describe how to display your computer's general battery information. You can also refer to the BatteryScope Help for more detailed information.

Activating BatteryScope

To activate BatteryScope

- 1 Click the Start button on the Windows 98 taskbar or double click the battery icon.
- 2 Point to Sony Folder, then Assistance and click BatteryScope.

When you move the pointer over the battery icon on the taskbar, a tooltip appears indicating the total capacity remaining in the battery and the estimated time until the battery fully discharges.

You can also view battery gauges on the shared PowerPanel and BatteryScope toolbar.





Percentage indicator

Displays the percentage of the remaining capacity.

Time indicator

Displays estimated time (hours/minutes) remaining before the battery fully drains, also referred to as the time-to-empty.

Battery Icon Descriptions

Battery icon	Battery status
	Discharging
	Charging
	No battery

Displaying Detailed Battery Information

You can obtain detailed information about the batteries.

- ❑ Click the battery icon on the toolbar to display the BatteryScope window.

The screen appears displaying the Battery tab, which contains information such as the estimated time-to-empty and the charging time.

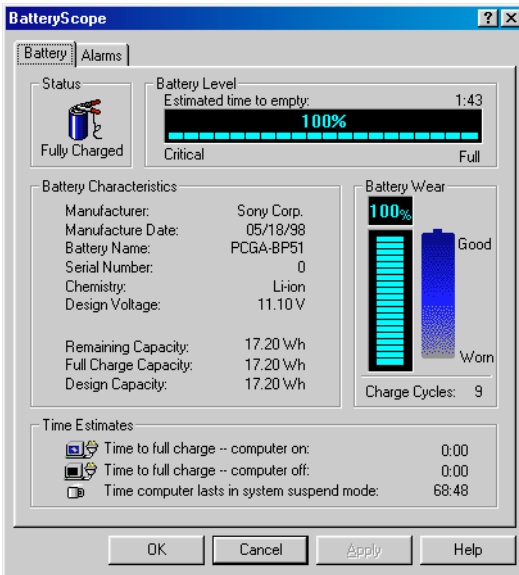

To customize the BatteryScope toolbar and alarm system

You can customize the BatteryScope toolbar to suit your portable computing needs, including modifications to the alarm settings. Refer to the BatteryScope Help for more information.

Starting Your Favorite Software With Programmable Power Key (PPK) Setup

The PPK Setup software enables you to start your favorite software by simply pressing the programmable power key.

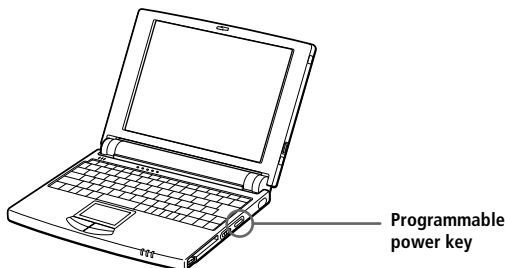

This section briefly describes how to use the programmable power key. You can also refer to the PPK Setup Help for more detailed information.

To use the PPK Setup screen:

- 1 Double-click the PPK Setup icon on the taskbar. The PPK Setup screen appears.

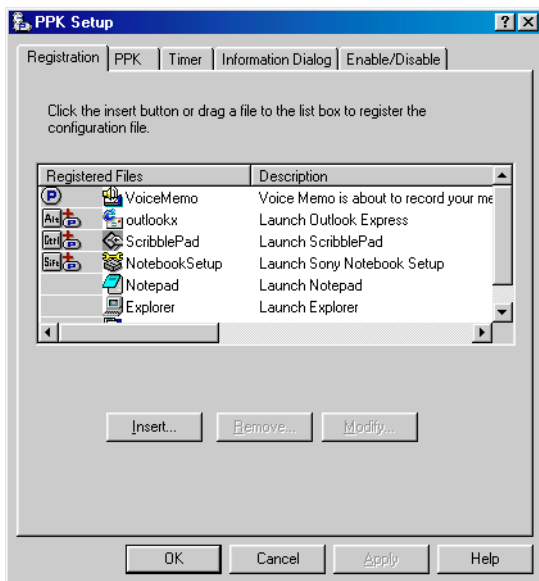

- 2 Select the software title you want PPK to launch automatically from the Registered Files list and right-click. The Setup options screen appears.
- 3 Click Set as PPK launch file. The  appears next to the selected software title.
- 4 Click OK.



The default settings for PPK do not allow you to start the selected software when the computer's LCD is closed. To start the selected software while the LCD is closed, click the Enable/Disable tab and select Enable PPK even if LCD Panel is closed. Be aware, however that the software can now start accidentally if you press the programmable power key when you carry the computer.

Using the Programmable Power Key With Other Keys

You can also choose to start other applications by pressing the programmable power key in combination with the Alt, Ctrl, or Shift keys.

To select the key combination, right-click the application you want to start and select an item from the menu. When you select Set as PPK launch file, you can turn on the power and start the selected application by just pressing the programmable power key. When you select Set as Alt+PPK launch file, Set as Ctrl+PPK launch file, or Set as Shift+PPK launch file, you need to turn on the computer to use these functions.

Using the internal timer:

You can use the internal timer to start software at a specific time. You can use this feature when the computer is in normal, system suspend mode.



If the computer's LCD is closed, you cannot use the internal timer to start software using the default settings. To start software while the LCD is closed, click the Enable/Disable tab and select the checkbox next to Enable Timer launch even if LCD Panel is closed.

It may take some time to actually start the software. It is advised that you confirm the time your selected software takes to start.

Selecting the Display Mode

When you connect an external display, you can toggle the display mode between the LCD on your computer and an external display.

- 1 Click the Start button on the Windows 98 taskbar.
- 2 Point to Settings and click Control Panel.
- 3 Click Display.
- 4 Click the Settings tab.
- 5 Click the Advanced button.
- 6 Click the NeoMagic® tab.

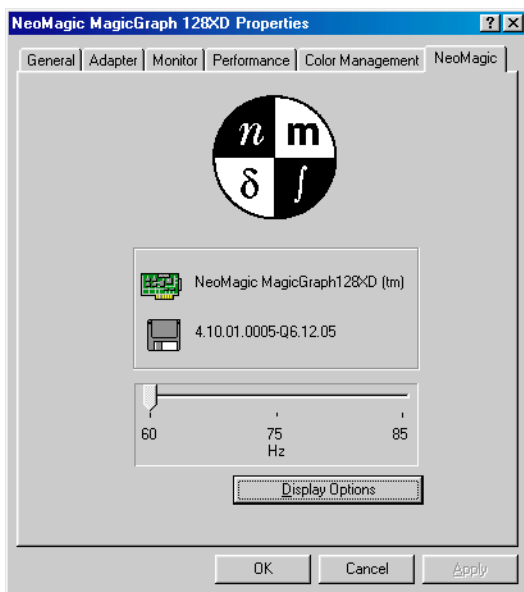

- 7 Click Display Options.
- 8 Select one of the options under Display Mode:

<i>Display modes</i>	<i>Functions</i>
Monitor	Displays only an external display connected to the Monitor connector on the port replicator.
LCD Panel	Displays only the Liquid Crystal Display (LCD) on your computer.
Monitor/LCD	Displays simultaneously both the LCD and an external display connected to the Monitor connector on the port replicator.

9 Click OK.



You can adjust the refresh rate when you select Monitor as the display mode.

Some displays do not support using both the computer's LCD and an external display simultaneously.

To use the Monitor and Monitor/LCD display modes, an external display must be connected to the monitor connector on the port replicator.

Getting Help

This section describes how to get help and support from Sony, as well as troubleshooting tips for your computer.

About Sony's Support Options

Sony provides several support options for your Sony computer. When you have questions about your computer and the pre-installed software, check these sources for answers, in the following sequence:

- ❑ **This guide** explains how to use your computer, connect peripheral devices, use the utility programs, and perform basic computer tasks. It is included with your computer as an electronic document.
- ❑ **The online help files** that accompany your pre-installed software contain instructions on using the software.
- ❑ **The *About Your Sony Notebook Computer*** guide lists the pre-installed software titles. This guide also includes a packing list and technical specifications for your notebook computer. It is included with your computer as an electronic document.
- ❑ **The *Sony Service Guide*** gives you complete information on communicating with VAIO Link Response Centre. Please also refer to this guide to get extended warranty conditions.
- ❑ **The *VAIO Channel*** offers on-line information about your notebook computer and other Sony products that work with your computer. Just click the VAIO Channel button on your Channel Bar to access the www.
- ❑ **The *Club VAIO*** offers you a full range of tips and tricks at the address: <http://www.club-vaio.com>.
- ❑ **The *VAIO Link***: If you have some problems with your computer, you can contact VAIO Link by telephone, fax or e-mail (see your *Customer Service Guide* and VAIO Space for phone numbers). Before calling VAIO Link, try to solve the problem by reading your User Guide

(troubleshooting chapter) or the manuals and helpfiles of the peripherals or software.

- **The Sony e-mail support service** answers your questions by electronic mail. Just send your question in an e-mail message, and a Customer Service Analyst will send you a reply with the answer. To send a question to Sony e-mail support, please refer to the instructions in your *Customer Service Guide*.

Troubleshooting

This section describes how to solve common problems you may encounter when using your computer. Many problems have simple solutions, so try these suggestions before you call VAIO Link.



When you reconnect devices, be sure to turn off the computer as described in “Shutting Down Your Computer” on page 13. If you turn off the computer in other ways, it may result in data loss.

My computer doesn't start

- ❑ Check that the computer is plugged into a power source and that it is turned on. Check that the power indicator on the front panel of the computer indicates that the power is on.
- ❑ Check that the battery is inserted properly and that it is charged.
- ❑ Make sure there is no diskette in the floppy disk drive.
- ❑ Confirm that the power cord and all cables are connected firmly, as described in “Connecting Peripheral Devices” on page 33.
- ❑ If you plugged the computer into a UPS, make sure the UPS is turned on and working.
- ❑ If you are using an external display, check that it is plugged into a power source and turned on. Check that the brightness control is adjusted correctly. See the manual that came with your display for details.
- ❑ Moisture condensation may have occurred. Do not use the computer for at least one hour and then turn on the computer.

My LCD does not display anything

- ❑ Check that the computer is plugged into a power source and that it is turned on. Check that the power indicator on the front panel of the computer is on.
- ❑ Check that the battery pack is inserted properly and that it is charged.
- ❑ The computer may be in LCD (Video) Standby mode. Press any key to activate the display.
- ❑ The video output may be directed to an external display attached to the port replicator. Press Fn+F7 until video output appears on the LCD.

The screen image on my external display is not centered or sized properly

Use the controls on your external display to adjust the image. See the manual supplied with your display for more information.

Movements of the displayed images are awkward (not smooth).

Use the PowerPanel to select Change CPU Speed. Remove the check from Auto and set Speed Controller to 100%.

The video image on my screen is too dark

If an external display is connected to the Monitor connector, disconnect the display.

My computer "locks up"

- ❑ Try restarting the computer. On the Windows taskbar, click the Start button, click Shut Down, and then click Restart the computer.
- ❑ If you cannot restart as described in the preceding step, you can restart the computer by pressing Ctrl+Alt+Delete twice.
- ❑ If the previous step does not work, slide the power switch toward the front and hold it for four seconds. This turns off the power.
- ❑ If your computer locks up while playing a CD-ROM, stop the CD-ROM, and restart the computer by pressing Ctrl+Alt+Delete twice.



Pressing Ctrl+Alt+Delete twice or turning off the computer with the power switch may result in data loss in files that are currently open.

My software program "locks up" or crashes

Contact the software publisher or designated provider for technical support. See "About Your Sony Notebook Computer" for a complete list of addresses.

I cannot play a CD-ROM disc

- ❑ Make sure that the switch of the CD-ROM drive is turned on.
- ❑ Make sure the label of the CD-ROM is facing up.
- ❑ If the CD-ROM disc requires software, make sure the software is installed according to the program's instructions.
- ❑ Moisture condensation may have occurred. Disconnect the CD-ROM drive and disconnect the power to the drive for at least one hour.
- ❑ Make sure the CD-ROM drive is properly connected. See "Connecting the CD-ROM Drive" on page 36.
- ❑ Make sure the computer is turned on.

When I click an application icon a message appears, such as “You must insert the application CD into your CD-ROM drive”, and the software does not start

- ❑ Some titles require specific files that are located on the application’s CD-ROM disc. Insert the disc and try starting the program again.
- ❑ Make sure you place the disc in the tray with the label side facing up.

My floppy disk drive cannot write to a diskette

- ❑ The diskette is write-protected. Disable the write-protect feature or use a diskette that is not write-protected.
- ❑ Check that the diskette is properly inserted into the floppy disk drive.

My speaker has no sound

- ❑ The built-in speaker is turned off. Press Fn+F3 to turn on the speaker.
- ❑ The speaker volume is turned to the minimum. Press Fn+F4, and then press **↑** or **→** to increase the volume.
- ❑ If your computer is powered by the battery, check that the battery is connected properly and that it is charged.
- ❑ If you are using an application that has its own volume control, check that the volume is turned up.
- ❑ Check the volume controls in Windows 98.
- ❑ If you connect external speakers, check that the speakers are properly connected and the volume is turned up. If the speakers have a mute button, make sure it is off. If the speakers are powered by batteries, check that the batteries are inserted properly and that they are charged.
- ❑ If you have connected a headphone or an audio cable to the Headphone connector, disconnect the cable.

When I press Fn+F3, I see the message “Muting”

Click the Volume icon in the Windows 98 taskbar. When the Volume cursor appears, disable “Mute” by clicking this option. You can also disable “Muting” by pressing Fn+F3 again.

My modem (PC card) doesn’t work

- ❑ Check that your PC card is properly inserted in your computer (label side facing up).
- ❑ Check your PC card modem has been detected by the system. See “Connecting a PC card modem” on page 34.
- ❑ Check that the phone line is plugged into your PC card. See “Connecting a PC card modem” on page 34 for details.

- ❑ Check that the phone line is working. You can check the line by plugging in an ordinary phone and listening for a dial tone.
- ❑ Check that the phone number the program is dialing is correct.
- ❑ If you connect a GSM phone, make sure that the programming of the supplied PC card is compatible with it: use the supplied card loader to re-program it (refer to your card's user manual).
- ❑ Make sure that the driver selected in your communication software is matching the programming of your PC card (refer to your communication software user manual).
- ❑ Check that the software you are using is compatible with the provided PC card (refer to your software user manual).

My modem connection is slow

Many factors influence modem connection speed, including telephone line noise or compatibility with telephone equipment (such as fax machines or other modems). If you think your modem is not connecting properly to other PC-based modems, fax machines, or your Internet Service Provider, check the following:

- ❑ Have your phone company check that your phone line is free from any line noise.
- ❑ If your problem is fax-related, check that there are no problems with the fax machine you are calling and that it is compatible with fax modems.
- ❑ If you are having a problem connecting with your Internet Service Provider, check that the ISP is not experiencing technical problems.
- ❑ If you have a second phone line available, try connecting the modem to that line.

My mouse doesn't work

If you are using an external mouse, check that the mouse is plugged into the mouse connector. See "Connecting an External Mouse and Keyboard" on page 44 for details.

My touchpad interprets a single tap as a double-click

- ❑ Open the Mouse folder in the Control Panel and change the button assignments in the Mouse Properties dialog box. One of the buttons is assigned to the double-click action.
- ❑ If you have connected an external mouse while your computer is on, you should restart your computer.

I cannot use DV devices. The message "DV equipment seems to be disconnected or turned off" appears.

- ❑ Check that the DV device is turned on and that the cables are properly connected.
- ❑ If you are using multiple i.LINK devices, the combination of the connected devices may cause unstable operation. In this case, turn off the power to all connected devices and disconnect unused devices. Check the connection, then turn on the power again.

My computer does not shut down

It is best to shut down your computer using the Shut Down command on the Windows 98 Start menu. Using other methods, including those listed here, may result in loss of unsaved data. If the Shut Down command does not work properly, follow these steps:

- ❑ Restart the computer by pressing Ctrl + Alt + Delete twice. If this does not work, slide the power switch forward and hold it for at least four seconds, this turns off the power.
- ❑ Unplug the computer from the AC adapter and remove the battery pack from your computer.

My PC card is not working

- ❑ Make sure the PC card is compatible with Windows 98.
- ❑ Use the Sony Notebook Setup utility to disable devices you are not currently using.

I cannot print.

- ❑ Check that all the cables of the port replicator and the printer are correctly connected.
- ❑ Check that your printer is correctly configured and that you have up to date drivers (See "Connecting a Printer" on page 41.If needed, contact your dealer).
- ❑ Use the Sony Notebook Setup utility to change the printer port setting.

Movements of the displayed images are awkward (not smooth).

- ❑ Use the PowerPanel to select Change CPU Speed. Remove the check from Auto and set Speed Controller to 100%.

Using the Product Recovery CD-ROM

The following sections describe how to use the Recovery CD-ROM.

The Product Recovery CD-ROM allows you to perform:

- ❑ A full system recovery
- ❑ An application recovery
- ❑ A manual reinstallation of device drivers

You may need to recover the entire contents of your hard drive, in case of a serious system crash. In this instance, perform a system recovery.

If you encounter a problem with your computer, probably caused by a badly configured system, reinstalling an individual device driver may solve the problem.

Another problem could be that a pre-installed application doesn't work properly anymore. Reinstalling the appropriate application should fix the problem. Consequently, you should perform an application recovery.

Performing a System Recovery.

Use this option only when your system is seriously damaged. For example: Windows 98 does not work anymore, or your PC behaves abnormally... The system recovery will completely reinstall the originally configured system on your PC.



You can only use this Recovery CD-ROM on the Sony notebook you purchased and not on any other Sony PC or other manufacturer's PC!

! Applying a system recovery means that you will lose all your data stored on the hard drive. Therefore, before applying a system recovery, save your data stored on the hard disk to an external disk. If this is not possible under Windows 98, try to save your data from the DOS-prompt to a floppy.

! CAUTION: ensure that your computer is connected to AC (not the batteries) before you attempt a System Recovery.

! CAUTION: when the recovery is performed, you must remove the recovery CD-ROM from the drive before restarting the computer. If the CD-ROM is still in the drive, you will restart a recovery process.

Procedure for a System Recovery



The PCGA-CD5 CD-ROM drive must be connected to the computer to use the System Recovery CD.

You need to complete the Windows® 98 registration process when you use the Product Recovery CD-ROM. Make sure you have the product ID number located on the cover of your Microsoft Windows 98 "Getting Started" manual. You will need this number to complete the recovery process.

- 1 Connect your CD-ROM drive to the notebook, insert the Sony Product Recovery CD-ROM and turn on your computer (using AC power only).
- 2 The system recovery screen appears next. If you're really sure that you do not mind losing all your data, choose 'Yes'.
- 3 You will get a final warning. If you choose 'Go', all data will be removed permanently and the recovery process will start.



The recovery process takes between 10 to 20 minutes to complete.

- 4 When the Windows Setup Wizard appears, confirm that you have read and accepted the Microsoft End-User License Agreement, enter the Product ID mentioned on your Certificate of Authenticity for Windows. Then, follow the on-screen instructions to complete the recovery process.



If your computer does not start the Windows Setup, refer to your Customer Service Guide to call VAIO-Link by phone or by fax.

Performing an Application Recovery (via the Install Manager).

The Install Manager allows you to reinstall individual applications. Reinstallation of a program can fix the problems encountered in a program that does not run correctly anymore.



You must run the Recovery CD from Windows 98.
The application will not run from DOS.

Procedure for an application recovery

- 1 Turn on your computer (using AC power only) and wait until Windows 98 is booted up.

- 2 Insert the Recovery CD. The Application Recovery utility now loads automatically.
- 3 When the Application Recovery menu appears, follow the on-screen instructions to choose the application you want to recover.



When performing an application recovery, you do not lose data.

Reinstalling a device driver

First check whether the driver you plan to reinstall is on the Product Recovery CD-ROM. Only device drivers that are not delivered with Windows 98 can be found in the directory drivers (in G:\Drivers). Check all underlying sub-directories for the appropriate driver. Next, launch the 'Add New Hardware' wizard (in the Windows start menu, select settings, then control panel) to install the appropriate device.

Notes on Use

This section describes safety guidelines and precautions to help protect your computer from potential damage

On Upgrading the System

Due to the use of high precision components and the technology of the electronic connectors of your Notebook computer and memory modules, to avoid the invalidation of your Guarantee by mishandling, Sony Corporation recommends that:

- ❑ you contact your dealer to install a new memory module,
- ❑ you do not install it yourself,
- ❑ you do not touch the connectors or open the memory panel.

Please call VAIO Link if you need assistance.

On Handling the LCD Screen

- ❑ Do not leave the LCD facing the sun as it can damage the LCD. Be careful when using the computer near a window.
- ❑ Do not scratch the LCD or exert pressure on it. This could cause a malfunction.
- ❑ Using the computer in low temperature conditions may produce a residual image on the screen. This is not a malfunction. When the computer returns to normal temperature, the screen returns to normal.
- ❑ A residual image may appear on the screen if the same image is displayed for a lengthy period of time. The residual image disappears in a while. You can use a screen saver to prevent residual images.
- ❑ The screen becomes warm during operation. This is normal and does not indicate a malfunction.
- ❑ The LCD is manufactured using high-precision technology. You may, however, see tiny black points and/or bright points (red, blue, or

green) that continuously appear on the LCD. This is a normal result of the manufacturing process and does not indicate a malfunction.

On the Power Source

- ❑ Your computer operates on 100V-240V AC 50/60 Hz.
- ❑ Do not share the AC outlet with other power-consuming equipment, such as a copying machine or shredder.
- ❑ You can purchase a power strip with a surge protector. This device prevents damage to your computer caused by sudden power surges such as those that may occur during an electrical storm.
- ❑ Do not place heavy objects on the AC adapter or its cord.
- ❑ To disconnect the cord, pull it out by the plug. Never pull the cord itself.
- ❑ Unplug your computer from the wall outlet if you will not be using the computer for a long time.
- ❑ When the AC adapter is not used, unplug it from the AC outlet, to save energy.
- ❑ Use only the AC adapter supplied. Do not use any other AC adapter.

On Handling

- ❑ Clean the cabinet with a soft, dry cloth or a soft cloth lightly moistened with a mild detergent solution. Do not use any type of abrasive pad, scouring powder, or solvent such as alcohol or benzine, as these may damage the finish of your computer.
- ❑ Should any solid object or liquid fall into the computer, shut down your computer and then unplug it. You may want to have the computer checked by qualified personnel before operating it any further.
- ❑ Do not drop the computer or place heavy objects on top of the computer.

On Installation

- ❑ Do not place your computer in a location subject to:
 - ❑ Heat sources, such as radiators or air ducts
 - ❑ Direct sunlight
 - ❑ Excessive dust
 - ❑ Moisture or rain
 - ❑ Mechanical vibration or shock

- ❑ Strong magnets or speakers that are not magnetically shielded
- ❑ Ambient temperature of more than 35° C or less than 10° C
- ❑ High humidity
- ❑ Do not place electronic equipment near your computer. The computer's electromagnetic field may cause a malfunction.
- ❑ Provide adequate air circulation to prevent internal heat build-up. Do not place your computer on porous surfaces such as rugs or blankets, or near materials such as curtains or draperies that may block its ventilation slots.
- ❑ The computer uses high-frequency radio signals and may cause interference to radio or TV reception. Should this occur, relocate the computer a suitable distance away from the set.
- ❑ Use only specified peripheral equipment and interface cables; otherwise, problems may result.
- ❑ Do not use cut or damaged connection cables.

On Moisture Condensation

If the computer is brought directly from a cold location to a warm one, moisture may condense inside your computer. In this case, allow at least an hour before turning on your computer. If any problems occur, unplug your computer, and contact VAIO Link.

On Handling Diskettes

- ❑ Do not open the shutter manually and touch the surface of the diskette.
- ❑ Keep diskettes away from magnets.
- ❑ Keep diskettes away from direct sunlight and other heat sources.

On Handling CD-ROM Discs

- ❑ Do not touch the surface of the disc.
- ❑ Do not drop or bend the disc.

On Cleaning CD-ROM Discs

- ❑ Fingerprints and dust on the surface of a disc may cause read errors. Proper care of the disc is essential to maintain its reliability. Do not use solvents such as benzine, thinner, commercially available cleaners or anti-static spray, as they may cause damage to the disc.
- ❑ For normal cleaning, hold the disc by its edge and use a soft cloth to wipe the surface from the center out.

- ❑ If the disc is badly soiled, moisten a soft cloth with water, wring it out well, and use it to wipe the surface of the disc from the center out. Wipe off any remaining moisture with a dry soft cloth.

On Using Batteries

- ❑ Never leave the battery pack in temperatures above 60° C, such as in a car parked in the sun or under direct sunlight.
- ❑ Battery life is shorter in a cold environment. This is due to decreased battery efficiency at low temperatures.
- ❑ Charge the batteries at temperatures between 10° C to 30° C. Lower temperatures require a longer charging time.
- ❑ While the battery is in use or being discharged, the battery pack heats up. This is normal and is not a cause for concern.
- ❑ Keep the battery pack away from all sources of heat.
- ❑ Keep the battery pack dry.
- ❑ Do not open or try to disassemble the battery pack.
- ❑ Do not expose the battery pack to any mechanical shock.
- ❑ If you are not using the computer for an extended period of time, remove the battery pack from the computer to prevent damage to the battery.
- ❑ If, after fully charging the battery pack, the battery power is still low, the battery pack may be reaching the end of its life and should be replaced.
- ❑ You do not need to discharge the battery before recharging.
- ❑ If you have not used the battery pack for a considerable amount of time, recharge the battery.

On Maintenance

- ❑ Make sure to disconnect the AC adapter before cleaning the computer.
- ❑ Avoid rubbing the LCD screen as this can damage the screen. Use a soft, dry cloth to wipe the LCD screen.
- ❑ Clean the computer with a soft cloth lightly moistened with a mild detergent solution. Do not use any type of abrasive pad, scouring powder or solvent, such as alcohol or benzine.

Index

A

- About This Computer tab **54**
- About Your Sony Notebook Computer **2, 65**
- AC adapter **8**

- AC power **8**
- AC Profile power setting **55**
- accessing online support **14**
- adding
 - hardware **33**
 - peripherals **33**
 - printers **41**
- adjusting
 - brightness **20**
- air circulation **77**
- Alt key **17**
- Application Recovery **73**
- Applications key **17**
- attaching port replicator **39**

B

- Basic/Advanced tab **54**
- battery pack **9, 78**
 - charge status icons **58**
 - charging **10**
 - connector **6**
 - indicator light status **10**
 - indicator lights **5, 10, 19**
 - inserting **9**
 - loading **9**
 - power status **10**
 - rechargeable **8**
 - removing **11**
- battery packs **78**
 - charging **10**
 - inserting **9**
 - inserting into battery bay **9**
 - loading **9**
 - rechargeable **8**
 - removing **10**

- battery power **10**
- BatteryScope utility **58**
- brightness
 - adjusting **12, 20**
- built-in speaker **20**
 - volume **20**
- buttons
 - Finish **14**
 - left **5**
 - Open **37**
 - right **5**
 - Start (Windows 98) **13, 53**

C

- cameras
 - digital video recorder **48**
 - Sony Digital Still **45**
- canceling commands **17**
- Caps Lock **5**
 - indicator light **19**
- CD-ROM discs
 - cleaning **77**
 - handling **77**
 - inserting **37**
 - playing audio **38**
 - troubleshooting **68**
- CD-ROM drive
 - closing lid **38**
 - connecting **26, 36**
 - opening lid **37**
 - troubleshooting **68**
 - using **36**
- charge status indicator light **10**
- charging battery pack **10**
- charging battery packs **10**

- choosing
 - power source **9**
 - cleaning computer **76**
 - computer
 - cleaning **76**
 - condensation **77**
 - customizing **53**
 - lithium ion battery **iii**
 - setting up **5**
 - setup screen **53**
 - starting **12**
 - troubleshooting **67, 68**
 - Connecting **44**
 - connecting **34**
 - CD-ROM drive **26, 36**
 - digital still camera **45**
 - digital video recorder **48**
 - external keyboard **44**
 - external mouse **44**
 - external speakers **46, 47**
 - floppy disk drive **24**
 - GSM **35**
 - ISDN **35**
 - keyboard **44**
 - modem **34**
 - monitor **42**
 - network **26**
 - parallel devices **41**
 - phone line **34**
 - port replicator **39**
 - power source **8**
 - printer **41**
 - projector **43**
 - serial device **45**
 - USB device **49**
 - connectors
 - battery **6**
 - DC In **6, 8**
 - external speakers **6**
 - FDD **6, 24**
 - i.LINK **6**
 - infrared **7, 29**
 - keyboard **39**
 - monitor **39**
 - mouse **39**
 - parallel **41**
 - parallel port **39**
 - port replicator **6**
 - printer **39, 41**
 - Serial port **39**
 - USB **6**
 - correction keys **16, 17, 35**
 - Ctrl key **17**
 - cursor-movement keys **17**
 - customer assistance
 - support options **65**
 - customer support **66**
 - See also VAIO Link
 - customizing your computer **53**
- D**
- DC In **6, 8**
 - digital still camera **29**
 - connecting **45**
 - digital video camera **48**
 - diskettes
 - ejecting **25**
 - handling **77**
 - inserting into drive **24**
 - troubleshooting **69**
 - display
 - connector **39**
 - mode **62**
 - drives **36**
 - CD-ROM **36**
 - floppy disk **6, 24**
 - DV In/Out **6, 48**
- E**
- earphone **43**
 - Eject button **25**
 - ejecting
 - diskettes **25**
 - electronic
 - documentation **65**
 - ergonomic considerations **3, 4**
 - Escape key **17**
 - external devices
 - display **4**
 - See also monitor
 - keyboard **44**
 - mouse **44**

speakers **46, 47**
 External Display (connecting) **42**

F

FDD connector **6, 24**
 Finish button **14**
 floppy disk drive
 connecting **24**
 connector **6**
 disconnecting **25**
 troubleshooting **69**
 Fn key **17**
 combination commands **20**
 function keys **16, 17**

G

glare **3**
 GSM **35**
 guarantee **15**
 Guarantee card **15**

H

handling
 audio CDs **77**
 CD-ROM discs **77**
 diskettes **77**
 Hard Disk Sleep power setting **56**
 hard drive
 indicator light **5, 19**
 headphone
 connector **43**
 Help
 online **65**
 help **65**
 Hibernation Mode **32**

I

i.LINK **6, 48**
 IEEE1394 **6, 48**
 indicator lights **19**
 battery **5, 10, 19**
 Caps Lock **5, 19**
 charge status **10**
 hard drive **5, 19**
 Num Lock **5, 19**
 power **5**

Scroll Lock **5, 19**
 infrared communication devices **29**
 other computers **29**
 infrared port **7, 29**
 Infrared tab **54**
 infrared transmission
 active distance **30**
 troubleshooting **30**
 Insert key **17**
 inserting
 battery pack **9**
 diskettes into drive **24**
 installing
 hardware **33**
 memory **26**
 peripherals **33**
 interference **77**
 ISDN **35**

K

keyboard **5, 17**
 connecting **44**
 connector **44**
 external connector **39**

L

LCD **63, 75**
 lock lever **12**
 reducing glare **3**
 troubleshooting **67, 68**
 left button **5**
 lever
 LCD **12**
 lighting **3**
 Liquid Crystal Display screen
 See LCD
 lithium ion battery
 disposal **iii**
 safety precautions **iii**
 loading
 battery pack **9**
 location for computer **3**

M

maintenance **76, 78**
 Maximum Battery Life power setting

- 55
- Maximum Performance power setting
- 55
- memory module
 - installing 26
- microphone 5
 - connector 43
- modem 34
 - troubleshooting 69
- moisture condensation 77
- monitor 39, 63
 - connecting 42
 - connector 43
 - switching among 20
- mouse
 - connecting 44
 - connector 39
 - troubleshooting 70

N

- navigation keys 16, 17, 35
- network
 - connecting 26
- Normal Mode 31
- Notebook Setup tabs 54
- Num Lock 5
 - indicator light 19
- numeric keypad area 16

O

- online
 - help 65
 - support
 - options 65
- online help 65
- Open button 37
- opening
 - CD-ROM drive lid 37
- operator keys 17
- output devices
 - adding 41

P

- packing list 65
- parallel port 39, 41
- PC card 71

- inserting 26
- release button 26, 34
- removing 28
- slot protector 27
- slots 7, 26
- troubleshooting 71
 - Type II 26
- PC card modem 34
- Peripheral Devices 33
- plastic pen 6
- port replicator 6
 - connecting 39
- power 19
 - indicator light 5
 - programmable key 7
 - switch 7, 12
- Power Management
 - toolbar 57
- power management
 - settings 55
- Power Management Off power setting 55
- Power On
 - Device Sequence tab 54
 - Password tab 54
- power saving modes 31
 - System Hibernation 20, 32
 - System Suspend 31
 - system suspend 31
 - systemhibernation 32
 - Video Standby 20
- power setting
 - AC Profile 55
 - LCD (Video) Standby 56
 - Maximum Battery Life 55
 - Maximum Performance 55
 - Power Management Off 55
 - System Hibernation 56
 - System Suspend 56
- power sources 9, 76
 - connecting 8
- power standby
 - Hard Disk Sleep 56
- PowerPanel
 - activating 57
 - customizing toolbar 55, 56

- PPK **7**
 - precautions **77**
 - pre-installed software **65**
 - Print Screen key **17**
 - printer
 - connecting **41**
 - connector **39**
 - port **41**
 - Product **72**
 - Product Recovery CD-ROM **72**
 - programmable power key **7**
 - projector **43**
- R**
- radio interference **77**
 - rechargeable battery pack **8, 9**
 - rechargeable battery packs **8**
 - recharging battery pack **10**
 - recharging battery packs **10**
 - registering
 - Windows 98 **14**
 - your computer **15**
 - Registering Your Computer **15**
 - regulatory information **iii**
 - Reinstalling a device driver **74**
 - removing
 - battery pack **11**
 - battery packs **10**
 - diskettes **25**
 - floppy disk drive **25**
 - right button **5**
- S**
- screen
 - See LCD
 - ScribblePad **23**
 - plastic pen **6**
 - Scroll Lock **5**
 - indicator light **19**
 - selecting
 - power source **9**
 - Serial connector **39, 45**
 - serial devices
 - connecting **45**
 - digital still camera **45**
 - setting up
 - Windows 98 **14**
 - setup screen
 - About This Computer tab **54**
 - Basic/Advanced tab **54**
 - displaying **53**
 - Infrared tab **54**
 - Power On Device Sequence tab **54**
 - Power On Password tab **54**
 - setup tabs **54**
 - Shift key **17**
 - Shut Down Windows dialog box **13**
 - Sony e-mail support service **66**
 - Sony Notebook Setup screen **53**
 - Sony Online Support
 - options **65**
 - Sony Service Guide **65**
 - speakers
 - connectors **6**
 - external **46, 47**
 - troubleshooting **69**
 - Start button **13, 53**
 - starting
 - computer **12**
 - startup problems **13**
 - stylus **6**
 - Suspend Mode **31**
 - switching
 - display **20**
 - monitor **20**
 - System and Application Recovery CD
 - 72**
 - System Hibernation mode **20, 32, 56**
 - system hibernation mode **32**
 - System Recovery **72**
 - System Suspend mode **20, 31, 56**
 - system suspend mode **31**
- T**
- technical specifications **65**
 - technical support **65, 66**
 - support options **65**
 - touchpad **5, 21, 70**
 - troubleshooting **67**
 - startup **13, 67**
 - turning on
 - computer **12**

TV

- interference **77**

- TV interference **77**

U

USB

- connecting **47, 49**

- connector **6, 47, 49**

V

VAIO Link **65**

- response center **65**

- software **65**

- ventilation **77**

- video camera **48**

- Video Standby mode **20**

W

Windows 98

- Certificate of Authenticity **14**

- Control Panel **30**

- Explorer **18**

- Find window **18**

- Finish button **14**

- help **18**

- key **17**

- key combinations **18**

- License Agreement **14**

- registering **14**

- setup **14**

- Setup Wizard screen **14**

- Start button **13**

- taskbar **13, 68**