

SONY®

Television

Operating Instructions

Parts and Controls

Watching TV

Navigating through Home Menu

Viewing Pictures from Connected
Equipment

Additional Information

BRAVIA

KDL-40R48xB / 40R45xB / 32R43xB / 32R41xB

Table of Contents

IMPORTANT NOTICE	3
Safety information	3
Precautions	5

Parts and Controls

TV	7
Remote Control	8

Watching TV

Changing the Viewing Style	10
Changing the Wide Mode	10
Setting Scene Select	10

Navigating through Home Menu

Digital Programme List	11
Digital Electronic Programme Guide (EPG)	11
Applications	11
Using the TV as a Photo Frame	11
Listening to FM Radio (for Russia or Ukraine only)	12
Recordings	12
Photo Share (except KDL-40R45xB, KDL-32R41xB)	13
Media	13
Playing back Photo/Music/Video via USB	13
Settings	14
System Settings	14
Customer Support	21

Viewing Pictures from Connected Equipment

Connection Diagram	23
Using Audio and Video Equipment	24
Using Screen mirroring (except KDL-40R45xB, KDL-32R41xB)	25

Additional Information

Troubleshooting	26
Picture	26
Sound	27
Channels	27
General	27
Specifications	28

Introduction

Thank you for choosing this Sony product.
Before operating the TV, please read this manual thoroughly and retain it for future reference.

Note

- The "x" that appears in the model name corresponds to a numeric digit, related to design, colour or TV system.
- Before operating the TV, please read "Safety information" (page 3).
- Images and illustrations used in Quick Start Guide and this manual are for reference only and may differ from actual product appearance.

Location of the identification label

Labels for Model No., Production Date (month/year) and Power Supply rating (in accordance with applicable safety regulation) are located on the rear of the TV or package.

Labels for mains adaptor Model No. and Serial No. are located at the bottom of mains adaptor.

WARNING

TO PREVENT THE
SPREAD OF FIRE, KEEP
CANDLES OR OTHER OPEN
FLAMES AWAY FROM THIS
PRODUCT AT ALL TIMES.



NOTICE FOR CUSTOMERS IN THE UNITED KINGDOM

A moulded plug complying with BS1363 is fitted to this equipment for your safety and convenience.

Should the fuse in the plug supplied need to be replaced with the same rating of fuse approved by ASTA or BSI to BS 1362 (i.e., marked with ⚡ or ⚡) must be used.

If the plug supplied with this equipment has a detachable fuse cover, be sure to attach the fuse cover after you change the fuse. Never use the plug without the fuse cover. If you should lose the fuse cover, please contact your nearest Sony service station.

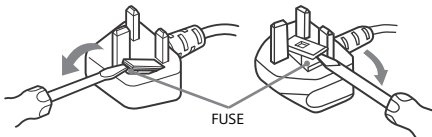

How to replace the fuse

Open the fuse compartment with a blade screwdriver, and replace the fuse.
Please refer to the illustration that actually equipped with the product.

IMPORTANT NOTICE

This product has been manufactured by or on behalf of Sony Corporation, 1-7-1 Konan Minato-ku Tokyo, 108-0075 Japan. Inquiries related to product compliance based on European Union legislation shall be addressed to the authorized representative, Sony Deutschland GmbH, Hedelfinger Strasse 61, 70327 Stuttgart, Germany. For any service or guarantee matters, please refer to the addresses provided in the separate service or guarantee documents.

Notice for Wireless Signal

Hereby, Sony Corporation declares that this unit is in compliance with the essential requirements and other relevant provisions of Directive 1999/5/EC.

For details, please access the following URL:
<http://www.compliance.sony.de/>



Safety information

WARNING

Batteries must not be exposed to excessive heat such as sunshine, fire or the like.

Installation/Set-up

Install and use the TV set in accordance with the instructions below in order to avoid any risk of fire, electrical shock or damage and/or injuries.

Installation

- The TV set should be installed near an easily accessible AC power outlet (mains socket).
- Place the TV set on a stable, level surface to avoid it from falling down and cause personal injury or damage to the TV.
- Only qualified service personnel should carry out wall installations.
- For safety reasons, it is strongly recommended that you use Sony accessories, including:
Wall-Mount Bracket
— SU-WL450
- Be sure to use the screws supplied with the Wall-Mount Bracket when attaching the mounting hooks to the TV set. The supplied screws are designed as indicated by illustration when measured from the attaching surface of the mounting hook.
The diameter and length of the screws differ depending on the Wall-Mount Bracket model.
Use of screws other than those supplied may result in internal damage to the TV set or cause it to fall, etc.

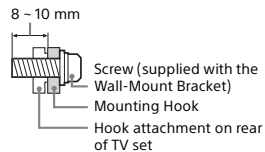

Transporting

- Before transporting the TV set, disconnect all cables.
- Two or three people are needed to transport a large TV set.
- When transporting the TV set by hand, hold it as shown below. Do not put stress on the LCD panel and the frame around the screen.

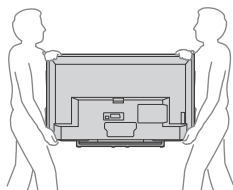

- When transporting the TV set, do not subject it to jolts or excessive vibration.
- When transporting the TV set for repairs or when moving, pack it using the original carton and packing material.

Ventilation

- Never cover the ventilation holes or insert anything in the cabinet.
- Leave space around the TV set as shown below.
- It is strongly recommended that you use a Sony Wall-Mount Bracket in order to provide adequate air-circulation.

Installed on the wall

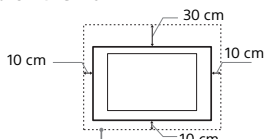

Leave at least this space around the set.

Installed with stand

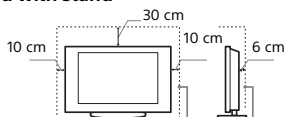

Leave at least this space around the set.

- To ensure proper ventilation and prevent the collection of dirt or dust:
 - Do not lay the TV set flat, install upside down, backwards, or sideways.
 - Do not place the TV set on a shelf, rug, bed or in a closet.
 - Do not cover the TV set with a cloth, such as curtains, or items such as newspapers, etc.
 - Do not install the TV set as shown below.

Air circulation is blocked.

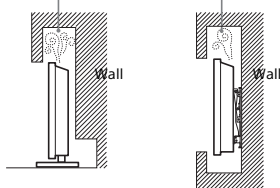

Mains lead

Handle the mains lead and socket as follows in order to avoid any risk of fire, electrical shock or damage and/or injuries:

- Use only mains leads supplied by Sony, not other suppliers.
- Insert the plug fully into the mains socket.
- Operate the TV set on a 220-240 V AC supply only.
- When wiring cables, be sure to unplug the mains lead for your safety and take care not to catch your feet on the cables.
- Disconnect the mains lead from the mains socket before working on or moving the TV set.
- Keep the mains lead away from heat sources.
- Unplug the mains plug and clean it regularly. If the plug is covered with dust and it picks up moisture, its insulation may deteriorate, which could result in a fire.

Note

- Do not use the supplied mains lead on any other equipment.
- Do not pinch, bend, or twist the mains lead excessively. The core conductors may be exposed or broken.
- Do not modify the mains lead.
- Do not put anything heavy on the mains lead.
- Do not pull on the mains lead itself when disconnecting the mains lead.
- Do not connect too many appliances to the same mains socket.
- Do not use a poor fitting mains socket.

NOTE ON MAINS ADAPTOR

Warning

To reduce the risk of fire or electric shock, do not expose this apparatus to rain or moisture.

To prevent fire or shock hazard, do not place objects filled with liquids, such as vases, on the apparatus. Do not install this equipment in a confined space, such as a bookshelf or similar unit.

- Please ensure that the mains socket is installed near the equipment and shall be easily accessible.
- Be sure to use the supplied mains adaptor and mains lead.
- Do not use any other mains adaptor. It may cause a malfunction.
- Connect the mains adaptor to an easily accessible mains socket.
- Do not coil the mains lead around the mains adaptor. The core wire may be cut and/or it may cause a malfunction of the media receiver.



- Do not touch the mains adaptor with wet hands.
- If you notice an abnormality in the mains adaptor, disconnect it from the mains socket immediately.
- The set is not disconnected from the mains source as long as it is connected to the mains socket, even if the set itself has been turned off.
- As the mains adaptor will become warm when it is used for a long time, you may feel hot when touching it by hand.

Prohibited Usage

Do not install/use the TV set in locations, environments or situations such as those listed below, or the TV set may malfunction and cause a fire, electrical shock, damage and/or injuries.

Location:

- Outdoors (in direct sunlight), at the seashore, on a ship or other vessel, inside a vehicle, in medical institutions, unstable locations, near water, rain, moisture or smoke.
- If the TV is placed in the changing room of a public bath or hot spring, the TV may be damaged by airborne sulphur, etc.



- For best picture quality, do not expose the screen to direct illumination or sunlight.
- Avoid moving the TV from a cold area to a warm area. Sudden room temperature changes may cause moisture condensation. This may cause the TV to show poor picture and/or poor colour. Should this occur, allow moisture to evaporate completely before powering the TV on.

Environment:

- Places that are hot, humid, or excessively dusty; where insects may enter; where it might be exposed to mechanical vibration, near flammable objects (candles, etc.). The TV set shall not be exposed to dripping or splashing and no objects filled with liquids, such as vases, shall be placed on the TV.
- Do not place the TV in a humid or dusty space, or in a room with oily smoke or steam (near cooking tables or humidifiers). Fire, electric shock, or warping may result.
- Do not install the TV in places subject to extreme temperature such as in direct sunlight, near a radiator or a heating vent. The TV may overheat in such condition which can cause deformation of the enclosure and/or TV malfunction.

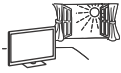

Situation:

- Do not use when your hands are wet, with the cabinet removed, or with attachments not recommended by the manufacturer. Disconnect the TV set from mains socket and aerial during lightning storms.
- Do not install the TV so that it sticks out into an open space. Injury or damage from a person or object bumping into the TV may result.



Broken pieces:

- Do not throw anything at the TV set. The screen glass may break by the impact and cause serious injury.
- If the surface of the TV set cracks, do not touch it until you have unplugged the mains lead. Otherwise electric shock may result.

When not in use

- If you will not be using the TV set for several days, the TV set should be disconnected from the mains for environmental and safety reasons.
- As the TV set is not disconnected from the mains when the TV set is just turned off, pull the plug from the mains to disconnect the TV set completely.
- However, some TV sets may have features that require the TV set to be left in standby to work correctly.

For children

- Do not allow children to climb on the TV set.
- Keep small accessories out of the reach of children, so that they are not mistakenly swallowed.

If the following problems occur...

Turn off the TV set and unplug the mains lead immediately if any of the following problems occur.

Ask your dealer or Sony service centre to have it checked by qualified service personnel.

When:

- Mains lead is damaged.
- Poor fitting of mains socket.
- TV set is damaged by being dropped, hit or having something thrown at it.
- Any liquid or solid object falls through openings in the cabinet.

About LCD Monitor Temperature

When the LCD Monitor is used for an extended period, the panel surrounds become warm. You may feel hot when touching there by the hand.

Precautions

Viewing the TV

- For best picture quality, do not expose the screen to direct illumination or sunlight.
- View the TV in moderate light, as viewing the TV in poor light or during long period of time, strains your eyes.
- When using headphones, adjust the volume so as to avoid excessive levels, as hearing damage may result.

LCD Screen

- Although the LCD screen is made with high-precision technology and 99.99% or more of the pixels are effective, black dots may appear or bright points of light (red, blue, or green) may appear constantly on the LCD screen. This is a structural property of the LCD screen and is not a malfunction.
- Do not push or scratch the front filter, or place objects on top of this TV set. The image may be uneven or the LCD screen may be damaged.
- If this TV set is used in a cold place, a smear may occur in the picture or the picture may become dark. This does not indicate a failure. These phenomena disappear as the temperature rises.
- Ghosting may occur when still pictures are displayed continuously. It may disappear after a few moments.
- The screen and cabinet get warm when this TV set is in use. This is not a malfunction.
- The LCD screen contains a small amount of liquid crystal. Follow your local ordinances and regulations for disposal.

Handling and cleaning the screen surface/cabinet of the TV set

Be sure to unplug the mains lead connected to the TV set from mains socket before cleaning.

To avoid material degradation or screen coating degradation, observe the following precautions.

- To remove dust from the screen surface/cabinet, wipe gently with a soft cloth. If dust is persistent, wipe with a soft cloth slightly moistened with a diluted mild detergent solution.
- Never spray water or detergent directly on the TV set. It may drip to the bottom of the screen or exterior parts and enter the TV set, and may cause damage to the TV set.
- Never use any type of abrasive pad, alkaline/acid cleaner, scouring powder, or volatile solvent, such as alcohol, benzene, thinner or insecticide. Using such materials or maintaining prolonged contact with rubber or vinyl materials may result in damage to the screen surface and cabinet material.
- Periodic vacuuming of the ventilation openings is recommended to ensure to proper ventilation.
- When adjusting the angle of the TV set, move it slowly so as to prevent the TV set from moving or slipping off from its table stand.



Optional Equipment

- Keep optional components or any equipment emitting electromagnetic radiation away from the TV set. Otherwise picture distortion and/or noisy sound may occur.
- This equipment has been tested and found to comply with the limits set out in the EMC Directive using a connection signal cable shorter than 3 meters.

Recommendation of F-type plug

Projection of the inner wire from the connection part must be less than 1.5 mm.

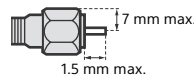

(Reference drawing of the F type plug)

Caution about handling the remote control

- Observe the correct polarity when inserting batteries.
- Do not use different types of batteries together or mix old and new batteries.
- Dispose of batteries in an environmentally friendly way. Certain regions may regulate the disposal of batteries. Please consult your local authority.
- Handle the remote control with care. Do not drop or step on it, or spill liquid of any kind onto it.
- Do not place the remote control in a location near a heat source, a place subject to direct sunlight, or a damp room.

Wireless Function of the unit

- Do not operate this unit near medical equipment (pacemaker, etc.), as malfunction of the medical equipment may result.
- Although this unit transmits/receives scrambled signals, be careful of unauthorised interception. We cannot be responsible for any trouble as a result.

Disposal of the TV set



Disposal of Old Electrical & Electronic Equipment (Applicable in the European Union and other European countries with separate collection systems)

This symbol on the product or on its packaging indicates that this product shall not be treated as household waste. Instead it shall be handed

over to the applicable collection point for the recycling of electrical and electronic equipment. By ensuring this product is disposed of correctly, you will help prevent potential negative consequences for the environment and human health, which could otherwise be caused by inappropriate waste handling of this product. The recycling of materials will help to conserve natural resources. For more detailed information about recycling of this product, please contact your local Civic Office, your household waste disposal service or the shop where you purchased the product.



Disposal of waste batteries (applicable in the European Union and other European countries with separate collection systems)

This symbol on the battery or on the packaging indicates that the battery provided with this

product shall not be treated as household waste. On certain batteries this symbol might be used in combination with a chemical symbol. The chemical symbols for mercury (Hg) or lead (Pb) are added if the battery contains more than 0.0005% mercury or 0.004% lead. By ensuring these batteries are disposed of correctly, you will help prevent potentially negative consequences for the environment and human health which could otherwise be caused by inappropriate waste handling of the battery. The recycling of the materials will help to conserve natural resources. In case of products that for safety, performance or data integrity reasons require a permanent connection with an incorporated battery, this battery should be replaced by qualified service staff only. To ensure that the battery will be treated properly, hand over the product at end-of-life to the applicable collection point for the recycling of electrical and electronic equipment. For all other batteries, please view the section on how to remove the battery from the product safely. Hand the battery over to the applicable collection point for the recycling of waste batteries. For more detailed information about recycling of this product or battery, please contact your local Civic Office, your household waste disposal service or the shop where you purchased the product.

Parts and Controls

TV

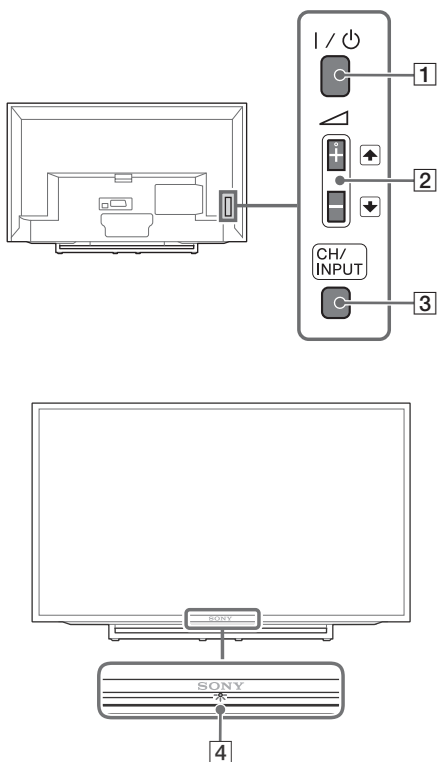

1 I/⏻ (Power)

Turns the TV on or to switch to standby mode.

Note

- To disconnect the TV from the AC power completely, pull the plug from the mains socket.

2 ⏪ + / - / ⏩ (Volume / Item select)

- Increases/decreases the volume, or selects the next (+) or previous (-) channel when the CH Up/Down notification is displayed by pressing the **CH/INPUT** button.
- Moves the selected input source up/down when the input select menu is displayed by pressing the **CH/INPUT** button.

3 CH/INPUT

Switches between the CH Up/Down screen and the input select screen.

4 (Sensors/LED indicator)

- Receives signals from the remote control. Do not put anything over the sensor. Doing so may affect its function.
- Lights up in amber when the sleep timer or [On Timer] is set (page 19), or the TV is in Photo Frame Mode (page 11).
- Lights up in green when [Power Saving] is set to [Picture Off] (page 21).
- Lights up in green when the TV is turned on.
- Does not light up when the TV is in standby mode.
- Flashes while the remote control is being operated.

Note

- Make sure that the TV is completely turned off before unplugging the AC power cord (mains lead).

Hint

- The ⏪ + button has a tactile dot. Use it as a reference when operating the TV.

Remote Control

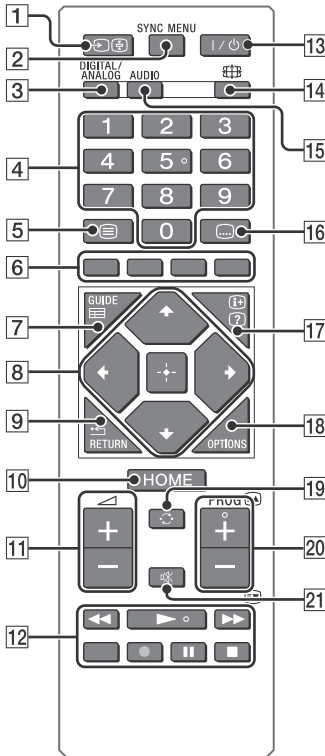

- 1** **(Input select / Text hold)**
- Displays and selects the input source (page 24).
 - In text mode, holds the current page.

- 2** **SYNC MENU**
- Press to display the BRAVIA Sync Menu and then select connected HDMI/MHL equipment from [Device Selection]. The following options can be selected from BRAVIA Sync Menu.

Device Control:

Use the [Device Control] to operate equipment that is compatible with BRAVIA Sync Control. Select options from [Home (Menu)], [Options], [Content List] and [Power Off] to operate the equipment.

Speakers:

Selects [TV Speakers] or [Audio System] to output the TV's sound from the TV speakers or connected audio equipment.

TV Control:

Use the [TV Control] menu to operate the TV from the [Home (Menu)] or [Options] menu.

Return to TV:

Selects this option to return to TV programme.

- 3** **DIGITAL/ANALOG**
- Switch to digital or analogue input.
- 4** **Number buttons**
- Select channels. For channel numbers 10 and above, enter the next digit quickly.
 - In text mode, enter the three digit page number to select the page.
- 5** **(Text)**
- In text mode, displays Text broadcast. Each time you press , the display changes cyclically as follows:
Text → Text over the TV picture (mix mode) → No Text (exit the Text service)
- 6** **Colour buttons**
- Display operation guide (when colour buttons are available).
- 7** **GUIDE (EPG)**
- Displays the Digital Electronic Programme Guide (EPG) (page 11).
- 8** **(Item select / Enter)**
- Select or adjust items.
 - Confirm selected items.
- 9** **RETURN**
- Returns to the previous screen of any displayed menu.
 - Stops playback when playing photo/music/video file.
- 10** **HOME**
- Displays or cancels the menu.
- 11** **+/- (Volume)**
- Adjusts volume.
- 12**
- Operate the connected BRAVIA Sync-compatible equipment.
 - This key also can be used to operate USB media playback.

13  **(TV standby)**

Turns the TV on or switches to standby mode.

14  **(Wide Mode)**

Adjusts the screen display. Press repeatedly to select the desired wide mode (page 10).

15 **AUDIO**

- In digital mode, selects the sound for multilingual source.
- In analogue mode, selects dual sound (page 15).

16  **(Subtitle)**

Activates or changes the subtitle language (page 17).

17  **(Info / Text reveal)**



- Displays information. Press once to display information about the programme/input you are viewing. Press again to remove the display from the screen.
- In text mode, reveals hidden information (e.g. answers to a quiz).



18 **OPTIONS**

Press to displays a list that contains shortcuts to some setting menus. The listed options vary depending on the current input and content.

19  **(Jump)**

Returns to the previous channel or input viewed more than 15 seconds.

20 **PROG +/- /  / **

- Selects the next (+) or previous (-) channel.
- In text mode, selects the next () or previous () page.

21  **(Mute)**

Mutes the sound. Press again to restore the sound.

Hint

- The number **5**, , **PROG +** and **AUDIO** buttons have tactile dots. Use the tactile dots as references when operating the TV.

Note













- If subtitles are selected and the user launches a digital text application via 'text' key, subtitles may, under certain circumstance stop being displayed. When the user exits the digital text application, subtitle decoding will resume automatically.

Watching TV

- 1 Press **I/⏻** on the TV or remote control to turn on the TV.
- 2 Press **DIGITAL/ANALOG** to switch between digital and analogue modes.
- 3 Press the number buttons or **PROG +/-** to select a TV channel.
- 4 Press **⏮ +/-** to adjust the volume.

In digital mode

An information banner appears briefly. The following icons may be indicated on the banner.

-  Data service (Broadcast application)
-  Radio service
-  Scrambled/Subscription service
-  Multiple audio languages available
-  Subtitles available
-  Subtitles and/or audio available for the hearing impaired
-  Recommended minimum age for current programme (from 3 to 18 years)
-  Parental Lock
-  Digital Programme Lock
-  Audio available for the visually impaired
-  Spoken subtitle audio available
-  Multi-channel audio available

Changing the Viewing Style

Changing the Wide Mode

- 1 Press **⏮** repeatedly to select the wide mode.

[Wide Zoom]*

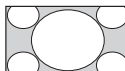

[Normal]

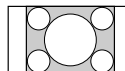

[Full]

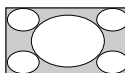

[Zoom]*

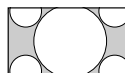

[14:9]*

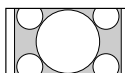

[Captions]*

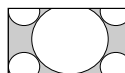

* Parts of the top and bottom of the picture may be cut off.

Note

- You cannot select [14:9] or [Captions] for HD source pictures.

For HDMI PC Input (PC timing)

Normal

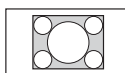

Full 1

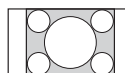

Full 2

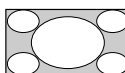

Setting Scene Select

- 1 Press **OPTIONS**.
- 2 Press **⏮/⏭** then **+** to select [Scene Select].

When you select the desired scene option, the optimum sound and picture quality for selected scene are automatically set. The options you can select may vary. Unavailable options are greyed out.

Navigating through Home Menu

The **HOME** button allows you to access a variety of TV settings and features.

1 Press **HOME**.

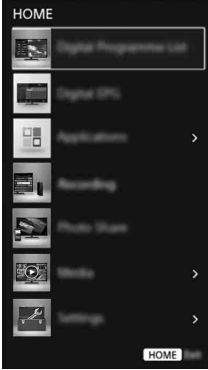

2 Press \uparrow/\downarrow to select an option, then press $\left[\right]$.

Digital Programme List

- 1 Press **HOME** in digital mode.
- 2 Press \uparrow/\downarrow then $\left[\right]$ to select [Digital Programme List].



3 Press $\uparrow/\downarrow/\leftarrow/\rightarrow$ then $\left[\right]$ to select a programme.

To use the Favourite list

The Favourite feature allows you to specify up to four lists of your favourite programmes. While watching TV, press $\left[\right]$ to create or display a Favourite list.

Hint

- Press the blue button to edit the Favourite list. Follow the guides at the bottom of the screen.

Digital Electronic Programme Guide (EPG)

1 Press $\left[\right]$ **GUIDE** in digital mode.



2 Press $\uparrow/\downarrow/\leftarrow/\rightarrow$ then $\left[\right]$ to select a programme.

Applications

Using the TV as a Photo Frame

Photo Frame displays the clock and calendar at the same time as displaying a photo, and listening to music or FM radio.

- 1 Press **HOME**.
- 2 Press \uparrow/\downarrow then $\left[\right]$ to select [Applications].
- 3 Press \uparrow/\downarrow then $\left[\right]$ to select [Photo Frame Mode].



To select photo or music from USB memory

- 1 Press **OPTIONS** while playing back a photo or music file.
- 2 Press \uparrow/\downarrow then \square to select [Photo Frame Mode] to launch Photo Frame.

To select Display mode

You can change the photo frame display by selecting [Display Mode] in the [Photo Frame Settings] (page 19).

To select Clock Display mode

You can select among three clock display modes by selecting [Clock Display] in the [Photo Frame Settings] (page 19).

Note

- This TV does not have a battery powered backup for the clock. Therefore, if there is a power failure or if you disconnect the power cord, be sure to reset the current date and time.

Duration

To save power, the TV continually plays back in Photo-Frame Mode for up to 24 hours before powering off automatically. After automatic power off, do not use Photo-Frame Mode for at least one hour to avoid panel burn-in. You can change the setting of the [Duration] in the [Photo Frame Settings] (page 19).

To avoid panel burn-in, the position of the photo, clock and calendar are switched automatically every hour.

Listening to FM Radio (for Russia or Ukraine only)

- 1 Press **HOME**.
- 2 Press \uparrow/\downarrow then \square to select [Applications].
- 3 Press \uparrow/\downarrow then \square to select [FM Radio].
- 4 Press **PROG +/-** to select an FM radio station.

To exit FM Radio mode

- 1 Press \leftarrow **RETURN**.

Presetting Radio Stations

When you use FM Radio function for the first time, press **HOME** and select [Settings] \rightarrow [System Settings] \rightarrow [Channel Set-Up] \rightarrow [FM Radio Set-Up] \rightarrow [Auto Tuning].

To change preset radio stations

- 1 Press **OPTIONS** in FM Radio mode.
- 2 Press \uparrow/\downarrow then \square to select [FM Radio Presets].
- 3 Press \uparrow/\downarrow then \square to select the radio station you want to change.
- 4 Press \uparrow/\downarrow then \square to change the FM frequency then to edit FM Radio station name.

Note

- If the station has a noisy sound, you may be able to improve the sound quality by pressing \leftarrow/\rightarrow .
- When an FM stereo programme has static noise, press **AUDIO** until [Mono] appears. There will be no stereo effect, but the noise will be reduced.

Recordings

- 1 Press **HOME** in digital mode.
- 2 Press \uparrow/\downarrow then \square to select [Recordings].
- 3 Press **REC** button to record currently viewed programmed with USB HDD recording function.

Photo Share (except KDL-40R45xB, KDL-32R41xB)

Connect, copy and view favourite photos on TV using your devices (eg. smart phones or tablets).

- 1 Press **HOME**.
- 2 Press \uparrow/\downarrow then \square to select [Photo Share].
- 3 Follow the instructions on the screen to connect your device to the TV.
- 4 Open web browser on device after all connections are established, then follow the instructions on the screen to access URL.

To display photo on TV

- 1 Tap on your device to start.
- 2 Select a photo, then tap the  icon on your device.

To save a photo displayed on TV

- 1 Tap thumbnail on your device, then hold the photo to open the context menu.
- 2 Select [Save].

Note

- Thumbnail history in your device will keep up to 5 photos.
Connect USB flash drive to keep up to 50 photos.
- Up to 10 smart phones or tablets can be connected to the TV at the same time.
- Maximum file size of each photo is 10 MB.

Media

Playing back Photo/Music/Video via USB

You can enjoy photo/music/video files stored in a Sony digital still camera or camcorder through a USB cable or USB storage device on your TV.

- 1 Connect a supported USB device to the TV.
- 2 Press **HOME**.
- 3 Press \uparrow/\downarrow then \square to select [Media].
- 4 Press \uparrow/\downarrow then \square to select [Photo], [Music] or [Video].
If more than one USB device is connected, press the red button to select [Playback Options] then [Device Selection] to select the appropriate USB device.
- 5 Press $\uparrow/\downarrow/\leftarrow/\rightarrow$ then \square to select a file or folder.

Playback options

Press the red button to display the list of USB playback settings.

To adjust the picture quality of USB video

- 1 Press **OPTIONS** during video playback.
- 2 Press \uparrow/\downarrow then \square to select [Picture].
- 3 Press $\uparrow/\downarrow/\leftarrow/\rightarrow$ then \square to select and adjust an item.

To play a photo as a slideshow (Photo)

- 1 Press the green button in thumbnail view to start slideshow.
To set [Slideshow Effect] and [Slideshow Speed], press **OPTIONS** \rightarrow [Playback Options].
To stop a slideshow, press  **RETURN**.

Note

- While the TV is accessing the data on a USB device, observe the following:
 - Do not turn off the TV.
 - Do not disconnect the USB cable.
 - Do not remove the USB device.The data on the USB device may be damaged.

- Sony will not be held liable for any damage to, or loss of, data on the recording media due to a malfunction of any connected devices or the TV.
- The file system on the USB device supports FAT16, FAT32 and NTFS.
- The file name and folder name may not display correctly in some cases.
- When you connect a Sony digital still camera, set the camera's USB connection mode to Auto or Mass Storage. For more information about USB connection mode, refer to the instructions supplied with your digital camera.
- Use a USB storage device that is compliant with USB mass storage device class standards.
- If a selected file has incorrect container information, or is incomplete, it cannot be played back.

USB Video format

- AVI (.avi)
Video Codec: MPEG1, MPEG2, Xvid, MPEG4, H.264, Motion JPEG
Audio Codec: PCM, MPEG1 Layer1/2, MPEG2 AAC (2ch), MPEG4 AAC (2ch), Dolby Digital (2ch), WMA v8, MP3.
- ASF (.wmv, .asf)
Video Codec: WMV v9, Xvid, VC-1
Audio Codec: MP3, WMA v8
- MP4 (.mp4, .mov, .3gp)
Video Codec: MPEG-4, H.264, H.263, Motion JPEG
Audio Codec: MPEG1 Layer1/2, MP3, MPEG2 AAC, MPEG4 AAC, MPEG4 HE-AAC
- MKV (.mkv)
Video Codec: WMV9, MPEG4, H.264, VC-1, VP8
Audio Codec: PCM, MPEG1 Layer1/2, MP3, MPEG2 AAC (2ch), MPEG4 AAC (2ch), Dolby Digital (2ch), WMA v8, Dolby Digital Plus (2ch), DTS, DTS 2.0, VORBIS
- WebM (.webm)
Video Codec: VP8
Audio Codec: VORBIS
- PS (.mpg, .mpeg, .vro, .vob)
Video Codec: MPEG1, MPEG2
Audio Codec: MPEG1 Layer1/2, MP3, Dolby Digital (2ch), Dolby Digital Plus (2ch), DTS, DTS 2.0

- TS (.ts, .m2ts)
Video Codec: MPEG2, H.264, VC-1
Audio Codec: MPEG1 Layer1/2, MP3, MPEG2 AAC, MPEG4 AAC, MPEG4 HE-AAC, Dolby Digital, Dolby Digital Plus (2ch), DTS, DTS 2.0

USB Music format

- LPCM (.wav)
- MPEG1, audio layer3 (.mp3)
- WMA V8 (.wma)

USB Photo format

- JPEG (.jpg, .jpeg)

Note

- Playback of the above file formats is not guaranteed.

Settings

System Settings

Note

- The options you can adjust vary depending on the situation. Unavailable options are greyed out or not displayed.
- Satellite features are only available for satellite models.

Picture

Picture Mode

Sets a picture mode. The options that can be selected differ depending on the [Scene Select] settings.

Reset

Reset all the [Picture] settings except [Picture Mode] to the default settings.

Backlight

Adjusts the brightness of the backlight.

Contrast

Increases or decreases picture contrast.

Brightness

Brightens or darkens the picture.

Colour

Increases or decreases colour intensity.

Hue

Increases or decreases the green tones and red tones.

Sharpness

Sharpens or softens the picture.

Colour Temperature

Adjusts the whiteness of the picture.

Noise Reduction

Reduces the picture noise (snowy picture) in a weak broadcast signal.

MPEG Noise Reduction

Reduces the picture noise in MPEG-compressed video.

Film Mode

Provides improved picture movement when playing BD (Blu-ray Disc), DVD or VCR images taken on film, reducing picture blur and graininess. Select [Auto] to represent original film-based content as it is.

Note

- If the image contains irregular signals or too much noise, [Film Mode] is automatically turned off even if [Auto] is selected.

Advanced Settings

Sets [Picture] settings in more detail.

Reset: Resets all the advanced settings to the default settings.

Adv. Contrast Enhancer: Automatically adjusts [Backlight] and [Picture] to the most suitable settings judging from the brightness of the screen. This setting is especially effective for dark images scenes, and will increase the contrast distinction of the darker picture scenes.

Black Corrector: Enhances black areas of the picture for stronger contrast.

Gamma: Adjusts the balance between bright and dark areas of the picture.

Clear White: Emphasises white colours.

Live Colour: Makes colours more vivid.

LED Motion Mode: Reduces blur in movies by controlling the LED backlight source, but the brightness decreases.

Sound

Sound Mode

Select according to content you want to enjoy.

Reset

Resets all the [Sound] settings except [Sound Mode], [Dual Sound] and [Advanced Settings] to the default settings.

Equaliser

Adjusts sound frequency settings.

Sound Booster

Produces a fuller sound for more impact, by emphasising the bass sounds.

Clear Voice

Makes voices sound clearer.

Auto Volume

Minimizes the difference in volume level between all programmes and adverts (e.g. adverts tend to be louder than programmes).

Balance

Emphasises left or right speaker balance.

Volume Offset

Adjusts the volume level of the current input relative to other inputs.

Dual Sound

Sets the sound from the speaker to [Mono], [Stereo], [A] or [B].

Note

- If the signal is very weak, the sound becomes monaural automatically.
- If the stereo sound is noisy when receiving a NICAM programme, select [Mono]. The sound becomes monaural, but the noise is reduced.
- The [Dual Sound] setting is memorized for each programme position.
- You cannot listen to stereo broadcast sound when [Mono] is selected.

Hint

- If you select other equipment connected to the TV, set [Dual Sound] to [Stereo], [A] or [B].
-

Advanced Settings

Dynamic Range: Compensates for differences in the audio level between different channels (only for Dolby Digital audio).

Note

- The effect may not function or may vary depending on the programme regardless of the [Dynamic Range] setting.

Downmix Mode: Set the downmix method that are suitable for multi-channel and 2-channel sound.

Screen

Screen Format

For details about wide mode, see page 10.

Auto Format

Automatically changes [Screen Format] to match the input signal.

To keep your setting, set [Off].

Hint

- Even if [Auto Format] is set to [On] or [Off], you can always modify the format of the screen by pressing  repeatedly.
-

4:3 Default

Sets the default [Screen Format] for a 4:3 input signal.

Auto Display Area

Automatically adjusts the picture to the most appropriate display area.

Display Area

Adjusts the picture display area.

Horizontal Shift

Adjust the horizontal position of the picture.

Vertical Shift

Adjust the vertical position of the picture.

Vertical Size

Adjusts the vertical size of the picture when [Screen Format] is set to [Wide Zoom].

PC Adjustment

Selects screen mode or adjust the display position of the picture when receiving PC input signal.

Analogue Set-up

Analogue Auto Tuning: Tunes in all the available analogue channels. Usually you do not need to do this operation because the channels are already tuned when the TV was first installed. However, this option allows you to repeat the process (e.g., to retune the TV after moving house, or to search for new channels that have been launched by broadcasters).

Manual Programme Preset: Before selecting [TV System]/[Channel]/[Label]/[AFT]/[Audio Filter]/[Skip], press PROG +/- to select the programme number with the channel. You cannot select a programme number that is set to [Skip].

Programme:

Presets programme channels manually.

Programme Sorting: Changes the order in which the channels are stored on the TV.

Digital Set-up

Digital Tuning:

Digital Auto Tuning

Tunes in the available digital channels. This option allows you to retune the TV after moving house, or to search for new channels that have been launched by broadcasters.

Auto Tuning Range

[Normal]: Searches for available channels within your region/country.
[Full]: Searches for available channels regardless of region/country.

Note

- You can run [Digital Auto Tuning] after moving to a new residence, changing service providers, or to search for newly launched channels.

Programme List Edit

Removes any unwanted digital channels stored on the TV, and changes the order of the digital channels stored on the TV.

Digital Manual Tuning

Tunes the digital channels manually.

Subtitle Set-up:

Subtitle Setting

When [For Hard Of Hearing] is selected, some visual aids may also be displayed with the subtitles (if TV channels broadcast such information).

Primary Preferred Language

Select preferred language which subtitles are displayed in.

Secondary Preferred Language

Select secondary preferred language which subtitles are displayed in.

Audio Set-up:

Audio Type

Switches to broadcast for the hearing impaired when [For Hard Of Hearing] is selected.

Primary Preferred Language

Select the preferred language used for a programme. Some digital channels may broadcast several audio languages for a programme.

Secondary Preferred Language

Select the secondary preferred language used for a programme. Some digital channels may broadcast several audio languages for a programme.

Audio Description

Provides audio description (narration) of visual information if TV channels broadcast such information.

Mixing Level

Adjusts the TV main audio and Audio Description output levels.

Hint

- This option is only available when [Audio Description] is set to [On].

MPEG Audio Level

Adjusts the MPEG audio sound level.

Technical Set-up:

Auto Service Update

Enables the TV to detect and store new digital services as they become available.

Service Replacement

Select [On] to automatically change the channel when broadcaster changes transmission of the viewing programme to a different channel.

Satellite Set-up:

Allows you to automatically tune satellite channels.

CA Module Set-up:

Allows you to access a pay TV service once you obtain a Conditional Access Module (CAM) and a view card.

CA Module Pin:

Allows you to enter the 8 digits Conditional Access Module (CAM) PIN to be stored in TV.

Delete Service List:

Deletes a service list. Select [Yes] to delete.

FM Radio Set-up (for Russia or Ukraine only)

Presets up to 30 FM radio stations that can be received in your area.

Auto Tuning: Allows you to automatically tune and store all the available channels.

FM Radio Presets: Allows you to manually tune and store each available channel one at a time.

Note

- To enable this feature, access to FM Radio mode by using Home (Menu) (page 12), then preset your desired FM radio stations according to the steps mentioned above.

Parental Lock

PIN Code

Sets up TV to block channel or external input. Use 0-9 on the remote control to enter a four-digit PIN code.

Change PIN Code

Select to change your PIN code.

Parental Rating

Sets an age restriction to viewing. To view any programme rated for ages above the age you specify, enter the correct PIN code.

Setup Protection

Sets your PIN code for programme related operations.

Digital Programme Lock

Locks a digital channel from being watched. To view a blocked channel, select [Unlocked].

Satellite Programme Lock

Locks satellite programme from being watched. To view locked programme, select [Unlocked].

External Input Lock

Locks an external input from being watched. To view a blocked external input, select [Unlocked].

Note

- Entering the correct PIN code for blocked channel or external input will temporarily deactivate the [Parental Lock] feature. To reactivate the [Parental Lock] settings, turn off and on the TV.

Hint

- If you lost your PIN code, see page 27.

Guidance Block for Recorded Titles

You can block recorded content by displaying a guidance that requires password input to access.

Set-up

Wi-Fi Setup (except KDL-40R45xB, KDL-32R41xB)

Built-in Wi-Fi: Turns on/off the Wireless LAN.

Wi-Fi Direct: Turns on/off to display photos, music and movies or control volume level using Wi-Fi direct device such as PC, mobile phone or digital camera.

Wi-Fi Direct Settings: Set to connect a Wi-Fi direct device to the TV using the Wi-Fi Direct function. If you cannot connect, press **OPTIONS** key and select [Manual].

Device Name: Change the name of the TV shown on the connected device.

Home Network Setup: Allows devices to connect using the renderer function.

Photo Frame Settings

Display Mode: Allows you to select the display mode. See page 11.

Clock Display: Allows you to select the clock display.

Audio Application: Sets [FM Radio], [Music] or [Off] as audio application.

Image Selection: Select image.

Music Selection: Select music.

Slideshow Setting: Select from showing slideshow mode or single view photo.

Music Playback Setting: Select from listening to all tracks or a single music track.

Duration: Select the time period ([1 h], [2 h], [4 h] or [24 h]) after which the TV automatically switches to standby mode.

First day of the week: Set [Sunday] or [Monday] as the first day of the week on the calendar.

USB Auto Start

When USB device is connected to the USB port, select [On] to automatically view the thumbnail of the last played Photo/Music/Video.

Clock/Timers

Sets the timer and clock.

Sleep Timer: Set the time in minutes that you would like the TV to remain on before shutting off automatically.

On Timer: Turns on the TV from standby mode at a time you set, and tuned to a channel or input of your preference. Before setting this function, make sure you set the correct current time.

Clock Set: Set the current time and date. This feature also can be set from initial set-up.

Time Zone Setting: Sets whether or not to automatically select the time zone you are in.

Time Zone: Allows you to manually select the time zone you are in, if it is not the same as the default time zone setting for your country/region.

Auto DST: Sets whether or not to automatically switch between summer time and winter time.

On: Automatically switches between summer time and winter time according to the calendar.

Off: The time is displayed according to the time difference set by [Time Zone].

Recording Set-Up

Enables timer recordings to a connected USB HDD device, and selection of recorded content to play.

Auto Start-up

Starts the initial set-up procedure. This option allows you to retune the TV after moving houses, or to search for new channels that have been launched by broadcasters.

Language

Select the language in which the menus are displayed.

Start-up Logo

Select [On] to display the logo when the TV is turned on. Select [Off] to disable it.

LED Indicator

Select [On] to light up the LED indicator. Select [Off] to disable it.

AV Set-up

AV Preset: Assigns name to external equipment input.

Enable: Select [Auto] to display names only when the equipment is connected, or [Always] to display regardless of connection status.

AV2/Component Input: Select [Auto] to have the TV detect and switch between the component video jack or the video jack when component video jack or video jack is connected.

Note

- You cannot use the component video jack and the video jack at the same time.

Speakers: Select sound output from the TV speakers or external audio equipment.

Headphone/Audio Out: Sets the sound output to headphones, external audio systems or Active Subwoofer connected to the TV. Disconnect headphones from the TV when you select [Audio Out] or [Subwoofer].

Headphone Speaker Link: Switches the TV's internal speakers on/off when you connect headphones to the TV.

Headphone Volume: Adjusts the volume of the headphones.

Note

- This option is not available, when [Headphone/Audio Out] is set to [Audio Out].

Audio Out:

Variable: When using an external audio system, volume output from audio out can be controlled using the TV's remote control.

Fixed: The audio output of the TV is fixed. Use your audio receiver's volume control to adjust the volume (and other audio settings) through your audio system.

Digital Audio Out: Sets the audio signal that is output by connecting using digital audio output (optical) cable or HDMI (ARC) cable. Set to [Auto], when connecting equipment compatible with Dolby Digital or DTS. Set to [PCM], when connecting equipment not compatible with Dolby Digital or DTS.

TV Position: Improves the speaker settings when set as [Table-Top Stand] or [Wall Mount] according to your TV's position.

BRAVIA Sync Settings

Allows the TV to communicate with equipment that is compatible with the BRAVIA Sync Control function, and connected to the HDMI/MHL jacks of the TV. Note that communication settings must also be made on the connected equipment.

BRAVIA Sync Control: Sets whether or not to link the operations of the TV and the connected equipment that is compatible with BRAVIA Sync Control. When set to [On], the following functions are available. If the specific Sony equipment that is compatible with BRAVIA Sync Control is connected, this setting is applied to the connected equipment automatically.

Auto Devices Off: When this is set to [On], the connected equipment that is compatible with BRAVIA Sync Control turns off when your TV goes to standby mode.

Auto TV On: When this is set to [On], the TV turns on when you turn on the connected equipment that is compatible with BRAVIA Sync Control (except in MHL mode).

Auto Input Change (MHL): When this is set to [On], an MHL device is switched to MHL input automatically. If the TV is in standby mode, it will not switch automatically. Select [Off] to disable it. The availability of [Auto Input Change(MHL)] depends on whether the MHL-compatible device can support this feature.

BRAVIA Sync Device List: Displays a list of connected equipment that is compatible with BRAVIA Sync Control. Selects [Enable] to update the [BRAVIA Sync Device List].

Device Control Keys: Select button functions of the TV's remote control to operate the connected equipment.

None

Deactivates the control by the TV's remote control.

Normal

For basic operations, such as navigation buttons (up, down, left or right, etc).

Tuning Keys

For basic operations and operation of channel-related buttons, such as

PROG +/- or (0-9), etc.

Useful when you control a tuner or set-top box, etc; via the remote control.

Menu Keys

For basic operations and operation of the HOME/OPTIONS button.

Useful when you select menus of a BD player, etc; via the remote control.

Tuning and Menu Keys

For basic operations and operation of channel-related buttons and HOME/OPTIONS button.

Note

- You cannot use [BRAVIA Sync Control] if the TV operations are linked to the operations of an audio system that is compatible with BRAVIA Sync Control.
- Some equipment with [BRAVIA Sync Control] does not support the [Device Control] feature.

Network Set-Up (UK only)

Allows you to set up the IP settings of the TV's Ethernet port and establish a network connection.

Note

- For LAN connections, use a Category 5 cable (not supplied).
- This TV supports additional content/services provided by the MHEG Internet Connected Services feature. General Internet (IPTV/Web service/e-mail, etc.) is not supported by this TV.

Customer Support

Provide information of your TV's model, software, and others. For details, see page 21.



Eco

Reset

Resets the current Eco settings to the default values.

Power Saving

Reduces power consumption of the TV by adjusting the backlight.

When you select [Picture Off], the picture is switched off. The sound remains unchanged.

Idle TV Standby

Turns the TV off after it has been kept idle for the preset length of time.

Customer Support

Model Name

Displays model name of your TV.

Software Version

Displays current software version of your TV.

Digital

Select [System Information] to display digital channel information of your TV.

External Inputs

Selects to view or manage the TV input.

Picture Check

View Test Picture: Allows you to check the picture condition on the display.

USB System Update

Select to perform system update.

Automatic Software Download

Select [On] to download the software automatically by broadcast signal. Select [Off] to disable it.

Factory Settings

Resets all settings to factory settings. After completing this process, the initial set-up screen is displayed.

Note

- Be sure not to turn the TV off during this period (it takes about 30 seconds) or press any buttons.
-

Product Support

Displays your TV's product information.

Viewing Pictures from Connected Equipment

Connection Diagram

You can connect a wide range of optional equipment to your TV.

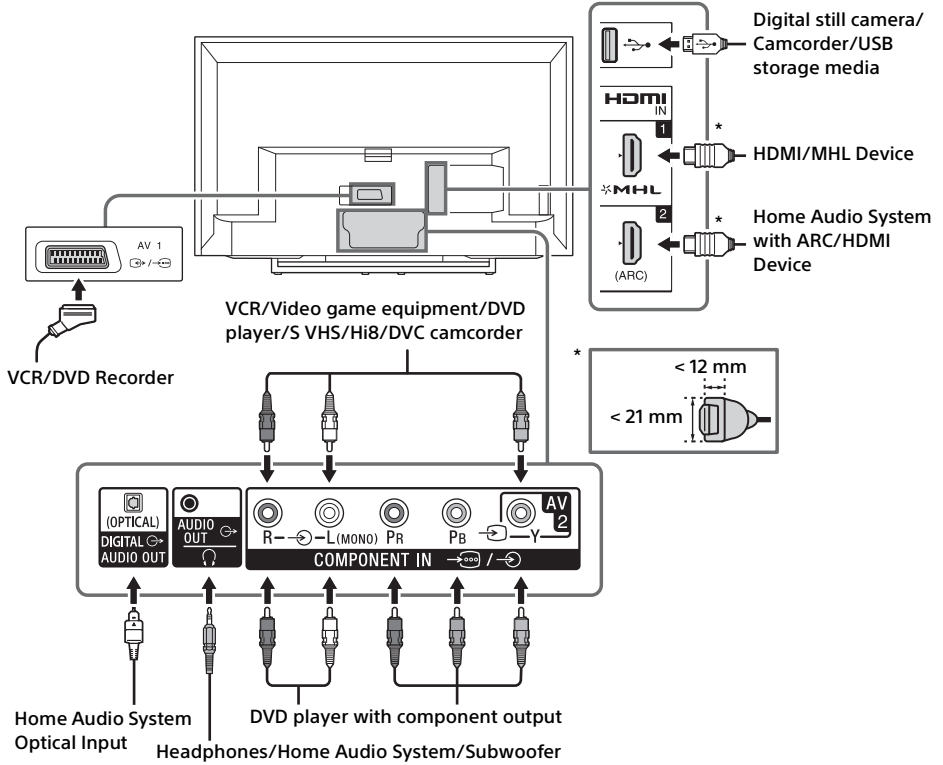

GB

Viewing Pictures from Connected Equipment

Picture Quality

- AV composite cable
- Antenna (aerial) cable
- Component cable
- HDMI cable





Standard definition (SD) videos have picture signals with a vertical resolution of 480 (NTSC) or 576 (PAL/SECAM) lines.



High definition (HD) videos have picture signals with a vertical resolution of 720 or 1080 lines.

Using Audio and Video Equipment

- 1 Turn on the connected equipment.
- 2 Press  to display the input source.
- 3 Press  then  to select the desired input source.
The highlighted item is selected if 2 seconds pass without any operation.

Note

- When connecting a digital audio system not compatible with Audio Return Channel (ARC) technology using an HDMI cable, you need to connect an optical audio cable to the DIGITAL AUDIO OUT (OPTICAL) to output digital sound.
- When connecting with an HDMI cable, be sure to use HighSpeed HDMI Cable with Cable Type Logo (Recommended SONY Cable).
- When connecting mono equipment, connect the audio cable to the L (mono) jack.

To use MHL device

Use an authorised MHL 2 CABLE with MHL logo (not supplied).

The TV simultaneously charges the MHL-compatible connected device while playing photo/music/video files.





To use BRAVIA Sync devices

When connecting the TV to BRAVIA Sync compatible equipment, you can control them together.

Be sure to perform the necessary settings in advance. The BRAVIA Sync Control settings must be set on both the TV and the connected equipment. See [BRAVIA Sync Settings] (page 20) for the settings on the TV side. Refer to the connected equipment operating instructions for the settings on the connected equipment side.

To use DTV Scart Out

Setting Digital TV SCART Out

- 1 Select Digital RF input.
- 2 Press OPTION.
- 3 Press  then  to select [SCART Out].
- 4 Press  then  to select [On].

Note

When input : Digital TV + [SCART Out] : [On],





- i Some of remote commander keys will be disable: (eg : HOME, PICTURE, WIDE etc.)
- ii Below message will be display:

Feature is unavailable when SCART Out is On.
To disable SCART Out, press OPTIONS and choose "SCART Out: Off".

- iii PQ (picture quality) setting will keep raw signal condition when [SCART Out] : [On] is selected.

Using Screen mirroring (except KDL-40R45xB, KDL-32R41xB)

Screen mirroring displays the screen of a compatible device (e.g. smartphones) on your large TV screen by Miracast technology. No wireless router (or access point) is required to use this feature.

- 1 Press the  /  button, then select [Screen mirroring] using  /  buttons.
- 2 Operate the Screen mirroring compatible device to connect with the TV. Once connected, the screen will be displayed on the device and also TV. For details, refer to the instruction manual of the device.

To list connected devices/deregister device

When the standby screen for the Screen mirroring is displayed, press **OPTION**, then select [Show Device List / Delete].

To deregister a device, select the device in the list to delete, press . Then, select [Yes] in the confirmation display.

To display dialogue when attempting to connect a device with the TV

Activating this function can avoid an unintended device from being connected. When the standby screen for then Screen mirroring is displayed, press **OPTION**, then select [Registration Notification] → [On]. Note that once you decline registration request from a device, you will not be able to connect the device unless you delete it from the device list.

To change the band setting (for experts)

When the standby screen for Screen mirroring is displayed, press **OPTION**, then select [Band Setting].

Note

- Connecting devices must conform to the following:
 - Screen mirroring compatible devices:
 - 2.4 GHz connection (5 GHz not supported).
- For information about the supported wireless band of your device, refer to the instruction manual of your device.

Additional Information

Troubleshooting

When the LED indicator is flashing red, count how many times it flashes (interval time is three seconds).

If the LED indicator flashes red, reset the TV by disconnecting the AC power cord (mains lead) from the TV for two minutes, then turn on the TV. If the problem persists, contact your dealer or Sony service centre with the number of times the LED indicator flashes red (interval time is three seconds). Press I/⏻ on the TV to turn it off, disconnect the AC power cord (mains lead), and inform your dealer or Sony service centre.

When the LED indicator is not flashing, check the items as follows.

If the problem persists, have your TV serviced by qualified service personnel.

Picture

No picture (screen is dark) and no sound

- Check the antenna/cable connection.
- Connect the TV to the AC power outlet (mains socket), and press I/⏻ on the TV or remote control.

No picture or no menu information from equipment connected to the video input jack appears on the screen

- Press  to display the connected equipment list, then select the desired input.
- Check the connection between the optional equipment and the TV.

Double images or ghosting

- Check the antenna/cable connection, location or direction.

Only snow and noise appear on the screen

- Check if the antenna is broken or bent.
- Check if the antenna has reached the end of its serviceable life (three to five years in normal use, one to two years at the seaside).

Distorted picture (dotted lines or stripes)

- Keep the TV away from electrical noise sources such as cars, motorcycles, hair-dryers or optional equipment.
- When installing optional equipment, leave some space between the optional equipment and the TV.
- Check the antenna/cable connection.
- Keep the antenna cable away from other connecting cables.

Picture or sound noise when viewing a TV channel

- Adjust [AFT] (Automatic Fine Tuning) to obtain better picture reception.

Tiny black points and/or bright points appear on the screen



- The picture of a display unit is composed of pixels. Tiny black points and/or bright points (pixels) on the screen do not indicate a malfunction.



Picture contours are distorted

- Change the current setting of [Film Mode] to other settings (page 15).

No colour on programmes

- Select [Reset] (page 14).

No colour or irregular colour when viewing a signal from the Y, Pb, Pr jacks of /

- Check the connection of the Y, Pb, Pr jacks of / and check if each jack is firmly seated in their respective jacks.

No picture from the connected equipment appears on the screen

- Turn the connected equipment on.
- Check the cable connection.
- Press  to display the connected equipment list, then select the desired input.
- Correctly insert the memory card or other storage device in the digital still camera.
- Use a digital still camera memory card or other storage device that has been formatted according to the instruction manual supplied with the digital still camera.
- Operations are not guaranteed for all USB devices. Also, operations differ depending on the features of the USB device and the video being played.

Cannot select the connected equipment on the menu or cannot switch the input

- Check the cable connection.

Sound

No sound, but good picture

- Press \triangleleft +/- or Mute (Mute).
- Check if [Speakers] in [AV Set-up] is set to [TV Speakers] (page 20).
- Check if the headphone plug is connected to the TV.

No sound or noisy sound

- Check if the TV system setting is appropriate (page 15).

Channels

The desired channel cannot be selected

- Switch between digital and analogue mode and select the desired digital/analogue channel.

Some channels are blank

- The channel is for scrambled/subscription service only. Subscribe to a pay TV service.
- Channel is used only for data (no picture or sound).
- Contact the broadcaster for transmission details.

Digital channels are not displayed

- Contact a local installer to find out if digital transmissions are provided in your area.
- Upgrade to a higher gain aerial.

General

The TV turns off automatically (the TV enters standby mode)

- Check if the [Sleep Timer] is activated (page 19).
- Check if the [Duration] is activated by [On Timer] (page 19) or [Photo Frame Settings] (page 19).
- Check if the [Idle TV Standby] is activated (page 21).

Some input sources cannot be selected

- Select [AV Preset] and select [Always] of the input source (page 20).

The remote control does not function

- Replace the batteries.

HDMI/MHL equipment does not appear on [BRAVIA Sync Device List]

- Check that your equipment is compatible with BRAVIA Sync Control.

Cannot select [Off] in [BRAVIA Sync Control]

- If you have connected any audio system that is compatible with BRAVIA Sync Control, you cannot select [Off] in this menu. To change the audio output to the TV speaker, select [TV Speakers] in the [Speakers] menu (page 20).

The [Parental Lock] password has been forgotten

- Press **HOME** and select [Settings] → [System Settings] → [Parental Lock] → [PIN Code] then enter 9999 for the PIN code (PIN code 9999 is always accepted).

Store Display Mode or Promoting Feature Logo appears on the screen

- On the remote control, press **RETURN** then press **HOME** and select [Settings] → [System Settings] → [Set-up] → [Auto Start-up]. Be sure to select [Home] in [Location].

Specifications

System

Panel system

LCD (Liquid Crystal Display) Panel, LED Backlight

TV system

Analogue: Depending on your country/area

selection: B/G/H, D/K, L, I

Digital: DVB-T/DVB-C

DVB-T2*1

Satellite*1: DVB-S/DVB-S2

Colour/video system

Analogue: PAL, SECAM, NTSC3.58, NTSC4.43

Digital: MPEG-2 MP@ML/HL, H.264/MPEG-4 AVC

HP@L4.0, MP@L4.0

Channel coverage

Analogue: UHF/VHF/Cable, Depending on your country/area selection.

Digital: UHF/VHF/Cable, Depending on your country/area selection.

Satellite*1: IF Frequency 950-2150 MHz

Sound output (Only for 19.5V supply)

8 W + 8 W (KDL-40R48xB, KDL-40R45xB)

5 W + 5 W (KDL-32R43xB, KDL-32R41xB)

Input/Output jacks

Antenna (aerial)/cable

75 ohm external terminal for VHF/UHF

Satellite antenna*1

Female F-Type Connector IEC169-24, 75 ohm.

DiSeqC 1.0, LNB 13 V/18 V & 22 kHz tone,

Single Cable Distribution EN50494.

AV1

21-pin scart connector (CENELEC standard) including audio/video input, RGB input and TV audio/video output.

COMPONENT IN/ AV2

COMPONENT IN

Supported formats: 1080p, 1080i, 720p, 576p, 576i, 480p, 480i

Y: 1 Vp-p, 75 ohms, 0.3V negative sync

Pb: 0.7 Vp-p, 75 ohms

Pr: 0.7 Vp-p, 75 ohms

 Video input (phono jack)

COMPONENT IN/ AV2

Audio input (phono jacks)

HDMI IN 1/MHL, HDMI IN 2 (ARC)

HDMI Video: 1080/24p, 1080p, 1080i, 720p, 576p, 576i, 480p, 480i

MHL Video: 1080/24p, 1080/30p, 1080i, 720p, 720/30p, 576p, 576i, 480p, 480i

PC input:

(Resolution, Horizontal frequency, Vertical frequency)

For KDL-40R48xB, KDL-40R45xB

640 × 480, 31.5 kHz, 60 Hz

800 × 600, 37.9 kHz, 60 Hz

1024 × 768, 48.4 kHz, 60 Hz

1280 × 768, 47.4 kHz, 60 Hz

1280 × 768, 47.8 kHz, 60 Hz

1360 × 768, 47.7 kHz, 60 Hz

1280 × 1024, 64.0 kHz, 60 Hz

* 1920 × 1080, 67.5 kHz, 60 Hz

* The 1080p timing when applied to the HDMI input will be treated as a video timing and not PC timing.

For KDL-32R43xB, KDL-32R41xB

640 × 480, 31.5 kHz, 60 Hz

800 × 600, 37.9 kHz, 60 Hz

1024 × 768, 48.4 kHz, 60 Hz

1280 × 768, 47.4 kHz, 60 Hz

1280 × 768, 47.8 kHz, 60 Hz

1360 × 768, 47.7 kHz, 60 Hz

Audio: Two channel linear PCM: 32, 44.1 and 48 kHz, 16, 20 and 24 bits, Dolby Digital

ARC (Audio Return Channel) (HDMI IN 2 only)

DIGITAL AUDIO OUT (OPTICAL)

Digital optical jack

AUDIO OUT,

Audio output, Headphones (mini jack), Subwoofer

USB port (support HDD Rec)

CAM (Conditional Access Module) slot

DC IN 19.5 V

AC adapter input

LAN (Depending on your country/area)

10BASE-T/100BASE-TX connector (Depending on the operating environment of the network, connection speed may differ. 10BASE-T/100BASE-TX communication rate and communication quality are not guaranteed for this TV.)

Others

Optional accessories

Wall-Mount Bracket: SU-WL450
MHL Cable: DLC-MB10/DLC-MB20/DLC-MC10/
DLC-MC20

Operating temperature

0 °C – 40 °C

Operating humidity

10 % – 80 % RH (non-condensing)

Power and others

Power requirements

19.5 V DC with AC adapter
Rating: Input 220 V - 240 V AC, 50 Hz

Energy Efficiency Class

KDL-40R48xB: A
KDL-40R45xB: A
KDL-32R43xB: A
KDL-32R41xB: A

Screen size (measured diagonally) (approx.)

KDL-40R48xB: 40 inches / 101.6 cm
KDL-40R45xB: 40 inches / 101.6 cm
KDL-32R43xB: 32 inches / 80.0 cm
KDL-32R41xB: 32 inches / 80.0 cm

Power consumption

In [Standard] mode

KDL-40R48xB: 58 W
KDL-40R45xB: 58 W
KDL-32R43xB: 36 W
KDL-32R41xB: 36 W

In [Vivid] mode

KDL-40R48xB: 84 W
KDL-40R45xB: 84 W
KDL-32R43xB: 60 W
KDL-32R41xB: 60 W

Average annual energy consumption*²

KDL-40R48xB: 85 kWh
KDL-40R45xB: 85 kWh
KDL-32R43xB: 53 kWh
KDL-32R41xB: 53 kWh

Standby power consumption*³

0.45 W

Display resolution

KDL-40R48xB: 1,920 dots (horizontal) x 1,080 lines
(vertical)
KDL-40R45xB: 1,920 dots (horizontal) x 1,080 lines
(vertical)
KDL-32R43xB: 1,366 dots (horizontal) x 768 lines
(vertical)
KDL-32R41xB: 1,366 dots (horizontal) x 768 lines
(vertical)

Dimensions (Approx.) (w × h × d)

with Table-Top Stand

KDL-40R48xB: 92.6 × 58.4 × 16.2 cm
KDL-40R45xB: 92.6 × 58.4 × 17.5 cm
KDL-32R43xB: 73.6 × 47.3 × 13.1 cm
KDL-32R41xB: 73.6 × 47.3 × 14.4 cm

without Table-Top Stand

KDL-40R48xB: 92.6 × 55.6 × 8.9 cm
KDL-40R45xB: 92.6 × 55.6 × 8.9 cm
KDL-32R43xB: 73.6 × 45.1 × 8.0 cm
KDL-32R41xB: 73.6 × 45.1 × 8.0 cm

Mass (Approx.)

with Table-Top Stand

KDL-40R48xB: 7.5 kg
KDL-40R45xB: 7.4 kg
KDL-32R43xB: 5.0 kg
KDL-32R41xB: 4.9 kg

without Table-Top Stand

KDL-40R48xB: 7.0 kg
KDL-40R45xB: 7.0 kg
KDL-32R43xB: 4.7 kg
KDL-32R41xB: 4.7 kg

- *¹ Not all the TV sets have DVB-T2 or DVB-S/S2 technology or satellite antenna terminal.
- *² Energy consumption per year, based on the power consumption of the television operating 4 hours per day for 365 days. The actual energy consumption will depend on how the television is used.
- *³ Specified standby power is reached after the TV finishes necessary internal processes.

Note

- Optional accessories availability depends on countries/region/TV model/stock.
- Do not remove the dummy card from TV CAM (Conditional Access Module) slot other than to insert a smart card fitted in CAM.
- Design and specifications are subject to change without notice.
- This TV set incorporates MHL 2.

Notes on Digital TV function

- Any functions related to Digital TV (**DVB**) will only work in countries or areas where DVB-T/DVB-T2* (MPEG-2 and H.264/MPEG-4 AVC) digital terrestrial signals are broadcast or where you have access to a compatible DVB-C (MPEG-2 and H.264/MPEG-4 AVC) cable service. Please confirm with your local dealer if you can receive a DVB-T/DVB-T2* signal where you live or ask your cable provider if their DVB-C cable service is suitable for integrated operation with this TV.
- Your cable provider may charge a fee for their services, or require you to agree to its terms and conditions of business.
- This TV set complies with DVB-T/DVB-T2* and DVB-C specifications, but compatibility with future DVB-T/DVB-T2* digital terrestrial and DVB-C digital cable broadcasts are not guaranteed.
- Some Digital TV functions may not be available in some countries/areas and DVB-C cable may not operate correctly with some providers.

* Not all the TV sets have 2nd generation T2* Digital Video Broadcast technology.

Trademark information

- The terms HDMI and HDMI High-Definition Multimedia Interface, and the HDMI Logo are trademarks or registered trademarks of HDMI Licensing LLC in the United States and other countries.
- Manufactured under license from Dolby Laboratories. Dolby and the double-D symbol are trademarks of Dolby Laboratories.
- "BRAVIA" and BRAVIA are trademarks of Sony Corporation.
- Wi-Fi, Wi-Fi Direct and Miracast are trademarks or registered trademarks of Wi-Fi Alliance.
- "Blu-ray Disc", "Blu-ray" and "Blu-ray Disc" logo are trademarks of Blu-ray Disc Association.
- MHL, Mobile High-Definition Link and the MHL Logo are trademarks or registered trademarks of MHL Licensing, LLC.

- For DTS patents, see <http://patents.dts.com>. Manufactured under license from DTS Licensing Limited. DTS, the Symbol, & DTS and the Symbol together are registered trademarks, and DTS 2.0+ Digital Out is a trademark of DTS, Inc. © DTS, Inc. All Rights Reserved.

For satellite models only:

- DiSEqC™ is a trademark of EUTELSAT. This TV supports DiSEqC 1.0. This TV is not intended for controlling motorized antennas.

HDMITM
HIGH-DEFINITION MULTIMEDIA INTERFACE

MHLTM
Mobile High-Definition Link



dts[®]
2.0+Digital Out



For useful information about Sony products
Pour obtenir les informations utiles concernant les produits Sony
Información de utilidad para productos Sony
Voor nuttige informatie over Sony producten
Für hilfreiche Informationen zu Sony Produkten
Para informação útil sobre os produtos Sony
Per informazioni utili sui prodotti Sony
For nyttig informasjon om Sony-produkter
For mere informasjon om Sony-produkter
Hyödyllistä tietoa Sony tuotteista
For nyttig informasjon om Sony produkter
Szczegółowe informacje o produktach Sony

Užitečné informace o výrobcích Sony
Pre viac informácií o produktoch Sony
Sony termékekről hasznos információkat találhat az alábbi weboldalon
Pentru informații utile despre produsele Sony
За полезна информация относно продуктите на Sony
Για χρήσιμες πληροφορίες σχετικά με τα προϊόντα SONY
Sony ürünleri için faydalı bilgiler
Для получения полезной информации о продукции Сони
Для отримання корисної інформації щодо виробів компанії Sony

<http://support.sony-europe.com/>

<http://www.sony.net/>

©2014 Sony Corporation



4528603121

4-528-603-12(1)