



# User Guide

**VGC-V3 Series (PCV-E31M/PCV-F31M)**

## *Read this first*

### *Notice*

© 2005 Sony Corporation. All rights reserved.

This manual and the software described herein, in whole or in part, may not be reproduced, translated, or reduced to any machine-readable form without prior written approval.

Sony Corporation provides no warranty with regard to this manual, the software, or other information contained herein and hereby expressly disclaims any implied warranties or merchantability or fitness for any particular purpose with regard to this manual, the software or such other information. In no event shall Sony Corporation be liable for any incidental, consequential, or special damages, whether based on tort, contract, or otherwise, arising out of or in connection with this manual, the software, or other information contained herein or the use thereof.

Macrovision: This product incorporates copyright protection technology that is protected by U.S patents and other intellectual property rights. Use of this copyright protection technology must be authorised by Macrovision, and is intended for home and other limited viewing uses only unless otherwise authorised by Macrovision. Reverse engineering or disassembly is prohibited.

In the manual, the <sup>TM</sup> or <sup>®</sup> marks are not specified.

Sony Corporation reserves the right to make any modification to this manual or the information contained herein at any time without notice. The software described herein is governed by the terms of a separate user licence agreement.

**Please note that the illustrations in this manual may not necessarily apply to your model. Please see the Specifications sheet for the specific configuration of your VAIO.**

## *ENERGY STAR*

As an ENERGY STAR Partner, Sony has determined that this product meets the ENERGY STAR guidelines for energy efficiency. The International ENERGY STAR Office Equipment Program is an international program that promotes energy saving through the use of computers and their office equipment. The program backs the development and dissemination of products with functions that effectively reduce energy consumption. It is an open system in which business proprietors can participate voluntarily. The targeted products are office equipment such as computers, displays, printers, facsimiles and copiers. Their standards and logos are uniform among participating nations.

ENERGY STAR is a U.S. registered mark.



## *Environmental information*



Halogenated flame retardants are not used in cabinets.

Corrugated cardboard is used for packaging cushions.

## *Owner's record*

The serial number, model number and product key are located on the back of your Sony desktop. Record the numbers and refer to them if you call VAIO-Link. See also the printed **Specifications** sheet.

## *Safety information*

### *General*

- ❑ Opening the unit, for whatever reason, could lead to damages that are not covered by the guarantee.
- ❑ To avoid electrical shock, do not open the cabinet. Refer servicing to qualified personnel only.
- ❑ To prevent fire or shock hazard, do not expose your VAIO desktop to rain or moisture.
- ❑ If reporting a gas leak, do not use the modem or a telephone in the vicinity of the leak.
- ❑ Avoid using the modem during a severe electrical storm.
- ❑ Do not move your computer while the system is in **Standby** mode.
- ❑ The magnetic properties of some objects can have serious consequences for your hard disk drive. They can erase the data on the hard disk drive and cause the computer to malfunction. Do not place your computer near or on any objects, which emit magnetic fields, mainly:
  - ❑ TV sets
  - ❑ Speakers
  - ❑ Magnets and magnetic bracelets.

You can find detailed safety information in the **Regulations Guide**.

### *Audio/video*

Audio and picture distortion may occur if this equipment is positioned in close proximity to any equipment emitting electromagnetic radiation.

## *Connectivity*

- Never install modem or telephone wiring during a severe lightning storm.
- Never install telephone jacks in wet locations unless the jack is specifically designed for wet locations.
- Take care when installing or modifying telephone lines.
- To disconnect your VAIO completely from the mains voltage, unplug the power cable.
- Make sure that the socket outlet is easily accessible.

## *Optical disc drive*

The use of optical instruments can cause eye hazard. As the laser beam used in this product is harmful to the eyes, do not attempt any disassembling process. For servicing, refer to qualified personnel only.

## Regulatory information

Sony hereby declares that this product is in compliance with the essential requirements and other relevant provisions of European Directive 1999/5/EC (radio equipment and telecommunications terminal equipment Directive).

Models with Wireless LAN:

Models without Wireless LAN:



### Declaration of Conformity

The European Union is targeting the free movement of goods for the internal market and to prevent technical barriers to trade. This effort has resulted in several EU Directives asking that manufacturers make their products comply with essential standards. Manufacturers are required to affix the "CE" mark on the products they sell and to draw up a "Declaration of Conformity" (DoC).

Primarily, the Declarations of Conformity are intended for the market surveillance authorities as proof that products satisfy the required standards. Additionally, Sony provides these EU DoC's on the website [www.compliance.sony.de](http://www.compliance.sony.de) as a service to our customers.

You can search for all Declarations of Conformity available for a specific product by typing in the model name in the search box. A list of matching documents will be displayed and can be downloaded. Please note that the availability of declarations depends on the scope of the EU Directives and the individual product specifications.

Before activating the built-in modem, please read the **Regulations Guide**.

You can find detailed safety information in the **Regulations Guide**.

If your model is equipped with Wireless LAN, please read the **Regulations Guide** before activating the Wireless LAN functionality.

Depending on the country, usage of the **Wireless LAN** functionality may be restricted. For country-specific details, please refer to the **Regulations Guide**. The Wireless LAN PC functionality which is incorporated into this unit has passed Wi-Fi certification, and complies with the interoperability specifications established by WECA (Wireless Ethernet Compatibility Alliance).



## Disposing of the internal memory backup battery

- ❑ Your Sony VAIO desktop is equipped with an internal back-up memory battery (motherboard battery) that should not have to be replaced during the lifetime of the product. If you want to replace the battery, please contact VAIO-Link: [www.vaio-link.com](http://www.vaio-link.com)
- ❑ Keep away from children.
- ❑ Dispose of the battery properly at its end-of-life.
- ❑ In some areas the disposal of non-hazardous batteries in household or business waste may be prohibited. Please use the public waste collection system.

## Disposing of the AA batteries

AA batteries are delivered with this VAIO (keyboard, mouse and remote control).

- ❑ Do not handle damaged or leaking batteries.
- ❑ Dispose of promptly and properly at end-of-life.
- ❑ May explode or leak if recharged, disposed of in fire, mixed with other types of battery or improperly installed.
- ❑ Keep away from children.
- ❑ In some areas, the disposal of batteries in household or business waste may be prohibited. Please use the public waste collection system.

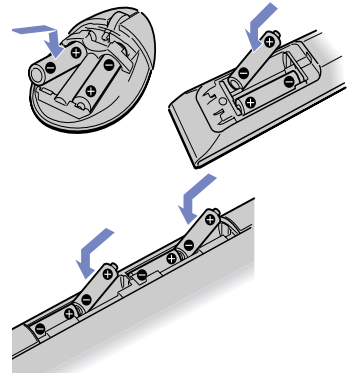

# Welcome

Congratulations on purchasing a Sony VAIO computer. Sony has combined leading-edge technology in audio, video, computing and communications to provide you with state-of-the-art personal computing.

As well as exceptional performance, here are the main features you can enjoy:

- ❑ **Sony audio and video quality** – The high-quality internal speakers and graphics enable you to take advantage of today's advanced multimedia applications, games, and entertainment software.
- ❑ **Wireless setup** – Thanks to the Wireless LAN (IEEE 802.11b/g) technology, you can communicate freely, without cables or wires.
- ❑ **VAIO Zone** – Take advantage of this new software application, allowing you to enjoy music, video, and photos locally or through a home networking environment. If your computer has TV tuner functionalities, you can also watch/record TV on your VAIO.
- ❑ **tvvtv** – tvvtv takes your VAIO's TV functions to a new level. Never miss your favourite TV programme again, by remote-recording it via the Internet onto your TV tuner-equipped VAIO. The tvvtv Interactive Programme Guide gives you a comprehensive overview of what's on when and automatically synchronises it with your VAIO, wherever you happen to be at the time.
- ❑ **Multimedia features** – Make the most out of your audio and video CDs and DVDs, even record them yourself.
- ❑ **Sony Memory Stick PRO slot** – This compact digital storage medium allows you to easily transfer images, sounds, data and text between cameras, computers, and more.
- ❑ **Windows XP with Service Pack 2** – Your system includes the latest operating system from Microsoft.
- ❑ **Excellent customer support** – If you are experiencing any problems with your computer, please check the VAIO-Link website for a possible solution: [www.vaio-link.com](http://www.vaio-link.com). Before contacting VAIO-Link, please try to solve the problem by using the search functionality in **Help and Support Center** or by reading this guide, your printed **Troubleshooting Guide**, your printed **Recovery Guide** or the manuals and help files for the peripherals or software.



## Documentation pack

Your documentation pack contains printed information and user guides to read on your computer.

Guides are provided in PDF format, which you can easily browse through and print out.

The **My Club VAIO** portal is a perfect starting point to **use** your VAIO - a comprehensive collection of everything you need to get the most from your PC.

The user guides are collected under **Documentation**, which can be shown as follows:

- 1 Go to **Start** and click the **My Club VAIO** icon .
- 2 Click **Documentation**.
- 3 Select the guide you want to read.

 You can manually browse to the user guides by going to **My Computer** > **VAIO (C:)** (your C drive) > **Documentation** > **Documentation** and opening the folder for your language.

You may have a separate disc for the documentation of bundled accessories.

## *Printed documentation*

The printed part of your documentation pack includes the following:

- ❑ A **Specifications** sheet, containing a table of specifications, a list of bundled software and, on the reverse side, a guide to setting up your VAIO;
- ❑ A **Troubleshooting Guide**, where you will find VAIO-Link information and solutions to common problems;
- ❑ A **Recovery Guide**, where you will find an explanation about the recovery process of your VAIO;
- ❑ Booklets containing the following information: **Sony Guarantee** conditions, **Safety Regulations**, **Modem Regulations** and **Wireless LAN Regulations**.

## *Help and Support Center*

**Help and Support Center** is a comprehensive resource for practical advice, tutorials, and demonstrations to help you learn to use Microsoft Windows XP and your VAIO. Use the Search feature, Index, or table of contents to view all Windows Help resources, including those that are on the Internet.

To access **Help and Support Center**, proceed as follows:

- 1 Go to **Start**.
- 2 Click **Help and Support**.

## My Club VAIO

In **My Club VAIO**, you can find:

**Documentation**, which gives you:

- Access to the **User Guide**. This guide explains the features of your VAIO in detail, how to use these features confidently and safely, connect peripheral devices and more.
- Access to **Help and Training**. This is the portal of **VAIO Help and Support Center**.
- Important information about your computer, in the form of notices and announcements.

In **My Club VAIO** you can also find:

### Accessories

Want to expand the capabilities of your VAIO? Click on this icon and have a look at your compatible accessories.

### Software

Feeling creative? Click this icon for an overview of your software and check out our upgrade options.

### Wallpapers

Click this icon and check out our most popular Sony and Club VAIO wallpapers.

### Links

Click this icon and check out our most popular Sony and Club VAIO websites.

## Further sources

- Consult the **Online Help** files of the software you are using for detailed information on features and troubleshooting.
- Go to [www.club-vaio.com](http://www.club-vaio.com) to find online tutorials about your favourite VAIO software.

## *Ergonomic considerations*

Whenever possible, try and take into account the following ergonomic considerations when using your new computer, whether at home or in the office:

- ❑ **Position of the keyboard and mouse** – Make sure the keyboard is directly in front of you. Keep your forearms horizontal, with your wrists in a neutral, comfortable position while using the keyboard or mouse – not at an angle. Let your upper arms hang naturally at your sides. Place the mouse at the same level as the keyboard and use your whole arm to move it.
- ❑ **Position and viewing angle of the display** – Set the display at a comfortable viewing distance. Make sure the display screen is at eye level or slightly lower. Use the display's tilting feature to find the best position. You can reduce eye-strain and muscle-fatigue by adjusting the tilt of the display to the proper position. Remember to adjust the brightness setting of the display.
- ❑ **Furniture and posture** – Sit in a chair with good back support. Adjust the level of the chair so your feet are flat on the floor. A footrest may make you more comfortable. Sit in a relaxed, upright posture and avoid slouching forward or leaning too far backwards.
- ❑ **Lighting** – Choose a location where windows and lights do not create glare or reflection on the display. Use indirect lighting to avoid bright spots reflecting on the display. Proper lighting adds to your comfort and work effectiveness.
- ❑ **Ventilation** – Make sure you leave at least 25 cm of space behind and on each side of the main unit.
- ❑ **And finally** – Remember to have breaks during sessions with your computer. Excessive use of the computer may strain muscles or tendons.

## Using your VAIO

Once you have read and followed the information on the printed **Specifications** sheet, you can start using your computer safely and confidently. Read on to get the most out of using your VAIO computer.

- Shutting down your computer safely ([page 13](#))
- Using the keyboard ([page 14](#))
- Using the pointing device ([page 18](#))
- Using the mouse ([page 20](#))
- Using the TV function ([page 23](#))
- Using the disc drive ([page 24](#))
- Using the modem ([page 27](#))
- Using power modes ([page 28](#))
- Using the Memory Stick ([page 30](#))
- Using PC Cards ([page 33](#))
- Using Wireless LAN (WLAN) ([page 35](#))

## Shutting down your computer safely

It is important that you shut down your computer properly so you do not lose unsaved data.

To shut down your computer, proceed as follows:

- 1 Turn off any peripherals connected to your computer.
- 2 Click the **Start** button.
- 3 Click **Turn Off Computer**.  
The **Turn off computer** window appears.
- 4 Click **Turn Off**.
- 5 Respond to any prompts warning you to save documents or to consider other users and wait for your computer to turn off automatically.  
The power indicator turns off.

 See the printed **Troubleshooting Guide** if you have problems shutting down your computer.

## Using the keyboard



Your VAIO is delivered with a wireless keyboard. You can place the keyboard anywhere you find comfortable within a range of 10 m\* from the main unit.

The keyboard has a standard key arrangement and additional keys that perform specific functions. For more information on the standard keys and shortcuts, please go to **Help and Support Center (Start > Help and Support)**. The VAIO-Link website ([www.vaio-link.com](http://www.vaio-link.com)) also contains glossary information to help you use the keyboard.

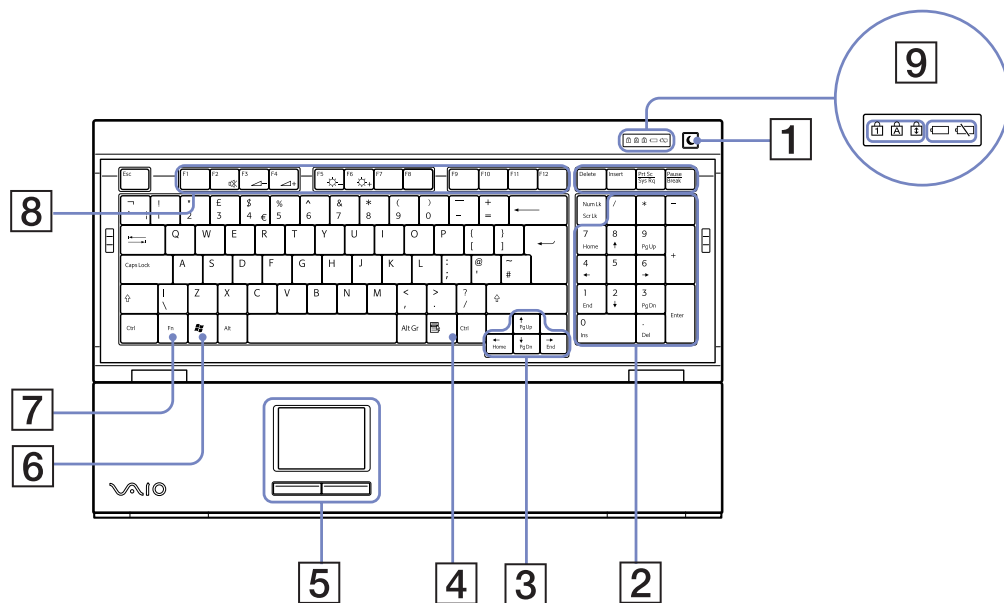

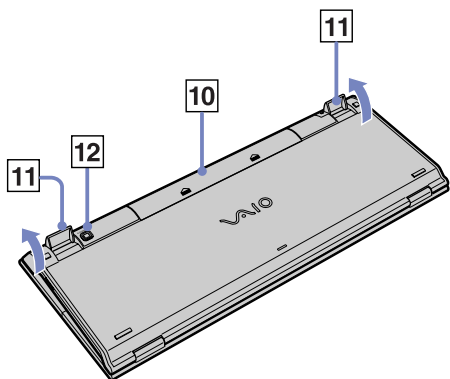
\* Effective usage distance depending on the environment.





	KEY	FUNCTION
1	<b>Standby</b> 	Press the button to place the computer in <b>Standby</b> mode. Press the power button or <b>Standby</b> key briefly to resume normal operation.
2	<b>Numeric keypad</b>	Use the numeric keypad to type numbers or to perform basic maths calculations. Press the <b>Num Lock</b> key to activate the numeric keypad. Press the <b>Num Lock</b> key again to deactivate the numeric keypad.
3	<b>Directional arrows</b>	The Up, Down, Left, and Right arrow keys move the pointer on the screen.
4	<b>Applications</b> 	The <b>Applications</b> key displays a shortcut menu in certain software programmes. Pressing this key is equivalent to clicking the right mouse button.
5	Pointing device	See <b>Using the pointing device</b> (page 18) for more information.
6	<b>Windows</b> 	The <b>Microsoft Windows</b> key displays the <b>Start</b> menu. Pressing this key is equivalent to clicking <b>Start</b> on the taskbar.



	KEY	FUNCTION
7	<Fn> key	Used in combination with other keys to execute commands. <Fn>+<F2>: Turns off the speaker sound. <Fn>+<F3>: Decreases the volume of the speakers. <Fn>+<F4>: Increases the volume of the speakers. <Fn>+<F5>: Decreases the brightness of the display screen. <Fn>+<F6>: Increases the brightness of the display screen.
8	<b>Function keys</b>	The 12 function keys along the top of the keyboard are used to perform certain tasks. The task associated with each function key may vary from one application to the next.
9	LED screen	<p><b>Num Lock:</b></p>  Turns on when the number keys in the numeric keypad are active.
		<p><b>Caps Lock:</b></p>  Turns on when the letters appear in uppercase as you type. The <Shift> key lowers the case of typed characters when <b>Caps Lock</b> is on.
		<p><b>Scroll Lock:</b></p>  Turns on when the screen scrolls differently (not all applications support this function).
10	Battery compartment	Storage compartment for the AA batteries.
11	Keyboard feet	Extend to adjust the keyboard height.
12	<b>CONNECT</b> button	Press to enable the keyboard to communicate with the system unit.

## Before you use the keyboard

Before attempting to use the wireless keyboard, you must enable communication between the computer and the keyboard.

Four AA batteries, for use in the wireless keyboard, are supplied with your VAIO.

To connect the wireless keyboard, proceed as follows:

- 1 Insert the 4 AA batteries (1) into the wireless keyboard as shown.
- 2 Turn on the computer.
- 3 Slide the power switch on the right-hand side of the keyboard to turn on the keyboard (2).
- 4 Press the **CONNECT** button on the right panel of the computer (3).
- 5 Turn the wireless keyboard over and press the **CONNECT** button (4). Communication between the wireless keyboard and the computer is now active.

 Steps 4 and 5 must be carried out within 10 seconds of each other.

If your wireless keyboard does not operate properly, the batteries may need to be replaced. Always use the same type and brand of batteries. If your wireless keyboard is not being used for extended periods of time, remove the batteries to avoid possible damage from battery leakage. Do not place other wireless devices or metal objects near your VAIO or wireless keyboard, as this may cause interference. Do not obstruct the communication between your wireless keyboard and your VAIO.

If you want to put the keyboard in a more 'ergonomical' position, open the keyboard feet.

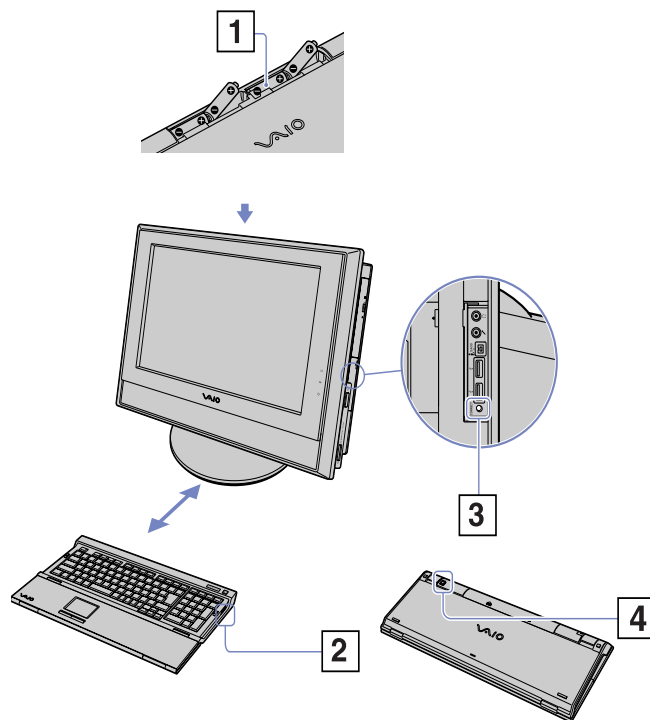
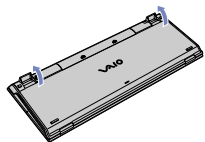

## Using the pointing device

The keyboard features a pointing device (1), which controls the cursor on the screen. You can point to, select and drag objects on the screen using the built-in pointing device.

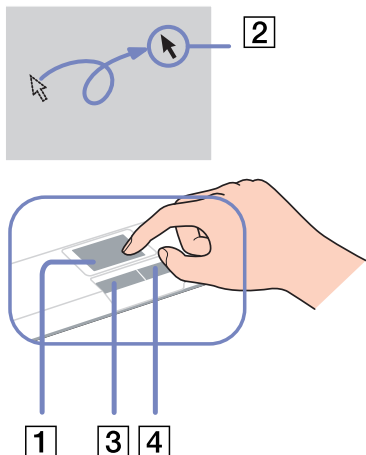

<i>Action</i>	<i>Description</i>
Point	Slide one finger on the pointing device to place the pointer (2) on an item or object.
Click	Press the left button (3) once.
Double-click	Press the left button twice.
Right-click	Press the right button (4) once. In many applications, this action displays a shortcut menu.
Drag and select	Slide one finger while pressing the left button.

## Before using the pointing device

Before attempting to use the pointing device, you must activate it.

To activate the pointing device, proceed as follows:

- 1 Fold the keyboard out.
- 2 Turn on the **Pointing Device** switch (1).
- 3 Close the lower part of the cover as shown (2).  
You can now use the pointing device together with your keyboard.
- 4 If you only want to use the pointing device, close the cover completely as shown (3).

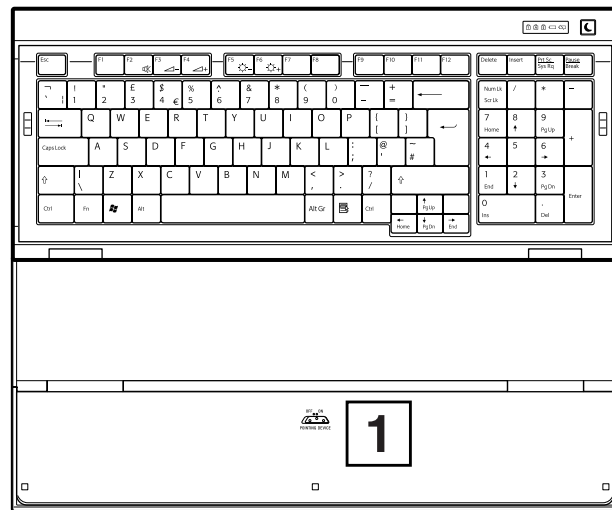
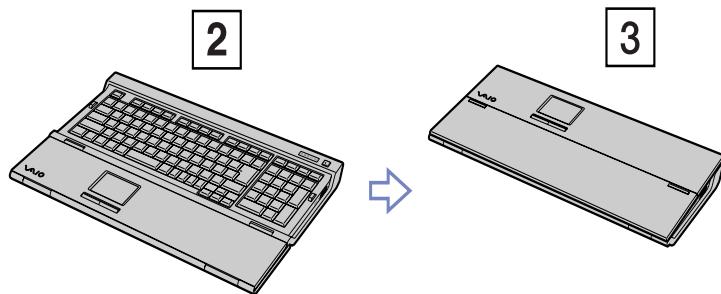

## Using the mouse

Your computer is delivered with a wireless optical mouse, which has no cables to plug in and uses a light-emitting diode (LED) instead of a ball. You can use the mouse anywhere you feel comfortable within a range of 10 m\* of the main unit. Avoid using the mouse on a piece of glass or other transparent material, as this can interfere with smooth cursor movement on the screen.

\* Effective usage distance depending on the environment.

1	Left button	Click or double-click the left button to select items. To drag and drop items, hold the left button down while sliding the mouse, then release the button to drop the item.
2	Right button	Press the right button once to display a context-sensitive shortcut menu (not always an active function).
3	Central wheel	Turn the central wheel to scroll up or down a page. Press the wheel once to lock the scroll action and control the movement by moving the entire mouse (The scroll function is available only with applications that support it).
4	Power switch	Slide switch to turn the mouse on and off. This will help you save battery power.
5	<b>CONNECT</b> button	Press to enable communication between your VAIO computer and the wireless mouse.

You can adjust the mouse pointer speed and other functions under **Mouse Properties**. To display **Mouse Properties**, go to the **Control Panel**, select **Printers and Other Hardware**, then select **Mouse**.

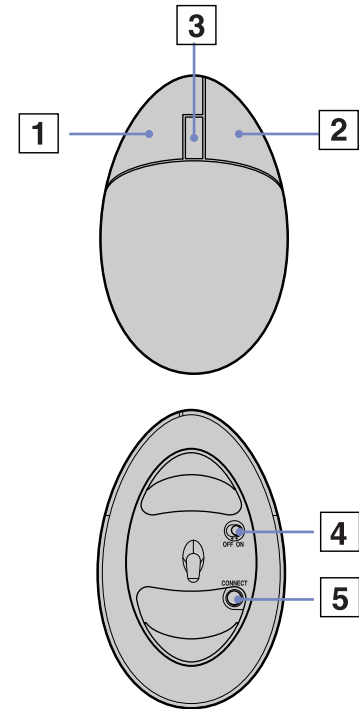

## Before using the mouse

Before attempting to use the wireless mouse, you must enable communication between the computer and the mouse.

Two AA batteries, for use in the wireless mouse, are supplied with your VAIO. They are identified by a sticker "For mouse" on the packaging.

To connect the wireless mouse, proceed as follows:

- 1 Turn the wireless mouse over and slide the power button to the **OFF** position (1).
- 2 Insert the two AA batteries into the wireless mouse as shown (2).
- 3 Turn on the computer.
- 4 Press the **CONNECT** button on the right panel of the computer (3).
- 5 Turn the wireless mouse over, slide the power button to the **ON** position (4) and press the **CONNECT** button (5).

Communication between the wireless mouse and the computer is now active.

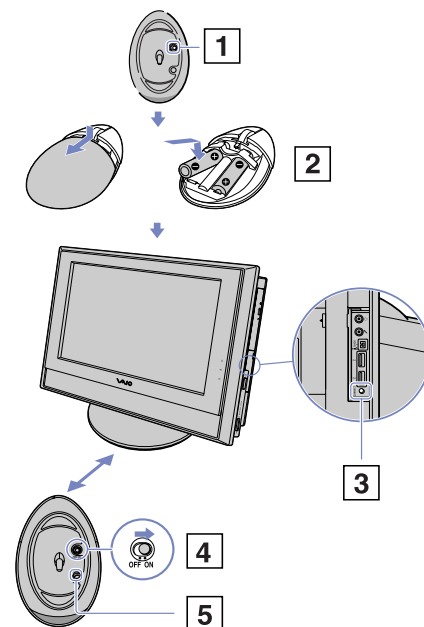

 Steps 4 and 5 must be carried out within 10 seconds of each other.

If your wireless mouse does not operate properly, the batteries may need to be replaced with new ones. Always use the same type and brand of batteries. If your wireless mouse is not being used for an extended period of time, remove the batteries to avoid possible damage from battery leakage. Do not place other wireless devices or metal objects near your VAIO or wireless mouse, as this may cause interference. Do not obstruct the communication between your wireless mouse and your VAIO.

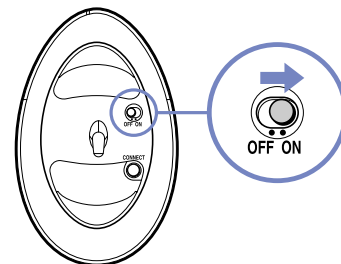

## Setting up the mouse for left-handed users

To set your mouse up for left-handed users, proceed as follows:

- 1 Go to **Start**, select **Control Panel**, then click the **Printers and Other Hardware** option.
- 2 Click the mouse icon.  
The **Mouse Properties** dialog box appears.
- 3 In the **Buttons** tab, select the option button next to **Switch primary and secondary buttons**.
- 4 Click **OK**.  
The new mouse settings are now in place.

## Using the TV function

Your VAIO is equipped with a TV tuner board. In combination with Sony's **VAIO Zone** software, it allows you to:

- Watch, record and play back analogue broadcasted cable and terrestrial TV programmes, all by remote control;
  - Digitise analogue video and audio using the S-video or composite and audio inputs;
  - Manage your video units (capsules), preview them and create multiple folders;
  - Set up a timer to record channels at a repeated time;
  - Suspend viewing TV (time-shifting);
  - Stream your recorded TV contents via Ethernet (or WLAN) to connected PCs.
-  Sony cannot guarantee the streaming of recorded content if it is beyond a certain level of high quality.

For details on using **VAIO Zone** and the remote control, please see the dedicated guide. Otherwise read the help files within the software itself.

tvTV takes your VAIO's TV functions to a new level. Never miss your favourite TV programme again, by remote-recording it via the Internet onto your TV tuner-equipped VAIO. The tvTV Interactive Programme Guide gives you a comprehensive overview of what's on when and automatically synchronises it with your VAIO, wherever you happen to be at the time. For more information, read the **Welcome to tvTV** HTML files on your computer.



## Using the disc drive

Your computer is equipped with a double layer DVD±RW drive, which reads data from a compatible CD or DVD and writes data to a DVD-RW, DVD+RW, DVD-R, DVD+R, CD-RW, or CD-R.

To insert a disc, proceed as follows:

- 1 Turn on the computer.
- 2 Press the eject button to open the drive.  
The tray pops out.
- 3 Place a disc in the tray with the label side facing outwards.  
Make sure the disc is secure in the centre of the tray.
- 4 Close the tray by pushing it gently.

 See the printed **Troubleshooting Guide**.

## *Reading and writing CDs and DVDs*

To achieve optimum performance when writing data on to disc (also called 'burning'), follow these recommendations:

- To make the data on a disc readable on an optical drive, you need to close the session when you eject it. To complete this process, follow the instructions included with your software.
- Only use circular discs. Do not use discs with any other shape (star, heart, card, etc.), as this may damage the disc drive.
- Do not strike or shake the computer while writing data to a disc.
- For optimal writing speed, deactivate the screensaver before writing data to a disc.
- Memory-resident disc utilities may cause unstable operation or data loss. Deactivate these utilities before writing data to a disc.
- When using your software application to burn discs, make sure you exit and close all other applications.
- Never touch the surface of the disc. Fingerprints and dust on the surface of a disc may cause writing errors.
- Do not put your VAIO computer into a power saving mode while using the pre-installed software or while using the CD burning software.
- Never put labels on discs. This will affect the use of the disc irreparably.

## Playing DVDs

To achieve optimum performance when playing DVDs, you should follow these recommendations:

- Close all open applications before playing a DVD movie.
- Play DVDs with the software **VAIO Zone**.
- Do not switch power saving modes while playing a DVD.
- Do not use built-in utility applications to speed up discs, because they may cause the system to become unstable.
- Make sure the screensaver is deactivated.
- Region codes indicators are labelled on the DVDs to indicate in which region and on what type of player you can play the disc. Unless a '2' (Europe belongs to region '2') or 'all' (this means that you can play this DVD everywhere in the world) is labelled on your DVD disc or on the packaging, you cannot play the disc on this player.
- Do not try to change the region code settings of the DVD drive. Any difficulties caused by changing the region code settings of the DVD drive are out of warranty.
- If your computer has Wireless LAN and Wireless LAN is activated, playing DVDs may cause some interruptions in audio and video playback.

## Troubleshooting discs

If you have problems with your optical disc, check **Help and Support Center** and the VAIO-Link website ([www.vaio-link.com](http://www.vaio-link.com)).

## *Using the modem*

Your VAIO desktop is equipped with an internal modem. As described on the printed **Specifications** sheet, use the single RJ-11 jack to connect the supplied modem cable to the phone line. Once you have connected the phone line and registered with an Internet Service Provider, you can take advantage of online services and the Internet, to register your computer and software online and to contact VAIO-Link.

## *Troubleshooting the modem*

If you have problems with your modem, check **Help and Support Center** and the VAIO-Link website ([www.vaio-link.com](http://www.vaio-link.com)).

## Using power modes

The colour of the power indicator light behind the power button tells you which mode the computer is in.

Power indicator	Mode
Green	Computer is in <b>Normal</b> mode (on)
Amber	Computer is in <b>Standby</b> mode
No light	Computer is turned off or in <b>Hibernate</b> mode

 Please see the printed **Specifications** sheet for the exact location of the indicators.

To set the timer for your computer to automatically enter **Standby** or **Hibernate** mode after a certain amount of time, go to **Control Panel**, click **Performance and Maintenance** and change the settings under **Power Schemes**.

### Using **Standby** mode

If you plan to stop using your computer for a short period of time (not overnight), you can put it into **Standby** mode instead of turning it off completely. Putting the computer into **Standby** mode saves energy and allows a quick return to normal computer use.

To activate **Standby** mode manually, proceed as follows:

- 1 Save your work, close all applications and close your Internet connection, if applicable.
- 2 Press the **Standby** button on the keyboard . Alternatively, from the **Start** menu on the Windows taskbar, select **Turn Off Computer** and select **Stand By**. The computer goes into **Standby** mode, indicated by the amber light of the power indicator.
- 3 To return to **Normal** mode, press the **Standby** button or any other key on the keyboard, or press the **Power** button briefly.

 You can leave Windows running when using **Standby**.

If you press the power button for more than 4 or 6 seconds (depending on your model), the computer will switch off completely.

When the computer is in **Standby** mode, you cannot insert a disc.

The computer comes out of **Standby** mode quicker than out of **Hibernate** mode and uses more power.

## Using *Hibernate* mode

If you are interrupted and need to leave your computer suddenly, you can put it into **Hibernate** mode. This power saving mode saves you the time of shutting down in the normal way.

When you put your computer into **Hibernate** mode:

- Everything in the memory is saved to the hard disk.
- The monitor and system are turned off.
- The computer is turned off.
- The power indicator light turns off.

To activate **Hibernate** mode manually, proceed as follows:

- 1 Save your work.
- 2 From the **Start** menu on the Windows taskbar, select **Turn Off Computer**.
- 3 In the **Turn Off Computer** screen, hold down the **<Shift>** key to reveal the **Hibernate** button.
- 4 Click **Hibernate**.

The computer goes into **Hibernate** mode, the computer turns off.

Alternatively, quickly press the power button.

To return to **Normal** mode, quickly press the power button.

Operation returns to the same state as before.

 You can leave Windows running when using **Hibernate**.

If you press the power button for more than 4 or 6 seconds (depending on your model), the computer will switch off completely.

When the computer is in **Hibernate** mode, you cannot insert a disc.

**Hibernate** uses less power than **Standby** and requires more time.

## Using the Memory Stick

Your VAIO computer is designed to support the Memory Stick. The Memory Stick is a compact, portable, and versatile device especially designed for exchanging and sharing digital data with compatible products, such as digital cameras, mobile phones and CLIÉ handheld devices. Because it is removable, it can be used for external data storage.

Use the flash memory technology to download anything that can be converted into digital data, such as pictures, music, words, sounds, movies and photographs.

Please see your printed **Specifications** sheet to see which Memory Stick types are compatible with your VAIO and if there are any limitations.

- You can purchase Memory Sticks from the Sony Style website ([www.sonystyle-europe.com](http://www.sonystyle-europe.com)), or from your local Sony dealer.
  - Detailed information about which VAIO computers are compatible with which Memory Sticks can be found here: [www.vaio-link.com](http://www.vaio-link.com).
-  Never use the Windows XP Format command to format a Memory Stick. Using the Windows XP format command can make your Memory Stick inaccessible. For more information, consult **Help and Support Center**.

## Inserting a Memory Stick

To insert a Memory Stick, proceed as follows:

- 1 Locate the Memory Stick slot on the unit.
- 2 Hold the Memory Stick with the connectors pointing towards the front and push it in until it clicks.  
The Memory Stick is automatically detected by your system and appears in the **My Computer** window with its own drive.

 Always hold the Memory Stick with the arrow pointing in the correct direction when you insert it into the slot. To avoid damaging the computer or the Memory Stick, do not force the Memory Stick into the slot if it does not insert smoothly.

## Removing a Memory Stick

To remove a Memory Stick, proceed as follows:

- 1 Make sure the indicator light is not on.
- 2 Push the Memory Stick in to release it, and then pull it out.

 Always remove the Memory Stick gently, or it may pop out unexpectedly.

You are recommended to remove the Memory Stick before shutting down the computer.

If an error message appears when you remove it, insert the Memory Stick into the slot again and press **<Enter>**. Wait until the active application finishes, then remove the Memory Stick. If the message confirms the ejection of the Memory Stick, click **OK**.

**!** Do not remove the Memory Stick while the Memory Stick indicator is turned on. If you do, you may lose data. When you remove the Memory Stick during file transfer, large volumes of data may be lost.



## Write-protecting cards

Some Memory Sticks are designed with an erasure prevention switch to protect valuable data from accidental erasure or overwriting. Move the tab horizontally or vertically to set or release write-protection. When the erasure prevention switch is off, data can be saved on the Memory Stick. When the erasure prevention switch is on, data can be read from but not saved on the Memory Stick.

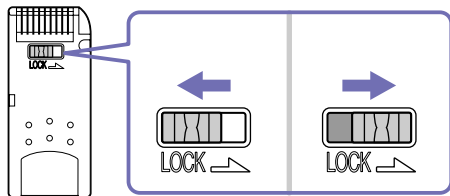



 Some kinds of Memory Stick do not have a lock switch.

## Using PC Cards

Your VAIO desktop has a PC Card slot on the side panel that supports Type I or Type II PC Cards. PC Cards allow you to interconnect with portable external devices.

### Inserting a PC Card

Insert the PC Card gently into the PC Card slot with the label and arrow facing towards you. The PC Card is automatically detected by your system and the **Safely Remove Hardware**  icon appears in the taskbar.

 You do not need to shut down your computer when inserting a PC Card.

Some PC Cards may require you to disable idle devices when using the PC Card.

You may not be able to use some PC Cards or some functions of the PC Card with this computer.

Make sure you use the most recent software driver provided by the PC Card manufacturer.

If the PC Card is operating abnormally, go to **Control Panel, Performance and Maintenance, System**, click the **Hardware** tab, and then **Device Manager**. If an “!” mark appears next to the PC Card device, remove the software driver and then reinstall it from the installation CD that accompanies the PC Card.

Do not force a PC Card into the slot as it may damage the connector pins. If you have difficulty inserting a PC Card, check that you are inserting the PC Card in the correct direction. See the manual supplied with your PC Card for more information on use.

For some PC Cards, if you alternate between **Normal** power operation and **Standby** or **Hibernate** power management modes while the card is inserted, you may find that a device connected to your system is not recognised. Reboot your system to correct the problem.

## Removing a PC Card

Follow the steps below to remove the PC Card while your computer is on. If it is not removed in the correct way, your system may crash and unsaved data may be lost. If you want to remove a PC Card when your computer is off, skip steps 1 to 5.

To remove a PC Card, proceed as follows:

- 1 Close any applications that are using the PC Card.
- 2 Double-click the **Safely Remove Hardware** icon  in the taskbar. The **Safely Remove Hardware** dialog box appears.
- 3 Select the hardware you want to unplug and click **Stop**.
- 4 In the **Stop a Hardware device** dialog box, select the device, confirm that it can be safely removed from the system and click **OK**.  
You see the message that it is safe to remove the device.
- 5 Click **Close**.
- 6 Press the PC Card release button once so it is extended and ready for use.
- 7 Push the PC Card release button to eject the card and then pull it out.

## Using Wireless LAN (WLAN)

Thanks to Sony's Wireless LAN (WLAN)\*, all your digital devices with built-in WLAN functionality communicate freely with each other through a powerful network. A WLAN is a network in which a mobile user can connect to a local area network (LAN) through a wireless (radio) connection. So there is no need anymore to pull cables or wires through walls and ceilings.

The Sony WLAN supports all normal Ethernet activities, but with the added benefits of mobility and roaming. You can still access information, internet/intranet and network resources, even in the middle of a meeting, or as you move from one place to another. You can communicate **without an Access Point**, this means that you can communicate between a limited number of computers (**computer-to-computer**), or you can communicate **with an Access Point**, which allows you to create a full infrastructure network (**infrastructure**).

\* Depending on your model.

 In some countries, using WLAN products may be restricted by the local regulations (e.g. limited number of channels). Therefore, before activating the WLAN functionality, read the **Regulations** booklet carefully. Channel selection is explained further in this manual (see **How to select a Wireless LAN channel** ([page 39](#))).

WLAN uses the IEEE 802.11b/g standard, which specifies the used technology. The standard includes the encryption method: **Wired Equivalent Privacy (WEP)**, which is a security protocol and **WiFi Protected Access (WPA)** - Proposed jointly by the IEEE and Wi-Fi Alliance, WiFi Protected Access is a specification of standards based, interoperable security enhancements that increase the level of data protection and access control for existing WiFi networks. WPA has been designed to be forward compatible with the IEEE 802.11i specification. It utilizes the enhanced data encryption TKIP (Temporal Key Integrity Protocol) in addition to user authentication using 802.1X and EAP (Extensible Authentication Protocol). Data encryption protects the vulnerable wireless link between clients and Access Points. Besides that, there are other typical LAN security mechanisms to ensure privacy, such as: password protection, end-to-end encryption, virtual private networks, and authentication.

Wireless LAN devices using the IEEE 802.11a standard and those using the IEEE 802.11b or g standard cannot communicate because the frequencies are different. Wireless LAN devices using the IEEE 802.11g standard can only communicate with a device using the IEEE 802.11b standard, not with the a standard.

IEEE 802.11b: The standard speed is 11 Mbps, or about 30 to 100 times faster than a standard dial up.

IEEE 802.11g: The standard speed is 54 Mbps, or about 5 times faster than a Wireless LAN device using the IEEE 802.11b standard.

## *Communicating without an Access Point (computer-to-computer)*

A computer-to-computer network is a network in which a local network is created only by the wireless devices themselves, with no other central controller or Access Point. Each device communicates directly with other devices in the network. You can set up a computer-to-computer network easily at home.

To communicate without an Access Point (computer-to-computer), proceed as follows:

- 1 Turn on the wireless switch.  
If your computer supports Bluetooth, the **Wireless Device Switch** dialog box appears.  
Select the **Enable 2.4 GHz Wireless LAN** check box and deselect the **Enable Bluetooth Device** check box, then click the **OK** button.  
The Wireless LAN indicator lights up.
- 2 Right-click the network icon in the taskbar displaying **Wireless Network Connection**.
- 3 Click **View Available Wireless Networks**.  
The **Wireless Network Connection** dialog box appears.
- 4 Click the **Change advanced settings** link.  
The **Wireless Network Connection Properties** dialog box appears.
- 5 Select the **Wireless Networks** tab.
- 6 Click the **Add** button.  
The **Wireless network properties** dialog box appears.
- 7 Enter a **Network name (SSID)\***.
- 8 Select **Open** from the **Network Authentication** drop-down box.
- 9 Select **WEP** from the **Data Encryption** drop-down box if you want to use data encryption.
- 10 Deselect the **The key is provided for me automatically** option button.  
Some information becomes visible.
- 11 Fill in the **Network key\***.

- 12 Fill in exactly the same **Network key** again, for confirmation.
- 13 Select the **This is a computer (ad hoc) network; wireless access points are not used** check box at the bottom of the screen.
- 14 Click **OK**.  
Your **Network name** appears in the **Preferred networks** list.
- 15 Click **OK**.  
The network you have created appears in the list.  
Your computer is ready to communicate with another computer.

\* If you want to communicate between two or more computers, you need to configure all these computers the exact same way. This means that you need to enter the same Network name and the same Network key on all computers as on the first computer you configure.

 In France, only certain channels are legally allowed when using WLAN outdoors. For more information, see the **Regulations** booklet.

A computer-to-computer network does not support WPA.

A Network key can contain ASCII or hexadecimal characters:

**ASCII:** The basis of character sets used in almost all present-day computers. ASCII is a code for representing English characters as numbers, with each letter assigned a number from 0 to 127.

**Hexadecimal:** A number representation using the digits 0-9, with their usual meaning, plus the letters A-F (or a-f) to represent hexadecimal digits with values of (decimal) 10 to 15.

## Communicating with an Access Point (infrastructure)

An infrastructure network is a network that extends an existing wired local network to wireless devices by providing an Access Point, for example the **Sony PCWA-A320 Access Point**. The Access Point bridges the wireless and wired LAN and acts as a central controller for the Wireless LAN. The Access Point coordinates transmission and reception from multiple wireless devices within a specific range.

To communicate with an Access Point (infrastructure), proceed as follows:

- 1 Set up the Access Point as described in the manual delivered with the Access Point and turn on the Access Point.
- 2 Turn on the wireless switch.  
If your computer supports **Bluetooth**, the **Wireless Device Switch** dialog box appears.  
Select the **Enable 2.4 GHz Wireless LAN** check box and deselect the **Enable Bluetooth Device** check box, then click the **OK** button.  
The Wireless LAN indicator lights up.
- 3 Right-click the network icon in the taskbar displaying **Wireless Network Connection**.
- 4 Click **View Available Wireless Networks**.  
The **Wireless Network Connection** dialog box appears.  
The Access Points appears in the list.  
If the Access Point is not displayed, click the **Refresh network list** link.
- 5 Select the network you want to use and click the **Connect** button.  
The **Wireless Network Connection** dialog box appears.
- 6 Type the **Network key** if applicable and click the **Connect** button.  
After 30 seconds, the connection is established.  
Once you are connected, you see the word **Connected** appear behind the name of the network.

 For more information about setting up an access point, see the documentation supplied with your **Access Point**.

## *How to select a Wireless LAN channel*

In an 802.11b/g configuration, channels 1 to 13 can be used.

### *(a) With an Access Point ("Infrastructure")*

- The channel used will be the channel selected by the Access Point.

 For details on how to select the channel that will be used by the Access Point, please refer to the corresponding instruction manual.

### *(b) Without Access Point ("computer-to-computer")*

- If the Wireless connection is initiated by the VAIO computer, channel 11 will be selected.
- If the Wireless connection is initiated by a peer Wireless LAN equipment, the Wireless LAN communication will make use of the channel selected by the peer Wireless LAN equipment.

 In France, outdoors, Wireless LAN connections are only allowed on certain channels. For details, please refer to the **Regulations** booklet.



## *Troubleshooting Wireless LAN*

if you cannot use the Wireless LAN function, make sure the wireless switch is turned on before checking the following points.

### *The Wireless LAN Access Point and my computer cannot communicate*

- Check if the power of the Access Point is turned on.
- Check if the Access Point is displayed in the **View Available Networks** list.  
(Right-click the network icon in the taskbar displaying **Wireless Network Connection**. Click the **View Available Wireless Networks** link.)  
If the Access Point is displayed, select the Access Point and click the **Connect** button.  
If the Access Point is not displayed, click the **Refresh Network List** and create a network (See **Communicating with an Access Point (infrastructure)** (page 38)).
- Connection availability is affected by distance and obstructions. You may need to move your computer away from obstructions or nearer to any Access Point you may be using.

### *The data transfer speed is slow*

- The maximum communication speed can vary depending on the obstacles or the distance between the communication devices and the radio waves. Remove the obstacle or make the distance between the Access Point and your machine smaller.
- It is possible that your Access Point communicates at the same time with another Access Point. Read the manual of the Access Point.
- If several computers communicate with the same Access Point, the concentration may be too high. Wait a few minutes and try to access it again.
- If a Wireless LAN device using the IEEE 802.11g standard communicates with a device using the IEEE 802.11b standard, it is normal that the speed is reduced. Devices using the IEEE 802.11g standard are 5 times faster than the ones using the IEEE 802.11b standard.

### *I cannot access the Internet*

- Check the settings of the Access Point. See the manual of the Access Point.
- Check if your computer and the Access Point are communicating.
- Check your internet connection and check if your browser and e-mail client are correctly configured.

### *I cannot establish a Wireless LAN connection*

There are many steps to the wireless connection setup and each one should be followed carefully to ensure a smooth connection. Please read all the documentation on the wireless setup before calling VAIO-Link with a problem.

Please bear in mind the following:

- Make sure all the power to the equipment is turned on, including the computer's wireless switch and the access point, if applicable.
- When you turn on the wireless switch and the Access Point, communication between the VAIO and the Access Point is not automatic. To make sure you perform the steps in full, please refer to all the documentation. The available documentation depends on your model: check the online Help files in the software; separate **Wireless Connection** sheets (depending on your model); separate Wireless LAN accessory guides, and so on.
- Wireless LAN devices using the IEEE 802.11a standard cannot communicate with those using the IEEE 802.11b or IEEE 802.11g standard as they run on different frequencies.
- With a computer-to-computer setup, if you want to communicate between two or more computers, you need to configure all these computers the exact same way. This means you need to enter the same network name and the same network key on all computers as on the first computer you configure.

## Connecting peripheral devices

You can add functionality to your computer by using the various ports on your unit.

- ❑ Connecting a Universal Serial Bus (USB) device ([page 43](#))
- ❑ Connecting an i.LINK device ([page 44](#))
- ❑ Connecting a microphone ([page 45](#))
- ❑ Connecting to a network ([page 46](#))

To identify and locate the ports on your computer, please see the printed **Specifications** sheet.

Sony computer supplies, accessories and peripherals can be purchased from your local retailer or from the Sony website:

[www.sonystyle-europe.com](http://www.sonystyle-europe.com)

For more information about connection compatibility, go to the VAIO-Link website: [www.vaio-link.com](http://www.vaio-link.com)

## Connecting a Universal Serial Bus (USB) device

You can connect a USB device such as a scanner, a floppy disk drive or a printer, to your VAIO desktop.

To connect a USB device, simply plug in the USB cable of the device into one of the  ports on your system unit.

USB devices are hot plug and play devices. You do not need to shut down your computer prior to connecting these devices unless the manual supplied with the device states otherwise.

For some USB devices you need to install the software before you connect the device. Not following this procedure might cause the device not to work properly. For more information, check the manual provided with the USB device.

## Connecting a USB printer

To connect a printer, you can use either the printer port or a USB port, depending on the cable you use for your printer. Please see your printer's documentation for details on connection and installation.

Always check the printer manufacturer's website for the latest drivers for your operating system. Some printers do not function properly without updated drivers.

USB printer drivers should be automatically installed. Once you plug the printer's USB cable into one of the USB ports on your computer, the **Found New Hardware Wizard** will guide you through any setup procedure you need to follow.

If the printer is not automatically installed, you can try the following:

- 1 From the **Control Panel**, select **Printers and Other Hardware**, then **Printers and Faxes**.
- 2 Under **Printer Tasks**, click **Add a printer**.
- 3 Let the **Add Printer Wizard** guide you through the installation process.
- 4 Click **Finish**.  
The printer is now installed.

 This procedure applies for most, but not for all printers.

## Troubleshooting printing

If you have problems printing, check **Help and Support Center**; the documentation delivered with your printer; and the VAIO-Link website ([www.vaio-link.com](http://www.vaio-link.com)).

## Connecting an i.LINK device

Your VAIO computer includes a 4-pin i.LINK port  located on the side of the system unit. Use this port to connect an i.LINK device such as a digital video camera recorder, or to link up two VAIO computers so you can copy, delete or edit files.

- The i.LINK device will need its own power supply.
- You are strongly advised to use only Sony i.LINK cables, as using other brands may cause problems with the i.LINK devices.
- The i.LINK connection may vary, depending on the software applications, operating system, and compatible i.LINK devices. Not all products with an i.LINK connection may communicate with each other.
- Please refer to the documentation that came with your compatible i.LINK device and software for information on operating conditions and proper connection.

## Connecting a digital video camera recorder

To connect a digital video camera recorder, proceed as follows:

- 1 Plug one end of the i.LINK cable (not supplied) into the i.LINK port of the computer and the other end into the DV out port on your digital video camera recorder.  
On Sony digital video cameras, ports marked DV out, DV in/out or i.LINK are i.LINK-compatible.
- 2 Launch the **DVgate Plus** application (see the Help files within the software itself for more information).

 The Sony digital video camera recorder is an example; your digital video camera recorder may need to be connected differently. Some cameras can be connected via USB 2.0.

If your digital video camera recorder includes a Memory Stick slot, you can use it to copy images from the camera to your computer. To do so, simply copy images on the Memory Stick, and then insert it into the Memory Stick slot of your computer.

If the connected i.LINK device is not recognised, disconnect the i.LINK device, then connect it again.

## *Troubleshooting i.LINK devices*

If you have problems with your i.LINK device, check **Help and Support Center**, the documentation delivered with the device, and the VAIO-Link website ([www.vaio-link.com](http://www.vaio-link.com)).

## *Connecting a microphone*

Your VAIO desktop does not contain an internal microphone. If you need to use a sound input device, for example to chat on the Internet, you need to plug in an external microphone.

To connect an external microphone, plug the microphone cable into the microphone connector identified by the symbol .

 Make sure your microphone is designed for computer use.

## Connecting to a network

Your computer comes with a built-in Ethernet interface.

To connect to a network, proceed as follows:

- 1 Connect your 10BASE-T/100BASE-TX Ethernet cable (not supplied) to the Ethernet port  on the computer.  
If there is a sticker covering the Ethernet port, this is to remind customers in Germany not to insert an ISDN cable (see caution below).
  - 2 Go to **Start**, right-click **My Computer** and select **Properties**.
  - 3 Click the **Hardware** tab and select **Device Manager**.  
The **Device Manager** screen appears with the list of devices.
  - 4 Under **Network adapters**, right-click the name of the adapter and click **Properties**.
  - 5 On the **General** tab under **Device Usage**, select **Use this device (enable)**.
  - 6 Click **OK** to close the **Properties** window.  
The Ethernet connection is now enabled.
- !** Connect only 10BASE-T/100BASE-TX cables to the Ethernet port. Using other cables or a telephone cable may cause a malfunction, excessive heat or even fire in the port. If using this computer in Germany, please make sure you do not use an ISDN cable. It is physically very similar, but its higher voltage of 12V may destroy the motherboard inside the computer.

 For more information about connecting your VAIO desktop to the network, please consult the hardware troubleshooting section of the VAIO-Link website ([www.vaio-link.com](http://www.vaio-link.com)).

For help on connecting to a network, see your network administrator if you have one.

## Upgrading your VAIO computer

Sony recommends contacting your local dealer for upgrade or maintenance of your new computer. Your local dealer has knowledge of this specialised personal computer and familiar with the safety practices and regulatory compliance required for using and modifying electronic equipment.

The upgrading procedures described in this section assume that you are familiar with the general terminology associated with personal computers and with the safety practices and regulatory compliance required for using and modifying electronic equipment.

Disconnect the computer from its power source and from telecommunication links, networks, or modems before you open the unit or follow any procedures described in this section.

Your computer may not be equipped with all of the hardware features mentioned in this section. The interior configuration of your system may vary from the illustrations, depending on the computer purchased.

To view the hardware configuration for your computer, see the printed **Specifications** sheet.

Your VAIO desktop and memory modules use high precision components and electronic connector technology. To avoid the invalidation of your guarantee by mishandling, it is recommended that:

- You contact your local Sony dealer to install any new internal hardware components.
  - You do not install memory modules yourself, if you are not familiar with upgrading memory on a computer.
  - Please contact VAIO-Link if you need assistance.
- ! Failure to disconnect your computer from its power source may result in personal injury or equipment damage.
- ! Electrostatic discharge (ESD) can damage disk drives, add-on cards, and other components. Follow the procedures here only at an ESD workstation. Otherwise, do not work on a carpeted area and do not handle materials that produce or hold static electricity, such as cellophane wrappers. Ground yourself by keeping constant contact with an unpainted metal part of the unit while carrying out any of these procedures.



## Upgrading memory

In the future, you may want to upgrade the memory installed on your VAIO by replacing / adding memory modules. However, we recommend that you do not install them yourself unless you are familiar with upgrading memory on a computer.

For memory upgrades, use only those modules mentioned in the printed **Specifications** table.

Be careful when adding memory yourself. Mistakes on installation or removal of the memory module may cause a malfunction.

Electrostatic discharge can damage electronic components. Before touching a memory expansion board, remember the following:

- ❑ Handle the memory module gently.
  - ❑ The procedures described in this document assume familiarity with the general terminology associated with personal computers and with the safety practices and regulatory compliance required for using and modifying electronic equipment.
  - ❑ Disconnect the system from its power source and from any telecommunication links, networks, or modems before you open the system. Failure to do so may result in personal injury or equipment damage.
  - ❑ Do not open the memory module package until you are ready to install the module. The package protects the module from ESD.
  - ❑ Use the special bag delivered with the memory module, or wrap the module in aluminium foil to protect it from electrostatic discharge.
-  Do not place the memory module in places subject to: Heat sources such as radiators or air ducts, direct sunlight, excessive dust, mechanical vibration or shock, strong magnets or speakers that are not magnetically shielded, ambient temperature of more than +35°C or less than +5°C, or high humidity.
- !** Introducing any liquids or any foreign substances or objects into the memory slots, or other internal components of the computer, will result in damage to the computer and any repairs will be out of warranty.

## Viewing the amount of memory

To view the amount of memory, proceed as follows:

- 1 Turn on the computer.
- 2 Click the **Start** button, point to **All Programs, Security & Utilities**, then **VAIO System Information**, and click **VAIO System Information** again.  
You can view the amount of installed memory here.

## Adding / replacing a memory module

If you are not familiar with upgrading memory on a computer, we highly recommend that you contact your dealer.

To add or change a memory module, proceed as follows:

- 1 Shut down the computer, unplug it, and remove any peripheral devices.
- 2 Wait for the computer to cool down.  
The inside of the main unit becomes very hot during operation. Wait for about one hour for the computer to cool down before opening the unit.
- 3 With the main unit's back panel facing you, slide the back panel up until you cannot go any further.  
As you slide the back panel up, a 'button' appears (middle of the back of your computer).
- 4 When you push this button, you can remove the back panel completely.
- 5 Set the back panel aside.  
A metal panel, the 'memory cover', appears.
- 6 Remove the 2 screws with a + screwdriver and remove the memory cover.
- 7 To remove an existing memory module, release the end latches and gently lift out the module, as shown (may vary from actual configuration):

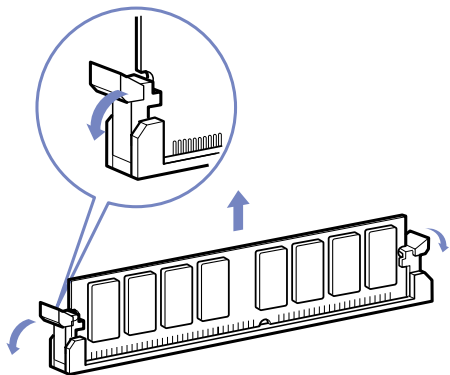

- 8 To insert a new memory module, remove it from its anti-static package, handling it only by the edges.
- 9 Locate the notch on the bottom edge of the memory module.
- 10 Align the memory module over the slot, making sure the module is facing the correct way.
- 11 Press evenly against the memory module's upper corners. The end latches snap into position automatically, as shown.

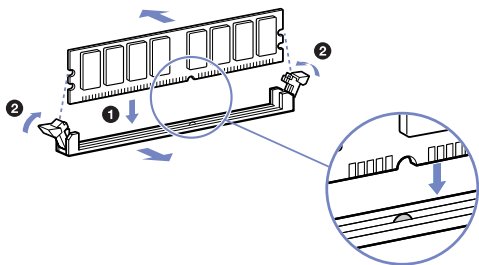

12 Align the tabs on the side cover to the rim of the unit and press the side cover firmly against the unit until it snaps into place.

13 Put the memory cover and the back panel back into place.

 The illustrations here may vary from the actual configuration of your VAIO.

! Use only the memory modules specified on the printed **Specifications** sheet.

! To avoid damaging a memory module or the memory module slot, move the side latches slightly outward to relieve pressure. The module is properly inserted when the side latches click into place.

## Getting help

This section describes how to get help and support if something goes wrong with your computer. Sony offers you many support options for your computer.

### *Sony documentation*

Please see the section **Documentation pack (page 8)** for details on the printed and online documentation delivered with your computer, as well as further sources of reference.

### *Other sources of information*

- Use the search functionality in **Help and Support Center**.
- Go to the **online help files** that accompany your software for instructions on using the software.
- VAIO-Link website:** If you have any problems with your computer, you can access the VAIO-Link website for troubleshooting. Go to: [www.vaio-link.com](http://www.vaio-link.com)
- e-Support:** This interactive part of our website [www.vaio-link.com](http://www.vaio-link.com) allows you to get in contact with our dedicated support team over the internet. Using a personalised account, you can log your technical queries with ease.
- Visit the other Sony websites:
  - [www.club-vaio.com](http://www.club-vaio.com) if you want to know more about VAIO and become part of the growing VAIO community.
  - [www.sonystyle-europe.com](http://www.sonystyle-europe.com) for online purchases.
  - [www.sony.net](http://www.sony.net) for other Sony products.

 You need to set up an Internet connection before you can access the online features described here.

## *e-Support*

### *What is e-Support?*

You have searched our user guides and website ([www.vaio-link.com](http://www.vaio-link.com)) but have not found an answer to your question/issue? e-Support is the ideal solution for you!

Our e-Support Web Portal is an interactive website on which you can submit any technical query you may have regarding your VAIO and receive answers from our dedicated support team.

Every submitted query will result in a unique 'case number' to ensure smooth communication between yourself and the e-Support Team.

### *Who can use e-Support?*

All registered VAIO customers are entitled to unlimited access to the VAIO-Link e-Support Web Portal.

### *How can I access the e-Support portal?*

When you register your VAIO computer online at Club-VAIO ([www.club-vaio.com](http://www.club-vaio.com)), you will automatically receive an email with the link to the e-Support Web Portal, your Customer ID and some basic explanation a few hours later.

All you need to do is activate your account by clicking on the provided link in the email.

You are now ready to create your first case!

You can access the e-Support Web Portal from any computer with an active Internet connection.

A complete help file is available on the e-Support Web Portal to help you use our e-Support Service.

### *Can I submit questions in my native language?*

Since you are interacting with our e-Support Team through a portal, which connects you directly to our central database, e-Support will only accept and deal with queries submitted in English.

### *Can I submit my questions at any time?*

Yes, you can submit your questions 24/7, but please keep in mind that our e-Support Team can only treat your queries from Monday till Friday between 8am and 6pm.

### *Is there a cost involved for using e-Support?*

No, this is a complete free of charge service offered to all registered VAIO customers!

### *How do I know when the e-Support Team has handled my query/case?*

As soon as your case has been dealt with by our e-Support Team, you will receive an email, notifying you that your case has been updated.

## *Precautions*

This section describes safety guidelines and precautions to help you protect your computer from potential damage.

Please contact VAIO-Link if you need assistance.

- ❑ On handling the hard disk ([page 56](#))
- ❑ On using the power source ([page 57](#))
- ❑ On handling your computer ([page 58](#))
- ❑ On handling the LCD screen ([page 59](#))
- ❑ On handling discs ([page 60](#))
- ❑ On handling Memory Sticks ([page 61](#))



## *On handling the hard disk*

The hard disk has a high storage density and reads or writes data in a short time. However, it can be easily damaged by mechanical vibration, shock or dust.

Although the hard disk has the internal safety device to prevent losing data due to mechanical vibration, shock or dust, you should be careful when handling your computer. Always make a backup of your important data.

To avoid damaging your hard disk:

- Do not subject your computer to sudden movements.
- Keep the computer away from magnets.
- Do not place your computer in a location subject to mechanical vibration or in an unstable position.
- Do not move your computer while the power is on.
- Do not turn off the power or restart the computer while reading or writing data to disk.
- Do not use your computer in a place subject to extreme changes in temperature.

 If the hard disk is damaged, the data cannot be restored.

## *On using the power source*

- See the printed **Specifications** sheet to check the power operation of your VAIO.
- Do not share the AC outlet with other high power-consuming equipment, such as a photocopier or shredder.
- You can purchase a power strip with a surge protector. This device prevents damage to your computer caused by sudden power surges, in an electrical storm, for example.
- Do not place heavy objects on the power cord.
- To disconnect the cord, pull it out by the plug. Never pull the cord itself.
- Unplug your computer from the wall outlet if you are planning to not use the computer for a long time.
- Make sure that the socket outlet is easily accessible.

## *On handling your computer*

- Clean the unit with a soft cloth, which is either dry or lightly moistened with a mild detergent solution. Do not use any type of abrasive pad, scouring powder, or solvent such as alcohol or benzene, as these may damage the finish of your computer.
- Should you drop a solid object or any liquid onto the computer, shut down your computer and then unplug it. You may want to have the computer checked by qualified personnel before operating it again.
- Do not drop the computer or place heavy objects on top of the computer.
- Do not place your computer in a location subject to:
  - Heat sources, such as radiators or air ducts
  - Direct sunlight
  - Excessive dust
  - Moisture or rain
  - Mechanical vibration or shock
  - Strong magnets or speakers that are not magnetically shielded
  - An ambient temperature of more than 35°C or less than 5°C
  - High humidity.
- Do not place electronic equipment near your computer. The electromagnetic field of your computer may cause a malfunction.
- Provide adequate air circulation to prevent internal heat from building up. Do not place your computer on porous surfaces such as rugs or blankets, or near material such as curtains or draperies that may block its ventilation slots.
- The computer uses high-frequency radio signals and may cause interference to radio or TV reception. Should this occur, relocate the computer a suitable distance away from the set.
- Use only specified peripheral equipment and interface cables; otherwise, problems may occur.
- Do not use cut or damaged connection cables.

- ❑ If the computer is brought directly from a cold location to a warm one, moisture may condense inside your computer. In this case, allow at least one hour before turning on your computer. If any problems occur, unplug your computer and contact VAIO-Link.
- ❑ Make sure you disconnect the power cord before cleaning the computer.
- ❑ As you may lose important data once your computer is damaged, you should back up your data regularly. You can restore most of the original application programmes from a Recovery Disk (read the **Recovery Guide** for details).

### *On handling the LCD screen*

- ❑ Do not leave the LCD facing the sun as it can damage the LCD. Be careful when using the computer near a window.
- ❑ Do not scratch the LCD or exert pressure on it. This could cause malfunction.
- ❑ Using the computer in low temperature conditions may produce a residual image on the screen. This is not a malfunction. When the computer returns to normal temperature, the screen returns to normal.
- ❑ A residual image may appear on the screen if the same image is displayed for a lengthy period of time. The residual image disappears in a while. You can use a screensaver to prevent residual images.
- ❑ The screen becomes warm during operation. This is normal and does not indicate a malfunction.
- ❑ The LCD is manufactured using high-precision technology. You may, however, see tiny black points and/or bright points (red, blue, or green) that continuously appear on the LCD. This is a normal result of the manufacturing process and does not indicate a malfunction.
- ❑ Avoid rubbing the LCD screen, as this can damage the screen. Use a soft, dry cloth to wipe the LCD screen.

## On handling discs

- ❑ Do not touch the surface of the disc.
- ❑ Do not drop or bend the disc.
- ❑ Fingerprints and dust on the surface of a disc may cause reading errors. Always hold the disc by its edge and central hole, as shown.

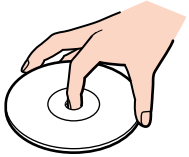

- ❑ Proper care of the disc is essential to its continuous reliability. Do not use solvents such as benzene, thinning agents, commercially available cleaners or anti-static spray, as they may cause damage to the disc.
- ❑ For normal cleaning, hold the disc by its edge and use a soft cloth to wipe the surface from the centre out.
- ❑ If the disc is badly soiled, moisten a soft cloth with water, wring it out well, and use it to wipe the surface of the disc from the centre out. Wipe off any remaining moisture with a dry soft cloth.
- ❑ Never put labels on discs. This will affect the use of the disc irreparably.

## *On handling Memory Sticks*

- Do not touch the Memory Stick connector with your finger or metallic objects.
- Use only the label supplied with the Memory Stick as a label.
- Do not bend, drop, or apply heavy shock to the Memory Stick.
- Do not disassemble or modify Memory Sticks.
- Do not let Memory Sticks get wet.
- Do not use or store Memory Sticks in a location subject to:
  - Extremely high temperatures, such as in a car parked in the sun
  - Direct sunlight
  - High humidity or
  - Corrosive substances.
- Use the storage case supplied with the Memory Stick.

## Trademarks

Sony, Battery Checker, Click to DVD, DVgate Plus, HotKey Utility, Keyboard Utility, Memory Stick Formatter, PictureGear Studio, Prepare your VAIO, SonicStage, SonicStage Mastering Studio, VAIO Control Center, VAIO Edit Components, VAIO Launcher, VAIO Media, VAIO Power Management, VAIO Power Management Viewer, Image Converter, VAIO Zone, VAIO Update, Memory Stick, the Memory Stick logo, VAIO and the VAIO logo are trademarks of Sony Corporation.

Intel, Pentium, and Intel SpeedStep are trademarks or registered trademarks of Intel Corporation.

Microsoft, Internet Explorer, Windows Movie Maker, Windows Media Player, Windows XP Professional, Windows XP Home Edition, Microsoft Works 8.0, Microsoft Office 2003 SBE Trial version and the Windows logo are trademarks or registered trademarks of Microsoft Corporation in the U.S. and other countries.

i.LINK is a trademark of Sony used only to designate that a product contains an IEEE1394 connection.

Adobe, Adobe Acrobat Elements, Adobe Acrobat Professional, Adobe Photoshop Album, Adobe Reader, Adobe Premiere Standard and Adobe Photoshop Elements are trademarks of Adobe Systems Incorporated.

MoodLogic is a trademark of MoodLogic, Inc.

Norton Internet Security 2005 and Norton Password Manager 2004 are trademarks or registered trademarks of Symantec Corporation.

RecordNow! is a trademark of Sonic.

WinDVD for VAIO is a trademark of InterVideo, Inc.

Sun Java VM is a trademark of Sun Microsystems, Inc.

Google Toolbar is a trademark of Google.

Yahoo! Messenger is a trademark of Yahoo!.

SafeGuard PrivateDisk is a trademark of Utimaco Software.

My Club VAIO uses Macromedia Flash™ Player software by Macromedia, Inc., Copyright © 1995-2003 Macromedia, Inc. All rights reserved. Macromedia and Flash are trademarks of Macromedia, Inc.

The Bluetooth word mark and logos are owned by the Bluetooth SIG, Inc. and any use of such marks by Sony Corporation is under license. Other trademarks and trade names are those of their respective owners.

All other names of systems, products and services are trademarks of their respective owners. In the manual, the ™ or ® marks are not specified.

Specifications are subject to change without notice. All other trademarks are trademarks of their respective owners.

**Please see the printed Specifications sheet to see what software is available for your model.**