

**SONY**<sup>®</sup>

4-187-068-11(1)

# AUDIO SYSTEM COMPONENT

Operating Instructions  
WHG-SLK2i  
WHG-SLK1i



## WARNING

### To reduce the risk of fire or electric shock, do not expose this apparatus to rain or moisture.

To reduce the risk of fire, do not cover the ventilation opening of the apparatus with newspapers, tablecloths, curtains, etc. Do not place the naked flame sources such as lighted candles on the apparatus.

To reduce the risk of fire or electric shock, do not expose this apparatus to dripping or splashing, and do not place objects filled with liquids, such as vases, on the apparatus.

As the main plug is used to disconnect the unit from the mains, connect the unit to an easily accessible AC outlet. Should you notice an abnormality in the unit, disconnect the main plug from the AC outlet immediately.

Do not install the appliance in a confined space, such as a bookcase or built-in cabinet.

Do not expose batteries or apparatus with battery-installed to excessive heat such as sunshine, fire or the like.

The unit is not disconnected from the mains as long as it is connected to the AC outlet, even if the unit itself has been turned off.

Excessive sound pressure from earphones and headphones can cause hearing loss.

### CAUTION

The use of optical instruments with this product will increase eye hazard.

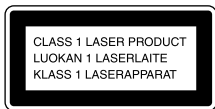

This appliance is classified as a CLASS 1 LASER product. This marking is located on the rear exterior.

- The dating code and the nameplate are located on the bottom exterior.
- These following indications are located on the bottom exterior.



### Notice for customers in the U.S.A. and Canada



This symbol is intended to alert the user to the presence of uninsulated “dangerous voltage” within the product’s enclosure that may be of sufficient magnitude to constitute a risk of electric shock to persons.



This symbol is intended to alert the user to the presence of important operating and maintenance (servicing) instructions in the literature accompanying the appliance.

### Owner's Record

The model and serial numbers are located on the bottom of the unit. Record these numbers in the space provided below. Refer to them whenever you call upon your Sony dealer regarding this product.

Model No. \_\_\_\_\_

Serial No. \_\_\_\_\_

## Important Safety Instructions

- 1) Read these instructions.
- 2) Keep these instructions.
- 3) Heed all warnings.
- 4) Follow all instructions.
- 5) Do not use this apparatus near water.
- 6) Clean only with dry cloth.
- 7) Do not block any ventilation openings. Install in accordance with the manufacturer's instructions.
- 8) Do not install near any heat sources such as radiators, heat registers, stoves, or other apparatus (including amplifiers) that produce heat.
- 9) Do not defeat the safety purpose of the polarized or grounding-type plug. A polarized plug has two blades with one wider than the other. A grounding type plug has two blades and a third grounding prong. The wide blade or the third prong are provided for your safety. If the provided plug does not fit into your outlet, consult an electrician for replacement of the obsolete outlet.
- 10) Protect the power cord from being walked on or pinched particularly at plugs, convenience receptacles, and the point where they exit from the apparatus.
- 11) Only use attachments/accessories specified by the manufacturer.
- 12) Use only with the cart, stand, tripod, bracket, or table specified by the manufacturer, or sold with the apparatus. When a cart is used, use caution when moving the cart/apparatus combination to avoid injury from tip-over.
- 13) Unplug this apparatus during lightning storms or when unused for long periods of time.
- 14) Refer all servicing to qualified service personnel. Servicing is required when the apparatus has been damaged in any way, such as power-supply cord or plug is damaged, liquid has been spilled or objects have fallen into the apparatus, the apparatus has been exposed to rain or moisture, does not operate normally, or has been dropped.



**The following FCC statement applies only to the version of this model manufactured for sale in the U.S.A. Other versions may not comply with FCC technical regulations.**

**NOTE:**

This equipment has been tested and found to comply with the limits for a Class B digital device, pursuant to Part 15 of the FCC Rules. These limits are designed to provide reasonable protection against harmful interference in a residential installation. This equipment generates, uses and can radiate radio frequency energy and, if not installed and used in accordance with the instructions, may cause harmful interference to radio communications. However, there is no guarantee that interference will not occur in a particular installation. If this equipment does cause harmful interference to radio or television reception, which can be determined by turning the equipment off and on, the user is encouraged to try to correct the interference by one or more of the following measures:

- Reorient or relocate the receiving antenna.
- Increase the separation between the equipment and receiver.
- Connect the equipment into an outlet on a circuit different from that to which the receiver is connected.
- Consult the dealer or an experienced radio/TV technician for help.

**CAUTION**

You are cautioned that any changes or modifications not expressly approved in this manual could void your authority to operate this equipment.

**Notice for customers: the following information is only applicable to equipment sold in countries applying EU directives.**

The manufacturer of this product is Sony Corporation, 1-7-1 Konan Minato-ku, Tokyo, 108-0075 Japan. The Authorized Representative for EMC and product safety is Sony Deutschland GmbH, Hedelfinger Strasse 61, 70327 Stuttgart, Germany. For any service or guarantee matters, please refer to the addresses given in separate service or guarantee documents.



**Disposal of Old Electrical & Electronic Equipment (Applicable in the European Union and other European countries with separate collection systems)**

This symbol on the product or on its packaging indicates that this product shall not be treated as household waste. Instead it shall be handed over to the applicable collection point for the recycling of electrical and electronic equipment. By ensuring this product is disposed of correctly, you will help prevent potential negative consequences for the environment and human health, which could otherwise be caused by inappropriate waste handling of this product. The recycling of materials will help to conserve natural resources. For more detailed information about recycling of this product, please contact your local Civic Office, your household waste disposal service or the shop where you purchased the product.  
Applicable accessories: Remote commander



**Disposal of waste batteries (applicable in the European Union and other European countries with separate collection systems)**

This symbol on the battery or on the packaging indicates that the battery provided with this product shall not be treated as household waste. On certain batteries this symbol might be used in combination with a chemical symbol. The chemical symbols for mercury (Hg) or lead (Pb) are added if the battery contains more than 0.0005% mercury or 0.004% lead. By ensuring these batteries are disposed of correctly, you will help prevent potentially negative consequences for the environment and human health which could otherwise be caused by inappropriate waste handling of the battery. The recycling of the materials will help to conserve natural resources.

In case of products that for safety, performance or data integrity reasons require a permanent connection with an incorporated battery, this battery should be replaced by qualified service staff only. To ensure that the battery will be treated properly, hand over the product at end-of-life to the applicable collection point for the recycling of electrical and electronic equipment.

For all other batteries, please view the section on how to remove the battery from the product safely. Hand the battery over to the applicable collection point for the recycling of waste batteries.

For more detailed information about recycling of this product or battery, please contact your local Civic Office, your household waste disposal service or the shop where you purchased the product.

---

## About product registration (for U.S. customers only)

Proper registration will enable us to send you periodic mailings about new products and other important announcements. Registering your product will also allow us to contact you in the unlikely event that it will need adjustment or modification. Please take the time to register your new product at our website:

<http://www.sony.com/productregistration>

You will find the product serial number on the main unit and the carton box.

If you have any operational questions regarding your new purchase, please contact your retailer. For the location of a Sony dealer in your area, or for any other questions, please call 1-800-222-SONY(7669).

---

## About this manual

- The instructions in this manual are for models WHG-SLK2i and WHG-SLK1i. Each model consists of the following components.

### WHG-SLK2i

Main unit:

HCD-SLK2i

Speaker system:

SS-SLK2i (Front speakers)

### WHG-SLK1i

Main unit:

HCD-SLK1i

Speaker system:

SS-SLK1i (Front speakers)

- Icons, such as **DVD-V**, listed at the top of each explanation indicate what kind of media can be used with the function being explained.
- The Control Menu items may be different depending on the disc.
- The Control Menu items may vary depending on the area.
- The “SETUP” menu items may be different depending on the area.
- The order of the displayed items on the Control Menu or the “SETUP” menu may be different from the actual display.
- DivX and MPEG4 video files on a disc cannot be played back on the North American model.
- The playable video format for files stored on a USB device, “Memory Stick” media or SD memory card is MPEG4/MPEG2/MPEG1/Motion JPEG.
- You can view any video contents stored in the connected iPod.

# Table of Contents

About product registration (for U.S. customers only).....	6
About this manual .....	6
Playable discs .....	9
Guide to parts and controls .....	12
Basic operations .....	18

## Getting Started

Hooking up the system securely.....	24
Hooking up the TV.....	27
Performing the basic adjustments .....	28
Setting the clock .....	30

## Disc

Playing a disc.....	32
Using play mode .....	46
Adjusting the delay between the picture and sound ("A/V SYNC") ...	50
Restricting playback of the disc (PARENTAL CONTROL).....	51
Using the "SETUP" menu .....	53

## Tuner

Listening to the radio .....	59
------------------------------	----

## iPod

Playing the iPod.....	61
-----------------------	----

## USB Device/Memory Card

Before using the USB device and the memory card with this system .....	65
Playing a file on the USB device or memory card .....	67

## Sound Adjustment

Adjusting the sound .....	72
---------------------------	----

## Other Operations















Enjoying simultaneous playback .....	75
Using the timers .....	76
Changing the display .....	78
Using the calendar and clock functions .....	81
Changing other settings.....	82
Hooking up optional components.....	83



## Additional Information

Troubleshooting.....	85
Precautions.....	100
Specifications .....	104
Compatible devices with this system.....	110
Guide to the Control Menu display (CD/DVD function only).....	113
Language code list .....	117
Glossary .....	119
Index.....	122
License and trademark notice....	124



# Playable discs

Type	Disc logo	Characteristics	Icon
DVD VIDEO	     	<ul style="list-style-type: none"><li>• DVD VIDEO</li><li>• DVD-R/DVD-RW in DVD VIDEO format or video mode</li><li>• DVD+R/DVD+RW in DVD VIDEO format</li></ul>	
VR (Video Recording) mode	 	<ul style="list-style-type: none"><li>• DVD-R/DVD-RW in VR (Video Recording) mode (except for DVD-R DL)</li></ul>	
VIDEO CD		<ul style="list-style-type: none"><li>• VIDEO CD (Ver. 1.1 and 2.0 discs)</li><li>• Super VCD</li><li>• CD-R/CD-RW/CD-ROM in video CD format or Super VCD format</li></ul>	
CD		<ul style="list-style-type: none"><li>• Audio CD</li><li>• CD-R/CD-RW in audio CD format</li></ul>	

Type	Disc logo	Characteristics	Icon
DATA CD		<ul style="list-style-type: none"> <li>CD-R/CD-RW/CD-ROM in DATA CD format, containing MP3 files, JPEG image files, DivX video files and MPEG4 video files, and conforming to ISO 9660 Level 1/Level 2, or Joliet (expansion format)</li> </ul>	
DATA DVD		<ul style="list-style-type: none"> <li>DVD-ROM/DVD-R/DVD-RW/ DVD+R/DVD+RW in DATA DVD format, containing MP3 files, JPEG image files, DivX video files and MPEG4 video files, and conforming to UDF (Universal Disk Format)</li> </ul>	

- MP3 files: MP3 (MPEG 1 Audio Layer 3) is a standard format defined by ISO (International Organization for Standardization)/MPEG (Moving Picture Experts Group) which compresses audio data. MP3 files must be in MPEG 1 Audio Layer 3 format.
- JPEG image files: JPEG image files must conform to the DCF image file format (DCF “Design rule for Camera File System”: Image standards for digital cameras regulated by “Japan Electronics and Information Technology Industries Association” (JEITA)).
- DivX video files: DivX video files must be recorded in DivX format with the extension “.avi” or “.divx”. Please be aware that playback of DivX video files is not supported on the North American model.
- MPEG4 video files: MPEG4 video files must be recorded in MP4 file format with the extension “.mp4” or “.m4v”. Please be aware that playback of MPEG4 video files is not supported on the North American model.
- ISO 9660: A logical format of files and folders on CD-ROMs, defined by ISO.

## Discs that cannot be played

- CD-ROMs recorded in PHOTO CD format
- DATA CDs recorded in MP3 PRO format
- Data part of CD-Extras<sup>1)</sup>
- Data part of Mixed CDs<sup>2)</sup>
- Super Audio CDs
- DVD Audio discs
- DVD-RAMs
- CPRM compatible DVD-R/RW recorded in Copy-once programs<sup>3)</sup>
- Discs of non-standard shape (for example, heart, square, star)
- Discs that have adhesive tape, paper, or sticker attached to them
- Rental or used discs with attached seals where the glue extends beyond the seal
- Discs that have labels printed using ink that feels tacky when touched

<sup>1)</sup> CD-Extra: This format records audio (AUDIO CD data) on the tracks in session 1 and data on the tracks in session 2.

<sup>2)</sup> Mixed CD: This format records data on the first track and audio (AUDIO CD data) on the second and subsequent tracks of a session.

<sup>3)</sup> CPRM: "Content Protection for Recordable Media" is a coding technology that protects copyright for Copy-Once programs.

See "Region code of DVD VIDEOS you can play back on this system" and "Notes on discs" (page 100) regarding the region code and notes on discs.

# Guide to parts and controls

This manual mainly explains operations using the remote, but the same operations can also be performed using the buttons on the unit having the same or similar names.

## Main unit

### Top

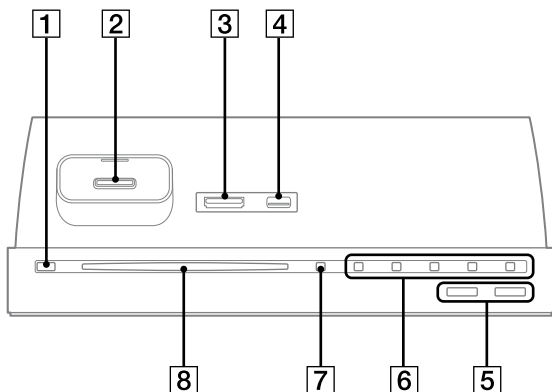

### Front

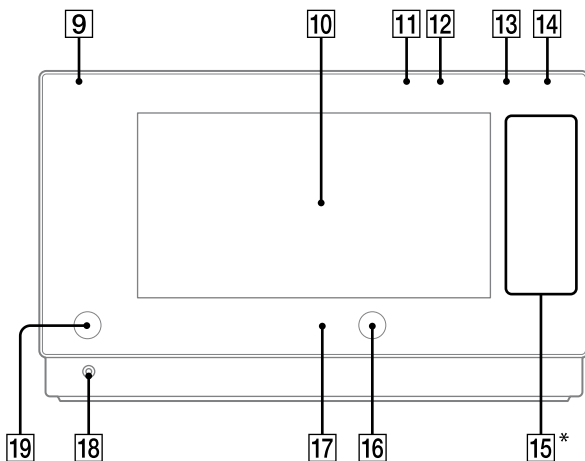

\* Touch sensitive buttons

**1****I/⏻** (on/standby) button

Press to turn on or off the system.

**2**

iPod Dock (page 26, 61)

**3**

Multi memory card slot

Insert a “Memory Stick” media or an SD memory card to play back audio files, video files, or image files.

**4****⏻** (USB) port

Connect an optional USB device.

**5**

VOL +/- button

Press to adjust the volume.

**6****▶** (play) button

Press to start playback.

**⏸** (pause) button

Press to pause playback.

**■** (stop) button

Press to stop playback.

+/- (tuning) button

Press to tune in the desired station.

**⏮/⏭** (go backward/go forward) button

Press to select a track, file or chapter.

**7****⏏** (eject) button

Press to eject a disc.

**8**

Disc slot

**9**

ON/STANDBY indicator

Lights up in green when the system is turned on and lights up in red when the system is in standby mode.

**10**

LCD screen

Continued 

**11**

### **PLAY indicator**

Lights up in green during playback and turns off when playback is stopped.

**12**

### **PAUSE indicator**

Lights up in amber when playback is in pause status.

**13**

### **TIMER indicator**

Lights up in amber when Play Timer is set.

**14**

### **AUTO STANDBY indicator**

Lights up in amber when the system is in automatic standby mode.

You can turn on or off the automatic standby function. For details, see page 97.

**15\***

### **HOME button (page 18)**

Press to display the home menu.

### **OPTIONS button (page 19)**

Press to bring up the Options menu to change the current setting while using any of the functions.

### **RETURN/iPod MENU button (page 18, 19, 42, 62, 64, 69)**

Press to return to the previous menu, previous screen or previous status.  
Press to display the iPod menu for operations when using the iPod function.

### **ENTER button**

Press to enter the current operation or setting.

**16**

### **Ambient light sensor**

**17**

### **Sony logo (page 82)**

You can change the brightness of Sony logo on the unit. For details, see page 82.

**18**

### **🎧 (headphones) jack**

**19**

### **Remote sensor**

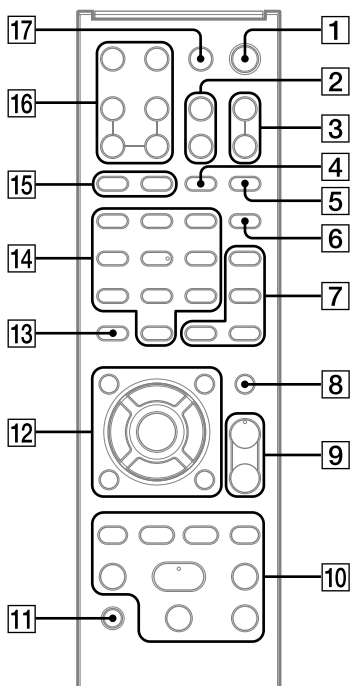
**Remote**

**1**  
**I/⏻ (on/standby) button**  
 Press to turn on or off the system.

**2**  
**DISPLAY button (page 20, 23)**  
 Press to switch back to the CD music playback screen from the Control Menu (CD/DVD function only), or to turn on or off the status bar when viewing DVD VIDEOS, video files or slideshows.

**TIME/TEXT button (page 78, 79)**  
 Press to change the information on the display.

**3**  
**📁 +/- button (page 33, 69)**  
 Press to select a folder.

**4**  
**TUNER/BAND button**  
 Press to select the tuner function. Press to switch between FM and AM bands.

**5**  
**PICTURE NAVI button (page 41)**  
 Press to display the thumbnail pictures from the original image files stored on a DATA CD or DATA DVD when using the CD/DVD function.

**6**  
**AUDIO button (page 36, 37)**  
 Press to select the audio format or mode during playback.

Continued

**7**

**SUBTITLE/D.TUNING button**  
(page 34, 59)

Press to switch the language of the subtitles (e.g., DVD VIDEO).  
Press to switch to direct tuning mode.

**ANGLE button (page 34)**

Press to change the angle (DVD VIDEO with multi-angles only).

**DVD TOP MENU/DVD MENU button (page 33, 36, 41)**

Press to display the DVD title on the screen.  
Press to select the DVD menu items such as the languages and subtitles.  
Press to turn on or off the menu items on the screen.

**8**

**MUTING button**

Press to mute the sound.

**9**

**VOLUME +/-<sup>2)</sup> button**

Press to adjust the volume.

**10**

**+/- (tuning) button**

Press to tune in the desired station.

**⏮/⏭ (go backward/go forward) button**

Press to select a track, file or chapter.

**⏪/⏩ (rewind/fast forward) button**

Press to find a point in a track, file or chapter.

**◀◀ SLOW/SLOW ▶▶ button**

Press to watch slow-motion play.

**⏮ STEP ⏭ button (page 34)**

Press to play one frame at a time when playback is paused.

**◀◀ REPLAY/ADVANCE ▶▶ button (page 34)**

Press to replay the previous scene during playback.  
Press to advance the current scene during playback.

**▶<sup>2)</sup> button**

Press to start playback.

**⏸ (pause) button**

Press to pause playback.

**■ (stop) button**

Press to stop playback.

**11**

**SOUND FIELD button (page 72)**

Press to select the sound field for surround sound.



**12****HOME button (page 18)**

Press to display the home menu.

**⏪ RETURN/iPod MENU button (page 18, 19, 42, 62, 64, 69)**

Press to return to the previous menu, previous screen or previous status.  
Press to display the iPod menu for operations when using the iPod function.

**⬆/⬇/⬅/➡ button**

Press to select the menu items.

**ENTER button**

Press to enter the current operation or setting.

**⏻ DISPLAY button (page 22, 23, 113)**

Press to turn on or off the Control Menu on the screen.  
The Control Menu can be displayed only when using the CD/DVD function.

**OPTIONS button (page 19)**

Press to bring up the Options menu to change the current setting while using any of the functions.

**13****CLEAR button (page 40, 43, 47)**

Press to return to the original or previous status.  
Press to delete a pre-programmed track.

**14****Numeric buttons<sup>2)</sup>**

Press to select a track, chapter or file with its item number.  
Press to enter numbers or values.

**15****GROOVE button (page 72)**

Press to reinforce the bass.

**EQ button (page 72)**

Press to select the preset sound effect.

**16****TV INPUT<sup>1)</sup> button**

Press to switch the input sources.

**TV VOL +/—<sup>1)</sup> button**

Press to adjust the TV volume.

**TV I/⏻ (on/standby)<sup>1)</sup> button**

Press to turn on or off the TV.

**TV CH +/—<sup>1)</sup> button**

Press to change the TV channels.

**17****SLEEP button (page 76)**

Press to set the Sleep Timer.

<sup>1)</sup> This button is used to operate a Sony TV. For details, see "Operating a Sony TV" (page 28).

<sup>2)</sup> The numeric button 5, VOLUME + and ► buttons on the remote have a tactile dot. Use the tactile dot as a reference when operating the system.

# Basic operations

## Operations with the home menu

### ■ Home menu

The home menu is the basic user interface of this system to select a function, to access the “Settings” menu, and to allow you to use the system as a calendar or a clock. The system turns on with this home screen. However, you can display the home menu at any time by pressing HOME button.

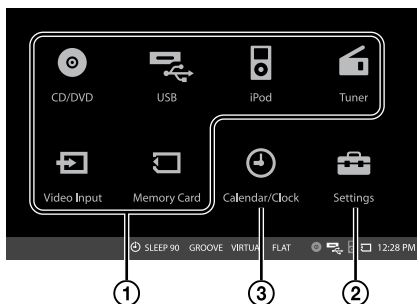

- ① Functions
- ② Settings: See below.
- ③ Calendar/Clock: Displays a calendar or a clock. See “Using the calendar and clock functions” (page 81).

#### <Basic operations>

- $\blacktriangleleft/\blacktriangleright/\blacktriangleleft/\blacktriangleright$ : Moves the focus to an item.
- ENTER: Enters the focused item to use the function.

### ■ Settings menu

The “Settings” menu is composed of 4 pages and you can set various system settings.

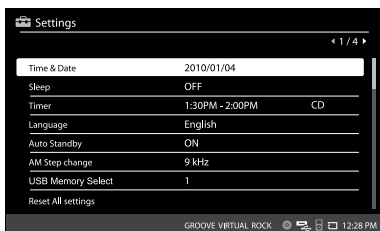

#### <Basic operations>

- $\blacktriangleleft/\blacktriangleright$ : Advances a page to next or previous page.
- ENTER: Enters the highlight to select the menu.
- $\blacktriangleleft/\blacktriangleright$  RETURN: Cancels the current operation.

\* “AM Step change” is not displayed on European and Saudi Arabian models.

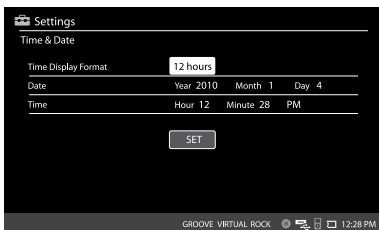

### <Operations in setting boxes>

- **↑/↓/←/→**: Moves the focus to a setting box. In each setting box, you can select a setting by pressing **↑/↓**.
- **ENTER**: Enters the focus to change the setting, or enters the selection or setting you made.
- **RETURN**: Cancels the current operation or returns to unfocused status.

## ■ Options menu

You can bring up the Options menu at any time by pressing **OPTIONS** button while using a function. Displayed menu items are related to the function you select, and vary with each function of this system.

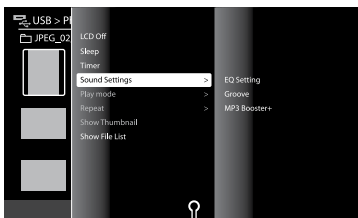

Options menu

### <Basic operations>

- **OPTIONS**: Brings up the Options menu while using a function.
- **↑/↓**: Moves the highlight up/down.
- **ENTER**: Enters the highlight to select the menu. When the menu has submenu items, pressing **ENTER** moves the highlight to a top menu in the submenu.
- **RETURN**: Cancels the current operation or closes the Options menu.

### Tip

You can bring up the menu items “LCD Off,” “Sleep,” “Timer” and “Sound Settings” in the Options menu regardless of a function.

Continued 

## ■ Status bar

The Status bar indicates the following information.



- ① Indicates music or sound source and photo image source.
- ② Indicates the status of Play Timer or Sleep Timer.
- ③ Indicates current GROOVE, surround and equalizer settings.
- ④ Indicates media insertion or connection status.
- ⑤ Clock

## Tip

You can turn on the status bar when you play back a DVD VIDEO, video file or slideshow by pressing DISPLAY.

## ■ Playback screens and indicators

### • CD-DA/MP3 disc

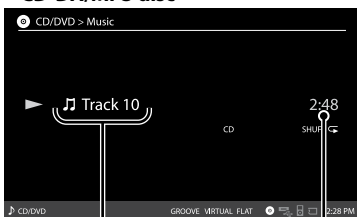

A

B

### • USB device/iPod/Memory card

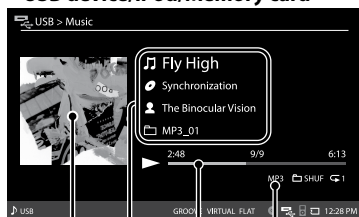

C

D

E

F

G

H

I

J

K

L

TAG

MP3

CD

PGM

SHUF

1

## **A** Track Information

- Current track name and its album number (🎵) (MP3 disc only) (see “Information display on the CD music playback screen” on page 79)

## **B** Time information

- See “Information display on the CD music playback screen” on page 79.

## **C** Album artwork (If available)

## **D** Music information (If available)

- Current file name (🎵)/Album (folder) name (📁)/Artist name (👤)/Current folder name (📁)

## **E** Playback progress bar

## **F** Audio format (USB device and memory card only)

## **G** Lights up when the ID3 tag information is displayed (MP3 files on MP3 disc only).

## **H** Lights up when an MP3 disc is inserted.

## **I** Lights up when a CD-DA/CD-R/CD-RW music disc is inserted.

## **J** Lights up when using Program Play with a CD-DA disc or VIDEO CD.

## **K** Play mode indicator

- CD-DA/MP3 disc: No display (normal play)/SHUF (shuffle play)
- USB device/Memory card: No display (normal play)/SHUF (shuffle play)/🎵 SHUF (album shuffle)/📁 SHUF (folder shuffle)
- iPod: No display (normal play)/SHUF (shuffle play)/🎵 SHUF (album shuffle)

## **L** Repeat mode indicator

- CD-DA disc: No display (Repeat off)/🔄 (Repeat 1 disc)/🔄 1 (Repeat one track)
- MP3 disc: No display (Repeat off)/🔄 (Repeat 1 disc)/🔄 (Repeat one folder) /🔄 1 (Repeat one file)
- USB device/iPod/Memory card: No display (Repeat off)/🔄 (Repeat all files)/🔄 1 (Repeat one file)

## **Notes**

- When “Please Wait” is displayed in the album artwork area, the system is waiting for album artwork from the iPod. It may take some time for the artwork to appear. Some operations are unavailable during this process.
- Album artwork may not be displayed in some cases.

## Operations with the Control Menu (CD/DVD function only)

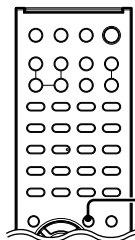
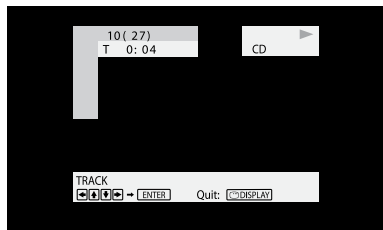

The Control Menu can be used when using the CD/DVD function for optional settings such as play mode or repeat mode settings or for various DVD-oriented functions. You can call up the Control Menu using the  DISPLAY button on the remote. For more detailed information about the Control Menu, see each section of the “Disc” chapter in the Operating Instructions and “Guide to the Control Menu display (CD/DVD function only)” (page 113).

### ■ Control Menu



The Control Menu can be called up using the  DISPLAY button.





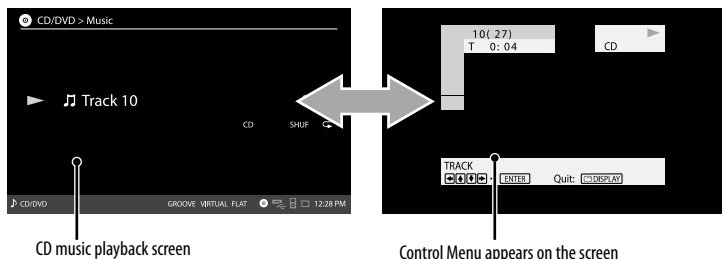

## How to call up the Control Menu when the CD music playback screen is displayed

If you want to call up the Control Menu while the CD music playback screen is displayed, make sure to repeatedly press  DISPLAY on the remote. Repeatedly pressing  DISPLAY allows you to call up the Control Menu.

When you switch back to the CD music playback screen, press DISPLAY.



### Tips

- You can also use the following combinations to call up the Control Menu while the CD music playback screen is displayed.
  - Press DVD MENU, and then press  DISPLAY repeatedly.
  - Press ///, and then press  DISPLAY repeatedly.
- When listening to the MP3 disc, repeatedly pressing DVD MENU allows you to display the folder list or the file list directory from the CD music playback screen.

## Getting Started

### Hooking up the system securely

Connect the speaker cords and FM/AM antennas to the system as illustrated below. WHG-SLK2i can be installed on the wall using the supplied wall-mounting brackets. When you wall-mount the system, follow the instructions described in the separate leaflet "Installing the system on the wall" after connections of speaker cords and antennas are made.

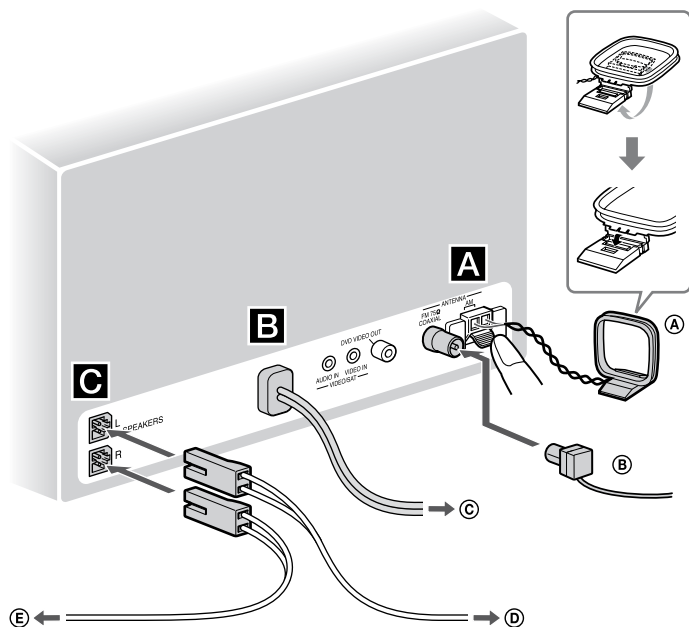

(A) AM loop antenna

(B) FM lead antenna (Extend it horizontally.)

(C) To wall outlet

(D) To front speaker (Left)

(E) To front speaker (Right)



## **A** FM/AM antennas

Find a location and an orientation that provide good reception, and then set up the antennas.

Keep the antennas away from the speaker cords, the power cord and the USB cable to avoid picking up noise.

## **B** Power

Connect the power cord to a wall outlet. If the supplied adaptor on the plug does not fit your wall outlet, detach it from the plug (only for models equipped with an adaptor).

## **C** Speakers

Connect the speaker cords to the SPEAKERS jacks.

## Canceling the automatic demonstration

When you first turn on the system, the demonstration screen appears automatically.

To turn off the automatic demonstration screen, follow the procedure below.

- 1 Select "Settings" from the home menu, then press ENTER.
- 2 Select "Demonstration mode," then press ENTER.  
The setting screen appears.
- 3 Press  $\blacktriangle/\blacktriangledown$  repeatedly to select "OFF," then press ENTER.

## Saving power in standby mode

This system enters standby mode when you turn off the system using the  $I/\text{C}$  button, minimizing the power consumption automatically (power saving mode). However, if "Demonstration mode" has been enabled, the system cannot enter power saving mode. Be sure to turn off demonstration mode to save power in standby mode.

### Note

Be aware that the system cannot enter power saving mode if both "Demonstration mode" and "Auto Standby" (page 97) settings are turned on.

## Inserting batteries

Slide and remove the battery compartment lid, and insert the two supplied R6 (size AA) batteries,  $\ominus$  side first, matching the polarities shown below.

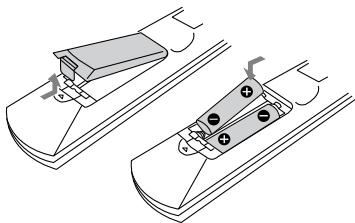

### Note

If you do not use the remote for a long period of time, remove the batteries to avoid possible damage from battery leakage and corrosion.

### Tip

With normal use, the batteries should last for about six months. When the remote no longer operates the system, replace both batteries with new ones.

## Using the iPod

Insert an iPod Dock Adapter into the Dock before use. The iPod Dock Adapter is not supplied with the system. Use an iPod Dock Adapter supplied with your iPod. For details on the iPod Dock Adapter, refer to the user's guide of your iPod.

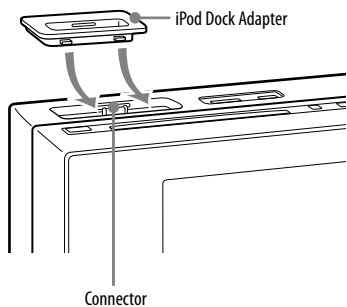

To remove the iPod Dock Adapter, pull it up with your fingernail or a flat object using the slot inside the adapter.

## Hooking up the TV

Connect the video input jack of your TV to the DVD VIDEO OUT jack on the unit, using the supplied video cord (WHG-SLK2i) or a commercially available video cord (WHG-SLK1i). Please be aware that the connection should be made before installing the system on the wall if you purchased WHG-SLK2i and are using it on the wall.

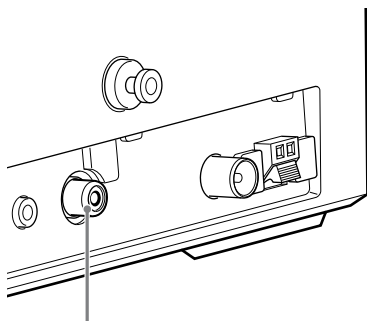

DVD VIDEO OUT

### Notes on the video output of DVD VIDEO OUT jack

- Video output is available only when you are using the CD/DVD function and the inserted disc contains motion picture or still image data.
- You cannot view video contents stored in the iPod, USB device or memory card on the connected TV screen. Video contents on those devices can be viewed only on the LCD screen.

## Changing the color system

(Except for North American, European and Latin American models)

Set the color system to PAL or NTSC depending on the color system of your TV.

The default setting for the color system is different depending on the area.

Each time you perform the procedure below, the color system changes as follows:

NTSC ↔ PAL

- 1 Press I/⏻ to turn on the system.
- 2 Select "CD/DVD" from the home menu, then press ENTER.
- 3 Press I/⏻ to turn off the system.
- 4 Press I/⏻ on the unit while holding down ■ on the unit.  
The system turns on automatically and the color system is changed. "DVD COLOR NTSC" or "DVD COLOR PAL" appears on the screen.

Continued 

## When using a TV

Turn on the TV and select the video input so that you can view the pictures from this system.

### Operating a Sony TV

You can use the following buttons to operate a Sony TV.

To	Press
Turn the TV on or off	TV I/⏻.
Switch the TV's input source between the TV and other input sources	TV INPUT.
Select the TV channels	TV CH +/-.
Adjust the volume of the TV speaker(s)	TV VOL +/-.

## Performing the basic adjustments

You can make the basic adjustments for using the system.

### Performing "QUICK" setup for CD/DVD function

Follow the steps below to select the display language and the TV type. If you do not want to perform "QUICK" setup, press CLEAR in step 3. The guide message will disappear from the screen.

**1** Turn on your TV and select the video input\*.

\* This step is not required when using the LCD screen for performing "QUICK" setup.

**2** Press I/⏻ to turn on the system.

#### Note

Make sure there is no disc in the unit. Otherwise, the guide message does not appear.

- 3** Select “CD/DVD” from the home menu, then press ENTER.  
The guide message appears at the bottom of the screen.

- 4** Press ENTER without inserting a disc.  
“LANGUAGE SETUP” appears.

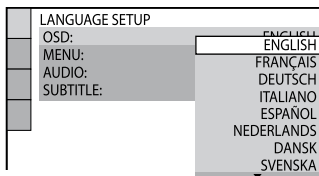

- 5** Press **↑** or **↓** repeatedly to select a desired language, then press ENTER.  
The setting is selected and “VIDEO SETUP” appears.

#### Tip

Selected language is applied to the “OSD,” “MENU” and “SUBTITLE” of the Control Menu (page 54).

#### Note

The selectable language is different depending on the area.

- 6** Press **↑** or **↓** repeatedly to select the setting that matches your TV type.

#### If you have a 4:3 standard TV:

Select “4:3 LETTER BOX” or “4:3 PAN SCAN” (page 55).

#### If you have a wide-screen TV or a 4:3 standard TV with wide-screen mode:

Select “16:9” (page 55).

- 7** Press ENTER.

The setting is selected and “QUICK SETUP is complete.” appears.  
The system is ready for playback.  
If you want to change each setting individually, see “Using the “SETUP” menu” (page 53).

#### If you make a mistake

Press **⏪**, then select the item again.

#### To quit “QUICK” setup

Press **⏏** DISPLAY.

#### To recall “QUICK” setup settings

- Press **⏏** DISPLAY when playback is stopped.  
The Control Menu appears.
- Press **↑** or **↓** repeatedly to select **⏏** (SETUP), then press ENTER.
- Press **↑** or **↓** repeatedly to select “QUICK,” then press ENTER.

#### Note

The guide message appears at the bottom of the screen when you turn on the system for the first time or after performing “RESET” (page 96).

## Selecting the display language for the home menu

You can select a language for the home menu.

English, French, Spanish, German or Portuguese can be selected for the display language.

- 1 Select “Settings” from the home menu, then press ENTER.
- 2 Press  $\uparrow/\downarrow$  repeatedly to select “Language,” then press ENTER. The setting screen appears.
- 3 Press  $\uparrow/\downarrow$  repeatedly to select the desired language, then press ENTER.

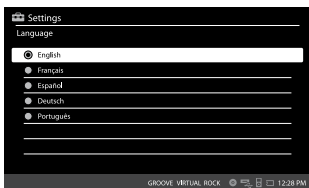

## Setting the clock

- 1 Select “Settings” from the home menu, then press ENTER.
- 2 Press  $\uparrow/\downarrow$  repeatedly to select “Time & Date,” then press ENTER. The setting screen appears.
- 3 Set the time and date as follows.

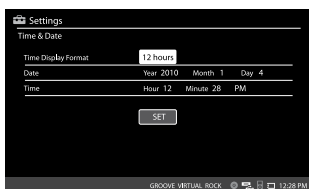

**“Time Display Format”**

Select “12 hours” or “24 hours.” When you select the format of “12 hours,” “AM” or “PM” can be selected. After selecting the time format, set the hour (“Hour”) and the minutes (“Minute”).

**“Date”**

Set the values for “Year,” “Month” and “Day.”

**“Time”**

Set the values for “Hour” and “Minute,” and select “AM” or “PM.”

**Note**

The clock settings are cancelled when you disconnect the power cord or if a power failure occurs.

## Disc

### Playing a disc

DVD-V   DVD-VR   VIDEO CD   C D   DATA CD  
DATA DVD

Depending on the DVD VIDEO or VIDEO CD, some operations may be different or restricted. Refer to the operating instructions supplied with the disc.

Note that the playback of video files (DivX/MPEG4 video files) on the disc is not available on the North American model.

#### **Note on the maximum number of tracks, files and folders on a DATA CD/DATA DVD**

This system cannot play a DATA CD/DATA DVD in the following cases.

- When the number of tracks or files on a folder exceeds 150.
- When the number of folders on a disc exceeds 200.

These numbers may vary depending on the track structure, the file structure and the folder structure.

1 Select "CD/DVD" from the home menu, then press ENTER.

2 Insert a disc.

Insert a disc in the disc slot with the label side facing forward. Playback starts automatically when you insert a disc in the disc slot. If the playback does not start automatically, press ►.

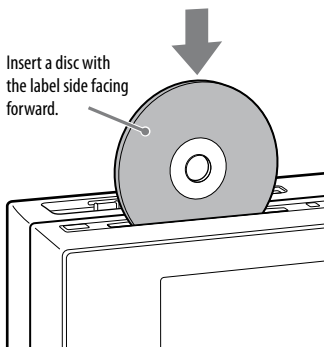













## Notes

- **Do not insert a disc with non-standard shapes (e.g., heart, square, star). The disc may fall into the system and cause irreparable damage.**
- When pressing  on the unit and then reinserting the disc that appears in the disc slot, do not simply push in the disc. Remove the disc from the disc slot and then reinsert it.
- Do not turn off the system with a disc halfway inserted in the disc slot. Doing so may cause the disc to fall.
- Do not use a disc with tape, seals or paste on it as this may cause malfunction.
- When you eject a disc, handle the disc by its edge. Do not touch the surface.
- Do not push a disc into the disc slot when the system is off. Doing so may cause the system to malfunction.
- Do not insert an 8 cm disc with an adaptor. Doing so may cause the system to malfunction.
- Do not place any object on the disc slot.
- Depending on the system status, the volume level may not appear on the screen.

## Other operations

Operations for video files are not available on the North American model.

To	Do this
Stop playback	Press  . To resume playback where you stopped the disc, press  . To play back from the beginning of the disc, press  again.
Pause playback	Press  <sup>1)</sup> . To resume playback, press  again or press  .
Select a track, audio file, chapter or video file <sup>2)</sup>	Press  or  repeatedly during playback. Or, press any of the numeric buttons, then press ENTER <sup>3)</sup> .
Select a title <sup>4)</sup>	Press DVD TOP MENU, then press  ,  , or any of the numeric buttons.
Select a folder <sup>5)</sup>	Press  +/- repeatedly during playback or when playback is paused.

To	Do this
Locate a point quickly in fast forward or fast reverse (Lock Search) <sup>6)</sup>	Press ◀◀ or ▶▶ during playback. Each time you press ◀◀ or ▶▶, the playback speed changes cyclically <sup>7)</sup> . To return to normal playback, press ▶.
Watch frame by frame (Slow-motion Play) <sup>8)</sup>	Press ◀◀ SLOW <sup>9)</sup> or SLOW ▶▶ when playback is paused. Each time you press ◀◀ SLOW or SLOW ▶▶, the playback speed changes. To return to normal playback, press ▶.
Play one frame at a time (Freeze Frame) <sup>8)</sup>	Press ◀◀ STEP <sup>9)</sup> or STEP ▶▶ to reverse or advance frame by frame when playback is paused. Each time you press ◀◀ STEP or STEP ▶▶, the frame changes. To return to normal playback, press ▶.

To	Do this
Replay the previous scene (Instant Replay) <sup>10)</sup>	Press ◀•REPLAY during playback.
Briefly fast forward the current scene (Instant Advance) <sup>10)</sup>	Press ADVANCE •➡ during playback.
Change the angle <sup>11)</sup>	Press ANGLE repeatedly during playback. Each time you press ANGLE, the angle changes.
Display the subtitle	Press SUBTITLE repeatedly during playback. Each time you press SUBTITLE, the subtitle language changes <sup>12)</sup> or turns off <sup>13)</sup> .

<sup>1)</sup> There may be some disturbance in the video image.

<sup>2)</sup> Except for JPEG image files. You cannot select an audio track or file during Lock Search operation of MP3 files.

<sup>3)</sup> DVD VIDEO, DVD-R/-RW in VR mode, VIDEO CD, AUDIO CD and video files only.

<sup>4)</sup> DVD VIDEO only.

<sup>5)</sup> MP3 files, JPEG image files, DivX video files and MPEG4 video files only.

<sup>6)</sup> Except for JPEG image files.

<sup>7)</sup> Depending on the disc, the actual speed may differ.

- <sup>8)</sup> DVD VIDEO, DVD-R/-RW in VR mode, video files and VIDEO CD only.
- <sup>9)</sup> Except for VIDEO CD and video files.
- <sup>10)</sup> DVD VIDEO and DVD-R/-RW in VR mode only.
- <sup>11)</sup> Multi-angle DVD VIDEO only.
- <sup>12)</sup> For DVD VIDEO, DVD-R/-RW in VR mode or DivX video files with multilingual subtitles.
- <sup>13)</sup> For DVD VIDEO, DVD-R/-RW in VR mode or DivX video files with subtitles.

## Options menu for the CD/DVD function

You can use the Options menu items during playback of DVD VIDEOS. Functions of the menu items are the same as DVD TOP MENU, DVD MENU and  DISPLAY on the remote. Press OPTIONS to select any of the menus during playback.

### Notes

- You cannot perform resume playback during Shuffle Play or Program Play.
- Resume playback may not work properly with some discs.
- You cannot search for a still picture on a DVD-R/-RW in VR mode.
- You may not be able to use the Instant Replay or Instant Advance function in Repeat Play mode or with some scenes.
- Depending on the DVD VIDEO, you may not be able to change the angle, even if multi-angles are recorded on the DVD VIDEO.
- Depending on the DVD VIDEO, you may not be able to change the subtitles even if multilingual subtitles are recorded on the DVD VIDEO. You also may not be able to turn the subtitles off.
- You can change the subtitles if the DivX video file has an ".avi" or ".divx" extension and contains subtitle information within the same file.



## On Multi-disc Resume

(DVD VIDEO and VIDEO CD only)

This system can store the point where you stopped the playback of the disc for up to 6 discs and resumes playback when you insert the same disc again. If you store a playback resume point for the 7th disc, the playback resume point for the first disc will be deleted.

The default setting is "ON." To turn off this function, set "MULTI-DISC RESUME" in "SYSTEM SETUP" to "OFF" (page 58).

### Notes

- If "MULTI-DISC RESUME" in "SYSTEM SETUP" is set to "ON" and you play back a recorded disc such as DVD-R, the system may play back other recorded discs from the same playback resume point. To start playback from the beginning of the disc, press  twice and then press .
- The playback resume point is deleted when the power cord is disconnected.

## Changing the language/sound

Press AUDIO repeatedly during playback to select the desired audio format or mode.

If the CD music playback screen is displayed, make sure to press  DISPLAY repeatedly to call up the Control Menu (page 23) before pressing AUDIO.

The default setting is underlined.

### When playing a DVD VIDEO:

Depending on the DVD VIDEO, the option of language and audio format varies.

When a 4-digit number is displayed, the digits represent a language code (see “Language code list” (page 117)). When the same language is displayed two or more times, the DVD VIDEO is recorded in multiple audio formats (PCM, MPEG audio or Dolby Digital). Note that the sound changes automatically depending on the disc.

Some DVD VIDEOS allow you to select items such as the language for the subtitles and the language for the sound using DVD MENU.

### When playing a DivX video file:

The options for audio format differ depending on the DivX video files.

### When playing a DVD-R/-RW in VR mode:

The number of audio tracks recorded on a disc are displayed.

Example:

- 1: MAIN: the main sound of the audio track 1.
- 1: SUB: the sub sound of the audio track 1.
- 1: MAIN+SUB: the main and sub sound of the audio track 1.
- 2: MAIN\*: the main sound of the audio track 2.
- 2: SUB\*: the sub sound of the audio track 2.
- 2: MAIN+SUB\*: the main and sub sound of the audio track 2.

\* These items do not appear if only one audio stream is recorded on the disc being played back.

### When playing a VIDEO CD, AUDIO CD, or MP3 file:

You can select the sound from the right or left channel and listen to the sound of the selected channel through both the right and left speakers. For example, when playing a track with the vocals on the right channel and the instruments on the left channel, you can hear the instruments from both speakers by selecting the left channel.

- STEREO: the standard stereo sound.
- 1/L: the sound of the left channel (monaural).
- 2/R: the sound of the right channel (monaural).

**When playing a Super VCD:**

- 1: STEREO: the stereo sound of the audio track 1.
- 1: 1/L: the sound of the left channel of the audio track 1 (monaural).
- 1: 2/R: the sound of the right channel of the audio track 1 (monaural).
- 2: STEREO: the stereo sound of the audio track 2.
- 2: 1/L: the sound of the left channel of the audio track 2 (monaural).
- 2: 2/R: the sound of the right channel of the audio track 2 (monaural).

**Note**

While the system is playing a Super VCD on which the audio track 2 is not recorded, no sound will come out when you select "2: STEREO," "2: 1/L" or "2: 2/R."

**To display the audio signal format**

(DVD VIDEO and video files only)  
When you press AUDIO repeatedly during playback, the format of the current audio signal is displayed on the screen.

**When playing a DVD VIDEO:**

For example, in Dolby Digital format, multiple signals ranging from monaural to 5.1 channel signals can be recorded on a DVD VIDEO.

Example: For Dolby Digital 5.1 channel

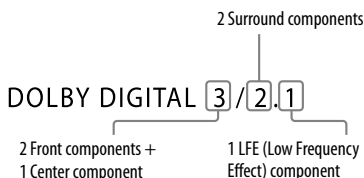
**When playing a video file on a disc:**

Example: Format information about MP3 audio

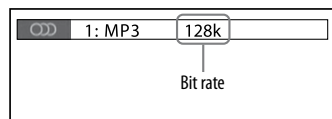

## Playing VIDEO CDs with PBC functions (PBC Playback) (Version 2.0)

### VIDEO CD

You can use the PBC (Playback Control) menus included on the VIDEO CDs (Version 2.0 only) on the screen to enjoy the disc's interactive software. The menu format and structure may differ depending on each disc.

- 1 Select "CD/DVD" from the home menu, then press ENTER.
- 2 Insert a VIDEO CD.  
The PBC menu appears on the screen. Depending on the VIDEO CD, the menu may not appear.
- 3 Press the numeric buttons to select the desired item number.
- 4 Press ENTER.  
Depending on the VIDEO CD, "Press ENTER" may appear as "Press SELECT" in the operating instructions supplied with the disc. In this case, press ►.

- 5 Continue playback according to the instructions on the menus. Refer to the operating instructions supplied with the VIDEO CD, as the operating procedure may differ depending on the VIDEO CD.

### Note

PBC playback is cancelled when Shuffle Play, Program Play or Repeat Play is activated.







### To cancel playback with PBC functions

- 1 Press ◀◀ or ▶▶ repeatedly or press the numeric buttons to select a track when playback is stopped.
- 2 Press ► or ENTER.  
Playback starts from the selected track. Still images, such as the menu screens, will not be shown.  
To return to PBC playback, press ■ twice, then press ►.

## Selecting “ORIGINAL” or “PLAY LIST”

### DVD-VR





This function is only available for DVD-Rs/-RWs in VR mode with a playlist created.

- 1 Press  DISPLAY when playback is stopped.  
The Control Menu appears.
- 2 Press  or  repeatedly to select  (ORIGINAL/PLAY LIST), then press ENTER.  
The options for “ORIGINAL/PLAY LIST” appear.
- 3 Press  or  repeatedly to select the desired setting.
  - PLAY LIST: play back according to the playlist created on the disc.
  - ORIGINAL: play back according to the originally recorded sequence.
- 4 Press ENTER.



## Searching for items on a disc by the assigned numbers

### DVD-V DVD-VR VIDEO CD C D DATA CD DATA DVD

You can search by different information recorded on a disc, such as title, track, scene, file, and folder. Each item is assigned a unique number on the disc, and you can select the numbered item you want from the Control Menu. You can also search for a particular point using the time code (Time Search) (DVD VIDEO and DVD-R/-RW in VR mode only).

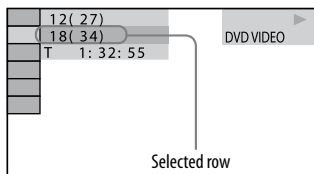
- 1 Press  DISPLAY.  
The Control Menu appears.
- 2 Press  or  repeatedly to select the search item.  
Example: when you select  (CHAPTER) “\*\* (\*\*)” is selected (\*\* refers to a number). The number in parentheses indicates the total number of titles, chapters, tracks, index, scenes, folders or files.







- 3 Press ENTER.  
“\*\* (\*\*)” changes to “- - (\*\*).”
- 4 Press  or  repeatedly or the numeric buttons to select the title, track, folder or file, etc.  
If you make a mistake, press CLEAR to cancel the number.
- 5 Press ENTER.  
The system starts playback from the selected title, track, folder or file, etc.

#### Tip

When the Control Menu display is turned off, you can search for a chapter (DVD VIDEO and DVD-R/-RW in VR mode) or track (AUDIO CD and VIDEO CD) or file (video files in DATA CD/DVD) by pressing the numeric buttons and ENTER.

### To search for a particular point using the time code (Time Search)

(DVD VIDEO and DVD-R/-RW in VR mode only)

- 1 Press  DISPLAY.
- 2 Press  or  repeatedly to select  (TIME).  
“T \*\*: \*\*: \*\*” (elapsed playing time of the current title) is selected.
- 3 Press ENTER.  
“T \*\*: \*\*: \*\*” changes to “T--:--:--”





- 4 Input the time code using the numeric buttons, then press ENTER.  
For example, to find the scene at 2 hours, 10 minutes, and 20 seconds from the beginning, enter “21020.”  
If you make a mistake, press CLEAR to cancel the number.

#### Note

Depending on the disc, you cannot perform Time Search.

### Selecting a folder/file using the Control Menu

#### DATA CD DATA DVD

- 1 Press  DISPLAY when playback is stopped.  
The Control Menu appears.
- 2 Press  or  repeatedly to select  \* (MEDIA), then press ENTER.  
The options for “MEDIA” appear.  
\*  appears on the North American model.
  - MUSIC/PHOTO: for playing both MP3 files and JPEG image files in the same folder as a slideshow
  - MUSIC: for playing MP3 files
  - VIDEO (except for the North American model): for playing DivX or MPEG4 video files
  - PHOTO: for playing JPEG image files



- 3** Press **↑** or **↓** repeatedly to select the desired option, then press **ENTER**. When the desired option has already been selected, press **DVD MENU**.

A list of folders that contains the files of the selected file type appears.

- 4** Press **↑** or **↓** repeatedly to select a folder.

**Playing a folder:**

Press **▶**.

The system starts playback from the first file of the selected folder.

To stop playback, press **■**.

**Playing an MP3 file:**

- 1** Press **ENTER**.

“TRACK LIST” appears.

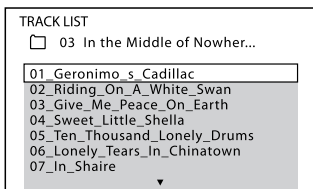

- 2** Press **↑** or **↓** repeatedly to select the desired MP3 file, then press **ENTER**.

The system starts playback of the selected MP3 file.

To stop playback, press **■**.

**Playing an image file:**

- 1** Press **PICTURE NAVI**.

Thumbnail picture for the first 16 JPEG image files in the selected folder is displayed.

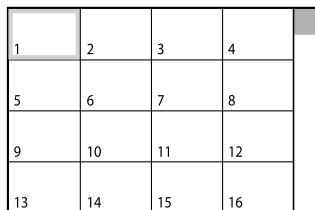

- 2** Press **↕/↔/↗/↘** repeatedly to select the image you want to view, then press **ENTER**.

The selected image is displayed on the screen. To display the next or previous image, press **↗/↘**. To return to the thumbnail view, press **PICTURE NAVI**.

When you press **▶** after selecting a image file, the slideshow starts from the selected image file. To stop the slideshow, press **■**.

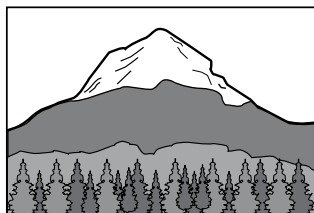

## Playing a video file (except for the North American model):

- 1 Press ENTER.  
“FILE LIST” appears.

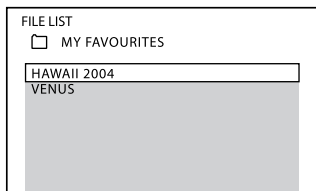

- 2 Press **▲** or **▼** repeatedly to select the desired video file, then press ENTER.

The system starts playback of the selected video file.

To stop playback, press **■**.

## Other operations

Operations for video files are not available on the North American model.

To	Do this
Display the next or previous page of “TRACK LIST,” “FOLDER LIST” or “FILE LIST”	Press <b>◀••</b> or <b>••▶</b> repeatedly.
Play back the next folder of MP3 files or video files	Press <b>▶▶▶</b> repeatedly until reaching the last file of the current folder, then press <b>▶▶▶</b> once. To select the previous folder, select the folder from “FOLDER LIST.”
Return to “FOLDER LIST” when “TRACK LIST” or “FILE LIST” is displayed	Press <b>↶</b> RETURN.
Play back the next folder of JPEG image files	Press <b>▶</b> repeatedly until reaching the last file of the current folder, then press <b>▶</b> once. To select the previous folder, select the folder from “FOLDER LIST.”

To	Do this
Rotate the image by 90 degrees	Press <b>↑</b> or <b>↓</b> repeatedly while viewing an image or slideshow. To return to the original view, press CLEAR. Rotating an image during a slideshow stops the slideshow. To resume slideshow, press <b>■</b> .

### Notes

- Supported file formats are as follows:
    - MP3: file extension “.mp3”
    - DivX: file extension “.avi” or “.divx”
    - MP4: file extension “.mp4” or “.m4v”
    - JPEG: file extension “.jpg” or “.jpeg”
- Note that even when file names have the above file extensions, if the actual files differ, the system cannot play those files, or playback problems occur even if you play the files. Especially, such audio files and audio data in video files may generate a loud noise which could damage the speaker system and the system may malfunction.

- Depending on the encoding/writing software, recording device, or the recording media used to record data, you may encounter problems such as being unable to play back, sound interruptions and noise.
- The following discs/situations can increase the time it takes to start playback:
  - a disc recorded with a complicated tree structure.
  - a disc recorded in multi session.
  - a disc to which data can be added (non-finalized disc).
  - when the tracks or files in another folder have just been played back.
- Some CD-Rs/-RWs or DVD-Rs/-RWs/+Rs/+RWs cannot be played back on the system depending on the file format.
- The system can play back to a depth of 8 folders only.
- The system may not play certain types of JPEG image files (ex. a JPEG image file that is less than 8 (width) × 8 (height) pixels).
- When you press **◀** or **▶** to select the next or previous image, the image will return to its original view even if you have rotated the image previously.
- The system may not play back a video file when the file has been combined from two or more video files.
- The system cannot play back any video file that is more than 720 (width) × 576 (height) pixels in resolution or 2 GB in file size.
- Depending on the video file, the picture may be unclear or the sound may skip.
- The system cannot play back some video files that are longer than 3 hours.

- Due to the compression technology used for video files, it may take some time after you press  for the picture to appear.
- Depending on the video file, the sound may not match the pictures on the screen.

### Tip on playing the DivX video files





If the number of viewing times has been preset, you can play back the DivX video files as many times as the preset number. The following occurrences are counted:



- when the system is turned off.
- when the disc is removed.
- when another video file is played back.



### To play MP3 files and JPEG image files as a slideshow with sound

(DATA CD and DATA DVD only)

You can play back a slideshow with sound by first placing both JPEG image files and MP3 files in the same folder on a DATA CD/DVD.

- 1 Press  DISPLAY when playback is stopped.  
The Control Menu appears.
- 2 Press  or  repeatedly to select  \* (MEDIA), then press ENTER.  
The options for “MEDIA” appear.  
\*  appears on the North American model.

- 3 Press  or  repeatedly to select “MUSIC/PHOTO,” then press ENTER.  
When “MUSIC/PHOTO” has already been selected, press DVD MENU.  
“FOLDER LIST” appears.

- 4 Press  or  repeatedly to select the desired folder, then press .  
The slideshow with sound starts from the selected folder.

- 5 Press DISPLAY to switch to the image display screen from the CD music playback screen.

You can switch between these screens by pressing DISPLAY repeatedly.

To stop playback, press .







To cancel the slideshow with sound, select “MUSIC” or “PHOTO” in step 3.

### Note

If you play back a large data size of MP3 files and JPEG image files at the same time, the sound may skip.

## To specify the slideshow speed

(JPEG image files only)







- 1 Press  DISPLAY during slideshow. The Control Menu appears. If “INTERVAL” is not displayed on the Control Menu, press  DISPLAY repeatedly until “INTERVAL” appears.
- 2 Press  or  repeatedly to select  (INTERVAL), then press ENTER. The options for “INTERVAL” appear.
- 3 Press  or  repeatedly to select the desired transition interval. The default setting is underlined.
  - NORMAL: Sets to the standard duration.
  - FAST: Sets the duration shorter than “NORMAL.”
  - SLOW 1: Sets the duration longer than “NORMAL.”
  - SLOW 2: Sets the duration longer than “SLOW 1.”
- 4 Press ENTER. The selected setting takes effect.

### Note

Some JPEG image files (especially progressive JPEG image files or JPEG image files with 3,000,000 pixels or more) may take a longer time to display than others, which may make the transitions seem longer than that of the option you selected.







## To select a transition effect for image files in the slideshow

(JPEG image files only)

- 1 Press  DISPLAY during slideshow. The Control Menu appears. If “EFFECT” is not displayed on the Control Menu, press  DISPLAY repeatedly until “EFFECT” appears.
- 2 Press  or  repeatedly to select  (EFFECT), then press ENTER. The options for “EFFECT” appear.
- 3 Press  or  repeatedly to select the desired setting. The default setting is underlined.
  - MODE 1: The image sweeps in from top to bottom of the screen.
  - MODE 2: The image sweeps in from left to right of the screen.
  - MODE 3: The image stretches out from the center of the screen.
  - MODE 4: The image randomly cycles through the effects.
  - MODE 5: The next image slides over the current image.
  - OFF: turns off this function.
- 4 Press ENTER. The selected setting takes effect.

## To select the playback priority for the file type

You can select playback priority when files of different media types, including MP3 files, JPEG image files and video files, are present on the disc.

- 1 Press  DISPLAY when playback is stopped.  
The Control Menu appears.
- 2 Press  or  repeatedly to select  \* (MEDIA), then press ENTER. The options for “MEDIA” appear.  
\*  appears on the North American model.
- 3 Press  or  repeatedly to select the desired setting.
  - MUSIC/PHOTO: You can play back a slideshow with sound, when MP3 files and JPEG image files are in the same folder.
  - MUSIC: MP3 file playback has priority.
  - VIDEO (except for the North American model): Video file playback has priority.
  - PHOTO: JPEG image file playback has priority.
- 4 Press ENTER.  
The selected setting takes effect.  
For further details of the playback priority of file types, see page 116.







## Using play mode

### Creating your own program (Program Play)

VIDEO CD 

You can make a program of up to 99 steps in the order you want them to be played back.

You can only program the tracks from the disc.

- 1 Press  DISPLAY when playback is stopped.  
The Control Menu appears.
- 2 Press  or  repeatedly to select  (PROGRAM), then press ENTER.  
The options for “PROGRAM” appear.
- 3 Press  or  repeatedly to select “SET →,” then press ENTER.

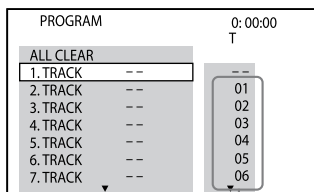

**4** Press **➡**.

The cursor moves to the track list “T” (in this case, “01”).

PROGRAM	0:00:00
T	
ALL CLEAR	--
1. TRACK --	01
2. TRACK --	02
3. TRACK --	03
4. TRACK --	04
5. TRACK --	05
6. TRACK --	06
7. TRACK ▼	06

**5** Select the track you want to program.

For example, select track “02.”  
Press **▲** or **▼** repeatedly to select “02” under “T,” then press ENTER.

PROGRAM	0:03:51
T	
ALL CLEAR	--
1. TRACK --	01
2. TRACK --	02
3. TRACK --	03
4. TRACK --	04
5. TRACK --	05
6. TRACK --	06
7. TRACK ▼	06

Total time of the programmed tracks

**6** To program other tracks, repeat steps 4 and 5.**7** Press **▶**.

Program Play starts.  
When the Program Play ends, you can restart the same program by pressing **▶**.

**To change a programmed step:**

Press **▲** or **▼** repeatedly to select the programmed step number you want to change. Then, press **▶** and select the desired track number.

**To delete a programmed step:**

Press **▲** or **▼** repeatedly to select the programmed step number you want to delete. Then, press CLEAR.

**To delete all of the programmed steps in the program list:**

Press **▲** to select “ALL CLEAR.” Then, press ENTER.

**To cancel Program Play**

Press CLEAR or select “OFF” in step 3. To play back the same program again, select “ON” in step 3 and press ENTER.

**Notes**

- When Program Play is activated, the “REPEAT” setting is automatically changed to “ON” if the current setting is “DISC” or “TRACK.”
- You cannot perform Program Play with VIDEO CDs during PBC playback.

**Tip**

The Program Play is cancelled and the program list is cleared when

- you eject the disc.
- you turn off the system.
- you change the function.
- you press HOME to return to the home menu.

Continued 

## Playing in random order (Shuffle Play)







VIDEO CD

C D

DATA CD

DATA DVD

You can play back the tracks on the current disc in random order. Each time you perform Shuffle Play, the playing order may differ.

- 1 Press  DISPLAY.  
The Control Menu appears.
- 2 Press  or  repeatedly to select  (SHUFFLE), then press ENTER.  
The options for "SHUFFLE" appear.
- 3 Press  or  repeatedly to select the desired setting.  
The default setting is underlined.

### When playing a VIDEO CD or AUDIO CD:

- OFF: turns off this function.
- TRACK: all tracks on the disc are played back randomly.

### When Program Play is activated:

- OFF: turns off this function.
- ON: all tracks in the program list are played back randomly.

### When playing a DATA CD/DVD (except for video files):

- OFF: turns off this function.
- ON(MUSIC): all MP3 files in the selected folder on the disc are played back randomly.  
When no folder is selected, the first folder is played back randomly.

- 4 Press ENTER.
- 5 Press .  
Shuffle Play starts.  
To cancel Shuffle Play, press CLEAR or select "OFF" in step 3.

### Notes

- You cannot perform Shuffle Play with VIDEO CDs during PBC playback.
- The same song may be played back repeatedly for MP3 files.

### Tip

Shuffle Play is cancelled when

- you eject the disc.
- you turn off the system.
- you change the function.
- you perform Track/Index Search.
- you press HOME to return to the home menu.



## Playing repeatedly (Repeat Play)

DVD-V

DVD-VR

VIDEO CD

C D

DATA CD

DATA DVD

You can play the contents on a disc repeatedly.

You can also repeat Shuffle Play or Program Play.



**1** Press  DISPLAY.

The Control Menu appears.

**2** Press  or  repeatedly to select

 (REPEAT), then press ENTER.

The options for "REPEAT" appear.

**3** Press  or  repeatedly to select the desired setting.

The default setting is underlined.

### When playing a DVD VIDEO or DVD-R/DVD-RW in VR mode:

- OFF: does not play back repeatedly.
- DISC: repeats all the titles on the disc.
- TITLE: repeats the current title.
- CHAPTER: repeats the current chapter.

### When playing a VIDEO CD or AUDIO CD:

- OFF: does not play back repeatedly.
- DISC: repeats all the tracks on the current disc.
- TRACK: repeats the track.

### When playing a DATA CD or DATA DVD:

- OFF: does not play back repeatedly.
- DISC: repeats all the folders on the disc.
- FOLDER: repeats the current folder.
- TRACK<sup>1)</sup>: repeats the current audio file.
- FILE<sup>2)</sup>: repeats the current video file.

<sup>1)</sup> MP3 files only.

<sup>2)</sup> Not available on the North American model.

### When Program Play or Shuffle Play is activated:

- OFF: does not play back repeatedly.
- ON: repeats the Program Play or Shuffle Play.

**4** Press ENTER.

**5** Press .

Repeat Play starts.

To cancel Repeat Play, press CLEAR or select "OFF" in step 3.







## Notes

- Depending on the DVD VIDEO, you cannot perform Repeat Play.
- You cannot perform Repeat Play with VIDEO CDs during PBC playback.
- When playing a DATA CD/DVD which contains MP3 files and JPEG image files, the audio sound will not match the image if their playing time are different.
- Repeat Play is cancelled when
  - you eject the disc.
  - you turn off the system.
  - you change the function.
  - you press HOME to return to the home menu.

## Adjusting the delay between the picture and sound (“A/V SYNC”)

DVD-V DVD-VR VIDEO CD DATA CD DATA DVD

When the sound does not synchronize with the displayed pictures, you can adjust the delay between the picture and sound.

- 1 Press  DISPLAY.  
The Control Menu appears.
- 2 Press  or  repeatedly to select  (A/V SYNC), then press ENTER.  
The options for “A/V SYNC” appear.
- 3 Press  or  repeatedly to select the desired setting.  
The default setting is underlined.
  - OFF: Does not adjust.
  - ON: Adjusts the difference between picture and sound.
- 4 Press ENTER.









### Note



Depending on the input stream, this function may not be effective.

## Restricting playback of the disc (PARENTAL CONTROL)

### DVD-V

You can limit the playback of some DVD VIDEOS according to a predetermined level such as the age of the users. When a limited scene is played back, that scene may be skipped or replaced with different scenes.

- 1 Press  DISPLAY when playback is stopped.  
The Control Menu appears.
- 2 Press  or  repeatedly to select  (SETUP), then press ENTER.  
The options for "SETUP" appear.
- 3 Press  or  repeatedly to select "CUSTOM," then press ENTER.  
The Setup Menu appears.
- 4 Press  or  repeatedly to select "SYSTEM SETUP," then press ENTER.

- 5 Press  or  repeatedly to select "PARENTAL CONTROL," then press ENTER.

### If you have not registered a password:

The display for registering a new password appears on the screen.

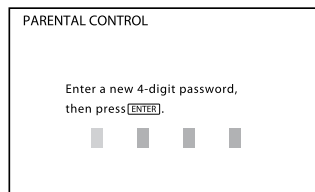

Enter a 4-digit password using the numeric buttons, then press ENTER.  
The display for confirming the password appears on the screen.

### When you have already registered a password:

The display for entering the password appears on the screen.

### If you make a mistake when entering your password:

Press  repeatedly to delete the number you have entered, then re-enter your password again.

- 6** Enter or re-enter your 4-digit password using the numeric buttons, then press ENTER.  
The display for setting the playback limitation level appears on the screen.

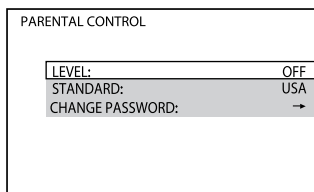

- 7** Press **▲** or **▼** repeatedly to select "STANDARD," then press ENTER.  
The options for "STANDARD" appear.
- 8** Press **▲** or **▼** repeatedly to select a geographic area as the playback limitation level, then press ENTER.  
The area is selected.  
When you select "OTHERS →," enter the area code for the geographic area you want by using the numeric buttons (see "Parental Control area code list" (page 118)).

- 9** Press **▲** or **▼** repeatedly to select "LEVEL," then press ENTER.  
The options for "LEVEL" appear.

- 10** Press **▲** or **▼** repeatedly to select the desired level, then press ENTER.  
"PARENTAL CONTROL" setting is completed.  
The lower the value, the stricter the limitation.

### To turn off the "PARENTAL CONTROL" function

Set "LEVEL" to "OFF" in step 10.

### To change the password

- 1 Follow the procedure from step 1 to step 6 of "Restricting playback of the disc (PARENTAL CONTROL)" (page 51), and press **▲**/**▼** repeatedly to select "CHANGE PASSWORD," and then ENTER.
- 2 Enter a new 4-digit password using the numeric buttons, then press ENTER.
- 3 Re-enter the new password for confirmation, then press ENTER.

## If you forget your password

Remove the disc and repeat steps 1 to 5 of “Restricting playback of the disc (PARENTAL CONTROL)” (page 51). When you are asked to enter your password, enter “199703” using the numeric buttons, then press ENTER. The display will ask you to enter a new 4-digit password. After you enter a new 4-digit password, reload the disc and press . When the display for entering your password appears, enter your new password.

## To play back a disc for which “PARENTAL CONTROL” is set

- 1 Insert the disc and press .  
The display for entering your password appears on the screen.
- 2 Enter your 4-digit password using the numeric buttons, then press ENTER.  
The system starts playback.

### Notes

- When you play back DVD VIDEOS which do not have the “PARENTAL CONTROL” function, playback cannot be limited on this system.
- Depending on the DVD VIDEO, you may be asked to change the “PARENTAL CONTROL” level while playing the disc. In this case, enter your password, then change the level. If resume playback is cancelled, the level returns to the original level.

## Using the “SETUP” menu

By using the Setup Menu, you can make various adjustments to items such as picture and sound. Displayed items vary depending on the country or region.





### Note

Playback settings stored in the disc take priority over the “SETUP” menu settings. Therefore, some of the “SETUP” menu settings may not be performed.

- 1 Press DISPLAY when playback is stopped.  
The Control Menu appears.
- 2 Press or repeatedly to select (SETUP), then press ENTER.  
The options for “SETUP” appear.
- 3 Press or repeatedly to select “CUSTOM,” then press ENTER.  
The Setup Menu appears.

- 4** Press **▲** or **▼** repeatedly to select the setup item from the displayed list, then press **ENTER**.  
The setup item is selected.

Setup items:

- : LANGUAGE SETUP
- : VIDEO SETUP
- : AUDIO SETUP
- : SYSTEM SETUP

Example: “VIDEO SETUP”

Selected item

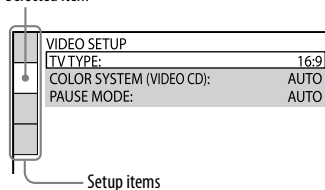

- 5** Press **▲** or **▼** repeatedly to select the desired item, then press **ENTER**.

The options for the selected item appear.

Example: “TV TYPE”

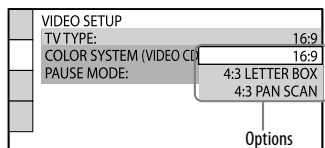

- 6** Press **▲** or **▼** repeatedly to select the desired setting, then press **ENTER**.

The setting is selected and setup is completed.

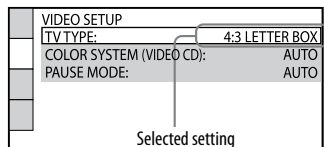

## Setting the language — “LANGUAGE SETUP”

Configure language-related settings.

### **OSD**

(On-Screen Display)

Sets the display language for the “OSD.”

### **MENU\***

(DVD VIDEO only)

Sets the language for the DVD menu.

When you select “OTHERS →,” enter a language code using the numeric buttons (page 117).

**AUDIO\***

(DVD VIDEO only)

Switches the language of the sound track. When you select "ORIGINAL," the language given priority in the disc is selected.

When you select "OTHERS →," enter a language code using the numeric buttons (page 117).

**SUBTITLE\***

(DVD VIDEO only)

Switches the language of the subtitle. When you select "AUDIO FOLLOW," the language for the subtitles changes according to the language you selected for the sound track.

When you select "OTHERS →," enter a language code using the numeric buttons (page 117).

\* If language which you have selected is not available from the language tracks recorded on a DVD VIDEO, the language is automatically set based on the given priority by the disc. However, depending on the disc, the language may not be selected automatically due to the disc specifications.



## Setting the TV screen — "VIDEO SETUP"

Choose the settings according to the TV you connected.

The default setting is underlined.

**TV TYPE**

(DVD VIDEO only)

16:9: Select this when you connect a wide-screen TV or a TV with a wide mode function.



**4:3 LETTER BOX**: Select this when you connect a 4:3 screen TV. This setting displays a wide picture with bands on the upper and lower portions of the screen.



**4:3 PAN SCAN\***: Select this when you connect a 4:3 screen TV. This setting displays the wide picture on the entire screen and cuts off the portions that do not fit.



Continued

---

### COLOR SYSTEM(VIDEO CD)

(Except for North American, European and Latin American models)

Sets the output video signal for playback of a VIDEO CD.

**AUTO:** Outputs the video signal according to the color system of the disc, either PAL or NTSC.

**PAL:** Changes the video signal of an NTSC disc and output it in PAL system.

**NTSC:** Changes the video signal of a PAL disc and output it in NTSC system.

---

### BLACK LEVEL

(North American and Latin American models only)

Sets the black level (setup level) for the video signal output.

**ON:** Sets the black level of the output signal to the standard level.

**OFF:** Lowers the standard black level. Use this when the picture becomes too white.

---

### PAUSE MODE

(DVD VIDEO and DVD-R/-RW in VR mode only)

**AUTO:** The picture, including subjects that move dynamically, is output with no jitter. Normally select this option.

**FRAME:** The picture, including subjects that do not move dynamically, is output in high resolution.

---

\* Depending on the DVD VIDEO, "4:3 LETTER BOX" may be selected automatically instead of "4:3 PAN SCAN" or vice versa.



### Setting the audio options — "AUDIO SETUP"

Configure audio related settings.  
The default setting is underlined.

---

#### AUDIO DRC<sup>1)</sup> (Dynamic Range Compression)

(DVD VIDEO only)

**OFF:** No compression of dynamic range.

**STANDARD:** Reproduces the sound track with the kind of dynamic range that the recording engineer intended. Useful for watching movies at low volume late at night.

**MAX:** Narrows the dynamic range fully.

---



---

**TRACK SELECTION**

(DVD VIDEO only)

Gives priority to the sound track which contains the highest number of channels when you play back a DVD VIDEO on which multiple audio formats (PCM, MPEG audio, or Dolby Digital)<sup>2)</sup> are recorded.

**OFF:** No priority given.

**AUTO**<sup>3)</sup>: Priority given.

---

- 1) "AUDIO DRC" can only be performed with Dolby Digital sources.
- 2) If each audio sound track has the same number of channels, the system selects the audio sound tracks in the order from PCM, Dolby Digital, to MPEG audio.
- 3) When you set "TRACK SELECTION" to "AUTO," the language may change. The "TRACK SELECTION" setting has higher priority than the "AUDIO" settings in "LANGUAGE SETUP" (page 54). However, depending on the disc, this function may not be performed.

**Setting the system**  
— "SYSTEM SETUP"

---

**SCREEN SAVER**

The screen saver will help prevent your display device from becoming damaged (ghosting). Press any button (e.g., ►) to cancel the screen saver.

**ON:** The screen saver image appears if you do not operate the system for about 15 minutes.

**OFF:** The screen saver does not appear.

---

**BACKGROUND**

Sets the background color or picture to be displayed on the screen. The background color or picture is displayed when playback is stopped or while playing an AUDIO CD and MP3 files.

**JACKET PICTURE:** The jacket picture (still picture) appears in the background, but only when the jacket picture is already recorded on the disc (DVD VIDEO, CD-Extra, etc.). If the disc does not contain a jacket picture, the "GRAPHICS" picture appears.

**GRAPHICS:** A preset picture stored in the system appears in the background.

**BLUE:** The background color is blue.

**BLACK:** The background color is black.

---

---

## **PARENTAL CONTROL**

Sets the playback restrictions. For details, see “Restricting playback of the disc (PARENTAL CONTROL)” (page 51).

---

### **DivX**

(except for North American model)

Displays the registration code for this system.

For more information, go to <http://www.divx.com> on the Internet.

---

## **MULTI-DISC RESUME**

(DVD VIDEO and VIDEO CD only)

**ON:** Stores the resume playback point in the memory for up to 6 discs.

**OFF:** Does not store the resume playback point in the memory. Playback starts at the resume playback point only for the current disc in the system.

---

## **RESET**

Returns “SETUP” settings to the default settings. For details, see “To reset the “SETUP” settings in the Control Menu of CD/DVD function” (page 96).

---

## Tuner

### Listening to the radio

You can listen to a radio station either by automatic or manual tuning, or by selecting a preset station.

- 1 Select "Tuner" from the home menu, then press ENTER.
- 2 Press TUNER/BAND repeatedly to select the FM or AM band.
- 3 Press OPTIONS to bring up the Options menu.
- 4 Select the auto or manual tuning mode.  
Select "Tuning mode." → Press ENTER. → Select "AUTO" or "MANUAL." → Press ENTER.
- 5 Perform tuning.

#### For automatic scanning

Press +/-.

Scanning stops automatically when a station is tuned in and "TUNED" and "STEREO" (for stereo program only) appear.

If "TUNED" does not appear and the scanning does not stop while tuning in, press ■ and perform manual tuning.

#### For manual tuning:

Press +/- repeatedly until the frequency of the desired radio station appears.

#### Example: FM display



Frequency\*

\* If an FM station provides RDS services, the service name or station name appears below the displayed frequency (European model only).

#### For direct tuning:

Press D.TUNING, then use the numeric buttons to enter the frequency of the desired station. For example, press 1, 0, 2, 5 and 0 to enter the frequency of FM 102.50 MHz, then press ENTER. If you cannot tune in the station, make sure you have entered the right frequency. If you still cannot tune in the station, the frequency is not used in your area. To cancel direct tuning, press D.TUNING.

### Tip

You can also change the FM/AM tuner band from the Options menu. Press **OPTIONS** to bring up the Options menu after selecting "Tuner" from the home menu and follow the procedure below.

Select "BAND change." → Press **ENTER**. → Select "FM" or "AM." → Press **ENTER**.

## Presetting a radio station

- 1 Tune in the desired station.
- 2 Press **OPTIONS** to bring up the Options menu.
- 3 Press **▲** or **▼** repeatedly to select "Tuner Memory," then press **ENTER**.
- 4 Press **◀◀/▶▶** repeatedly (or press the numeric buttons) to select the desired preset number.
- 5 Press **ENTER**.  
The station is stored.  
If another station is already assigned to the selected preset number, the station is replaced by the new station.
- 6 Repeat steps 1 to 5 to store other stations.  
You can preset up to 20 FM stations and 10 AM stations.

## To listen to the preset radio station

- 1 Follow the procedure from step 1 to step 3 of "Listening to the radio" to select the "PRESET" tuning mode. Select "Tuning mode." → Press **ENTER**. → Select "PRESET." → Press **ENTER**.
- 2 Press **◀◀/▶▶** repeatedly (or the numeric buttons) to select the desired preset number.

### Tips

- When an FM stereo program has static noise, monaural reception mode may reduce the noise. You can select the monaural mode from Options menu. Press **OPTIONS** to bring up the Options menu while listening to FM stereo program, select "MONO" in the "FM mode" menu.
- To improve broadcast reception, adjust the supplied antennas, or connect an external antenna.

## Playing the iPod

You can enjoy audio, video and photo contents stored in your iPod with this system.

See “Compatible devices with this system” (page 110) for iPod models that can be connected to this system.

- 1 Place an iPod into the iPod Dock on the unit.

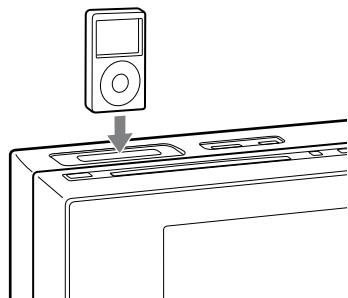

- 2 Select “iPod” from the home menu, then press ENTER.

- 3 Select “Music” or “Video,” then press ENTER.

When playing back a slideshow with photo contents on the iPod, select “Video,” then manually start playback of the slideshow on the iPod.

### Notes

- Confirm the output video signal setting (NTSC/PAL) on your iPod before connecting your iPod to the system.
- You cannot view pictures of the video content with “Music” content type. If you start playback of a video content with “Music” setting, only music data in the video content is played back.
- If you want to return to the home menu, press HOME. Note that ⏪ RETURN cannot be used while you play back a music or video content.

### Note for the iPod touch user

The video content from the iPod touch does not start automatically. Start playback of the video content manually on the iPod touch.

## Basic operations

To	Press
Resume playback when the playback is paused	▶.
Pause playback	⏸/■.
Scroll up/down the iPod menus	⬆/⬇. You can scroll up or down the iPod menus much like the Click Wheel operations of the iPod or the drag up-or-down operations of the iPod touch.
Select a track, chapter of audiobook/podcast, video file or photo file (image file)	⏪/▶▶. To fast-forward or fast-rewind, hold down the button.
Choose the selected item	➡/ENTER. You can choose the selected item much like the center button on the iPod or the touch operation of the iPod touch.
Find a point in a track, chapter of audiobook/podcast or video content	Hold down ◀◀/▶▶ during playback, and release the button at the desired point.
Return to the previous menu or select a menu	◀/iPod MENU. You can return to the previous menu or select a menu much like the Menu button on the iPod or the touch operation of the iPod touch.

## To use the system as a battery charger

You can use the system as a battery charger for the iPod when the system is on.

The charging begins when the iPod is placed on the iPod Dock. The charging status appears in the iPod display. For details, see the user's guide of your iPod.

## To stop charging the iPod

Remove the iPod. Turning off the system also stops charging the iPod.

### Note on charging the iPod

The system does not charge the iPod in the following cases even when the iPod is connected.

- When the system is off.
- When the auto standby function is enabled (page 97) and the system has entered standby mode.

## Notes

- When placing or removing the iPod, handle the iPod in the same angle as that of the iPod connector on the unit and do not twist or sway the iPod to prevent connector damage.
- Do not carry the unit with an iPod set on the connector. Doing so may cause a malfunction.
- When placing or removing the iPod, brace the unit with one hand and take care not to press the controls of the iPod by mistake.
- Depending on the connected iPod, operations may differ.
- It may take time to start playback depending on the contents.
- Before disconnecting the iPod, pause playback.
- To change the volume level, use VOLUME +/- (or VOL +/- on the unit). The volume level does not change even if adjusted on the iPod.
- Hold down **⏮/⏭** to fast-forward (fast-rewind) while playing video if **⏮/⏭** does not function.
- The iPod Dock on the unit is designed for iPod only. You cannot connect any other portable audio players.
- For details on iPod operation, refer to the user's guide of your iPod.
- Sony cannot accept responsibility in the event that data recorded to iPod is lost or damaged when using an iPod with this system.
- Because the operation of the system and the iPod are different, you may not operate the iPod using buttons on the remote or unit. In this case, use control buttons on the iPod.

## Changing the play mode

You can change the play mode during playback or play-paused status. The play mode can be selected only when you play back music contents.

- 1 Press **OPTIONS** to bring up the Options menu.
- 2 Press **▲/▼** repeatedly to select "Play mode," then press **ENTER**.
- 3 Press **▲/▼** repeatedly to select the desired setting.
  - Normal: The system plays all the tracks on the iPod.
  - Shuffle Tracks: The system plays all the tracks on the iPod in random order.
  - Shuffle Albums: The system plays the tracks in the multiple albums in random order.

#### 4 Press ENTER.

Playback starts or resumes in the selected play mode. To return to the playback screen, press  RETURN twice.

#### Note

Shuffle play is cancelled when:

- you remove the iPod.
- you turn off the system.

#### 4 Press ENTER.

Repeat play starts in the selected repeat play mode. To return to the playback screen, press  RETURN twice.

#### Note



Repeat play is cancelled when:



- you remove the iPod.
- you turn off the system.

## Changing the repeat play mode

You can change the repeat mode for the selected play mode during playback or play-paused status. The repeat mode can be selected only when you play back music contents.

1 Press **OPTIONS** to bring up the Options menu.

2 Press / repeatedly to select “Repeat,” then press **ENTER**.

3 Press / repeatedly to select the desired setting.

- **OFF:** Repeat play is off.
- **One Track:** The system plays the selected track repeatedly.
- **All Tracks:** The system plays all the tracks repeatedly in the selected play mode.



## USB Device/Memory Card

### Before using the USB device and the memory card with this system

You can use the USB device and the memory card with this system. Check the compatible devices that can be used with the system. For details, see “Compatible devices with this system” (page 110).

#### Notes on the USB device

- When USB cable connection is necessary, connect the USB device with a USB cable supplied with the device. See the operating instructions supplied with the USB device for details.
- Do not connect the system and the USB device through a USB hub.

#### Notes on using a memory card

- When using the memory card, make sure to insert the card in the correct orientation.
- When inserting the memory card, do not forcibly push it as this could damage the memory card and/or the system.
- When you carry or store a memory card, put it in the case supplied with the memory card.
- Do not touch the terminal of a card with your hand or a metal object.

#### Notes on using a USB device and memory card

- Do not remove the USB device or memory card during playback. Otherwise, data may be corrupted. Sony cannot accept responsibility in the event that recorded data is lost or damaged.
- We recommend that you back up important data on the USB device or memory card.
- It may take some time before “Reading” appears on the screen depending on the type of USB device or memory card.
- The system takes a certain time to display the folder list from when you select the “Music,” “Photo” or “Video” content type.
- Compatibility with all encoding software cannot be guaranteed. If audio and video files were encoded with incompatible software, those files may produce audio noise, interrupted audio, unsmooth motion of video, or may not play at all.
- This system cannot continue playback in the following cases.
  - When the number of files per folder exceeds 5,000.
  - When the number of folders on the USB device or memory card exceeds 1,000.
  - When the number of files on the USB device or memory card exceeds 5,000.These numbers may vary depending on a file and folder structure of your device. Do not save unnecessary folders and files to your device that has audio, video and image files to be played back with the system.

- Supported file formats are as follows:
  - MP3: file extension “.mp3”
  - WMA: file extension “.wma”
  - AAC: file extension “.m4a”
  - MPEG4: file extension “.mp4” or “.avi”
  - MPEG2/MPEG1: file extension “.mpg” or “.avi”
  - Motion JPEG: file extension “.avi”
  - JPEG: file extension “.jpg” or “.jpeg”





Note that even when file names have the above file extensions, if the actual files differ, the system cannot play those files, or playback problems occur even if you could play files. Especially, such audio files and audio data in video files may generate a loud noise which could damage the speaker system and the system may malfunction.

- The following situations can increase the time it takes to start playback:
  - files and folders recorded on the USB device or memory card with a complicated tree structure.
  - when the files in another folder have just been played back.
  - when you play back AAC files.
- Playback of MP3 files may take time depending on the encoding software used to create the MP3 files.
- The system can play back to a depth of 8 folders only.
- Resume play back is cancelled when you change the function.
- The system does not necessarily support all the functions of USB device or memory card.
- The playback order of files and folders for the system may differ from the original order of their creation on the USB device or memory card.
- Folders that have no MP3/WMA/AAC audio files, video files, JPEG image files are skipped during playback.

## To select the memory on the USB device

If the USB device has more than one memory (for example, internal memory and a memory card), you can select which memory to use and then start playback.

You cannot select a memory during playback. Make sure to select a memory before starting playback.

- 1 Connect the USB device to the  (USB) port.
- 2 Select “Settings” from the home menu, then press ENTER.
- 3 Press / repeatedly to select “USB Memory Select,” then press ENTER. The setting screen appears.
- 4 Press / repeatedly to select a memory number, then press ENTER.

## Playing a file on the USB device or memory card



You can play audio, video and image files stored on the USB device or memory card with this system.

Supported file formats are MP3\*/WMA\*/AAC\* for audio files, MPEG4\*/MPEG2/MPEG1/Motion JPEG for video files and JPEG for image files.

\* Files with DRM (Digital Rights Management) copyright protection cannot be played back on the system.

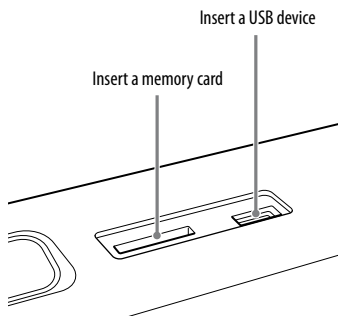

- 1 Connect a USB device to the  (USB) port, or insert a memory card to the multi memory card slot.

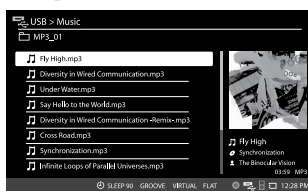

- 2 Select "USB" or "Memory Card" from the home menu, then press ENTER.
- 3 Select "Music," "Photo" or "Video," then press ENTER.  
The folder list appears.
- 4 Press  or  repeatedly to select a folder.
- 5 Press ENTER.  
Track list or file list appears.

Example: Track list of MP3 files



- 6 Press  or  repeatedly to select a desired file, then press ENTER.  
The system starts playback of the selected audio or video file. When selecting a JPEG image file, the slideshow starts from the selected image file.  
To stop playback or slideshow, press .

## To start the slideshow from the thumbnail view

You can switch to the thumbnail view from the file list (or vice-versa) by pressing the DISPLAY button, and start the slideshow from the selected image file.

- 1 Press DISPLAY while the file list of image files is displayed.  
Thumbnail pictures for first 18 JPEG image files in the selected folder are displayed. If there are more than 18 image files in the folder, the scroll bar appears at the right.

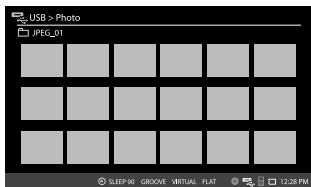

- 2 Press  $\uparrow/\downarrow/\leftarrow/\rightarrow$  repeatedly to select an image file, then press ENTER.  
The slideshow starts from the selected image file.  
If you want to return to the file list, press DISPLAY again while the thumbnail view is displayed.

## To specify the slideshow speed

(JPEG image files only)

- 1 Select "Settings" from the home menu, then press ENTER.
- 2 Select "Slideshow Interval," then press ENTER.  
The setting screen appears.

- 3 Press  $\uparrow/\downarrow$  repeatedly to select a desired transition interval.  
The default setting is "7 sec."  
If you want to turn off the slideshow function, select "OFF." Turning off the function allows you to display one picture at a time, and to manually display the previous or next image file using the  $\leftarrow/\rightarrow$  button.  
The slideshow speed may change depending on the selected transition effect (see below) or the file size of each image file stored on the USB device or memory card.

### Note

Some JPEG image files (especially progressive JPEG image files or JPEG image files with 3,000,000 pixels or more) may take a longer time to display than others, which may make the transitions seem longer than that of the option you selected.

## To select a transition effect for the slideshow

(JPEG image files only)

- 1 Select "Settings" from the home menu, then press ENTER.
- 2 Select "Transition Effect," then press ENTER.  
The setting screen appears.

- 3 Press  $\blacktriangle/\blacktriangledown$  repeatedly to select a desired transition effect.

The default setting is underlined.

- None: Turns off this function.
- Crossfade: Current image changes to the next image with fade in and out effect.
- Vert. Blinds: Current image changes to the next image with fade in and out effect, simulating a vertical blind for a window.
- Horiz. Blinds: Current image changes to the next image with fade in and out effect, simulating a horizontal blind for a window.
- Vert. Wipe: Next image wipes out the current image from top to bottom.
- Horiz. Wipe: Next image wipes out the current image from left to right.
- Mosaic: Image files in the selected folder are displayed as mosaic blocks.
- Random: The above effects are randomly applied to the slideshow playback.

### To select a display size of image on the screen

(JPEG image files only)

- 1 Select "Settings" from the home menu, then press ENTER.
- 2 Select "Fit," then press ENTER. The setting screen appears.

- 3 Press  $\blacktriangle/\blacktriangledown$  repeatedly to select a desired display size.

The default setting is underlined.

- Entire image: Enlarges an image in largest possible with the original aspect ratio and displays entire image. To fill the screen, margins at top and bottom or left and right are shown on the screen.
- Fit to screen: Stretches an image to fit the screen.

### Other operations

To	Do this
Play back audio or video files in a next folder	Press $\blacktriangleright\blacktriangleright$ repeatedly until reaching the last file of the current folder, then press $\blacktriangleright\blacktriangleright$ once. To select the previous folder, select the folder from the folder list.
Return to the folder list from the track/file list	Press $\curvearrowright$ RETURN.
Select a folder	Press $\text{Folder} +/ -$ repeatedly during playback, or when playback is paused or stopped.

### Tip

You can turn on or off the status bar during a playback of video file or slideshow by pressing DISPLAY.

Continued 

## To remove the USB device

- 1 Press **■** to stop playback.
- 2 Remove the USB device.

## To remove the memory card

- 1 Press **■** to stop playback.
- 2 Pull out the inserted memory card from the multi memory card slot.

## Changing the play mode

You can change the play mode during playback or play-paused status. Supported files for play modes are MP3/WMA/AAC audio files, JPEG image files and MPEG4/MPEG2/MPEG1/Motion JPEG video files stored on the USB device or the memory card.

- 1 Press **OPTIONS** to bring up the Options menu.
- 2 Press **▲** or **▼** repeatedly to select "Play mode," then press **ENTER**.

- 3 Press **▲** or **▼** repeatedly to select the desired setting.

- Normal: The system plays all the files on the USB device or the memory card in sequential order.
- Shuffle: The system plays all the files on the USB device or the memory card in random order.
- Folder: The system plays all the files in the selected folder on the USB device or the memory card in sequential order.
- Folder Shuffle: The system plays all the files in the selected folder on the USB device or the memory card in random order.

- 4 Press **ENTER**.

Playback starts or resumes in the selected play mode. To return to the playback screen, press **↶** RETURN twice.

### Note

The same song may be played back repeatedly for audio files.

## Changing the repeat play mode

You can change the repeat mode for the selected play mode during playback or play-paused.

Supported files for repeat play modes are MP3/WMA/AAC audio files, JPEG image files and MPEG4/MPEG2/MPEG1/Motion JPEG video files stored on the USB device or the memory card.

- 1 Press **OPTIONS** to bring up the Options menu.
- 2 Press **▲** or **▼** repeatedly to select "Repeat," then press **ENTER**.
- 3 Press **▲** or **▼** repeatedly to select the desired setting.
  - **OFF:** Repeat play is off.
  - **One Track:** The system plays the selected file repeatedly.
  - **All Tracks:** The system plays all the files repeatedly in the selected play mode.
- 4 Press **ENTER**.  
Repeat play starts in the selected repeat play mode. To return to the playback screen, press **↶** RETURN twice.

# Sound Adjustment

## Adjusting the sound

To	Do this
Reinforce the sound	Press GROOVE repeatedly. Each time you press the button, the display on the status bar changes as follows: GROOVE <sup>1)</sup> → Z-GROOVE <sup>1)</sup> → No display (GROOVE off) → GROOVE → ...
Select the preset sound effect	Press EQ repeatedly <sup>2)</sup> . Each time you press the button, the display on the status bar changes as follows: ROCK → POP → JAZZ → DANCE → SOUL → TECHNO → HIP HOP → FLAT...

<sup>1)</sup> The volume switches to power mode and the equalizer curve changes.

<sup>2)</sup> The Default setting is "ROCK."

### Tips

- You can also select the Groove setting from "Settings" in the home menu. Select "Settings" from the home menu and follow the procedure below.  
Select "Groove." → Press ENTER. → Select "OFF," "Groove" or "Z-Groove." → Press ENTER.
- You can also select the EQ setting from "Settings" in the home menu. Select "Settings" from the home menu and follow the procedure below.  
Select "EQ Setting" → Press ENTER. → Select a desired EQ Setting. → Press ENTER.

### Selecting the sound field

You can take advantage of the surround sound simply by selecting one of the sound fields. They bring the exciting and powerful sound of movie theaters into your home.

Press **SOUND FIELD** repeatedly.  
Each time you press the button, the sound field setting is changed as follows.



**When the headphones are not connected:**

---

**2CH STEREO**

The normal stereo sound field for all functions.

Reproduces stereo output from multi channel sources such as DVD VIDEOS during DVD function. The system outputs the original sound when the sound source is originally stereo sound (Audio CD, VIDEO CD, MP3 files and MPEG4 files on the DATA CD/DATA DVD, etc.).

---

**2CH SURROUND**

The sound field with surround effect for all functions.

Reproduces stereo output with surround effect from multi channel sources such as DVD function.

---

**VIRTUAL A\* (DVD function only)**

Creates 3 sets of virtual surround speakers from the sound of the front speakers. This sound field is only effective when you play back multi channel sources.

---

**VIRTUAL B\* (DVD function only)**

Creates 1 set of virtual surround speakers from the sound of the front speakers without using actual surround speakers. This mode is effective when the distance between the front speakers is short. This sound field is only effective when you play back multi channel sources.

---

**When the headphones are connected:**

---

**HP STEREO**

The normal sound field for headphones.

---

**HP SURROUND**

The sound field for headphones with surround effect.

---

**HP VIRTUAL\* (DVD function only)**

The sound field for headphones with virtual surround effect. This sound field is only effective when you play back multi channel sources.

---

\* These sound fields cannot be selected when the system is in standby mode.

**Note**

Depending on the disc, the surround effect may not be as much as expected.

## Selecting the MP3 Booster+ effect

You can enhance the sound quality of MP3, WMA or AAC audio files.

**1** Select "Settings" from the home menu, then press ENTER.

**2** Select "MP3 Booster+," then press ENTER.

The setting screen appears.

**3** Press  $\blacktriangle/\blacktriangledown$  repeatedly to select a desired setting, then press ENTER.

The default setting is underlined.

- AUTO: The MP3 Booster+ effect is automatically activated when starting playback.
- OFF: Turns off this function.

## Other Operations

### Enjoying simultaneous playback

You can enjoy simultaneous playback of sound and image data as a slideshow.

- 1 Prepare the sound source and start the music content or sound.  
**When using a CD-DA disc or MP3 disc as a sound source:**  
See “Playing a disc” (page 32).  
To start from a specific track, create your own program (page 46).  
**When using a USB device or memory card as a sound source:**  
See “Playing a file on the USB device or memory card” (page 67).  
**When using an iPod as a sound source:**  
See “Playing the iPod” (page 61).  
**When using a tuner reception as a sound source:**  
See “Listening to the radio” (page 59).  
**When using a connected optional component as a sound source:**  
See “Listening to a connected VCR or satellite tuner” (page 84).
- 2 Press **OPTIONS** to bring up the Options menu.
- 3 Select “Photo Select,” then press **ENTER**.

- 4 Select “USB,” “Memory Card” or “iPod” for an image playback source, then press **ENTER**.

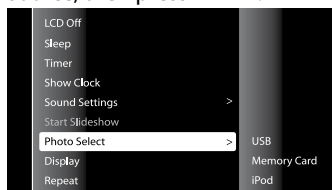

- 5 Select an image file and start the slideshow.

#### **When using a USB device or memory card as an image source:**

See “Playing a file on the USB device or memory card” (page 67).

#### **When using an iPod as an image source:**

See “Playing the iPod” (page 61). Note that you cannot select “iPod” for the image source when you are using the iPod as a music source.

## To play the same slideshow with music or sound

- 1 Confirm the preparation of the music or sound source. See step 1 of “Enjoying simultaneous playback.”
- 2 Press **OPTIONS** to bring up the Options menu.
- 3 Select “Start Slideshow,” then press **ENTER**.

### Note

Make sure to always start the music or sound first when enjoying simultaneous playback.

---

## Using the timers

The system offers two timer functions. If you use both timers, the Sleep Timer has priority.

### Sleep Timer

You can fall asleep to music. This function works even if the clock is not set.

- 1 Press **SLEEP**, then press **ENTER**.  
The setting screen appears.
- 2 Select the time you want, then press **ENTER**.
- 3 Select “**SET**,” then press **ENTER**.  
The system turns off on the preset time.

### Play Timer

The Play Timer can be set with the “CD/DVD,” “USB,” “iPod,” “Tuner” or “Memory Card” function.

Make sure you have set the clock.

- 1 Prepare the sound source.  
Prepare the sound source, and then press **VOLUME +/-** (or **VOL +/-** on the unit) to adjust the volume.
- 2 Select “Settings” from the home menu, then press **ENTER**.

- 3 Select “Timer,” then press ENTER. The setting screen appears.

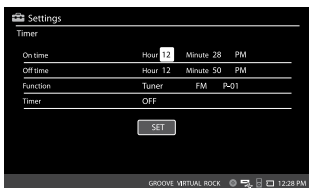

- 4 Set the Play Timer as follows.

#### “On time” and “Off time”

Set the start time and stop time. “AM”/“PM” can be selected only when you have selected the 12-hour time display format in the clock setting (page 30).

#### “Function”

Set the function for sound source. If you have selected tuner function, you can select the tuner band (“FM” or “AM”) and a preset number in each setting box accordingly.

#### “Timer”

Select “ON” to turn on the Play Timer.

- 5 Select “SET,” then press ENTER to enter the settings.

- 6 Press I/⏻ to turn off the system.

The system turns on 30 seconds before the preset time.

If the system is on at the preset time, the Play Timer will not be activated. Do not operate the system from the time the system turns on until the playback starts.

### To check the Play Timer setting

Display the “Timer” menu in the “Settings.” Current setting of the Play Timer is shown at right.

### To change the Play Timer setting

Start over from step 1.

### To cancel the Play Timer

Repeat the procedure and select “OFF” for “Timer” in step 4.

### Notes for the iPod user

- Make sure the iPod is not playing when using the Play Timer.
- The Play Timer may not be activated depending on the status of the connected iPod.

## Note

The Play Timer will not be activated if the system is turned on. Be sure to turn off the system at least 120 seconds before the preset time.

## Tips

- You can also set the Sleep Timer from “Settings” in the home menu. Select “Settings” from the home menu and follow the procedure below.  
Select “Sleep.” → Press ENTER. → Select the upper setting box. → Press ENTER. → Select a desired setting. → Press ENTER. → Select “SET.” → Press ENTER. To cancel the Sleep Timer, select “OFF” in the setting box.
- The Play Timer setting remains as long as the setting is not cancelled manually.

# Changing the display

## Viewing information about the playback source

You can view various information of playback source on the “TIME” display during playback when using the CD/DVD function. When playing back a CD-DA track on an AUDIO CD or an MP3 file on a DATA CD/DVD, you can also view information on the CD music playback screen. For details, see “Information display on the CD music playback screen” (page 79).

Press TIME/TEXT repeatedly.

Each time you press TIME/TEXT during playback, the display changes from ① → ② → ... → ① → ...

The time display that you can view on the screen depends on the playback source. If the CD music playback screen is displayed, make sure to press  DISPLAY repeatedly to call up the Control Menu (page 23) before pressing TIME/TEXT.

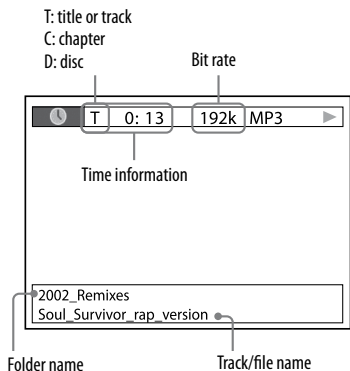

### When playing a DVD VIDEO or DVD-R/-RW in VR mode:

- ① Elapsed playing time of the current title
- ② Remaining time of the current title
- ③ Elapsed playing time of the current chapter
- ④ Remaining time of the current chapter
- ⑤ Elapsed playing time of the current title and disc title

### When playing a VIDEO CD with PBC function:

- ① Elapsed playing time of the current scene
- ② Elapsed playing time of the current scene and disc title

### When playing an AUDIO CD or VIDEO CD without PBC function:

- ① Elapsed playing time of the current track
- ② Remaining time of the current track
- ③ Elapsed playing time of the disc
- ④ Remaining time of the disc
- ⑤ Elapsed playing time of the current track and track name

### When playing MP3 files or video files on a DATA CD/DVD:

Elapsed playing time of the current file and folder/file name

### Information display on the CD music playback screen

You can also view information about a CD-DA track or MP3 file when the CD music playback screen is displayed, and a track is being played back or paused. Each time you press TIME/TEXT during an CD-DA track or MP3 file is being played back or paused, the display changes from ① → ② → ... → ① → ...

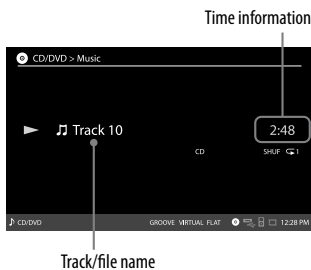

### When playing an AUDIO CD:

- ① Elapsed playing time of the current track
- ② Remaining time of the current track
- ③ Elapsed playing time of the disc
- ④ Remaining time of the disc
- ⑤ Track name

### When playing an MP3 file on a DATA CD/DVD:

Elapsed playing time of the current file and its file name

#### Notes

- For MP3 files with format other than ISO 9660 Level 1 and Level 2, folder name and file name may not be displayed.
- Only alphabet letters, numbers and some symbols can be displayed.
- Depending on the media, the system can only display a limited number of characters.

#### Tip

If an MP3 file has the ID3 tag, the system will display an album name or title name from the ID3 tag information. The system supports ID3 ver 1.0/1.1/2.2/2.3. ID3 ver 2.2/2.3 tag information display has priority when both ID3 ver 1.0/1.1 and ver 2.2/2.3 tags are used for a single MP3 file.

### Checking the date information of JPEG image files recorded on the disc

When “Exif”\* tag is recorded in the JPEG image files, you can check the date information in the Control Menu by pressing ( ) DISPLAY during playback.

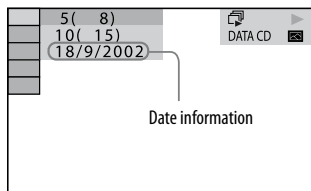

\* “Exchangeable Image File Format” is a digital camera image format defined by the “Japan Electronics & Information Technology Industries Association” (JEITA).

#### Note

The date information format varies depending on the area.



## Using the calendar and clock functions

You can use this system as a calendar or clock display, depending on your taste.

Select "Calendar/Clock" from the home menu, then press ENTER.

The calendar display appears on the screen.

You can select the calendar display or analogue clock display by pressing DISPLAY repeatedly.

When using the calendar display, you can advance a month to the previous or next month by pressing ◀/▶.

### Calendar



Sun	Mon	Tue	Wed	Thu	Fri	Sat
27	28	29	30	31	1	2
3	<u>4</u>	5	6	7	8	9
10	11	12	13	14	15	16
17	18	19	20	21	22	23
24	25	26	27	28	29	30
31	1	2	3	4	5	6

### Analogue clock



### To display the clock while playing back a content

- 1 Press OPTIONS during playback to bring up the Options menu.
- 2 Select "Show Clock," then press ENTER.

## Changing other settings

The following settings can be changed from the "Settings" menu in the home menu.

The default setting is underlined.

To	Do this
Change the LCD brightness	<ol style="list-style-type: none"><li>1 Select "Display Brightness," then press ENTER.</li><li>2 Select a desired setting, then press ENTER.<ul style="list-style-type: none"><li>• AUTO</li><li>• Low</li><li>• Mid</li><li>• <u>High</u></li></ul></li></ol>
Change the brightness of touch sensitive buttons on the unit	<ol style="list-style-type: none"><li>1 Select "Key Brightness," then press ENTER.</li><li>2 Select a desired setting, then press ENTER.<ul style="list-style-type: none"><li>• OFF</li><li>• Low</li><li>• Mid</li><li>• <u>High</u></li></ul></li></ol>

To	Do this
Change the Sony logo backlight	<ol style="list-style-type: none"><li>1 Select "Sony Logo Backlight," then press ENTER.</li><li>2 Select a desired setting, then press ENTER.<ul style="list-style-type: none"><li>• OFF</li><li>• <u>ON</u></li></ul></li></ol>
Change the beep sound	<ol style="list-style-type: none"><li>1 Select "Beep sound," then press ENTER.</li><li>2 Select a desired setting, then press ENTER.<ul style="list-style-type: none"><li>• OFF</li><li>• Low</li><li>• Mid</li><li>• <u>High</u></li></ul></li></ol>

## Setting a screen mode for the LCD screen

You can select a screen mode for pictures displayed on the LCD screen. This function is available when using the "CD/DVD," "iPod," "Video Input" or "SAT Input" function.

The default setting is underlined.

- 1 Press **OPTIONS** to bring up the Options menu while the pictures are displayed.
- 2 Press **▲/▼** repeatedly to select "Wide Mode," then press **ENTER**.

- 3 Press  $\uparrow/\downarrow$  repeatedly to select the desired setting, then press ENTER.
- **Full:** Select this when viewing pictures in 16:9-format. This setting displays pictures in full screen mode.
  - **Normal:** Select this when viewing pictures in 4:3-format. This setting displays pictures in normal screen mode with bands on the left and right portions of the screen.

#### Note

The selected screen mode may not be effective if the screen mode is fixed, as a priority setting, on the source pictures.

## Hooking up optional components

To enhance your system, you can connect optional components. Refer to the operating instructions provided with each component.

If you purchased WHG-SLK2i and installed the system on the wall, please be aware that the connections should be made before installation. For details, refer to the separate leaflet "Installing the system on the wall."

#### Rear panel

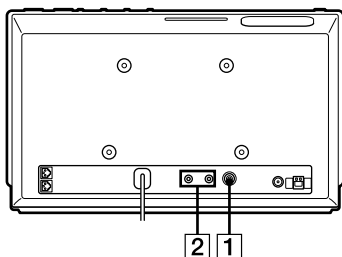

#### 1 DVD VIDEO OUT jack

Connect the video input jack of the TV or projector.

## Notes

- Video output is available only when you are using the CD/DVD function and the inserted disc contains motion picture or still image data.
- You cannot view video contents stored in an iPod, USB device or memory card on the connected TV screen. Video contents on those devices can be viewed only on the LCD screen.

## 2 VIDEO/SAT AUDIO IN jack, VIDEO/SAT VIDEO IN jack

Connect the audio and video output jacks of an optional component (such as VCR or satellite tuner).

## Listening to a connected VCR or satellite tuner

- 1 Select "Video Input" or "SAT Input" from the home menu, then press ENTER.
- 2 Start playing the connected component.

## To switch between the "Video Input" and "SAT Input" function

- 1 Select "Settings" from the home menu, then press ENTER.
- 2 Select "External Video source," then press ENTER.  
The setting screen appears.
- 3 Press  $\blacktriangle/\blacktriangledown$  repeatedly to select "Video" or "Satellite," then press ENTER.

### Note

If the sound is distorted or too loud when "Video" is selected, change the function to "Satellite."

### Tip

The icon name on the home menu changes to "Video Input" or "SAT Input" depending on the "External Video source" setting.

### Troubleshooting

Should you encounter a problem with your system, do the following:

- 1 Make sure the power cord and speaker cords are connected correctly and firmly.
- 2 Find your problem in the troubleshooting checklist below and take the indicated corrective action.
- 3 If the system still does not operate properly, reset the system (page 95, 96).

If the problem persists after doing all of the above, consult your nearest Sony dealer.

#### If the STANDBY indicator flashes

Immediately unplug the power cord, and check the following items.

- Are you using only the supplied speakers?
- Is anything blocking the ventilation hole on the rear of the system?

After the STANDBY indicator stops flashing, reconnect the power cord, and turn on the system. If the issue persists, contact your nearest Sony dealer.

### General

**The images with Sony illumination appear after you connect the power cord, even though you have not turned on the system.**

- Turn off the automatic demonstration (page 25).

**The system does not turn on.**

- Is the power cord plugged in?

**It takes some time for the home menu screen to appear when you turn on the system.**

- This is not a malfunction. The system takes a certain time for readying and displaying the home menu when you turn on the system. Wait for a while and do not attempt to press **I/⏻** again as the system will already be in the process to display the home menu.

**The system has entered standby mode unexpectedly.**

- This is not a malfunction. The system enters standby mode automatically after about 30 minutes when there is no operation, or when playback ends on the connected device. See “To turn off the automatic standby function” (page 97).

**The clock or timer setting is cancelled.**

- The power cord is disconnected or a power failure occurred. Redo “Setting the clock” (page 30). If you have set the timer, redo “Using the timers” (page 76).

**There is no sound.**

- Press VOLUME + (or VOL + on the unit) repeatedly.
- The headphones are connected to the PHONES jack.
- Check the speaker connections (page 24).
- The system is in pause mode, in Slow-motion Play or in Lock Search. Press ► to start the playback.

**There is severe hum or noise.**

- A TV or VCR is placed too close to the unit. Move the unit away from the TV or VCR.
- Move the unit away from the source of noise.
- Install a noise filter (commercially available) to the power cord.

**The timer does not function.**

- Check the timer setting and set the correct time (page 76).
- Cancel the Sleep Timer function.

**The remote does not function.**

- Remove the obstacles between the remote and the unit.
- Move the remote closer to the unit.
- Point the remote at the unit's sensor.
- Replace the batteries (R6/size AA).
- Locate the unit away from the fluorescent light.

**There is acoustic feedback.**

- Reduce the volume.

### **The sound from the component connected to the VIDEO/AUDIO IN jacks is distorted.**

- If “Video Input” is displayed on the home menu, switch the mode to “Satellite” (see “To switch between the “Video Input” and “SAT Input” function” (page 84)).

### **“Over Current!” appears.**

- A problem has been detected with the level of electrical current from the iPod connector,  (USB) port or memory card terminal on the unit. Turn off the system and remove the iPod, USB device or memory card from the system. Make sure there is no problem with these devices. If this display pattern persists, contact your nearest Sony dealer.

## **Speakers**

---

### **Sound comes from one channel or unbalanced left and right volume.**

- Place the speakers as symmetrically as possible.
- Check that the speakers are connected securely and correctly.
- The source being played back is monaural.

## **Disc Player**

---

### **The system does not eject the disc and “LOCKED” appears.**

- Consult your nearest Sony dealer or local authorized Sony service facility.

### **Playback does not start.**

- Check whether a disc is loaded.
- Wipe the disc clean (page 100).
- Reload the disc.
- Load the disc that this system can play back (page 9, 32).
- Remove the disc and wipe away the moisture on the disc, then leave the system turned on for a few hours until the moisture evaporates.
- Press  to start playback.
- The region code on the DVD VIDEO does not match the system.

### **The sound skips.**

- Wipe the disc clean (page 100).
- Reload the disc.
- Move the unit to a place without vibrations (e.g., on top of a stable stand).
- Move the speakers away from the unit, or place them on separate stands. When you listen to a track or file with bass sounds at high volume, the speaker vibration may cause the sound to skip.

**Playback does not start from the first track.**

- Shuffle Play mode, Program Play mode or Repeat Play mode is selected.
- Resume playback has been selected. Press ■ twice. Then, press ► to start playback.
- The title of DVD VIDEO or PBC menu of VIDEO CD automatically appears on the screen.

**Playback stops automatically.**

- Some discs may contain an auto pause signal. While playing such a disc, the playback stops at auto pause signal.

**You cannot perform some functions such as Stop, Lock Search, Slow-motion Play, Repeat Play, Shuffle Play or Program Play.**

- Depending on the disc, you may not be able to do some of the operations above. Refer to the operating instructions supplied with the disc.

**The DATA CD/DVD (MP3 file/JPEG image file/DivX video file/MPEG4 video file) cannot be played back.**

- The DATA CD is not recorded in a format that conforms to ISO 9660 Level 1, Level 2, or Joliet (expansion format).

- The DATA DVD is not recorded in a format that conforms to UDF (Universal Disk Format).
- The MP3 file does not have the extension “.mp3”.
- The data is not stored in the desired format.
- The audio file is not stored in MP3 (MPEG 1 Audio Layer 3) format.
- The system can play back to a depth of 8 folders only.
- The disc contains more than 200 folders.
- The folder contains more than 150 files.
- The JPEG image file does not have the extension “.jpg” or “.jpeg”.
- The JPEG image file is larger than 3,072 (width) × 2,048 (height) pixels in normal mode, or more than 2,000,000 pixels in Progressive JPEG mode, which is mainly used on the Internet website.
- The MPEG4 video file does not have the extension “.mp4” or “.m4v”.
- The DivX video file does not have the extension “.avi” or “.divx”.
- DivX and MPEG4 video files cannot be played back on the North American model.
- The video file is larger than 720 (width) × 576 (height) pixels.



- If you cannot change the “MEDIA” setting, re-load the disc or turn the system off, then on.

### **The MP3 files take longer time to play back than others.**

- After the system reads all the MP3 files on the disc, playback may take more time than usual if:
  - the number of folders or MP3 files on the disc is very large.
  - the file structure is extremely complex.

### **“Data Error” appears on the screen when playing a DATA CD/DVD.**

- The MP3 file/JPEG image file you want to play is broken.
- The MP3 file does not conform to MPEG 1 Audio Layer 3.
- The JPEG image file format does not conform to DCF.
- The JPEG image file has the extension “.jpg” or “.jpeg”, but is not in JPEG format.
- The DivX video file has the extension “.avi” or “.divx”, but is not in DivX format.
- The DivX video file does not conform to a DivX Certified profile.
- The MPEG4 video file has the extension “.mp4” or “.m4v”, but does not conform to MPEG4 Simple Profile.

### **The disc title, CD-TEXT and DVD-TEXT characters do not appear properly.**

- The disc is recorded in format other than ISO 9660 Level 1, Level 2 or Joliet (expansion).
- The character code that can be displayed by this system are as follows:
  - Upper cases (A to Z)
  - Numbers (0 to 9)
  - Symbols (< > \* + , ? / [ ] \ \_)
 Other characters appear as “\_”.

### **The surround effect is difficult to hear when you are playing a Dolby Digital or MPEG audio sound track.**

- Make sure the sound field is set properly (page 72).
- Check the speaker connection (page 24).
- Depending on the DVD VIDEO, the output signal may not be the entire 5.1 channel. It may be monaural or stereo, even if the sound track is recorded in Dolby Digital or MPEG audio format.

### **The sound loses stereo effect when you play back a DVD VIDEO, VIDEO CD, AUDIO CD, MP3 file or video file.**

- Make sure the system is connected properly.
- Check the speaker connection (page 24).

## iPod

---

### **There is no sound.**

- Make sure the iPod is connected securely.
- Make sure the iPod is updated with the latest software. If not, update the iPod before using with the system.
- Make sure the iPod is playing music.
- Adjust the volume.
- It may take time to start playback depending on the contents.

### **The sound is distorted.**

- Make sure the iPod is connected securely.
- Turn down the volume.
- Set the “EQ” setting of the iPod to “Off” or “Flat.”

### **The iPod does not function.**

- Make sure the iPod is connected securely.
- Make sure the iPod is updated with the latest software. If not, update the iPod before using with the system.
- Because operation of the system and the iPod are different, you may not operate the iPod using buttons on the remote or unit. In this case, use control buttons on the iPod.
- Check if your iPod is compatible with this system (page 112).

### **The iPod cannot be charged.**

- Make sure the iPod is connected securely.
- You can use the system as a battery charger for iPod only when the system is on.
- The system is in standby status with the automatic standby function. Turn off the automatic standby function (page 97).

### **Video/photo image from the iPod does not appear on the LCD screen.**

- Make sure the iPod is connected securely.
- Check that the TV output setting on the iPod is on. (Refer to the user's guide of your iPod.)
- Check that the iPod is compatible with the video output. (Refer to the user's guide of your iPod.)

### **Video/photo image from the iPod does not appear on the iPod display.**

- Make sure the iPod is connected securely.
- Adjust the video/photo image output settings to the appropriate settings.

## USB device/Memory card

---

### Are you using a supported USB device or memory card?

- If you use an unsupported USB device or memory card, the following problems may occur. See “Compatible devices with this system” (page 110) for the supported device types.
  - USB device or memory card is not recognized.
  - File or folder names are not displayed on this system.
  - Playback is not possible.
  - The sound skips.
  - There is noise.
  - A distorted sound is output.

### There is no sound.

- The USB device is not connected correctly. Turn off the system and reconnect the USB device, then turn on the system again.
- The memory card is not inserted correctly. Turn off the system and reinsert the memory card, then turn on the system again.

### There is noise, skipping, or distorted sound.

- Turn off the system, then reconnect the USB device.
- Turn off the system, then reinsert the memory card.
- The music data itself contains noise, or the sound is distorted. Noise may have entered when creating music data due to the conditions of the computer. Create the music data again.
- The bitrate used when encoding audio files was low. Send audio files with higher bit rate to the USB device or the memory card.

### The USB device cannot be connected into the (USB) port.

- The USB device is being connected backwards. Connect the USB device in the correct orientation.

### The memory card cannot be inserted into the multi memory card slot on the unit.

- The memory card is being inserted backwards. Insert the memory card in the correct orientation.

**“Reading” is displayed for an extended time, or it takes a long time before playback starts.**

- The reading process can take a long time in the following cases.
    - There are many folders or files on the USB device or the memory card.
    - The file structure is extremely complex.
    - The memory capacity is excessive.
    - The file size is extremely large.
    - The internal memory is fragmented.
- Thus, we recommend following these guidelines.
- Total folders on the USB device or the memory card: 200 or less
  - Total files per folder: 150 or less

**Erroneous display**

- Send the music data to the USB device or the memory card again, as the stored data may have been corrupted.
- Character codes that can be displayed by this system are as follows:
  - Upper cases (A to Z)
  - Numbers (0 to 9)
  - Symbols (< > \* + , ? / [ ] \ \_)Other characters appear as “\_”.

**The USB device or the memory card is not recognized.**

- The USB device is not connected correctly. Turn off the system and reconnect the USB device, then turn on the system again.
- The memory card is not inserted correctly. Turn off the system and reinsert the memory card, then turn on the system again.
- See “Compatible devices with this system” (page 110) for the supported device types.
- The USB device or the memory card does not work properly. Refer to the operating instructions supplied with the USB device or the memory card for how to deal with this problem. If the problem persists, contact your nearest Sony dealer.

**“Data Error” appears on the screen when playing a file on the USB device or the memory card.**

- The file on the USB device or the memory card is not playable.

**Play does not start.**

- The USB device is not connected correctly. Turn off the system and reconnect the USB device, then turn on the system again.

- The memory card is not inserted correctly. Turn off the system and reinsert the memory card, then turn on the system again.
- See “Compatible devices with this system” (page 110) for the supported device types.
- Press ► to start playback.

### **Play does not start from the first track.**

- Set the play mode to normal play mode.

### **Files cannot be played back.**

- The MP3 file does not have the extension “.mp3”.
- The WMA file does not have the extension “.wma”.
- The AAC file does not have the extension “.m4a”.
- The MPEG4 file does not have the extension “.mp4” or “.avi”.
- The MPEG2/MPEG1 file does not have the extension “.mpg” or “.avi”.
- The Motion JPEG file does not have the extension “.avi”.
- The audio file is not stored in MP3/WMA/AAC format.
- The video file is not stored in MPEG4/MPEG2/MPEG1/Motion JPEG format.

- The JPEG image file does not have the extension “.jpg” or “.jpeg”.
- The JPEG image file is larger than 3,072 (width) × 2,048 (height) pixels in normal mode, or more than 2,000,000 pixels in Progressive JPEG mode which is mainly used on the Internet website.
- USB devices or memory cards formatted with file systems other than FAT16 or FAT32 are unsupported.\*
- The WMA file stored in WMA DRM/WMA Lossless/WMA PRO format cannot be played back.
- The AAC file stored in copyright-protected AAC or AAC Lossless format cannot be played back.
- AAC files encoded at a sampling frequency of 96 kHz cannot be played back.
- If you use a partitioned USB device, only files on the first partition can be played.
- The system can play back to a depth of 8 folders only.
- The number of folders has exceeded 200.
- The number of files has exceeded 150.
- Files that are encrypted or protected by passwords, etc. cannot be played back.

\* This system supports FAT16 and FAT32, but some USB devices may not support all of these FAT. For details, see the operating instructions of each USB device or contact the manufacturer.

## Picture

---

### **There is no picture on the TV screen.**

- Check that the system is connected securely.
- The video cord is damaged. Replace it with a new one.
- Make sure you connect the unit to the video input jack of your TV (page 83).
- Make sure you turn on the TV and operate the TV correctly.
- Make sure you select the video input on the TV so that you can view the pictures from the system.
- Make sure you set the color system correctly, according to your TV's color system (page 27).
- You cannot view the pictures from the optional component which connected to the VIDEO/SAT VIDEO IN jack on the unit.

### **Picture noise appears on the TV screen.**

- Wipe the disc clean (page 100).
- If video signal from your system has to go through your VCR to your TV, the copy-protection applied to some DVD VIDEO programs could affect the picture quality.
- When you play back a VIDEO CD recorded in a different color system from the one you set to the system, the picture image may be distorted (page 56).
- Set the color system to match your TV (page 27).

### **The aspect ratio of the TV screen cannot be changed even though you can set "TV TYPE" under "VIDEO SETUP" in the Setup Menu when you play back a wide picture.**

- The aspect ratio is fixed on your DVD VIDEO.
- Depending on the TV, you may not change the aspect ratio.

### **Messages do not appear on the screen in your desired language.**

- When using the CD/DVD function, select the language for the on-screen display in "OSD" under "LANGUAGE SETUP" in the Setup Menu (page 29, 54).
- When using a function other than CD/DVD function, select the language for the home menu (page 30).

### **The language for the sound track cannot be changed.**

- Multilingual tracks are not recorded on the DVD VIDEO being played back.
- The DVD VIDEO prohibits changing the language for the sound track.

### **The subtitles language cannot be changed.**

- Multilingual subtitles are not recorded on the DVD VIDEO being played back.
- The DVD VIDEO prohibits changing the subtitles.

### **The subtitles cannot be turned off.**

- The DVD VIDEO prohibits turning off subtitles.

### **The angles cannot be changed.**

- Multi-angles are not recorded on the DVD VIDEO being played back.
- The DVD VIDEO prohibits changing the angles.

## **Tuner**

---

### **There is severe hum or noise. ("TUNED" or "STEREO" flashes on the screen.)**

- Set the proper band and frequency (page 59).
- Connect the antenna properly (page 24).
- Find a place and an orientation that provide good reception, then set up the antenna again. If you cannot obtain good reception, we recommend that you connect a commercially available external antenna.
- The supplied FM lead antenna receives signals along its entire length, so make sure you extend it fully.
- Locate the antennas as far away from the speaker cords and the power cord as possible, to avoid picking up noise.
- Try turning off the surrounding electrical equipment.

### **A stereo FM program cannot be received in stereo, or stereo FM program has static noise.**

- Change the FM tuning mode from stereo to monaural (page 60).

## **Optional components**

---













### **There is no sound.**

- Refer to General item "There is no sound." (page 86) and check the condition of the system.
- Connect the component properly (page 83) while checking:
  - if the cords are connected properly.
  - if the cord plugs are firmly inserted all the way.
- Turn on the connected component.
- Refer to the operating instructions supplied with the connected component and start playback.

### **To reset the settings in the home menu**

- 1 Select "Settings" from the home menu, then press ENTER.
- 2 Select "Reset All settings," then press ENTER.  
The setting screen appears.
- 3 Select "Yes," then press ENTER.  
All the settings are reset and returned to the default settings.
- 4 Press I/⏻ to turn on the system.

## To reset the "SETUP" settings in the Control Menu of CD/DVD function

- 1 Press  DISPLAY when playback is stopped.  
The Control Menu appears.
- 2 Press  or  repeatedly to select  (SETUP), then press ENTER.
- 3 Press  or  repeatedly to select "CUSTOM," then press ENTER.  
The Setup Menu appears.
- 4 Press  or  repeatedly to select "SYSTEM SETUP," then press ENTER.
- 5 Press  or  repeatedly to select "RESET," then press ENTER.
- 6 Press  or  repeatedly to select "YES," then press ENTER.  
The "SETUP" settings are reset to the default settings except for "PARENTAL CONTROL" settings (page 51). Do not press  while resetting. Resetting takes a few minutes to complete.

### Note

"MEDIA," "INTERVAL" and "EFFECT" settings also return to the default settings.

## Self-diagnosis function

(When letters/numbers appear on the screen)

When the self-diagnosis function is activated to prevent the system from malfunctioning, a 5-character service number (e.g. C 13 50) with a combination of a letter and 4 digits appears on the screen. In this case, check the following table.

First 3 characters of the service number	Cause and corrective action
--	-----------------------------

C 13	This disc is dirty. <ul style="list-style-type: none"><li>• Clean the disc with a soft cloth (page 100).</li></ul>
C 31	The disc is not inserted correctly. <ul style="list-style-type: none"><li>• Restart the system, then re-insert the disc correctly.</li></ul>



### To change the AM tuning interval (except for European and Saudi Arabian models)

The AM tuning interval is factory-preset to 9 kHz (or 10 kHz for some areas).

Follow the steps below when you change the AM tuning interval. Note that all the AM preset stations are erased when you change the AM tuning interval.

- 1 Select "Settings" from the home menu, then press ENTER.
- 2 Select "AM Step change," then press ENTER.  
The setting screen appears.
- 3 Press  $\blacktriangle/\blacktriangledown$  repeatedly to select "9 kHz" or "10 kHz," then press ENTER.

### To turn off the automatic standby function

This system is equipped with an automatic standby function. With this function, the system enters standby mode automatically after about 30 minutes when there is no operation, or when playback ends on the connected device. By default, the automatic standby function is turned on.

You can turn off the automatic standby mode from the home menu.

- 1 Select "Settings" from the home menu, then press ENTER.
- 2 Select "Auto Standby," then press ENTER.  
The setting screen appears.
- 3 Press  $\blacktriangle/\blacktriangledown$  repeatedly to select "OFF," then press ENTER.  
To turn on the function, repeat the procedure and select "ON" for "Auto Standby."

## Notes

- The automatic standby function is invalid for the “iPod,” “Tuner,” “Video Input,” “SAT Input” and “Calendar/Clock” functions, even when you have enabled it.
- The system may not enter standby mode automatically in the following cases;
  - when an iPod or USB device is connected.
  - during playback of audio tracks or files.
  - while the preset Play Timer or Sleep Timer is in process.

## Tip

The system enters standby mode automatically when playback of music stops while enjoying a slideshow.

## Messages

One of the following messages may appear or flash on the screen during operation.

### Cannot Play

- A disc that cannot be played back was inserted.
- A DVD VIDEO with unsupported region code was inserted.

### Complete!

The radio preset operation ended normally.

### Data Error

You tried to play a file on the USB device or the memory card that is not playable.

### Data Error (for DATA CD/DVDs)

- The MP3 file, JPEG image file, DivX video file and MPEG4 video file you want to play back is damaged.
- The MP3 file does not conform to MPEG 1 Audio Layer 3 format.
- The JPEG image file does not conform to DCF format.
- The MP3 file has the extension “.mp3”, but is not in MP3 format.
- The JPEG image file has the extension “.jpg” or “.jpeg”, but is not in JPEG format.

- The DivX video file does not conform to DivX Certified profiles.
- The DivX video file has the extension “.avi” or “.divx”, but is not in DivX format.
- The MPEG4 video file has the extension “.mp4” or “.m4v”, but does not conform to MPEG4 Simple Profile.

#### **Device Error**

- The connected USB device could not be recognized or an unknown device is connected.
- The inserted memory card could not be recognized or a unknown memory card is inserted.

#### **No Audio**

There is no audio file in the selected folder.

#### **No Data**

- There is no file or folder to play back.
- There is no playable track on the DATA DVD.

#### **No Device**

No USB device or iPod is connected.

#### **No Disc**

There is no disc in the player, or you have loaded a disc that cannot be played back.

#### **No Memory**

The memory card is not inserted.

#### **Not in Use**

You have pressed a button whose operation is not allowed or invalid at that time.

#### **OFF TIME NG!**

The on time and off time of Play Timer is the same.

#### **Over Current!**

An over current from the iPod connector,  (USB) port or memory card terminal was detected. See ““Over Current!” appears.” (page 87).

#### **Please Wait**

The system is doing initialization process.

#### **Reading**

- The system is reading information from the disc, USB device or memory card. Some buttons are not available.
- The system is recognizing the USB device or memory card.

#### **SET CLOCK!**

You tried to select the timer when the clock is not set.

---

## Precautions

### Notes on discs

- Before playing, wipe the disc with a cleaning cloth from the center out to the edge.
- Do not clean discs with solvents, such as benzene, thinner, or commercially available cleaners or anti-static spray intended for vinyl LPs.
- Do not expose discs to direct sunlight or heat sources such as hot air ducts, nor leave it in a car parked in direct sunlight.

### Region code of DVD VIDEOS you can play back on this system

Your system has a region code printed on the back of the unit and will only play back DVD VIDEOS labeled with identical region code.

DVD VIDEOS labeled  will also be played back on this system.

If you try to play back any other region code DVD VIDEO, the message "Playback prohibited by area limitations." will appear on the TV screen. Depending on the DVD VIDEO, no region code indication may be labeled even though playing the DVD VIDEO is prohibited by area restrictions.

### Note on DualDiscs

A DualDisc is a two sided disc product which mates DVD recorded material on one side with digital audio material on the other side. However, since the audio material side does not conform to the Compact Disc (CD) standard, playback on this product is not guaranteed.

### Notes on CD-R/-RW and DVD-R/-RW/+R/+RW

- In some cases, CD-Rs/-RWs and DVD-Rs/-RWs/+Rs/+RWs cannot be played back on this system due to the recording quality or physical condition of the disc, or the characteristics of the recording device and authoring software. The disc will not be played back if it has not been correctly finalized. For more information, see the operating instructions for the recording device.
- Please be aware that some playback functions may not work with some DVD+Rs/+RWs, even if they have been correctly finalized. In this case, view the disc by normal playback.
- A disc created in Packet Write format cannot be played back.
- Please be aware that DivX video files or MPEG4 video files cannot be played back on the North American model even if they are present on multi session discs.

**Note on playback operations of DVD VIDEOS and VIDEO CDs**

Some playback operations of DVD VIDEOS and VIDEO CDs may be intentionally set by software producers. Since this system play back DVD VIDEOS and VIDEO CDs according to the disc contents the software producers designed, some playback features may not be available. Also, refer to the instructions supplied with the DVD VIDEOS or VIDEO CDs.

**Music discs encoded with copyright protection technologies**

This product is designed to play back discs that conform to the Compact Disc (CD) standard. Recently, various music discs encoded with copyright protection technologies are marketed by some record companies. Please be aware that among those discs, there are some that do not conform to the CD standard and may not be playable by this product.

**Notes on multi session disc**

- If the first session is recorded in AUDIO CD or VIDEO CD format, only the first session will be played back.
- The system will recognize a multi session disc as an AUDIO CD if there is a session recorded in AUDIO CD format on the disc. However, the system will only play back the disc if the first session is recorded in AUDIO CD format.

- This system can play back multi session discs when an MP3 file, a JPEG image file, a DivX video file or an MPEG4 video file is contained in the first session. Any subsequent MP3 files, JPEG image files, DivX video files or MPEG4 video files recorded in later sessions can also be played back.
- Please be aware that DivX video files or MPEG4 video files cannot be played back on the North American model even if they are present on multi session discs.

**Note on copyright-protected content**

The transferred music is limited to private use only. Use of the music beyond this limit requires permission of the copyright holders.

**On cleaning discs, disc/lens cleaner**

Do not use a commercially available cleaning disc or disc/lens cleaner (wet or spray type). These may cause apparatus to malfunction.

### **Notes on using a memory card**

- Do not strike, bend or drop a memory card.
- Do not disassemble or modify a memory card.
- Do not expose a memory card to water.
- Do not use or store a memory card under the following conditions;
  - Locations beyond the required operational conditions including locations such as the hot interior of a car parked in the sun and/or in the summer, the outdoors exposed to direct sunlight, or a place near a heater
  - Humid locations or locations with corrosive substances present
  - Locations subject to static electricity or electrical noises

### **On safety**

- Completely disconnect the power cord (mains lead) from the wall outlet (mains) if it is not going to be used for an extended period of time. When unplugging the unit, always grip the plug. Never pull the cord itself.
- Should any solid object or liquid get into the system, unplug the system, and have it checked by qualified personnel before operating it again.

### **On placement**

- Do not place the system in an inclined position or in locations that are extremely hot, cold, dusty, dirty, or humid or lacking adequate ventilation, or subject to vibration, direct sunlight or a bright light.
- Be careful when placing the unit or speakers on surfaces that have been specially treated (for example, with wax, oil, polish) as staining or discoloration of the surface may result.
- If the system is brought directly from a cold to a warm location or is placed in a very damp room, moisture may condense on the lens inside the DVD player, and cause the system to malfunction. In this situation, remove the disc, and leave the system turned on for about an hour until the moisture evaporates.

### **On heat buildup**

- Heat buildup on the unit during operation is normal and is not cause for alarm.
- Do not touch the cabinet if it has been used continuously at a high volume because the cabinet may have become hot.
- Do not obstruct the ventilation holes.

### Notes on LCD screen

- The displayed image on the screen is not identical in picture quality and colors with the printed image because phosphor methods or profiles differ. Please regard the displayed image as just a reference.
- Do not press against the LCD screen. The screen may be discolored and that may cause a malfunction.
- Exposing the LCD screen to direct sunlight for long periods may cause malfunctions.
- The LCD screen is manufactured using extremely high-precision technology, so over 99.99% of the pixels are operational for effective use. However, there may be some tiny black points and/or bright points (white, red, blue or green in color) that constantly appear on the LCD screen. These points are normal in the manufacturing process and do not affect the printing in any way.
- Images may trail across on the LCD screen in a cold location. This is not a malfunction.

### On the speaker system

This speaker system is not magnetically shielded, and the picture on nearby TV sets may become magnetically distorted. In this situation, turn off the TV, wait 15 to 30 minutes, and turn it back on. If there is no improvement, move the speakers far away from the TV.

#### IMPORTANT NOTICE

**Caution:** If you leave a still video image or on-screen display image displayed on your TV for an extended period of time via this system, you risk permanent damage to your TV screen. Projection TVs are especially susceptible to this.

### Cleaning the cabinet

- Clean this system with a soft cloth slightly moistened with a mild detergent solution. Do not use any type of abrasive pads, scouring powder, or solvents, such as thinner, benzine, or alcohol.
- Wipe off fingerprints and smudges on the unit with a soft dry cloth or a soft cloth slightly moistened with a mild detergent solution.

# Specifications

## Main unit

AUDIO POWER SPECIFICATIONS  
POWER OUTPUT AND TOTAL  
HARMONIC DISTORTION:

(WHG-SLK1i The United States model only)

With 8 ohm loads, both channels driven, from 120 — 10,000 Hz; rated 35 watts per channel minimum RMS power, with no more than 1% total harmonic distortion from 800 milliwatts to rated output.

## Amplifier section

The following measured at AC 120 V, 60 Hz (North American model)

The following measured at AC 127 V, 60 Hz (Mexican model)

The following measured at AC 127 V — 240 V, 60 Hz (Brazilian model)

The following measured at AC 220 V — 240 V, 50/60 Hz (European, Korean, Argentine, Thai and Australian models)

The following measured at AC 120 V — 240 V, 50/60 Hz (Other models)

## WHG-SLK2i

Brazilian model:

Power output (rated):

85 W + 85 W (at 6  $\Omega$ , 1 kHz,  
1% THD)

RMS output power (reference):

100 W + 100 W (per channel at 6  $\Omega$ ,  
1 kHz, 10% THD)

Other models:

Power output (rated):

85 W + 85 W (at 6  $\Omega$ , 1 kHz,  
1% THD)

RMS output power (reference):

120 W + 120 W (per channel at 6  $\Omega$ ,  
1 kHz)

## WHG-SLK1i

The United States model:

RMS output power (reference):

65 W + 65 W (per channel at 8  $\Omega$ ,  
1 kHz)

Other models:

Power output (rated):

40 W + 40 W (at 8  $\Omega$ , 1 kHz,  
1% THD)

RMS output power (reference):

65 W + 65 W (per channel at 8  $\Omega$ ,  
1 kHz)

## Inputs

VIDEO/SAT VIDEO IN:

1 V<sub>p-p</sub>, 75  $\Omega$

VIDEO/SAT AUDIO IN:

voltage 250/450 mV, impedance  
47 k $\Omega$

## Outputs

DVD VIDEO OUT:

max. output level 1 V<sub>p-p</sub>, unbalanced,  
Sync negative, load impedance 75  $\Omega$

PHONES:

accepts headphones of 8  $\Omega$  or more

SPEAKERS:

Use only the supplied speakers

SS-SLK2i (WHG-SLK2i) or SS-SLK1i  
(WHG-SLK1i).



## USB section

- (USB) port: Type A  
Maximum current: 500 mA

## Memory card section

- Multi memory card slot:  
Compatible with "Memory Stick"  
media (page 110), SD memory cards  
(page 111)

## Disc player section

- System:  
Compact disc and digital audio and  
video system
- Laser Diode Properties  
Emission duration: Continuous  
Laser Output\*: Less than 44.6  $\mu$ W  
\* This output is the value measurement  
at a distance of 200mm from the  
objective lens surface on the Optical  
Pick-up Block with 7mm aperture.
- Frequency response  
DVD (PCM 48 kHz): 2 Hz — 22 kHz  
( $\pm 1$  dB)  
CD: 2 Hz — 20 kHz ( $\pm 0.5$  dB)
- Video color system format  
North American and Latin American  
models: NTSC  
Other models: NTSC and PAL

## Tuner section

- FM stereo, FM/AM superheterodyne tuner
- FM tuner section  
Tuning range  
North American and Brazilian  
models:  
87.5 MHz — 108.0 MHz (100 kHz  
step)  
Other models:  
87.5 MHz — 108.0 MHz (50 kHz step)
- Antenna:  
FM lead antenna
- Antenna terminals:  
75  $\Omega$  unbalanced
- Intermediate frequency:  
10.7 MHz
- AM tuner section  
Tuning range  
European and Saudi Arabian models:  
531 kHz — 1,602 kHz (9 kHz step)  
North American and Latin American  
models:  
530 kHz — 1,710 kHz (10 kHz step)  
531 kHz — 1,710 kHz (9 kHz step)  
Australian model:  
531 kHz — 1,710 kHz (9 kHz step)  
530 kHz — 1,710 kHz (10 kHz step)  
Other models:  
531 kHz — 1,602 kHz (9 kHz step)  
530 kHz — 1,610 kHz (10 kHz step)
- Antenna:  
AM loop antenna
- Antenna terminals:  
External antenna terminal
- Intermediate frequency:  
450 kHz

## Speaker

### Front speaker (SS-SLK2i) for WHG-SLK2i

Speaker system:  
2-way 2-driver speaker system, Bass reflex

Speaker unit  
Woofers: 130 mm, cone type  
Tweeter: 40 mm, cone type

Rated impedance: 6  $\Omega$

Dimensions (W/H/D):  
Approx. 330 mm  $\times$  203 mm  $\times$  138 mm

Mass:  
Approx. 3.1 kg

### Front speaker (SS-SLK1i) for WHG-SLK1i

Speaker system:  
2-way 2-driver speaker system, Bass reflex

Speaker unit  
Woofers: 100 mm, cone type  
Tweeter: 40 mm, cone type

Rated impedance: 8  $\Omega$

Dimensions (W/H/D):  
Approx. 140 mm  $\times$  203 mm  $\times$  138 mm

Mass:  
Approx. 1.3 kg

## General

### Power requirements

North American model:

AC 120 V, 60 Hz

Mexican model:

AC 127 V, 60 Hz

Brazilian model:

AC 127 V — 240 V, 60 Hz

European, Korean, Argentine, Thai and Australian models:

AC 220 V — 240 V, 50/60 Hz

Other models:

AC 120 V — 240 V, 50/60 Hz

### Power consumption

WHG-SLK2i:

80 W

WHG-SLK1i:

60 W

### Dimensions (W/H/D) (excl. speakers)

WHG-SLK2i:

Approx. 330 mm  $\times$  203 mm  $\times$  141 mm

WHG-SLK1i:

Approx. 330 mm  $\times$  203 mm  $\times$  138 mm

### Mass (excl. speakers)

WHG-SLK2i:

Approx. 3.7 kg

WHG-SLK1i:

Approx. 3.6 kg

### Supplied accessories:

Remote Commander (1)

AM loop antenna (1)

FM lead antenna (1)

Video cord (1) (WHG-SLK2i only)

R6 (Size AA) batteries (2)

Wall-mount bracket (3) (WHG-SLK2i only)

Bracket lock levers (3) and screws (3) (WHG-SLK2i only)

Leaflet "Installing the system on the wall" (1) (WHG-SLK2i only)

## Supported file format

Media type and file format	DATA CD/DATA DVD	USB device	"Memory Stick" media/SD memory card
<b>Audio</b>	<b>MP3</b> File extension: .mp3 Bitrate: 32 kbps — 320 kbps, VBR Sampling frequencies: 32/44.1/48 kHz DRM: Not compatible	<b>MP3</b> File extension: .mp3 Bitrate: 32 kbps — 320 kbps, VBR Sampling frequencies: 32/44.1/48 kHz DRM: Not compatible  <b>WMA</b> File extension: .wma Bitrate: 48 kbps — 192 kbps Sampling frequencies: 44.1 kHz DRM: Not compatible  <b>AAC</b> File extension: .m4a Bitrate: 48 kbps — 320 kbps Sampling frequencies: 44.1 kHz DRM: Not compatible	

Media type and file format	DATA CD/DATA DVD	USB device	"Memory Stick" media/SD memory card
<b>Video</b>	<p><b>DivX<sup>1)</sup></b>  File extension: .avi/.divx  Video codec: DivX video  Bitrate: 8 Mbps (MAX)  Frame rate: 30 fps  Resolution: 720 (width) × 576 (height) pixels  Audio codec: MP3</p> <p><b>MPEG4<sup>1)</sup></b>  File format: MP4  File extension: .mp4/.m4v  Video codec:  MPEG4 Simple Profile (AVC is not compatible.)  Bitrate: 4 Mbps  Frame rate: 30 fps  Resolution: 720 (width) × 576 (height) pixels  Audio codec: AAC-LC (HE-AAC is not compatible.)  DRM:  Not compatible</p>	<p><b>MPEG4</b>  File format: MP4/AVI  File extension: .mp4/.avi  Video codec:  MPEG4 Simple Profile/MPEG4 Advanced Simple Profile (AVC is not compatible.)  Bitrate: 4 Mbps  Frame rate: 30 fps  Resolution: 720 (width) × 576 (height) pixels  Audio codec:  AAC-LC (HE-AAC is not compatible.)/MP3  Channel (s): 2-channels (MAX)  Bitrate: 128 kbps  Sampling frequency: 44.1 kHz  DRM:  Not compatible</p> <p><b>MPEG2/MPEG1</b>  File format: MPEG2/MPEG1/AVI  File extension: .mpg/.avi  Bitrate: 4 Mbps (including audio streams)  Frame rate: 30 fps  Resolution: 720 (width) × 576 (height) pixels  Audio codec:  MP1 (MPEG1 Audio Layer 1)/MP2 (MPEG1 Audio Layer 2)  Channel (s): 2-channels (MAX)  Bitrate: 128 kbps  Sampling frequency: 44.1 kHz</p> <p><b>Motion JPEG</b>  File format: AVI  File extension: .avi  Bitrate: 4 Mbps  Frame rate: 30 fps  Resolution: 640 (width) × 480 (height) pixels  Audio codec:  AAC-LC (HE-AAC is not compatible.)/MP3  Channel (s): 2-channels (MAX)  Bitrate: 128 kbps  Sampling frequency: 44.1 kHz</p>	

<b>Media type and file format</b>	<b>DATA CD/DATA DVD</b>	<b>USB device</b>	<b>“Memory Stick” media/SD memory card</b>
<b>Image</b>	<b>JPEG</b> Image format: Interlace or progressive format, DCF conformity, 24-bit RGB color File extension: .jpg/.jpeg Resolution: 8 (width) × 8 (height) pixels (MIN) — 3,071 (width) × 2,047 (height) pixels (MAX) <sup>2)</sup>		

<sup>1)</sup> Not supported on the North American model.

<sup>2)</sup> Less than 2,000,000 pixels for progressive JPEG format.

Design and specifications are subject to change without notice.

- Standby power consumption: 0.5 W
- Halogenated flame retardants are not used in the certain printed wiring boards.

## Compatible devices with this system

### USB devices

Check the websites below for information about compatible USB devices.

For customers in the U.S.A.:

<<http://www.sony.com/shelfsupport>>

For customers in Canada:

English <<http://www.sony.ca/ElectronicsSupport/>>

French <<http://fr.sony.ca/ElectronicsSupport/>>

For customers in Europe:

<<http://support.sony-europe.com/>>

For customers in Latin America:

<<http://www.sony-latin.com/index.crp>>

For customers in Asia and Oceania:

<<http://www.sony-asia.com/support>>

### “Memory Stick” media

You can use the following types of “Memory Stick” media<sup>1)2)</sup>:

- “Memory Stick”<sup>3)</sup> (Not compatible with “MagicGate”)
- “Memory Stick”<sup>3)</sup> (Compatible with “MagicGate”)
- “MagicGate Memory Stick”<sup>4)</sup>
- “Memory Stick PRO”<sup>3)</sup>
- “Memory Stick PRO DUO”
- “Memory Stick PRO-HG”
- “Memory Stick Micro”<sup>5)</sup> (“M2”<sup>6)</sup>)

<sup>1)</sup> This system supports FAT32.

<sup>2)</sup> The system has been demonstrated as operable with a “Memory Stick” media with a capacity of 32 GB or less manufactured by Sony Corporation. However, we do not guarantee the operations of all “Memory Stick” media.

<sup>3)</sup> The multi memory card slot on the unit is compatible with both standard-size and Duo-size media. Without a “Memory Stick Duo” media adaptor, you can use both a standard-size “Memory Stick” media and the compact-size “Memory Stick Duo” media.

<sup>4)</sup> Data reading that requires “MagicGate” copyright protection cannot be performed. “MagicGate” is the general name of a copyright protection technology developed by Sony using authentication and encryption.

<sup>5)</sup> When using a “Memory Stick Micro” media, always insert it into an M2 adaptor.

<sup>6)</sup> “M2” is an abbreviation for “Memory Stick Micro” media. In this section, “M2” is used to describe “Memory Stick Micro” media.

## SD memory card

You can use the following types of memory cards:

- SD memory card<sup>1)4)</sup>
- miniSD memory card and microSD memory card (An adaptor is necessary.)<sup>2)4)</sup>
- SDHC memory card<sup>3)4)</sup>

<sup>1)</sup> The system has been demonstrated as operable with an SD memory card with a capacity of 2 GB or smaller.

<sup>2)</sup> Some commercially available card adaptors have projected terminals on the rear. This type of adaptor may not work properly with the system.

<sup>3)</sup> The system has been demonstrated as operable with an SDHC memory card with a capacity of 8 GB or less.

<sup>4)</sup> We do not guarantee proper operations for all types of SD memory cards.

### Note on SD memory card

Data reading that requires a copyright protection cannot be performed.

## iPod models

You can use the following iPod models on this system. Update your iPod with the latest software before using it.



iPod nano  
5th generation  
(video camera)



iPod touch  
2nd generation



iPod classic  
120 GB  
160 GB (2009)



iPod nano  
4th generation  
(video)



iPod classic  
160 GB (2007)



iPod touch  
1st generation



iPod nano  
3rd generation  
(video)



iPod classic  
80 GB



iPod nano  
2nd generation  
(aluminum)



# Guide to the Control Menu display (CD/DVD function only)

Use the Control Menu to select a function and to view related information. Press  DISPLAY repeatedly to turn on, turn off or change the Control Menu display as follows:

Control Menu display 1 → Control Menu display 2\* → Control Menu display off → Control Menu display 1 → ...

\* Control Menu display 2 appears when available.

## Control Menu display

The Control Menu display 1 and 2 will show different items depending on the disc type. Example: Control Menu display 1 when playing a DVD VIDEO

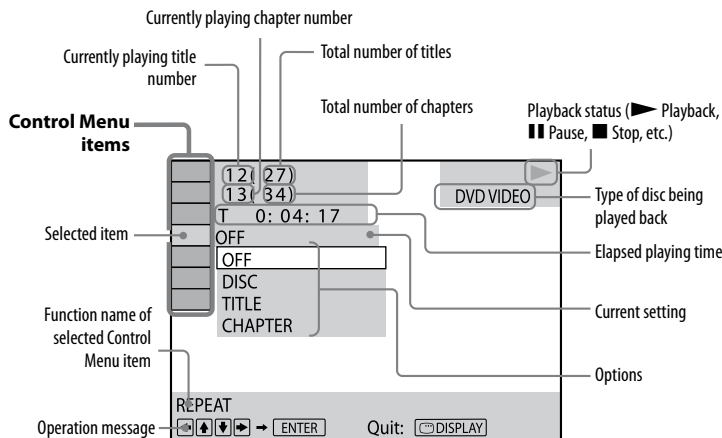

Additional Information









## To turn off the Control Menu

Press  DISPLAY repeatedly until the Control Menu disappears from the TV screen.

Continued 

## List of Control Menu items

Item	Item Name, Function, Relevant Disc Type
	<b>[TITLE]/[SCENE]/[TRACK] (page 39)</b> Selects a title, scene or track to be played back. <b>DVD-V</b> <b>DVD-VR</b> <b>VIDEO CD</b>
	<b>[CHAPTER]/[INDEX] (page 39)</b> Selects a chapter or index to be played back. <b>DVD-V</b> <b>DVD-VR</b> <b>VIDEO CD</b>
	<b>[TRACK] (page 39)</b> Selects a track or audio file to be played back. <b>C D</b> <b>DATA CD</b> <b>DATA DVD</b>
	<b>[ORIGINAL/PLAY LIST] (page 39)</b> Selects the playback sequence either to the originally recorded sequence or to the playlist created on the disc. <b>DVD-VR</b>
	<b>[TIME] (page 40)</b> Displays the elapsed playing time and the remaining time. You can play from a desired point by inputting the time code (DVD VIDEO/DVD-VR only). <b>DVD-V</b> <b>DVD-VR</b> <b>VIDEO CD</b> <b>C D</b> <b>DATA CD</b> <b>DATA DVD</b>
	<b>[PROGRAM] (page 46)</b> Plays back the tracks in the order you want. <b>VIDEO CD</b> <b>C D</b>
	<b>[SHUFFLE] (page 48)</b> Plays back the tracks or audio files in random order. <b>VIDEO CD</b> <b>C D</b> <b>DATA CD</b> <b>DATA DVD</b>
	<b>[REPEAT] (page 49)</b> Plays back a disc repeatedly, the entire disc (all titles/all tracks/all files/all folders) repeatedly or one title/chapter/track/folder/file repeatedly. <b>DVD-V</b> <b>DVD-VR</b> <b>VIDEO CD</b> <b>C D</b> <b>DATA CD</b> <b>DATA DVD</b>

Item	Item Name, Function, Relevant Disc Type
	<p><b>[A/V SYNC] (page 50)</b> Adjusts the delay between the picture and sound.</p> <p><b>DVD-V</b> <b>DVD-VR</b> <b>VIDEO CD</b> <b>DATA CD</b> <b>DATA DVD</b></p>
	<p><b>[SETUP] (page 28, 53)</b> <b>QUICK</b> Use “QUICK” setup to choose the display language of the Control Menu display and the aspect ratio of the TV screen. <b>CUSTOM</b> In addition to the “QUICK” setup setting, you can adjust other settings.</p> <p><b>DVD-V</b> <b>DVD-VR</b> <b>VIDEO CD</b> <b>C D</b> <b>DATA CD</b> <b>DATA DVD</b></p>
	<p><b>[FOLDER] (page 49)</b> Selects a folder to be played back.</p> <p><b>DATA CD</b> <b>DATA DVD</b></p>
	<p><b>[FILE] (page 49)</b> Selects a JPEG image file or video file to be played back.</p> <p><b>DATA CD</b> <b>DATA DVD</b></p>
	<p><b>[DATE] (page 80)</b> Displays the date when the picture was taken by a digital camera.</p> <p><b>DATA CD</b> <b>DATA DVD</b></p>
	<p><b>[INTERVAL] (page 45)</b> Selects the duration for which the JPEG image files are played back.</p> <p><b>DATA CD</b> <b>DATA DVD</b></p>
	<p><b>[EFFECT] (page 45)</b> Selects the transition effects to be used during a slideshow.</p> <p><b>DATA CD</b> <b>DATA DVD</b></p>
 : North American model	<p><b>[MEDIA] (page 40, 44, 46)</b> Selects the data type (MP3 file, JPEG image file, video file, or both MP3 file and JPEG image file) to be played back.</p> <p><b>DATA CD</b> <b>DATA DVD</b></p>
 : Other models	<p><b>DATA CD</b> <b>DATA DVD</b></p>

Continued 

## Playback priority of file types

The table below describes the playback priority of file types under the “MEDIA” setting.

File type on a disc	“MEDIA” setting			
	VIDEO*	MUSIC/ PHOTO	MUSIC	PHOTO
Video files only	Video files	Video files	Video files	Video files
JPEG image files only	JPEG image files	JPEG image files	JPEG image files	JPEG image files
MP3 files only	MP3 files	MP3 files	MP3 files	MP3 files
Video files and JPEG image files	Video files	JPEG image files	Video files	JPEG image files
Video files and MP3 files	Video files	MP3 files	MP3 files	MP3 files
MP3 files and JPEG image files	MP3 files and JPEG image files with slideshow	MP3 files and JPEG image files with slideshow	MP3 files	JPEG image files
Video files, MP3 files, and JPEG image files	Video files	MP3 files and JPEG image files with slideshow	MP3 files	JPEG image files

\* Not available on the North American model.

# Language code list

The language spellings conform to the ISO 639:1988 (E/F) standard.

<b>Code</b>	<b>Language</b>	<b>Code</b>	<b>Language</b>	<b>Code</b>	<b>Language</b>	<b>Code</b>	<b>Language</b>
1027	Afar	1186	Scots Gaelic	1350	Malayalam	1513	Siswati
1028	Abkhazian	1194	Galician	1352	Mongolian	1514	Sesotho
1032	Afrikaans	1196	Guarani	1353	Moldavian	1515	Sundanese
1039	Amharic	1203	Gujarati	1356	Marathi	1516	Swedish
1044	Arabic	1209	Hausa	1357	Malay	1517	Swahili
1045	Assamese	1217	Hindi	1358	Maltese	1521	Tamil
1051	Aymara	1226	Croatian	1363	Burmese	1525	Telugu
1052	Azerbaijani	1229	Hungarian	1365	Nauru	1527	Tajik
1053	Bashkir	1233	Armenian	1369	Nepali	1528	Thai
1057	Byelorussian	1235	Interlingua	1376	Dutch	1529	Tigrinya
1059	Bulgarian	1239	Interlingue	1379	Norwegian	1531	Turkmen
1060	Bihari	1245	Inupiak	1393	Occitan	1532	Tagalog
1061	Bislama	1248	Indonesian	1403	(Afan) Oromo	1534	Setswana
1066	Bengali; Bangla	1253	Icelandic	1408	Oriya	1535	Tonga
1067	Tibetan	1254	Italian	1417	Punjabi	1538	Turkish
1070	Breton	1257	Hebrew	1428	Polish	1539	Tsonga
1079	Catalan	1261	Japanese	1435	Pashto; Pushto	1540	Tatar
1093	Corsican	1269	Yiddish	1436	Portuguese	1543	Twì
1097	Czech	1283	Javanese	1463	Quechua	1557	Ukrainian
1103	Welsh	1287	Georgian	1481	Rhaeto-Romance	1564	Urdu
1105	Danish	1297	Kazakh	1482	Kirundi	1572	Uzbek
1109	German	1298	Greenlandic	1483	Romanian	1581	Vietnamese
1130	Bhutani	1299	Cambodian	1489	Russian	1587	Volapük
1142	Greek	1300	Kannada	1491	Kinyarwanda	1613	Wolof
1144	English	1301	Korean	1495	Sanskrit	1632	Xhosa
1145	Esperanto	1305	Kashmiri	1498	Sindhi	1665	Yoruba
1149	Spanish	1307	Kurdish	1501	Sangho	1684	Chinese
1150	Estonian	1311	Kirghiz	1502	Serbo-Croatian	1697	Zulu
1151	Basque	1313	Latin	1503	Singhalese	1703	Not specified
1157	Persian	1326	Lingala	1505	Slovak		
1165	Finnish	1327	Laothian	1506	Slovenian		
1166	Fiji	1332	Lithuanian	1507	Samoa		
1171	Faroese	1334	Latvian; Lettish	1508	Shona		
1174	French	1345	Malagasy	1509	Somali		
1181	Frisian	1347	Maori	1511	Albanian		
1183	Irish	1349	Macedonian	1512	Serbian		

## Parental Control area code list

<b>Code</b>	<b>Area</b>	<b>Code</b>	<b>Area</b>	<b>Code</b>	<b>Area</b>	<b>Code</b>	<b>Area</b>
2044	Argentina	2165	Finland	2362	Mexico	2149	Spain
2047	Australia	2174	France	2376	Netherlands	2499	Sweden
2046	Austria	2109	Germany	2390	New Zealand	2086	Switzerland
2057	Belgium	2248	India	2379	Norway	2528	Thailand
2070	Brazil	2238	Indonesia	2427	Pakistan	2184	United Kingdom
2079	Canada	2254	Italy	2424	Philippines		
2090	Chile	2276	Japan	2436	Portugal		
2092	China	2304	Korea	2489	Russia		
2115	Denmark	2363	Malaysia	2501	Singapore		

---

## Glossary

### Auto Pause

An automatic pause according to the signal encoded on the disc while playing a VIDEO CD. If the CD/DVD player does not resume playback for a long time, perform resume playback manually.

### Chapter

Subdivision of a title on a DVD VIDEO. A title is composed of several chapters.

### DivX®

Digital video technology created by DivX, Inc. Videos encoded with DivX technology are among the highest quality with a relatively small file size.

### Dolby Digital

This movie theater sound format is more advanced than Dolby Surround Pro Logic. In this format, the surround speakers output stereo sound with an expanded frequency range and a subwoofer channel for deep bass is independently provided. This format is also called "5.1" because the subwoofer channel is counted as 0.1 channel (since it functions only when a deep bass effect is needed). All six channels in this format are recorded separately for superior channel separation. Furthermore, since all the signals are processed digitally, less signal degradation occurs.

### DVD VIDEO

A disc that contains up to 8 hours of moving pictures even though its diameter is the same as an AUDIO CD. The data capacity of a single-layer and single-sided DVD VIDEO, at 4.7 GB (Giga Byte), is 7 times that of an AUDIO CD. Furthermore, the data capacity of a dual-layer and single-sided DVD VIDEO is 8.5 GB, a single-layer and double-sided DVD VIDEO 9.4 GB, and a dual-layer and double-sided DVD VIDEO 17 GB. The picture data uses the MPEG 2 format, one of the worldwide standards for digital compression technology. The picture data is compressed to about 1/40 of its original size. The DVD VIDEO also uses variable rate coding technology that changes the data to be allocated according to the status of the picture. The audio data is recorded in Dolby Digital as well as in PCM, allowing you to enjoy more realistic audio presence. Furthermore, various advanced functions such as the multi-angle, multilingual, and Parental Control functions are provided with the DVD VIDEO.

## **DVD-RW**

A DVD-RW is a recordable and rewritable disc that is the same size as a DVD VIDEO. The DVD-RW has two different modes: VR mode and Video mode. DVD-RWs created in Video mode have the same format as a DVD VIDEO, while discs created in VR (Video Recording) mode allow the contents to be programmed or edited.

## **DVD+RW**

A DVD+RW (plus RW) is a recordable and rewritable disc. DVD+RWs use a recording format that is comparable to the DVD VIDEO format.

## **File**

Audio file (MP3/WMA/AAC), JPEG image file, DivX and MPEG4 video file recorded on a DATA CD, DATA DVD, USB device or memory card. ("File" is an exclusive definition for this system.)

## **Film based software, Video based software**

DVD VIDEOS can be classified as Film based or Video based software. Film based DVD VIDEOS contain the same images (24 frames per second) that are shown at movie theaters. Video based DVD VIDEOS, such as television dramas or sitcoms, display images at 30 frames (or 60 fields) per second.

## **Folder**

Section of a music or picture piece on a DATA CD, DATA DVD, USB device or memory card containing data such as MP3 files, JPEG image files and video files.

## **Menu Playback**

Playback using the menu screens recorded on VIDEO CDs with PBC functions. You can enjoy simple interactive software using the menu playback function.

## **Multi-angle function**

Various angles, or viewpoints of the video camera, for a scene are recorded on some DVD VIDEOS.

## **Multilingual function**

Several languages for the sound or subtitles in a picture are recorded on some DVD VIDEOS.

## **Multi Session**

This is a recording method that enables adding of data using the Track-At-Once method. Conventional CDs begin at a CD control area called the Lead-in and end at an area called Lead-out. A multi session disc is a disc having multiple sessions, with each segment from Lead-in to Lead-out regarded as a single session.



## Parental Control

A function of the DVD VIDEO to limit playback of the disc by the age of the users according to the limitation level in each country. The limitation varies from disc to disc; when it is activated, playback is completely prohibited, violent scenes are skipped or replaced with other scenes and so on.

## Playback Control (PBC)

Signals encoded on VIDEO CDs (Version 2.0) to control playback. By using menu screens recorded on VIDEO CDs with PBC functions, you can enjoy playing simple interactive programs, programs with search functions, and so on.

## Region Code

This system is used to protect copyrights. A region code is allocated on each DVD system or DVD VIDEO according to the sales region. Each region code is shown on the unit as well as on the disc packaging. The system can play back the discs that match its region code. The system can also play back discs with the “” mark. Even when the region code is not shown on the DVD VIDEO, the region limit may still be activated.

## Scene

On a VIDEO CD with PBC functions, the menu screens, moving pictures and still pictures are divided into sections called “scenes.”

## Title

The longest section of a picture or a music piece on a DVD VIDEO; a movie, etc., for a picture piece on video software, or the entire album in audio software.

## Track

Section of a music or a picture on a VIDEO CD, CD, or section of a music on a CD.

## VIDEO CD

A compact disc that contains moving pictures.

The picture data uses the MPEG 1 format, one of the worldwide standards for digital compression technology. The picture data is compressed to about 1/140 of its original size. Consequently, a 12 cm VIDEO CD can contain up to 74 minutes of moving pictures.

VIDEO CDs also contain compact audio data.

Sounds outside the range of human hearing are compressed while the sounds we can hear are not compressed. VIDEO CDs can hold 6 times the audio information of conventional AUDIO CDs.

There are 2 versions of VIDEO CDs.

- Version 1.1: You can play back only moving pictures and sounds.
- Version 2.0: You can play back high-resolution still pictures and enjoy PBC functions.

This system conforms to both versions.

# Index

## Numerics

- 16:9 55
- 4:3 LETTER BOX 55
- 4:3 PAN SCAN 55
- 5.1 Channel surround 37

## A

- A/V SYNC 50, 115
- AAC 107
- Analogue clock 81
- AUDIO 55
- AUDIO DRC 56
- AUDIO SETUP 56
- Automatic demonstration 25, 78
- Auto pause 119
- Auto standby function 97

## B

- BACKGROUND 57
- Batteries 26
- Beep sound 82
- BLACK LEVEL 56

## C

- Calendar 81
- CD music playback screen 23
- CHAPTER 49, 114
- Chapter 33, 119
- Clock setup 30
- COLOR SYSTEM(VIDEO CD) 56
- Controlling the TV 28
- Control Menu 22
- Control Menu display 113
- CUSTOM 51, 53

## D

- DATE 80, 115
- Display language 29, 30, 54
- DivX 108
- Dolby Digital 119
- DVD 9, 10
- DVD+RW 9, 10, 120
- DVD-RW 9, 10, 120
- DVD VIDEO 119

## E

- EFFECT 45, 115

## F

- Fast forward 34
- Fast reverse 34
- FILE 49, 115
- File 120
- Film based software 120
- FOLDER 49, 115
- Folder 120
- Freeze Frame 34

## H

- Home menu 18

## I

- INDEX 39, 114
- Indicator 20
- Instant Advance 34
- Instant Replay 34
- INTERVAL 45, 115
- iPod 26, 61, 112
- iPod Dock Adapter 26

## J

- JPEG 109

## K

- Key brightness 82

## L

- Language code list 117
- LCD brightness 82
- LCD screen mode 82

## M

- Main unit 12
- MEDIA 40, 44, 46, 115
- Memory card 65
- Memory select 66
- "Memory Stick" media 110
- MENU 54
- Motion JPEG 108
- MP3 107
- MP3 Booster+ 74
- MPEG1 108
- MPEG2 108
- MPEG4 108
- Multi-angle 34, 120
- MULTI-DISC RESUME 35, 58
- Multilingual 120
- Multi session disc 101, 120

## O

- Options menu 19
- ORIGINAL 39, 114
- OSD 54
- Other Component Hookup 83

## **P**

PARENTAL CONTROL 51  
Parental control 121  
PAUSE MODE 56  
PBC playback 38  
Photo fitting 69  
Playback Control (PBC) 121  
Playback priority 116  
Playback screen 20  
PLAY LIST 39, 114  
Play Timer 76  
Power saving mode 25  
Preset sound effect 72  
PROGRAM 46, 114  
Program play 46

## **Q**

QUICK setup 28

## **R**

Rear panel 83  
Region code 121  
Remote 15  
Repeat play 49, 64, 71, 114  
RESET 96  
Reset 95

## **S**

Satellite tuner 84  
SCENE 114  
Scene 121  
Screen mode 82  
Screen saver 57  
SD memory card 111  
Settings menu 18  
SETUP menu 53, 115  
Shuffle play 48, 63, 70, 114  
Simultaneous playback 75  
Sleep Timer 76  
Slideshow 44, 67, 68  
Slow-motion Play 34  
Sony logo backlight 82  
Sound field 72  
Status bar 20  
SUBTITLE 55  
SYSTEM SETUP 57

## **T**

TIME 40, 114  
Time display format 31  
Timer 76  
TITLE 49, 114  
Title 33, 121  
TRACK 48, 114  
TRACK SELECTION 57  
Troubleshooting 85  
Tuner memory 60  
Tuning mode 59  
TV Hookup 27  
TV TYPE 55

## **U**

Usable discs 9  
USB device 65  
User registration 6

## **V**

VIDEO CD 9, 121  
Video input 84  
VIDEO SETUP 29, 55

## **W**

WMA 107

## License and trademark notice

- This product incorporates copyright protection technology that is protected by U.S. patents and other intellectual property rights. Use of this copyright protection technology must be authorized by Macrovision, and is intended for home and other limited viewing uses only unless otherwise authorized by Macrovision. Reverse engineering or disassembly is prohibited.
- Manufactured under license from Dolby Laboratories. "Dolby" and the double-D symbol are trademarks of Dolby Laboratories.
- "DVD+RW," "DVD-RW," "DVD+R," "DVD VIDEO," and the "CD" logos are trademarks.
- DivX<sup>®</sup> is a video file compression technology, developed by DivX, Inc. DivX, DivX Certified, and associated logos are trademarks of DivX, Inc. and are used under license.  
This product is an official DivX<sup>®</sup> certified product.
- MPEG Layer-3 audio coding technology and patents licensed from Fraunhofer IIS and Thomson.
- iPod is a trademark of Apple Inc., registered in the U.S. and other countries.
- "Made for iPod" means that an electronic accessory has been designed to connect specifically to iPod and has been certified by the developer to meet Apple performance standards.
- Apple is not responsible for the operation of this device or its compliance with safety and regulatory standards.

-  "Memory Stick," **MEMORY STICK**, "Memory Stick Duo," **MEMORY STICK DUO**, "MagicGate Memory Stick," "Memory Stick PRO," **MEMORY STICK PRO**, "Memory Stick PRO Duo," **MEMORY STICK PRO DUO**, "Memory Stick PRO-HG Duo," **MEMORY STICK PRO-HG DUO**, "Memory Stick Micro," **MEMORY STICK MICRO, M2**, "Memory Stick-ROM," **MEMORY STICK-ROM**, "MagicGate," and **MAGICGATE** are trademarks or registered trademarks of Sony Corporation.
- SDHC Logo is a trademark of SD-3C, LLC.
- Windows Media is either a registered trademark or trademark of Microsoft Corporation in the United States and/or other countries.
- This product is protected by certain intellectual property rights of Microsoft Corporation. Use or distribution of such technology outside of this product is prohibited without a license from Microsoft or an authorized Microsoft subsidiary.

- THIS PRODUCT IS LICENSED UNDER THE MPEG-4 VISUAL PATENT PORTFOLIO LICENSE FOR THE PERSONAL AND NON-COMMERCIAL USE OF A CONSUMER FOR
  - (i) ENCODING VIDEO IN COMPLIANCE WITH THE MPEG-4 VISUAL STANDARD (“MPEG-4 VIDEO”) AND/OR
  - (ii) DECODING MPEG-4 VIDEO THAT WAS ENCODED BY A CONSUMER ENGAGED IN A PERSONAL AND NON-COMMERCIAL ACTIVITY AND/OR WAS OBTAINED FROM A VIDEO PROVIDER LICENSED BY MPEG LA TO PROVIDE MPEG-4 VIDEO.NO LICENSE IS GRANTED OR SHALL BE IMPLIED FOR ANY OTHER USE. ADDITIONAL INFORMATION INCLUDING THAT RELATING TO PROMOTIONAL, INTERNAL AND COMMERCIAL USES AND LICENSING MAY BE OBTAINED FROM MPEG LA, LLC. SEE <http://www.mpegla.com/>
- All other trademarks and registered trademarks are of their respective holders. In this manual, <sup>TM</sup> and <sup>®</sup> marks are not specified.



