

- ▶ Before Use
- ▶ Operating the camera
- ▶ Shooting
- ▶ Viewing
- ▶ Useful shooting functions
- ▶ Useful viewing functions
- ▶ Changing settings
- ▶ Viewing images on a TV
- ▶ Using with your computer
- ▶ Printing
- ▶ Troubleshooting
- ▶ Precautions / About this camera

[→ Contents list](#)

DSC-RX100M2

User Guide

Use this manual if you encounter any problems, or have any questions about the camera.



Cyber-shot

[▲ Back to top](#)

Copyright 2013 Sony Corporation

[▶ Before Use](#)[▶ Operating the camera](#)[▶ Shooting](#)[▶ Viewing](#)[▶ Useful shooting functions](#)[▶ Useful viewing functions](#)[▶ Changing settings](#)[▶ Viewing images on a TV](#)[▶ Using with your computer](#)[▶ Printing](#)[▶ Troubleshooting](#)[▶ Precautions / About this camera](#)[⇒ Contents list](#)

Before Use

How to use this User Guide

[How to use this User Guide](#)

Names of parts and list of icons displayed on the screen

[Names of parts](#)

[List of icons displayed on the screen](#)

Using the strap

[Using the wrist strap](#)

Using the shoulder strap

[Using the shoulder strap \(sold separately\)](#)

Using the In-Camera Guide

[In-Camera Guide](#)

[Shooting Tip](#)

[▲ Back to top](#)

- ▶ [Before Use](#)
- ▶ [Operating the camera](#)
- ▶ [Shooting](#)
- ▶ [Viewing](#)
- ▶ [Useful shooting functions](#)
- ▶ [Useful viewing functions](#)
- ▶ [Changing settings](#)
- ▶ [Viewing images on a TV](#)
- ▶ [Using with your computer](#)
- ▶ [Printing](#)
- ▶ [Troubleshooting](#)
- ▶ [Precautions / About this camera](#)

[⇒ Contents list](#)

Operating the camera

Operating the camera

[Using the control wheel](#)

[How to use Control Ring](#)

[How to use the Fn \(Function\) button](#)

[Using MENU items](#)

[▲ Back to top](#)

- ▶ [Before Use](#)
- ▶ [Operating the camera](#)
- ▶ [Shooting](#)
- ▶ [Viewing](#)
- ▶ [Useful shooting functions](#)
- ▶ [Useful viewing functions](#)
- ▶ [Changing settings](#)
- ▶ [Viewing images on a TV](#)
- ▶ [Using with your computer](#)
- ▶ [Printing](#)
- ▶ [Troubleshooting](#)
- ▶ [Precautions / About this camera](#)

[⇒ Contents list](#)

Shooting

Shooting still images

[Shooting still images](#)

[Zoom \(Still images\)](#)

Shooting movies

[Shooting movies](#)

[Zoom \(Movies\)](#)

[Shooting still images while recording a movie \(Dual Rec\)](#)

Setting REC mode

[List of mode dial functions](#)

[Intelligent Auto](#)

[Superior Auto](#)

[Program Auto](#)

[Aperture Priority](#)

[Shutter Priority](#)

[Manual Exposure](#)

[Memory recall](#)

[Movie](#)

[Sweep Panorama](#)

[Scene Selection](#)

[▲ Back to top](#)

- ▶ Before Use
- ▶ Operating the camera
- ▶ Shooting
- ▶ Viewing
- ▶ Useful shooting functions
- ▶ Useful viewing functions
- ▶ Changing settings
- ▶ Viewing images on a TV
- ▶ Using with your computer
- ▶ Printing
- ▶ Troubleshooting
- ▶ Precautions / About this camera

[⇒ Contents list](#)

Viewing

Viewing still images

[Viewing still images](#)

[Playback zoom](#)

[Image Index](#)

Deleting images

[Deleting images](#)

Viewing movies

[Viewing movies](#)

Viewing panoramic images

[Scrolling panoramic images for display](#)

[▲ Back to top](#)

- ▶ Before Use
- ▶ Operating the camera
- ▶ Shooting
- ▶ Viewing
- ▶ Useful shooting functions
- ▶ Useful viewing functions
- ▶ Changing settings
- ▶ Viewing images on a TV
- ▶ Using with your computer
- ▶ Printing
- ▶ Troubleshooting
- ▶ Precautions / About this camera

[⇒ Contents list](#)

Useful shooting functions

Functions not available for each shooting mode

[Functions not available for each shooting mode](#)

[MENU items not available for each shooting mode](#)

Using shooting functions

[Tracking focus](#)

[DISP \(Display Contents\)](#)

[Flash Mode](#)

[Exposure Comp.](#)

[Photo Creativity](#)

[Drive Mode](#)

[Image Size](#)

[Aspect Ratio](#)

[Quality](#)

[Panorama: Size](#)

[Panorama: Direction](#)

[Focus Mode](#)

[Autofocus Area](#)

[Soft Skin Effect](#)

[Smile/Face Detect.](#)

[Auto Object Framing](#)

[ISO](#)

[Metering Mode](#)

[Flash Comp.](#)

[White Balance](#)

[DRO/Auto HDR](#)

[Creative Style](#)

[Picture Effect](#)

[Clear Image Zoom](#)

[Digital Zoom](#)

[Long Exposure NR](#)

[High ISO NR](#)

[AF Illuminator](#)

[SteadyShot](#)

[Color Space](#)

[Ctrl with Smartphone](#)

[Write Date](#)

[Memory](#)

[File Format](#)

[Record Setting](#)

[Image Size\(Dual Rec\)](#)

SteadyShot
Audio Recording
Wind Noise Reduct.
FINDER/LCD Setting
Red Eye Reduction
Grid Line
Auto Review
DISP Button
Peaking Level
Peaking Color
Control Ring
Zoom Func. on Ring
Control Ring Display
Function Button
Func. of Center Button
Func. of Left Button
Func. of Right Button
MOVIE Button
MF Assist
Focus Magnif. Time
Face Priority Tracking
Face Registration

[▲ Back to top](#)

Copyright 2013 Sony Corporation

- ▶ [Before Use](#)
- ▶ [Operating the camera](#)
- ▶ [Shooting](#)
- ▶ [Viewing](#)
- ▶ [Useful shooting functions](#)
- ▶ [Useful viewing functions](#)
- ▶ [Changing settings](#)
- ▶ [Viewing images on a TV](#)
- ▶ [Using with your computer](#)
- ▶ [Printing](#)
- ▶ [Troubleshooting](#)
- ▶ [Precautions / About this camera](#)

[⇒ Contents list](#)

Useful viewing functions

Functions not available for each view mode

[MENU items not available for each view mode](#)

Playback menu

[Still/Movie Select](#)

[Delete](#)

[Slide Show](#)

[Image Index](#)

[Protect](#)

[Specify Printing](#)

[Send to Smartphone](#)

[Send to Computer](#)

[View on TV](#)

[Picture Effect](#)

[Volume Settings](#)

[Playback Display](#)

[▲ Back to top](#)

- ▶ Before Use
- ▶ Operating the camera
- ▶ Shooting
- ▶ Viewing
- ▶ Useful shooting functions
- ▶ Useful viewing functions
- ▶ Changing settings
- ▶ Viewing images on a TV
- ▶ Using with your computer
- ▶ Printing
- ▶ Troubleshooting
- ▶ Precautions / About this camera

[⇒ Contents list](#)

Changing settings

Memory Card Tool menu

- [Format](#)
- [File Number](#)
- [Select REC Folder](#)
- [New Folder](#)
- [Recover Image DB](#)
- [Display Card Space](#)

Clock setup menu

- [Date/Time Setup](#)
- [Area Setting](#)

Setup menu

- [Menu start](#)
- [Mode Dial Guide](#)
- [LCD Brightness](#)
- [Viewfinder Bright.](#)
- [Power Save](#)
- [Power Saving Start Time](#)
- [PAL/NTSC Selector \(only for 1080 50i-compatible models\)](#)
- [Upload Settings](#)
- [HDMI Resolution](#)
- [CTRL FOR HDMI](#)
- [USB Connection](#)
- [USB LUN Setting](#)
- [USB Power Supply](#)
- [Audio signals](#)
- [WPS Push](#)
- [Access Point Settings](#)
- [Edit Device Name](#)
- [Disp MAC Address](#)
- [SSID/PW Reset](#)
- [Airplane Mode](#)
- [Version](#)
- [Language](#)
- [Drop Sensor](#)
- [Demo Mode](#)
- [Initialize](#)

[▲ Back to top](#)

- ▶ Before Use
- ▶ Operating the camera
- ▶ Shooting
- ▶ Viewing
- ▶ Useful shooting functions
- ▶ Useful viewing functions
- ▶ Changing settings
- ▶ Viewing images on a TV
- ▶ Using with your computer
- ▶ Printing
- ▶ Troubleshooting
- ▶ Precautions / About this camera

[⇒ Contents list](#)

Viewing images on a TV

Viewing an image on a High Definition (HD) TV

[Viewing an image on an HD TV using the HDMI Cable \(sold separately\)](#)

Viewing an image on a "BRAVIA" Sync-compatible TV

[Viewing an image on a "BRAVIA" Sync-compatible TV](#)

[▲ Back to top](#)

- ▶ [Before Use](#)
- ▶ [Operating the camera](#)
- ▶ [Shooting](#)
- ▶ [Viewing](#)
- ▶ [Useful shooting functions](#)
- ▶ [Useful viewing functions](#)
- ▶ [Changing settings](#)
- ▶ [Viewing images on a TV](#)
- ▶ [Using with your computer](#)
- ▶ [Printing](#)
- ▶ [Troubleshooting](#)
- ▶ [Precautions / About this camera](#)

[⇒ Contents list](#)

Using with your computer

Recommended computer environment

[Recommended computer environment](#)

Using the software

[“PlayMemories Home” \(Windows\)](#)

[Installing “PlayMemories Home” \(Windows\)](#)

[Software for Mac](#)

[“Image Data Converter”](#)

[Installing “Image Data Converter” \(Windows / Mac\)](#)

Importing images to a computer

[Connecting the camera to the computer](#)

[Importing images to a computer](#)

[To disconnect your camera from the computer](#)

Creating a disc of movies

[Selecting a method for creating a disc of movies](#)

[▲ Back to top](#)

- ▶ Before Use
- ▶ Operating the camera
- ▶ Shooting
- ▶ Viewing
- ▶ Useful shooting functions
- ▶ Useful viewing functions
- ▶ Changing settings
- ▶ Viewing images on a TV
- ▶ Using with your computer
- ▶ **Printing**
- ▶ Troubleshooting
- ▶ Precautions / About this camera

[⇒ Contents list](#)

Printing

Printing still images

[Printing still images](#)

[▲ Back to top](#)

- ▶ [Before Use](#)
- ▶ [Operating the camera](#)
- ▶ [Shooting](#)
- ▶ [Viewing](#)
- ▶ [Useful shooting functions](#)
- ▶ [Useful viewing functions](#)
- ▶ [Changing settings](#)
- ▶ [Viewing images on a TV](#)
- ▶ [Using with your computer](#)
- ▶ [Printing](#)
- ▶ [Troubleshooting](#)
- ▶ [Precautions / About this camera](#)

[⇒ Contents list](#)

Troubleshooting

If you have problems

[If you have problems](#)

Troubleshooting

[Battery pack and power](#)

[Shooting still images/movies](#)

[Viewing images](#)

[Wi-Fi](#)

[Computers](#)

[Memory card](#)

[Printing](#)

[Others](#)

Warning indicators and messages

[Self-diagnosis display](#)

[Messages](#)

Situations this camera has difficulty handling

[Situations this camera has difficulty handling](#)

[▲ Back to top](#)

- ▶ [Before Use](#)
- ▶ [Operating the camera](#)
- ▶ [Shooting](#)
- ▶ [Viewing](#)
- ▶ [Useful shooting functions](#)
- ▶ [Useful viewing functions](#)
- ▶ [Changing settings](#)
- ▶ [Viewing images on a TV](#)
- ▶ [Using with your computer](#)
- ▶ [Printing](#)
- ▶ [Troubleshooting](#)
- ▶ [Precautions / About this camera](#)

[⇒ Contents list](#)

Precautions / About this camera

Precautions

[Precautions](#)

[On the internal rechargeable backup battery](#)

[Battery pack](#)

[Charging the battery pack](#)

[Memory card](#)

On cleaning

[On cleaning](#)

Number of still images and recordable time of movies

[Number of still images](#)

[Recordable time of movies](#)

Using the camera abroad

[Using the camera abroad](#)

[On TV color systems](#)

About this camera

[Carl Zeiss lens](#)

[AVCHD format](#)

[License](#)

Trademarks

[Trademarks](#)

[▲ Back to top](#)

- ▶ [Before Use](#)
- ▶ [Operating the camera](#)
- ▶ [Shooting](#)
- ▶ [Viewing](#)
- ▶ [Useful shooting functions](#)
- ▶ [Useful viewing functions](#)
- ▶ [Changing settings](#)
- ▶ [Viewing images on a TV](#)
- ▶ [Using with your computer](#)
- ▶ [Printing](#)
- ▶ [Troubleshooting](#)
- ▶ [Precautions / About this camera](#)

[⇒ Contents list](#)

Contents list

Before Use

How to use this User Guide

[How to use this User Guide](#)

Names of parts and list of icons displayed on the screen

[Names of parts](#)

[List of icons displayed on the screen](#)

Using the strap

[Using the wrist strap](#)

Using the shoulder strap

[Using the shoulder strap \(sold separately\)](#)

Using the In-Camera Guide

[In-Camera Guide](#)

[Shooting Tip](#)

[▲ Back to top](#)

Operating the camera

Operating the camera

[Using the control wheel](#)

[How to use Control Ring](#)

[How to use the Fn \(Function\) button](#)

[Using MENU items](#)

[▲ Back to top](#)

Shooting

Shooting still images

[Shooting still images](#)

[Zoom \(Still images\)](#)

Shooting movies

[Shooting movies](#)

[Zoom \(Movies\)](#)

[Shooting still images while recording a movie \(Dual Rec\)](#)

Setting REC mode

[List of mode dial functions](#)

[Intelligent Auto](#)

[Superior Auto](#)

[Program Auto](#)

[Aperture Priority](#)

- Shutter Priority
- Manual Exposure
- Memory recall
- Movie
- Sweep Panorama
- Scene Selection

[▲ Back to top](#)

■ Viewing

Viewing still images

- Viewing still images
- Playback zoom
- Image Index

Deleting images

- Deleting images

Viewing movies

- Viewing movies

Viewing panoramic images

- Scrolling panoramic images for display

[▲ Back to top](#)

■ Useful shooting functions

Functions not available for each shooting mode

- Functions not available for each shooting mode
- MENU items not available for each shooting mode

Using shooting functions

- Tracking focus
- DISP (Display Contents)
- Flash Mode
- Exposure Comp.
- Photo Creativity
- Drive Mode
- Image Size
- Aspect Ratio
- Quality
- Panorama: Size
- Panorama: Direction
- Focus Mode
- Autofocus Area
- Soft Skin Effect
- Smile/Face Detect.
- Auto Object Framing
- ISO
- Metering Mode
- Flash Comp.
- White Balance

DRO/Auto HDR
Creative Style
Picture Effect
Clear Image Zoom
Digital Zoom
Long Exposure NR
High ISO NR
AF Illuminator
SteadyShot
Color Space
Ctrl with Smartphone
Write Date
Memory
File Format
Record Setting
Image Size(Dual Rec)
SteadyShot
Audio Recording
Wind Noise Reduct.
FINDER/LCD Setting
Red Eye Reduction
Grid Line
Auto Review
DISP Button
Peaking Level
Peaking Color
Control Ring
Zoom Func. on Ring
Control Ring Display
Function Button
Func. of Center Button
Func. of Left Button
Func. of Right Button
MOVIE Button
MF Assist
Focus Magnif. Time
Face Priority Tracking
Face Registration

▲ Back to top

Useful viewing functions

Functions not available for each view mode

MENU items not available for each view mode

Playback menu

Still/Movie Select

Delete

Slide Show

Image Index

- Protect
- Specify Printing
- Send to Smartphone
- Send to Computer
- View on TV
- Picture Effect
- Volume Settings
- Playback Display

[▲ Back to top](#)

Changing settings

Memory Card Tool menu

- Format
- File Number
- Select REC Folder
- New Folder
- Recover Image DB
- Display Card Space

Clock setup menu

- Date/Time Setup
- Area Setting

Setup menu

- Menu start
- Mode Dial Guide
- LCD Brightness
- Viewfinder Bright.
- Power Save
- Power Saving Start Time
- PAL/NTSC Selector (only for 1080 50i-compatible models)
- Upload Settings
- HDMI Resolution
- CTRL FOR HDMI
- USB Connection
- USB LUN Setting
- USB Power Supply
- Audio signals
- WPS Push
- Access Point Settings
- Edit Device Name
- Disp MAC Address
- SSID/PW Reset
- Airplane Mode
- Version
- Language
- Drop Sensor
- Demo Mode
- Initialize

[▲ Back to top](#)

Viewing images on a TV

Viewing an image on a High Definition (HD) TV

[Viewing an image on an HD TV using the HDMI Cable \(sold separately\)](#)

Viewing an image on a "BRAVIA" Sync-compatible TV

[Viewing an image on a "BRAVIA" Sync-compatible TV](#)

[▲ Back to top](#)

Using with your computer

Recommended computer environment

[Recommended computer environment](#)

Using the software

["PlayMemories Home" \(Windows\)](#)

[Installing "PlayMemories Home" \(Windows\)](#)

[Software for Mac](#)

["Image Data Converter"](#)

[Installing "Image Data Converter" \(Windows / Mac\)](#)

Importing images to a computer

[Connecting the camera to the computer](#)

[Importing images to a computer](#)

[To disconnect your camera from the computer](#)

Creating a disc of movies

[Selecting a method for creating a disc of movies](#)

[▲ Back to top](#)

Printing

Printing still images

[Printing still images](#)

[▲ Back to top](#)

Troubleshooting

If you have problems

[If you have problems](#)

Troubleshooting

[Battery pack and power](#)

[Shooting still images/movies](#)

[Viewing images](#)

[Wi-Fi](#)

[Computers](#)

[Memory card](#)

[Printing](#)

[Others](#)

Warning indicators and messages

[Self-diagnosis display](#)

[Messages](#)

Situations this camera has difficulty handling

[Situations this camera has difficulty handling](#)

[▲ Back to top](#)

| [Precautions / About this camera](#)

Precautions

[Precautions](#)

[On the internal rechargeable backup battery](#)

[Battery pack](#)

[Charging the battery pack](#)

[Memory card](#)

On cleaning

[On cleaning](#)

Number of still images and recordable time of movies

[Number of still images](#)

[Recordable time of movies](#)

Using the camera abroad

[Using the camera abroad](#)

[On TV color systems](#)

About this camera

[Carl Zeiss lens](#)

[AVCHD format](#)

[License](#)

Trademarks

[Trademarks](#)

[▲ Back to top](#)

Copyright 2013 Sony Corporation

- ▶ Before Use
- ▶ Operating the camera
- ▶ Shooting
- ▶ Viewing
- ▶ Useful shooting functions
- ▶ Useful viewing functions
- ▶ Changing settings
- ▶ Viewing images on a TV
- ▶ Using with your computer
- ▶ Printing
- ▶ Troubleshooting
- ▶ Precautions / About this camera

[→ Contents list](#)

How to use this User Guide

- ▼ [Selecting a topic to display](#)
- ▼ [Searching a topic by keyword](#)
- ▼ [Returning to a previous page](#)
- ▼ [Printing out a page](#)
- ▼ [Marks and notations used in this User Guide](#)

The images used as examples in this User Guide are reproduced images, and are not actual images shot using this camera.

Selecting a topic to display

The following illustrations take Internet Explorer 7 as an example.

1. Click a title in the side bar on the left of the browser window.
The title's topic list appears in the right pane.
2. Click a topic title in the list.

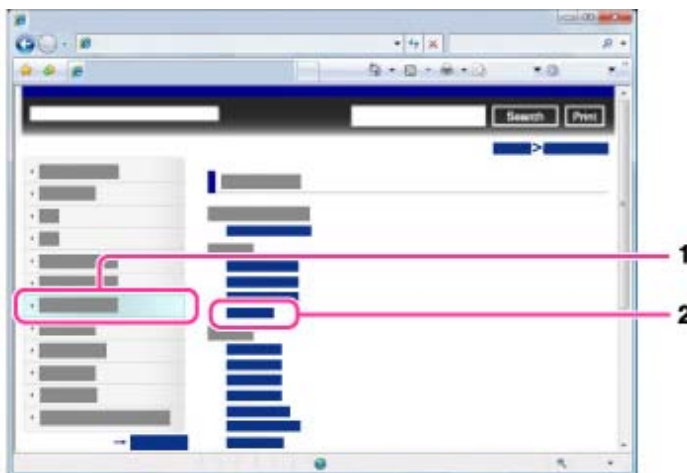

Descriptions appear in the right pane.



Changing the font size

Change the font size by changing the setting of your web browser. For how to change the font size setting, refer to the Help of your web browser.

Searching a topic by keyword

Enter the keyword in the search window, then click the [Search] button.

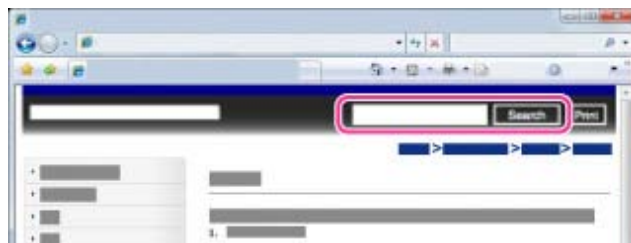

Returning to a previous page

Use the browser's back button to return to a previously viewed page, or use the breadcrumb trail navigation (A) to display the desired page.



Printing out a page

Click the [Print] button to print out the page you are viewing.

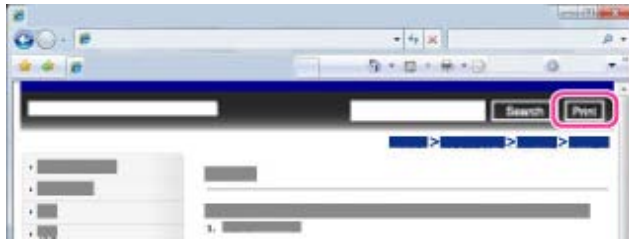

Marks and notations used in this User Guide

In this User Guide, the sequence of operations is shown by arrows (→) (A).
Operate the camera in the order indicated.

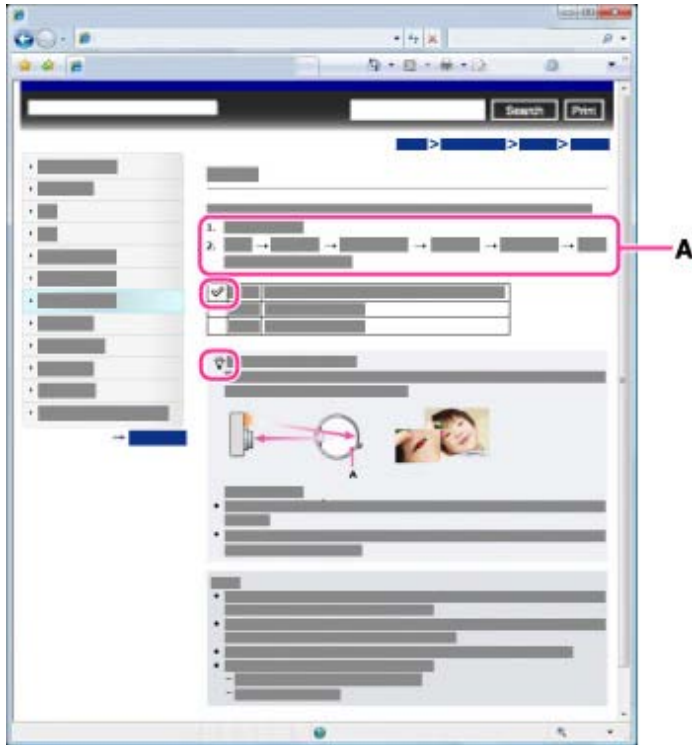

- Icons in the operating procedure sentences appear when the camera is in its default settings.
- The default setting is indicated by ✓.
- 💡 indicates information that is useful to know.

[▲ Back to top](#)

Copyright 2013 Sony Corporation

- ▶ Before Use
- ▶ Operating the camera
- ▶ Shooting
- ▶ Viewing
- ▶ Useful shooting functions
- ▶ Useful viewing functions
- ▶ Changing settings
- ▶ Viewing images on a TV
- ▶ Using with your computer
- ▶ Printing
- ▶ Troubleshooting
- ▶ Precautions / About this camera

[→ Contents list](#)

Names of parts

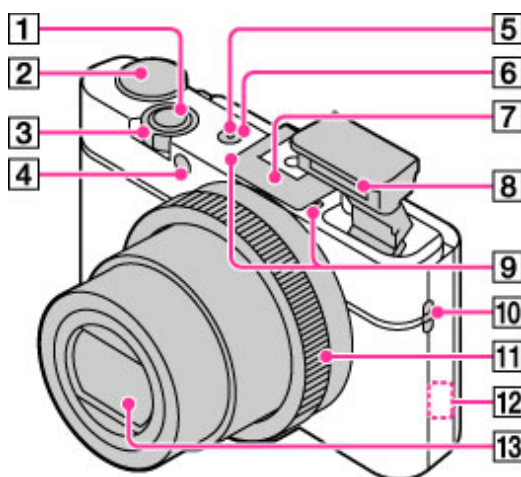

- 1** Shutter button
- 2** Mode dial
- 3** For shooting: W/T (zoom) lever
For viewing: Index/Playback zoom lever
- 4** Self-timer lamp/Smile Shutter lamp/AF illuminator
- 5** Power/Charge lamp
- 6** ON/OFF (Power) button
- 7** Multi interface shoe*
- 8** Flash
 - Do not cover the flash with your fingers.
 - When using the flash, the flash pops up automatically. If not using the flash, press it down manually.
- 9** Microphone
- 10** Hook for strap
- 11** Control Ring
- 12** Wi-Fi sensor (built-in)
- 13** Lens

* For details on compatible accessories for the multi interface shoe, visit the Sony web site, or consult your Sony dealer or local authorized Sony service facility. You can also use accessories that are compatible with the accessory shoe. Operations with other manufacturers' accessories are not guaranteed.



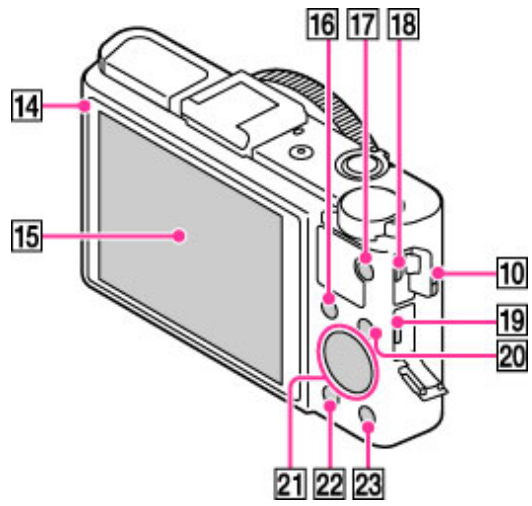

14 Light sensor

15 LCD screen

- Adjust the screen for a comfortable viewing angle to shoot in various positions.

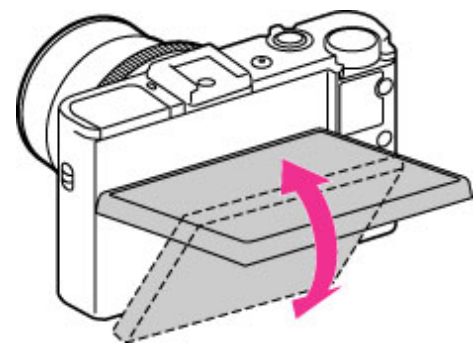

16 Fn (Function) button

17 MOVIE (Movie) button

18 Multi Terminal

- Supports Micro USB compatible device.

19 HDMI micro jack

20 MENU button

21 Control wheel

22  (Playback) button

23  (In-Camera Guide/Delete) button

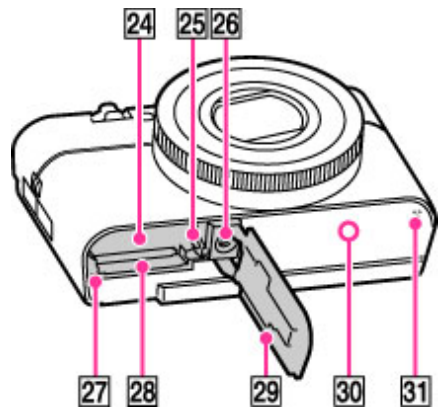

24 Battery insertion slot

25 Battery eject lever

26 Tripod socket hole

27 Access lamp

28 Memory card slot

29 Battery/Memory card cover

30  (N Mark)

- Touch the mark when you connect the camera to a smartphone equipped with the NFC function.
- NFC (Near Field Communication) is an international standard of the short-range wireless communication technology.

31 Speaker

[▲ Back to top](#)

Copyright 2013 Sony Corporation

Top page > Before Use > Names of parts and list of icons displayed on the screen > List of icons displayed on the screen

- ▶ Before Use
- ▶ Operating the camera
- ▶ Shooting
- ▶ Viewing
- ▶ Useful shooting functions
- ▶ Useful viewing functions
- ▶ Changing settings
- ▶ Viewing images on a TV
- ▶ Using with your computer
- ▶ Printing
- ▶ Troubleshooting
- ▶ Precautions / About this camera

[⇒ Contents list](#)

List of icons displayed on the screen

▼ List of shooting mode icons

▼ List of viewing mode icons

Icons are displayed on the screen to indicate camera status.
You can change the screen display using **DISP** on the control wheel.

List of shooting mode icons

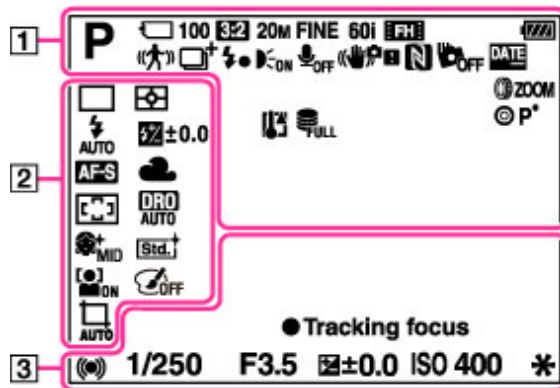



1

Display	Indication
	Shooting mode
	Memory recall
	Memory card/Upload
100	Number of recordable images
	Aspect ratio of still images
20M/18M/17M/13M/10M/7.5M/6.5M/5.0M/4.2M/3.7M/3.2M/VGA 	Image size of still images
RAW RAW+J FINE STD	Image quality of still images
60p 60i 50p 50i 24p 25p	Frame rate of movies
	Recording mode of movies
	Battery charge remaining
	Low battery warning
	Scene Recognition icon
	Scene Selection







	Overlay icon
	Flash charge in progress
	AF Illuminator
	Does not record sound during movie recording
	Wind Noise Reduction
	SteadyShot
	SteadyShot warning
	NFC active
	Airplane Mode
	Drop sensor off
	Write Date
	Control Ring function
	Control wheel function
	Overheating warning
	Database file full/Database file error
	Clear Image Zoom
	Digital Zoom
	Buffer writing
	Importing still images
	Still image recording unavailable
	Spot metering circle
	Self-diagnosis display
	Level

2

Display	Indication
	Drive Mode
	Metering Mode
	Flash Mode/Red Eye Reduction
	Flash compensation
	Focus Mode
	White Balance
	Autofocus Area
	DRO/Auto HDR
	Soft Skin Effect
	Creative Style
	Face detection/Smile Shutter

	Picture Effect
	Auto Object Framing
	Smile Detection Sensitivity indicator



3

Display	Indication
● Tracking focus	Tracking focus guide
REC 0:12	Recording time of the movie (m:s)
	Focus status
1/250	Shutter speed
F3.5	Aperture value
 +0.0	Metered manual
 +0.0	Exposure compensation
ISO400	ISO number
	AE lock
	Shutter speed indicator
	Aperture indicator
	Histogram

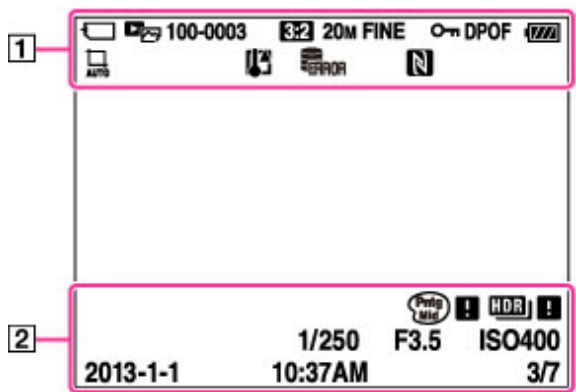
List of viewing mode icons



1

Display	Indication
	Memory card/Upload
	View Mode
100-0003	Folder-file number

3:2 16:9 4:3 1:1	Aspect ratio of still images
20M/18M/17M/13M/10M/7.5M/6.5M/5.0M/4.2M/3.7M/3.2M/VGA WIDE STD 16:9	Image size of still images
RAW RAW+J FINE STD	Image quality of still images
60p 60i 50p 50i 24p 25p	Frame rate of movies
FX FH PS 1080i VGA	Recording mode of movies
AVCHD MP4	File Format
Off	Protect
DPOF	Print order (DPOF)
	Battery charge remaining
	Low battery warning
	Overheating warning
	Database file full/Database file error
	NFC active
	Airplane Mode
	Auto Object Framing image

2

Display	Indication
	Picture Effect error
	Auto HDR image error
1/250	Shutter speed
F3.5	Aperture value
ISO400	ISO number
2013-1-1 10:37 AM	Recorded date/time of the playback image
3/7	Image number/Number of images recorded in selected View Mode

[▲ Back to top](#)

[▶ Before Use](#)[▶ Operating the camera](#)[▶ Shooting](#)[▶ Viewing](#)[▶ Useful shooting functions](#)[▶ Useful viewing functions](#)[▶ Changing settings](#)[▶ Viewing images on a TV](#)[▶ Using with your computer](#)[▶ Printing](#)[▶ Troubleshooting](#)[▶ Precautions / About this camera](#)[⇒ Contents list](#)

Using the wrist strap

Attach the strap and place your hand through the loop to prevent the camera from damage by being dropped.

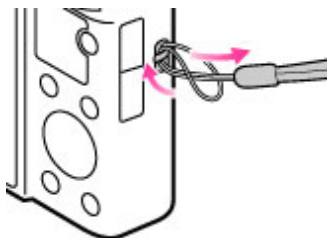
[▲ Back to top](#)

[Top page](#) > [Before Use](#) > [Using the shoulder strap](#) > [Using the shoulder strap \(sold separately\)](#)

▶ Before Use

▶ Operating the camera

▶ Shooting

▶ Viewing

▶ Useful shooting functions

▶ Useful viewing functions

▶ Changing settings

▶ Viewing images on a TV

▶ Using with your computer

▶ Printing

▶ Troubleshooting

▶ Precautions / About this camera

[⇒ Contents list](#)

Using the shoulder strap (sold separately)

Use the strap adapters (supplied) for attaching the shoulder strap (sold separately).

1. Attach the strap adapters to the hook for strap (two places).
2. Attach the shoulder strap (sold separately) to the strap adapters.

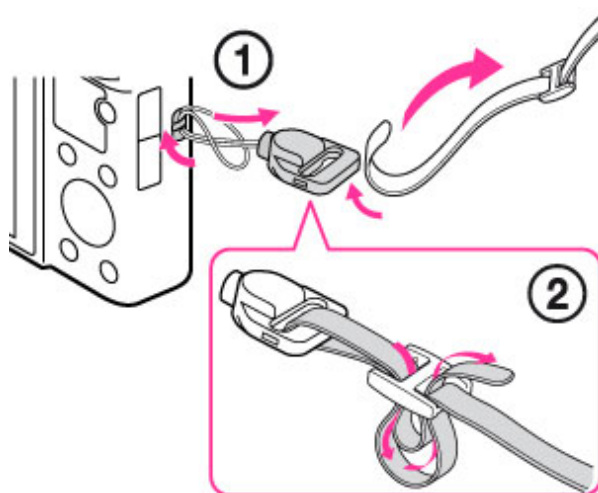

Notes

- Shoulder strap is sold separately.

[▲ Back to top](#)

[▶ Before Use](#)[▶ Operating the camera](#)[▶ Shooting](#)[▶ Viewing](#)[▶ Useful shooting functions](#)[▶ Useful viewing functions](#)[▶ Changing settings](#)[▶ Viewing images on a TV](#)[▶ Using with your computer](#)[▶ Printing](#)[▶ Troubleshooting](#)[▶ Precautions / About this camera](#)[⇒ Contents list](#)

In-Camera Guide

This allows you to display operation guides about MENU functions or settings.





1. Press the MENU button.
2. Select the desired MENU item using ▲ / ▼ on the control wheel.
3. Press the  (In-Camera Guide) button.
The operation guide for the MENU item you have selected in step 2 is displayed.

[▲ Back to top](#)





[▶ Before Use](#)[▶ Operating the camera](#)[▶ Shooting](#)[▶ Viewing](#)[▶ Useful shooting functions](#)[▶ Useful viewing functions](#)[▶ Changing settings](#)[▶ Viewing images on a TV](#)[▶ Using with your computer](#)[▶ Printing](#)[▶ Troubleshooting](#)[▶ Precautions / About this camera](#)[⇒ Contents list](#)

Shooting Tip

The camera displays shooting tips for the shooting mode selected.

1. Press  (In-Camera Guide) button in shooting mode.
2. Select the desired shooting tip using  /  on the control wheel, then press .

The shooting tip is displayed.

- You can scroll the screen using  / .
- You can refer to the other shooting tips using  / .

 To access all shooting tips

You can display all shooting tips by MENU →  5 → [Shooting Tip List].

[▲ Back to top](#)

- ▶ Before Use
- ▶ **Operating the camera**
- ▶ Shooting
- ▶ Viewing
- ▶ Useful shooting functions
- ▶ Useful viewing functions
- ▶ Changing settings
- ▶ Viewing images on a TV
- ▶ Using with your computer
- ▶ Printing
- ▶ Troubleshooting
- ▶ Precautions / About this camera

[→ Contents list](#)

Using the control wheel

- ▼ Moving the selection frame on the MENU screen, etc.
- ▼ Selecting an image to be played back

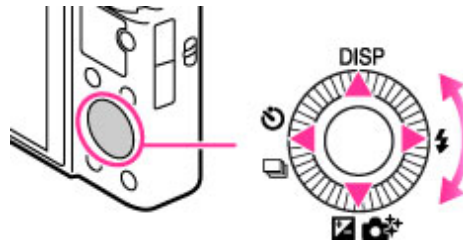

The following functions are located on the up/down/right/left side of the control wheel: **DISP** (Display Contents), ⚡ (Flash Mode), (Exposure Comp./Photo Creativity), (Drive Mode). You can also assign the desired function to the right/left button or ● in the center of the control wheel.

Press the control wheel toward each icon to enter the setup screen for each function.

Turn the control wheel or press the up/down/right/left side of the wheel following the screen to move the selection frame.

Press ● in the center of the control wheel to set the selected item.

▮ Moving the selection frame on the MENU screen, etc.

Turn the control wheel or press the up/down/right/left side of the wheel to move the selection frame. In some modes, you can also move the selection frame by turning the control wheel.

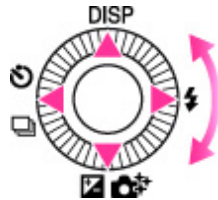

▮ Selecting an image to be played back

Press the right or left side of the control wheel, or turn the wheel to play back the next/previous image.

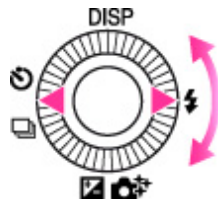

Related Topic

[Func. of Center Button](#)

[Func. of Left Button](#)

- ▶ [Before Use](#)
- ▶ [Operating the camera](#)
- ▶ [Shooting](#)
- ▶ [Viewing](#)
- ▶ [Useful shooting functions](#)
- ▶ [Useful viewing functions](#)
- ▶ [Changing settings](#)
- ▶ [Viewing images on a TV](#)
- ▶ [Using with your computer](#)
- ▶ [Printing](#)
- ▶ [Troubleshooting](#)
- ▶ [Precautions / About this camera](#)

[➡ Contents list](#)

How to use Control Ring

You can change the setting needed for each REC mode immediately by turning the control ring. In the default setting, the function that the camera recommends is assigned, but you can change the function to be assigned.

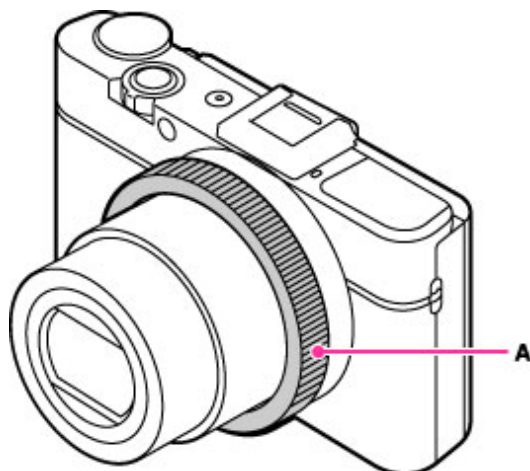

A: Control Ring

B: Active Control Ring function

C: Active control wheel function

For details on how to assign the functions, see "Control Ring." [\[Details\]](#)

Related Topic

[Control Ring](#)

[▲ Back to top](#)

[Top page](#) > [Operating the camera](#) > [Operating the camera](#) > [How to use the Fn \(Function\) button](#)

- ▶ Before Use
- ▶ **Operating the camera**
- ▶ Shooting
- ▶ Viewing
- ▶ Useful shooting functions
- ▶ Useful viewing functions
- ▶ Changing settings
- ▶ Viewing images on a TV
- ▶ Using with your computer
- ▶ Printing
- ▶ Troubleshooting
- ▶ Precautions / About this camera

[➔ Contents list](#)

How to use the Fn (Function) button

You can recall often-used functions by pressing the Fn (Function) button in shooting mode. Up to seven functions can be registered.

1. Press the Fn (Function) button in shooting mode.

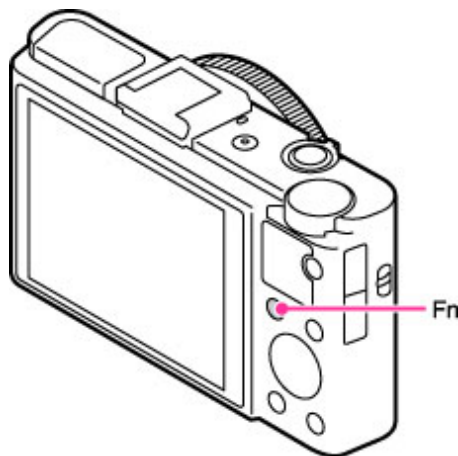

2. Select the desired function by pressing the Fn (Function) button repeatedly.
 - You can also select the desired function using ◀ / ▶ on the control wheel.

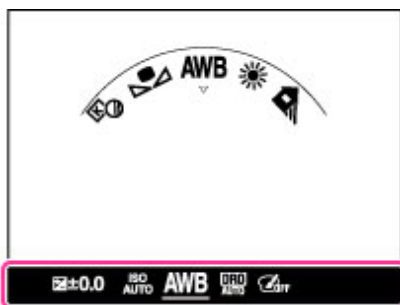

3. Set the desired mode or value by turning the control wheel or the Control Ring.
 - If the selected function setting can be further fine-tuned, press ▼ on the control wheel to display the setting screen.
 - To customize functions that are recalled when pressing the Fn (Function) button, see “Function Button.” [\[Details\]](#)

Related Topic

[Function Button](#)







[▲ Back to top](#)

- ▶ Before Use
- ▶ Operating the camera
- ▶ Shooting
- ▶ Viewing
- ▶ Useful shooting functions
- ▶ Useful viewing functions
- ▶ Changing settings
- ▶ Viewing images on a TV
- ▶ Using with your computer
- ▶ Printing
- ▶ Troubleshooting
- ▶ Precautions / About this camera

[→ Contents list](#)

Using MENU items

You can change general camera settings such as for shooting, playback, operating method, etc., and execute functions.

-  (Still shooting menu)
-  (Movie shooting menu)
-  (Custom menu)
-  (Viewing menu)
-  (Memory Card Tool menu)
-  (Clock setup menu)
-  (Setup menu)

1. Press the MENU button to display the Menu screen.

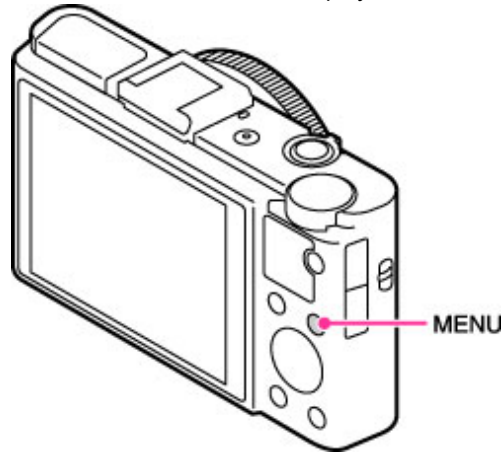

2. Select the desired Menu screen page using ◀ / ▶ on the control wheel.

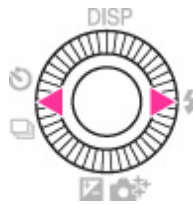

3. Select the desired item using ▲ / ▼ or by turning the control wheel, and then press ●.

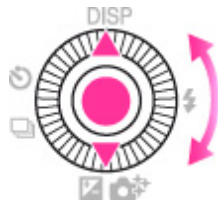

4. Select the desired item following the instructions on the screen, and then press ● to confirm.

[▲ Back to top](#)

- ▶ Before Use
- ▶ Operating the camera
- ▶ Shooting
- ▶ Viewing
- ▶ Useful shooting functions
- ▶ Useful viewing functions
- ▶ Changing settings
- ▶ Viewing images on a TV
- ▶ Using with your computer
- ▶ Printing
- ▶ Troubleshooting
- ▶ Precautions / About this camera

[➔ Contents list](#)

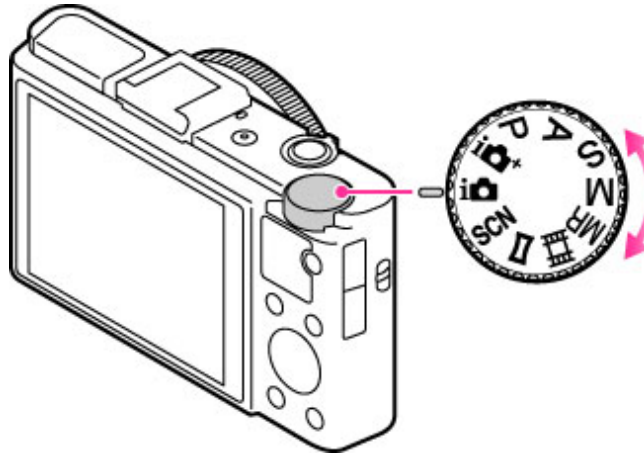

Shooting still images

1. Set the mode dial to  (Intelligent Auto).



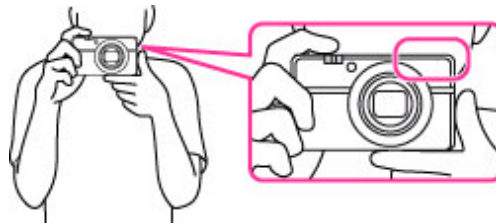



2. Hold the camera steady as illustrated.
 - Do not cover the flash with your fingers.

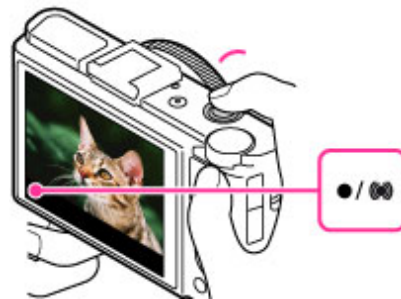

3. Press the shutter button halfway down to focus.
When the image is in focus, a beep sounds and the indicator ( or ) lights.



Focus indicator

-  lights: Image is in the focus.
-  lights: Image is in the focus. The focused position will change to suit the motion of the subject.
-  lights: The camera is in the progress of focusing.
-  flashes: The focusing is failed.

- The shortest shooting distance is approximately 5 cm (0.16 ft) (W), 55 cm (1.8 ft) (T) (from the lens).

4. Press the shutter button fully down.

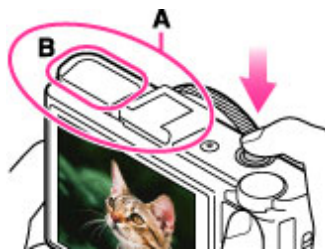

- Do not cover part (A), shown in the illustration.
- When using the flash, the flash (B) pops up automatically. If not using the flash, press it down manually.

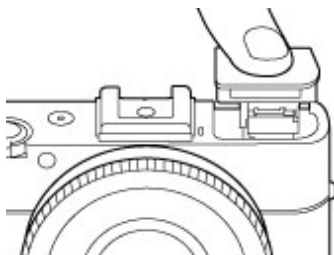

 If you shoot a still image of a subject that is difficult to focus on

- When the camera cannot focus automatically, the focus indicator flashes and the beep does not sound. Either recompose the shot or change the focus setting. [\[Details\]](#)
- Focusing may be difficult in the following situations:
 - It is dark and the subject is distant.
 - The contrast between the subject and the background is poor.
 - The subject is seen through glass.
 - The subject is moving quickly.
 - There is reflective light or shiny surfaces.
 - The subject is backlit or there is a flashing light.

Related Topic

[Viewing still images](#)

[Image Size](#)

[▲ Back to top](#)

Copyright 2013 Sony Corporation

- ▶ Before Use
- ▶ Operating the camera
- ▶ Shooting
- ▶ Viewing
- ▶ Useful shooting functions
- ▶ Useful viewing functions
- ▶ Changing settings
- ▶ Viewing images on a TV
- ▶ Using with your computer
- ▶ Printing
- ▶ Troubleshooting
- ▶ Precautions / About this camera

[→ Contents list](#)

Zoom (Still images)

▼ Available zoom

▼ Zoom scale

Enlarge images with the W/T (zoom) lever when shooting. The camera's optical zoom function can enlarge images up to 3.6×.

Optical zoom allows you to enlarge an image without deteriorating its original quality.

1. Set the camera to shooting mode.
2. Turn the W/T (zoom) lever.
 - Turn the lever to the T side to zoom in, or to the W side to zoom out.



- When zoom is assigned to the Control Ring, you can zoom in and zoom out also using the Control Ring. [\[Details\]](#)

Notes

- Zoom is locked to the W side in [Sweep Panorama] mode.

Available zoom

The camera achieves a high magnification zoom scale by combining zoom methods. The icon and zoom bar on the screen change in accordance with the zoom you use.

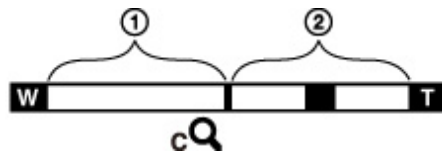

① Optical zoom range

The camera's optical zoom function can enlarge images up to 3.6×.

② Zoom range other than optical zoom

Zoom with the original image quality

When [Image Size] is set to other than [L], you can shoot still images with no deterioration in the original image quality, even if the optical zoom scale exceeds 3.6× magnification, by trimming image processing.



(cQ) [Clear Image Zoom]

Zoom with close to the original image quality [\[Details\]](#)

(DQ) [Digital Zoom]

Less than the original image quality [\[Details\]](#)

Operation	Settings	Zoom bar
	[Image Size]: [L]	

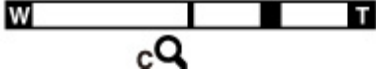
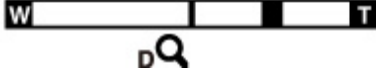
Using optical zoom only	[Clear Image Zoom]: [Off] [Digital Zoom]: [Off]	
Zooming images without deterioration	[Image Size]: Other than [L] [Clear Image Zoom]: [Off] [Digital Zoom]: [Off]	
Shooting clear images using [Clear Image Zoom] (close to the original image quality)	[Clear Image Zoom]: [On] [Digital Zoom]: [Off]	
Zooming to the maximum zoom range	[Clear Image Zoom]: [On] [Digital Zoom]: [On] • [Clear Image Zoom] may not be available for some settings. [Details]	

Zoom scale

The supported zoom scales are different depending on the settings or the image size. The table below summarizes the zoom scales when [Clear Image Zoom] and [Digital Zoom] are set to [On], and [Aspect Ratio] is set to [3:2].

Image Size	Optical zoom	Zoom with [Clear Image Zoom] [On]	Zoom with maximum zoom scale*
L: 20M	3.6×	7.2×	14×
M: 10M	3.6×	10×	20×
S: 5.0M	3.6×	14×	28×

* The maximum zoom scale is the magnification when [Clear Image Zoom] is set to [On] and [Digital Zoom] is set to [On]. The maximum zoom scale varies depending on the settings. [\[Details\]](#)

Notes

- The default setting for [Clear Image Zoom] is [Off]. [\[Details\]](#)
- The default setting for [Digital Zoom] is [Off]. Set [Digital Zoom] to [On] to enlarge images even with deterioration. [\[Details\]](#)
- The default setting for [Image Size] is [L]. To change the zoom scale, change [Image Size]. [\[Details\]](#)
- When [Image Size] is set to [VGA], [Digital Zoom] is limited; the maximum zoom scale is 54×
- Zoom functions other than the optical zoom are not available when shooting in the following situations:
 - When the Smile Shutter function is activated
 - When [Drive Mode] is set to [Self-portrait]
 - When [Quality] is set to [RAW] or [RAW & JPEG]
- The Face Detection function does not operate when you use other than the optical zoom.

[▲ Back to top](#)

- ▶ [Before Use](#)
- ▶ [Operating the camera](#)
- ▶ [Shooting](#)
- ▶ [Viewing](#)
- ▶ [Useful shooting functions](#)
- ▶ [Useful viewing functions](#)
- ▶ [Changing settings](#)
- ▶ [Viewing images on a TV](#)
- ▶ [Using with your computer](#)
- ▶ [Printing](#)
- ▶ [Troubleshooting](#)
- ▶ [Precautions / About this camera](#)

[➡ Contents list](#)

Shooting movies

You can start recording a movie by pressing the MOVIE (Movie) button, regardless of the position of the mode dial.

1. Press the MOVIE button to start recording.

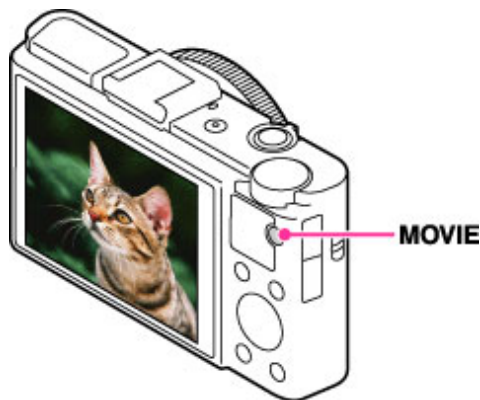

- To adjust the shutter speed and aperture value to the desired settings, set the mode dial to  (Movie).
2. Press the MOVIE button again to stop recording.

Notes

- The sound of the lens and lever operating will be recorded when the zoom function operates while shooting a movie. The sound of the MOVIE button operating may also be recorded when you press the MOVIE button to stop recording.
- Continuous shooting is possible for approximately 29 minutes at one time at the camera's default settings and when the temperature is approximately 25°C (77°F). When movie recording is finished, you can restart recording by pressing the MOVIE button again. Recording may stop to protect the camera depending on the ambient temperature.

Related Topic

[Zoom \(Movies\)](#)

[Shooting still images while recording a movie \(Dual Rec\)](#)

[Movie](#)

[File Format](#)

[▲ Back to top](#)

- ▶ Before Use
- ▶ Operating the camera
- ▶ Shooting
- ▶ Viewing
- ▶ Useful shooting functions
- ▶ Useful viewing functions
- ▶ Changing settings
- ▶ Viewing images on a TV
- ▶ Using with your computer
- ▶ Printing
- ▶ Troubleshooting
- ▶ Precautions / About this camera

[⇒ Contents list](#)

Zoom (Movies)

Enlarge images with the W/T (zoom) lever when shooting. The camera's optical zoom function can enlarge images up to 3.6×.

Optical zoom allows you to enlarge an image without deteriorating its original quality.

1. Set the camera to shooting mode.
2. Turn the W/T (zoom) lever.
 - Turn the lever to the T side to zoom in, or to the W side to zoom out.



- When zoom is assigned to the Control Ring, you can zoom in and zoom out also using the Control Ring. [\[Details\]](#)

Available zoom

When zooming, you can exceed the 3.6× optical zoom. During movie shooting, the digital zoom always operates when the zoom scale exceeds 3.6×, even if [Digital Zoom] is set to [Off]. The camera can enlarge images up to 14×.



- ① Optical zoom range
Optical zoom: The camera's optical zoom function can enlarge images up to 3.6×.
- ② Zoom range other than optical zoom
[Digital Zoom]: Less than original image quality [\[Details\]](#)

Notes

- [Clear Image Zoom] is not available while recording movies.
- The camera zooms slowly while recording movies.

[▲ Back to top](#)

[Top page](#) > [Shooting](#) > [Shooting movies](#) > [Shooting still images while recording a movie \(Dual Rec\)](#)

- ▶ Before Use
- ▶ Operating the camera
- ▶ Shooting
- ▶ Viewing
- ▶ Useful shooting functions
- ▶ Useful viewing functions
- ▶ Changing settings
- ▶ Viewing images on a TV
- ▶ Using with your computer
- ▶ Printing
- ▶ Troubleshooting
- ▶ Precautions / About this camera

[➔ Contents list](#)

Shooting still images while recording a movie (Dual Rec)

You can shoot still images while recording a movie. The camera keeps recording the movie even when you shoot still images.

1. Press the MOVIE (Movie) button to start recording a movie.

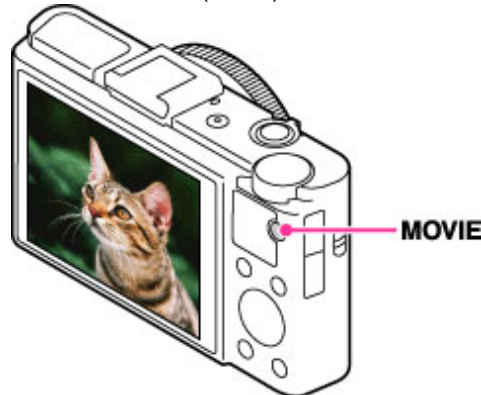

2. Press the shutter button.
A still image is recorded.
 - The number of recordable still images (A) appears on the screen when you press the shutter button halfway down.



3. Press the MOVIE button to stop recording the movie.

Using the Smile Shutter while recording movies

Set the mode dial to  (Movie) and press the MOVIE button after activating the Smile Shutter. A still image is shot automatically when a smile is detected while recording movies.

Notes

- When [Record Setting] is set to [60p 28M(PS)]/[50p 28M(PS)], you cannot use the Dual Rec.
- The sound of the shutter button operating may be recorded.
- Flash is not available for shooting still images during movie recording.
- The size of still image that can be shot while recording a movie varies depending on the movie recording setting. For details, see "Image Size(Dual Rec)." [\[Details\]](#)
- When Dual Rec recording is unavailable, the  (still image recording unavailable) indicator appears on the screen.

[▲ Back to top](#)

- ▶ Before Use
- ▶ Operating the camera
- ▶ Shooting
- ▶ Viewing
- ▶ Useful shooting functions
- ▶ Useful viewing functions
- ▶ Changing settings
- ▶ Viewing images on a TV
- ▶ Using with your computer
- ▶ Printing
- ▶ Troubleshooting
- ▶ Precautions / About this camera

[➔ Contents list](#)

List of mode dial functions

Set the mode dial to the desired function.

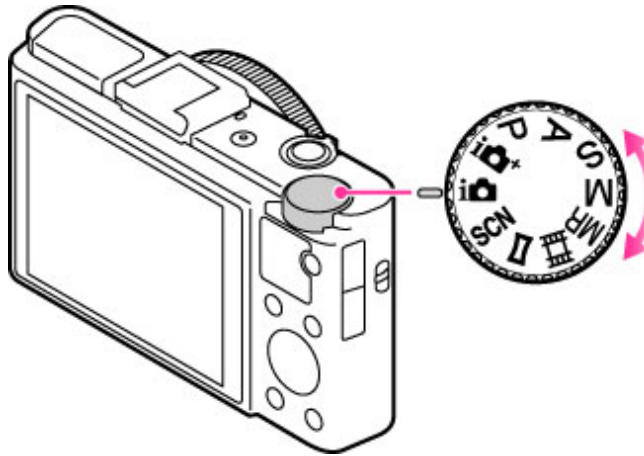

iA (Intelligent Auto)	Allows you to shoot still images with the settings adjusted automatically.
iA+ (Superior Auto)	Allows you to shoot still images in higher quality than with Intelligent Auto mode.
P (Program Auto)	Allows you to shoot with the exposure adjusted automatically (both the shutter speed and the aperture value (F value)). Also you can select various settings using the menu.
A (Aperture Priority)	Allows you to adjust the focus range or degree of background defocus.
S (Shutter Priority)	Allows you to shoot fast-moving subjects etc., by manually adjusting the shutter speed.
M (Manual Exposure)	Allows you to shoot after manually adjusting the exposure (both the shutter speed and the aperture (F value)).
MR (Memory recall)	Allows you to shoot an image after recalling often-used modes or numeric settings registered in advance.
Movie (Movie)	Allows you to change the setting for movie recording.
Sweep Panorama	Allows you to shoot a panoramic image after composing the image.
SCN (Scene Selection)	Allows you to shoot with preset settings according to the scene.

Related Topic

[Intelligent Auto](#)

[Superior Auto](#)

[Program Auto](#)

[Aperture Priority](#)

[Shutter Priority](#)

[Manual Exposure](#)

[Memory recall](#)

[Movie](#)

[Sweep Panorama](#)

[Scene Selection](#)

[▲ Back to top](#)

Copyright 2013 Sony Corporation

- ▶ Before Use
- ▶ Operating the camera
- ▶ Shooting
- ▶ Viewing
- ▶ Useful shooting functions
- ▶ Useful viewing functions
- ▶ Changing settings
- ▶ Viewing images on a TV
- ▶ Using with your computer
- ▶ Printing
- ▶ Troubleshooting
- ▶ Precautions / About this camera

[⇒ Contents list](#)

Intelligent Auto

▼ Scene Recognition

▼ Features of Auto shooting modes













Allows you to shoot still images with the settings adjusted automatically.

1. Set the mode dial to  (Intelligent Auto).
2. Shoot with the shutter button.



■ Scene Recognition

Scene Recognition operates in [Intelligent Auto] mode. This function lets the camera automatically recognize the shooting conditions and shoot the image.



In Scene Recognition, the position of an icon displayed on the screen differs depending on whether the camera recognizes a scene or condition. If the camera recognizes a scene, icons and guides such as , , , , , , , ,  or  are displayed on the first line. If the camera recognizes a condition, icons such as ,  or  are displayed on the second line. The camera may recognize both a scene and condition, or just one.





Notes

- Scene Recognition function does not operate when you use zoom functions other than the optical zoom.
- These scenes may not be recognized depending on the situation.
- If the environment causes vibrations to be transferred to the camera even when the camera is fixed to a tripod,  (Tripod) condition may not be recognized.
- Sometimes a slow shutter results when  (Tripod) and  (Night Scene) condition are recognized at the same time. Keep the camera still during shooting.

■ Features of Auto shooting modes

In [Superior Auto] mode, the camera shoots a higher-quality image than in [Intelligent Auto] mode. The camera also shoots multiple images based on the recognized scene, then creates a composite of the multiple images (Overlay shooting).

[Program Auto] mode allows you to change various shooting settings, such as the white balance or ISO settings.

REC Mode	When to use
 (Intelligent Auto)	<ul style="list-style-type: none"> • Use when you want the camera to automatically recognize the shooting conditions and shoot some images continuously.
 (Superior Auto)	<ul style="list-style-type: none"> • Use when you shoot images under difficult conditions, such as low light or backlit scenes. • Use when you want to shoot a higher-quality image than in  (Intelligent Auto) mode.
 (Program Auto)	<ul style="list-style-type: none"> • Use when you want to shoot using customized shooting settings, except the exposure (both the shutter speed and the aperture value) which are adjusted automatically.

Notes

- In [Intelligent Auto] mode, you may be unable to shoot low light or backlit scenes clearly.
- In [Superior Auto] mode, it takes some time to record an image, because the camera overlays the images.

Related Topic

[Functions not available for each shooting mode](#)

[MENU items not available for each shooting mode](#)

[▲ Back to top](#)

Copyright 2013 Sony Corporation

- ▶ Before Use
- ▶ Operating the camera
- ▶ Shooting
- ▶ Viewing
- ▶ Useful shooting functions
- ▶ Useful viewing functions
- ▶ Changing settings
- ▶ Viewing images on a TV
- ▶ Using with your computer
- ▶ Printing
- ▶ Troubleshooting
- ▶ Precautions / About this camera

[⇒ Contents list](#)

Superior Auto

The camera combines Scene Recognition and high-quality image technology to automatically shoot images with the optimal settings.

For details on the Scene Recognition function, see “Scene Recognition.” [\[Details\]](#)

1. Set the mode dial to  (Superior Auto).
2. Shoot with the shutter button.

The camera shoots burst images when needed and overlays the multiple images. By overlaying the images, the camera records an image with less subject blur and noise.



 What is the difference between [Superior Auto] mode and [Intelligent Auto] mode?

In [Superior Auto] mode, the camera shoots burst images based on the recognized scene, then creates a composite of the burst images (Overlay shooting).

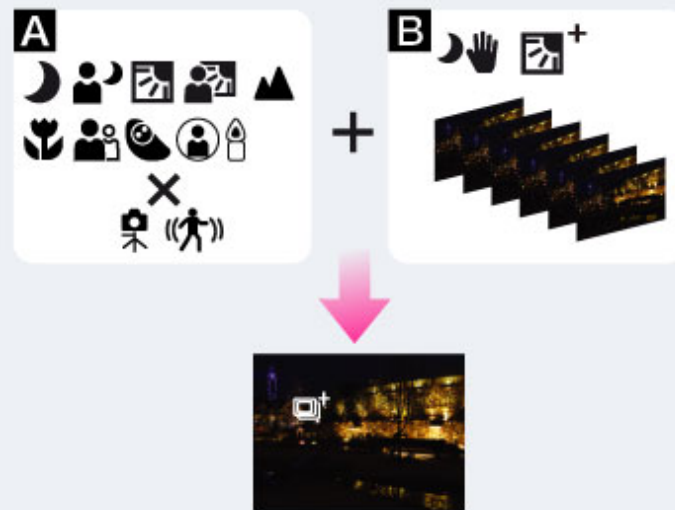
The camera automatically corrects the backlight and reduces the noise by overlaying images, so a higher-quality image results than in [Intelligent Auto] mode.



A : Scene Recognition

-  Night Scene
-  Night Portrait
-  Backlight
-  Backlight Portrait
-  Landscape
-  Macro
-  Portrait
-  Baby
-  Spotlight
-  Low Brightness
-  Tripod
-  Move

B : Overlaying processing

 Hand-held Twilight

 Backlight Correction HDR

- The camera automatically selects an overlaying mode based on the recognized scene, and  (overlay) appears on the screen.

Notes

- When the camera overlays the images, it takes more time to record an image.
- In low light conditions such as night scenes, set [Flash Mode] to [Flash Off] to achieve the optimal effect of the overlaid images.
- When [Quality] is set to [RAW] or [RAW & JPEG], the camera does not overlay the images.

Related Topic

[Functions not available for each shooting mode](#)

[MENU items not available for each shooting mode](#)

[▲ Back to top](#)

Copyright 2013 Sony Corporation

- ▶ Before Use
- ▶ Operating the camera
- ▶ Shooting
- ▶ Viewing
- ▶ Useful shooting functions
- ▶ Useful viewing functions
- ▶ Changing settings
- ▶ Viewing images on a TV
- ▶ Using with your computer
- ▶ Printing
- ▶ Troubleshooting
- ▶ Precautions / About this camera

[⇒ Contents list](#)

Program Auto

Allows you to shoot with the exposure adjusted automatically (both the shutter speed and the aperture value). Also you can select various settings using the menu.

1. Set the mode dial to **P** (Program Auto).
2. Shoot with the shutter button.

Program shift

You can change the aperture (F value) and shutter speed combination while keeping the exposure fixed when flash is set to [Flash Off].

1. Turn the control wheel.
 - “P” on the screen changes to “P*” and the shooting mode changes to program shift.
2. Turn the control wheel to select the aperture (F value) and shutter speed combination.
3. Shoot with the shutter button.
 - To cancel program shift, turn the control wheel to return the indication to “P”.



Notes

- According to the brightness of the environment, the program shift may not be used.
- Set the mode dial to the one other than “P” or turn off the power to cancel the setting you made.
- When the brightness changes, the aperture (F value) and shutter speed also change while maintaining the shift amount.
- When [Flash Mode] setting is changed, program shift is canceled.

Related Topic

[Functions not available for each shooting mode](#)

[MENU items not available for each shooting mode](#)

[▲ Back to top](#)

- ▶ Before Use
- ▶ Operating the camera
- ▶ Shooting
- ▶ Viewing
- ▶ Useful shooting functions
- ▶ Useful viewing functions
- ▶ Changing settings
- ▶ Viewing images on a TV
- ▶ Using with your computer
- ▶ Printing
- ▶ Troubleshooting
- ▶ Precautions / About this camera

[➡ Contents list](#)

Aperture Priority

Allows you to adjust the focus range or degree of background defocus.

1. Set the mode dial to **A** (Aperture Priority).
2. Turn the control wheel to select the aperture (F value).
 - When [Aperture Priority] is assigned to the Control Ring, you can set it also using the Control Ring. [\[Details\]](#)



- You can select an aperture (F value) from F1.8 to F11. (When you turn the W/T (zoom) lever to the T side, the minimum aperture (F value) will increase.)
 - The shutter speed is automatically adjusted from 1/2000 seconds to 8 seconds.
3. Shoot with the shutter button.

About aperture

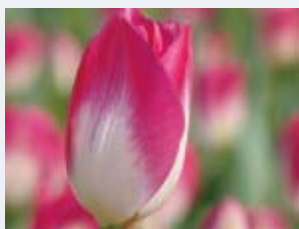

The lower the aperture (F value), the wider the hole that lets light pass through. The depth of focus decreases, and everything except objects within a narrow range of distance will be out of focus. This is good for portraits, etc.



The higher the aperture (F value), the smaller the hole that lets light pass through. Both objects relatively close and far away from the lens will appear sharp. This is good for landscapes, etc.

Notes

- If the proper exposure is not obtained after making the settings, the setting value indicators on the

screen flash. You can shoot in this condition, but we recommend that you adjust the flashing values again.

- The brightness of the image displayed on the screen may differ from the actual recorded image.

Related Topic

[Functions not available for each shooting mode](#)

[MENU items not available for each shooting mode](#)

[▲ Back to top](#)

Copyright 2013 Sony Corporation

- ▶ Before Use
- ▶ Operating the camera
- ▶ Shooting
- ▶ Viewing
- ▶ Useful shooting functions
- ▶ Useful viewing functions
- ▶ Changing settings
- ▶ Viewing images on a TV
- ▶ Using with your computer
- ▶ Printing
- ▶ Troubleshooting
- ▶ Precautions / About this camera

[⇒ Contents list](#)

Shutter Priority

You can shoot still images after adjusting the shutter speed manually.

1. Set the mode dial to **S** (Shutter Priority).
2. Turn the control wheel to select the shutter speed value.
 - When [Shutter Priority] is assigned to the Control Ring, you can set it also using the Control Ring. [\[Details\]](#)



- You can select a shutter speed from 1/2000 seconds to 30 seconds.
3. Shoot with the shutter button.

About shutter speed



When you set the shutter speed faster, moving objects such as running people, cars or splashing water, etc., appear stopped.



When you set the shutter speed slower, the traces of moving objects such as a river current etc., appear. You can shoot more natural live action images.

Notes

- When the shutter speed is fast, the amount of flash light may be insufficient even if you fire the flash.
- If the proper exposure is not obtained after making the settings, the setting value indicators on the screen flash. You can shoot in this condition, but we recommend that you adjust the flashing values

again.

- Shutter speed of 0.4 seconds or longer is indicated by ["], for example, 0.4".
- When you set the shutter speed slower, using a tripod is recommended to prevent the effects of vibration.
- If you select slow shutter speeds, it takes time to process the data.

Related Topic

[Functions not available for each shooting mode](#)

[MENU items not available for each shooting mode](#)

[▲ Back to top](#)

Copyright 2013 Sony Corporation

- ▶ Before Use
- ▶ Operating the camera
- ▶ Shooting
- ▶ Viewing
- ▶ Useful shooting functions
- ▶ Useful viewing functions
- ▶ Changing settings
- ▶ Viewing images on a TV
- ▶ Using with your computer
- ▶ Printing
- ▶ Troubleshooting
- ▶ Precautions / About this camera

[→ Contents list](#)

Manual Exposure

▼ BULB

You can shoot at your favorite exposure by manually setting the shutter speed and aperture value.

1. Set the mode dial to **M** (Manual Exposure).
2. Press ▼ on the control wheel to select the shutter speed or aperture (F value).
 - Each time you press ▼, the item to be set will change.
3. Turn the control wheel to select a value.

Control wheel	Feature
▼	Moving items
]	Shutter speed or aperture (F value) settings

- When [Aperture Priority] or [Shutter Priority] is assigned to the Control Ring, you can set it also using the Control Ring.
 - Select a shutter speed from 1/2000 seconds to 30 seconds. You can also shoot in [BULB] mode.
 - When zoom is set fully to W, you can select an aperture from F1.8 to F11.
When zoom is set fully to T, you can select an aperture from F4.9 to F11.
4. Press the shutter button to shoot the image.

💡 Setting the shutter speed and aperture (F value)

The difference between the value you set and the proper exposure judged by the camera appears as a metered manual (MM) value on the screen.



- A: Shutter speed value
- B: Aperture value
- C: Metered manual (MM)

- If you set the exposure value toward +, the images become brighter; toward –, the images become darker. “0” indicates the appropriate exposure as analyzed by the camera.
- Shutter speed of 0.4 seconds or longer is indicated by [“.”], for example, 0.4”.
- When you set the shutter speed slower, using a tripod is recommended to prevent the effects of vibration.
- If you select slow shutter speeds, it takes time to process the data.

Notes

- [ISO AUTO] cannot be selected for [ISO] in [Manual Exposure] mode.
- If proper exposure is not obtained by your settings, the setting value indicators on the screen will

flash. You can shoot in this condition, but exposure readjustment is recommended.

BULB

You can shoot trails with long exposure. [BULB] is suitable for shooting trails of light, such as fireworks.

1. Set the mode dial to **M** (Manual Exposure).
2. Press **▼** on the control wheel to select shutter speed.
3. Turn the control wheel counterclockwise until [BULB] is indicated.



4. Press the shutter button halfway down to adjust the focus.
5. Press and hold the shutter button for the duration of the shooting.
As long as the shutter button is pressed, the shutter remains open.

Notes

- Since the shutter speed becomes slow and the camera shake tends to occur more easily, it is recommended that you use a tripod.
- The longer the exposure time, the more conspicuous the noise on the image.
- After shooting, noise reduction (Long Exposure NR) will be done for the same amount of time that the shutter was open. You cannot do any further shooting during the reduction.
- When the [Smile Shutter] or [Auto HDR] function is activated, you cannot set the shutter speed to [BULB].
- If the [Smile Shutter] or [Auto HDR] function is used with the shutter speed set to [BULB], the shutter speed is temporarily set to 30 seconds.

Related Topic

[Functions not available for each shooting mode](#)

[MENU items not available for each shooting mode](#)

[▲ Back to top](#)

Copyright 2013 Sony Corporation

- ▶ Before Use
- ▶ Operating the camera
- ▶ Shooting
- ▶ Viewing
- ▶ Useful shooting functions
- ▶ Useful viewing functions
- ▶ Changing settings
- ▶ Viewing images on a TV
- ▶ Using with your computer
- ▶ Printing
- ▶ Troubleshooting
- ▶ Precautions / About this camera

[⇒ Contents list](#)

Memory recall

Allows you to shoot an image after recalling often-used modes or camera settings registered in advance.

1. Set the mode dial to **MR** (Memory recall).
2. Press ◀ / ▶ on the control wheel or turn the control wheel to select the desired number → ●
 - If you want to select another number, press the MENU button →  5 → [Memory recall].

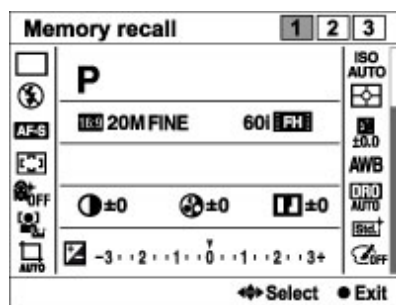

Notes

- Register shooting settings in advance by [Memory]. [\[Details\]](#)
- If you set **MR** (Memory recall) after completing the shooting settings, the registered settings are given priority and the original settings may become invalid. Check the indicators on the screen before shooting.

Related Topic

Memory

Functions not available for each shooting mode

MENU items not available for each shooting mode



[▲ Back to top](#)





- ▶ Before Use
- ▶ Operating the camera
- ▶ Shooting
- ▶ Viewing
- ▶ Useful shooting functions
- ▶ Useful viewing functions
- ▶ Changing settings
- ▶ Viewing images on a TV
- ▶ Using with your computer
- ▶ Printing
- ▶ Troubleshooting
- ▶ Precautions / About this camera

[➡ Contents list](#)

Movie

You can set the shutter speed and aperture value to your desired settings while recording movies.

1. Set the mode dial to  (Movie).
2. Select the desired mode → ● on the control wheel.
 - When [Mode Dial Guide] is set to [Off], the mode selection screen does not appear.
 - If you want to select another mode, press the MENU button → 1 → [Movie].

	 (Program Auto)	The camera sets the exposure (shutter speed and aperture value) automatically, but you can set other settings and the settings will be retained.
	 (Aperture Priority)	Sets the aperture value manually.
	 (Shutter Priority)	Sets the shutter speed manually.
	 (Manual Exposure)	Sets the exposure (shutter speed and aperture value) manually.

3. Press the MOVIE (Movie) button to record movies.

Related Topic

[Functions not available for each shooting mode](#)

[MENU items not available for each shooting mode](#)

[▲ Back to top](#)



- ▶ Before Use
- ▶ Operating the camera
- ▶ Shooting
- ▶ Viewing
- ▶ Useful shooting functions
- ▶ Useful viewing functions
- ▶ Changing settings
- ▶ Viewing images on a TV
- ▶ Using with your computer
- ▶ Printing
- ▶ Troubleshooting
- ▶ Precautions / About this camera

[⇒ Contents list](#)

Sweep Panorama

Allows you to create a panoramic image from composite images.



1. Set the mode dial to  (Sweep Panorama).
2. Turn the Control Ring to select a shooting direction.
When another function is assigned to the Control Ring, press the MENU button →  → [Panorama: Direction].
3. Point the camera at the subject you want to adjust the brightness and focus for, then press the shutter button halfway.



A: This part will not be recorded.

4. With the shutter button pressed halfway, point the camera at the start of the composition, then press the shutter button fully down.
5. Pan the camera to the end of the guide (B), following the indicator on the screen.



Tips for shooting a panoramic image

Hold the camera as close to the body as possible with elbows pressed against your sides, then pan the camera around you in an arc, at a steady speed, in the direction of the arrow indicated on the screen. (Aim for 5 or 6 seconds for a half circle.)

It is recommended that you practice a few times before shooting.

For best effect, ensure that the distance between subject and background is sufficient, and there is enough ambient light.

Vertical direction

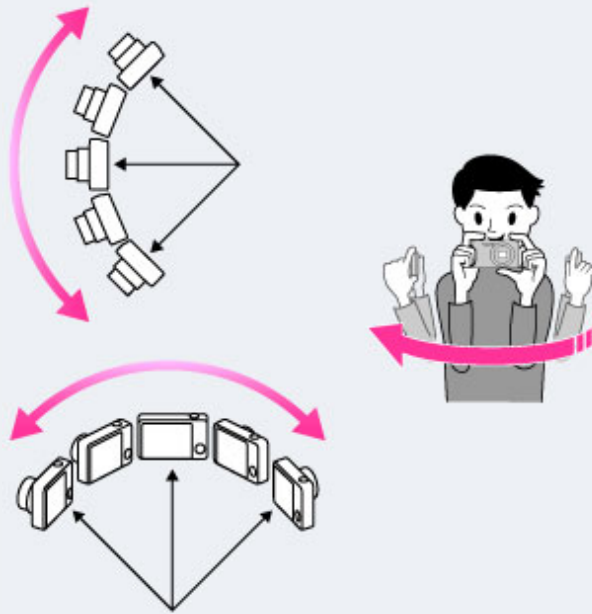

Horizontal direction

- First press the shutter button halfway so that you can lock the focus and exposure. Then press the shutter button fully down and pan or tilt the camera.
- If a section with greatly varied shapes or scenery is concentrated along a screen edge, the image composition may fail. In such a case, adjust the frame composition so that the section is in the center of the image, then shoot again.

Notes

- If you cannot pan the camera across the entire subject within the given time, a gray area occurs in the composite image. If this happens, move the camera faster to record a full panoramic image.
- Since several images are stitched together, the stitched part may not be recorded smoothly.
- When the whole angle of panoramic shooting and the AE/AF locked angle are very different in brightness, color and focus, the shooting may not be successful. If this happens, change the AE/AF locked angle and shoot again.
- You cannot create panoramic images in the following situations:
 - You pan the camera too quickly or too slowly.
 - There is too much camera shake.

Related Topic

[Scrolling panoramic images for display](#)

[Panorama: Size](#)

[Panorama: Direction](#)

[Functions not available for each shooting mode](#)

[MENU items not available for each shooting mode](#)

[▲ Back to top](#)









- ▶ Before Use
- ▶ Operating the camera
- ▶ Shooting
- ▶ Viewing
- ▶ Useful shooting functions
- ▶ Useful viewing functions
- ▶ Changing settings
- ▶ Viewing images on a TV
- ▶ Using with your computer
- ▶ Printing
- ▶ Troubleshooting
- ▶ Precautions / About this camera















[➡ Contents list](#)

Scene Selection

Allows you to shoot with preset settings according to the scene.

1. Set the mode dial to **SCN** (Scene Selection).
2. Select the desired mode → ● on the control wheel.
 - When [Mode Dial Guide] is set to [Off], the mode selection screen does not appear.
 - Use the Control Ring to select another [Scene Selection] mode. When another function is assigned to the Control Ring, press the MENU button →  5 → [Scene Selection].

 (Portrait)	<p>Allows you to blur backgrounds and sharpen the subject. Expresses skin tones softly.</p> 
 (Anti Motion Blur)	<p>Allows you to shoot indoor shots without using the flash to reduce subject blur.</p> 
 (Sports Action)	<p>Allows you to shoot a moving subject at a fast shutter speed so that the subject looks as if it is standing still. The camera shoots images continuously while the shutter button is pressed.</p> 
 (Pet)	<p>Allows you to shoot images of your pet with the best settings.</p> 
	<p>Allows you to shoot food arrangements in delicious and bright colors.</p>

 (Gourmet)	
 (Macro)	<p>Allows you to shoot a flower or other small item from close up.</p> 
 (Landscape)	<p>Allows you to shoot the entire range of scenery in sharp focus with vivid colors.</p> 
 (Sunset)	<p>Allows you to shoot the reds of the sunset or sunrise beautifully.</p> 
 (Night Scene)	<p>Allows you to shoot night scenes without losing the dark atmosphere.</p> 
 (Hand-held Twilight)	<p>Allows you to shoot night scenes with less noise without using a tripod. A burst of shots are taken, and image processing is applied to reduce subject blur, camera shake, and noise.</p> 
 (Night Portrait)	<p>Allows you to shoot sharp images of people with a night view in the background.</p> 
<p>Allows you to record fireworks in all their splendor.</p>	

(Fireworks)





ISO (High Sensitivity)



Allows you to shoot images without a flash under low light conditions, reducing blur.

Notes

- When you shoot images using  (Night Scene),  (Night Portrait) or  (Fireworks) modes, the shutter speed is slower and the images tend to blur. To prevent blurring, the use of a tripod is recommended.

Related Topic

[Functions not available for each shooting mode](#)

[MENU items not available for each shooting mode](#)

[▲ Back to top](#)

Copyright 2013 Sony Corporation

- ▶ Before Use
- ▶ Operating the camera
- ▶ Shooting
- ▶ Viewing
- ▶ Useful shooting functions
- ▶ Useful viewing functions
- ▶ Changing settings
- ▶ Viewing images on a TV
- ▶ Using with your computer
- ▶ Printing
- ▶ Troubleshooting
- ▶ Precautions / About this camera

[➡ Contents list](#)

Viewing still images

1. Press the  (Playback) button to switch to playback mode.
2. Select an image with the control wheel.

Viewing images taken with a different camera

This camera creates an Image Database File on a memory card for recording and playing images. Images not registered in the Image Database File may not be displayed correctly.

Register images recorded with other cameras by selecting MENU →  1 → [Recover Image DB] to play them back on this camera.

- Use a sufficiently charged battery to register images. If a battery with a low charge is used to register images, it may not be possible to register all of the data or the data may be corrupted if the battery charge runs out.

Rotating an image

You can rotate an image by pressing the Fn (Function) button while the still image is displayed.



Related Topic

[Recover Image DB](#)





[▲ Back to top](#)

- ▶ Before Use
- ▶ Operating the camera
- ▶ Shooting
- ▶ Viewing
- ▶ Useful shooting functions
- ▶ Useful viewing functions
- ▶ Changing settings
- ▶ Viewing images on a TV
- ▶ Using with your computer
- ▶ Printing
- ▶ Troubleshooting
- ▶ Precautions / About this camera

[→ Contents list](#)

Playback zoom

Enlarges the image being played back.

1. Press the  (Playback) button to switch to playback mode.
2. Turn the W/T (zoom) lever to the T side during still image playback.
3. Adjust the position using  /  /  /  on the control wheel.
 - The frame in the lower left of the image shows which part of the total image is being displayed.



4. Change the zoom scale with the W/T (zoom) lever.
 - Turn the W/T (zoom) lever to the T side to zoom in, W side to zoom out.
 - Press  on the control wheel to cancel playback zoom.

Notes

- Initially the image is enlarged greatly when you use the playback zoom. Adjust to the desired zoom scale using the W/T (zoom) lever.



[▲ Back to top](#)

- ▶ Before Use
- ▶ Operating the camera
- ▶ Shooting
- ▶ Viewing
- ▶ Useful shooting functions
- ▶ Useful viewing functions
- ▶ Changing settings
- ▶ Viewing images on a TV
- ▶ Using with your computer
- ▶ Printing
- ▶ Troubleshooting
- ▶ Precautions / About this camera



[→ Contents list](#)

Image Index

Displays multiple images at the same time.

1. Press the  (Playback) button to switch to playback mode.
2. Turn the W/T (zoom) lever to the W side to display the image index screen.
Turn the lever again to display an index screen with more images.
3. To return to the single-image screen, select an image with the control wheel, then press .

Displaying images of the desired folder

Select the left side bar with the control wheel, then select the desired folder using  / .

Press  on the control wheel to switch the display between still images/movies (View Mode).

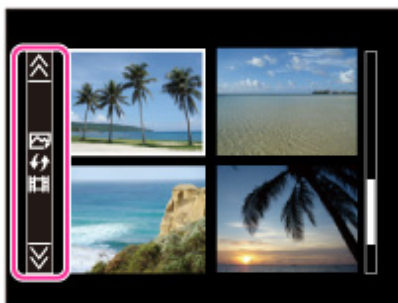

Related Topic

[Still/Movie Select](#)



[▲ Back to top](#)

[▶ Before Use](#)[▶ Operating the camera](#)[▶ Shooting](#)[▶ Viewing](#)[▶ Useful shooting functions](#)[▶ Useful viewing functions](#)[▶ Changing settings](#)[▶ Viewing images on a TV](#)[▶ Using with your computer](#)[▶ Printing](#)[▶ Troubleshooting](#)[▶ Precautions / About this camera](#)[⇒ Contents list](#)

Deleting images

You can delete the currently displayed image.

You can also delete images from the MENU button. [\[Details\]](#)

1. Press the  (Playback) button to switch to playback mode.
2.  (Delete) button → [Delete] → ● on the control wheel

Related Topic



[Delete](#)

[▲ Back to top](#)

- ▶ Before Use
- ▶ Operating the camera
- ▶ Shooting
- ▶ Viewing
- ▶ Useful shooting functions
- ▶ Useful viewing functions
- ▶ Changing settings
- ▶ Viewing images on a TV
- ▶ Using with your computer
- ▶ Printing
- ▶ Troubleshooting
- ▶ Precautions / About this camera

[➡ Contents list](#)

Viewing movies

1. Press the  (Playback) button to switch to playback mode.
2. MENU →  1 → [Still/Movie Select] → [Folder View(MP4)] or [AVCHD View].
 - To return to still image playback mode, select [Folder View(Still)].
3. Select a movie with the control wheel.
4. Press  .
 Movie playback starts. When a movie file is played back to the end, the camera automatically starts playing back the next movie file.





On the movie viewing screen

The Playback bar appears, you can check a playback position of a movie.

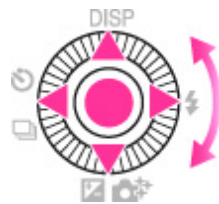

FX / **FH** / **PS** / **1080** / **VGA** appears on the movie viewing screen.
 The icon displayed may vary depending on the record settings.



Control wheel	Action during movie playback
	Pause/Play
	Fast forward
	Fast rewind
Turn the control wheel clockwise during pause.	Forward slow playback
Turn the control wheel counterclockwise during pause. • Movies are played back in frame advance.	Rewind slow playback
	Volume
	Information display

Notes

- You may not be able to play back some images shot using other cameras.

Related Topic

[Still/Movie Select](#)

[▲ Back to top](#)

Copyright 2013 Sony Corporation

- ▶ Before Use
- ▶ Operating the camera
- ▶ Shooting
- ▶ Viewing
- ▶ Useful shooting functions
- ▶ Useful viewing functions
- ▶ Changing settings
- ▶ Viewing images on a TV
- ▶ Using with your computer
- ▶ Printing
- ▶ Troubleshooting
- ▶ Precautions / About this camera

[➡ Contents list](#)

Scrolling panoramic images for display

You can scroll panoramic images by pressing the center button on the control wheel while panoramic images are being displayed.

Press the  (Playback) button to display the whole image again.



A: Shows the displayed area of the whole panoramic image

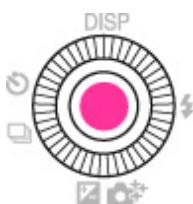

Control wheel	Action
	Starts scrolling playback/pauses scrolling playback

- Panoramic images recorded using another camera may not scroll correctly when played.

[▲ Back to top](#)

- ▶ Before Use
- ▶ Operating the camera
- ▶ Shooting
- ▶ Viewing
- ▶ Useful shooting functions
- ▶ Useful viewing functions
- ▶ Changing settings
- ▶ Viewing images on a TV
- ▶ Using with your computer
- ▶ Printing
- ▶ Troubleshooting
- ▶ Precautions / About this camera

[→ Contents list](#)

[Top page](#) > [Useful shooting functions](#) > [Functions not available for each shooting mode](#) > [Functions not available for each shooting mode](#)

Functions not available for each shooting mode

▼ Functions not available for each REC modes

▼ Functions not available for each [Scene Selection]

▼ Functions not available for each [Picture Effect]

In the table below, a check mark indicates a function that can be changed, while — indicates function that cannot be changed. The icons below [Flash Mode] and [Drive Mode] indicate the available modes. When the shooting modes below are registered and recalled in **MR** (Memory recall), the conditions for whether settings can be changed or not remain the same as in the table below.

Functions not available for each REC modes

	Flash Mode	Smile/Face Detect.	Tracking focus	Drive Mode	Exposure Comp.	Photo Creativity
(Intelligent Auto)		✓	✓		—	✓
(Superior Auto)		✓	✓		—	✓
P (Program Auto)		✓	✓	✓	✓	—
A (Aperture Priority)		✓	✓	✓	✓	—
S (Shutter Priority)		✓	✓	✓	✓	—
M (Manual Exposure)		✓	✓	✓	—	—
(Movie)		✓	✓	—	✓	—
(Sweep Panorama)		—	—		✓	—

Functions not available for each [Scene Selection]

	Flash Mode	Smile/Face Detect.	Tracking focus	Drive Mode	Exposure Comp.
(Portrait)		✓	✓		—
(Anti Motion)					

Blur)		✓*	—		—
(Sports Action)		✓	✓		—
(Pet)		✓	✓		—
(Gourmet)		✓	✓		—
(Macro)		✓	✓		—
(Landscape)		✓	✓		—
(Sunset)		✓	✓		—
(Night Scene)		✓	✓		—
(Hand-held Twilight)		✓*	—		—
(Night Portrait)		✓	✓		—
(Fireworks)		—	—		—
(High Sensitivity)		✓	✓		—

* Smile Shutter cannot be selected.

Functions not available for each [Picture Effect]

	Flash Mode	Smile/Face Detect.	Tracking focus	Drive Mode	Exposure Comp.
OFF (Off)		✓	✓	✓	✓
(Toy Camera)		✓*	✓	✓	✓
(Pop Color)		✓*	✓	✓	✓
(Posterization)		✓*	✓	✓	✓
(Retro Photo)		✓*	✓	✓	✓
(Soft High-key)		✓*	✓	✓	✓
(Partial Color)		✓*	✓	✓	✓
(High Contrast Mono.)		✓*	✓	✓	✓
(Soft Focus)		✓*	✓	—	✓
(HDR Painting)		✓*	✓	—	✓
(Rich-tone Mono.)		✓*	✓	—	✓
(Miniature)		✓*	✓	—	✓
(Watercolor)		✓*	✓	—	✓
(Illustration)		✓*	✓	—	✓

* Smile Shutter cannot be selected.

Notes

- There may be some options that cannot be selected even in a function marked with .
- Available functions may be limited by other conditions.

[▲ Back to top](#)

Copyright 2013 Sony Corporation

Top page > Useful shooting functions > Functions not available for each shooting mode > MENU items not available for each shooting mode

- ▶ Before Use
- ▶ Operating the camera
- ▶ Shooting
- ▶ Viewing
- ▶ Useful shooting functions
- ▶ Useful viewing functions
- ▶ Changing settings
- ▶ Viewing images on a TV
- ▶ Using with your computer
- ▶ Printing
- ▶ Troubleshooting
- ▶ Precautions / About this camera

[→ Contents list](#)

MENU items not available for each shooting mode

▼ Still/Movie shooting menu items not available in some REC modes

▼ Still/Movie shooting menu items not available for [Scene Selection] and [Picture Effect]

In the table below, a check mark indicates settings that can be changed, while — indicates settings that cannot be changed. A setting may be fixed or restricted depending on the shooting mode.

Still/Movie shooting menu items not available in some REC modes

Menu items	i	i+	P	A	S	M	□	□
Image Size	✓	✓	✓	✓	✓	✓	✓	—
Aspect Ratio	✓	✓	✓	✓	✓	✓	✓	—
Quality	✓	✓	✓	✓	✓	✓	✓	—
Panorama: Size	—	—	—	—	—	—	—	✓
Panorama: Direction	—	—	—	—	—	—	—	✓
Drive Mode	✓	✓	✓	✓	✓	✓	—	—
Flash Mode	✓	✓	✓	✓	✓	✓	—	—
Focus Mode	✓	✓	✓	✓	✓	✓	✓	✓
Autofocus Area	—	—	✓	✓	✓	✓	—	—
Soft Skin Effect	✓	✓	✓	✓	✓	✓	—	—
Smile/Face Detect.	✓	✓	✓	✓	✓	✓	✓	—
Auto Object Framing	✓	✓	✓	✓	✓	✓	—	—
ISO	—	—	✓	✓	✓	✓	✓	—
Metering Mode	—	—	✓	✓	✓	✓	✓	✓
Flash Comp.	—	—	✓	✓	✓	✓	✓	—
White Balance	—	—	✓	✓	✓	✓	✓	✓
DRO/Auto HDR	—	—	✓	✓	✓	✓	✓	—
Creative Style	—	—	✓	✓	✓	✓	✓	✓
Picture Effect	—	—	✓	✓	✓	✓	✓	—
Clear Image Zoom	✓	✓	✓	✓	✓	✓	—	—
Digital Zoom	✓	✓	✓	✓	✓	✓	—	—
Long Exposure NR	—	—	✓	✓	✓	✓	✓	—
High ISO NR	—	—	✓	✓	✓	✓	✓	—

AF Illuminator	✓	✓	✓	✓	✓	✓	✓	✓
SteadyShot (Still)	✓	✓	✓	✓	✓	✓	✓	✓
Color Space	✓	✓	✓	✓	✓	✓	✓	✓
Ctrl with Smartphone	✓	✓	✓	✓	✓	✓	✓	✓
Shooting Tip List	✓	✓	✓	✓	✓	✓	✓	✓
Write Date	✓	✓	✓	✓	✓	✓	—	—
Scene Selection	—	—	—	—	—	—	—	—
Memory recall	—	—	—	—	—	—	—	—
Memory	✓	✓	✓	✓	✓	✓	✓	✓
File Format	✓	✓	✓	✓	✓	✓	✓	✓
Record Setting	✓	✓	✓	✓	✓	✓	✓	✓
Image Size(Dual Rec)	✓	✓	✓	✓	✓	✓	✓	✓
SteadyShot (Movie)	✓	✓	✓	✓	✓	✓	✓	✓
Audio Recording	✓	✓	✓	✓	✓	✓	✓	✓
Wind Noise Reduct.	✓	✓	✓	✓	✓	✓	✓	✓
Movie	—	—	—	—	—	—	✓	—

Still/Movie shooting menu items not available for [Scene Selection] and [Picture Effect]

The icons below **SCN** indicate the available modes.

Menu items	SCN	
Image Size	✓	✓
Aspect Ratio	✓	✓
Quality	✓	✓
Panorama: Size	—	—
Panorama: Direction	—	—
Drive Mode		
Flash Mode		✓
Focus Mode		✓
Autofocus Area	—	✓
Soft Skin Effect		✓
Smile/Face Detect.		✓*
Auto Object Framing		
ISO	—	✓
Metering Mode	—	✓
Flash Comp.	—	✓
White Balance	—	✓

DRO/Auto HDR	—	
Creative Style	—	
Picture Effect	—	✓
Clear Image Zoom	✓	✓
Digital Zoom	✓	✓
Long Exposure NR	—	✓
High ISO NR	—	✓
AF Illuminator	✓	✓
SteadyShot (Still)		✓
Color Space	✓	✓
Ctrl with Smartphone	✓	✓
Shooting Tip List	✓	✓
Write Date		✓
Scene Selection	✓	—
Memory recall	—	—
Memory	✓	✓
File Format	✓	✓
Record Setting	✓	✓
Image Size(Dual Rec)	✓	✓
SteadyShot (Movie)	✓	✓
Audio Recording	✓	✓
Wind Noise Reduct.	✓	✓
Movie	—	—

* Smile Shutter cannot be selected.

Notes

- When the above shooting modes are registered and recalled in **MR** (Memory recall), the conditions for whether settings can be changed or not remain the same as in the above table.
- There may be some options that cannot be selected even in a function marked with .
- Available functions may be limited by other conditions.

[▲ Back to top](#)

- ▶ Before Use
- ▶ Operating the camera
- ▶ Shooting
- ▶ Viewing
- ▶ Useful shooting functions
- ▶ Useful viewing functions
- ▶ Changing settings
- ▶ Viewing images on a TV
- ▶ Using with your computer
- ▶ Printing
- ▶ Troubleshooting
- ▶ Precautions / About this camera

[➔ Contents list](#)

Tracking focus

The camera tracks the subject and adjusts the focus automatically even when the subject is moving.

1. Press ● on the control wheel.

The target frame appears.



2. Place the target frame over the subject you want to focus on, and press ● .
Tracking begins.
3. Press the shutter button to shoot the image.
4. To cancel tracking focus before shooting, press ● again.

Tracking a face

If you use the tracking focus function while the Face Detection function is activated, you can select a face to be given priority and register that face with the camera. Even if the registered face disappears from the screen, when it shows up on the screen again, the camera focuses on the registered face.

- When a specified face is registered in the camera's memory and you use the Smile Shutter function, the camera searches only for that face's smile.
- When tracking a face, the subject's body will be tracked when the subject's face does not appear on the screen. You can set whether to give priority to a tracked face using [Face Priority Tracking].

[\[Details\]](#)

Notes

- Tracking focus is not available in the following situations:
 - When using zoom functions other than optical zoom
 - When [Focus Mode] is set to [Manual Focus]
 - When [Autofocus Area] is set to [Flexible Spot]
- Tracking focus will automatically be canceled when the subject disappears from the screen or has failed to be tracked. However, if the target of the tracking focus is a specified face, the camera keeps tracking on that face even if the face disappears from the screen.

Related Topic

[Smile/Face Detect.](#)

[Face Priority Tracking](#)

[Functions not available for each shooting mode](#)

- ▶ Before Use
- ▶ Operating the camera
- ▶ Shooting
- ▶ Viewing
- ▶ Useful shooting functions
- ▶ Useful viewing functions
- ▶ Changing settings
- ▶ Viewing images on a TV
- ▶ Using with your computer
- ▶ Printing
- ▶ Troubleshooting
- ▶ Precautions / About this camera





[⇒ Contents list](#)

DISP (Display Contents)

▼ Displaying histogram



1. Press **DISP** (Display Contents) on the control wheel, then select a desired mode.
 - Selectable modes can be set using MENU →  1 → [DISP Button].

In shooting mode

Graphic Display	<p>Shows basic shooting information. Graphically shows the shutter speed and aperture value.</p> 
Display All Info.	<p>Shows recording information.</p> 
No Disp. Info.	<p>Does not show recording information.</p> 
Level	<p>Displays an indicator guide showing the angle of inclination of the camera to backward, forward, left or right. When the camera is held on a level, this indicator guide appears green.</p> 
	<p>Displays the luminance distribution graphically (histogram). This mode can be set by selecting MENU →  1 → [DISP Button] → [Histogram].</p>

Histogram	
-----------	--

In playback mode

Display Info.	<p>Shows recording information.</p> 
Histogram	<p>Displays the histogram and recording information.</p> 
No Disp. Info.	<p>Does not show recording information.</p> 

 Graphic display

The graphic display shows the shutter speed and the aperture value graphically in the picture, so that you can easily understand the exposure system. The shutter speed indicator bar and the aperture value indicator bar show the current values.

A: Shutter speed

B: Aperture value

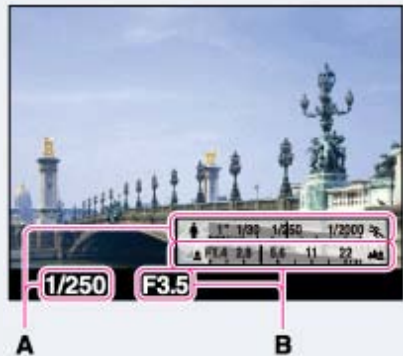

Displaying histogram

A histogram is a graph showing the brightness of an image. The graph display indicates a bright image when skewed to the right side (A), and a dark image when skewed to the left side (B).

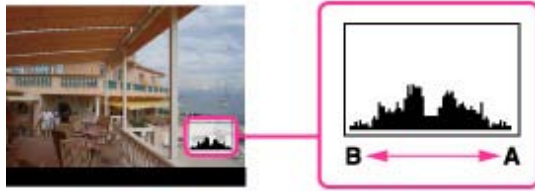

1. Select MENU → 1 → [DISP Button].
2. Check [Histogram], then press MENU button.
3. Press **DISP** (Display Contents) repeatedly in shooting mode to display histogram.

Notes

- The histogram also appears when playing back a single image, but you cannot adjust the exposure.
- The histogram does not appear when:
 - Recording/playing back movies
 - Shooting in [Sweep Panorama] mode or viewing panoramic images
- A large difference in the histogram displayed during shooting and playback may occur when:
 - The flash strobes.
 - The shutter speed is slow or fast.
- The histogram may not appear for images recorded using other cameras.

Related Topic

[DISP Button](#)

[▲ Back to top](#)



Copyright 2013 Sony Corporation





- ▶ Before Use
- ▶ Operating the camera
- ▶ Shooting
- ▶ Viewing
- ▶ Useful shooting functions
- ▶ Useful viewing functions
- ▶ Changing settings
- ▶ Viewing images on a TV
- ▶ Using with your computer
- ▶ Printing
- ▶ Troubleshooting
- ▶ Precautions / About this camera

[⇒ Contents list](#)

Flash Mode

You can also change [Flash Mode] using MENU.

1. Press  (Flash Mode) on the control wheel.
 - When another function is assigned to the control wheel, press the MENU button →  2 → [Flash Mode].
2. Select the desired mode with the control wheel.



 (Flash Off)	Flash does not operate.
 (Autoflash)	Flash automatically operates in dark locations or when there is a backlight.
 (Fill-flash)	Flash always operates.
 (Slow Sync.)	Flash always operates. The shutter speed is slow in a dark place to clearly shoot background that is out of flash light.
 (Rear Sync.)	Flash operates before exposure is completed every time you trigger the shutter. Rear Sync shooting allows you to shoot a natural image of the trail of a moving subject, such as a moving car or a walking person.

When “White circular spots” appear in flash photos

These spots are caused by particles (dust, pollen, etc.) floating close to the lens. When they are accentuated by the camera’s flash, they appear as white circular spots.



How can the “White circular spots” be reduced?

- Light the room and shoot the subject without flash.
- Select  (Anti Motion Blur) or  (High Sensitivity) mode in [Scene Selection]. ([Flash Off] is automatically selected.)

Notes

- The flash strobes twice. The first flash adjusts the light quantity.
- While charging the flash,  flashes. After charging is completed, the flashing icon will light up.
- When using the flash, the flash pops up automatically. Do not cover the flash with your fingers. If not using the flash, press it down manually.
- You cannot use the flash when [Drive Mode] is set to [Self-timer(Cont)] or [Bracket: Cont.].
- When shooting with the flash and the zoom is set to W, the shadow of the lens may appear on the screen, depending on the shooting conditions. If this happens, shoot away from the subject or set the zoom to T and shoot with the flash again.

Related Topic

[Functions not available for each shooting mode](#)

[▲ Back to top](#)

Copyright 2013 Sony Corporation

- ▶ Before Use
- ▶ Operating the camera
- ▶ Shooting
- ▶ Viewing
- ▶ Useful shooting functions
- ▶ Useful viewing functions
- ▶ Changing settings
- ▶ Viewing images on a TV
- ▶ Using with your computer
- ▶ Printing
- ▶ Troubleshooting
- ▶ Precautions / About this camera

[⇒ Contents list](#)

Exposure Comp.

You can adjust the exposure manually in 1/3 EV steps in a range of -3.0 EV to +3.0 EV.

1. Press the  (Exposure Comp.) on the control wheel.
2. Select the desired value using the control wheel.

 Adjusting the exposure for better looking images



A: Overexposure (too much light)

B: Correct exposure

C: Underexposure (too little light)

- When the image shot is overexposed, adjust [Exposure Comp.] to the minus side.
- When the image shot is underexposed, adjust [Exposure Comp.] to the plus side.

Notes

- If you shoot a subject in extremely bright or dark conditions, or when you use the flash, the exposure adjustment may not be effective.

Related Topic

[Functions not available for each shooting mode](#)



[▲ Back to top](#)



- ▶ Before Use
- ▶ Operating the camera
- ▶ Shooting
- ▶ Viewing
- ▶ Useful shooting functions
- ▶ Useful viewing functions
- ▶ Changing settings
- ▶ Viewing images on a TV
- ▶ Using with your computer
- ▶ Printing
- ▶ Troubleshooting
- ▶ Precautions / About this camera





[➔ Contents list](#)







Photo Creativity

[Photo Creativity] is a mode that allows you to operate the camera intuitively, using unusual screen display.

When the shooting mode is set to  (Intelligent Auto) or  (Superior Auto), you can change the settings easily and shoot images.

1. Set the mode dial to  (Intelligent Auto) or  (Superior Auto).
2. Press  (Photo Creativity) on the control wheel.
3. Select the desired item with the control wheel.

 (Bkground Defocus)	Adjusts the intensity of Background Defocus.
 (Brightness)	Adjusts brightness.
 (Color)	Adjusts color.
 (Vividness)	Adjusts vividness.
 (Picture Effect)	Shoots a still image with original texture according to the desired effect.

4. Change the settings with the control wheel.
 - You can combine some settings by repeating steps 3 and 4.
 - To reset the changed settings to the default settings, press the  (In-Camera Guide) button.
 -  (Bkground Defocus),  (Brightness),  (Color) and  (Vividness) are set to [AUTO], and  (Picture Effect) is set to .
5. When shooting still images: Shoot with the shutter button.
When recording movies: Press the MOVIE (Movie) button to start recording.

Notes

- When you record movies in [Photo Creativity] mode, you can only select [Bkground Defocus] while recording.
- If you switch the camera mode to [Intelligent Auto] mode, [Superior Auto] mode or turn off the camera, the settings you changed revert to the default settings.
- When you set [Photo Creativity] in [Superior Auto] mode, overlaying images are disabled.

Related Topic

[Picture Effect](#)

[Functions not available for each shooting mode](#)

[▲ Back to top](#)





- ▶ Before Use
- ▶ Operating the camera
- ▶ Shooting
- ▶ Viewing
- ▶ Useful shooting functions
- ▶ Useful viewing functions
- ▶ Changing settings
- ▶ Viewing images on a TV
- ▶ Using with your computer
- ▶ Printing
- ▶ Troubleshooting
- ▶ Precautions / About this camera











[⇒ Contents list](#)

Drive Mode

▼ Automatic shooting with Self-portrait timer



You can set a drive mode, such as continuous, self-timer, or bracket shooting. You can select the [Drive Mode] also from MENU.

1. Press  (Drive Mode) on the control wheel.
 - When another function is assigned to the control wheel, press the MENU button →  → [Drive Mode].
2. Select the desired mode with the control wheel.
 - Select detailed settings using  /  if the selected mode has such options.

	 (Single Shooting)	The camera shoots a single image without using the self-timer.
	 (Cont. Shooting)	The camera shoots continuous images while the shutter button is pressed.
	 (Spd Priority Cont.)	Shoots images continuously at high speed while you press and hold down the shutter button. Focus and brightness settings of the first shot are used for the following shots.
	 (Self-timer)	Sets the self-timer to a 10-second or 2-second delay. When you press the shutter button, the self-timer lamp flashes and a beep sounds until the shutter operates. To cancel, press  again.
	 (Self-portrait)	Sets the self-timer to Self-portrait timer. When the camera detects the specified number of faces, a beep sounds, and the shutter operates 2 seconds later.
	 (Self-timer(Cont))	The camera shoots continuous frames 10 seconds after you press the shutter button. Select the number of frames from three or five.
	 (Bracket: Cont.)	Shoots three images, each with different degrees of brightness. You can set the value of bracket deviation (steps).
	 (WB bracket)	Shoots three images, each with different degrees of brightness according to the selected settings of white balance, color temperature and color filter. You can select the value of bracket deviation (steps) from [Lo] or [Hi].

Tips for preventing blur

If your hands or body move while holding the camera and pressing the shutter button, “Camera shake” occurs.

Camera shake occurs frequently under low-light or slow shutter speed conditions, such as those encountered in  (Night Portrait) or  (Night Scene) mode.



To reduce camera shake, set the self-timer to a 2-second delay and brace your arms against your sides after pressing the shutter button.

Notes

- When [Drive Mode] is set to [Self-timer(Cont)] or [Bracket: Cont.], [Flash Mode] is set to [Flash Off].
- When the battery level is low, or a memory card is full, the burst stops.

Automatic shooting with Self-portrait timer

Point the lens at yourself so that the selected number of faces is reflected in the screen. The shutter operates automatically. Do not move your camera after the beep sounds.



- You can also shoot an image by pressing the shutter button during this operation.

Related Topic

[Functions not available for each shooting mode](#)

[▲ Back to top](#)

Copyright 2013 Sony Corporation

- ▶ Before Use
- ▶ Operating the camera
- ▶ Shooting
- ▶ Viewing
- ▶ Useful shooting functions
- ▶ Useful viewing functions
- ▶ Changing settings
- ▶ Viewing images on a TV
- ▶ Using with your computer
- ▶ Printing
- ▶ Troubleshooting
- ▶ Precautions / About this camera

[⇒ Contents list](#)

Image Size

[Image Size] determines the size of the image file that is recorded when you take an image. The larger the image size, the more detail will be reproduced when the image is printed on large-format paper. The smaller the image size, the more images can be recorded.

1. MENU →  1 → [Image Size] → desired size

When [Aspect Ratio] is set to [3:2]

	Image size		Usage guidelines
✓	L: 20M	5472 × 3648 pixels	For prints up to A3+ size
	M: 10M	3888 × 2592 pixels	For prints up to A3 size
	S: 5.0M	2736 × 1824 pixels	For prints from 10×15 cm up to A4 size

When [Aspect Ratio] is set to [16:9]

	Image size		Usage guidelines
✓	L: 17M	5472 × 3080 pixels	For viewing on a high-definition TV
	M: 7.5M	3648 × 2056 pixels	
	S: 4.2M	2720 × 1528 pixels	

When [Aspect Ratio] is set to [4:3]

	Image size		Usage guidelines
✓	L: 18M	4864 × 3648 pixels	For viewing on a computer
	M: 10M	3648 × 2736 pixels	
	S: 5.0M	2592 × 1944 pixels	
	VGA	640 × 480 pixels	For e-mail attachments

When [Aspect Ratio] is set to [1:1]

	Image size		Usage guidelines
✓	L: 13M	3648 × 3648 pixels	For shooting in composition as a medium format camera
	M: 6.5M	2544 × 2544 pixels	
	S: 3.7M	1920 × 1920 pixels	

- When [Quality] is set to [RAW] or [RAW & JPEG], the RAW image size corresponds to L.

Related Topic

[Aspect Ratio](#)

[▲ Back to top](#)

Copyright 2013 Sony Corporation

- ▶ Before Use
- ▶ Operating the camera
- ▶ Shooting
- ▶ Viewing
- ▶ Useful shooting functions
- ▶ Useful viewing functions
- ▶ Changing settings
- ▶ Viewing images on a TV
- ▶ Using with your computer
- ▶ Printing
- ▶ Troubleshooting
- ▶ Precautions / About this camera

[⇒ Contents list](#)

Aspect Ratio

Sets the aspect ratio of still images.

1. MENU →  1 → [Aspect Ratio] → desired mode

<input checked="" type="checkbox"/>	3:2	Suitable for standard prints.
<input type="checkbox"/>	16:9	For viewing on a wide TV, etc.
<input type="checkbox"/>	4:3	For viewing on a computer.
<input type="checkbox"/>	1:1	For shooting in composition as a medium format camera.

[▲ Back to top](#)

- ▶ Before Use
- ▶ Operating the camera
- ▶ Shooting
- ▶ Viewing
- ▶ Useful shooting functions
- ▶ Useful viewing functions
- ▶ Changing settings
- ▶ Viewing images on a TV
- ▶ Using with your computer
- ▶ Printing
- ▶ Troubleshooting
- ▶ Precautions / About this camera

[➔ Contents list](#)

Quality

Selects the image quality for still images.

1. MENU →  1 → [Quality] → desired mode

RAW (RAW)	File format: RAW (Records using the RAW compression format.) Digital processing is not performed on this file format. Select this format to process images on a computer for professional purposes. <ul style="list-style-type: none"> ● The image size is fixed to the maximum size. The image size is not displayed on the screen.
RAW+J (RAW & JPEG)	File format: RAW (Records using the RAW compression format.) + JPEG A RAW image and a JPEG image are created at the same time. This is suitable when you need two image files, a JPEG for viewing, and a RAW for editing. <ul style="list-style-type: none"> ● The JPEG image quality is fixed to [Fine].
 FINE (Fine)	File format: JPEG The image is compressed in the JPEG format when recorded.
STD (Standard)	Since the compression rate for [Standard] is higher than that for [Fine], the file size of [Standard] is smaller than that of [Fine]. This allows more files to be recorded on one memory card, but the image quality will be lower.

RAW images

You need the “Image Data Converter” software in order to open a RAW image recorded on this camera. With this software, a RAW image can be opened and converted to a common format, such as JPEG or TIFF, and its white balance, color saturation, contrast, etc., can be readjusted.

Notes

- You cannot add DPOF (print order) registration to RAW format images.
- You cannot use the following functions when [Quality] is set to [RAW] or [RAW & JPEG].
 - Zoom functions other than optical zoom
 - [Auto HDR]
 - [Picture Effect]
 - [Auto Object Framing]

Related Topic

[MENU items not available for each shooting mode](#)
[“Image Data Converter”](#)

[▲ Back to top](#)

[▶ Before Use](#)[▶ Operating the camera](#)[▶ Shooting](#)[▶ Viewing](#)[▶ Useful shooting functions](#)[▶ Useful viewing functions](#)[▶ Changing settings](#)[▶ Viewing images on a TV](#)[▶ Using with your computer](#)[▶ Printing](#)[▶ Troubleshooting](#)[▶ Precautions / About this camera](#)[⇒ Contents list](#)

Panorama: Size

Sets the image size when shooting in [Sweep Panorama] mode.

1. MENU →  1 → [Panorama: Size] → desired size

<input checked="" type="checkbox"/>	Standard	Shoots images at standard size. Vertical: 3872 × 2160 Horizontal: 8192 × 1856
<input type="checkbox"/>	Wide	Shoots images at wide size. Vertical: 5536 × 2160 Horizontal: 12416 × 1856

[▲ Back to top](#)

- ▶ Before Use
- ▶ Operating the camera
- ▶ Shooting
- ▶ Viewing
- ▶ Useful shooting functions
- ▶ Useful viewing functions
- ▶ Changing settings
- ▶ Viewing images on a TV
- ▶ Using with your computer
- ▶ Printing
- ▶ Troubleshooting
- ▶ Precautions / About this camera

[⇒ Contents list](#)

Panorama: Direction

Sets the direction to pan the camera when shooting panoramic images.

1. MENU →  1 → [Panorama: Direction] → desired mode

<input checked="" type="checkbox"/>	Right	Pan the camera from the left to the right.
<input type="checkbox"/>	Left	Pan the camera from the right to the left.
<input type="checkbox"/>	Up	Pan the camera from the bottom to the top.
<input type="checkbox"/>	Down	Pan the camera from the top to the bottom.

Related Topic

[Sweep Panorama](#)

[▲ Back to top](#)

- ▶ Before Use
- ▶ Operating the camera
- ▶ Shooting
- ▶ Viewing
- ▶ Useful shooting functions
- ▶ Useful viewing functions
- ▶ Changing settings
- ▶ Viewing images on a TV
- ▶ Using with your computer
- ▶ Printing
- ▶ Troubleshooting
- ▶ Precautions / About this camera

[⇒ Contents list](#)

Focus Mode

Selects the focus method to suit the movement of the subject.

AF stands for “Auto Focus,” a function that adjusts the focus automatically.

1. MENU →  2 → [Focus Mode] → desired mode

✓	AF-S (Single-shot AF)	The camera locks the focus when the focus adjustment is achieved. Use [Single-shot AF] when the subject is motionless.
	AF-C (Continuous AF)	The camera continues to focus while the shutter button is pressed and held halfway down. Use this when the subject is in motion.
	DMF (DMF)	Allows you to use manual focus and auto focus in combination.
	MF (Manual Focus)	Adjusts the focus manually.

Using [DMF]/[Manual Focus]

1. MENU →  2 → [Focus Mode] → [DMF] or [Manual Focus]
2. Adjust the focus by turning the Control Ring.
 - Use the peaking function, [Focus Magnifier] or [MF Assist] to adjust focus more easily.
 - When [Focus Mode] is set to [DMF], auto focus activates when you press the shutter button halfway down.

Focusing using the [DMF] setting

Using [DMF] allows you to use a combination of manual and automatic focus adjustment as follows.

- After focusing automatically, make fine focus adjustments manually.
Effective when you want to focus narrowly. Hold down the shutter button halfway, then turn the Control Ring.
- Adjust the focus manually in advance, then use automatic focus.
Effective for focusing on subjects that are toward the back of a scene because those subjects tend to be out of focus when using the automatic focus adjustment.

Notes

- If the focus distance is set very close, the image may show dust or fingerprints on the lens. Wipe the lens with a soft cloth, etc.
- Once you change the focus method, the distance of the focus you set up is cleared.

Related Topic

[MENU items not available for each shooting mode](#)

[Peaking Level](#)

[Func. of Center Button](#)

[MF Assist](#)

- ▶ Before Use
- ▶ Operating the camera
- ▶ Shooting
- ▶ Viewing
- ▶ Useful shooting functions
- ▶ Useful viewing functions
- ▶ Changing settings
- ▶ Viewing images on a TV
- ▶ Using with your computer
- ▶ Printing
- ▶ Troubleshooting
- ▶ Precautions / About this camera







[➔ Contents list](#)

Autofocus Area

▼ Using Flexible Spot

You can change the focusing area. Use the menu when it is difficult to get the proper focus in auto focus mode.

1. MENU →  2 → [Autofocus Area] → desired mode

	 (Multi)	Focuses on a subject in all ranges of the finder frame automatically. When you press the shutter button halfway down in still image shooting mode, a green frame is displayed around the area that is in focus. <ul style="list-style-type: none"> ● When the Face Detection function is active, AF operates with priority on faces.
	 (Center)	Focuses on a subject in the center of the finder frame automatically. Using the AF lock function together, you can compose the image the way you want. <div style="text-align: center;">  </div>
	 (Flexible Spot)	Allows you to move the AF range finder frame to the desired point on the screen and focus on an extremely small subject in a narrow area. <div style="text-align: center;">  </div>

Notes

- When you use the following functions, the AF range finder frame is disabled and appears in a dotted line. In this case, the camera works to focus on the subjects at the center of the screen.
 - Zoom functions other than optical zoom
 - [AF Illuminator]
- If the tracking focus is activated, the camera focuses with priority on the subject to be tracked.

Using Flexible Spot

[Flexible Spot] is useful when you shoot a subject that is not in the center of the frame. You can shoot the subject without changing the composition.

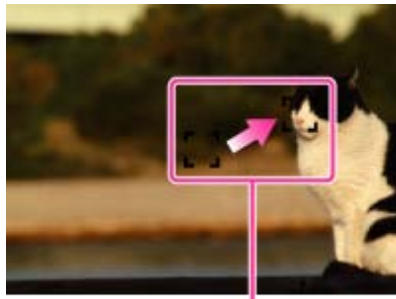

A

A: AF range finder frame (yellow: adjustable/gray: fixed)

1. Use the control wheel to adjust the position of the AF range finder frame where you want to focus, then press .

To reset the setting, press  again.

Related Topic

[MENU items not available for each shooting mode](#)

[Tracking focus](#)

[▲ Back to top](#)

Copyright 2013 Sony Corporation



- ▶ Before Use
- ▶ Operating the camera
- ▶ Shooting
- ▶ Viewing
- ▶ Useful shooting functions
- ▶ Useful viewing functions
- ▶ Changing settings
- ▶ Viewing images on a TV
- ▶ Using with your computer
- ▶ Printing
- ▶ Troubleshooting
- ▶ Precautions / About this camera

[⇒ Contents list](#)

Soft Skin Effect

When the Face Detection function is activated, sets whether to use [Soft Skin Effect], and the effect level.

1. MENU →  2 → [Soft Skin Effect] → desired mode
 - When you select [On], select the desired effect level using ◀ / ▶ on the control wheel.

	(On)	Uses [Soft Skin Effect].
	 (Off)	Does not use [Soft Skin Effect].

Notes

- The [Soft Skin Effect] may not be visible depending on the subject.

Related Topic

[MENU items not available for each shooting mode](#)

[▲ Back to top](#)

- ▶ Before Use
- ▶ Operating the camera
- ▶ Shooting
- ▶ Viewing
- ▶ Useful shooting functions
- ▶ Useful viewing functions
- ▶ Changing settings
- ▶ Viewing images on a TV
- ▶ Using with your computer
- ▶ Printing
- ▶ Troubleshooting
- ▶ Precautions / About this camera

[→ Contents list](#)

Smile/Face Detect.

▼ Using Smile Shutter

When the Face Detection function is used, the camera detects the faces of your subjects and adjusts [Autofocus Area], [Flash Mode], [Exposure Comp.], [White Balance] and [Red Eye Reduction] settings automatically. When using [Smile Shutter], the camera detects smiles and releases the shutter automatically.

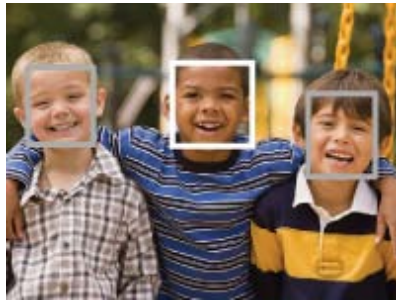

When the camera detects more than one subject, the camera will judge which is the main subject and set focus by priority. The frame for which the focus is set will turn green by pressing the shutter button halfway down.

1. MENU → 2 → [Smile/Face Detect.] → desired mode





	[OFF] (Off)	Does not use Face Detection.
	(On (Regist. Faces))	Detects with priority on a face you have registered using [Face Registration].
	[ON] (On)	Detects but does not give priority to the face you have registered.
	(Smile Shutter)	Detects smiles and releases the shutter automatically.

Notes

- [Off] is not available when [Drive Mode] is set to [Self-portrait].
- The Face Detection function does not work when you use zoom functions other than optical zoom.
- Up to eight faces of your subjects can be detected.

Using Smile Shutter



1. MENU →  2 → [Smile/Face Detect.] → [Smile Shutter]
2. Press ◀ / ▶ on the control wheel to select a desired smile detection sensitivity.
 - You can select the sensitivity to detect a smile from the following three levels;  (On: Slight Smile),  (On: Normal Smile) or  (On: Big Smile).
3. Wait for a smile to be detected.

When a face is detected and the smile level exceeds the ◀ point on the indicator, the camera records images automatically.

 - If you press the shutter button during Smile Shutter shooting, the camera shoots the image, then returns to Smile Shutter mode.

 Tips for better capturing of smiles



- 1 Do not cover the eyes with bangs. Do not obscure the face by a hat, mask, sunglasses, etc.
- 2 Try to orient the face in front of the camera and be as level as possible. Keep the eyes narrowed.
- 3 Give a clear smile with an open mouth. The smile is easier to be detected when the teeth are showing.
 - The shutter operates when any person whose face is being detected smiles.
 - You can select or register a priority subject for face detection. When the selected face is registered in the camera memory, Smile Detection is performed only for that face.
 - If a smile is not detected, set the smile detection sensitivity to [On: Slight Smile].

Notes

- Smiles may not be detected correctly depending on the conditions.

Related Topic

[Tracking focus](#)

[Face Registration](#)

[Functions not available for each shooting mode](#)

[MENU items not available for each shooting mode](#)

[▲ Back to top](#)

- ▶ Before Use
- ▶ Operating the camera
- ▶ Shooting
- ▶ Viewing
- ▶ Useful shooting functions
- ▶ Useful viewing functions
- ▶ Changing settings
- ▶ Viewing images on a TV
- ▶ Using with your computer
- ▶ Printing
- ▶ Troubleshooting
- ▶ Precautions / About this camera

[➔ Contents list](#)

Auto Object Framing

When the camera detects and shoots faces, close-ups, or subjects tracked by the tracking focus function, the captured image is automatically trimmed for the best composition. Both the original and trimmed images are recorded. The trimmed image is recorded in the same size as the original image.

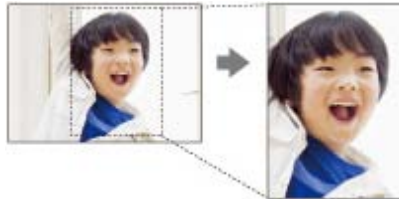

1. MENU → 2 → [Auto Object Framing] → desired mode

The icon on the screen turns green when the camera decides that an image being captured can be trimmed.

- After shooting, the trimmed area is indicated by a frame on the auto review screen.

<input checked="" type="checkbox"/>	(Off)	Sets whether or not to use [Auto Object Framing].
<input type="checkbox"/>	(Auto)	

Notes

- The image may not be trimmed into its optimal composition depending on the shooting conditions.
- Auto Object Framing cannot be used in the following settings.
 - When [Quality] is set to [RAW] or [RAW & JPEG]
 - When [DRO/Auto HDR] is set to [Auto HDR]
 - When [Focus Mode] is set to [Manual Focus]
 - When [Drive Mode] is set to [Cont. Shooting], [Spd Priority Cont.], [Self-timer(Cont)], [Bracket: Cont.] or [WB bracket]
 - When [ISO] is set to [Multi Frame Noise Reduct.]
- When [Smile/Face Detect.] is set to [Off], you cannot use [Auto Object Framing] for faces.

Related Topic

[MENU items not available for each shooting mode](#)

[▲ Back to top](#)

- ▶ Before Use
- ▶ Operating the camera
- ▶ Shooting
- ▶ Viewing
- ▶ Useful shooting functions
- ▶ Useful viewing functions
- ▶ Changing settings
- ▶ Viewing images on a TV
- ▶ Using with your computer
- ▶ Printing
- ▶ Troubleshooting
- ▶ Precautions / About this camera

[➡ Contents list](#)

ISO

1. MENU → 3 → [ISO] → desired mode
 - In case you select [Multi Frame Noise Reduct.] or [ISO AUTO], press on the control wheel to display the setting screen, then select a desired value.

(Multi Frame Noise Reduct.)	The camera overlays the continuous shots so that an image with less noise results. Press on the control wheel to display the setting screen, then select a desired value from ISO AUTO, 200 to 25600 using / .
(ISO AUTO)	The camera sets the ISO sensitivity automatically based on the surrounding light conditions. You can set the maximum and minimum ISO value for [ISO AUTO] mode. Press to display the setting screen.
100/125/160/200/400/800/1600/3200/6400/12800	You can reduce image blurring in dark locations or with moving subjects by increasing the ISO sensitivity (select a larger number).

Adjusting ISO Sensitivity (Recommended Exposure Index)

ISO sensitivity is a speed rating for recording media that incorporates an image sensor that receives light. Even when the exposure is the same, images differ depending on the ISO sensitivity.

High ISO sensitivity



Records a bright image even in dark locations while increasing shutter speed to reduce blur. However, the image tends to be noisy.

Low ISO sensitivity



Records a smoother image.
However, when the exposure is insufficient, the image may be darker.

Notes

- You cannot select [ISO AUTO] when the camera is set to [Manual Exposure]. [ISO 160] is the default setting.
- When [ISO] is set to a value lower than ISO 160, the range for recordable subject brightness (dynamic range) may decrease.
- For movies, the value between ISO 160 to ISO 3200 is available.
- When [ISO] is set to [Multi Frame Noise Reduct.], the camera overlays the images. It takes more time to record an image, and the flash does not operate.

Related Topic

[MENU items not available for each shooting mode](#)

[▲ Back to top](#)

Copyright 2013 Sony Corporation





- ▶ Before Use
- ▶ Operating the camera
- ▶ Shooting
- ▶ Viewing
- ▶ Useful shooting functions
- ▶ Useful viewing functions
- ▶ Changing settings
- ▶ Viewing images on a TV
- ▶ Using with your computer
- ▶ Printing
- ▶ Troubleshooting
- ▶ Precautions / About this camera

[➡ Contents list](#)

Metering Mode

Selects [Metering Mode] that sets which part of the subject to measure to determine the exposure.

1. MENU →  3 → [Metering Mode] → desired mode

<input checked="" type="checkbox"/>	 (Multi)	Divides into multiple regions and measures each region. The camera determines a well-balanced exposure (Multi-pattern metering).
<input type="checkbox"/>	 (Center)	Measures the center of the image, and determines the exposure based on the brightness of the subject there (Center-weighted metering).
<input type="checkbox"/>	 (Spot)	Align the spot metering cross hairs (A) on the subject to meter one part of the subject (Spot metering). This function is useful when the subject is backlit or when there is strong contrast between the subject and the background. 

Related Topic

[MENU items not available for each shooting mode](#)

[▲ Back to top](#)

- ▶ Before Use
- ▶ Operating the camera
- ▶ Shooting
- ▶ Viewing
- ▶ Useful shooting functions
- ▶ Useful viewing functions
- ▶ Changing settings
- ▶ Viewing images on a TV
- ▶ Using with your computer
- ▶ Printing
- ▶ Troubleshooting
- ▶ Precautions / About this camera

[⇒ Contents list](#)

Flash Comp.

Adjusts the amount of flash light. Separately to the exposure compensation, flash compensation changes the amount of flash light to change the exposure for the main subject within the range of flash light.

1. MENU →  3 → [Flash Comp.] → desired value

Adjusting the value to the + side increases the flash level and to the – side decreases the flash level.

 What is the difference between exposure compensation and flash compensation?

Exposure compensation changes the amount of flash light along with the change of the shutter speed, aperture, and ISO (when [ISO] is set to [ISO AUTO]). Flash compensation changes the amount of flash light only.

Related Topic

[MENU items not available for each shooting mode](#)

[▲ Back to top](#)

- ▶ Before Use
- ▶ Operating the camera
- ▶ Shooting
- ▶ Viewing
- ▶ Useful shooting functions
- ▶ Useful viewing functions
- ▶ Changing settings
- ▶ Viewing images on a TV
- ▶ Using with your computer
- ▶ Printing
- ▶ Troubleshooting
- ▶ Precautions / About this camera

[→ Contents list](#)

White Balance

▼ To capture a basic white color in [Custom Setup] mode

Adjusts color tones according to the surrounding light conditions. Use this function if image color appears unnatural.

1. MENU → 3 → [White Balance] → desired mode
 - In [White Balance] modes other than [C.Temp./Filter], you can fine tune the color tone as you like. Press on the control wheel to display the adjustment screen, then adjust the tone using / / / .
 - The color tone can be micro adjusted to the Green (G)/Magenta (M)/Blue (B)/Amber (A) directions.

	AWB (Auto WB)	Adjusts the white balance automatically so that the colors appear natural.
	(Daylight)	Adjusts for outdoors conditions on a fine day, evening views, night scenes, neon signs, fireworks, etc.
	(Shade)	Adjusts for a shady location.
	(Cloudy)	Adjusts for a cloudy sky or a shady location.
	(Incandescent)	Adjusts for places under incandescent lamp, or under bright lighting, such as in a photo studio.
	𠄎-1 (Fluor.: Warm White) 𠄎0 (Fluor.: Cool White) 𠄎+1 (Fluor.: Day White) 𠄎+2 (Fluor.: Daylight)	[Fluor.: Warm White]: Adjusts for warm white fluorescent lighting. [Fluor.: Cool White]: Adjusts for cool white fluorescent lighting. [Fluor.: Day White]: Adjusts for day white fluorescent lighting. [Fluor.: Daylight]: Adjusts for daylight fluorescent lighting.
	(Flash)	Adjusts for the flash conditions.
	(C.Temp./Filter)	Adjusts the color temperature depending on the light source. Achieves the effect of CC (Color Compensation) filters for photography. If you press , you can set the color temperature using / . If you press again, the fine adjustment screen will be displayed.
	(Custom)	Fixes the white balance to a setting depending on the light source. Use this mode when [Auto WB] and other settings do not provide accurate colors.
	SET (Custom Setup)	Memorizes the basic white color which will be used in [Custom] mode.

Effects of lighting conditions

The apparent color of the subject is affected by the lighting conditions. The color tones are adjusted automatically, but you can adjust color tones manually using the White

Balance function.



Daylight (White as Standard)



Cloudy (Bluish)



Fluorescent (Green-tinged)



Incandescent (Reddish)

| To capture a basic white color in [Custom Setup] mode

1. MENU → 3 → [White Balance] → [Custom Setup]
2. Hold the camera so that the white area fully covers the AF area located in the center, and then press the shutter button down.
The shutter clicks and the calibrated values (Color Temperature and Color filter) are displayed.
3. Press on the control wheel.
The screen returns to the recording information display while retaining the memorized custom white balance setting.
 - The custom white balance setting registered using this operation is effective until a new setting is registered.

Notes

- The message “Custom WB Error” indicates that the value is beyond the expected range. (For example, when the flash is used on a subject in close proximity or when a brightly colored subject is in the frame.) If you register this value, the indicator turns yellow on the recording information display. You can shoot at this point, but it is recommended that you set the white balance again to obtain a more accurate white balance value.
- Do not shake or strike the camera while capturing the basic white color.
- If the flash is used when the shutter button is pressed, a custom white balance is registered with the flash light taken into account. Take pictures with the flash in later shootings.

Related Topic

[MENU items not available for each shooting mode](#)

[▲ Back to top](#)

Copyright 2013 Sony Corporation

- ▶ Before Use
- ▶ Operating the camera
- ▶ Shooting
- ▶ Viewing
- ▶ Useful shooting functions
- ▶ Useful viewing functions
- ▶ Changing settings
- ▶ Viewing images on a TV
- ▶ Using with your computer
- ▶ Printing
- ▶ Troubleshooting
- ▶ Precautions / About this camera

[→ Contents list](#)

DRO/Auto HDR

▼ D-Range Optimizer

▼ Auto HDR

Corrects the brightness or contrast.

1. MENU → 3 → [DRO/Auto HDR] → desired mode

	(Off)	Does not use [DRO/Auto HDR].
	 (D-Range Opt.)	By dividing the image into small areas, the camera analyzes the contrast of light and shadow between the subject and the background, producing the image with the optimal brightness and gradation.
	(Auto HDR)	Shoots three images with different exposures, and then overlays the bright area of the under exposed image and the dark area of the over exposed image to create an image with rich gradation. One image with proper exposure and one overlaid image are recorded.

■ D-Range Optimizer

1. MENU → 3 → [DRO/Auto HDR] → [D-Range Opt.]
2. Select the optimal level using ◀ / ▶ on the control wheel.

	 (D-Range Optimizer: Auto)	Corrects the brightness automatically.
	(Level)*	Optimizes the gradations of a recorded image in each area of the image. Select the optimal level between Lv1 (weak) and Lv5 (strong).

* The Lv number that appears with the mark indicates the current setting value.

Notes

- When shooting with [D-Range Opt.], the image may be noisy. Select the proper level by checking the recorded image, especially when you enhance the effect.

■ Auto HDR

1. MENU → 3 → [DRO/Auto HDR] → [Auto HDR]
2. Select the optimal level using ◀ / ▶ on the control wheel.

	 (Auto HDR: Exposure Diff. Auto)	Corrects the exposure difference automatically.
--	-------------------------------------	---

HDR (Exposure Difference Level)*	Sets the exposure difference, based on the contrast of the subject. Select the optimal level between 1.0 EV (weak) and 6.0 EV (strong). For example, if you set the exposure value to 2.0EV, three images will be composed; -1.0EV, optimal exposure and +1.0EV images.
---	---

* The EV number that appears with the **HDR** mark indicates the current setting value.

Notes

- Since the shutter is released three times for one shot, be careful about the following:
 - Use this function when the subject is motionless or does not blink
 - Do not recompose.
- You cannot use this function with RAW images.
- You cannot start the next shoot until the capture process is completed after you shoot.
- You may not obtain a desired effect depending on the luminance difference of a subject and the shooting conditions.
- When the flash is used, this function has little effect.
- When the contrast of the scene is low or when significant camera shake or subject blur has occurred, you may not obtain good HDR images. If the camera detects such situation, **HDR !** is indicated on the recorded image to inform you of this situation. Shoot again, as necessary, recomposing or paying attention to the blur.

Related Topic

[MENU items not available for each shooting mode](#)

[▲ Back to top](#)

Copyright 2013 Sony Corporation

- ▶ Before Use
- ▶ Operating the camera
- ▶ Shooting
- ▶ Viewing
- ▶ Useful shooting functions
- ▶ Useful viewing functions
- ▶ Changing settings
- ▶ Viewing images on a TV
- ▶ Using with your computer
- ▶ Printing
- ▶ Troubleshooting
- ▶ Precautions / About this camera

[➔ Contents list](#)

Creative Style

Allows you to select the desired image processing.

You can adjust contrast, saturation and sharpness as you like for each [Creative Style] mode. Unlike with [Scene Selection], where images are shot automatically, you can adjust the exposure (shutter speed/aperture value), etc.

1. MENU → 3 → [Creative Style] → desired mode

✓	(Standard)	For shooting various scenes with rich gradation and beautiful colors.
	(Vivid)	The saturation and contrast are heightened for shooting striking images of colorful scenes and subjects such as flowers, spring greenery, blue sky, or ocean views.
	(Portrait)	For shooting the skin color in a soft tone, ideally suited for shooting portraits.
	(Landscape)	The saturation, contrast, and sharpness are heightened for shooting vivid and crisp scenery. Distant landscapes also stand out more.
	(Sunset)	For shooting the beautiful red of the setting sun.
	(Black & White)	For shooting images in black and white monotone.

2. When you want to adjust (Contrast), (Saturation), or (Sharpness), press ◀ / ▶ on the control wheel.
3. Select a desired value using ▲ / ▼ .

(Contrast)	The higher the value selected, the more the difference of light and shadow is accentuated, thus making an impact on an image.
(Saturation)	The higher the value selected, the more vivid the color. When a lower value is selected, the color of the image is restrained and subdued.
(Sharpness)	Adjusts the sharpness. The higher the value selected, the more the contours are accentuated, and the lower the value selected, the more the contours are softened.

Notes

- When [Creative Style] is set to [Black & White], [Saturation] cannot be adjusted.

Related Topic

[MENU items not available for each shooting mode](#)

[▲ Back to top](#)





- ▶ Before Use
- ▶ Operating the camera
- ▶ Shooting
- ▶ Viewing
- ▶ Useful shooting functions
- ▶ Useful viewing functions
- ▶ Changing settings
- ▶ Viewing images on a TV
- ▶ Using with your computer
- ▶ Printing
- ▶ Troubleshooting
- ▶ Precautions / About this camera

[➔ Contents list](#)

Picture Effect

Select the desired effect filter to achieve a more impressive and artistic expression.

1. MENU → 3 → [Picture Effect] → desired mode
 - If you select a mode with optional settings, select the desired setting using ◀ / ▶ on the control wheel.
 - If you want to add effects to movies, press the MOVIE (Movie) button.

(Off)	Does not use [Picture Effect].
(Toy Camera)	Allows you to shoot images with effects such as tunnel effect, high contrast, or color cast as if they were shot with a toy camera. You can set the color tone using ◀ / ▶ . 
(Pop Color)	Allows you to shoot a pop art-like colorful image with emphasis on the color tone. 
(Posterization)	Creates a high contrast, abstract look by heavily emphasizing primary colors, or in black and white. You can select primary colors or black and white using ◀ / ▶ . 
(Retro Photo)	Creates the look of an aged photo with sepia color tones and faded contrast. 
	Allows you to shoot soft, clear images with an emphasis on brightness.

 (Soft High-key)



 (Partial Color)



 (High Contrast Mono.)



 (Soft Focus)



 (HDR Painting)







 (Rich-tone Mono.)





Allows an image to be processed so that it looks as though you were shooting dioramas. One part of the image is blurred for a high-contrast image. You can change the blurred part using ◀ / ▶ .

(Miniature)	
 (Watercolor)	Allows you to shoot an image with ink bleed and blurring effects as if it painted with watercolors. 
 (Illustration)	Allows you to shoot an illustration-like image by emphasizing the outlines. You can set the effect intensity using ◀ / ▶ . 

 To add an effect to a movie

- The following [Picture Effect] modes are effective for movies. The Dual Rec function cannot be used.
 - [Toy Camera]
 - [Pop Color]
 - [Posterization]
 - [Retro Photo]
 - [Soft High-key]
 - [Partial Color]
 - [High Contrast Mono.]

Notes

- The [Miniature] effect may not be applied when using a zoom function other than optical zoom.
- When using [Partial Color], the selected color may not remain depending on the subject or shooting condition.
- In the following situations, you cannot confirm the effect before shooting. You also cannot set [Drive Mode].
 - [Soft Focus]
 - [HDR Painting]
 - [Rich-tone Mono.]
 - [Miniature]
 - [Watercolor]
 - [Illustration]
- When the contrast of the scene is low or when significant camera shake or subject blur has occurred with [HDR Painting] or [Rich-tone Mono.] selected, you may not obtain good HDR images. If the camera detects such situations,  is indicated on the recorded image to inform you of this situation. Shoot again, as necessary, recomposing or paying attention to the blur.

Related Topic

[MENU items not available for each shooting mode](#)

- ▶ Before Use
- ▶ Operating the camera
- ▶ Shooting
- ▶ Viewing
- ▶ Useful shooting functions
- ▶ Useful viewing functions
- ▶ Changing settings
- ▶ Viewing images on a TV
- ▶ Using with your computer
- ▶ Printing
- ▶ Troubleshooting
- ▶ Precautions / About this camera

[➔ Contents list](#)

Clear Image Zoom

▼ Total zoom scale when [Clear Image Zoom] is selected (including 3.6× optical zoom)

[Clear Image Zoom] allows you to enlarge the image with close to the original image quality when shooting still images.

The camera zooms images with the original image quality first depending on the selected image size. When [Clear Image Zoom] is set to [On], the camera automatically switches over to [Clear Image Zoom] when the zoom range without deterioration of the original image quality is exceeded.

1. MENU →  4 → [Clear Image Zoom] → desired mode

On	Zooms images with close to the original image quality, depending on the image size. Switches to [Clear Image Zoom] within the range where  is displayed.
<input checked="" type="checkbox"/> Off	Does not use [Clear Image Zoom].

Notes

- To zoom images within the range where original image quality can be retained, set both [Clear Image Zoom] and [Digital Zoom] to [Off]. [\[Details\]](#)
- The [Clear Image Zoom] function does not operate in the following situations:
 - In movie mode
 - In [Sweep Panorama] mode
 - When the Smile Shutter function is activated.
 - When [Drive Mode] is set to [Cont. Shooting], [Spd Priority Cont.], [Self-portrait], [Self-timer(Cont)] or [Bracket: Cont.].
 - When [Quality] is set to [RAW] or [RAW & JPEG].
 - When [ISO] is set to [Multi Frame Noise Reduct.].
- When [Drive Mode] is set to [Cont. Shooting], [Spd Priority Cont.], [Self-timer(Cont)] or [Bracket: Cont.], or while recording movies, the digital zoom will automatically be enabled, regardless of the setting of [Digital Zoom].
- The Face Detection function does not operate in the range of [Clear Image Zoom].

Total zoom scale when [Clear Image Zoom] is selected (including 3.6× optical zoom)

The supported zoom scales are different depending on the image size.

When [Aspect Ratio] is set to [3:2]

Image size	Total zoom scale
L: 20M	Approx. 7.2×
M: 10M	Approx. 10×
S: 5.0M	Approx. 14×

- ▶ Before Use
- ▶ Operating the camera
- ▶ Shooting
- ▶ Viewing
- ▶ Useful shooting functions
- ▶ Useful viewing functions
- ▶ Changing settings
- ▶ Viewing images on a TV
- ▶ Using with your computer
- ▶ Printing
- ▶ Troubleshooting
- ▶ Precautions / About this camera

[➔ Contents list](#)

Digital Zoom

Sets the total zoom scale (including 3.6× optical zoom). When [Digital Zoom] is set to [On], the camera zooms images without deteriorating the original quality, but it automatically switches over to [Digital Zoom] when that zoom range (for achieving the original image quality) is exceeded.

When [Clear Image Zoom] is set to [On] to shoot still images, the camera automatically switches over to [Digital Zoom] when the [Clear Image Zoom] range is exceeded. [\[Details\]](#)

1. MENU →  4 → [Digital Zoom] → desired mode

On	The quality of the resulting image will deteriorate when  is displayed, but you can enlarge images 4× up to the maximum zoom scale.
<input checked="" type="checkbox"/> Off	Does not use [Digital Zoom] when shooting still images. If [Digital Zoom] is set to [Off], the digital zoom function will work when recording a movie.

Notes

- When using [Clear Image Zoom], the maximum zoom scale for [Digital Zoom] is 2×.
- [Digital Zoom] is not available in the following situations:
 - In [Sweep Panorama] mode
 - When the Smile Shutter function is activated.
 - When [Drive Mode] is set to [Self-portrait].
 - When [Quality] is set to [RAW] or [RAW & JPEG].
 - When [ISO] is set to [Multi Frame Noise Reduct.].
- The Face Detection function does not operate in the range of [Digital Zoom].

[▲ Back to top](#)

- ▶ Before Use
- ▶ Operating the camera
- ▶ Shooting
- ▶ Viewing
- ▶ Useful shooting functions
- ▶ Useful viewing functions
- ▶ Changing settings
- ▶ Viewing images on a TV
- ▶ Using with your computer
- ▶ Printing
- ▶ Troubleshooting
- ▶ Precautions / About this camera

[⇒ Contents list](#)



Long Exposure NR

When you set the shutter speed to 1/3 second or longer (Long exposure shooting), noise reduction is turned on for the same duration that the shutter is open. This is to reduce the grainy noise typical in a long exposure.

1. MENU →  4 → [Long Exposure NR] → desired mode

<input checked="" type="checkbox"/>	On	Activates noise reduction for the same duration that the shutter is open. When noise reduction is in progress, a message appears and you cannot take another picture. Select this to prioritize the image quality.
<input type="checkbox"/>	Off	Does not use [Long Exposure NR]. Select this to prioritize the timing of shooting.

Notes

- Even when [Long Exposure NR] is set to [On], noise reduction is not available in the following situations:
 - When [Drive Mode] is set to [Cont. Shooting], [Spd Priority Cont.], [Self-timer(Cont)] or [Bracket: Cont.]
 - When [Scene Selection] is set to  (Sports Action) or  (Hand-held Twilight)
 - In [Sweep Panorama] mode

Related Topic

[MENU items not available for each shooting mode](#)[▲ Back to top](#)

- ▶ [Before Use](#)
- ▶ [Operating the camera](#)
- ▶ [Shooting](#)
- ▶ [Viewing](#)
- ▶ [Useful shooting functions](#)
- ▶ [Useful viewing functions](#)
- ▶ [Changing settings](#)
- ▶ [Viewing images on a TV](#)
- ▶ [Using with your computer](#)
- ▶ [Printing](#)
- ▶ [Troubleshooting](#)
- ▶ [Precautions / About this camera](#)

[⇒ Contents list](#)

High ISO NR

When shooting with a high ISO, the camera reduces noise. When noise reduction is in progress, in some cases a message may appear, and you cannot take another picture during that time.

1. MENU →  4 → [High ISO NR] → desired mode

	High	Activates high ISO noise reduction strongly. Select this to prioritize noise reduction.
<input checked="" type="checkbox"/>	Normal	Activates high ISO noise reduction normally.
	Low	Activates high ISO noise reduction moderately. Select this to prioritize the timing of shooting.

Notes

- Noise reduction is not available for RAW images.

Related Topic

[MENU items not available for each shooting mode](#)

[▲ Back to top](#)

- ▶ Before Use
- ▶ Operating the camera
- ▶ Shooting
- ▶ Viewing
- ▶ Useful shooting functions
- ▶ Useful viewing functions
- ▶ Changing settings
- ▶ Viewing images on a TV
- ▶ Using with your computer
- ▶ Printing
- ▶ Troubleshooting
- ▶ Precautions / About this camera

[⇒ Contents list](#)

AF Illuminator





The AF illuminator supplies fill light to focus more easily on a subject in dark surroundings. The AF illuminator emits red light allowing the camera to focus easily when the shutter button is pressed halfway, until the focus is locked.

The  ON indicator appears at this time.

1. MENU →  4 → [AF Illuminator] → desired mode

<input checked="" type="checkbox"/>	Auto	Sets whether or not to use the AF illuminator.
<input type="checkbox"/>	Off	

Notes

- Focus is achieved as long as the AF illuminator light reaches the subject, regardless of whether light fails to reach the center of the subject.
- You cannot use [AF Illuminator] in the following situations:
 - In movie mode
 - In [Sweep Panorama] mode
 - When  (Landscape),  (Night Scene),  (Pet),  (Fireworks) or  (Sports Action) mode is selected in [Scene Selection].
- When you use the AF illuminator, the normal AF range finder frame is disabled and a new AF range finder frame is displayed by a dotted line. AF operates with priority on subjects located near the center of the frame.
- The AF illuminator emits very bright light. Although there is no health hazard, do not look directly into the AF illuminator emitter at close range.

[▲ Back to top](#)

- ▶ Before Use
- ▶ Operating the camera
- ▶ Shooting
- ▶ Viewing
- ▶ Useful shooting functions
- ▶ Useful viewing functions
- ▶ Changing settings
- ▶ Viewing images on a TV
- ▶ Using with your computer
- ▶ Printing
- ▶ Troubleshooting
- ▶ Precautions / About this camera

[⇒ Contents list](#)

SteadyShot

Sets whether or not you use [SteadyShot] for still image shooting.

1. MENU →  4 → [SteadyShot] → desired mode

<input checked="" type="checkbox"/>	On	Sets whether or not to use [SteadyShot].
<input type="checkbox"/>	Off	

[▲ Back to top](#)

- ▶ Before Use
- ▶ Operating the camera
- ▶ Shooting
- ▶ Viewing
- ▶ Useful shooting functions
- ▶ Useful viewing functions
- ▶ Changing settings
- ▶ Viewing images on a TV
- ▶ Using with your computer
- ▶ Printing
- ▶ Troubleshooting
- ▶ Precautions / About this camera

[➡ Contents list](#)

Color Space

The way colors are represented with combinations of numbers or the range of color reproduction is called "color space." You can change the color space, depending on your purpose.

1. MENU →  4 → [Color Space] → desired mode

<input checked="" type="checkbox"/>	sRGB	This is the standard color space of the digital camera. Use sRGB in normal shooting, such as when you intend to print out the images without any modification.
<input type="checkbox"/>	AdobeRGB	This has a wide range of color reproduction. When a large part of the subject is vivid green or red, Adobe RGB is effective. The file name of the image starts with "_DSC."

Notes

- Adobe RGB is for applications or printers that support color management and DCF2.0 option color space. Using some applications or printers that do not support them may result in or print images that do not faithfully reproduce the color.
- When displaying images that were recorded with Adobe RGB on the camera or non-Adobe RGB-compliant devices, the images are displayed with low saturation.

[▲ Back to top](#)

- ▶ Before Use
- ▶ Operating the camera
- ▶ Shooting
- ▶ Viewing
- ▶ Useful shooting functions
- ▶ Useful viewing functions
- ▶ Changing settings
- ▶ Viewing images on a TV
- ▶ Using with your computer
- ▶ Printing
- ▶ Troubleshooting
- ▶ Precautions / About this camera

[⇒ Contents list](#)

Ctrl with Smartphone

- ▼ [Connect to the camera from an Android smartphone](#)
- ▼ [Connect to the camera from an iOS smartphone](#)
- ▼ [Connect the camera to an Android smartphone with one touch \(One-touch remote \(NFC\)\)](#)
- ▼ [Functions that can be set with the smartphone](#)

You can shoot still images and movies by controlling the camera remotely by a smartphone.

You can also save recorded still images on your smartphone. Install the smartphone support application “PlayMemories Mobile” to your smartphone from the application store. If “PlayMemories Mobile” has already been installed on your smartphone, update it to the latest version.

For details on “PlayMemories Mobile”, refer to the support website (<http://www.sony.net/pmm/>).

1. MENU →  1 → [Ctrl with Smartphone]
2. Connect to the camera from your smartphone, using the information that appears on the screen when the camera is ready to be connected. Connection methods differ, depending on the type of smartphone. [\[Details\]](#) [\[Details\]](#)

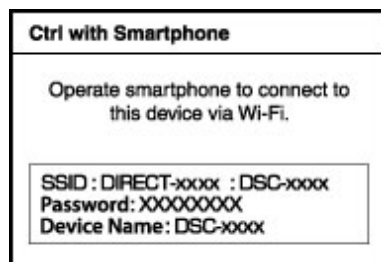

- If you assign [Ctrl with Smartphone] to ◀ / ▶ on the control wheel, you can display the smartphone control screen immediately by pressing ◀ / ▶ .

3. Determine the composition on the screen of the smartphone, then press the shutter button (A) to shoot.

- You can zoom with the zoom button (B).
- You can switch between still images and movies (C).
- You can configure settings for [Flash], [Self-timer] or saving images on your smartphone (D).

[\[Details\]](#)

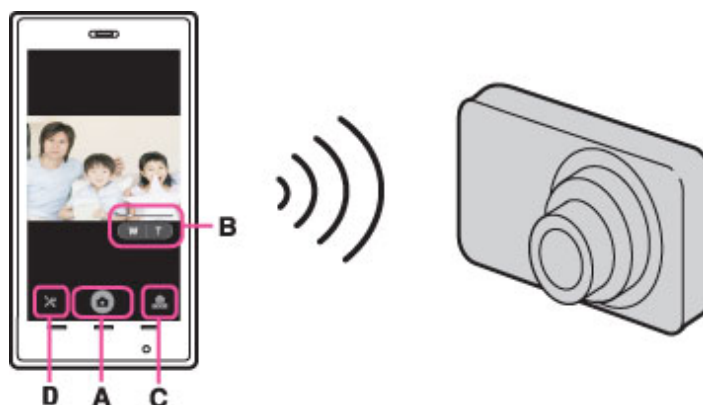

Notes

- When the image size is not [VGA], still images recorded on a smartphone are in [2M] format.

- Movies cannot be recorded on a smartphone.

Connect to the camera from an Android smartphone

1. Start “PlayMemories Mobile” on your smartphone.
2. Select (DIRECT-XXXX : DSC-XXXX).



3. Input the password displayed on the camera.



The smartphone is connected to the camera.

Connect to the camera from an iOS smartphone

1. Select (DIRECT-XXXX : DSC-XXXX) on the Wi-Fi settings screen of iOS.



2. Input the password displayed on the camera.



The smartphone is connected to the camera.

3. Start “PlayMemories Mobile” on your smartphone.

Connect the camera to an Android smartphone with one touch (One-touch remote (NFC))

You can connect the camera to an NFC smartphone with just one touch, without the need for complicated settings.

1. Activate the NFC functions of smartphone.
2. Set the camera to shooting mode.
 - You can use the NFC function only when **N** (N Mark) is displayed on the screen.
3. Touch the camera to the smartphone.

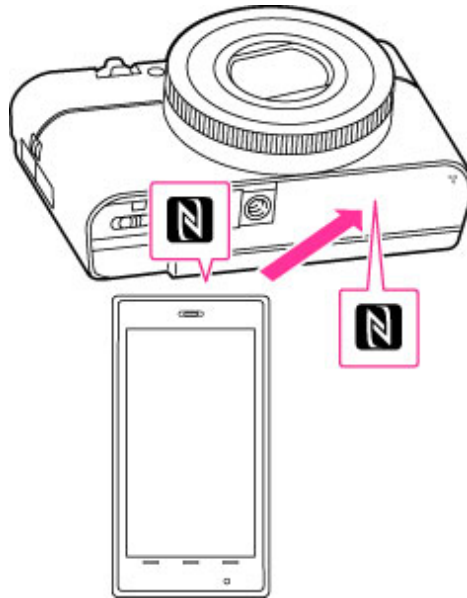

The smartphone is connected to the camera, and “PlayMemories Mobile” is activated. The smartphone control screen is displayed.

- Continue touching until “PlayMemories Mobile” starts (1 - 2 seconds).
- Touch the N mark of the smartphone to **N** (N Mark) of the camera. If there is no N mark on the smartphone, refer to the manual of the smartphone.

About NFC

NFC (Near Field Communication) is a technology enabling short-range wireless communication between various devices, such as mobile phones and IC tags. Thanks to the NFC function, data communication can be achieved easily just by touching the relevant symbol or designated location on NFC compatible devices.

- NFC (Near Field Communication) is an international standard of the short-range wireless communication technology.

Notes

- If you cannot connect the smartphone and camera correctly, do the following.
 - Activate “PlayMemories Mobile” on the smartphone, then move the smartphone slowly around  (N mark) of the camera.
 - If you have put a case on your smartphone, remove the case.
 - If you have put a case on the camera, remove the case.
 - If you have attached a tripod to the camera, remove the tripod temporarily.
 - Confirm that the NFC functions are activated on the smartphone.
- When the camera is in Airplane mode, connection to a smartphone is not possible. Set [Airplane Mode] to [Off].
- If you connect the camera to a smartphone via NFC while the playback screen is displayed on the camera, the image being played back will be transferred to the smartphone.

Functions that can be set with the smartphone

Flash	Select [Off] or [Auto].
Self-timer	Select [Off], [2sec] or [10sec].
Review Check	Select [Off], [Review Only] or [Review, Save Image]. If you select [Review, Save Image], you can also save still pictures on your smartphone.

[▲ Back to top](#)

Copyright 2013 Sony Corporation

- ▶ Before Use
- ▶ Operating the camera
- ▶ Shooting
- ▶ Viewing
- ▶ Useful shooting functions
- ▶ Useful viewing functions
- ▶ Changing settings
- ▶ Viewing images on a TV
- ▶ Using with your computer
- ▶ Printing
- ▶ Troubleshooting
- ▶ Precautions / About this camera

[→ Contents list](#)

Write Date

Sets whether to record a shooting date on the still image.



1. MENU → 5 → [Write Date] → desired mode

On ()	Records a shooting date. When [On] is selected, the mark will appear on the screen while shooting. However, in some shooting modes that cannot record dates on images, the mark will disappear.
<input checked="" type="checkbox"/> Off	Does not record a shooting date.

Notes

- You cannot record dates in the following situations:
 - In movie mode
 - When shooting still images while recording a movie (Dual Rec)
 - In [Sweep Panorama] mode
 - In burst or bracket shooting mode
 - [Quality] is set to [RAW] or [RAW & JPEG]
- If you shoot images with the date once, you cannot delete the date from the images later.
- The dates are doubly printed, if you set the camera to superimpose the dates when printing.
- The recorded time of the image cannot be superimposed on the image.

[▲ Back to top](#)

- ▶ Before Use
- ▶ Operating the camera
- ▶ Shooting
- ▶ Viewing
- ▶ Useful shooting functions
- ▶ Useful viewing functions
- ▶ Changing settings
- ▶ Viewing images on a TV
- ▶ Using with your computer
- ▶ Printing
- ▶ Troubleshooting
- ▶ Precautions / About this camera

[⇒ Contents list](#)

Memory

▼ Items that can be registered

▼ To recall registered settings

Allows you to register up to three often-used modes or camera settings in the camera. You can recall the settings using [Memory recall].



1. Set the camera to the setting you want to register.
2. MENU →  5 → [Memory] → desired number

Notes

- When correcting settings, follow steps 1 – 2 again.

Items that can be registered

Available shooting settings are as follows:

- Shooting modes set using the mode dial
- Aperture (F value)
- Shutter speed
- EV
-  (Still shooting menu) items
-  (Movie shooting menu) items
- Optical zoom scale

Notes

- Program shift and Manual Focus cannot be registered.

To recall registered settings

1. Set the mode dial to **MR** (Memory recall).
2. Press ◀ / ▶ on the control wheel or turn the control wheel to select the desired number

Notes

- If you set **MR** (Memory recall) after completing the shooting settings, the recalled [Memory] values are given priority and the original settings may become invalid. Check the indicators on the screen before shooting.

Related Topic

[Memory recall](#)

[MENU items not available for each shooting mode](#)

[▲ Back to top](#)

- ▶ Before Use
- ▶ Operating the camera
- ▶ Shooting
- ▶ Viewing
- ▶ Useful shooting functions
- ▶ Useful viewing functions
- ▶ Changing settings
- ▶ Viewing images on a TV
- ▶ Using with your computer
- ▶ Printing
- ▶ Troubleshooting
- ▶ Precautions / About this camera

[⇒ Contents list](#)

File Format

You can set the recording method used to record movies.

1. MENU →  1 → [File Format] → desired mode

✓	AVCHD	AVCHD movies are recorded. Sets the recording method to AVCHD, which is suitable for viewing smooth video images on a high-definition television. Blu-ray discs, AVCHD discs and DVD-Video discs can be created using the software "PlayMemories Home." When you create AVCHD discs from movies recorded in [60p 28M(PS)]/[50p 28M(PS)], [60i 24M(FX)]/[50i 24M(FX)] or [24p 24M(FX)]/[25p 24M(FX)], it will take time as the image quality must be converted. To save [60p 28M(PS)]/[50p 28M(PS)], [60i 24M(FX)]/[50i 24M(FX)] or [24p 24M(FX)]/[25p 24M(FX)]movies without converting the image quality, use Blu-ray discs. [Details]
	MP4	MP4 (AVC) movies are recorded. Sets the recording method to MP4, which is suitable for WEB uploads and e-mail attachments. No discs can be created from MP4 movies, even if you use the software "PlayMemories Home."

Related Topic

[AVCHD format](#)

[▲ Back to top](#)

- ▶ Before Use
- ▶ Operating the camera
- ▶ Shooting
- ▶ Viewing
- ▶ Useful shooting functions
- ▶ Useful viewing functions
- ▶ Changing settings
- ▶ Viewing images on a TV
- ▶ Using with your computer
- ▶ Printing
- ▶ Troubleshooting
- ▶ Precautions / About this camera

[➔ Contents list](#)

Record Setting

The larger the size of the movie image, the higher the image quality. The higher the amount of data used per second (average bit-rate), the higher the image quality.

1. MENU →  1 → [Record Setting] → desired mode

File Format: AVCHD

60i/50i:

Movies are recorded at approximately 60 fields/sec (for 1080 60i-compatible devices) or 50 fields/sec (for 1080 50i-compatible devices), in interlaced mode, with Dolby Digital audio, in AVCHD format.

24p/25p:

Movies are recorded at approximately 24 frames/sec (for 1080 60i-compatible devices) or 25 frames/sec (for 1080 50i-compatible devices), in progressive mode, with Dolby Digital audio, in AVCHD format.

60p/50p:

Movies are recorded at approximately 60 frames/sec (for 1080 60i-compatible devices) or 50 frames/sec (for 1080 50i-compatible devices), in progressive mode, with Dolby Digital audio, in AVCHD format.

	Record Setting	Average bit-rate	Description
	60i 24M(FX) 50i 24M(FX)	24 Mbps	Shoots at the high picture quality of 1920×1080 (60i/50i) size
✓	60i 17M(FH) 50i 17M(FH)	17 Mbps	Shoots at a standard picture quality of 1920×1080 (60i/50i) size
	60p 28M(PS) 50p 28M(PS)	28 Mbps	Shoots at the highest picture quality of 1920×1080 (60p/50p) size
	24p 24M(FX) 25p 24M(FX)	24 Mbps	Shoots at a high picture quality of 1920×1080 (24p/25p) size, creating a movie-like atmosphere.
	24p 17M(FH) 25p 17M(FH)	17 Mbps	Shoots at a standard quality of 1920×1080 (24p/25p) size, creating a movie-like atmosphere.

File Format: MP4

Movies shot are recorded in MPEG-4 format, at approximately 30 frames/sec (for 1080 60i-compatible devices) or approximately 25 frames/sec (for 1080 50i-compatible devices), in progressive mode, with AAC audio, mp4 format.

	Record Setting	Average bit-rate	Description
✓			

	1440×1080 12M	12 Mbps	Shoots at 1440×1080 size
	VGA 3M	3 Mbps	Shoots at VGA size

Notes

- A telephoto image is produced when [VGA 3M] image size is selected.
- When you create AVCHD discs from movies recorded in [60p 28M(PS)]/[50p 28M(PS)], [60i 24M(FX)]/[50i 24M(FX)] or [24p 24M(FX)]/[25p 24M(FX)], it will take time, as the image quality must be converted. To save [60p 28M(PS)]/[50p 28M(PS)], [60i 24M(FX)]/[50i 24M(FX)] or [24p 24M(FX)]/[25p 24M(FX)] movies without converting the image quality, use Blu-ray discs.

Related Topic

[File Format](#)

[▲ Back to top](#)

Copyright 2013 Sony Corporation

- ▶ Before Use
- ▶ Operating the camera
- ▶ Shooting
- ▶ Viewing
- ▶ Useful shooting functions
- ▶ Useful viewing functions
- ▶ Changing settings
- ▶ Viewing images on a TV
- ▶ Using with your computer
- ▶ Printing
- ▶ Troubleshooting
- ▶ Precautions / About this camera

[➡ Contents list](#)

Image Size(Dual Rec)

Sets the still image size shot while recording a movie.

1. MENU →  1 → [Image Size(Dual Rec)] → desired size

When [Record Setting] is set to other than [VGA 3M]

✓	L: 17M	For viewing on a high-definition TV and printing up to A3+ size
	S: 4.2M	For viewing on a high-definition TV

When [Record Setting] is set to [VGA 3M]

✓	L: 13M	For prints up to A3 (11×17")
	S: 3.2M	For prints up to 10×15 cm (4×6") or 13×18 cm (5×7")

Related Topic

[MENU items not available for each shooting mode](#)

[▲ Back to top](#)

- ▶ Before Use
- ▶ Operating the camera
- ▶ Shooting
- ▶ Viewing
- ▶ Useful shooting functions
- ▶ Useful viewing functions
- ▶ Changing settings
- ▶ Viewing images on a TV
- ▶ Using with your computer
- ▶ Printing
- ▶ Troubleshooting
- ▶ Precautions / About this camera

[⇒ Contents list](#)

SteadyShot

The strength of [SteadyShot] effect when shooting movies can be adjusted.

1. MENU →  1 → [SteadyShot] → desired mode

<input checked="" type="checkbox"/>	Active	Reduces camera shake when shooting images while walking or zoom shooting.
<input type="checkbox"/>	Standard	Reduces camera shake under stable movie shooting conditions.
<input type="checkbox"/>	Off	Does not provide [SteadyShot].

Notes

- If you change the setting for [SteadyShot], the angle of view will change.

Related Topic

[Shooting movies](#)

[MENU items not available for each shooting mode](#)

[▲ Back to top](#)

- ▶ Before Use
- ▶ Operating the camera
- ▶ Shooting
- ▶ Viewing
- ▶ Useful shooting functions
- ▶ Useful viewing functions
- ▶ Changing settings
- ▶ Viewing images on a TV
- ▶ Using with your computer
- ▶ Printing
- ▶ Troubleshooting
- ▶ Precautions / About this camera

[⇒ Contents list](#)

Audio Recording

When recording a movie, sets whether to record sounds.

1. MENU →  1 → [Audio Recording] → desired mode

<input checked="" type="checkbox"/>	On	When recording a movie, sets whether to record sounds.
<input type="checkbox"/>	Off	

Notes

- When [Audio Recording] is set to [On], the sound of the lens and camera operating will be recorded.

[▲ Back to top](#)

- ▶ Before Use
- ▶ Operating the camera
- ▶ Shooting
- ▶ Viewing
- ▶ Useful shooting functions
- ▶ Useful viewing functions
- ▶ Changing settings
- ▶ Viewing images on a TV
- ▶ Using with your computer
- ▶ Printing
- ▶ Troubleshooting
- ▶ Precautions / About this camera

[⇒ Contents list](#)

Wind Noise Reduct.

Reduces the noise of the wind when shooting movies.

1. MENU →  1 → [Wind Noise Reduct.] → desired mode

	On	Sets whether to reduce wind noise.
<input checked="" type="checkbox"/>	Off	

Notes

- If [Wind Noise Reduct.] is set to [On] even though the wind is not blowing strongly, recorded sounds other than the wind may be hard to hear.

[▲ Back to top](#)

- ▶ Before Use
- ▶ Operating the camera
- ▶ Shooting
- ▶ Viewing
- ▶ Useful shooting functions
- ▶ Useful viewing functions
- ▶ Changing settings
- ▶ Viewing images on a TV
- ▶ Using with your computer
- ▶ Printing
- ▶ Troubleshooting
- ▶ Precautions / About this camera

[⇒ Contents list](#)

FINDER/LCD Setting

When using an electronic viewfinder (sold separately), sets the method for switching between the electronic viewfinder and screen.

✓	Auto	Recognizes the position of eyes and switches the electronic viewfinder/screen automatically.
	Manual	Switches the electronic viewfinder/screen by the button on the viewfinder (sold separately).

Notes

- [FINDER/LCD Setting] can only be set when a compliant electronic viewfinder (sold separately) is attached.

[▲ Back to top](#)

- ▶ Before Use
- ▶ Operating the camera
- ▶ Shooting
- ▶ Viewing
- ▶ Useful shooting functions
- ▶ Useful viewing functions
- ▶ Changing settings
- ▶ Viewing images on a TV
- ▶ Using with your computer
- ▶ Printing
- ▶ Troubleshooting
- ▶ Precautions / About this camera

[➡ Contents list](#)

Red Eye Reduction

The flash strobos two or more times before shooting to reduce the red-eye phenomenon when using flash.

1. MENU →  1 → [Red Eye Reduction] → desired mode

<input type="checkbox"/>	On	The flash strobos to reduce the red-eye phenomenon.
<input checked="" type="checkbox"/>	Off	Does not use [Red Eye Reduction].

What causes the red-eye phenomenon?

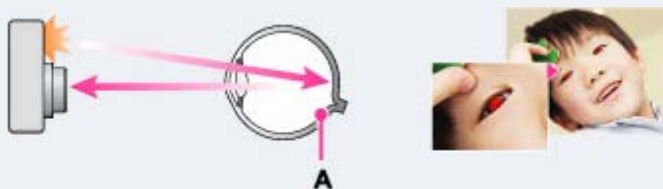

Pupils become dilated in dark environments. The flash light is reflected off the blood vessels at the back of the eye (retina) (A), causing the “red-eye” phenomenon.



Other ways to reduce red-eye

- Select **ISO** (High Sensitivity) mode in [Scene Selection]. ([Flash Mode] is set to [Flash Off] automatically.)

Notes

- To avoid blurring of images, hold the camera firmly until the shutter is released. It usually takes a second until the shutter is released, and also be sure not to allow the subject to move during this period.
- [Red Eye Reduction] may not produce the desired effects. It depends on individual differences and conditions, such as the distance to the subject or if the subject looked away from the pre-strobe.
- [Red Eye Reduction] is set to [Off] in the following situations:
 - In [Sweep Panorama] mode
 - When  (Night Scene) or  (Hand-held Twilight) mode is selected in [Scene Selection].
 - When the Smile Shutter function is activated.

[▲ Back to top](#)

- ▶ Before Use
- ▶ Operating the camera
- ▶ Shooting
- ▶ Viewing
- ▶ Useful shooting functions
- ▶ Useful viewing functions
- ▶ Changing settings
- ▶ Viewing images on a TV
- ▶ Using with your computer
- ▶ Printing
- ▶ Troubleshooting
- ▶ Precautions / About this camera

[⇒ Contents list](#)

Grid Line

With reference to the grid lines, you can easily set a subject in a horizontal/vertical position.

1. MENU →  1 → [Grid Line] → desired mode

	Rule of 3rds Grid	Placing the main subjects close to one of the grid lines that divide the image into thirds makes for a well-balanced composition.
	Square Grid	Square grids make it easier to confirm the horizontal level of your composition. This is suitable for determining the quality of the composition when shooting landscape, close-ups, or duplicated images.
	Diag. + Square Grid	Placing a subject on the diagonal line can express an uplifting and powerful feeling.
<input checked="" type="checkbox"/>	Off	Does not display grid lines.

[▲ Back to top](#)

- ▶ Before Use
- ▶ Operating the camera
- ▶ Shooting
- ▶ Viewing
- ▶ Useful shooting functions
- ▶ Useful viewing functions
- ▶ Changing settings
- ▶ Viewing images on a TV
- ▶ Using with your computer
- ▶ Printing
- ▶ Troubleshooting
- ▶ Precautions / About this camera

[⇒ Contents list](#)

Auto Review

You can check the recorded image on the screen right after the shooting. You can change the displayed time.

1. MENU →  1 → [Auto Review] → desired mode

	10 Sec	Displays for the set time.
	5 Sec	
✓	2 Sec	
	Off	Does not display.

Notes

- Depending on the setting, such as [DRO/Auto HDR] and [Soft Skin Effect], etc., the camera may display an unprocessed image temporarily before the effect-processed image.

[▲ Back to top](#)

- ▶ Before Use
- ▶ Operating the camera
- ▶ Shooting
- ▶ Viewing
- ▶ Useful shooting functions
- ▶ Useful viewing functions
- ▶ Changing settings
- ▶ Viewing images on a TV
- ▶ Using with your computer
- ▶ Printing
- ▶ Troubleshooting
- ▶ Precautions / About this camera

[⇒ Contents list](#)





DISP Button

When shooting, set available screen display mode by pressing the DISP (Display Contents) button on the control wheel.

1. MENU →  1 → [DISP Button] → desired mode

The items marked with  are available.

2. Press the MENU button to set.

Graphic Display	Shows basic shooting information. Graphically shows the shutter speed and aperture value. 
Display All Info.	Displays shooting information. 
No Disp. Info.	Does not display shooting information. 
Level	Displays an indicator guide showing the angle of inclination of the camera to backward, forward, left or right. When the camera is held on a level, this indicator guide appears green. 
Histogram	Displays the luminance distribution graphically.



Related Topic

[DISP \(Display Contents\)](#)

[▲ Back to top](#)

Copyright 2013 Sony Corporation

- ▶ Before Use
- ▶ Operating the camera
- ▶ Shooting
- ▶ Viewing
- ▶ Useful shooting functions
- ▶ Useful viewing functions
- ▶ Changing settings
- ▶ Viewing images on a TV
- ▶ Using with your computer
- ▶ Printing
- ▶ Troubleshooting
- ▶ Precautions / About this camera

[➡ Contents list](#)

Peaking Level

Enhances the outline of in-focus ranges using a specific color in manual focus. This function allows you to confirm the focus easily.

1. MENU →  1 → [Peaking Level] → desired mode

	High	Strongly emphasizes the outline.
	Mid	Moderately emphasizes the outline.
	Low	Slightly emphasizes the outline.
<input checked="" type="checkbox"/>	Off	Does not emphasize the outline.

Notes

- Since the camera judges that sharp areas are in focus, the peaking level differs, depending on the subject, shooting situation.
- The outline of in-focus ranges is not enhanced when the camera is connected using an HDMI cable.

Related Topic

[Peaking Color](#)

[▲ Back to top](#)

- ▶ [Before Use](#)
- ▶ [Operating the camera](#)
- ▶ [Shooting](#)
- ▶ [Viewing](#)
- ▶ [Useful shooting functions](#)
- ▶ [Useful viewing functions](#)
- ▶ [Changing settings](#)
- ▶ [Viewing images on a TV](#)
- ▶ [Using with your computer](#)
- ▶ [Printing](#)
- ▶ [Troubleshooting](#)
- ▶ [Precautions / About this camera](#)

[⇒ Contents list](#)

Peaking Color

Sets the color used for the peaking function in manual focus.

1. MENU →  1 → [Peaking Color] → desired mode

	Red	Enhances outlines in red.
	Yellow	Enhances outlines in yellow.
<input checked="" type="checkbox"/>	White	Enhances outlines in white.

Notes

- This item cannot be set when [Peaking Level] is set to [Off].

Related Topic

[Peaking Level](#)

[▲ Back to top](#)

- ▶ Before Use
- ▶ Operating the camera
- ▶ Shooting
- ▶ Viewing
- ▶ Useful shooting functions
- ▶ Useful viewing functions
- ▶ Changing settings
- ▶ Viewing images on a TV
- ▶ Using with your computer
- ▶ Printing
- ▶ Troubleshooting
- ▶ Precautions / About this camera

[⇒ Contents list](#)

Control Ring

Set the often-used functions to the Control Ring.



1. MENU →  2 → [Control Ring] → desired mode

<input checked="" type="checkbox"/>	Standard	Assigns recommended functions for each shooting mode.
<input type="checkbox"/>	Exposure Comp./ISO/White Balance/Creative Style/Picture Effect/Zoom/Shutter Speed/Aperture	Assigns the function that you set.
<input type="checkbox"/>	Not set	Does not assign functions.

Notes

- When [Focus Mode] is set to [DMF] or [Manual Focus], the function assigned to the Control Ring cannot be recalled. The Control Ring is used for manual focusing.

Functions assigned when [Control Ring] is set to [Standard]

Shooting mode	Functions assigned
 (Intelligent Auto)	Zoom
 (Superior Auto)	Zoom
P (Program Auto)	Program shift
A (Aperture Priority)	Aperture
S (Shutter Priority)	Shutter Speed
M (Manual Exposure)	Aperture
 (Sweep Panorama)	Shooting direction
SCN (Scene Selection)	Scene Selection

Related Topic

[How to use Control Ring](#)

[▲ Back to top](#)

- ▶ Before Use
- ▶ Operating the camera
- ▶ Shooting
- ▶ Viewing
- ▶ Useful shooting functions
- ▶ Useful viewing functions
- ▶ Changing settings
- ▶ Viewing images on a TV
- ▶ Using with your computer
- ▶ Printing
- ▶ Troubleshooting
- ▶ Precautions / About this camera

[⇒ Contents list](#)

Zoom Func. on Ring

Sets the zooming method when the zoom function is assigned to the Control Ring.

In the default setting, the zoom function is assigned to the Control Ring when shooting mode is set to [Intelligent Auto] or [Superior Auto].

1. MENU →  2 → [Zoom Func. on Ring] → desired mode

<input checked="" type="checkbox"/>	Standard	Zooms in/out smoothly using the Control Ring.
<input type="checkbox"/>	Step	Zooms in/out at fixed focal length steps, using the Control Ring. Fixed steps* are 28 mm, 35 mm, 50 mm, 70 mm and 100 mm. * 35 mm equivalent

Notes

- In the following cases, the zoom will be [Standard] even if [Step] is set.
 - When you zoom using the W/T (zoom) lever
 - While recording movies
 - While zoom functions other than optical are used

Related Topic

[Control Ring](#)

[▲ Back to top](#)

- ▶ Before Use
- ▶ Operating the camera
- ▶ Shooting
- ▶ Viewing
- ▶ Useful shooting functions
- ▶ Useful viewing functions
- ▶ Changing settings
- ▶ Viewing images on a TV
- ▶ Using with your computer
- ▶ Printing
- ▶ Troubleshooting
- ▶ Precautions / About this camera

[⇒ Contents list](#)

Control Ring Display

Sets whether to display animation when operating the Control Ring.

1. MENU →  2 → [Control Ring Display] → desired mode

<input checked="" type="checkbox"/>	On	Sets whether to display animation.
<input type="checkbox"/>	Off	

[▲ Back to top](#)

- ▶ Before Use
- ▶ Operating the camera
- ▶ Shooting
- ▶ Viewing
- ▶ Useful shooting functions
- ▶ Useful viewing functions
- ▶ Changing settings
- ▶ Viewing images on a TV
- ▶ Using with your computer
- ▶ Printing
- ▶ Troubleshooting
- ▶ Precautions / About this camera

[⇒ Contents list](#)

Function Button

You can customize the seven functions (A) assigned to the Fn (Function) button.

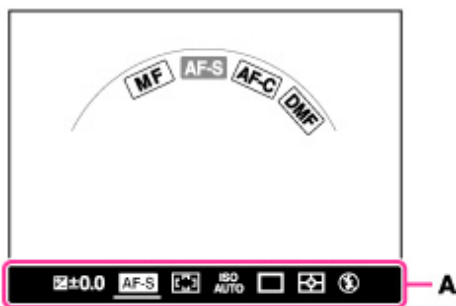

1. MENU → 2 → [Function Button] → [Function 1] to [Function 7] → desired mode
 The functions assigned to [Function 1] to [Function 7] are displayed from left to right on the screen (A).

Functions to be assigned
Exposure Comp.
Focus Mode
Autofocus Area
ISO
Drive Mode
Metering Mode
Flash Mode
Flash Comp.
White Balance
DRO/Auto HDR
Creative Style
Picture Effect
Soft Skin Effect
Quality
Image Size
Smile/Face Detect.
Aspect Ratio
Not set (No assigned functions)

Functions assigned in the default settings	
Function 1	Exposure Comp.

Function 2	ISO
Function 3	White Balance
Function 4	DRO/Auto HDR
Function 5	Picture Effect
Function 6	Not set
Function 7	Not set

Related Topic

[How to use the Fn \(Function\) button](#)

[Exposure Comp.](#)

[Focus Mode](#)

[Autofocus Area](#)

[ISO](#)

[Drive Mode](#)

[Metering Mode](#)

[Flash Mode](#)

[Flash Comp.](#)

[White Balance](#)

[DRO/Auto HDR](#)

[Creative Style](#)

[Picture Effect](#)

[Soft Skin Effect](#)

[Quality](#)

[Image Size](#)

[Smile/Face Detect.](#)

[Aspect Ratio](#)

[▲ Back to top](#)

Copyright 2013 Sony Corporation

- ▶ Before Use
- ▶ Operating the camera
- ▶ Shooting
- ▶ Viewing
- ▶ Useful shooting functions
- ▶ Useful viewing functions
- ▶ Changing settings
- ▶ Viewing images on a TV
- ▶ Using with your computer
- ▶ Printing
- ▶ Troubleshooting
- ▶ Precautions / About this camera

[→ Contents list](#)

Func. of Center Button

▼ Functions assigned when [Func. of Center Button] is set to [Standard]

- ▼ AEL toggle
- ▼ AF/MF Control Toggle
- ▼ Focus Magnifier

Allows you to select frequently used functions and assign them to the center button on the control wheel.

1. MENU →  2 → [Func. of Center Button] → desired mode





	Standard	The function assigned to the center button on the control wheel is different depending on the [Autofocus Area] setting.
	AEL toggle	Assigns the functions that you set.
	AF/MF Control Toggle	
	Focus Magnifier	

Functions assigned when [Func. of Center Button] is set to [Standard]

[Autofocus Area] setting	Assigned setting
Multi	Tracking focus
Center	Tracking focus
Flexible Spot	Change focus area



AEL toggle

When it is hard to obtain an appropriate exposure for a subject, this function allows you to lock the exposure by focusing on and measuring the light of an area that has the desired brightness.

1. MENU →  2 → [Func. of Center Button] → [AEL toggle]
2. Aim the camera at an area to which you want to match the exposure.
The exposure is set.
3. Press  on the control wheel.
The exposure is locked, and  (AE lock) lights up.
4. Focus on your subject and shoot it.
5. To cancel the exposure lock, press  again.



AF/MF Control Toggle

You can switch auto focus and manual focus temporarily.

1. MENU →  2 → [Func. of Center Button] → [AF/MF Control Toggle]
2. Press  to switch auto focus and manual focus.
When [Focus Mode] is set to [Manual Focus], the camera switches to [Single-shot AF], and when [Focus Mode] is set to other than [Manual Focus], it switches to [Manual Focus]. Press  to return to the previous mode.

Focus Magnifier

In [Manual Focus] mode, you can enlarge the image on the screen to make manual-focusing easier by using [Focus Magnifier].

1. MENU →  2 → [Func. of Center Button] → [Focus Magnifier]
2. Press  to enlarge the image.
 - You can set the length of time the image will be enlarged using [Focus Magnif. Time].

Related Topic

[Focus Magnif. Time](#)

[▲ Back to top](#)

Copyright 2013 Sony Corporation

- ▶ Before Use
- ▶ Operating the camera
- ▶ Shooting
- ▶ Viewing
- ▶ Useful shooting functions
- ▶ Useful viewing functions
- ▶ Changing settings
- ▶ Viewing images on a TV
- ▶ Using with your computer
- ▶ Printing
- ▶ Troubleshooting
- ▶ Precautions / About this camera

[⇒ Contents list](#)

Func. of Left Button

Allows you to select frequently used functions and assign them to the left button.

1. MENU →  2 → [Func. of Left Button] → desired mode

	Exposure Comp.	Assigns the function that you set.
✓	Drive Mode	
	Flash Mode	
	Focus Mode	
	Autofocus Area	
	Smile/Face Detect.	
	Auto Object Framing	
	Soft Skin Effect	
	ISO	
	Metering Mode	
	Flash Comp.	
	White Balance	
	DRO/Auto HDR	
	Creative Style	
	Picture Effect	
	Image Size	
	Aspect Ratio	
	Quality	
	Memory	
	AEL toggle	
	AF/MF Control Toggle	
	Focus Magnifier	
	Ctrl with Smartphone	

- For details on [AEL toggle], [AF/MF Control Toggle] and [Focus Magnifier], see “Func. of Center Button”. [\[Details\]](#)

Related Topic

[Exposure Comp.](#)

[Drive Mode](#)

[Flash Mode](#)

[Focus Mode](#)

[Autofocus Area](#)

[Smile/Face Detect.](#)

Auto Object Framing
Soft Skin Effect
ISO
Metering Mode
Flash Comp.
White Balance
DRO/Auto HDR
Creative Style
Picture Effect
Image Size
Aspect Ratio
Quality
Memory
Ctrl with Smartphone

[▲ Back to top](#)

Copyright 2013 Sony Corporation

- ▶ Before Use
- ▶ Operating the camera
- ▶ Shooting
- ▶ Viewing
- ▶ Useful shooting functions
- ▶ Useful viewing functions
- ▶ Changing settings
- ▶ Viewing images on a TV
- ▶ Using with your computer
- ▶ Printing
- ▶ Troubleshooting
- ▶ Precautions / About this camera

[⇒ Contents list](#)

Func. of Right Button

Allows you to select frequently used functions and assign them to the right button.

1. MENU →  2 → [Func. of Right Button] → desired mode

<input type="checkbox"/>	Exposure Comp.	Assigns the function that you set.
<input type="checkbox"/>	Drive Mode	
<input checked="" type="checkbox"/>	Flash Mode	
<input type="checkbox"/>	Focus Mode	
<input type="checkbox"/>	Autofocus Area	
<input type="checkbox"/>	Smile/Face Detect.	
<input type="checkbox"/>	Auto Object Framing	
<input type="checkbox"/>	Soft Skin Effect	
<input type="checkbox"/>	ISO	
<input type="checkbox"/>	Metering Mode	
<input type="checkbox"/>	Flash Comp.	
<input type="checkbox"/>	White Balance	
<input type="checkbox"/>	DRO/Auto HDR	
<input type="checkbox"/>	Creative Style	
<input type="checkbox"/>	Picture Effect	
<input type="checkbox"/>	Image Size	
<input type="checkbox"/>	Aspect Ratio	
<input type="checkbox"/>	Quality	
<input type="checkbox"/>	Memory	
<input type="checkbox"/>	AEL toggle	
<input type="checkbox"/>	AF/MF Control Toggle	
<input type="checkbox"/>	Focus Magnifier	
<input type="checkbox"/>	Ctrl with Smartphone	

- For details on [AEL toggle], [AF/MF Control Toggle] and [Focus Magnifier], see “Func. of Center Button”. [\[Details\]](#)

Related Topic

[Exposure Comp.](#)

[Drive Mode](#)

[Flash Mode](#)

[Focus Mode](#)

[Autofocus Area](#)

[Smile/Face Detect.](#)

[Auto Object Framing](#)

Soft Skin Effect
ISO
Metering Mode
Flash Comp.
White Balance
DRO/Auto HDR
Creative Style
Picture Effect
Image Size
Aspect Ratio
Quality
Memory
Ctrl with Smartphone

[▲ Back to top](#)

Copyright 2013 Sony Corporation



- ▶ Before Use
- ▶ Operating the camera
- ▶ Shooting
- ▶ Viewing
- ▶ Useful shooting functions
- ▶ Useful viewing functions
- ▶ Changing settings
- ▶ Viewing images on a TV
- ▶ Using with your computer
- ▶ Printing
- ▶ Troubleshooting
- ▶ Precautions / About this camera

[⇒ Contents list](#)

MOVIE Button

Allows you to set the mode to enable the MOVIE button.

1. MENU →  3 → [MOVIE Button] → desired mode

	Always	Movie recording starts, regardless of camera status.
	Movie Mode Only	Movie recording starts only when the shooting mode is set to  (Movie).



[▲ Back to top](#)

- ▶ [Before Use](#)
- ▶ [Operating the camera](#)
- ▶ [Shooting](#)
- ▶ [Viewing](#)
- ▶ [Useful shooting functions](#)
- ▶ [Useful viewing functions](#)
- ▶ [Changing settings](#)
- ▶ [Viewing images on a TV](#)
- ▶ [Using with your computer](#)
- ▶ [Printing](#)
- ▶ [Troubleshooting](#)
- ▶ [Precautions / About this camera](#)

[➡ Contents list](#)

MF Assist

Enlarges the image on the screen automatically to make manual focusing easier. This works in [Manual Focus] or [DMF] modes.

1. MENU →  3 → [MF Assist] → desired mode
2. Turn the Control Ring to adjust the focus.
The image is enlarged 8.6 times. You can also enlarge the image 17.1 times by pressing  on the control wheel.

<input checked="" type="checkbox"/>	On	Enlarges the image. You can set the enlarging duration using [Focus Magnif. Time].
<input type="checkbox"/>	Off	Does not enlarge the image.

Notes

- You cannot use [MF Assist] when shooting movies.

Related Topic

[Focus Magnif. Time](#)[▲ Back to top](#)

[Top page](#) > [Useful shooting functions](#) > [Using shooting functions](#) > [Focus Magnif. Time](#)

- ▶ Before Use
- ▶ Operating the camera
- ▶ Shooting
- ▶ Viewing
- ▶ Useful shooting functions
- ▶ Useful viewing functions
- ▶ Changing settings
- ▶ Viewing images on a TV
- ▶ Using with your computer
- ▶ Printing
- ▶ Troubleshooting
- ▶ Precautions / About this camera

[⇒ Contents list](#)

Focus Magnif. Time

Sets the length of time the image will be shown in an expanded version for the [MF Assist] or [Focus Magnifier] function.

1. MENU →  3 → [Focus Magnif. Time] → desired mode

<input checked="" type="checkbox"/>	2 Sec	Enlarges the image for two seconds.
	5 Sec	Enlarges the image for five seconds.
	No Limit	Enlarges the display with no limit. Press the shutter button to cancel enlargement of the display.

Related Topic

[MF Assist](#)

[Func. of Center Button](#)

[▲ Back to top](#)

Copyright 2013 Sony Corporation

- ▶ Before Use
- ▶ Operating the camera
- ▶ Shooting
- ▶ Viewing
- ▶ Useful shooting functions
- ▶ Useful viewing functions
- ▶ Changing settings
- ▶ Viewing images on a TV
- ▶ Using with your computer
- ▶ Printing
- ▶ Troubleshooting
- ▶ Precautions / About this camera

[⇒ Contents list](#)

Face Priority Tracking

When the camera detects faces while using the tracking focus function, sets whether to give priority to a face.

1. MENU →  3 → [Face Priority Tracking] → desired mode

<input checked="" type="checkbox"/>	On	The camera tracks with priority assigned to a face while using the tracking focus function.
<input type="checkbox"/>	Off	The camera does not give priority to a face while tracking.

[▲ Back to top](#)

- ▶ Before Use
- ▶ Operating the camera
- ▶ Shooting
- ▶ Viewing
- ▶ Useful shooting functions
- ▶ Useful viewing functions
- ▶ Changing settings
- ▶ Viewing images on a TV
- ▶ Using with your computer
- ▶ Printing
- ▶ Troubleshooting
- ▶ Precautions / About this camera

[→ Contents list](#)

Face Registration

▼ New Registration

▼ Order Exchanging

If you register faces in advance, the camera can detect the registered face as a priority when [Smile/Face Detect.] is set to [On (Regist. Faces)].

1. MENU →  3 → [Face Registration] → desired mode

New Registration	Registers a new face.
Order Exchanging	Changes the priority of faces previously registered.
Delete	Selects a registered face to delete.
Delete All	Deletes all registered faces.

■ New Registration

1. MENU →  3 → [Face Registration] → [New Registration]
2. Align the guide frame with the face to be registered, and press the shutter button.
3. When a confirmation message appears, select [Enter].

Notes

- Up to eight faces can be registered.
- Shoot the face from the front in a brightly lit place. The face may not be registered correctly if it is obscured by a hat, a mask, sunglasses, etc.
- Even if you execute [Initialize], registered faces are not deleted. Even if you execute [Delete], the data for registered face will remain in the camera. To delete the data for registered faces from the camera, select [Delete All].

■ Order Exchanging

1. MENU →  3 → [Face Registration] → [Order Exchanging]
2. Select a face for which you want to change the priority.
3. Select the priority level.
The smaller the number, the higher the priority.

Related Topic

[Smile/Face Detect.](#)

[▲ Back to top](#)

[Top page](#) > [Useful viewing functions](#) > [Functions not available for each view mode](#) > [MENU items not available for each view mode](#)

- ▶ Before Use
- ▶ Operating the camera
- ▶ Shooting
- ▶ Viewing
- ▶ Useful shooting functions
- ▶ Useful viewing functions
- ▶ Changing settings
- ▶ Viewing images on a TV
- ▶ Using with your computer
- ▶ Printing
- ▶ Troubleshooting
- ▶ Precautions / About this camera

[⇒ Contents list](#)

MENU items not available for each view mode

In the table below, a check mark indicates settings that can be changed, while — indicates settings that cannot be changed.

Menu items	Folder view (Still)	Folder view (MP4)	AVCHD view
Still/Movie Select	✓	✓	✓
Delete	✓	✓	✓
Slide Show	✓	—	—
Image Index	✓	✓	✓
Protect	✓	✓	✓
Specify Printing	✓	—	—
Send to Smartphone	✓	✓	✓
Send to Computer	✓	✓	✓
View on TV	✓	—	—
Picture Effect	✓	—	—
Volume Settings	✓	✓	✓
Playback Display	✓	✓	✓

[▲ Back to top](#)





- ▶ Before Use
- ▶ Operating the camera
- ▶ Shooting
- ▶ Viewing
- ▶ Useful shooting functions
- ▶ Useful viewing functions
- ▶ Changing settings
- ▶ Viewing images on a TV
- ▶ Using with your computer
- ▶ Printing
- ▶ Troubleshooting
- ▶ Precautions / About this camera

[⇒ Contents list](#)

Still/Movie Select

Switches the display mode between still images and movies (View Mode).

1. MENU →  1 → [Still/Movie Select] → desired mode

	 (Folder View(Still))	Displays still images.
	 (Folder View(MP4))	Displays MP4-format movies.
	 (AVCHD View)	Displays AVCHD-format movies.

Viewing images taken with a different camera

This camera creates an Image Database File on a memory card for recording and playing images. Images not registered in the Image Database File may not be displayed correctly.

Register images recorded with other cameras by selecting MENU →  1 → [Recover Image DB] to play them back on this camera.

- Use a sufficiently charged battery to register images. If a battery with a low charge is used to register images, it may not be possible to transfer all of the data or the data may be corrupted if the battery charge runs out.

Related Topic

[Recover Image DB](#)

[▲ Back to top](#)







- ▶ Before Use
- ▶ Operating the camera
- ▶ Shooting
- ▶ Viewing
- ▶ Useful shooting functions
- ▶ Useful viewing functions
- ▶ Changing settings
- ▶ Viewing images on a TV
- ▶ Using with your computer
- ▶ Printing
- ▶ Troubleshooting
- ▶ Precautions / About this camera

[⇒ Contents list](#)

Delete

Allows you to select unwanted images for deletion. You can also delete images using the Delete button.

1. MENU →  1 → [Delete] → desired mode

 (Multiple Img.)	Allows you to select and delete multiple images. ① After step 1, select an image to be deleted, then press  . To cancel the selection, press  again to cancel the  mark. ② MENU → [OK] → 
 (All in Folder)	Deletes all still images and movies in the selected folder at once.
 (All AVCHD view files)	Deletes all AVCHD movies at once.

Related Topic

[Deleting images](#)

[▲ Back to top](#)

- ▶ Before Use
- ▶ Operating the camera
- ▶ Shooting
- ▶ Viewing
- ▶ Useful shooting functions
- ▶ Useful viewing functions
- ▶ Changing settings
- ▶ Viewing images on a TV
- ▶ Using with your computer
- ▶ Printing
- ▶ Troubleshooting
- ▶ Precautions / About this camera

[⇒ Contents list](#)

Slide Show

Plays back images automatically.

Plays back only 3D images in [Slide Show] on a 3D TV connected to the camera.

1. MENU →  1 → [Slide Show]
The setting screen appears.
2. Select the desired setting.
3. [Enter] → ● on the control wheel
4. Press ● to exit [Slide Show].

Repeat		
<input type="checkbox"/>	On	Plays back images in a continuous loop.
<input checked="" type="checkbox"/>	Off	After all the images have been played back, the slide show ends.
Interval		
<input type="checkbox"/>	1 Sec	Sets the display interval for images.
<input checked="" type="checkbox"/>	3 Sec	
<input type="checkbox"/>	5 Sec	
<input type="checkbox"/>	10 Sec	
<input type="checkbox"/>	30 Sec	
Image Type		
<input checked="" type="checkbox"/>	All	Plays back all still images as normal images.
<input type="checkbox"/>	Display 3D Only	Plays back 3D images only.

Related Topic

[MENU items not available for each view mode](#)

[▲ Back to top](#)



- ▶ Before Use
- ▶ Operating the camera
- ▶ Shooting
- ▶ Viewing
- ▶ Useful shooting functions
- ▶ Useful viewing functions
- ▶ Changing settings
- ▶ Viewing images on a TV
- ▶ Using with your computer
- ▶ Printing
- ▶ Troubleshooting
- ▶ Precautions / About this camera

[→ Contents list](#)

Image Index

Selects the number of images to be displayed on the index.

1. MENU →  2 → [Image Index] → desired mode

<input checked="" type="checkbox"/>	 (4 Images)	Displays four images.
<input type="checkbox"/>	 (9 Images)	Displays nine images.

Displaying images of the desired folder

Select the left side bar with the control wheel, then select the desired folder using ▲ / ▼ .

Press ● on the control wheel to switch the display mode between still images and movies (View Mode).

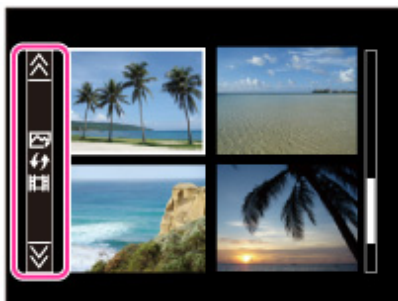
[▲ Back to top](#)









- ▶ Before Use
- ▶ Operating the camera
- ▶ Shooting
- ▶ Viewing
- ▶ Useful shooting functions
- ▶ Useful viewing functions
- ▶ Changing settings
- ▶ Viewing images on a TV
- ▶ Using with your computer
- ▶ Printing
- ▶ Troubleshooting
- ▶ Precautions / About this camera

[⇒ Contents list](#)

Protect

Protects recorded images against accidental erasure.
The  mark is displayed for registered images.

1. MENU →  2 → [Protect] → desired mode

 (Multiple Img.)	<p>You can select and protect multiple images.</p> <p>① After step 1, select an image to be protected, then press  . To cancel the selection, press  again to cancel the  mark.</p> <p>② MENU → [OK] → </p>
 (Cancel All Images)	Cancels the protection of all still images.
 (Cancel All Movies(MP4))	Cancels the protection of all movies (MP4).
 (Cancel All AVCHD view files)	Cancels the protection of all AVCHD movies.

[▲ Back to top](#)

- ▶ Before Use
- ▶ Operating the camera
- ▶ Shooting
- ▶ Viewing
- ▶ Useful shooting functions
- ▶ Useful viewing functions
- ▶ Changing settings
- ▶ Viewing images on a TV
- ▶ Using with your computer
- ▶ Printing
- ▶ Troubleshooting
- ▶ Precautions / About this camera





[⇒ Contents list](#)

Specify Printing

DPOF (Digital Print Order Format) is a function that allows you to specify the images of the memory card that you want to print out later.

The **DPOF** (Print order) mark is displayed for registered images.

1. MENU →  2 → [Specify Printing] → desired setting

DPOF Setup	
Multiple Img.	<p>You can select and order multiple images to be printed.</p> <p>① After step 1, select an image to be printed, then press  .</p> <p>To cancel the selection, press  again to cancel the  mark.</p> <p>② MENU → [OK] → </p>
Cancel All	Clears all DPOF marks.
Date Imprint	
On	Sets whether or not to date the DPOF marked images when printing them.
 Off	

Notes

- The **DPOF** (Print order) mark cannot be added to movies.
- You can add a **DPOF** (Print order) mark to a maximum 999 images.

Related Topic

[Printing still images](#)

[▲ Back to top](#)

- ▶ Before Use
- ▶ Operating the camera
- ▶ Shooting
- ▶ Viewing
- ▶ Useful shooting functions
- ▶ Useful viewing functions
- ▶ Changing settings
- ▶ Viewing images on a TV
- ▶ Using with your computer
- ▶ Printing
- ▶ Troubleshooting
- ▶ Precautions / About this camera

[⇒ Contents list](#)

Send to Smartphone



▼ Transfer images to an Android smartphone with one touch (One-touch sharing (NFC))

Allows you to transfer images to display on a smartphone.

Install the smartphone support application “PlayMemories Mobile” to your smartphone from the application store. If “PlayMemories Mobile” has already been installed on your smartphone, update it to the latest version.

For details on “PlayMemories Mobile”, refer to the support website (<http://www.sony.net/pmm/>).

1. MENU →  1 → [Send to Smartphone] → desired mode

Select on This Device	Select images on the camera to be transferred to the smartphone. <ol style="list-style-type: none"> ① Select from [This Image], [All Still Images on Date], [All Movie(MP4) on Date] or [Multiple Images]. ② If you select [Multiple Images], select images with  → MENU → [OK] → .
Select on Smartphone	Transfer all still images in a memory card to display on a smartphone.

2. Connect to the camera from your smartphone, using the information that appears on the screen when the camera is ready to be connected. Connection methods differ, depending on the type of smartphone. [\[Details\]](#)[\[Details\]](#)

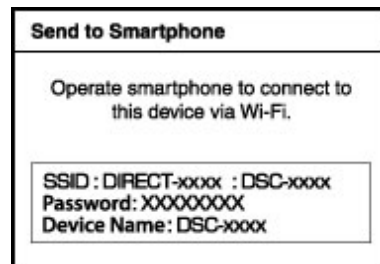

Notes

- Options for image size are the size in which the image was shot, [2M] or [VGA] format.
- To change the size of an image to be transferred to a smartphone, use “PlayMemories Mobile”.
- Some images may not be played back on the smartphone depending on the data format.
- RAW images are converted into JPEG images and then transferred.
- You cannot transfer AVCHD movies.
- The camera shares the connection information for [Send to Smartphone] with a device that has permission to connect. If you want to change the device that is permitted to connect to the camera, reset the connection information by pressing MENU →  3 → [SSID/PW Reset]. After resetting the connection information, you must set a smartphone. [\[Details\]](#)

Transfer images to an Android smartphone with one touch (One-touch sharing (NFC))

You can connect the camera to an NFC smartphone with just one touch, without the need for complicated settings, and transfer images.

1. Activate the NFC functions of smartphone.
2. Display a single image on the camera.
 - You can use the NFC function only when **N** (N Mark) is displayed on the screen.
3. Touch the camera to the smartphone.

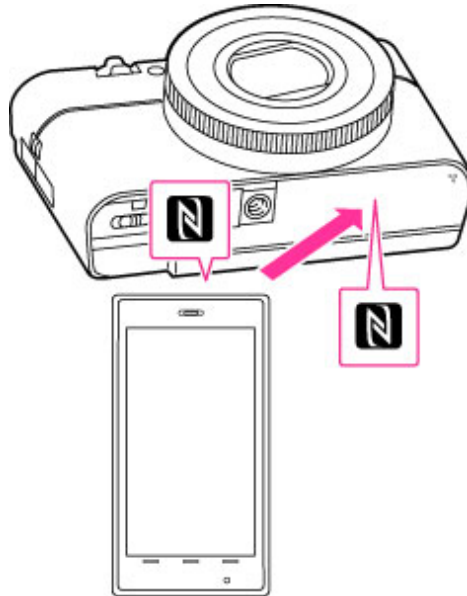

The smartphone is connected to the camera, and “PlayMemories Mobile” is activated. The image being displayed on the camera is transferred to the smartphone.

- Continue touching until “PlayMemories Mobile” starts (1 - 2 seconds).
- Touch after canceling sleep and the screen lock of the smartphone.
- Touch the N mark of the smartphone to **N** (N Mark) of the camera. If there is no N mark on the smartphone, refer to the manual of the smartphone.
- If you want to transfer multiple images at once, press MENU → 1 → [Send to Smartphone] and select the desired images. Wait for on-screen confirmation to connect, then connect the camera to the smartphone via NFC.

About NFC

NFC (Near Field Communication) is a technology enabling short-range wireless communication between various devices, such as mobile phones and IC tags. Thanks to the NFC function, data communication can be achieved easily just by touching the relevant symbol or designated location on NFC compatible devices.

Notes

- You cannot transfer images via NFC when the image index screen is displayed.
- If you cannot connect the smartphone and camera correctly, do the following.
 - Activate “PlayMemories Mobile” on the smartphone, then move the smartphone slowly around **N** (N mark) of the camera.
 - If you have put a case on your smartphone, remove the case.
 - If you have put a case on the camera, remove the case.
 - If you have attached a tripod to the camera, remove the tripod temporarily.
 - Confirm that the NFC functions are activated on the smartphone.
- When the camera is in Airplane mode, connection to a smartphone is not possible. Set [Airplane Mode] to [Off].

- ▶ Before Use
- ▶ Operating the camera
- ▶ Shooting
- ▶ Viewing
- ▶ Useful shooting functions
- ▶ Useful viewing functions
- ▶ Changing settings
- ▶ Viewing images on a TV
- ▶ Using with your computer
- ▶ Printing
- ▶ Troubleshooting
- ▶ Precautions / About this camera

[⇒ Contents list](#)

Send to Computer

You can easily back up images from the camera to a computer connected to your wireless access point or wireless broadband router.

Install “PlayMemories Home” [\[Details\]](#) before registering the wireless access point [\[Details\]](#) [\[Details\]](#).

1. Start your computer.
2. MENU →  1 → [Send to Computer] → ●

Notes

- Depending on the application settings of your computer, the camera will turn off after saving the images to your computer.
- Set up the access point in advance.
- You can simultaneously transfer multiple images to a personal computer.
- To transfer images to another computer, use a USB cable to connect the camera to the personal computer, then operate the camera with “PlayMemories Home”.

Related Topic

[WPS Push](#)

[Access Point Settings](#)



[▲ Back to top](#)

- ▶ Before Use
- ▶ Operating the camera
- ▶ Shooting
- ▶ Viewing
- ▶ Useful shooting functions
- ▶ Useful viewing functions
- ▶ Changing settings
- ▶ Viewing images on a TV
- ▶ Using with your computer
- ▶ Printing
- ▶ Troubleshooting
- ▶ Precautions / About this camera





[→ Contents list](#)

View on TV

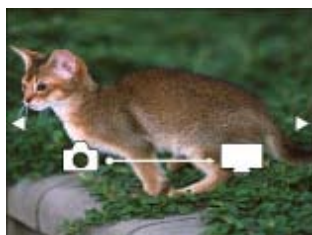
If the camera and TV are not connected using an HDMI cable, you can view images on a network-enabled TV by transferring the image from the camera. You may need to set the TV beforehand, depending on the model. For details, see the instruction manual of the TV.

1. MENU →  1 → [View on TV] → desired device to be connected
2. When you want to play back images using slideshow, press .



- To play back images manually, press  / .
- To change the device to be connected, press  to select [Device list], and press .

Slideshow setting

You can change the settings for the slideshow by pressing .

Playback Selection	Selects the group of images to be shown. Selects from [All] or [All in Folder].
Interval	Selects from [Short] or [Long].
Effects*	Selects from [On] or [Off].

* The settings are effective only for BRAVIA TV which is compatible with the functions.

Notes

- You can use this function on a TV that supports DLNA renderer.
- You can view images on a Wi-Fi Direct-enabled TV or network-enabled TV (including cable TV).
- If you connect TV and the camera and do not use Wi-Fi Direct, you need to register your access point on the camera first.
- Displaying the images on the TV may take time.
- Movies cannot be shown on TV using Wi-Fi. Use an HDMI cable (sold separately).

Related Topic

[WPS Push](#)

[Access Point Settings](#)

[▲ Back to top](#)



- ▶ Before Use
- ▶ Operating the camera
- ▶ Shooting
- ▶ Viewing
- ▶ Useful shooting functions
- ▶ Useful viewing functions
- ▶ Changing settings
- ▶ Viewing images on a TV
- ▶ Using with your computer
- ▶ Printing
- ▶ Troubleshooting
- ▶ Precautions / About this camera

[⇒ Contents list](#)

Picture Effect

Retouches a recorded image so that it looks like a watercolor or illustration, and saves it as a new file. The original image is retained.

1. MENU →  2 → [Picture Effect] → desired mode

 (Watercolor)	Adds ink bleed and gradational effects to images as if they were painted using watercolors.
 (Illustration)	Adds illustration-like effects to images by emphasizing contours, etc.

Notes

- You cannot use [Picture Effect] for the following images:
 - Panoramic images
 - Movies

[▲ Back to top](#)

- ▶ Before Use
- ▶ Operating the camera
- ▶ Shooting
- ▶ Viewing
- ▶ Useful shooting functions
- ▶ Useful viewing functions
- ▶ Changing settings
- ▶ Viewing images on a TV
- ▶ Using with your computer
- ▶ Printing
- ▶ Troubleshooting
- ▶ Precautions / About this camera

[⇒ Contents list](#)

Volume Settings

Adjusts the sound volume of movies in eight steps.

1. MENU →  2 → [Volume Settings] → desired value



Adjusting the volume during playback

The [Volume Settings] screen appears when you press the bottom of the control wheel while playing back movies.

You can adjust the volume while listening to the actual sound.

[▲ Back to top](#)

- ▶ Before Use
- ▶ Operating the camera
- ▶ Shooting
- ▶ Viewing
- ▶ Useful shooting functions
- ▶ Useful viewing functions
- ▶ Changing settings
- ▶ Viewing images on a TV
- ▶ Using with your computer
- ▶ Printing
- ▶ Troubleshooting
- ▶ Precautions / About this camera

[⇒ Contents list](#)

Playback Display

Selects the orientation when playing back still images recorded in portrait orientation.

1. MENU →  2 → [Playback Display] → desired mode

<input checked="" type="checkbox"/>	Auto Rotate	Displays in portrait orientation.
<input type="checkbox"/>	Manual Rotate	Displays in landscape orientation.

[▲ Back to top](#)

[▶ Before Use](#)[▶ Operating the camera](#)[▶ Shooting](#)[▶ Viewing](#)[▶ Useful shooting functions](#)[▶ Useful viewing functions](#)[▶ Changing settings](#)[▶ Viewing images on a TV](#)[▶ Using with your computer](#)[▶ Printing](#)[▶ Troubleshooting](#)[▶ Precautions / About this camera](#)[⇒ Contents list](#)

Format

Formats the memory card.

When you use a memory card with this camera for the first time, it is recommended to format the card using the camera for stable performance of the memory card before shooting. Note that formatting permanently erases all data on the memory card, and is unrecoverable. Save precious data on a computer, etc.

1. MENU →  1 → [Format] → [Enter]

Notes

- Note that formatting permanently erases all data including even protected images.

[▲ Back to top](#)

[▶ Before Use](#)[▶ Operating the camera](#)[▶ Shooting](#)[▶ Viewing](#)[▶ Useful shooting functions](#)[▶ Useful viewing functions](#)[▶ Changing settings](#)[▶ Viewing images on a TV](#)[▶ Using with your computer](#)[▶ Printing](#)[▶ Troubleshooting](#)[▶ Precautions / About this camera](#)[⇒ Contents list](#)

File Number

Selects the method used to assign file numbers to images.

1. MENU →  1 → [File Number] → desired mode

<input checked="" type="checkbox"/>	Series	Assigns numbers to files in sequence even if the recording folder or the memory card is changed. (When the replaced memory card contains a file with a number higher than the last assigned number, a number one higher than the largest number is assigned.)
<input type="checkbox"/>	Reset	Starts from 0001 each time the folder is changed. (When the recording folder contains a file, a number one higher than the largest number is assigned.)

[▲ Back to top](#)

[▶ Before Use](#)[▶ Operating the camera](#)[▶ Shooting](#)[▶ Viewing](#)[▶ Useful shooting functions](#)[▶ Useful viewing functions](#)[▶ Changing settings](#)[▶ Viewing images on a TV](#)[▶ Using with your computer](#)[▶ Printing](#)[▶ Troubleshooting](#)[▶ Precautions / About this camera](#)[⇒ Contents list](#)

Select REC Folder

Changes the folder in the memory card that is currently used for recording images.

1. MENU →  1 → [Select REC Folder]
2. Select a folder with ▲ / ▼ on the control wheel.
3. Press ●

Notes

- You cannot select a folder with a number that has only “□ □ □ MSDCF” or “□ □ □ ANV01” as a recording folder.
- You cannot move recorded images to another folder.

[▲ Back to top](#)

- ▶ [Before Use](#)
- ▶ [Operating the camera](#)
- ▶ [Shooting](#)
- ▶ [Viewing](#)
- ▶ [Useful shooting functions](#)
- ▶ [Useful viewing functions](#)
- ▶ [Changing settings](#)
- ▶ [Viewing images on a TV](#)
- ▶ [Using with your computer](#)
- ▶ [Printing](#)
- ▶ [Troubleshooting](#)
- ▶ [Precautions / About this camera](#)

[⇒ Contents list](#)

New Folder

Creates a folder in a memory card for recording images.

Images are recorded in the newly created folder until you create another folder or select another recording folder.

1. MENU →  1 → [New Folder]

On folders

After a new folder is created, you can change the storage destination folder. [\[Details\]](#)

Notes

- When you insert a memory card that was used with other equipment into the camera and shoot images, a new folder may be automatically created.
- Up to 4,000 images can be stored in one folder. When the folder capacity is exceeded, a new folder is automatically created.

[▲ Back to top](#)

- ▶ Before Use
- ▶ Operating the camera
- ▶ Shooting
- ▶ Viewing
- ▶ Useful shooting functions
- ▶ Useful viewing functions
- ▶ Changing settings
- ▶ Viewing images on a TV
- ▶ Using with your computer
- ▶ Printing
- ▶ Troubleshooting
- ▶ Precautions / About this camera

[⇒ Contents list](#)

Recover Image DB

When inconsistencies are found in the image database file, caused by processing files on computers, etc., images on the memory card will not be played back in this form. If this happens, the camera repairs the file.

1. MENU →  1 → [Recover Image DB] → [Enter]

The [Recover Image DB] screen is displayed, and the camera repairs the file.
Wait until the repair is completed.

Notes

- Use a sufficiently charged battery. Low battery power during repairs can cause damage to data.

[▲ Back to top](#)

- ▶ Before Use
- ▶ Operating the camera
- ▶ Shooting
- ▶ Viewing
- ▶ Useful shooting functions
- ▶ Useful viewing functions
- ▶ Changing settings
- ▶ Viewing images on a TV
- ▶ Using with your computer
- ▶ Printing
- ▶ Troubleshooting
- ▶ Precautions / About this camera

[⇒ Contents list](#)

Display Card Space

Displays the remaining recording time for movies on the memory card. The number of recordable still images is also displayed.

1. MENU →  1 → [Display Card Space]

[▲ Back to top](#)

- ▶ Before Use
- ▶ Operating the camera
- ▶ Shooting
- ▶ Viewing
- ▶ Useful shooting functions
- ▶ Useful viewing functions
- ▶ **Changing settings**
- ▶ Viewing images on a TV
- ▶ Using with your computer
- ▶ Printing
- ▶ Troubleshooting
- ▶ Precautions / About this camera

[⇒ Contents list](#)

Date/Time Setup

Sets the date and time again.

1. MENU →  1 → [Date/Time Setup]
2. Press ◀ / ▶ or turn the control wheel to select the desired item, and set the numeric value using ▲ / ▼ .
3. ● → [Enter]

Daylight Svg.:	You can select Summer Time ON/OFF.
Date Format:	You can select the date and time display format.

[▲ Back to top](#)

- ▶ Before Use
- ▶ Operating the camera
- ▶ Shooting
- ▶ Viewing
- ▶ Useful shooting functions
- ▶ Useful viewing functions
- ▶ **Changing settings**
- ▶ Viewing images on a TV
- ▶ Using with your computer
- ▶ Printing
- ▶ Troubleshooting
- ▶ Precautions / About this camera

[➔ Contents list](#)

Area Setting

Adjusts the time to the local time of a selected area.

1. MENU →  1 → [Area Setting]
2. Press ◀ / ▶ on the control wheel or turn the control wheel to select the desired area, then select Daylight Savings time using ▲ / ▼ .

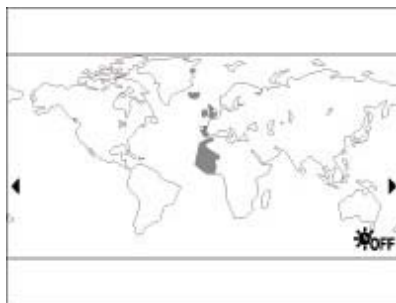

3. Press ● → [Enter].

[▲ Back to top](#)

- ▶ Before Use
- ▶ Operating the camera
- ▶ Shooting
- ▶ Viewing
- ▶ Useful shooting functions
- ▶ Useful viewing functions
- ▶ Changing settings
- ▶ Viewing images on a TV
- ▶ Using with your computer
- ▶ Printing
- ▶ Troubleshooting
- ▶ Precautions / About this camera

[⇒ Contents list](#)

Menu start

Allows you to select whether to always display the first screen of the menu or to display the screen of the item previously set.

1. MENU →  1 → [Menu start] → desired mode

<input checked="" type="checkbox"/>	Top	Always displays the first screen of the menu.
<input type="checkbox"/>	Previous	Displays the last item set. This makes it easier to quickly reset the item you set previously.

[▲ Back to top](#)

- ▶ Before Use
- ▶ Operating the camera
- ▶ Shooting
- ▶ Viewing
- ▶ Useful shooting functions
- ▶ Useful viewing functions
- ▶ Changing settings
- ▶ Viewing images on a TV
- ▶ Using with your computer
- ▶ Printing
- ▶ Troubleshooting
- ▶ Precautions / About this camera

[⇒ Contents list](#)

Mode Dial Guide

Sets whether to display the mode dial guide (description for each shooting mode).

1. MENU →  1 → [Mode Dial Guide] → desired mode

<input checked="" type="checkbox"/>	On	Sets whether to display [Mode Dial Guide].
<input type="checkbox"/>	Off	

[▲ Back to top](#)

- ▶ Before Use
- ▶ Operating the camera
- ▶ Shooting
- ▶ Viewing
- ▶ Useful shooting functions
- ▶ Useful viewing functions
- ▶ Changing settings
- ▶ Viewing images on a TV
- ▶ Using with your computer
- ▶ Printing
- ▶ Troubleshooting
- ▶ Precautions / About this camera

[⇒ Contents list](#)

LCD Brightness

The brightness of the screen is automatically adjusted to the ambient lighting conditions using the light sensor. You can set the brightness of the screen manually.

1. MENU →  1 → [LCD Brightness] → desired mode

<input checked="" type="checkbox"/>	Auto	Adjusts the brightness automatically.
<input type="checkbox"/>	Manual	Allows you to adjust the brightness within the range of -2 to +2.
<input type="checkbox"/>	Sunny Weather	Automatically adjusts the brightness appropriately for shooting outdoors.

Notes

- When this is set to [Auto], do not cover the light sensor with your hand or anything else. [\[Details\]](#)

[▲ Back to top](#)

- ▶ Before Use
- ▶ Operating the camera
- ▶ Shooting
- ▶ Viewing
- ▶ Useful shooting functions
- ▶ Useful viewing functions
- ▶ Changing settings
- ▶ Viewing images on a TV
- ▶ Using with your computer
- ▶ Printing
- ▶ Troubleshooting
- ▶ Precautions / About this camera

[⇒ Contents list](#)

Viewfinder Bright.

When using an electronic viewfinder (sold separately), sets the brightness of the electronic viewfinder.

1. MENU →  1 → [Viewfinder Bright.] → desired mode

<input checked="" type="checkbox"/>	Auto	Adjusts the brightness automatically.
<input type="checkbox"/>	Manual	Allows you to adjust the brightness within the range of -1 to +1.

[▲ Back to top](#)

- ▶ Before Use
- ▶ Operating the camera
- ▶ Shooting
- ▶ Viewing
- ▶ Useful shooting functions
- ▶ Useful viewing functions
- ▶ Changing settings
- ▶ Viewing images on a TV
- ▶ Using with your computer
- ▶ Printing
- ▶ Troubleshooting
- ▶ Precautions / About this camera

[⇒ Contents list](#)

Power Save

Saves battery charge by having the camera automatically turn off sooner after a period of no operation.

1. MENU →  1 → [Power Save] → desired mode

	Max	[Power Saving Start Time] is set to [1 Min]. If the camera is not operated for a certain period of time, the screen goes dark.
<input checked="" type="checkbox"/>	Standard	The setting of [Power Saving Start Time] is effective.

[▲ Back to top](#)

[▶ Before Use](#)[▶ Operating the camera](#)[▶ Shooting](#)[▶ Viewing](#)[▶ Useful shooting functions](#)[▶ Useful viewing functions](#)[▶ Changing settings](#)[▶ Viewing images on a TV](#)[▶ Using with your computer](#)[▶ Printing](#)[▶ Troubleshooting](#)[▶ Precautions / About this camera](#)[⇒ Contents list](#)

Power Saving Start Time

Sets the length of time until the camera turns off automatically.

If you do not operate the camera for a certain period of time while the power is on using the battery pack, the camera turns off automatically to prevent wearing down the battery pack (Auto power-off function).

1. MENU →  1 → [Power Saving Start Time] → desired mode

<input type="checkbox"/>	30 Min	Turns off the camera after the time you set.
<input type="checkbox"/>	5 Min	
<input checked="" type="checkbox"/>	2 Min	
<input type="checkbox"/>	1 Min	

Notes

- The camera does not enter “Auto power-off function” under conditions such as during a slideshow, when recording movies or when the camera is connected to a computer.

[▲ Back to top](#)

[Top page](#) > [Changing settings](#) > [Setup menu](#) > [PAL/NTSC Selector \(only for 1080 50i-compatible models\)](#)

▶ Before Use
▶ Operating the camera
▶ Shooting
▶ Viewing
▶ Useful shooting functions
▶ Useful viewing functions
▶ Changing settings
▶ Viewing images on a TV
▶ Using with your computer
▶ Printing
▶ Troubleshooting
▶ Precautions / About this camera

[⇒ Contents list](#)

PAL/NTSC Selector (only for 1080 50i-compatible models)

Plays back movies recorded with the camera on a PAL/NTSC system TV.

1. MENU →  1 → [PAL/NTSC Selector] → desired mode

<input checked="" type="checkbox"/>	PAL	Plays back movies recorded with the camera on a PAL system TV.
<input type="checkbox"/>	NTSC	Plays back movies recorded with the camera on an NTSC system TV.

Notes

- This function is provided with 1080 50i-compatible devices only. It is not provided with 1080 60i-compatible devices. The 1080 50i-compatible devices have a "50i" mark on the bottom of the camera.
- If you insert a memory card that has previously been formatted with the PAL system, a message telling you that you must re-format the card appears. When you record using the NTSC system, re-format the memory card or use another memory card.
- When the NTSC mode is selected, the "Running on NTSC." message always appears on the start-up screen each time you turn the camera on.

[▲ Back to top](#)

- ▶ Before Use
- ▶ Operating the camera
- ▶ Shooting
- ▶ Viewing
- ▶ Useful shooting functions
- ▶ Useful viewing functions
- ▶ Changing settings
- ▶ Viewing images on a TV
- ▶ Using with your computer
- ▶ Printing
- ▶ Troubleshooting
- ▶ Precautions / About this camera

[→ Contents list](#)







Upload Settings

▼ Transferring image data using the Eye-Fi card

Sets whether to use the upload function of an Eye-Fi card (commercially available), when you use the Eye-Fi card with this camera.

[Upload Settings] is displayed only when the Eye-Fi card is inserted in the camera.

1. MENU →  2 → [Upload Settings] → desired mode

	On	<p>Uses the upload function. The Eye-Fi mode display icon on the screen will change depending on the communication mode of the Eye-Fi card.</p> <ul style="list-style-type: none"> : Eye-Fi card is in standby mode. There is no image to be sent. : Eye-Fi card is in upload standby mode. : Eye-Fi card is in connecting mode. : Eye-Fi card is uploading images. : An error has occurred.
	Off	Does not use the upload function.



Notes

- Eye-Fi cards are sold in only some countries/regions.
- For more information on the Eye-Fi card, contact the manufacturer or seller of Eye-Fi cards directly.
- Eye-Fi cards are permitted only in the countries and regions in which they were purchased. You may be held liable due to local restrictions.
- The Eye-Fi card has a wireless LAN function. Do not insert the Eye-Fi card where wireless LAN is prohibited, such as while aboard an airplane. If the Eye-Fi card is inserted, set [Upload Settings] to [Off]. When the uploading function of the Eye-Fi card is set to [Off],  OFF is displayed on the screen.

Transferring image data using the Eye-Fi card

1. Set the wireless LAN access point settings or the transferring direction settings of the Eye-Fi card. For details, refer to the operating instructions supplied with the Eye-Fi card.
2. After the settings are finished, insert the Eye-Fi card into the camera, and shoot the images. The recorded images are automatically transferred via wireless LAN to a PC, etc.

Notes

- When uploading image data, the Auto power-off function is not available.
- If the  (error) icon is displayed, eject and re-insert the Eye-Fi card, or turn the power of the camera off and on again. If the  (error) icon is still displayed, the Eye-Fi card may be corrupted. For details, contact Eye-Fi, Inc.
- Wireless LAN communication may be interrupted by other communication devices. If data reception is insufficient, move the camera closer to the access point.
- Some Eye-Fi cards have an “Endless Memory Mode.” This product does not support “Endless Memory Mode.” Make sure that Eye-Fi cards that you insert into this product have “Endless Memory Mode” turned off. For details on setting “Endless Memory Mode”, refer to the operating instructions supplied with the Eye-Fi card.

- ▶ Before Use
- ▶ Operating the camera
- ▶ Shooting
- ▶ Viewing
- ▶ Useful shooting functions
- ▶ Useful viewing functions
- ▶ Changing settings
- ▶ Viewing images on a TV
- ▶ Using with your computer
- ▶ Printing
- ▶ Troubleshooting
- ▶ Precautions / About this camera

[⇒ Contents list](#)

HDMI Resolution

When you connect the camera to a High Definition (HD) TV with HDMI terminals using an HDMI Cable (sold separately), you can select HDMI Resolution to output images to the TV.

1. MENU →  2 → [HDMI Resolution] → desired mode

<input checked="" type="checkbox"/>	Auto	The camera automatically recognizes an HD TV and sets the output resolution.
	1080p	Outputs signals in HD picture quality (1080p).
	1080i	Outputs signals in HD picture quality (1080i).

Notes

- If you cannot display the screen properly with the [Auto] setting, select either [1080p] or [1080i], depending on the TV to be connected.

[▲ Back to top](#)

- ▶ Before Use
- ▶ Operating the camera
- ▶ Shooting
- ▶ Viewing
- ▶ Useful shooting functions
- ▶ Useful viewing functions
- ▶ Changing settings
- ▶ Viewing images on a TV
- ▶ Using with your computer
- ▶ Printing
- ▶ Troubleshooting
- ▶ Precautions / About this camera

[⇒ Contents list](#)

CTRL FOR HDMI

This setting allows (TV) remote control of a camera that is connected to a “BRAVIA” Sync TV using the HDMI Cable (sold separately).

1. MENU →  2 → [CTRL FOR HDMI] → desired mode

<input checked="" type="checkbox"/>	On	Sets whether to operate the camera using a TV remote control.
<input type="checkbox"/>	Off	

Notes

- You can perform the operation of the camera with the remote controller of your TV by connecting your camera to a “BRAVIA” Sync-compatible TV.

Related Topic

[Viewing an image on a “BRAVIA” Sync-compatible TV](#)

[▲ Back to top](#)

- ▶ Before Use
- ▶ Operating the camera
- ▶ Shooting
- ▶ Viewing
- ▶ Useful shooting functions
- ▶ Useful viewing functions
- ▶ Changing settings
- ▶ Viewing images on a TV
- ▶ Using with your computer
- ▶ Printing
- ▶ Troubleshooting
- ▶ Precautions / About this camera

[➡ Contents list](#)

USB Connection

Sets how to make a USB connection when connecting the camera to a computer, etc.

1. MENU →  2 → [USB Connection] → desired mode

	Auto	Depending on the computer or other USB devices you connect to the camera, the connection mode is automatically selected from [MTP] or [Mass Storage]. When you use Windows 7 or Windows 8, [MTP] is selected and specific functions become available.
	Mass Storage	Establishes a Mass Storage connection between the camera and a computer or other USB device.
	MTP	Establishes an MTP connection between the camera and a computer or other USB device. When you use Windows 7 or Windows 8, [MTP] is selected and specific functions become available. When you use other operating systems (Vista/XP, Mac OS X), the AutoPlay Wizard appears, and the still images in the recording folder on the camera are imported to the computer.

Notes

- If Device Stage* does not appear when connecting the camera to a Windows 7 or Windows 8 computer, set [USB Connection] to [Auto].

* Device Stage is a menu screen for managing connected devices, such as a camera. (Function of Windows 7 or Windows 8)

[▲ Back to top](#)

- ▶ Before Use
- ▶ Operating the camera
- ▶ Shooting
- ▶ Viewing
- ▶ Useful shooting functions
- ▶ Useful viewing functions
- ▶ Changing settings
- ▶ Viewing images on a TV
- ▶ Using with your computer
- ▶ Printing
- ▶ Troubleshooting
- ▶ Precautions / About this camera

[⇒ Contents list](#)

USB LUN Setting

Limits the function of USB connection and improves compatibility.

1. MENU →  2 → [USB LUN Setting] → desired mode

<input checked="" type="checkbox"/>	Multi	Set to [Multi] under normal conditions.
<input type="checkbox"/>	Single	Set to [Single] if USB connection in [Multi] setting fails.

[▲ Back to top](#)

[▶ Before Use](#)[▶ Operating the camera](#)[▶ Shooting](#)[▶ Viewing](#)[▶ Useful shooting functions](#)[▶ Useful viewing functions](#)[▶ Changing settings](#)[▶ Viewing images on a TV](#)[▶ Using with your computer](#)[▶ Printing](#)[▶ Troubleshooting](#)[▶ Precautions / About this camera](#)[⇒ Contents list](#)

USB Power Supply

Sets whether to use [USB Power Supply] function when the camera is connected to a computer or USB device using the micro USB cable.

1. MENU →  2 → [USB Power Supply] → desired mode

<input checked="" type="checkbox"/>	On	Uses [USB Power Supply] function when a USB connection is established.
<input type="checkbox"/>	Off	Does not use [USB Power Supply] function when a USB connection is established.

[▲ Back to top](#)

[▶ Before Use](#)[▶ Operating the camera](#)[▶ Shooting](#)[▶ Viewing](#)[▶ Useful shooting functions](#)[▶ Useful viewing functions](#)[▶ Changing settings](#)[▶ Viewing images on a TV](#)[▶ Using with your computer](#)[▶ Printing](#)[▶ Troubleshooting](#)[▶ Precautions / About this camera](#)[⇒ Contents list](#)

Audio signals

Selects whether the camera produce or turn off the sound when you operate the camera.

1. MENU →  2 → [Audio signals] → desired mode

<input checked="" type="checkbox"/>	On	Turns on the beep/shutter sound when you press shutter button halfway down to focus or press the shutter button to shoot, etc.
<input type="checkbox"/>	Off	Turns off the beep/shutter sound.

[▲ Back to top](#)

- ▶ [Before Use](#)
- ▶ [Operating the camera](#)
- ▶ [Shooting](#)
- ▶ [Viewing](#)
- ▶ [Useful shooting functions](#)
- ▶ [Useful viewing functions](#)
- ▶ [Changing settings](#)
- ▶ [Viewing images on a TV](#)
- ▶ [Using with your computer](#)
- ▶ [Printing](#)
- ▶ [Troubleshooting](#)
- ▶ [Precautions / About this camera](#)

[⇒ Contents list](#)

WPS Push

If your access point has the WPS button, you can register the access point to the camera easily by pushing the WPS button.

1. MENU →  3 → [WPS Push] → ●
2. Press the WPS button on the access point you want to register.

Notes

- To use [WPS Push], the security of your access point has to be set to WPA2 or WPA, and support the WPS push button system. In other cases, such as where security is set to WEP or the WPS push button system is not supported, register the access point manually. [\[Details\]](#)
- For details on the functions and settings of your access point, refer to the instruction manual of the access point, or contact the person who is managing the access point.
- Connection may not be established or communication distance may be shorter depending on the surrounding environment, such as obstacles between the camera and the access point, wall materials, radio wave conditions, etc. In such cases, change the location of the camera or move the camera closer to the access point.

Related Topic

[Access Point Settings](#)

[▲ Back to top](#)

- ▶ Before Use
- ▶ Operating the camera
- ▶ Shooting
- ▶ Viewing
- ▶ Useful shooting functions
- ▶ Useful viewing functions
- ▶ Changing settings
- ▶ Viewing images on a TV
- ▶ Using with your computer
- ▶ Printing
- ▶ Troubleshooting
- ▶ Precautions / About this camera

[⇒ Contents list](#)

Access Point Settings

▼ How to use the keyboard

▼ Other setting items

You can register your access point manually.
 Before starting the procedure, check the SSID name of the access point, security system, and password. The password may be preset in some devices. For details, see the instruction manual of the wireless access point, or consult the network administrator.

1. MENU → 3 → [Access Point Settings] → ●
2. Select the access point you want to register.



When the desired access point is displayed on the screen:
 Select the desired access point.

When the desired access point is not displayed on the screen:
 Select [Manual Setting] and set the access point.

* For the input method, refer to “How to use the keyboard.”

- If you select [Manual Setting], input the SSID name of the access point → select the security system.

3. Input the password → [OK] → ●

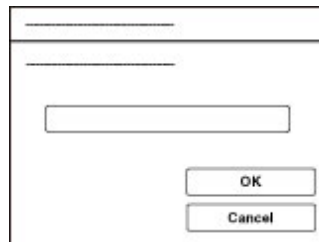

- Access points that do not display do not require a password to be entered.

4. Select [OK], then press ● .

How to use the keyboard

When manual character entry is required, a keyboard is displayed on the screen.
 Select the desired button using ▲ / ▼ / ◀ / ▶ , then press ● to enter the character.

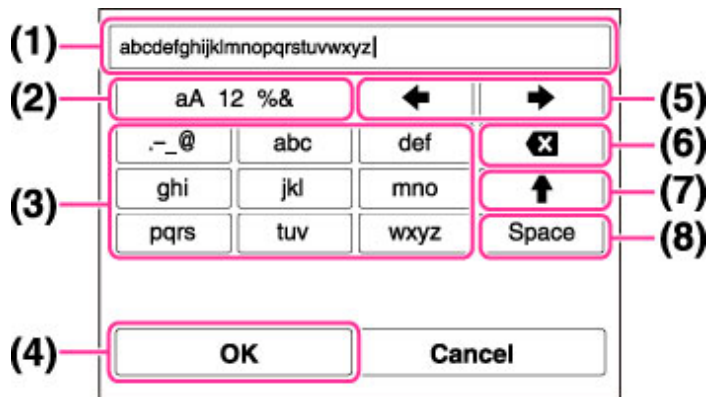

	Screen names	Functions
(1)	Input box	The characters you entered are displayed.
(2)	Switch character types	Each time you press ●, character types are switched among alphabet letters, numerals and symbols.
(3)	Keyboard	Each time you press ●, the character that you enter will be displayed. For example: If you want to enter "abd" Select the key for "abc" and press ● once to display "a" → select "→" to move the cursor (5) and press ● → select the key for "abc" and press ● twice to display "b" → select the key for "def" and press ● once to display "d"
(4)	Fix	Fixes the entry.
(5)	Move cursor	Moves the cursor in the input box to the right or left.
(6)	Delete	Deletes the character preceding the cursor.
(7)	↑	Switches the next character to a capital or small letter.
(8)	Space	Enters a space.

- To cancel entering characters midway, select [Cancel].

Other setting items

Depending on the status or the setting method of your access point, you may want to set more items.

Screen names	Functions
WPS PIN	Displays the PIN code to enter into the connected device.
IP Address Setting	Selects [Auto] or [Manual Setting].
IP Address	If you are entering the IP address manually, enter the set address.
Subnet Mask/ Default Gateway	When you set [IP Address Setting] to [Manual Setting], enter the IP address to match your network environment.
Priority Connection	Selects [On] or [Off] for [Priority Connection].

Notes

- To give the registered access point priority, set [Priority Connection] to [On].

[▶ Before Use](#)[▶ Operating the camera](#)[▶ Shooting](#)[▶ Viewing](#)[▶ Useful shooting functions](#)[▶ Useful viewing functions](#)[▶ Changing settings](#)[▶ Viewing images on a TV](#)[▶ Using with your computer](#)[▶ Printing](#)[▶ Troubleshooting](#)[▶ Precautions / About this camera](#)[⇒ Contents list](#)

Edit Device Name

You can change the device name under Wi-Fi Direct, etc.

1. MENU →  3 → [Edit Device Name] → ●
2. Select the input box, then input the device name → [OK] → ●
 - For input method, refer to “How to use the keyboard.” [\[Details\]](#)

Related Topic

[WPS Push](#)[Access Point Settings](#)[▲ Back to top](#)

[▶ Before Use](#)[▶ Operating the camera](#)[▶ Shooting](#)[▶ Viewing](#)[▶ Useful shooting functions](#)[▶ Useful viewing functions](#)[▶ Changing settings](#)[▶ Viewing images on a TV](#)[▶ Using with your computer](#)[▶ Printing](#)[▶ Troubleshooting](#)[▶ Precautions / About this camera](#)[⇒ Contents list](#)

Disp MAC Address

Displays the MAC address of the camera.

1. MENU →  3 → [Disp MAC Address] → ●

[▲ Back to top](#)

- ▶ [Before Use](#)
- ▶ [Operating the camera](#)
- ▶ [Shooting](#)
- ▶ [Viewing](#)
- ▶ [Useful shooting functions](#)
- ▶ [Useful viewing functions](#)
- ▶ [Changing settings](#)
- ▶ [Viewing images on a TV](#)
- ▶ [Using with your computer](#)
- ▶ [Printing](#)
- ▶ [Troubleshooting](#)
- ▶ [Precautions / About this camera](#)

[⇒ Contents list](#)

SSID/PW Reset

The camera shares the connection information for [Send to Smartphone] and [Ctrl with Smartphone] with a device that has permission to connect. If you want to change the device that is permitted to connect to the camera, reset the connection information by following these steps.

1. MENU →  3 → [SSID/PW Reset] → [OK] → ●

Notes

- After resetting the connection information, you must set a smartphone.

Related Topic

[Ctrl with Smartphone](#)[Send to Smartphone](#)[▲ Back to top](#)

[▶ Before Use](#)[▶ Operating the camera](#)[▶ Shooting](#)[▶ Viewing](#)[▶ Useful shooting functions](#)[▶ Useful viewing functions](#)[▶ Changing settings](#)[▶ Viewing images on a TV](#)[▶ Using with your computer](#)[▶ Printing](#)[▶ Troubleshooting](#)[▶ Precautions / About this camera](#)[⇒ Contents list](#)

Airplane Mode

When you board an airplane, etc., you can set whether to disable all the settings using functions related to Wi-Fi. If you set [Airplane Mode] to [On], an airplane mark will be displayed on the screen.

1. MENU →  4 → [Airplane Mode] → desired mode → ●

[▲ Back to top](#)

- ▶ [Before Use](#)
- ▶ [Operating the camera](#)
- ▶ [Shooting](#)
- ▶ [Viewing](#)
- ▶ [Useful shooting functions](#)
- ▶ [Useful viewing functions](#)
- ▶ [Changing settings](#)
- ▶ [Viewing images on a TV](#)
- ▶ [Using with your computer](#)
- ▶ [Printing](#)
- ▶ [Troubleshooting](#)
- ▶ [Precautions / About this camera](#)

[⇒ Contents list](#)

Version

Displays the software version installed on this camera.

1. MENU →  4 → [Version]

[▲ Back to top](#)

- ▶ [Before Use](#)
- ▶ [Operating the camera](#)
- ▶ [Shooting](#)
- ▶ [Viewing](#)
- ▶ [Useful shooting functions](#)
- ▶ [Useful viewing functions](#)
- ▶ [Changing settings](#)
- ▶ [Viewing images on a TV](#)
- ▶ [Using with your computer](#)
- ▶ [Printing](#)
- ▶ [Troubleshooting](#)
- ▶ [Precautions / About this camera](#)

[⇒ Contents list](#)

Language

Selects the language to be used in the menu items, warnings and messages.

1. MENU →  4 → [Language] → desired mode

[▲ Back to top](#)

- ▶ Before Use
- ▶ Operating the camera
- ▶ Shooting
- ▶ Viewing
- ▶ Useful shooting functions
- ▶ Useful viewing functions
- ▶ Changing settings
- ▶ Viewing images on a TV
- ▶ Using with your computer
- ▶ Printing
- ▶ Troubleshooting
- ▶ Precautions / About this camera

[⇒ Contents list](#)

Drop Sensor

Sets whether to use the protective function when you drop the camera.

1. MENU →  4 → [Drop Sensor] → desired mode

<input checked="" type="checkbox"/>	On	Sets whether to activate [Drop Sensor] function.
<input type="checkbox"/>	Off	

Notes

- [Drop Sensor] function may be activated even if you do not drop the camera, depending on how the camera is used.

[▲ Back to top](#)

- ▶ Before Use
- ▶ Operating the camera
- ▶ Shooting
- ▶ Viewing
- ▶ Useful shooting functions
- ▶ Useful viewing functions
- ▶ Changing settings
- ▶ Viewing images on a TV
- ▶ Using with your computer
- ▶ Printing
- ▶ Troubleshooting
- ▶ Precautions / About this camera

[⇒ Contents list](#)

Demo Mode

When you supply power to the camera using the AC-UD10 (sold separately) or AC-UD11 (sold separately) AC adaptor, you can set whether to use a demonstration of movie playback. When there is no need to view a demonstration, set to [Off].

1. MENU →  4 → [Demo Mode] → desired mode

On	Automatically starts the movie demonstration when no operation is performed for about one minute on the recording information display. Available for protected AVCHD movies. Protect the AVCHD movie with the oldest shooting date and time.
<input checked="" type="checkbox"/> Off	Does not perform a demonstration.

[▲ Back to top](#)

- ▶ Before Use
- ▶ Operating the camera
- ▶ Shooting
- ▶ Viewing
- ▶ Useful shooting functions
- ▶ Useful viewing functions
- ▶ Changing settings
- ▶ Viewing images on a TV
- ▶ Using with your computer
- ▶ Printing
- ▶ Troubleshooting
- ▶ Precautions / About this camera

[⇒ Contents list](#)

Initialize

Initializes the settings to the default setting.
Even if you execute this function, the images are retained.

1. MENU →  4 → [Initialize] → desired mode → [OK]

Reset Default	Resets all settings to default settings.
Rec mode reset	Resets only major shooting settings to the default values.
Custom reset	Resets only custom settings to the default values.
Reset Network Settings	Resets all network settings.

Notes

- Be sure not to remove the battery pack while initializing.

[▲ Back to top](#)

[Top page](#) > [Viewing images on a TV](#) > [Viewing an image on a High Definition \(HD\) TV](#) > [Viewing an image on an HD TV using the HDMI Cable \(sold separately\)](#)

- ▶ Before Use
- ▶ Operating the camera
- ▶ Shooting
- ▶ Viewing
- ▶ Useful shooting functions
- ▶ Useful viewing functions
- ▶ Changing settings
- ▶ Viewing images on a TV
- ▶ Using with your computer
- ▶ Printing
- ▶ Troubleshooting
- ▶ Precautions / About this camera

[➡ Contents list](#)

Viewing an image on an HD TV using the HDMI Cable (sold separately)

Connect the camera to an HD (High Definition) TV that has an HDMI jack using an HDMI Cable (sold separately).

1. Turn off both the camera and the TV.
2. Connect the HDMI connector of the camera (A) and the HDMI jack of the TV (B) using the HDMI Cable (sold separately) (C).

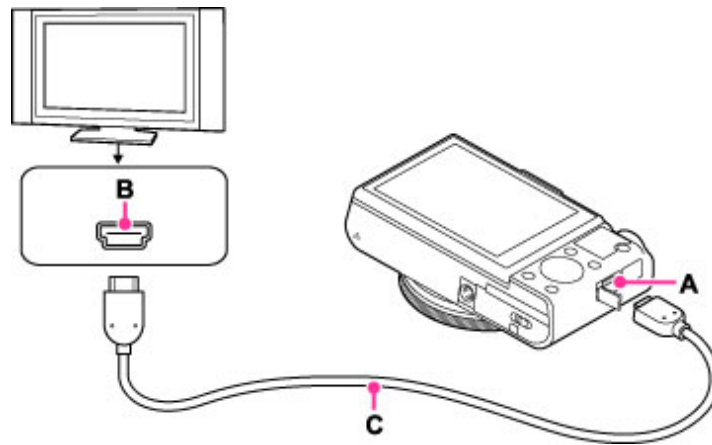

3. Turn on the TV and set the input.
4. Press the  (Playback) button to turn on the camera. Images shot with the camera appear on the TV. Select the desired image with the control wheel.

"PhotoTV HD"

This camera is compatible with the "PhotoTV HD" standard.

By connecting a Sony TV compatible with "PhotoTV HD" using an HDMI Cable (sold separately), a whole new world of photos can be comfortably enjoyed in breathtaking Full HD quality.

- "PhotoTV HD" allows for a highly-detailed, photo-like expression of subtle textures and colors.
- When the camera is connected to a Sony TV compatible with Video A mode using an HDMI Cable, your TV is automatically set to the picture quality suitable for still images. When the setting of the TV is set to Video, the picture quality is set to that suitable for movies.
- When playing back an AVCHD movie, it is recommended that you set [Still/Movie Select] to [AVCHD View].
- For details, see the operating instructions of the TV.

Notes

- Images shot in [VGA] image size cannot be played back in HD format.
- Do not connect the camera and equipment to be connected using both output terminals. When the camera and TV are connected using output terminals, no video or sound are produced. Such a connection can also cause problems with the camera and/or connected equipment.
- The camera may not work properly with some HD TVs. For example, you may not be able to view a video on your HD TV or hear sound from the HD TV.
- It is recommended that you use an authorized cable with HDMI logo or a Sony HDMI cable.
- Use an HDMI micro connector on one end (for the camera), and a connector suitable for connection

to your TV on the other end. You cannot view images on a TV that does not have an HDMI connector.

- Recording may automatically stop to protect the camera after a period of time if you are shooting movies when the camera and TV are connected by an HDMI Cable (sold separately).
- Open the HDMI cover all the way when inserting the HDMI Cable into the camera.
- Nothing is displayed on the camera screen.

[▲ Back to top](#)

Copyright 2013 Sony Corporation

- ▶ Before Use
- ▶ Operating the camera
- ▶ Shooting
- ▶ Viewing
- ▶ Useful shooting functions
- ▶ Useful viewing functions
- ▶ Changing settings
- ▶ Viewing images on a TV
- ▶ Using with your computer
- ▶ Printing
- ▶ Troubleshooting
- ▶ Precautions / About this camera

[➡ Contents list](#)



[Top page](#) > [Viewing images on a TV](#) > [Viewing an image on a "BRAVIA" Sync-compatible TV](#) > [Viewing an image on a "BRAVIA" Sync-compatible TV](#)

Viewing an image on a "BRAVIA" Sync-compatible TV

When you use a TV that has "BRAVIA" Sync (compatible with SYNC MENU) support, you can operate the playback functions of the camera using the remote control supplied with the TV by connecting the camera to the TV using an HDMI Cable (sold separately).

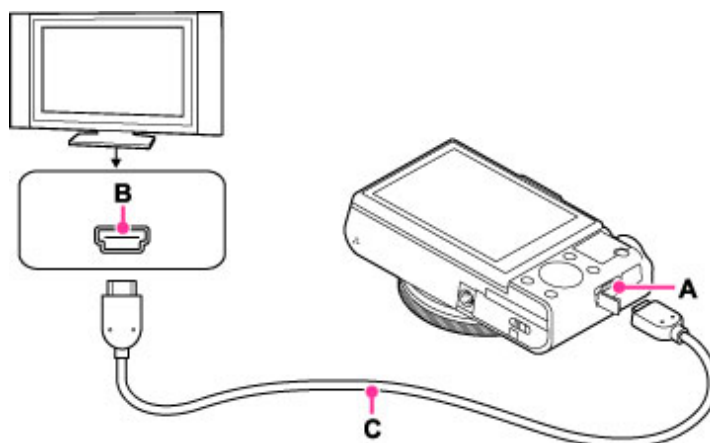
1. Connect the HDMI connector of the camera (A) and the HDMI jack of the TV (B) using the HDMI Cable (sold separately) (C).



2. Turn on the TV and set the input.
3. Press the  (playback) button of the camera to turn on the camera.
4. MENU →  2 → [CTRL FOR HDMI] → [On]
5. Press the SYNC MENU button of the TV's remote control to select the desired mode.

Notes

- When the camera is connected to a TV set using an HDMI Cable, the functions that you can operate are limited.
- You can perform the operation of the camera with the remote controller of your TV by connecting your camera to a "BRAVIA" Sync-compatible TV. For details, see the operating instructions of the TV.
- If the camera functions in an undesired manner when you are controlling it using the TV's remote controller, such as when connected via HDMI to another manufacturer's TV, press MENU →  2 → [CTRL FOR HDMI] → [Off].
- Open the HDMI cover all the way when inserting the HDMI Cable into the camera.
- Nothing is displayed on the screen of the camera.

[▲ Back to top](#)

[Top page](#) > [Using with your computer](#) > [Recommended computer environment](#) > [Recommended computer environment](#)

- ▶ Before Use
- ▶ Operating the camera
- ▶ Shooting
- ▶ Viewing
- ▶ Useful shooting functions
- ▶ Useful viewing functions
- ▶ Changing settings
- ▶ Viewing images on a TV
- ▶ Using with your computer
- ▶ Printing
- ▶ Troubleshooting
- ▶ Precautions / About this camera

[⇒ Contents list](#)

Recommended computer environment

The following computer environment is recommended when using the software “PlayMemories Home” (Windows), “Wireless Auto Import” (Windows/Mac) and “Image Data Converter” (Windows/Mac) and when importing images via a USB connection.

Windows

OS (pre-installed)		Microsoft Windows XP* ¹ SP3/Windows Vista* ² SP2/Windows 7 SP1/Windows 8
When using “PlayMemories Home”	CPU	Intel Pentium III 800 MHz or faster (For playing/editing the High Definition movies: Intel Core Duo 1.66 GHz or faster/Intel Core 2 Duo 1.66 GHz or faster (Intel Core 2 Duo 2.26 GHz or faster is required when processing AVC HD (FX/FH) movies and Intel Core 2 Duo 2.40 GHz or faster is required when processing AVC HD (PS) movies.))
	Memory	Windows XP: 512 MB or more (1 GB or more is recommended.) Windows Vista/Windows 7/ Windows 8: 1 GB or more
	Hard Disk (Disk space required for installation)	Approximately 500 MB
	Display	1,024 dots × 768 dots or more
When using “Image Data Converter”	CPU	Pentium 4 or faster
	Memory	1 GB or faster
	Display	1,024 dots × 768 dots or more

*¹ 64-bit editions and Starter (Edition) are not supported.

Windows Image Mastering API (IMAPI) Ver.2.0 or later is required to create a disc.

*² Starter (Edition) is not supported.

Mac

OS (pre-installed)	USB Connection: Mac OS X v10.3 to v10.8 Wireless Auto Import: Mac OS X v10.5 – v10.7 “Image Data Converter”: Mac OS X v10.5, v10.6 (Snow Leopard), v10.7 (Lion), v10.8 (Mountain Lion)
When using “Image Data Converter”	CPU: Intel processor (Intel Core Solo/Core Duo/Core 2 Duo etc.) Memory: 1 GB or more is recommended Display: 1,024 dots × 768 dots or more

Notes

- Operation is not assured in an environment based on an upgrade of the operating systems described above or in a multi-boot environment.

- If you connect two or more USB devices to a single computer at the same time, some devices, including the camera, may not operate, depending on the types of USB devices you are using.
- Connecting the camera using a USB interface that is compatible with Hi-Speed USB (USB 2.0) allows advanced transfer (high speed transfer), as the camera is compatible with Hi-Speed USB (USB 2.0).
- When your computer resumes activity from suspend or sleep mode, communication between the camera and your computer may not recover at the same time.

[▲ Back to top](#)

Copyright 2013 Sony Corporation

[Top page](#) > [Using with your computer](#) > [Using the software](#) > [“PlayMemories Home” \(Windows\)](#)

- ▶ Before Use
- ▶ Operating the camera
- ▶ Shooting
- ▶ Viewing
- ▶ Useful shooting functions
- ▶ Useful viewing functions
- ▶ Changing settings
- ▶ Viewing images on a TV
- ▶ Using with your computer
- ▶ Printing
- ▶ Troubleshooting
- ▶ Precautions / About this camera

[⇒ Contents list](#)

“PlayMemories Home” (Windows)

Below are examples of the functions available when you use “PlayMemories Home.”

- “PlayMemories Home” allows you to import images shot with the camera to a computer for display. Make a USB connection between the camera and your computer, and click [Import].
- You can display images stored on a computer by shooting date in a calendar display.
- You can save and print images with the date.
- You can edit still images, such as resizing (Resize) and cropping (Trimming).
- You can correct still images, and change the shooting date and time.
- Blu-ray discs, AVCHD discs and DVD-Video discs can be created from AVCHD movies imported to a computer.
- You can upload images to a network service. (An internet connection environment is required.)
- For other details, see [?](#) (PlayMemories Home Help Guide).

Notes

- Mac does not support “PlayMemories Home.” Use the application bundled with the Mac to play back images.

[▲ Back to top](#)

[Top page](#) > [Using with your computer](#) > [Using the software](#) > [Installing “PlayMemories Home” \(Windows\)](#)

- ▶ Before Use
- ▶ Operating the camera
- ▶ Shooting
- ▶ Viewing
- ▶ Useful shooting functions
- ▶ Useful viewing functions
- ▶ Changing settings
- ▶ Viewing images on a TV
- ▶ Using with your computer
- ▶ Printing
- ▶ Troubleshooting
- ▶ Precautions / About this camera

[→ Contents list](#)

Installing “PlayMemories Home” (Windows)

▼ Starting “PlayMemories Home” (Windows)

▼ Accessing to “PlayMemories Home Help Guide” (Windows)

1. Using the Internet browser on your computer, go to the following URL, then click [Install] → [Run].
www.sony.net/pm
 - If the software “PMB (Picture Motion Browser)” has already been installed on your computer, “PlayMemories Home” will overwrite it and will be installed. Although some “PlayMemories Home” functions differ from those of “PMB,” use “PlayMemories Home.”
2. Follow the instructions on the screen to complete the installation.
 - When the message to connect the camera to a computer is displayed, turn on the power and connect using the micro USB cable (supplied) (A).

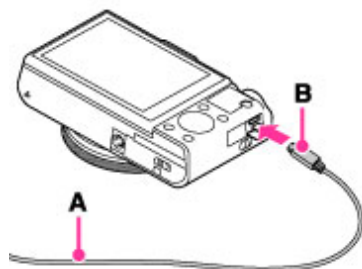

A: To a USB jack of the PC

B: To the Multi Terminal

- For details on “PlayMemories Home”, see [?](#) (PlayMemories Home Help Guide) or the following PlayMemories Home support page (English only):
<http://www.sony.co.jp/pmh-se/>

Notes

- Log on as Administrator.
- It may be necessary to restart your computer. When the restart confirmation message appears, restart the computer following the instructions on the screen.
- DirectX may be installed depending on your computer’s system environment.
- Mac does not support “PlayMemories Home.” Use the application bundled with the Mac to play back images.
- If “PlayMemories Home” has already been installed on your computer, connect the camera with the computer and register your camera with “PlayMemories Home.” The available functions are activated.

Starting “PlayMemories Home” (Windows)

1. Double-click (PlayMemories Home) on the desktop.
 - To start “PlayMemories Home” from the Start menu, select [Start] → [All Programs] → (PlayMemories Home).
 - For Windows 8, select the [PlayMemories Home] icon on the Start screen.

Accessing to “PlayMemories Home Help Guide” (Windows)

1. Double-click  (PlayMemories Home Help Guide) on the desktop.
 - To start “PlayMemories Home Help Guide” from the Start menu, select [Start] → [All Programs] → [PlayMemories Home] → [PlayMemories Home Help Guide].
 - Windows 8: select the [PlayMemories Home Help Guide] from [Help] in [PlayMemories Home].

[▲ Back to top](#)

Copyright 2013 Sony Corporation

- ▶ Before Use
- ▶ Operating the camera
- ▶ Shooting
- ▶ Viewing
- ▶ Useful shooting functions
- ▶ Useful viewing functions
- ▶ Changing settings
- ▶ Viewing images on a TV
- ▶ Using with your computer
- ▶ Printing
- ▶ Troubleshooting
- ▶ Precautions / About this camera

[⇒ Contents list](#)

Software for Mac

For details on software for Macs, access the following URL:

<http://www.sony.co.jp/imsoft/Mac/>

“Wireless Auto Import”

Before saving to a Mac computer, “Wireless Auto Import” must be installed. Download the software from the URL shown above and install it on your computer. For details, see the help in “Wireless Auto Import”.

Note

- The available software varies depending on the area.

Related Topic

[Send to Computer](#)

[▲ Back to top](#)

Copyright 2013 Sony Corporation

[Top page](#) > [Using with your computer](#) > [Using the software](#) > “Image Data Converter”

- ▶ Before Use
- ▶ Operating the camera
- ▶ Shooting
- ▶ Viewing
- ▶ Useful shooting functions
- ▶ Useful viewing functions
- ▶ Changing settings
- ▶ Viewing images on a TV
- ▶ Using with your computer
- ▶ Printing
- ▶ Troubleshooting
- ▶ Precautions / About this camera

[⇒ Contents list](#)

“Image Data Converter”

Below are examples of the functions available when you use “Image Data Converter.”

- You can edit RAW images using multiple correction functions, such as tone curve or sharpness.
- You can adjust images using white balance, aperture and Creative Style, etc.
- You can save displayed and edited still images to your computer.

There are two ways to save RAW images: save and leave as RAW data or save in a general-purpose file format.

- You can display and compare the RAW images/JPEG images that are shot with this camera.
- You can rank images in five levels.
- You can set the color label.

[▲ Back to top](#)

[Top page](#) > [Using with your computer](#) > [Using the software](#) > [Installing “Image Data Converter” \(Windows / Mac\)](#)

- ▶ Before Use
- ▶ Operating the camera
- ▶ Shooting
- ▶ Viewing
- ▶ Useful shooting functions
- ▶ Useful viewing functions
- ▶ Changing settings
- ▶ Viewing images on a TV
- ▶ **Using with your computer**
- ▶ Printing
- ▶ Troubleshooting
- ▶ Precautions / About this camera

[⇒ Contents list](#)

Installing “Image Data Converter” (Windows / Mac)

1. Download the software from the following URL and install it on your computer).
<http://www.sony.co.jp/ids-se/>

Notes

- Log on as Administrator.

Viewing “Image Data Converter Guide”

1. Windows:
Click [Start] → [All Programs] → [Image Data Converter] → [Help] → [Image Data Converter Ver.4]
For Windows 8, start “Image Data Converter Ver.4” → In the menu bar, choose “Help” → “Image Data Converter Guide.”

Mac:

Start Finder → [Applications] → [Image Data Converter] → [Image Data Converter Ver.4] → In the menu bar, choose “Help” → “Image Data Converter Guide.”

- For other details, see the “Image Data Converter” support page (English only).
<http://www.sony.co.jp/ids-se/>

[▲ Back to top](#)

[Top page](#) > [Using with your computer](#) > [Importing images to a computer](#) > [Connecting the camera to the computer](#)

- ▶ Before Use
- ▶ Operating the camera
- ▶ Shooting
- ▶ Viewing
- ▶ Useful shooting functions
- ▶ Useful viewing functions
- ▶ Changing settings
- ▶ Viewing images on a TV
- ▶ Using with your computer
- ▶ Printing
- ▶ Troubleshooting
- ▶ Precautions / About this camera

[⇒ Contents list](#)

Connecting the camera to the computer

1. Connect the camera to your computer using a micro USB cable (supplied) (A).

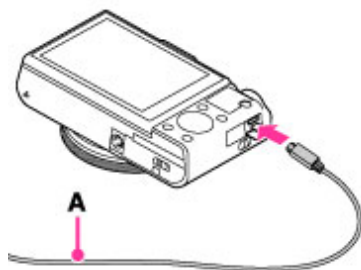

- When connecting the camera to a computer using the micro USB cable, power feeding from the computer starts if [USB Power Supply] is set to [On]. ([On] is the default setting.)

Related Topic

[USB Connection](#)

[USB LUN Setting](#)

[▲ Back to top](#)

[Top page](#) > [Using with your computer](#) > [Importing images to a computer](#) > [Importing images to a computer](#)

- ▶ Before Use
- ▶ Operating the camera
- ▶ Shooting
- ▶ Viewing
- ▶ Useful shooting functions
- ▶ Useful viewing functions
- ▶ Changing settings
- ▶ Viewing images on a TV
- ▶ Using with your computer
- ▶ Printing
- ▶ Troubleshooting
- ▶ Precautions / About this camera

[⇒ Contents list](#)

Importing images to a computer

“PlayMemories Home” allows you to easily import images.

For details on “PlayMemories Home” functions, see the “PlayMemories Home Help Guide”.

Importing images to a Windows computer without using “PlayMemories Home”

When the AutoPlay Wizard appears after making a USB connection between the camera and a computer, click [Open folder to view files] → [OK] → [DCIM] or [MP_ROOT] → copy the desired images to the computer.

- If the Device Stage screen appears with Windows 7 or Windows 8, double-click [Browse Files] → media icon → folder in which the image you want to import is stored.

Importing images to a Mac computer

Connect the camera to your Mac computer. Double-click the newly recognized icon on the desktop → the folder in which the image you want to import is stored. Then drag and drop the image file on to the hard disk icon.

Notes

- Use “PlayMemories Home” for operations such as when importing AVCHD movies to a computer (Windows).
- Use the “iMovie” software bundled with Mac for operations such as importing AVCHD movies to a computer (Mac). However, movies shot in 60p/50p mode cannot be imported.
- If operations are performed on an AVCHD movie file or folder on the camera from a PC while the camera is connected to a PC, it may destroy the image file or playback may become impossible. Do not delete or copy AVCHD movies on the camera’s memory card from a PC. Sony bears no responsibility for the result of operations of this type.

[▲ Back to top](#)

- ▶ Before Use
- ▶ Operating the camera
- ▶ Shooting
- ▶ Viewing
- ▶ Useful shooting functions
- ▶ Useful viewing functions
- ▶ Changing settings
- ▶ Viewing images on a TV
- ▶ Using with your computer
- ▶ Printing
- ▶ Troubleshooting
- ▶ Precautions / About this camera

[➡ Contents list](#)

[Top page](#) > [Using with your computer](#) > [Importing images to a computer](#) > [To disconnect your camera from the computer](#)



To disconnect your camera from the computer

Perform the procedures from step 1 to 2 below before:

- Disconnecting the cable.
- Removing a memory card.
- Turning off the camera.

1. Click the disconnect icon () on the tasktray.



- With Windows 7 or Windows 8, click  first, then click .

2. Click [Safely remove USB Mass Storage Device].

Notes

- Drag and drop the icon of the memory card or the drive icon to the “Trash” icon beforehand when you use a Mac computer, and the camera is disconnected from the computer.
- The disconnect icon may not appear when you use a Windows 7, Windows 8 computer. In this case, you can disconnect the camera from the computer without following the above steps.

[▲ Back to top](#)



- ▶ Before Use
- ▶ Operating the camera
- ▶ Shooting
- ▶ Viewing
- ▶ Useful shooting functions
- ▶ Useful viewing functions
- ▶ Changing settings
- ▶ Viewing images on a TV
- ▶ Using with your computer
- ▶ Printing
- ▶ Troubleshooting
- ▶ Precautions / About this camera

[⇒ Contents list](#)

Selecting a method for creating a disc of movies



- ▼ [Characteristics of each type of disc](#)
- ▼ [Creating a disc with a device other than a computer](#)
- ▼ [Creating Blu-ray discs](#)

You can create a disc from AVCHD movies that have been recorded with this camera. The devices that can play back movies vary depending on the type of disc. Select the type of disc suitable for your disc player. For details on the method for creating a disc using “PlayMemories Home”, see “PlayMemories Home Help Guide.” To import movies into a PC, see “Importing images to a computer” [\[Details\]](#).

Disc type/Purpose	Recordable movie quality			Player
	PS	FX	FH	
 For saving images in high-definition image quality (HD)	✓	✓	✓	Blu-ray disc playback devices (Sony Blu-ray disc player, PlayStation 3, etc.)
 For saving images in high-definition image quality (HD) (AVCHD disc)	—*	—*	✓	AVCHD format playback devices (Sony Blu-ray disc player, PlayStation 3, etc.)
 For saving images in standard definition image quality (STD)	—*	—*	—*	Ordinary DVD playback devices (DVD player, computer that can play DVDs, etc.)

* When creating discs using “PlayMemories Home,” you can record movies if you convert with a deterioration in image quality.

Characteristics of each type of disc

 High-definition image quality (HD)	Using a Blu-ray disc enables you to record high-definition image quality (HD) movies of a longer duration than DVD discs.
 High-definition image quality (HD) (AVCHD disc)	High-definition image quality (HD) movies can be recorded on DVD media, such as DVD-R discs, and a high-definition image quality (HD) disc is created. <ul style="list-style-type: none"> ● You can play a high-definition image quality (HD) disc on AVCHD format playback devices, such as a Sony Blu-ray disc player and a PlayStation 3. You cannot play the disc on ordinary DVD players.
	

Standard definition image quality (STD)	Standard definition image quality (STD) movies converted from high-definition image quality (HD) movies can be recorded on DVD media, such as DVD-R discs, and a standard definition image quality (STD) disc is created.
---	---

 Types of discs that can be used with “PlayMemories Home”

The following 12-cm discs can be used with “PlayMemories Home.” For information on Blu-ray discs, see “Creating Blu-ray discs.” [\[Details\]](#)





DVD-R / DVD+R / DVD+R DL: Cannot be re-written.

DVD-RW / DVD+RW: Can be re-written and used again.

- Always maintain your PlayStation 3 to use the latest version of the PlayStation 3 system software.
- The PlayStation 3 may not be available in some countries/regions.

Creating a disc with a device other than a computer

You can also create discs using a Blu-ray recorder, etc. Depending on which device you use, the types of disc that can be created vary.

Devices	Disc type	
 Creates a Blu-ray disc or a disc in standard definition image quality (STD) using a Blu-ray recorder.	 High-definition image quality (HD)	 Standard definition image quality (STD)
 Creates a disc in standard definition image quality (STD) using a device such as an HDD recorder.	 Standard definition image quality (STD)	

Notes

- When creating AVCHD discs using “PlayMemories Home” from movies recorded in [60p 28M(PS)]/[50p 28M(PS)], [60i 24M(FX)]/[50i 24M(FX)] or [24p 24M(FX)]/[25p 24M(FX)], the image quality is converted and it is not possible to create discs that have the original image quality. Converting image quality takes time. To record movies with the original image quality, use Blu-ray discs.
- To create a Blu-ray disc from movies recorded in [60p 28M(PS)]/[50p 28M(PS)], you need to use a device that is compliant with AVCHD format Ver. 2.0. The created Blu-ray disc can be played back only on a device that is compliant with AVCHD format Ver. 2.0.
- For details on how to create a disc, refer to the operating instructions of the device you use.

Creating Blu-ray discs

You can create Blu-ray discs from AVCHD movies imported to a PC.

The PC in question must be capable of creating Blu-ray discs. BD-R (not re-writable) or BD-RE (re-writable) discs can be used. Multi-session recordings cannot be made.

To create Blu-ray discs using “PlayMemories Home,” be sure to install the dedicated add-on software.

For details, see the following URL:

<http://support.d-imaging.sony.co.jp/BDUW/>

To install, your PC must be connected to the Internet.

For detailed operations, see “PlayMemories Home Help Guide.”

Notes

- To create a Blu-ray disc from movies recorded in [60p 28M(PS)]/[50p 28M(PS)], you need to use

- ▶ [Before Use](#)
- ▶ [Operating the camera](#)
- ▶ [Shooting](#)
- ▶ [Viewing](#)
- ▶ [Useful shooting functions](#)
- ▶ [Useful viewing functions](#)
- ▶ [Changing settings](#)
- ▶ [Viewing images on a TV](#)
- ▶ [Using with your computer](#)
- ▶ [Printing](#)
- ▶ [Troubleshooting](#)
- ▶ [Precautions / About this camera](#)

[⇒ Contents list](#)

Printing still images

You can print still images using the following methods.

- **Printing directly using a printer which supports your memory card type.**
For details, see the operating instructions supplied with the printer.
- **Printing using a computer**
You can import images to a computer using the “PlayMemories Home” software and print the images. You can print images with the date.
For details, see the “PlayMemories Home Help Guide”.
- **Printing at a shop**
You can take a memory card to a photo printing service shop. As long as the shop supports photo printing services conforming to DPOF, you can make a **DPOF** (Print order) mark on images in advance in playback mode so that you do not have to reselect them when you print them out at the shop. Before you take image data to a shop, always copy (back up) your data.

Notes

- When you print still images shot in [16:9] mode, both edges may be cut off.
- You cannot print panoramic images, depending on the printer.

[▲ Back to top](#)

[▶ Before Use](#)[▶ Operating the camera](#)[▶ Shooting](#)[▶ Viewing](#)[▶ Useful shooting functions](#)[▶ Useful viewing functions](#)[▶ Changing settings](#)[▶ Viewing images on a TV](#)[▶ Using with your computer](#)[▶ Printing](#)[▶ Troubleshooting](#)[▶ Precautions / About this camera](#)[⇒ Contents list](#)

If you have problems

If you experience trouble with the camera, try the following solutions.

1. Check the items under “Troubleshooting”, then check your camera.
 - If a code such as “C/E: □ □ : □ □ ” appears on the screen, see “Self-diagnosis display”.
 2. Remove the battery pack, wait for about one minute, re-insert the battery pack, then turn on the power.
 3. Initialize the settings. [\[Details\]](#)
 4. Consult your dealer or local authorized service facility.
- Additional information on this product and answers to frequently asked questions can be found at our Customer Support Website.
<http://www.sony.net/>

[▲ Back to top](#)

- ▶ Before Use
- ▶ Operating the camera
- ▶ Shooting
- ▶ Viewing
- ▶ Useful shooting functions
- ▶ Useful viewing functions
- ▶ Changing settings
- ▶ Viewing images on a TV
- ▶ Using with your computer
- ▶ Printing
- ▶ Troubleshooting
- ▶ Precautions / About this camera

[⇒ Contents list](#)

Battery pack and power

Cannot insert the battery pack into the camera.

- Make sure the direction of the battery pack is correct, and insert it until the battery eject lever is locked.

Cannot turn on the camera.

- After inserting the battery pack into the camera, it may take a few moments for the camera to power up.
- Make sure that the battery pack is inserted correctly.
- The battery pack will discharge by itself even if you do not use it. Charge the battery pack before use.
- Check that the battery pack type is NP-BX1.

The power turns off suddenly.

- Depending on the camera and battery temperature, the power may turn off automatically to protect the camera. In this case, a message is displayed on the screen before the power turns off.
- If you do not operate the camera for a certain period of time while the power is on, the camera turns off automatically to prevent wearing down the battery pack. Turn on the camera again.

The remaining charge indicator is incorrect.

- This is caused when you use the camera in an extremely hot or cold location.
- Battery capacity decreases over time and through repeated use. If decreased usage time between charges becomes significant, it is probably time to replace it with a new one.

The Power/Charge lamp of the camera flashes while charging the battery.

- Check that the battery pack type is NP-BX1.
- The Power/Charge lamp of the camera flashes infrequently when you use a battery pack that has not been used for a long time. In such cases, remove the battery pack from the camera and re-insert it.
- For details, see “Battery pack” [\[Details\]](#).

The battery is not charged even if the Power/Charge lamp turns off and charging is finished.

- This happens when you charge the battery pack in an extremely hot or cold location. Charge the battery pack within the proper charging temperature range of between 10°C to 30°C (50°F to 86°F).

The camera makes a noise when it is shaken.

- If the power is not on, the camera may make a noise when it is shaken. This is not a malfunction.

- ▶ Before Use
- ▶ Operating the camera
- ▶ Shooting
- ▶ Viewing
- ▶ Useful shooting functions
- ▶ Useful viewing functions
- ▶ Changing settings
- ▶ Viewing images on a TV
- ▶ Using with your computer
- ▶ Printing
- ▶ Troubleshooting
- ▶ Precautions / About this camera

[⇒ Contents list](#)

Shooting still images/movies

Cannot record images.

- Check the free capacity of the memory card. If it is full, do one of the following:
 - Delete unnecessary images. [\[Details\]](#) [\[Details\]](#)
 - Change the memory card.
- You cannot record images while charging the flash.
- When recording movies, it is recommended that you use the following memory cards:
 - “Memory Stick PRO Duo” (Mark2) media, “Memory Stick PRO-HG Duo” media, “Memory Stick XC-HG Duo” media or “Memory Stick Micro” (Mark2) media
 - SD memory card, SDHC memory card, SDXC memory card, microSD memory card, microSDHC memory card or microSDXC memory card (Class 4 or faster)

Smile Shutter function does not work.

- No image is shot if a smiling face is not detected. [\[Details\]](#)





Anti-blur function does not work.

- The anti-blur function may not work properly when shooting night scenes.
- Shoot after pressing the shutter button halfway down.

Recording takes a long time.

- The noise reduction function is turned on. This is not a malfunction. [\[Details\]](#) [\[Details\]](#)
- You are shooting in RAW mode. Since RAW data files are large, RAW mode shooting may take time.
- The Auto HDR is processing an image. [\[Details\]](#)
- The camera is overlaying images. [\[Details\]](#) [\[Details\]](#)











The image is out of focus.

- The subject is too close. When shooting, make sure to position the lens farther away from the subject than the shortest shooting distance (approximately 5 cm (0.16 ft) (W)/55 cm (1.8 ft) (T) from the lens).
-  (Sports Action),  (Landscape),  (Night Scene) or  (Fireworks) mode is selected in [Scene Selection] when shooting still images.

Zoom does not work.

- You cannot use the optical zoom when shooting in [Sweep Panorama] mode.
- You cannot use zoom functions other than optical zoom in the following situations:
 - When the Smile Shutter function is activated.
 - [Drive Mode] is set to [Self-portrait].
 - [Quality] is set to [RAW] or [RAW & JPEG].





The flash does not work.

- You cannot use the flash in the following situations:
 - [Drive Mode] is set to [Self-timer(Cont)] or [Bracket: Cont.]. [\[Details\]](#)
 -  (Anti Motion Blur),  (Night Scene),  (Hand-held Twilight),  (Fireworks) or  (High Sensitivity) mode is selected in [Scene Selection].
 - Shooting in [Sweep Panorama] mode
 - Shooting in movie mode
- Set the flash to [Fill-flash] when [Scene Selection] mode is set to  (Pet),  (Gourmet),  (Landscape),  (Sports Action) or  (Sunset) mode. [\[Details\]](#)

Fuzzy white circular spots appear in images shot using the flash.

- Particles (dust, pollen, etc.) in the air reflected the flash light and appeared in the image. This is not a malfunction. [\[Details\]](#)

The close-up shoot function (Macro) does not work.

- The camera automatically adjusts the focus. Press and hold the shutter button halfway down. Focus adjustment may take some time when shooting a close subject.
-  (Sports Action),  (Landscape),  (Night Scene) or  (Fireworks) mode is selected in [Scene Selection].

The date and time are not displayed on the screen.

- While shooting, the date and time are not displayed. They are displayed only during playback.

The F value and shutter speed flash.

- The exposure is incorrect. Correct [Exposure Comp.]. [\[Details\]](#)

The image colors are not correct.

- Adjust [White Balance]. [\[Details\]](#)
- [Picture Effect] is selected. [\[Details\]](#)
- Execute [Initialize] to reset settings to default. [\[Details\]](#)

The image is extremely bright or dark.

- Execute [Initialize] to reset settings to default. [\[Details\]](#)

Noise appears in the image when you view the screen in a dark place.

- The camera is attempting to increase the visibility of the screen by temporarily brightening the image under conditions of low illumination. There is no effect on the recorded image.

You can see a dark shadow on the image.

- Depending on the brightness of the subject, you may see a dark shadow when you change the aperture. This is not a malfunction.

The eyes of the subject come out red.

- Set [Red Eye Reduction] to [On]. [\[Details\]](#)
 - Shoot the subject at a distance closer than the flash range using the flash.
 - Light the room and shoot the subject.
-

Dots appear and remain on the screen.

- This is not a malfunction. These dots are not recorded.
-

Cannot shoot images in succession.

- The memory card is full. Delete unnecessary images. [\[Details\]](#) [\[Details\]](#)
 - The battery level is low. Insert a charged battery pack.
-

The same image is shot several times.

- Set [Drive Mode] to [Single Shooting]. [\[Details\]](#)

[▲ Back to top](#)

Copyright 2013 Sony Corporation

- ▶ Before Use
- ▶ Operating the camera
- ▶ Shooting
- ▶ Viewing
- ▶ Useful shooting functions
- ▶ Useful viewing functions
- ▶ Changing settings
- ▶ Viewing images on a TV
- ▶ Using with your computer
- ▶ Printing
- ▶ Troubleshooting
- ▶ Precautions / About this camera

[⇒ Contents list](#)

Viewing images

Cannot play back images.

- Make sure that the memory card is fully inserted into the camera.
- The folder/file name has been changed on your computer.
- No guarantees are made for playing back, on this camera, files containing images which were processed on a computer or images which were shot using other cameras.
- The camera is in USB mode. Disconnect the USB connection. [\[Details\]](#)
- Use “PlayMemories Home” to play images stored on a PC with this camera. To play back images on the Mac, use its bundled application.

The date and time are not displayed.

- The screen display is set to display images only. Press **DISP** (Display Contents) on the control wheel to display information. [\[Details\]](#)

The image does not appear on the TV.

- For viewing movies, the camera and television must use the same color television system. [\[Details\]](#)
- Check whether the connection is correct. [\[Details\]](#)

[▲ Back to top](#)

▶ Before Use
▶ Operating the camera
▶ Shooting
▶ Viewing
▶ Useful shooting functions
▶ Useful viewing functions
▶ Changing settings
▶ Viewing images on a TV
▶ Using with your computer
▶ Printing
▶ Troubleshooting
▶ Precautions / About this camera

[⇒ Contents list](#)

Wi-Fi

The wireless access point you want to connect to does not appear.

- Depending on the radio wave conditions, the wireless access point may not appear on the camera. Move the camera closer to the wireless access point.
- Depending on its setting, the wireless access point may not appear on the camera. Refer to the instruction manual for the wireless access point for the correct settings.

[WPS Push] does not work.

- Depending on the wireless access point setting, [WPS Push] may not be available. Confirm the password and SSID of the wireless access point to set [Access Point Settings]. [\[Details\]](#)

[Send to Computer] terminate prematurely.

- If the battery level is low, [Send to Computer] may terminate prematurely. Charge the battery pack before use.

Cannot transfer movies to the smartphone.

- Before shooting a movie to be transferred to a smartphone, set MENU →  1 → [File Format] → [MP4]. [\[Details\]](#)

[Send to Smartphone] terminate prematurely.

- If the battery level is low, [Send to Smartphone] may terminate prematurely. Charge the battery pack before use.

The shooting screen does not display smoothly, when the camera is disconnected from the computer.

- Depending on the radio wave conditions, communication between the smartphone and camera may not work correctly. Close the distance between the camera and smartphone.

Shooting with [Ctrl with Smartphone] terminate prematurely.

- If the battery level is low, shooting with [Ctrl with Smartphone] may terminate prematurely. Charge the battery pack before use.

Cannot use one-touch connection (NFC).

- Change the position of the camera and the smartphone to bring each  (N mark) as close as possible. If the NFC connection still does not start, shift the position of the smartphone a few millimeters, or move the smartphone away from the camera for at least 10 seconds, then touch it again.

- [Airplane Mode] is set to [On]. Set it to [Off].
- Check whether the smartphone is ready for connection.
For details, refer to the operating guide of the smartphone.
- Do not bring metal objects other than a smartphone close to  (N mark) of the camera.
- Do not have the camera touch more than one smartphone simultaneously.
- If another application using the NFC function is activated on the smartphone, close that application.

[▲ Back to top](#)

Copyright 2013 Sony Corporation

- ▶ Before Use
- ▶ Operating the camera
- ▶ Shooting
- ▶ Viewing
- ▶ Useful shooting functions
- ▶ Useful viewing functions
- ▶ Changing settings
- ▶ Viewing images on a TV
- ▶ Using with your computer
- ▶ Printing
- ▶ Troubleshooting
- ▶ Precautions / About this camera

[⇒ Contents list](#)

Computers

Your computer does not recognize the camera.

- Set [USB Connection] to [Mass Storage]. [\[Details\]](#)
- Use the micro USB cable (supplied).
- Disconnect the USB cable from both the computer and the camera, and connect it again firmly.
- Disconnect all equipment other than the camera, the keyboard and the mouse from the USB connectors of your computer.
- Connect the camera directly to your computer without passing through a USB hub or other device.
- Set [USB Power Supply] to [Off]. Your computer may recognize the camera.

Cannot import images.

- Connect the camera and your computer correctly making a USB connection. [\[Details\]](#)
- When you shoot images with a memory card formatted by a computer, you may not be able to import the images to a computer. Shoot using a memory card formatted by the camera. [\[Details\]](#)

After making a USB connection, "PlayMemories Home" does not start automatically.

- Make the USB connection after the computer is turned on.

Cannot play back images on your computer.

- If you are using "PlayMemories Home", refer to "PlayMemories Home Help Guide." [\[Details\]](#)
- Consult the computer or software manufacturer.

The image and sound are interrupted by noise when you view a movie on a computer.

- You are playing back the movie directly from the memory card. Import the movie to your computer using "PlayMemories Home" and play it back. [\[Details\]](#)

Images exported from a computer cannot be viewed on the camera.

- Use "PlayMemories Home" to copy images stored on a PC into this camera and view them on the camera. To play back images on the Mac, use its bundled application.

[▲ Back to top](#)

[▶ Before Use](#)[▶ Operating the camera](#)[▶ Shooting](#)[▶ Viewing](#)[▶ Useful shooting functions](#)[▶ Useful viewing functions](#)[▶ Changing settings](#)[▶ Viewing images on a TV](#)[▶ Using with your computer](#)[▶ Printing](#)[▶ Troubleshooting](#)[▶ Precautions / About this camera](#)[⇒ Contents list](#)

Memory card

Cannot insert a memory card.

- Insert the memory card in the correct direction.

You have formatted a memory card by mistake.

- All the data on the memory card is deleted by formatting. You cannot restore it.

[▲ Back to top](#)

- ▶ Before Use
- ▶ Operating the camera
- ▶ Shooting
- ▶ Viewing
- ▶ Useful shooting functions
- ▶ Useful viewing functions
- ▶ Changing settings
- ▶ Viewing images on a TV
- ▶ Using with your computer
- ▶ Printing
- ▶ Troubleshooting
- ▶ Precautions / About this camera

[⇒ Contents list](#)

Printing

Images are printed with both edges cut off.

- Depending on your printer, all the edges of the image may be cut off. Especially when you print an image shot with the image size set to [16:9], the lateral end of the image may be cut off.
- When printing images using your printer, cancel the trimming or borderless settings. Consult the printer manufacturer as to whether the printer provides these functions or not.
- When having images printed at a digital print shop, ask the shop whether they can print the images without cutting off both edges.

Cannot print images with the date.

- Select MENU →  5 → [Write Date] → [On] to insert a date on the image. Make sure that once the date is inserted, you cannot remove that date from the image.
- Using “PlayMemories Home”, you can insert the date on still images that have been recorded without a date. [\[Details\]](#)

[▲ Back to top](#)

- ▶ Before Use
- ▶ Operating the camera
- ▶ Shooting
- ▶ Viewing
- ▶ Useful shooting functions
- ▶ Useful viewing functions
- ▶ Changing settings
- ▶ Viewing images on a TV
- ▶ Using with your computer
- ▶ Printing
- ▶ Troubleshooting
- ▶ Precautions / About this camera

[⇒ Contents list](#)

Others

The lens gets fogged.

- Moisture condensation has occurred. Turn off the camera and leave it for about an hour before using it.

The camera stops with the lens portion extended.

- Do not attempt to force lens that has stopped moving.
- Insert a charged battery pack, then turn the camera on again.

The camera turns off with the lens portion extended.

- The battery pack is discharged. Replace it with a charged battery pack, then turn the camera on again.
- Do not attempt to force a lens that has stopped moving.

The camera becomes warm when you use it for a long time.

- This is not a malfunction.

The Clock Set screen appears when you turn on the camera.

- Set the date and time again. [\[Details\]](#)
- The internal rechargeable backup battery has discharged. Insert a charged battery, and set aside for 24 hours or more with the power left off.

The date or time is incorrect.

- [Area Setting] is set to a different location than your current location. Change the setting by MENU →  1 → [Area Setting].

[▲ Back to top](#)

- ▶ Before Use
- ▶ Operating the camera
- ▶ Shooting
- ▶ Viewing
- ▶ Useful shooting functions
- ▶ Useful viewing functions
- ▶ Changing settings
- ▶ Viewing images on a TV
- ▶ Using with your computer
- ▶ Printing
- ▶ Troubleshooting
- ▶ Precautions / About this camera

[⇒ Contents list](#)

Self-diagnosis display

If a code starting with a letter of the alphabet appears, the self-diagnosis function on the camera is working. The last two digits (indicated by) will differ depending on the state of the camera.

If you cannot solve the problem even after trying the following corrective actions a few times, the camera may need repair.

Contact your dealer or local authorized service facility.

C:32:

- There is trouble with the camera's hardware. Turn the power off and on again.
-

C:13:

- The camera cannot read or write data on the memory card. Try turning off and on the camera again, or taking out and inserting the memory card several times.
 - An unformatted memory card is inserted. Format the memory card. [\[Details\]](#)
 - The inserted memory card cannot be used with the camera, or the data is damaged. Insert a new memory card.
-

E:61:

E:62:

E:91:

- A camera malfunction has occurred. Initialize the camera, then turn the power on again. [\[Details\]](#)
-

E:94:

- There is a malfunction when writing or deleting data. Repair is required. Contact your dealer or local authorized service facility. Be prepared to give all numbers in the error code beginning from the E.

[▲ Back to top](#)

- ▶ Before Use
- ▶ Operating the camera
- ▶ Shooting
- ▶ Viewing
- ▶ Useful shooting functions
- ▶ Useful viewing functions
- ▶ Changing settings
- ▶ Viewing images on a TV
- ▶ Using with your computer
- ▶ Printing
- ▶ Troubleshooting
- ▶ Precautions / About this camera

[➔ Contents list](#)

Messages

If the following messages appear, follow the instructions.

Set Area/Date/Time.

- Set the area, date, and time. If you have not used the camera for a long time, charge the internal rechargeable battery. [\[Details\]](#)

Unable to use memory card. Format?

- The memory card was formatted on a computer and the file format was modified. Select [Enter], then format the memory card. You can use the memory card again; however, all previous data on the memory card will be erased. It may take some time to finish formatting. If the message appears again after formatting, use a different memory card.

Memory Card Error

- The inserted memory card cannot be used in the camera. [\[Details\]](#)
- Formatting failed. Format the memory card again. [\[Details\]](#)

Reinsert memory card.

- The inserted memory card cannot be used in the camera. [\[Details\]](#)
- The memory card is damaged.
- The terminal section of the memory card is dirty.

Memory card locked.

- You are using a memory card with a write-protect switch, and the switch is set to the LOCK position. Set the switch to the recording position.

Processing...

- When Long exposure noise reduction or High ISO noise reduction is underway, processing will occur for the same amount of time that the shutter was open. You cannot do any further shooting during this time.

Unable to display.

- Images recorded with other cameras or images modified using a computer may not be able to be displayed.

Unable to print.

- You tried to mark RAW images with a DPOF mark.

Internal temp. high. Allow it to cool.

- The camera has become hot because you have been shooting continuously. Turn the power off. Cool the camera and wait until the camera is ready to shoot again.



- Because you have been recording for a long time, the temperature inside the camera has increased to an unacceptable level. Stop recording.

Recording is unavailable in this movie format.

- Set [File Format] to [MP4].



- The number of images exceeds that for which date management in a database file by the camera is possible.



- Unable to register to the database file. Import all the images to a computer using “PlayMemories Home” and recover the memory card.

Camera Error. Turn power off then on.

System Error

- Remove the battery pack, then re-insert it. If the message appears frequently, consult your dealer or local authorized service facility.

Image Database File error. Recover?

- You cannot record or play back AVCHD movies because the Image Database File is damaged. Follow the on-screen instructions to recover data.

Unable to magnify.

Unable to rotate image.

- Images recorded using other cameras may not be magnified or rotated.

Cannot create more folders.

- A folder with a name beginning with “999” exists on the memory card. You cannot create any folders if this is the case.

[▲ Back to top](#)

- ▶ Before Use
- ▶ Operating the camera
- ▶ Shooting
- ▶ Viewing
- ▶ Useful shooting functions
- ▶ Useful viewing functions
- ▶ Changing settings
- ▶ Viewing images on a TV
- ▶ Using with your computer
- ▶ Printing
- ▶ Troubleshooting
- ▶ Precautions / About this camera

[⇒ Contents list](#)

[Top page](#) > [Troubleshooting](#) > [Situations this camera has difficulty handling](#) > [Situations this camera has difficulty handling](#)

Situations this camera has difficulty handling

The camera cannot take full advantage of some features under certain circumstances.

When shooting under the following conditions, either recompose the shot or change the shooting mode, then shoot the images again.

Low light conditions

- [Sweep Panorama](#)
- [Tracking focus](#)

Overly bright conditions

- [Tracking focus](#)

Varying levels of brightness

- [Tracking focus](#)

Flickering lights

- [Sweep Panorama](#)

Subjects too close to the camera

- [Sweep Panorama](#)

Large moving subjects or subjects that move too quickly

- [Superior Auto](#)
- [Tracking focus](#)
- [Sweep Panorama](#)
- [Auto HDR](#)

Subjects too small or too large

- [Tracking focus](#)
- [Sweep Panorama](#)

Scenes with little contrast, such as the sky or a sandy beach

- [Sweep Panorama](#)
- [Superior Auto](#)

Scenes changing constantly, such as a waterfall

- [Sweep Panorama](#)
- [Superior Auto](#)

[▲ Back to top](#)

- ▶ [Before Use](#)
- ▶ [Operating the camera](#)
- ▶ [Shooting](#)
- ▶ [Viewing](#)
- ▶ [Useful shooting functions](#)
- ▶ [Useful viewing functions](#)
- ▶ [Changing settings](#)
- ▶ [Viewing images on a TV](#)
- ▶ [Using with your computer](#)
- ▶ [Printing](#)
- ▶ [Troubleshooting](#)
- ▶ [Precautions / About this camera](#)

[⇒ Contents list](#)

Precautions

- ▼ [Memory card back up](#)
- ▼ [On database files](#)
- ▼ [Do not use/store the camera in the following places](#)
- ▼ [On carrying](#)
- ▼ [On operating temperatures](#)
- ▼ [On moisture condensation](#)
- ▼ [Functions built into this camera](#)
- ▼ [What is 1080 60p/50p?](#)
- ▼ [On image data compatibility](#)
- ▼ [Notes when playing movies on other devices](#)
- ▼ [Notes on the screen and lens](#)
- ▼ [Notes on the flash](#)

Memory card back up

Do not turn off the camera, remove the battery pack, or remove the memory card while the access lamp is lit. Otherwise, the memory card may be damaged. Be sure to make a backup copy to protect your data.

On database files

When you insert a memory card without a database file into the camera and turn on the power, part of the memory card capacity is used to automatically create a database file. It may take some time until you can perform the next operation. If a database file error occurs, import all the images to a computer using "PlayMemories Home", then format the memory card.

Do not use/store the camera in the following places

- In an extremely hot, cold or humid place
In places such as in a car parked in the sun, the camera body may become deformed and this may cause a malfunction.
- Storing under direct sunlight and near a heater
The camera body may become discolored or deformed, and this may cause a malfunction.
- In a location subject to rocking vibration
- Near strongly magnetic place
- In sandy or dusty places
Be careful not to let sand or dust get into the camera. This may cause the camera to malfunction, and in some cases this malfunction cannot be repaired.

On carrying

Do not sit down in a chair or other place with the camera in the back pocket of your trousers or skirt, as this may cause malfunction or damage the camera.

On operating temperatures

Your camera is designed for use under the temperatures between 0°C and 40°C (32°F and 104°F). Shooting in extremely cold or hot places that exceed this range is not recommended.

On moisture condensation

- If the camera is brought directly from a cold to a warm location, moisture may condense inside or outside the camera. This moisture condensation may cause a malfunction of the camera.
- If moisture condensation occurs, turn off the camera and wait about an hour for the moisture to evaporate. Note that if you attempt to shoot with moisture remaining inside the lens, you will be unable to record clear images.

Functions built into this camera

- This manual describes the functions of 1080 60i-compatible devices and 1080 50i-compatible devices.
- To check whether your camera is a 1080 60i-compatible device or 1080 50i-compatible device, look for the following marks on the bottom of the camera.
 - 1080 60i-compatible device: 60i
 - 1080 50i-compatible device: 50i
- While aboard an airplane, set [Airplane Mode] to [On].

What is 1080 60p/50p?

- Unlike standard recording modes up to now, which record in an interlacing method, this camera records using a progressive method. This increases the resolution, and provides a smoother, more realistic image.

On image data compatibility

- The camera conforms with DCF (Design rule for Camera File system) universal standards established by JEITA (Japan Electronics and Information Technology Industries Association).
- Sony does not guarantee that the camera will play back images recorded or edited with other equipment, or that other equipment will play back images recorded with the camera.

Notes when playing movies on other devices

- This camera uses MPEG-4 AVC/H.264 High Profile for AVCHD format recording. Movies recorded in AVCHD format with this camera cannot be played by the following devices.
 - Other devices compatible with an AVCHD format that does not support High Profile
 - Devices incompatible with the AVCHD formatThis camera also uses MPEG-4 AVC/H.264 Main Profile for MP4 format recording. For this reason, movies recorded in MP4 format with this camera cannot be played on devices other than those that support MPEG-4 AVC/H.264.
- You can play a high-definition image quality (HD) disc only on AVCHD format playback devices. A DVD player or DVD recorder cannot play back a disc recorded in high-definition image quality (HD) because they are not compatible with the AVCHD format. In addition, if you insert a high-definition image quality (HD) disc recorded in AVCHD format into a DVD player or DVD recorder, you may not be able to eject the disc.
- Movies recorded in 1080 60p/1080 50p format can be played back only on 1080 60p/1080 50p-supported devices.

Notes on the screen and lens

- The screen is manufactured using extremely high-precision technology so over 99.99% of the pixels are operational for effective use. However, some tiny black and/or bright dots (white, red, blue or green) may appear on the screen. These dots are a normal result of the manufacturing process and do not affect the recording.
- Exposing the screen or the lens to direct sunlight for long periods may cause malfunctions. Be careful when placing the camera near a window or outdoors.

- Do not press against the screen. The screen may be discolored and that may cause a malfunction.
- Images may trail across on the screen in a cold location. This is not a malfunction.
- Be careful not to bump the movable lens, and be careful not to apply force to it.

Notes on the flash

- When using the flash, the flash pops up automatically. If not using the flash, press it down manually.

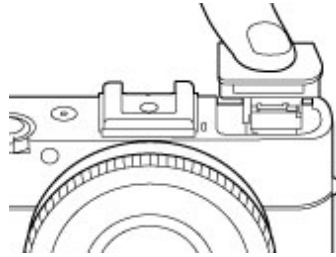

- Do not cover the flash with your fingers.
- Do not carry the camera by the flash unit, or use excessive strength on it.
- If water, dust or sand get into the open flash unit, it may cause a malfunction.

[▲ Back to top](#)

Copyright 2013 Sony Corporation

[Top page](#) > [Precautions / About this camera](#) > [Precautions](#) > [On the internal rechargeable backup battery](#)

- ▶ [Before Use](#)
- ▶ [Operating the camera](#)
- ▶ [Shooting](#)
- ▶ [Viewing](#)
- ▶ [Useful shooting functions](#)
- ▶ [Useful viewing functions](#)
- ▶ [Changing settings](#)
- ▶ [Viewing images on a TV](#)
- ▶ [Using with your computer](#)
- ▶ [Printing](#)
- ▶ [Troubleshooting](#)
- ▶ [Precautions / About this camera](#)

[⇒ Contents list](#)

On the internal rechargeable backup battery

This camera has an internal rechargeable battery for maintaining the date and time and other settings regardless of whether the power is on or off.

This rechargeable battery is continually charged as long as you are using the camera. However, if you use the camera for only short periods, it discharges gradually, and if you do not use the camera at all for about one month it becomes completely discharged. In this case, be sure to charge this rechargeable battery before using the camera.

However, even if this rechargeable battery is not charged, you can still use the camera, but the date and time will not be indicated.

Charging method of the internal rechargeable backup battery

Insert a charged battery pack in the camera, and then leave the camera for 24 hours or more with the power off.

[▲ Back to top](#)

- ▶ Before Use
- ▶ Operating the camera
- ▶ Shooting
- ▶ Viewing
- ▶ Useful shooting functions
- ▶ Useful viewing functions
- ▶ Changing settings
- ▶ Viewing images on a TV
- ▶ Using with your computer
- ▶ Printing
- ▶ Troubleshooting
- ▶ Precautions / About this camera

[→ Contents list](#)

Battery pack

- ▼ [On charging the battery pack](#)
- ▼ [Effective use of the battery pack](#)
- ▼ [Remaining battery charge](#)
- ▼ [How to store the battery pack](#)
- ▼ [On battery life](#)
- ▼ [Compatible battery pack](#)

On charging the battery pack

- Charge the battery pack (supplied) before using the camera for the first time.
- You can charge the battery pack even if it is not completely discharged. In addition, even if the battery pack is not fully charged, you can use the partially charged capacity of the battery pack as is.
- We recommend charging the battery pack in an ambient temperature of between 10°C to 30°C (50°F to 86°F). The battery pack may not be effectively charged in temperatures outside this range.

Effective use of the battery pack

- Battery performance decreases in low temperature surroundings. So in cold places, the operational time of the battery pack is shorter. We recommend the following to ensure longer battery pack use:
 - Put the battery pack in a pocket close to your body to warm it up, and insert it in the camera immediately before you start shooting.
 - (If there are any metal objects such as keys in your pocket, be aware of short-circuits.)
- The battery pack will run out quickly if you use the flash or zoom frequently.
- We recommend having spare battery packs handy for two times or three times the expected shooting time, and making trial shots before taking the actual shots.
- Do not expose the battery pack to water. The battery pack is not water-resistant.
- Do not leave the battery pack in extremely hot places, such as in a car or under direct sunlight.
- You may not be able to turn on the camera or the battery pack may not be effectively charged if the terminal section of the battery is dirty. In this case, wipe any dust off lightly using a soft cloth or a cotton swab to clean the battery.

Remaining battery charge

- A remaining charge indicator appears on the screen.



A: High

B: Low

- It takes about 1 minute until the correct remaining charge indicator appears.
- The remaining charge indicator may not be correct under certain circumstances.
- If you do not operate the camera for a certain period of time while the power is on, the camera turns off automatically. (Auto power-off function)
- If the battery remaining charge is not displayed, press DISP (Display Contents) on the control wheel. [\[Details\]](#)

How to store the battery pack

- Fully discharge the battery pack before storing and store the camera in a cool, dry place. To maintain the battery pack's function, charge the battery pack and then fully discharge it in the camera at least once a year while storing.
- To use the battery pack up, leave the camera in slideshow playback mode until the power goes off.
- To prevent staining the terminal, short-circuiting, etc., be sure to use a plastic bag, etc. to keep away from metal materials when carrying or storing.

On battery life

- The battery life is limited. Battery capacity decreases over time and through repeated use. If the available time of the battery is shortened significantly, it is probably time to replace it with a new one.
- The battery life varies according to how it is stored and the operating conditions and environment in which each battery pack is used.

Compatible battery pack

- The NP-BX1 (supplied) can be used only in X type compatible Cyber-shot models.

[▲ Back to top](#)

Copyright 2013 Sony Corporation

▶ Before Use
▶ Operating the camera
▶ Shooting
▶ Viewing
▶ Useful shooting functions
▶ Useful viewing functions
▶ Changing settings
▶ Viewing images on a TV
▶ Using with your computer
▶ Printing
▶ Troubleshooting
▶ Precautions / About this camera

[⇒ Contents list](#)

Charging the battery pack

- The supplied AC Adaptor is dedicated to this camera. Do not connect with other electronic devices. Doing so may cause a malfunction. Also, make sure to use a genuine Sony AC Adaptor.
- If the Power/Charge lamp of the camera flashes during charging, remove the battery pack being charged, and then insert the same battery pack into the camera securely again. If the Power/Charge lamp flashes again, this may indicate a battery error or that a battery pack other than the specified type has been inserted. Check that the battery pack is the specified type. If the battery pack is the specified type, remove the battery pack, replace it with a new or different one and check that the battery is charged correctly. If the battery is charged correctly, a battery error may have occurred.
- If the Power/Charge lamp flashes even if the AC Adaptor is connected to the camera and the wall outlet (wall socket), this indicates that charging has stopped temporarily and is on standby. Charging stops and enters standby status automatically when the temperature is outside of the recommended operating temperature. When the temperature returns to the appropriate range, charging resumes and the Power/Charge lamp lights up again. We recommend charging the battery pack in an ambient temperature of between 10°C to 30°C (50°F to 86°F).
- Power is not supplied during shooting/playback if the camera is connected to a wall outlet with the supplied AC adaptor. To supply power to the camera during shooting/playback, use the AC-UD10 (sold separately) or AC-UD11* (sold separately) AC adaptor.

* The AC Adaptor AC-UD11 (sold separately) may not be available in some countries/regions.

[▲ Back to top](#)

- ▶ Before Use
- ▶ Operating the camera
- ▶ Shooting
- ▶ Viewing
- ▶ Useful shooting functions
- ▶ Useful viewing functions
- ▶ Changing settings
- ▶ Viewing images on a TV
- ▶ Using with your computer
- ▶ Printing
- ▶ Troubleshooting
- ▶ [Precautions / About this camera](#)

[⇒ Contents list](#)

Memory card

- ▼ [Memory card](#)
- ▼ [Note on using the memory card adaptor \(sold separately\)](#)
- ▼ [“Memory Stick” media](#)
- ▼ [When using “Memory Stick XC Duo” media or “Memory Stick PRO Duo” media with standard sized “Memory Stick” media slot](#)
- ▼ [Notes on using “Memory Stick Micro” media \(sold separately\)](#)

Memory card

Memory card	Representation in User Guide
Memory Stick XC-HG Duo	“Memory Stick XC Duo” media
Memory Stick PRO Duo	“Memory Stick PRO Duo” media
Memory Stick PRO-HG Duo	
Memory Stick Micro (M2)	“Memory Stick Micro” media
Memory Stick Micro (Mark2)	
SD memory card	SD card
SDHC memory card	
SDXC memory card	
microSD memory card	microSD memory card
microSDHC memory card	
microSDXC memory card	

- “Memory Stick XC Duo” media, “Memory Stick PRO Duo” media and SD cards of up to 64 GB have been tested and proven to operate with your camera.
- “Memory Stick Micro” media of up to 16 GB and microSD memory cards of up to 64 GB have been tested and proven to operate with your camera.
- When recording movies, it is recommended that you use the following memory cards:
 - **MEMORY STICK PRO DUO** (Mark2) (“Memory Stick PRO Duo” (Mark2) media)
 - **MEMORY STICK XC-HG DUO** (“Memory Stick XC-HG Duo” media)
 - **MEMORY STICK PRO-HG DUO** (“Memory Stick PRO-HG Duo” media)
 - **MEMORY STICK MICRO** (Mark2) (“Memory Stick Micro” (Mark2) media)
 - SD card (Class 4 or faster), microSD memory card (Class 4 or faster)

Notes

- To ensure stable operation of the memory card, we recommend that you use this camera to format any memory card being used with this camera for the first time. Note that formatting will erase all data recorded on the memory card. This data cannot be restored. Be sure to back up any important data to a PC or other storage location.
- If you repeatedly record/delete images over a long period of time, fragmentation of data may occur on the memory card and movies may not be recorded properly. In such a case, save your images to a PC or other storage location, then [Format].
- A memory card formatted with a computer is not guaranteed to operate with the camera.

- Data read/write speeds differ depending on the combination of the memory card and the equipment used.
- Data may be corrupted in the following cases:
 - When the memory card is removed or the camera is turned off during a read or write operations
 - When the memory card is used in locations subject to static electricity or electrical noise
- We recommend backing up important data.
- Do not attach a label on the memory card itself nor on a memory card adaptor.
- Do not touch the terminal section of the memory card with your hand or a metal object.
- Do not strike, bend or drop the memory card.
- Do not disassemble or modify the memory card.
- Do not expose the memory card to water.
- Do not leave the memory card within the reach of small children. They might accidentally swallow it.
- Insert a memory card that fits the memory card slot size. Otherwise, it will cause a malfunction.
- Do not use or store the memory card under the following conditions:
 - High temperature locations such as the hot interior of a car parked in direct sunlight
 - Locations exposed to direct sunlight
 - Humid locations or locations with corrosive substances present
- Images recorded in “Memory Stick XC-HG Duo” media, SDXC memory cards, or micro SDXC memory cards cannot be transferred or played back on computers or AV devices that are not exFAT-compatible, even when the camera is connected to the computer or AV device using a USB cable. Before connecting, make sure that the device is exFAT-compatible. If connected to a device that is not exFAT-compatible, a format drive request may appear. Do not format the drive, or all data will be lost. (exFAT is the file system used by “Memory Stick XC-HG Duo” media, SDXC memory cards and micro SDXC memory cards.)

Note on using the memory card adaptor (sold separately)

- When inserting a memory card into a memory card adaptor, make sure the memory card is inserted facing in the correct direction, then insert it all the way in. Incorrect insertion may result in a malfunction.
- When using “Memory Stick Micro” media or a microSD memory card, be sure to insert into the dedicated memory card adaptor.

“Memory Stick” media

The types of “Memory Stick” media that can be used with the camera are listed in the table below. However, proper operation cannot be guaranteed for all “Memory Stick” media functions.

“Memory Stick” media type	Recording/Playback
Memory Stick PRO Duo	○ *1
Memory Stick PRO-HG Duo	○ *1*2
Memory Stick XC-HG Duo	○ *1*2
Memory Stick Micro (M2)	○ *1*3
Memory Stick Micro (Mark2)	○ *1

*1 That are equipped with MagicGate functions. MagicGate is copyright protection technology that uses encryption technology. Data recording/playback that requires MagicGate functions cannot be performed with the camera.

*2 This camera does not support 8-bit parallel data transfer. It performs the same 4-bit parallel data transfer as the “Memory Stick PRO Duo” media.

*3 Movies recorded in AVCHD format, [1440×1080 12M] size movies cannot be recorded to “Memory Stick Micro” media (“M2”).

When using “Memory Stick XC Duo” media or “Memory Stick PRO Duo”

media with standard sized “Memory Stick” media slot

You can use the “Memory Stick Duo” media by inserting it into the “Memory Stick Duo” media Adaptor (sold separately).



“Memory Stick Duo” media Adaptor

Notes on using “Memory Stick Micro” media (sold separately)

- This product is compatible with “Memory Stick Micro” media (“M2”). “M2” is an abbreviation for “Memory Stick Micro” media.
- To use a “Memory Stick Micro” media with the camera, be sure to insert the “Memory Stick Micro” media into an “M2” Adaptor as large as of Duo size. If you insert a “Memory Stick Micro” media into the camera without an “M2” Adaptor as large as of Duo size, you might not be able to remove it from the camera.
- Do not leave the “Memory Stick Micro” media within the reach of small children. They might accidentally swallow it.

[▲ Back to top](#)

Copyright 2013 Sony Corporation

- ▶ [Before Use](#)
- ▶ [Operating the camera](#)
- ▶ [Shooting](#)
- ▶ [Viewing](#)
- ▶ [Useful shooting functions](#)
- ▶ [Useful viewing functions](#)
- ▶ [Changing settings](#)
- ▶ [Viewing images on a TV](#)
- ▶ [Using with your computer](#)
- ▶ [Printing](#)
- ▶ [Troubleshooting](#)
- ▶ [Precautions / About this camera](#)

[⇒ Contents list](#)

On cleaning

Cleaning the lens and flash

Wipe the lens and flash with a soft cloth to remove fingerprints, dust, etc.

Cleaning the flash

Clean the flash surface before use. The heat of the flash emission may cause dirt on the flash surface to start smoking or burning. Wipe the flash surface with a soft cloth to remove dirt or dust, etc.

Cleaning the camera surface

Clean the camera surface with a soft cloth slightly moistened with water, then wipe the surface with a dry cloth. To prevent damage to the finish or casing:

- Do not expose the camera to chemical products such as thinner, benzine, alcohol, disposable cloths, insect repellent, sunscreen or insecticide.
- Do not touch the camera with any of the above on your hand.
- Do not leave the camera in contact with rubber or vinyl for a long time.

[▲ Back to top](#)

[Top page](#) > [Precautions / About this camera](#) > [Number of still images and recordable time of movies](#) > [Number of still images](#)

- ▶ Before Use
- ▶ Operating the camera
- ▶ Shooting
- ▶ Viewing
- ▶ Useful shooting functions
- ▶ Useful viewing functions
- ▶ Changing settings
- ▶ Viewing images on a TV
- ▶ Using with your computer
- ▶ Printing
- ▶ Troubleshooting
- ▶ Precautions / About this camera

[⇒ Contents list](#)

Number of still images

The number of still images may vary depending on the shooting conditions and the memory card.

[Image Size] : [L: 20M]

When [Aspect Ratio] is set to [3:2]*

(Units: Images)

Quality	Memory card formatted with this camera					
	2 GB	4 GB	8 GB	16 GB	32 GB	64 GB
Standard	295	590	1200	2400	4800	9600
Fine	170	345	690	1350	2800	5500
RAW & JPEG	58	115	235	470	950	1900
RAW	88	175	355	710	1400	2850

* When the [Aspect Ratio] is set to other than [3:2], you can record more pictures than shown above. (Except when [Quality] is set to [RAW].)

Notes

- Even if the number of remaining shootable images is greater than 9,999, the “9999” indicator appears.
- When an image shot with other cameras is played back on this camera, the image may not appear in the actual image size.

[▲ Back to top](#)

[Top page](#) > [Precautions / About this camera](#) > [Number of still images and recordable time of movies](#) > [Recordable time of movies](#)

▶ Before Use

▶ Operating the camera

▶ Shooting

▶ Viewing

▶ Useful shooting functions

▶ Useful viewing functions

▶ Changing settings

▶ Viewing images on a TV

▶ Using with your computer

▶ Printing

▶ Troubleshooting

▶ **Precautions / About this camera**

[⇒ Contents list](#)

Recordable time of movies

The table below shows the approximate maximum recording times. These are the total times for all movie files. The recordable time may vary depending on the shooting conditions and the memory card. (h (hour), m (minute))

Record Setting	Memory card formatted with this camera					
	2 GB	4 GB	8 GB	16 GB	32 GB	64 GB
60i 24M(FX) 50i 24M(FX)	10 m	20 m	40 m	1 h 30 m	3 h	6 h
60i 17M(FH) 50i 17M(FH)	10 m	30 m	1 h	2 h	4 h 5 m	8 h 15 m
60p 28M(PS) 50p 28M(PS)	9 m	15 m	35 m	1 h 15 m	2 h 30 m	5 h 5 m
24p 24M(FX) 25p 24M(FX)	10 m	20 m	40 m	1 h 30 m	3 h	6 h
24p 17M(FH) 25p 17M(FH)	10 m	30 m	1 h	2 h	4 h 5 m	8 h 15 m
1440×1080 12M	15 m	40 m	1 h 20 m	2 h 45 m	5 h 30 m	11 h 5 m
VGA 3M	1 h 10 m	2 h 25 m	4 h 55 m	9 h 55 m	20 h	40 h 10 m

Continuous shooting is possible for approximately 29 minutes (a product specification limit). The maximum continuous recording time of an MP4 (12M) format movie is about 15 minutes (limited by the 2 GB file size restriction).

Notes

- The recordable time of movies varies because the camera is equipped with VBR (Variable Bit Rate), which automatically adjusts image quality depending on the shooting scene. When you record a fast-moving subject, the image is clearer but the recordable time is shorter because more memory is required for recording. The recordable time also varies depending on the shooting conditions, the subject or the image quality/size settings.

[▲ Back to top](#)

[Top page](#) > [Precautions / About this camera](#) > [Using the camera abroad](#) > [Using the camera abroad](#)

▶ Before Use

▶ Operating the camera

▶ Shooting

▶ Viewing

▶ Useful shooting functions

▶ Useful viewing functions

▶ Changing settings

▶ Viewing images on a TV

▶ Using with your computer

▶ Printing

▶ Troubleshooting

▶ Precautions / About this camera

[⇒ Contents list](#)

Using the camera abroad

You can use the AC Adaptor (supplied) in any country or region where the power supply is within 100 V to 240 V AC, 50 Hz/60 Hz.

Notes

- An electronic voltage transformer is unnecessary and its use may cause a malfunction.

[▲ Back to top](#)

[Top page](#) > [Precautions / About this camera](#) > [Using the camera abroad](#) > [On TV color systems](#)

- ▶ Before Use
- ▶ Operating the camera
- ▶ Shooting
- ▶ Viewing
- ▶ Useful shooting functions
- ▶ Useful viewing functions
- ▶ Changing settings
- ▶ Viewing images on a TV
- ▶ Using with your computer
- ▶ Printing
- ▶ Troubleshooting
- ▶ Precautions / About this camera

[⇒ Contents list](#)

On TV color systems

To view movies shot using this camera on a television, the camera and television must use the same color television system. Check the color TV system for the country or region where you are using the camera.

NTSC system

Bahama Islands, Bolivia, Canada, Central America, Chile, Colombia, Ecuador, Jamaica, Japan, Korea, Mexico, Peru, Surinam, Taiwan, the Philippines, the U.S.A., Venezuela, etc.

PAL system

Australia, Austria, Belgium, China, Croatia, Czech Republic, Denmark, Finland, Germany, Holland, Hong Kong, Hungary, Indonesia, Italy, Kuwait, Malaysia, New Zealand, Norway, Poland, Portugal, Romania, Singapore, Slovak Republic, Spain, Sweden, Switzerland, Thailand, Turkey, United Kingdom, Viet Nam, etc.

PAL-M system

Brazil

PAL-N system

Argentina, Paraguay, Uruguay

SECAM system

Bulgaria, France, Greece, Guiana, Iran, Iraq, Monaco, Russia, Ukraine, etc.

[▲ Back to top](#)

[Top page](#) > [Precautions / About this camera](#) > [About this camera](#) > [Carl Zeiss lens](#)

- ▶ [Before Use](#)
- ▶ [Operating the camera](#)
- ▶ [Shooting](#)
- ▶ [Viewing](#)
- ▶ [Useful shooting functions](#)
- ▶ [Useful viewing functions](#)
- ▶ [Changing settings](#)
- ▶ [Viewing images on a TV](#)
- ▶ [Using with your computer](#)
- ▶ [Printing](#)
- ▶ [Troubleshooting](#)
- ▶ [Precautions / About this camera](#)

[⇒ Contents list](#)

Carl Zeiss lens

The camera is equipped with a Carl Zeiss lens which is capable of reproducing sharp images with excellent contrast. The lens for the camera has been produced under a quality assurance system certified by Carl Zeiss in accordance with the quality standards of Carl Zeiss in Germany.

[▲ Back to top](#)

- ▶ Before Use
- ▶ Operating the camera
- ▶ Shooting
- ▶ Viewing
- ▶ Useful shooting functions
- ▶ Useful viewing functions
- ▶ Changing settings
- ▶ Viewing images on a TV
- ▶ Using with your computer
- ▶ Printing
- ▶ Troubleshooting
- ▶ Precautions / About this camera

[⇒ Contents list](#)

AVCHD format

The AVCHD format has been developed for high-definition digital video cameras when recording an HD (High-Definition) signal at the 1080i*¹ or 720p*² specification using high-efficiency compression coding technology. The MPEG-4 AVC/H.264 format is adopted to compress video data, and the Dolby Digital or Linear PCM system is used to compress audio data.

The MPEG-4 AVC/H.264 format is capable of compressing images at higher efficiency than that of the conventional image compressing format. The MPEG-4 AVC/H.264 format enables a high definition video signal shot on a digital video camera recorder to be recorded on 8 cm DVD discs, hard disk drive, flash memory, memory card, etc.

Recording and playback on the camera

Based on the AVCHD format, your camera records with the high definition image quality (HD) mentioned below.

Video signal*³:

1080 60i-compatible device

MPEG-4 AVC/H.264 1920×1080/60i, 1920×1080/60p, 1920×1080/24p, 1440×1080/60i

1080 50i-compatible device

MPEG-4 AVC/H.264 1920×1080/50i, 1920×1080/50p, 1920×1080/25p, 1440×1080/50i

Audio signal: Dolby Digital 2ch

Recording media: Memory card

*1 1080i specification

A high definition specification which utilizes 1,080 effective scanning lines and the interlace system.

*2 720p specification

A high definition specification which utilizes 720 effective scanning lines and the progressive system.

*3 Data recorded in AVCHD format other than the above mentioned cannot be played on your camera.

[▲ Back to top](#)

- ▶ Before Use
- ▶ Operating the camera
- ▶ Shooting
- ▶ Viewing
- ▶ Useful shooting functions
- ▶ Useful viewing functions
- ▶ Changing settings
- ▶ Viewing images on a TV
- ▶ Using with your computer
- ▶ Printing
- ▶ Troubleshooting
- ▶ Precautions / About this camera

[⇒ Contents list](#)

License

Notes on the License

This camera comes with software that are used based on licensing agreements with the owners of that software. Based on requests by the owners of copyright of these software applications, we have an obligation to inform you of the following. Please read the following sections.

Licenses (in English) are recorded in the internal memory of your camera. Establish a Mass Storage connection between the camera and a computer to read licenses in the "PMHOME" - "LICENSE" folder.

THIS PRODUCT IS LICENSED UNDER THE AVC PATENT PORTFOLIO LICENSE FOR THE PERSONAL USE OF A CONSUMER OR OTHER USES IN WHICH IT DOES NOT RECEIVE REMUNERATION TO

(i) ENCODE VIDEO IN COMPLIANCE WITH THE AVC STANDARD ("AVC VIDEO") AND/OR

(ii) DECODE AVC VIDEO THAT WAS ENCODED BY A CONSUMER ENGAGED IN A PERSONAL ACTIVITY AND/OR WAS OBTAINED FROM A VIDEO PROVIDER LICENSED TO PROVIDE AVC VIDEO.

NO LICENSE IS GRANTED OR SHALL BE IMPLIED FOR ANY OTHER USE.

ADDITIONAL INFORMATION MAY BE OBTAINED FROM MPEG LA, L.L.C. SEE [HTTP://WWW.MPEGLA.COM](http://WWW.MPEGLA.COM)

On GNU GPL/LGPL applied software

The software that is eligible for the following GNU General Public License (hereinafter referred to as "GPL") or GNU Lesser General Public License (hereinafter referred to as "LGPL") are included in the camera.

This informs you that you have a right to have access to, modify, and redistribute source code for these software programs under the conditions of the supplied GPL/LGPL.

Source code is provided on the web. Use the following URL to download it.

<http://www.sony.net/Products/Linux/>

We would prefer you do not contact us about the contents of source code.

Licenses (in English) are recorded in the internal memory of your camera. Establish a Mass Storage connection between the camera and a computer to read licenses in the "PMHOME" - "LICENSE" folder.

[▲ Back to top](#)

- ▶ Before Use
- ▶ Operating the camera
- ▶ Shooting
- ▶ Viewing
- ▶ Useful shooting functions
- ▶ Useful viewing functions
- ▶ Changing settings
- ▶ Viewing images on a TV
- ▶ Using with your computer
- ▶ Printing
- ▶ Troubleshooting
- ▶ Precautions / About this camera

[⇒ Contents list](#)

Trademarks

- The following marks are trademarks of Sony Corporation.
Cyber-shot, “Cyber-shot,” “Memory Stick,” , “Memory Stick PRO,” **MEMORY STICK PRO**, “Memory Stick Duo,” **MEMORY STICK DUO**, “Memory Stick PRO Duo,” **MEMORY STICK PRO DUO**, “Memory Stick PRO-HG Duo,” **MEMORY STICK PRO-HG DUO**, “Memory Stick XC-HG Duo,” **MEMORY STICK XC-HG DUO**, “Memory Stick Micro,” **MEMORY STICK MICRO**, “MagicGate,” **MAGIC GATE**, “BRAVIA,” “PhotoTV HD.”
- “Blu-ray Disc™” and “Blu-ray™” are trademarks of the Blu-ray Disc Association.
- “AVCHD Progressive” and “AVCHD Progressive” logotype are trademarks of Panasonic Corporation and Sony Corporation.
- Dolby and the double-D symbol are trademarks of Dolby Laboratories.
- The terms HDMI and HDMI High-Definition Multimedia Interface, and the HDMI Logo are trademarks or registered trademarks of HDMI Licensing LLC in the United States and other countries.
- Microsoft, Windows, DirectX and Windows Vista are either registered trademarks or trademarks of Microsoft Corporation in the United States and/or other countries.
- Mac, Mac OS and iMovie are trademarks or registered trademarks of Apple Inc.
- iOS is a trademark or registered trademark of Cisco System Inc.
- Intel, Pentium and Intel Core are trademarks or registered trademarks of Intel Corporation.
- SDXC logo is a trademark of SD-3C, LLC.
- Android, Google Play are trademarks of Google Inc.
- Wi-Fi, the Wi-Fi logo, Wi-Fi PROTECTED SET-UP are registered trademarks of the Wi-Fi Alliance.
- The N Mark is a trademark or registered trademark of NFC Forum, Inc. in the United States and in other countries.
- DLNA and DLNA CERTIFIED are trademarks of Digital Living Network Alliance.
- “PlayStation” is a registered trademark of Sony Computer Entertainment Inc.
- Eye-Fi is a trademark of Eye-Fi, Inc.
- In addition, system and product names used in this manual are, in general, trademarks or registered trademarks of their respective developers or manufacturers. However, the ™ or ® marks are not used in all cases in this manual.

[▲ Back to top](#)