

- ▶ Before Use
- ▶ Operating the camera
- ▶ Shooting
- ▶ Viewing
- ▶ Useful shooting functions
- ▶ Useful viewing functions
- ▶ Changing settings
- ▶ Viewing images on a TV
- ▶ Using with your computer
- ▶ Printing
- ▶ Troubleshooting
- ▶ Precautions / About this camera

[⇒ Contents list](#)

DSC-HX50/HX50V

User Guide

Use this manual if you encounter any problems, or have any questions about the camera.



Cyber-shot

[▲ Back to top](#)

Copyright 2013 Sony Corporation

- ▶ **Before Use**
- ▶ Operating the camera
- ▶ Shooting
- ▶ Viewing
- ▶ Useful shooting functions
- ▶ Useful viewing functions
- ▶ Changing settings
- ▶ Viewing images on a TV
- ▶ Using with your computer
- ▶ Printing
- ▶ Troubleshooting
- ▶ Precautions / About this camera

[⇒ Contents list](#)

Before Use

How to use this User Guide

[How to use this User Guide](#)

Names of parts and list of icons displayed on the screen

[Names of parts](#)

[List of icons displayed on the screen](#)

Using the wrist strap

[Using the wrist strap](#)

Using the internal memory

[Using the internal memory](#)

Using the In-Camera guide

[In-Camera Guide](#)

[▲ Back to top](#)

- ▶ [Before Use](#)
- ▶ [Operating the camera](#)
- ▶ [Shooting](#)
- ▶ [Viewing](#)
- ▶ [Useful shooting functions](#)
- ▶ [Useful viewing functions](#)
- ▶ [Changing settings](#)
- ▶ [Viewing images on a TV](#)
- ▶ [Using with your computer](#)
- ▶ [Printing](#)
- ▶ [Troubleshooting](#)
- ▶ [Precautions / About this camera](#)

[⇒ Contents list](#)

Operating the camera

Operating the camera

- [Using the control wheel](#)
- [Using MENU items \(Shooting\)](#)
- [Using MENU items \(Viewing\)](#)
- [Changing camera settings](#)

[▲ Back to top](#)

- ▶ Before Use
- ▶ Operating the camera
- ▶ Shooting
- ▶ Viewing
- ▶ Useful shooting functions
- ▶ Useful viewing functions
- ▶ Changing settings
- ▶ Viewing images on a TV
- ▶ Using with your computer
- ▶ Printing
- ▶ Troubleshooting
- ▶ Precautions / About this camera

[⇒ Contents list](#)

Shooting

Shooting still images

[Shooting still images](#)

[Zoom \(Still images\)](#)

Shooting movies

[Shooting movies](#)

[Zoom \(Movies\)](#)

[Shooting still images while recording a movie \(Dual Rec\)](#)

Selecting the shooting mode based on the subject

[List of mode dial functions](#)

[Intelligent Auto](#)

[Superior Auto](#)

[Background Defocus](#)

[Program Auto](#)

[3D Still Image](#)

[Intelligent Sweep Panorama](#)

[Picture Effect](#)

[Scene Selection](#)

[Shutter Speed Priority Shooting](#)

[Aperture Priority Shooting](#)

[Manual Exposure Shooting](#)

[Memory recall mode](#)

[▲ Back to top](#)

- ▶ [Before Use](#)
- ▶ [Operating the camera](#)
- ▶ [Shooting](#)
- ▶ [Viewing](#)
- ▶ [Useful shooting functions](#)
- ▶ [Useful viewing functions](#)
- ▶ [Changing settings](#)
- ▶ [Viewing images on a TV](#)
- ▶ [Using with your computer](#)
- ▶ [Printing](#)
- ▶ [Troubleshooting](#)
- ▶ [Precautions / About this camera](#)

[⇒ Contents list](#)

Viewing

Viewing still images

[Viewing still images](#)

[Playback zoom](#)

[Image Index](#)

Deleting images

[Deleting images](#)

Viewing burst images

[Viewing burst images](#)

Viewing movies

[Viewing movies](#)

Viewing panorama images

[Scrolling the panorama images for display](#)

[▲ Back to top](#)

- ▶ Before Use
- ▶ Operating the camera
- ▶ Shooting
- ▶ Viewing
- ▶ Useful shooting functions
- ▶ Useful viewing functions
- ▶ Changing settings
- ▶ Viewing images on a TV
- ▶ Using with your computer
- ▶ Printing
- ▶ Troubleshooting
- ▶ Precautions / About this camera

[⇒ Contents list](#)

Useful shooting functions

Functions available for each shooting mode

[Functions available for each shooting mode](#)

[MENU items available for each shooting mode](#)

Menu items available for shooting

[Tracking focus](#)
[DISP \(Display Setting\)](#)
[Flash](#)
[Photo Creativity](#)
[Cont. Shooting Settings](#)
[Self-Timer](#)
[Using the CUSTOM \(Custom\) button](#)
[Movie shooting scene](#)
[Panorama Shooting Scene](#)
[Memory recall mode](#)
[Easy Mode](#)
[HDR Painting effect](#)
[Area of emphasis](#)
[Color hue](#)
[Extracted Color](#)
[Illustration Effect](#)
[Defocus Effect](#)
[Soft Skin Effect](#)
[Ctrl with Smartphone](#)
[Send to Computer](#)
[Still Image Size\(Dual Rec\)](#)
[Still Image Size/Panorama Image Size](#)
[Movie Quality/Movie Size](#)
[Exposure Compensation](#)
[ISO](#)
[White Balance](#)
[White Balance Shift](#)
[Focus](#)
[Metering Mode](#)
[Cont. Shooting Interval](#)
[Bracket Setting](#)
[Scene Recognition](#)
[Smile Shutter](#)
[Smile Detection Sensitivity](#)
[Face Detection](#)
[Color Mode](#)

Color Saturation
Contrast
Sharpness
Noise Reduction
Anti Blink
Movie SteadyShot
Position Information (DSC-HX50V)
GPS Log REC (DSC-HX50V)
Register Setting

[▲ Back to top](#)

Copyright 2013 Sony Corporation

- ▶ Before Use
- ▶ Operating the camera
- ▶ Shooting
- ▶ Viewing
- ▶ Useful shooting functions
- ▶ Useful viewing functions
- ▶ Changing settings
- ▶ Viewing images on a TV
- ▶ Using with your computer
- ▶ Printing
- ▶ Troubleshooting
- ▶ Precautions / About this camera

[⇒ Contents list](#)

Useful viewing functions

Functions available for each view mode

[MENU items available for each view mode](#)

MENU items (Viewing)

- [Send to Smartphone](#)
- [View on TV](#)
- [Send to Computer](#)
- [Retouch](#)
- [Picture Effect](#)
- [Slideshow](#)
- [Delete](#)
- [3D Viewing](#)
- [View Mode](#)
- [Display Cont. Shooting Group](#)
- [Protect](#)
- [Print \(DPOF\)](#)
- [Rotate](#)

[▲ Back to top](#)

- ▶ [Before Use](#)
- ▶ [Operating the camera](#)
- ▶ [Shooting](#)
- ▶ [Viewing](#)
- ▶ [Useful shooting functions](#)
- ▶ [Useful viewing functions](#)
- ▶ [Changing settings](#)
- ▶ [Viewing images on a TV](#)
- ▶ [Using with your computer](#)
- ▶ [Printing](#)
- ▶ [Troubleshooting](#)
- ▶ [Precautions / About this camera](#)

[⇒ Contents list](#)

Changing settings

Shooting Settings

- [Movie format](#)
- [AF Illuminator](#)
- [Grid Line](#)
- [Clear Image Zoom](#)
- [Digital Zoom](#)
- [Wind Noise Reduct.](#)
- [Micref Level](#)
- [Red Eye Reduction](#)
- [Blink Alert](#)
- [Write Date](#)
- [Expanded Focus](#)
- [Custom Button](#)
- [Disp. Resolution](#)

Main Settings

- [Beep](#)
- [Panel Brightness](#)
- [Language Setting](#)
- [Display color](#)
- [Demo Mode](#)
- [Initialize](#)
- [Function Guide](#)
- [HDMI Resolution](#)
- [CTRL FOR HDMI](#)
- [USB Connect Setting](#)
- [USB Power Supply](#)
- [LUN Setting](#)
- [Download Music](#)
- [Empty Music](#)
- [Airplane Mode](#)
- [GPS setting \(DSC-HX50V\)](#)
- [GPS assist data \(DSC-HX50V\)](#)
- [Dlt. GPS Log Data \(DSC-HX50V\)](#)
- [Eye-Fi](#)
- [Power Save](#)
- [Version](#)
- [Certification Logo \(Overseas model only\)](#)

Network Settings

- [WPS Push](#)
- [Access point settings](#)

Edit Device Name
SSID/PW Reset
Disp MAC Address

Memory Card Tool/Internal Memory Tool

Format
Create REC.Folder
Change REC.Folder
Delete REC.Folder
Copy
File Number

Clock Settings

Area Setting
Date & Time Setting
Auto Clock ADJ (DSC-HX50V)
Auto Area ADJ (DSC-HX50V)

[▲ Back to top](#)

Copyright 2013 Sony Corporation

- ▶ Before Use
- ▶ Operating the camera
- ▶ Shooting
- ▶ Viewing
- ▶ Useful shooting functions
- ▶ Useful viewing functions
- ▶ Changing settings
- ▶ Viewing images on a TV
- ▶ Using with your computer
- ▶ Printing
- ▶ Troubleshooting
- ▶ Precautions / About this camera

[⇒ Contents list](#)

Viewing images on a TV

Viewing an image on a High Definition (HD) TV

[Viewing an image on an HD TV using the HDMI Cable \(sold separately\)](#)

Viewing an image on a “BRAVIA” Sync-compatible TV

[Viewing an image on a “BRAVIA” Sync-compatible TV](#)

Viewing 3D images on a 3D TV

[Viewing 3D images on a 3D TV](#)

[▲ Back to top](#)

- ▶ Before Use
- ▶ Operating the camera
- ▶ Shooting
- ▶ Viewing
- ▶ Useful shooting functions
- ▶ Useful viewing functions
- ▶ Changing settings
- ▶ Viewing images on a TV
- ▶ Using with your computer
- ▶ Printing
- ▶ Troubleshooting
- ▶ Precautions / About this camera

[⇒ Contents list](#)

Using with your computer

Recommended computer environment

[Recommended computer environment](#)

Using the software

[“PlayMemories Home” \(Windows\)](#)

[Installing “PlayMemories Home” \(Windows\)](#)

[“Music Transfer”](#)

[Software for Mac](#)

Importing images to a computer

[Connecting the camera to the computer](#)

[Importing images to a computer](#)

[Disconnecting the camera from the computer](#)

Creating a disc of movies

[Selecting the method for creating a disc of movies](#)

[▲ Back to top](#)

- ▶ Before Use
- ▶ Operating the camera
- ▶ Shooting
- ▶ Viewing
- ▶ Useful shooting functions
- ▶ Useful viewing functions
- ▶ Changing settings
- ▶ Viewing images on a TV
- ▶ Using with your computer
- ▶ Printing
- ▶ Troubleshooting
- ▶ Precautions / About this camera

[⇒ Contents list](#)

Printing

Printing still images

[Printing still images](#)

[▲ Back to top](#)

- ▶ [Before Use](#)
- ▶ [Operating the camera](#)
- ▶ [Shooting](#)
- ▶ [Viewing](#)
- ▶ [Useful shooting functions](#)
- ▶ [Useful viewing functions](#)
- ▶ [Changing settings](#)
- ▶ [Viewing images on a TV](#)
- ▶ [Using with your computer](#)
- ▶ [Printing](#)
- ▶ [Troubleshooting](#)
- ▶ [Precautions / About this camera](#)

[⇒ Contents list](#)

Troubleshooting

If you have problems

[If you have problems](#)

Troubleshooting

[Battery pack and power](#)

[Shooting still images/movies](#)

[Viewing images](#)

[Wi-Fi](#)

[GPS \(DSC-HX50V\)](#)

[Computers](#)

[Memory card](#)

[Internal memory](#)

[Printing](#)

[Others](#)

Warning indicators and messages

[Self-diagnosis display](#)

[Messages](#)

Situations this camera has difficulty handling

[Situations this camera has difficulty handling](#)

[▲ Back to top](#)

- ▶ [Before Use](#)
- ▶ [Operating the camera](#)
- ▶ [Shooting](#)
- ▶ [Viewing](#)
- ▶ [Useful shooting functions](#)
- ▶ [Useful viewing functions](#)
- ▶ [Changing settings](#)
- ▶ [Viewing images on a TV](#)
- ▶ [Using with your computer](#)
- ▶ [Printing](#)
- ▶ [Troubleshooting](#)
- ▶ [Precautions / About this camera](#)

[⇒ Contents list](#)

Precautions / About this camera

Precautions

- [Precautions](#)
- [On the internal rechargeable backup battery](#)
- [Battery pack](#)
- [Charging the battery pack](#)
- [Memory card](#)

On cleaning

- [On cleaning](#)

Number of still images and recordable time of movies

- [Number of still images](#)
- [Recordable time of movies](#)

Using the camera abroad

- [Using the camera abroad](#)
- [On TV color systems](#)

About this camera

- [AVCHD format](#)
- [GPS \(DSC-HX50V\)](#)
- [License](#)

Trademarks

- [Trademarks](#)

[▲ Back to top](#)

- ▶ [Before Use](#)
- ▶ [Operating the camera](#)
- ▶ [Shooting](#)
- ▶ [Viewing](#)
- ▶ [Useful shooting functions](#)
- ▶ [Useful viewing functions](#)
- ▶ [Changing settings](#)
- ▶ [Viewing images on a TV](#)
- ▶ [Using with your computer](#)
- ▶ [Printing](#)
- ▶ [Troubleshooting](#)
- ▶ [Precautions / About this camera](#)

[⇒ Contents list](#)

Contents list

Before Use

How to use this User Guide

[How to use this User Guide](#)

Names of parts and list of icons displayed on the screen

[Names of parts](#)

[List of icons displayed on the screen](#)

Using the wrist strap

[Using the wrist strap](#)

Using the internal memory

[Using the internal memory](#)

Using the In-Camera guide

[In-Camera Guide](#)

[▲ Back to top](#)

Operating the camera

Operating the camera

[Using the control wheel](#)

[Using MENU items \(Shooting\)](#)

[Using MENU items \(Viewing\)](#)

[Changing camera settings](#)

[▲ Back to top](#)

Shooting

Shooting still images

[Shooting still images](#)

[Zoom \(Still images\)](#)

Shooting movies

[Shooting movies](#)

[Zoom \(Movies\)](#)

[Shooting still images while recording a movie \(Dual Rec\)](#)

Selecting the shooting mode based on the subject

[List of mode dial functions](#)

[Intelligent Auto](#)

[Superior Auto](#)

[Background Defocus](#)

[Program Auto](#)

[3D Still Image](#)

- Intelligent Sweep Panorama
- Picture Effect
- Scene Selection
- Shutter Speed Priority Shooting
- Aperture Priority Shooting
- Manual Exposure Shooting
- Memory recall mode

[▲ Back to top](#)

Viewing

Viewing still images

- Viewing still images
- Playback zoom
- Image Index

Deleting images

- Deleting images

Viewing burst images

- Viewing burst images

Viewing movies

- Viewing movies

Viewing panorama images

- Scrolling the panorama images for display

[▲ Back to top](#)

Useful shooting functions

Functions available for each shooting mode

- Functions available for each shooting mode
- MENU items available for each shooting mode

Menu items available for shooting

- Tracking focus
- DISP (Display Setting)
- Flash
- Photo Creativity
- Cont. Shooting Settings
- Self-Timer
- Using the CUSTOM (Custom) button
- Movie shooting scene
- Panorama Shooting Scene
- Memory recall mode
- Easy Mode
- HDR Painting effect
- Area of emphasis
- Color hue
- Extracted Color
- Illustration Effect
- Defocus Effect

Soft Skin Effect
Ctrl with Smartphone
Send to Computer
Still Image Size(Dual Rec)
Still Image Size/Panorama Image Size
Movie Quality/Movie Size
Exposure Compensation
ISO
White Balance
White Balance Shift
Focus
Metering Mode
Cont. Shooting Interval
Bracket Setting
Scene Recognition
Smile Shutter
Smile Detection Sensitivity
Face Detection
Color Mode
Color Saturation
Contrast
Sharpness
Noise Reduction
Anti Blink
Movie SteadyShot
Position Information (DSC-HX50V)
GPS Log REC (DSC-HX50V)
Register Setting

[▲ Back to top](#)

Useful viewing functions

Functions available for each view mode

MENU items available for each view mode

MENU items (Viewing)

Send to Smartphone
View on TV
Send to Computer
Retouch
Picture Effect
Slideshow
Delete
3D Viewing
View Mode
Display Cont. Shooting Group
Protect
Print (DPOF)
Rotate

[▲ Back to top](#)

Changing settings

Shooting Settings

- Movie format
- AF Illuminator
- Grid Line
- Clear Image Zoom
- Digital Zoom
- Wind Noise Reduct.
- Micref Level
- Red Eye Reduction
- Blink Alert
- Write Date
- Expanded Focus
- Custom Button
- Disp. Resolution

Main Settings

- Beep
- Panel Brightness
- Language Setting
- Display color
- Demo Mode
- Initialize
- Function Guide
- HDMI Resolution
- CTRL FOR HDMI
- USB Connect Setting
- USB Power Supply
- LUN Setting
- Download Music
- Empty Music
- Airplane Mode
- GPS setting (DSC-HX50V)
- GPS assist data (DSC-HX50V)
- Dlt. GPS Log Data (DSC-HX50V)
- Eye-Fi
- Power Save
- Version
- Certification Logo (Overseas model only)

Network Settings

- WPS Push
- Access point settings
- Edit Device Name
- SSID/PW Reset
- Disp MAC Address

Memory Card Tool/Internal Memory Tool

- Format
- Create REC.Folder

- Change REC.Folder
- Delete REC.Folder
- Copy
- File Number

Clock Settings

- Area Setting
- Date & Time Setting
- Auto Clock ADJ (DSC-HX50V)
- Auto Area ADJ (DSC-HX50V)

[▲ Back to top](#)

Viewing images on a TV

Viewing an image on a High Definition (HD) TV

- Viewing an image on an HD TV using the HDMI Cable (sold separately)

Viewing an image on a “BRAVIA” Sync-compatible TV

- Viewing an image on a “BRAVIA” Sync-compatible TV

Viewing 3D images on a 3D TV

- Viewing 3D images on a 3D TV

[▲ Back to top](#)

Using with your computer

Recommended computer environment

- Recommended computer environment

Using the software

- “PlayMemories Home” (Windows)
- Installing “PlayMemories Home” (Windows)
- “Music Transfer”
- Software for Mac

Importing images to a computer

- Connecting the camera to the computer
- Importing images to a computer
- Disconnecting the camera from the computer

Creating a disc of movies

- Selecting the method for creating a disc of movies

[▲ Back to top](#)

Printing

Printing still images

- Printing still images

[▲ Back to top](#)

Troubleshooting

If you have problems

- If you have problems

Troubleshooting

- Battery pack and power
- Shooting still images/movies
- Viewing images
- Wi-Fi
- GPS (DSC-HX50V)
- Computers
- Memory card
- Internal memory
- Printing
- Others

Warning indicators and messages

- Self-diagnosis display
- Messages

Situations this camera has difficulty handling

- Situations this camera has difficulty handling

[▲ Back to top](#)

Precautions / About this camera

Precautions

- Precautions
- On the internal rechargeable backup battery
- Battery pack
- Charging the battery pack
- Memory card

On cleaning

- On cleaning

Number of still images and recordable time of movies

- Number of still images
- Recordable time of movies

Using the camera abroad

- Using the camera abroad
- On TV color systems

About this camera

- AVCHD format
- GPS (DSC-HX50V)
- License

Trademarks

- Trademarks

[▲ Back to top](#)

[▶ Before Use](#)[▶ Operating the camera](#)[▶ Shooting](#)[▶ Viewing](#)[▶ Useful shooting functions](#)[▶ Useful viewing functions](#)[▶ Changing settings](#)[▶ Viewing images on a TV](#)[▶ Using with your computer](#)[▶ Printing](#)[▶ Troubleshooting](#)[▶ Precautions / About this camera](#)[→ Contents list](#)

How to use this User Guide

- ▼ [Selecting a topic to display](#)
- ▼ [Searching a topic by keyword](#)
- ▼ [Returning to a previous page](#)
- ▼ [Printing out a page](#)
- ▼ [Marks and notations used in this User Guide](#)

The images used as examples in this User Guide are reproduced images, and are not actual images shot using this camera.

Selecting a topic to display

The following illustrations take Internet Explorer 7 as an example.

1. Click a title in the side bar on the left of the browser window.
The title's topic list appears in the right pane.
2. Click a topic title in the list.

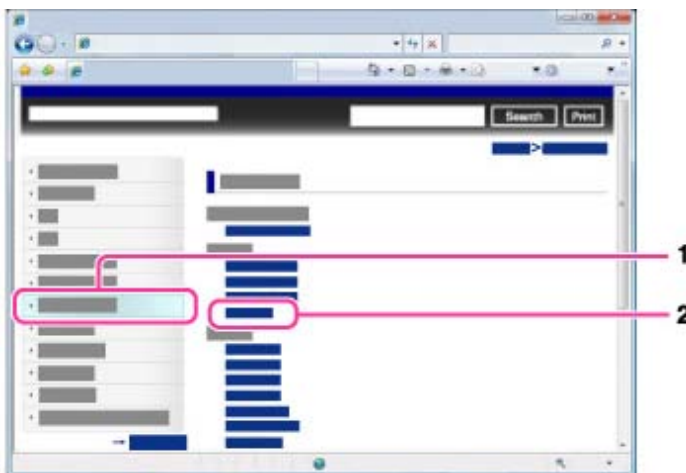

Descriptions appear in the right pane.



Changing the font size

Change the font size by changing the setting of your web browser. For how to change the font size setting, refer to the Help of your web browser.

Searching a topic by keyword

Enter the keyword in the search window, then click the [Search] button.

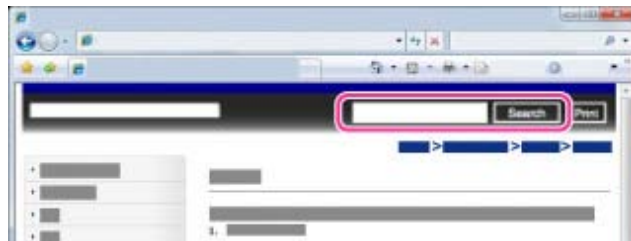

Returning to a previous page

Use the browser's back button to return to a previously viewed page, or use the breadcrumb trail navigation (A) to display the desired page.



Printing out a page

Click the [Print] button to print out the page you are viewing.

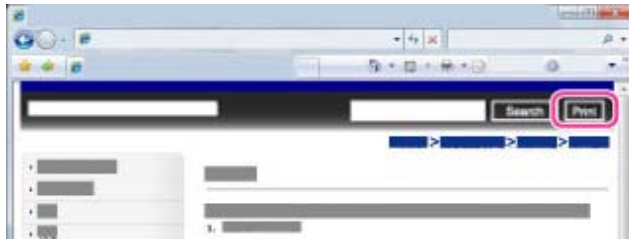

Marks and notations used in this User Guide

In this User Guide, the sequence of operations is shown by arrows (→) (A). Operate the camera in the order indicated.

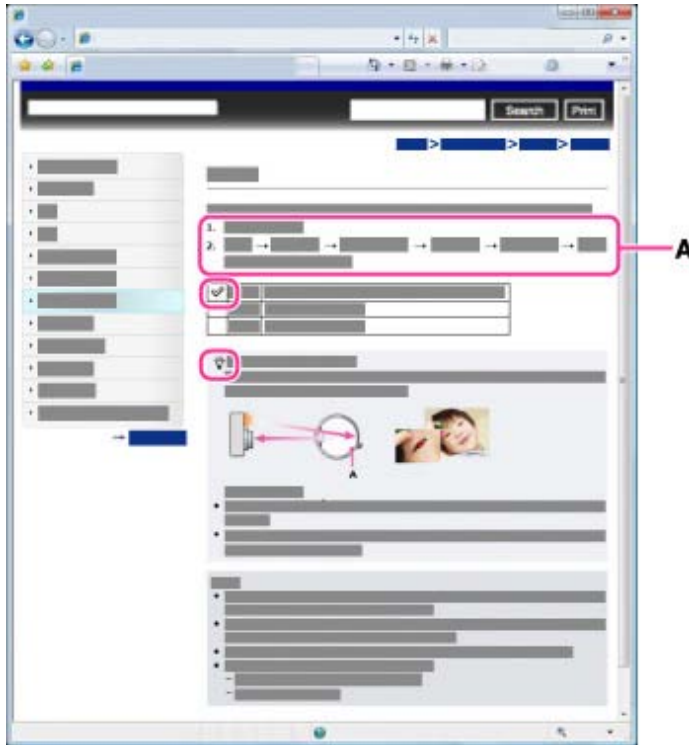

- Icons in the operating procedure sentences appear when the camera is in its default settings.
- The default setting is indicated by ✓.
- 💡 indicates information that is useful to know.

[▲ Back to top](#)

Copyright 2013 Sony Corporation

▶ Before Use

▶ Operating the camera

▶ Shooting

▶ Viewing

▶ Useful shooting functions

▶ Useful viewing functions

▶ Changing settings

▶ Viewing images on a TV

▶ Using with your computer

▶ Printing



▶ Troubleshooting

▶ Precautions / About this camera

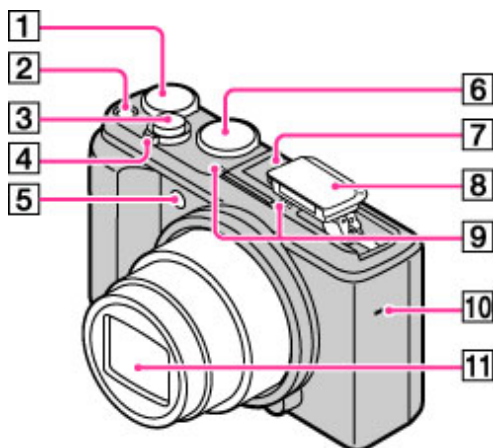

[→ Contents list](#)

Names of parts

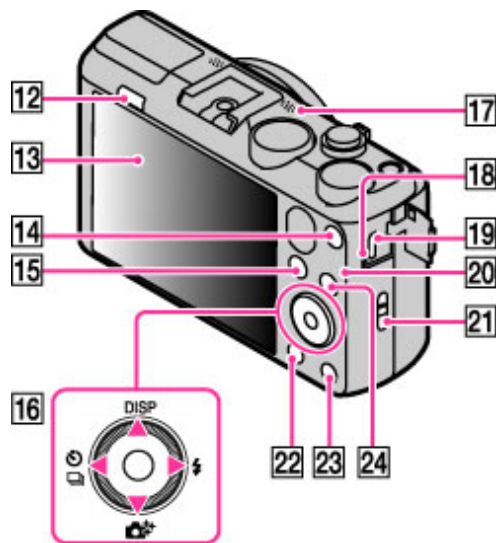

- 1** Exposure compensation dial
- 2** ON/OFF (Power) button
- 3** Shutter button
- 4** For shooting: W/T (zoom) lever
For viewing:  (Index) lever/ (Playback zoom) lever
- 5** Self-timer lamp/Smile Shutter lamp/AF illuminator
- 6** Mode dial
- 7** Multi interface shoe^{*1}
- 8** Flash
- 9** Microphone
- 10** Speaker
- 11** Lens



- 12  (Flash pop-up) button
- 13 LCD screen
- 14 MOVIE (Movie) button
- 15  (Playback) button
- 16 Control wheel
- 17 GPS sensor (built-in) (DSC-HX50V only)
- 18 Charge lamp
- 19 Multi/Micro USB Terminal^{*2}
- 20 Wi-Fi sensor (built-in)
- 21 Hook for wrist strap
- 22 MENU button
- 23  (In-Camera Guide/Delete) button
- 24 CUSTOM (Custom) button

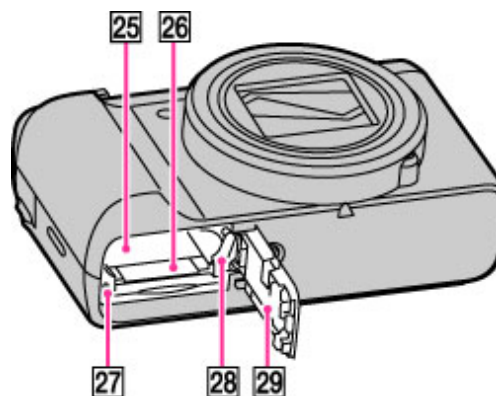

- 25 Battery insertion slot
- 26 Memory card slot
- 27 Access lamp
- 28 Battery eject lever

29 Battery/Memory card cover

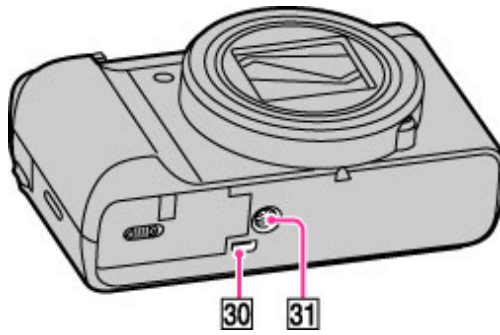

30 HDMI micro jack

31 Tripod receptacle

*1 For details on compatible accessories for the multi interface shoe, visit the Sony web site, or consult your Sony dealer or local authorized Sony service facility. You can also use accessories that are compatible with the accessory shoe. Operations with other manufacturers' accessories are not guaranteed.



*2 Supports Micro USB compatible device.

[▲ Back to top](#)

Top page > Before Use > Names of parts and list of icons displayed on the screen > List of icons displayed on the screen

- ▶ Before Use
- ▶ Operating the camera
- ▶ Shooting
- ▶ Viewing
- ▶ Useful shooting functions
- ▶ Useful viewing functions
- ▶ Changing settings
- ▶ Viewing images on a TV
- ▶ Using with your computer
- ▶ Printing
- ▶ Troubleshooting
- ▶ Precautions / About this camera

[→ Contents list](#)

List of icons displayed on the screen

▼ List of shooting mode icons

▼ List of viewing mode icons

Icons are displayed on the screen to indicate the camera status.

You can change the screen display using **DISP** (Display Setting) on the control wheel.

List of shooting mode icons

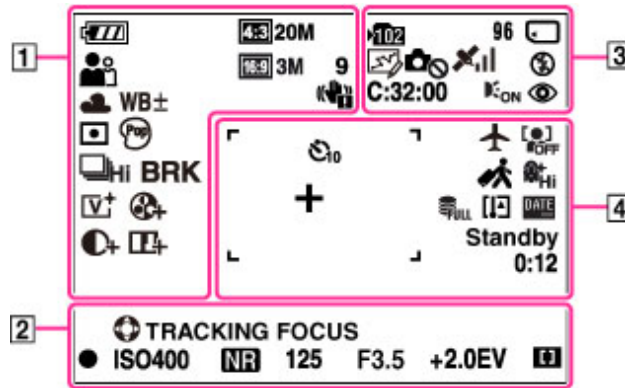

1













Display	Indication
	Battery remaining
	Low battery warning
	Image size/Panorama image size/Quality
9	Number of recordable images (Dual Rec)
	Memory recall mode
	Scene Selection
	Shooting mode
	Scene Recognition icon
	White balance
WB±	White balance Shift

	Metering Mode
	Picture Effect
	Vibration warning
	Anti Blink
	Scene Recognition
	Overlay icon
	Burst Shooting Interval
BRK	Bracket Shooting
± 0.3 ± 0.7 ± 1.0 BRK EV EV EV WB	Bracket Setting
	Color Mode
	Color Saturation
	Contrast
	Sharpness
NR_ NR+	Noise reduction
	Smile Detection Sensitivity indicator
	Zoom scaling













2

Display	Indication
	Tracking focus
	AE/AF lock
	Semi Manual
	Manual Focus
	Manual Focus bar
	Level
ISO400	ISO number
NR	NR slow shutter
125	Shutter speed
F3.5	Aperture value
+2.0EV	Exposure value
	AF range finder frame indicator

3

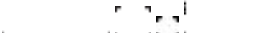
Display	Indication
	Recording folder
96	Number of recordable images
	Buffer writing
CAPTURE	Importing still images
100Min	Recordable time
	Recording Media (Memory card, internal memory)
	Eye-Fi Mode display
	GPS Log REC (DSC-HX50V)
	Warning indicator pertaining to still image recording
	GPS triangulating status (DSC-HX50V)
	Flash mode
C:32:00	Self-diagnosis display
	AF Illuminator
	Red-eye reduction
	Defocus Effect
	Flash charging

4

Display	Indication
	Self-timer
	Airplane Mode
	Destination (DSC-HX50)
	Face detection
	Soft Skin Effect
	Micref Level (Microphone reference level)
	Database file full/Database file error
	Overheating warning
	Write Date
	AF range finder frame
	Spot metering cross-hairs
	Wind Noise Reduction
	Histogram
REC Standby	Recording a movie/Movie standby
0:12	Recording time (m:s)

List of viewing mode icons

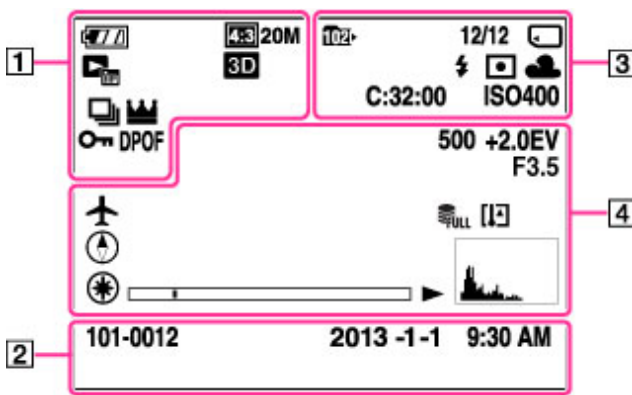

1





Display	Indication
	Battery remaining
	Low battery warning
	Image size/Panorama image size/Quality
	View mode
	3D images
	Burst Images
	Main image in the burst group
	Protect
	Print order (DPOF)
	Playback zoom

2











Display	Indication
101-0012	Folder-file number
2013-1-1 9:30 AM	Recorded date/time of the playback image

3

Display	Indication
	Playback folder
12/12	Image number/Number of images recorded in selected date range, folder
	Playback Media (Memory card, internal memory)

	Eye-Fi Mode display
	Flash mode
	Metering Mode
	White balance
C:32:00	Self-diagnosis display
ISO400	ISO number

4

Display	Indication
500	Shutter speed
+2.0EV	Exposure value
F3.5	Aperture value
	Direction
	Airplane Mode
	GPS information
35°37'32"N 139°44'31"E	Latitude and longitude display
	Database file full/Database file error
	Overheating warning
	Playback
	Variable speed playback
	Playback bar
00:00:12	Counter
	Histogram
	Volume

[▲ Back to top](#)

[▶ Before Use](#)[▶ Operating the camera](#)[▶ Shooting](#)[▶ Viewing](#)[▶ Useful shooting functions](#)[▶ Useful viewing functions](#)[▶ Changing settings](#)[▶ Viewing images on a TV](#)[▶ Using with your computer](#)[▶ Printing](#)[▶ Troubleshooting](#)[▶ Precautions / About this camera](#)[⇒ Contents list](#)

Using the wrist strap

Attach the strap and place your hand through the loop to prevent the camera from damage by being dropped.

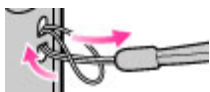
[▲ Back to top](#)

- ▶ Before Use
- ▶ Operating the camera
- ▶ Shooting
- ▶ Viewing
- ▶ Useful shooting functions
- ▶ Useful viewing functions
- ▶ Changing settings
- ▶ Viewing images on a TV
- ▶ Using with your computer
- ▶ Printing
- ▶ Troubleshooting
- ▶ Precautions / About this camera

[⇒ Contents list](#)

Using the internal memory

▼ On image data stored in the internal memory

The camera has approximately 48 MB of internal memory. You can record still images on the internal memory when there is no memory card inserted in the camera.

When a memory card is inserted

[Recording]: Images are recorded on the memory card.

[Playback]: Images on the memory card are played back.

[Menu, Settings, etc.]: Various functions can be performed on images on the memory card.

When there is no memory card inserted

[Recording]: Images are recorded using the internal memory. However, movies cannot be recorded to the internal memory.

[Playback]: Images stored in the internal memory are played back.

[Menu, Settings, etc.]: Various functions can be performed on images in the internal memory.

■ On image data stored in the internal memory

We recommend that you copy (back up) data using one of the following methods.

To copy (back up) data on a hard disk of your computer

Without a memory card inserted in the camera, import the images into a computer. [\[Details\]](#)

To copy (back up) data on a memory card

Prepare a memory card with sufficient free capacity, then copy the images in the internal memory to the memory card. [\[Details\]](#)

Notes

- You cannot transfer image data on a memory card to the internal memory.
- By making a USB connection between the camera and a computer with a micro USB cable, you can transfer data stored in the internal memory to a computer. However you cannot transfer data on a computer to the internal memory.
- You cannot transfer images recorded on the internal memory using the Wi-Fi function.

[▲ Back to top](#)



- ▶ Before Use
- ▶ Operating the camera
- ▶ Shooting
- ▶ Viewing
- ▶ Useful shooting functions
- ▶ Useful viewing functions
- ▶ Changing settings
- ▶ Viewing images on a TV
- ▶ Using with your computer
- ▶ Printing
- ▶ Troubleshooting
- ▶ Precautions / About this camera

[⇒ Contents list](#)

In-Camera Guide

This camera contains an internal function guide. This allows you to search the camera's functions according to your needs.

You can use the selected function after reading the guide.

1. Press the MENU button.
2. Select the desired MENU item using ▲ / ▼ .
3. Press the  (In-Camera Guide) button.
The operation guide for the MENU item you have selected in step 2 is displayed.
4. Use ▲ / ▼ to switch among summary, operation and details screens.
 - When [Use this function] is displayed on the screen, select it to switch to that mode.
 - If you press the  (In-Camera Guide) button when the MENU screen is not displayed, you can search the guide using keywords or icons.

Notes

-  (In-Camera Guide) button is not available in Easy Mode.
- Depending on the selected functions, the operation guide and details may not be displayed.

[▲ Back to top](#)



- ▶ Before Use
- ▶ Operating the camera
- ▶ Shooting
- ▶ Viewing
- ▶ Useful shooting functions
- ▶ Useful viewing functions
- ▶ Changing settings
- ▶ Viewing images on a TV
- ▶ Using with your computer
- ▶ Printing
- ▶ Troubleshooting
- ▶ Precautions / About this camera

[→ Contents list](#)

Using the control wheel

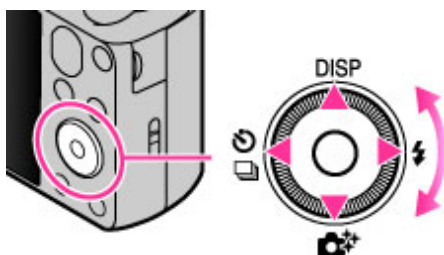
- ▼ Moving the selection frame on MENU screen, etc.
- ▼ Selecting an image to be played back



The following functions are located on the up/down/right/left side of the control wheel: **DISP** (Display Setting),  (Photo Creativity),  (Cont. Shooting/Self-Timer) and  (Flash).

Press the control wheel toward each icon to enter the setup screen for each function.

Turn the control wheel or press the up/down/right/left side of the wheel following the screen to move the selection frame.

Press  in the center of the control wheel to set the selected item.

Moving the selection frame on MENU screen, etc.

Turn the control wheel or press the up/down/right/left side of the wheel to move the selection frame. In some modes, you can also move the selection frame by turning the control wheel.



Selecting an image to be played back

Press the right or left side of the control wheel, or turn the wheel to play back the next/previous image.



[▲ Back to top](#)

- ▶ Before Use
- ▶ **Operating the camera**
- ▶ Shooting
- ▶ Viewing
- ▶ Useful shooting functions
- ▶ Useful viewing functions
- ▶ Changing settings
- ▶ Viewing images on a TV
- ▶ Using with your computer
- ▶ Printing
- ▶ Troubleshooting
- ▶ Precautions / About this camera

[→ Contents list](#)

Using MENU items (Shooting)

You can select the various shooting functions easily from the MENU button.

1. Press the ON/OFF (Power) button and set the camera to shooting mode.
2. Press the MENU button to display the Menu screen.

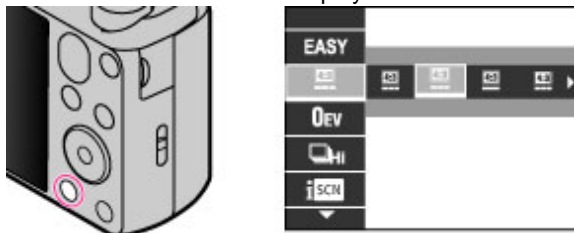

3. Select the desired menu item with ▲ / ▼ on the control wheel.

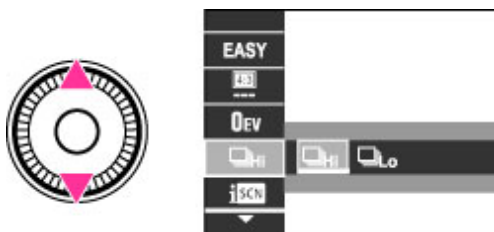

4. Select the desired item with ◀ / ▶ on the control wheel or by turning the control wheel.



5. Press the MENU button to close the Menu screen.

[▲ Back to top](#)

- ▶ Before Use
- ▶ Operating the camera
- ▶ Shooting
- ▶ Viewing
- ▶ Useful shooting functions
- ▶ Useful viewing functions
- ▶ Changing settings
- ▶ Viewing images on a TV
- ▶ Using with your computer
- ▶ Printing
- ▶ Troubleshooting
- ▶ Precautions / About this camera

[→ Contents list](#)

Using MENU items (Viewing)

You can select the various viewing functions easily from the MENU button.

1. Switch to playback mode.
2. Press the MENU button to display the Menu screen.

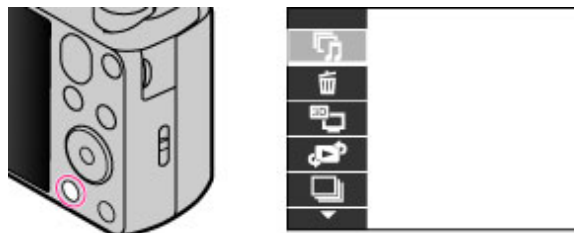

3. Select the desired menu item with ▲ / ▼ on the control wheel.



4. Select the desired item with ◀ / ▶ on the control wheel or by turning the control wheel.



5. Press ● in the center of the control wheel to execute the function.

[▲ Back to top](#)

- ▶ Before Use
- ▶ Operating the camera
- ▶ Shooting
- ▶ Viewing
- ▶ Useful shooting functions
- ▶ Useful viewing functions
- ▶ Changing settings
- ▶ Viewing images on a TV
- ▶ Using with your computer
- ▶ Printing
- ▶ Troubleshooting
- ▶ Precautions / About this camera

[→ Contents list](#)

Changing camera settings

You can change the settings on the [Settings] screen.

1. Press the MENU button to display the Menu screen.

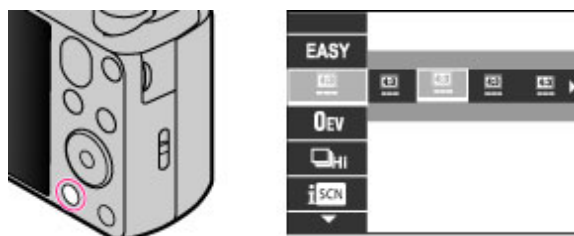

2. Select  (Settings) with ▲ / ▼ on the control wheel, then press ● on the control wheel to display the setup screen.

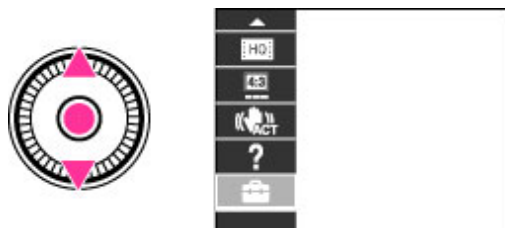

3. Select the desired category by using ▲ / ▼ on the control wheel or turning the control wheel, then press ●.

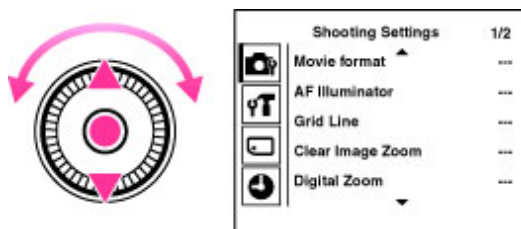

4. Select the desired item by using ▲ / ▼ on the control wheel or turning the control wheel, then press ●.

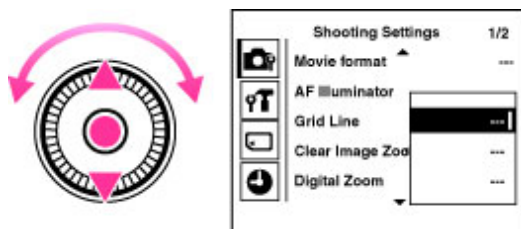

5. Select the desired setting, then press ●.

Notes

- [Shooting Settings] appears only when settings have been entered from shooting mode.
-

- [Memory Card Tool] appears only when a memory card is inserted in the camera, while [Internal Memory Tool] appears only when a memory card is not inserted.

[▲ Back to top](#)

Copyright 2013 Sony Corporation

- ▶ Before Use
- ▶ Operating the camera
- ▶ Shooting
- ▶ Viewing
- ▶ Useful shooting functions
- ▶ Useful viewing functions
- ▶ Changing settings
- ▶ Viewing images on a TV
- ▶ Using with your computer
- ▶ Printing
- ▶ Troubleshooting
- ▶ Precautions / About this camera

[→ Contents list](#)

Shooting still images

1. Set the mode dial to  (Intelligent Auto), then press the ON/OFF (Power) button.

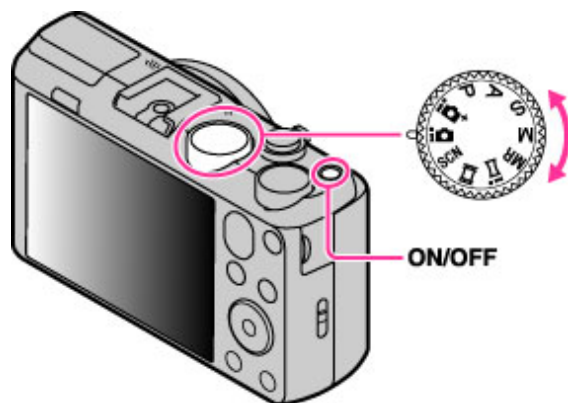

2. Hold the camera steady as illustrated.



3. Press the shutter button halfway down to focus.
When the image is in focus, a beep sounds and the  indicator lights.

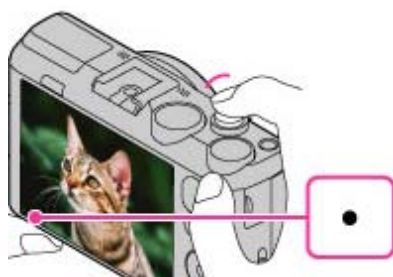

- The shortest shooting distance is approximately 5 cm (0.16 ft.) (W), 2 m (6.56 ft.) (T) (from the lens).

4. Press the shutter button fully down.



- When you want to use the flash, press the  (flash pop-up) button to pop up the flash unit.

 **If you shoot a still image of a subject that is difficult to focus on**

- When the camera cannot focus on the subject automatically, the AE/AF lock indicator changes to slowly flashing and the beep does not sound. Either recompose the shot or change the focus setting. [\[Details\]](#)
- Focusing may be difficult in the following situations:
 - It is dark and the subject is distant.
 - The contrast between the subject and the background is poor.
 - The subject is seen through glass.
 - The subject is moving quickly.
 - There is reflective light or shiny surfaces.
 - The subject is backlit or there is a flashing light.

[▲ Back to top](#)

Copyright 2013 Sony Corporation

- ▶ Before Use
- ▶ Operating the camera
- ▶ Shooting
- ▶ Viewing
- ▶ Useful shooting functions
- ▶ Useful viewing functions
- ▶ Changing settings
- ▶ Viewing images on a TV
- ▶ Using with your computer
- ▶ Printing
- ▶ Troubleshooting
- ▶ Precautions / About this camera

[→ Contents list](#)

Zoom (Still images)

▼ Available zoom

▼ Zoom scale

Enlarges images with the W/T (zoom) lever when shooting. The camera's optical zoom function can enlarge images up to 30x.

Optical zoom allows you to enlarge an image without deteriorating its original quality.

1. Set the camera to shooting mode.
2. Slide the W/T (zoom) lever.
 - Slide the lever to the T side to zoom in, or to the W side to zoom out.



Notes

- Zoom is locked to the W side in [iSweep Panorama] mode.

Available zoom

The camera achieves a high magnification zoom scale by combining zoom methods. The icon and zoom bar on the screen change in accordance with the zoom you use.

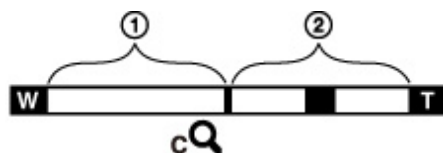

① Optical zoom range

The camera's optical zoom function can enlarge images up to 30x.

② Zoom range other than optical zoom

- Zoom with the original image quality

When [Image Size] is set to other than the maximum image size, you can shoot still images with no deterioration in the original image quality, even if the optical zoom scale exceeds 30x magnification, by trimming image processing.

- (cQ) [Clear Image Zoom]

Zoom with close to the original image quality [\[Details\]](#)

- (DQ) [Digital Zoom]

Less than the original image quality [\[Details\]](#)

Operation	Settings	Zoom bar
Using optical zoom	Still Image Size: [20M]/[16:9(15M)] [Clear Image Zoom]: [Off]	

only	[Digital Zoom]: [Off]	
Zooming images without deterioration	Still Image Size: Other than [20M] [Clear Image Zoom]: [Off] [Digital Zoom]: [Off]	
Shooting clear images using [Clear Image Zoom] (close to the original image quality)	[Clear Image Zoom]: [On] [Digital Zoom]: [Off]	
Zooming to the maximum zoom range	[Clear Image Zoom]: [On] [Digital Zoom]: [On] • [Clear Image Zoom] may not be available for some settings. [Details]	

Zoom scale

The supported zoom scales are different depending on the settings or the image size. The table below summarizes the zoom scales when [Clear Image Zoom] and [Digital Zoom] are set to [On].

Image Size	Optical zoom	Zoom with [Clear Image Zoom] [On]	Zoom with maximum zoom scale ^{*1}
20M	30	60	120
10M	30	85	170
5M	30	120	240
VGA	30	486	486 ^{*2}
16:9(15M)	30	60	120
16:9(2M)	30	162	324

*1 The maximum zoom scale is the magnification when [Clear Image Zoom] is set to [On] or [Digital Zoom] is set to [On]. The maximum zoom scale varies depending on the settings. The maximum zoom scale for the default setting is the same as when [Clear Image Zoom] is [On]. [\[Details\]](#)

*2 When [Still Image Size] is set to [VGA], [Digital Zoom] is limited; magnification will be the same when [Digital Zoom] is set to [Off], and when [Clear Image Zoom] is set to [On].

Notes

- The default setting for [Clear Image Zoom] is [On].
- The default setting for [Digital Zoom] is [Off]. Set [Digital Zoom] to [On] to enlarge images even with deterioration. [\[Details\]](#)
- The default setting for [Still Image Size] is set to maximum. To change the zoom scale, change [Still Image Size]. [\[Details\]](#)
- Zoom functions other than the optical zoom are not available when shooting in the following situations:
 - In [Picture Effect]
 - In [Background Defocus]
 - When the Smile Shutter function is activated.
 - When [Self-Timer] is set to [Self-portrait One Person] or [Self-portrait Two People].
 - When [Backlight Correction HDR] or [Advanced Sports Shooting] mode is selected in Scene Selection.
- The Face Detection function does not operate when you use other than the optical zoom.

[▲ Back to top](#)

- ▶ Before Use
- ▶ Operating the camera
- ▶ Shooting
- ▶ Viewing
- ▶ Useful shooting functions
- ▶ Useful viewing functions
- ▶ Changing settings
- ▶ Viewing images on a TV
- ▶ Using with your computer
- ▶ Printing
- ▶ Troubleshooting
- ▶ Precautions / About this camera

[➔ Contents list](#)

Shooting movies

1. Set the mode dial to  (Movie Mode), then press the ON/OFF (Power) button.

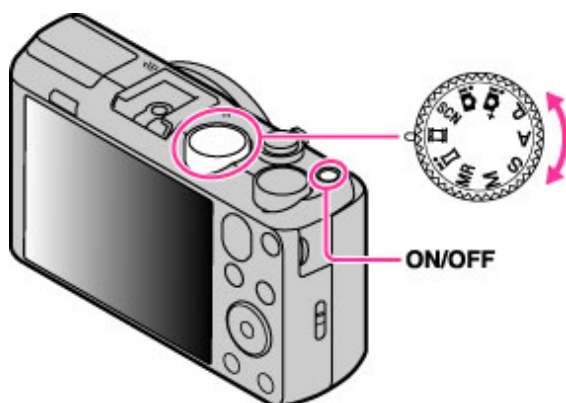

2. Press the MOVIE (Movie) button to start recording.

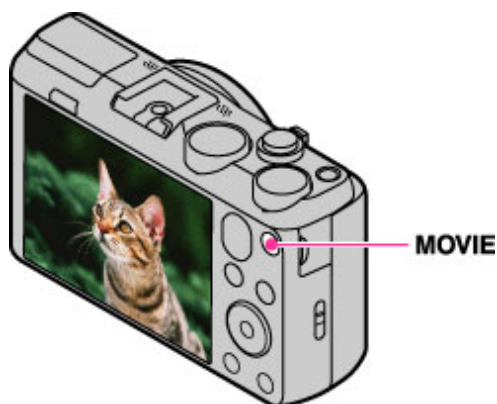

3. Press the MOVIE button again to stop recording.

MOVIE (Movie) button

You can start recording a movie by pressing the MOVIE button, regardless of the position of the mode dial.

Notes

- The sound of the lens and lever operating will be recorded when the zoom function operates while shooting a movie. The sound of the MOVIE button operating may also be recorded when you press the MOVIE button to stop recording.
- Continuous shooting is possible for approximately 29 minutes at one time at the camera's default settings and when the temperature is approximately 25°C (77°F). When movie recording is finished, you can restart recording by pressing the MOVIE button again. Recording may stop to protect the camera depending on the ambient temperature.

Related Topic[Zoom \(Movies\)](#)[Shooting still images while recording a movie \(Dual Rec\)](#)[Movie Quality/Movie Size](#)[Movie format](#)

[▲ Back to top](#)

Copyright 2013 Sony Corporation

- ▶ Before Use
- ▶ Operating the camera
- ▶ Shooting
- ▶ Viewing
- ▶ Useful shooting functions
- ▶ Useful viewing functions
- ▶ Changing settings
- ▶ Viewing images on a TV
- ▶ Using with your computer
- ▶ Printing
- ▶ Troubleshooting
- ▶ Precautions / About this camera

[→ Contents list](#)

Zoom (Movies)

▼ Available zoom

Enlarges images with the W/T (zoom) lever when shooting. The camera's optical zoom function can enlarge images up to 30x.

1. Set the camera to shooting mode.
 2. Slide the W/T (zoom) lever.
- Slide the lever to the T side to zoom in, or to the W side to zoom out.



Available zoom

When zooming, you can exceed the 30x optical zoom. Set [Digital Zoom] to [On] to enlarge the images. The camera can enlarge images up to 120x.



- ① Optical zoom range
Optical zoom: The camera's optical zoom function can enlarge images up to 30x.
- ② Zoom range other than optical zoom
[Digital Zoom]: Less than original image quality. [\[Details\]](#)

Operation	Settings	Zoom bar
To zoom in to the maximum scale before image quality deterioration occurs	[Digital Zoom]: [Off]	
To zoom in to the maximum scale	[Digital Zoom]: [On]	

Notes

- [Clear Image Zoom] is not available while recording movies.
- The camera zooms slowly while recording movies.

[▲ Back to top](#)

- ▶ Before Use
- ▶ Operating the camera
- ▶ Shooting
- ▶ Viewing
- ▶ Useful shooting functions
- ▶ Useful viewing functions
- ▶ Changing settings
- ▶ Viewing images on a TV
- ▶ Using with your computer
- ▶ Printing
- ▶ Troubleshooting
- ▶ Precautions / About this camera

[⇒ Contents list](#)

Shooting still images while recording a movie (Dual Rec)

You can shoot still images while recording a movie. The camera keeps recording the movie even if you shoot still images.

1. Press the MOVIE (Movie) button to start recording a movie.

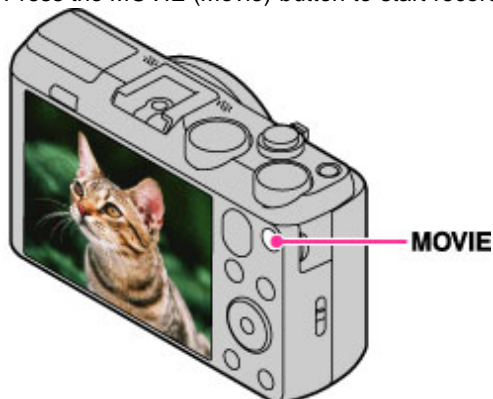

2. Press the shutter button.
A still image is recorded.
 - The number of recordable still images (**A**) appears on the screen when you press the shutter button halfway down.



3. Press the MOVIE button to stop recording the movie.

Notes

- When movies are recorded in [AVC HD 28M (PS)] quality, you cannot use Dual Rec.
- The sound of the shutter button operating may be recorded.
- Flash is not available for shooting still images during movie recording.
- The size of a still image that can be shot while recording a movie varies depending on the movie size. For details, see "Still Image Size(Dual Rec)." [\[Details\]](#)
- When the Smile Shutter function is set to [On], the shutter releases automatically each time the camera detects a smiling face. You cannot switch [On] or [Off] for Smile Shutter during movie recording.
- When the  (Movie Mode) is set and the camera is on [Standby], you cannot use [Smile Shutter].

[▲ Back to top](#)

[Top page](#) > [Shooting](#) > [Selecting the shooting mode based on the subject](#) > [List of mode dial functions](#)

- ▶ Before Use
- ▶ Operating the camera
- ▶ Shooting
- ▶ Viewing
- ▶ Useful shooting functions
- ▶ Useful viewing functions
- ▶ Changing settings
- ▶ Viewing images on a TV
- ▶ Using with your computer
- ▶ Printing
- ▶ Troubleshooting
- ▶ Precautions / About this camera

[⇒ Contents list](#)

List of mode dial functions

Set the mode dial to the desired function.

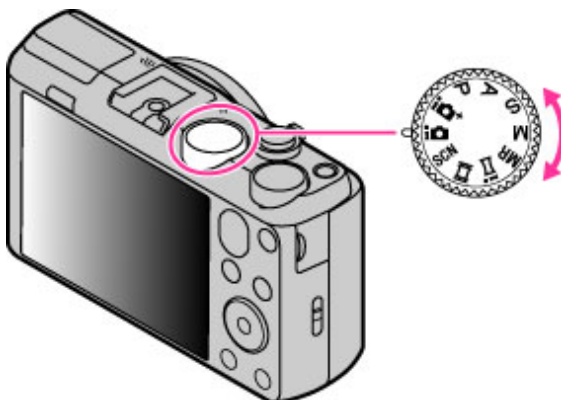

iA (Intelligent Auto)	Allows you to shoot still images with the settings adjusted automatically.
iA+ (Superior Auto)	Allows you to shoot still images in higher quality than with Intelligent Auto mode.
P (Program Auto)	Allows you to shoot with the exposure adjusted automatically (both the shutter speed and the aperture value (F value)). Also you can select various settings using the menu.
S (Shutter Speed Priority Shooting)	Allows you to shoot after adjusting the shutter speed manually.
A (Aperture Priority Shooting)	Allows you to shoot after adjusting the aperture value (F value) manually.
M (Manual Exposure Shooting)	Allows you to shoot after adjusting the exposure manually (both the shutter speed and the aperture (F value)).
MR (Memory recall mode)	Allows you to shoot an image after recalling often-used modes or numeric settings registered in advance.
iA (iSweep Panorama)	Allows you to shoot a panorama image after composing images.
[Movie Icon] (Movie Mode)	Allows you to change the setting for movie recording.
SCN (Scene Selection)	Allows you to shoot with preset settings according to the scene.

Related Topic

Intelligent Auto
Superior Auto
Program Auto
Shutter Speed Priority Shooting
Aperture Priority Shooting
Manual Exposure Shooting
Memory recall mode
Intelligent Sweep Panorama
Shooting movies
Scene Selection

[▲ Back to top](#)

Copyright 2013 Sony Corporation

- ▶ Before Use
- ▶ Operating the camera
- ▶ Shooting
- ▶ Viewing
- ▶ Useful shooting functions
- ▶ Useful viewing functions
- ▶ Changing settings
- ▶ Viewing images on a TV
- ▶ Using with your computer
- ▶ Printing
- ▶ Troubleshooting
- ▶ Precautions / About this camera

[➡ Contents list](#)

Intelligent Auto

Allows you to shoot still images with the setting adjusted automatically.

1. Set the mode dial to  (Intelligent Auto).
2. Shoot with the shutter button.

On Scene Recognition



Scene Recognition operates in Intelligent Auto mode. This function lets the camera automatically recognize the shooting conditions and shoot the image.



Features of Auto shooting modes

In Superior Auto mode, the camera shoots a higher-quality image than in Intelligent Auto mode. The camera also shoots multiple images based on the recognized scene, then creates a composite of the multiple images (Overlay shooting).

Program Auto mode allows you to change various shooting settings, such as the white balance or ISO settings.

REC Mode	When to use	Major restricted functions
 (Intelligent Auto)	<ul style="list-style-type: none"> ● Use when you want the camera to automatically recognize the shooting conditions and shoot some images continuously. 	Forced flash
 (Superior Auto)	<ul style="list-style-type: none"> ● Use when you shoot images under difficult conditions, such as low light or backlit scenes. ● Use when you want to shoot a higher-quality image than in  mode. 	Forced flash, Continuous shooting, Smile Shutter
P (Program Auto)	<ul style="list-style-type: none"> ● Use when you want to shoot using customized shooting settings except the exposure (both the shutter speed and the aperture value) adjusted automatically. 	Scene Recognition

Notes

- In [Intelligent Auto] mode, you may be unable to shoot low light or backlit scenes clearly.
- In [Superior Auto] mode, it takes some time to record an image, because the camera overlays the images.

Related Topic

[Advanced mode](#)

[Functions available for each shooting mode](#)

[MENU items available for each shooting mode](#)

[▲ Back to top](#)

Copyright 2013 Sony Corporation

- ▶ Before Use
- ▶ Operating the camera
- ▶ Shooting
- ▶ Viewing
- ▶ Useful shooting functions
- ▶ Useful viewing functions
- ▶ Changing settings
- ▶ Viewing images on a TV
- ▶ Using with your computer
- ▶ Printing
- ▶ Troubleshooting
- ▶ Precautions / About this camera

[⇒ Contents list](#)

Superior Auto

The camera combines Scene Recognition and high-quality image technology to automatically shoot the images with the optimal settings.

1. Set the mode dial to  (Superior Auto).
2. Shoot with the shutter button.

The camera shoots burst images when needed and overlays the multiple images. By overlaying the images, the camera records an image with less subject blur and noises.







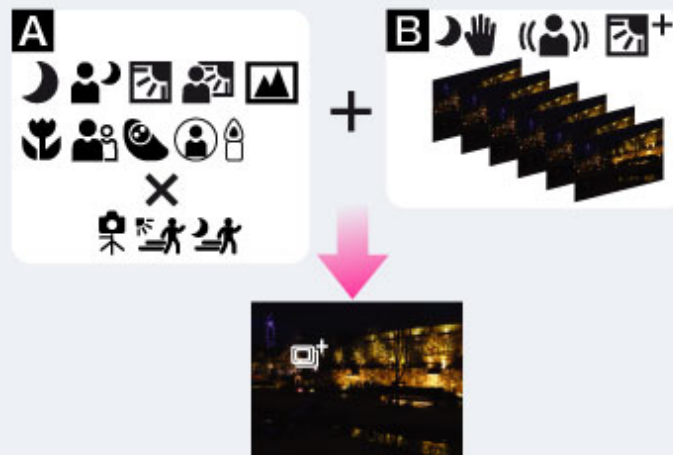

What is the difference between Superior Auto mode and Intelligent Auto mode?

In Superior Auto mode, the camera shoots burst images based on the recognized scene, then creates a composite of the burst images (Overlay shooting).



The camera automatically corrects the backlight and reduces the noise by overlaying images, so a higher-quality image results than in Intelligent Auto mode.



A : Scene Recognition

-  Night Scene
-  Night Portrait
-  Backlight
-  Backlight Portrait
-  Landscape
-  Macro
-  Portrait
-  Infant
-  Spotlight
-  Low Light
-  Tripod
-  Move (Bright)
-  Move (Dark)

B : Overlaying processing

-  Hand-held Twilight
-  Anti Motion Blur

Backlight Correction HDR

- The camera automatically selects an overlaying mode based on the recognized scene, and the  (overlay) appears on the screen.

Notes

- When the camera overlays the images, it takes more time to record an image.
- In low light conditions such as night scenes, set [Flash] to [Off] to achieve the optimal effect of the overlaid images.

Related Topic

[Scene Recognition](#)

[Functions available for each shooting mode](#)

[MENU items available for each shooting mode](#)

[▲ Back to top](#)

Copyright 2013 Sony Corporation

[Top page](#) > [Shooting](#) > [Selecting the shooting mode based on the subject](#) > [Background Defocus](#)

- ▶ Before Use
- ▶ Operating the camera
- ▶ Shooting
- ▶ Viewing
- ▶ Useful shooting functions
- ▶ Useful viewing functions
- ▶ Changing settings
- ▶ Viewing images on a TV
- ▶ Using with your computer
- ▶ Printing
- ▶ Troubleshooting
- ▶ Precautions / About this camera

[➔ Contents list](#)

Background Defocus

Allows you to shoot an image with image processing so that the background and the subject stands out.



1. Set the mode dial to **SCN** (Scene Selection).
2. Turn the control wheel to select  (Background Defocus). [\[Details\]](#)
3. Shoot with the shutter button.

Tips for adjusting the intensity of the background defocus

- Before shooting, select MENU → [Defocus Effect] → [High], [Mid] or [Low] to change the intensity of the background defocus effect.

Tips for defocusing the background

Position of the subject and the background

If you shoot an image with the subject and background far apart, as shown in the illustration, the background can be defocused. Shoot from the recommended shooting distance indicated on the screen.

Subject is sufficiently removed from the background

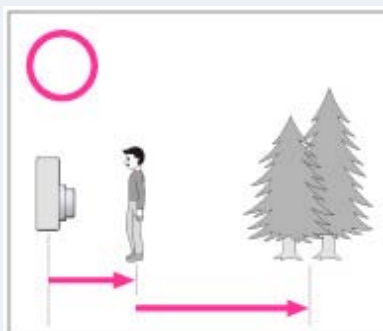

Subject and background are too close

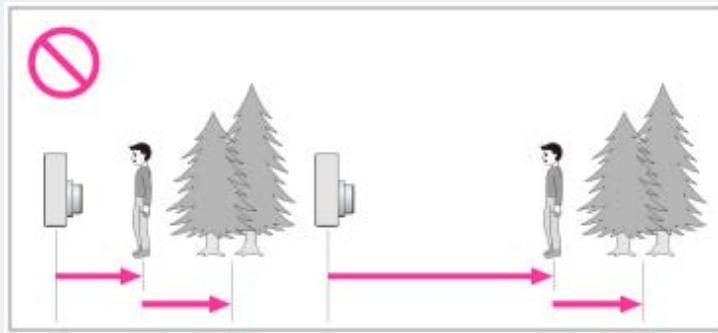

Zoom scale and position of the subject

When you shoot a flower and a small item from close up, turn the W/T (zoom) lever to the W side. For shooting people, move a short distance away from the subject and turn the W/T (zoom) lever to the T side.



- To lock the focus on the subject more easily, use the Tracking focus function of the camera. [\[Details\]](#)

Notes

- When shooting, hold the camera still to reduce camera shake.
- If you are unable to defocus effectively, try the following steps:
 - Turn the W/T (zoom) lever to the T side.
 - Approach the subject until you are within the recommended shooting distance.
 - Separate the subject and the background.
 - Shoot after focusing on the subject.

Related Topic

[Defocus Effect](#)

[Tracking focus](#)

[Functions available for each shooting mode](#)

[MENU items available for each shooting mode](#)

[▲ Back to top](#)

[Top page](#) > [Shooting](#) > [Selecting the shooting mode based on the subject](#) > [Program Auto](#)

- ▶ [Before Use](#)
- ▶ [Operating the camera](#)
- ▶ [Shooting](#)
- ▶ [Viewing](#)
- ▶ [Useful shooting functions](#)
- ▶ [Useful viewing functions](#)
- ▶ [Changing settings](#)
- ▶ [Viewing images on a TV](#)
- ▶ [Using with your computer](#)
- ▶ [Printing](#)
- ▶ [Troubleshooting](#)
- ▶ [Precautions / About this camera](#)

[⇒ Contents list](#)

Program Auto

Allows you to shoot with the exposure adjusted automatically (both the shutter speed and the aperture value). Also you can select various settings using the menu.

1. Set the mode dial to **P** (Program Auto).
2. Shoot with the shutter button.

Related Topic

[Functions available for each shooting mode](#)

[MENU items available for each shooting mode](#)

[▲ Back to top](#)

[▶ Before Use](#)[▶ Operating the camera](#)[▶ Shooting](#)[▶ Viewing](#)[▶ Useful shooting functions](#)[▶ Useful viewing functions](#)[▶ Changing settings](#)[▶ Viewing images on a TV](#)[▶ Using with your computer](#)[▶ Printing](#)[▶ Troubleshooting](#)[▶ Precautions / About this camera](#)[➔ Contents list](#)

3D Still Image

Shooting a 3D image. Images recorded using the 3D functions can be played back stereoscopically on a 3D TV.

1. Set the mode dial to **SCN** (Scene Selection).
2. Turn the control wheel to select **3D** (3D Still Image). [\[Details\]](#)
3. Shoot with the shutter button.

Tips for shooting 3D images

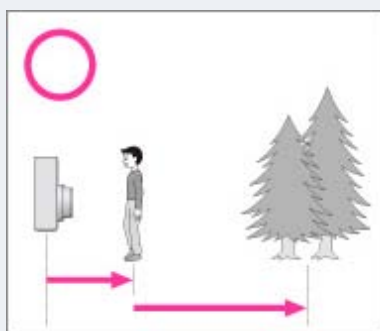

Approach a subject with the subject and background far apart, as shown in the illustration. The 3D effect may not work effectively when the scene is too dark, the subject is moving or you moved the camera after setting the AE/AF lock. If you shoot the image in a dark place, noise may be highly visible.

Notes

- Available image sizes are [20M] and [16:9(15M)].
- The 3D images are played back as standard still images on this camera.

Related Topic

[Functions available for each shooting mode](#)[MENU items available for each shooting mode](#)[Viewing 3D images on a 3D TV](#)[▲ Back to top](#)

[Top page](#) > [Shooting](#) > [Selecting the shooting mode based on the subject](#) > [Intelligent Sweep Panorama](#)

▶ Before Use
▶ Operating the camera
▶ Shooting
▶ Viewing
▶ Useful shooting functions
▶ Useful viewing functions
▶ Changing settings
▶ Viewing images on a TV
▶ Using with your computer
▶ Printing
▶ Troubleshooting
▶ Precautions / About this camera

[→ Contents list](#)

Intelligent Sweep Panorama

Allows you to create a panoramic image from composite images. The camera also automatically detects people's faces or moving subjects.



1. Set the mode dial to  (iSweep Panorama).
2. Select a shooting direction.
3. Align the camera with the end of the subject to be shot and press the shutter button fully.



A: This part will not be recorded.

4. Pan the camera to the end of the guide (**B**), following the indication on the screen.



Tips for shooting a panorama image

Pan the camera in an arc at a constant velocity in the direction indicated on the screen. Subjects at rest are more suited for panorama shots than moving subjects.
Radius as short as possible.

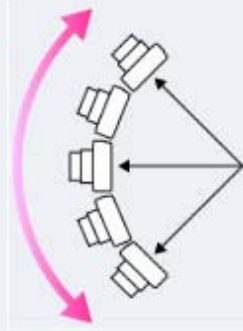

Vertical direction

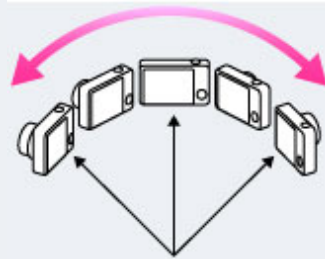

Horizontal direction

- First, press the shutter button halfway so that you can lock the focus and exposure. Then, press the shutter button fully down and pan or tilt the camera.
- If a section with greatly varied shapes or scenery is concentrated along a screen edge, the image composition may fail. In such case, adjust the frame composition so that the section is in the center of the image, then shoot again.

To shoot a 360 degree panoramic image

This camera is equipped with a panorama shooting function, capable of shooting a near-full 360 degree panoramic image.

Shoot a panoramic image by selecting MENU → set [Panorama Image Size] to [360°]. Recorded panoramic images can be scrolled accurately when played on the camera.

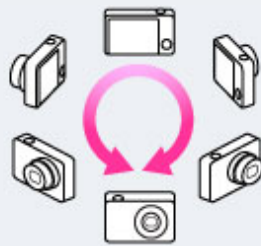

- Select a shooting direction with ◀ / ▶ . You cannot shoot a panoramic image in a vertical direction with [Panorama Image Size] set to [360°].
- The image actually recorded may not cover 360 degrees, depending on the subject or the way it is shot.

Notes

- If you cannot pan the camera across the entire subject within the given time, a gray area occurs in the composite image. If this happens, move the camera faster to record a full panorama image.
- Since several images are stitched together, the stitched part will not be recorded smoothly.
- When the whole angle of panoramic shooting and the AE/AF locked angle are very different in brightness, color and focus, the shooting will not be successful. If this happens, change AE/AF locked angle and shoot again.
- You cannot create panorama images in the following situations:
 - You pan the camera too quickly or too slowly.

– There is too much camera shake.

Related Topic

[Scrolling the panorama images for display](#)

[Still Image Size/Panorama Image Size](#)

[Functions available for each shooting mode](#)

[MENU items available for each shooting mode](#)

[Panorama Shooting Scene](#)

[Picture Effect](#)

[▲ Back to top](#)

Copyright 2013 Sony Corporation









- ▶ Before Use
- ▶ Operating the camera
- ▶ Shooting
- ▶ Viewing
- ▶ Useful shooting functions
- ▶ Useful viewing functions
- ▶ Changing settings
- ▶ Viewing images on a TV
- ▶ Using with your computer
- ▶ Printing
- ▶ Troubleshooting
- ▶ Precautions / About this camera











[⇒ Contents list](#)

Picture Effect

Allows you to shoot a still image with an original texture according to the desired effect.

1. Set the mode dial to **P** (Program Auto), **S** (Shutter Speed Priority Shooting), **A** (Aperture Priority Shooting) or **M** (Manual Exposure Shooting).
2. MENU →  (Picture Effect) → desired mode → ●
 - If you want to select other Picture Effect mode, select from MENU.
 - If you want to add an effect to a movie, press the MOVIE (Movie) button after selecting the desired effect.

 (Off)	Does not use the Picture Effect.
 (HDR Painting)	Allows you to shoot multiple images with different exposures to create a single image that looks like an oil painting. You can change the effect level using MENU → [HDR Painting effect]. 
 (Rich-tone Monochrome)	Allows you to shoot multiple images with different exposures to create a single, sharp monochrome image. 
 (Miniature)	Allows an image to be processed so that it looks as though you were shooting dioramas. The image is blurred except one part, for a high-contrast image. You can select a part to be not blurred by using MENU → [Area of emphasis]. 
	Allows you to shoot images with effects such as tunnel effect, high contrast, or color cast as if they were shot with a toy camera. You can change the color hue using MENU → [Color hue].

(Toy camera)	
 (Pop Color)	<p>Allows you to shoot a pop art-like colorful image with emphasis on the color tone.</p> 
 (Partial Color)	<p>Allows you to shoot an image that makes a strong impression by leaving a specified color on portions of a monochrome image. You can select the color to extract using MENU → [Extracted Color].</p> 
 (Soft High-key)	<p>Allows you to shoot soft, clear images with an emphasis on brightness.</p> 
 (Watercolor)	<p>Allows you to shoot an image with ink bleed and blurring effects as if it painted with watercolors.</p> 
 (Illustration)	<p>Allows you to shoot an illustration-like image by emphasizing the outlines. You can change the effect level using MENU → [Illustration Effect].</p> 

 **To add an effect when shooting panoramic image**

- If you set MENU → [Panorama Shooting Scene] → [Picture Effect] → desired mode, the following Picture Effect modes are effective:
 - [Pop Color]

- [Partial Color]
- [Soft High-key]

To add an effect to a movie

- The following Picture Effect modes are effective for movies. The Dual Rec function cannot be used.
 - [Toy camera]
 - [Pop Color]
 - [Partial Color]
 - [Soft High-key]
- When the mode dial is set to  (Movie Mode), you cannot set the Picture Effect.

Related Topic

[HDR Painting effect](#)

[Area of emphasis](#)

[Color hue](#)

[Extracted Color](#)

[Illustration Effect](#)

[Functions available for each shooting mode](#)

[MENU items available for each shooting mode](#)

[Panorama Shooting Scene](#)

[▲ Back to top](#)

Copyright 2013 Sony Corporation

- ▶ Before Use
- ▶ Operating the camera
- ▶ Shooting
- ▶ Viewing
- ▶ Useful shooting functions
- ▶ Useful viewing functions
- ▶ Changing settings
- ▶ Viewing images on a TV
- ▶ Using with your computer
- ▶ Printing
- ▶ Troubleshooting
- ▶ Precautions / About this camera

[⇒ Contents list](#)



Scene Selection

Allows you to shoot with preset settings according to the scene.









For still images:















1. Set the mode dial to **SCN** (Scene Selection).
2. Select the desired mode.













For movies:

1. Set the mode dial to  (Movie Mode).
2. MENU →  (Movie shooting scene) → **SCN** (Scene Selection) → ●
3. Select the desired mode.



Scene Selection modes with an * mark are not available for [Scene Selection] in [Movie shooting scene].

 (Soft Skin)*	Allows you to shoot faces for smoothness. 
 (Background Defocus)*	Allows you to shoot an image with background defocus and define the subject. 
 (Soft Snap)	Allows you to shoot images with a softer atmosphere for portraits and flowers, etc. 
 (Anti Motion Blur)*	Allows you to shoot indoor shots without using the flash to reduce subject blur. 
	Allows easy shooting of distant scenes by focusing in the distance. Shoots the clear sky and trees and flowers in vivid colors.

 (Landscape)	
 (Backlight Correction HDR)*	Allows you to shoot three images having different exposures to create a single image with a greater range of gradation. 
 (Night Portrait)*	Allows you to shoot sharp images of people with the night view in the background without compromising the atmosphere. <ul style="list-style-type: none"> Press the  (flash pop-up) button to pop up the flash unit. 
 (Night Scene)	Allows you to shoot night scenes at far distance without losing the dark atmosphere of the surroundings. 
 (Hand-held Twilight)*	Allows you to shoot night scenes with less noise without using a tripod. 
 (High Sensitivity)	For still images, allows you to shoot images without a flash under low light conditions, reducing blur. For movies, allows you to record low light scenes with more brightness. 
 (Gourmet)*	Allows you to shoot food arrangements in delicious and bright color.

	
 (Pet)*	<p>Allows you to shoot images of your pet with the best settings.</p> 
 (Beach)	<p>Allows you to shoot scenes on the beach in bright and vivid colors even under the sunlight.</p> 
 (Snow)	<p>Allows you to record clear images preventing sunken colors in snowy scenes or other places where the whole screen appears white.</p> 
 (Fireworks)	<p>Allows you to record fireworks in all their splendor.</p> 
 (Advanced Sports Shooting)*	<p>Allows you to shoot subjects with fast movements such as sports. While the shutter is pressed halfway, the movement of the subject is predicted and the focus will be adjusted.</p> 
 (3D Still Image)*	<p>Allows you to shoot 3D images. Images recorded using the 3D functions can be played back stereoscopically on a 3D TV.</p>

**Notes**

- When you shoot images using  (Night Portrait),  (Night Scene) or  (Fireworks) mode, the shutter speed is slower and the images tend to blur. To prevent blurring, the use of a tripod is recommended.

Related Topic

[Functions available for each shooting mode](#)

[MENU items available for each shooting mode](#)

[▲ Back to top](#)

Copyright 2013 Sony Corporation

- ▶ Before Use
- ▶ Operating the camera
- ▶ Shooting
- ▶ Viewing
- ▶ Useful shooting functions
- ▶ Useful viewing functions
- ▶ Changing settings
- ▶ Viewing images on a TV
- ▶ Using with your computer
- ▶ Printing
- ▶ Troubleshooting
- ▶ Precautions / About this camera

[➡ Contents list](#)

[Top page](#) > [Shooting](#) > [Selecting the shooting mode based on the subject](#) > [Shutter Speed Priority Shooting](#)

Shutter Speed Priority Shooting

You can shoot still images after adjusting the shutter speed manually.

1. Set the mode dial to **S** (Shutter Speed Priority Shooting).
2. Press **●** on the control wheel.
3. Turn the control wheel to select the shutter speed value.



- You can select a shutter speed from 1/1600 to 30 seconds.
- You can set the ISO setting with **●** on the control wheel.

4. Shoot with the shutter button.

Notes

- When the shutter speed is fast, the amount of flash light may be insufficient even if you fire the flash.
- If the proper exposure is not obtained after making the settings, the setting value indicators on the screen flash when the shutter button is pressed halfway down. You can shoot in this condition, but we recommend that you adjust the flashing values again.
- If the ISO sensitivity is set to 6400 or 12800 or higher, you cannot use a shutter speed slower than 1/4 second. To use a shutter speed slower than 1/4 second, set the ISO sensitivity to 3200 or less.

About the shutter speed



When you set the shutter speed faster, moving objects such as running people, cars or splashing water, etc., appear stopped.



When you set the shutter speed slower, the traces of moving objects such as a river current etc., appear. You can shoot more natural live action images.

Related Topic

[Functions available for each shooting mode](#)

[MENU items available for each shooting mode](#)

[▲ Back to top](#)

Copyright 2013 Sony Corporation

- ▶ Before Use
- ▶ Operating the camera
- ▶ Shooting
- ▶ Viewing
- ▶ Useful shooting functions
- ▶ Useful viewing functions
- ▶ Changing settings
- ▶ Viewing images on a TV
- ▶ Using with your computer
- ▶ Printing
- ▶ Troubleshooting
- ▶ Precautions / About this camera

[⇒ Contents list](#)

Aperture Priority Shooting

You can manually adjust the amount of light that passes through the lens.

1. Set the mode dial to **A** (Aperture Priority Shooting).
2. Press **●** on the control wheel.
3. Turn the control wheel to select the aperture (F value).



- You can select an aperture (F value) from F 3.5 to F 8.0. (When you turn the W/T (zoom) lever to T side, the minimum aperture (F value) will increase.)
- The shutter speed is automatically adjusted from 1/1600 to 8 seconds.
- You can set the ISO setting with **●** on the control wheel.

4. Shoot with the shutter button.

Notes

- If the proper exposure is not obtained after making the settings, the setting value indicators on the screen flash when the shutter button is pressed halfway down. You can shoot in this condition, but we recommend that you adjust the flashing values again.

About the aperture priority



The lower the aperture (F value), the wider the hole that lets light pass through. The depth of focus decreases, and everything except objects within a narrow range of distance will be out of focus. This is good for portraits, etc.



The higher the aperture (F value), the smaller the hole that lets light pass through. Both objects relatively close and far away from the lens will appear sharp. This is good for landscapes, etc.

Related Topic

[Functions available for each shooting mode](#)

[MENU items available for each shooting mode](#)

[▲ Back to top](#)

Copyright 2013 Sony Corporation

- ▶ Before Use
- ▶ Operating the camera
- ▶ Shooting
- ▶ Viewing
- ▶ Useful shooting functions
- ▶ Useful viewing functions
- ▶ Changing settings
- ▶ Viewing images on a TV
- ▶ Using with your computer
- ▶ Printing
- ▶ Troubleshooting
- ▶ Precautions / About this camera

[➡ Contents list](#)

[Top page](#) > [Shooting](#) > [Selecting the shooting mode based on the subject](#) > [Manual Exposure Shooting](#)

Manual Exposure Shooting

You can shoot at your favorite exposure by manually setting the shutter speed and aperture value.

1. Set the mode dial to **M** (Manual Exposure Shooting).
2. Press **●** on the control wheel to select the shutter speed, aperture (F value) or ISO speed.
 - Each time you press the center of the control wheel, the item to be set will change.
 - When you want to set the focus, you can also select MENU → [Focus] and select **AF** (Flexible Spot AF), **S** (Semi Manual) or **M** (Manual Focus).
 - When shooting in Manual Exposure Shooting mode with Smile Shutter [On], **●** on the control wheel is used for Tracking focus. Settings such as the shutter speed, aperture (F value), focus and ISO cannot be adjusted.
3. Turn the control wheel to select a value.
4. Press the shutter button to shoot the image.

Setting the shutter speed and aperture (F value)

The difference between the settings and proper exposure judged by the camera appears as an Exposure Compensation value on screen.



A: Shutter speed value

B: Aperture value

C: Exposure Compensation value

- 0EV is the value judged as the most suitable by the camera.
- When the shutter speed is one second or slower, the shutter speed is indicated by ["], for example, [1"].
- When you set the shutter speed slower, using a tripod is recommended to prevent the effects of vibration.
- When the shutter speed becomes slower than a certain speed, the NR slow shutter function is activated automatically to reduce image noise, and **NR** appears on the screen.
- If you select slow shutter speeds, it takes time to process the data.

Notes

- [Auto] cannot be selected for [ISO] in Manual Exposure Shooting mode.
- If proper exposure is not obtained by your settings, the setting value indicators on the screen will flash when the shutter button is pressed halfway down. You can shoot in this condition, but exposure readjustment is recommended.
- If the ISO sensitivity is set to 6400 or 12800, you cannot use a shutter speed slower than 1/4 second. To use a shutter speed slower than 1/4 second, set the ISO sensitivity to 3200 or less.

Related Topic

[Functions available for each shooting mode](#)

[MENU items available for each shooting mode](#)

[▲ Back to top](#)

Copyright 2013 Sony Corporation

- ▶ Before Use
- ▶ Operating the camera
- ▶ Shooting
- ▶ Viewing
- ▶ Useful shooting functions
- ▶ Useful viewing functions
- ▶ Changing settings
- ▶ Viewing images on a TV
- ▶ Using with your computer
- ▶ Printing
- ▶ Troubleshooting
- ▶ Precautions / About this camera

[⇒ Contents list](#)

Memory recall mode

Allows you to shoot an image after recalling often-used modes or camera settings registered in advance.

1. Set the mode dial to **MR** (Memory recall mode).

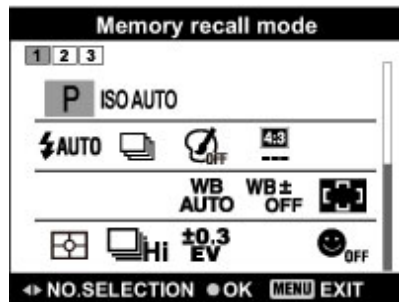

2. Press **◀ / ▶** to select the desired number → **●**.

Notes

- Register shooting settings in advance by **MR^{SET}** (Register Setting). [\[Details\]](#)
- If you set **MR** (Memory recall mode) after completing the shooting settings, the registered settings are given priority and the original settings may become invalid. Check the indicators on the screen before shooting.

Related Topic

[Register Setting](#)

[Functions available for each shooting mode](#)

[MENU items available for each shooting mode](#)

[▲ Back to top](#)

- ▶ Before Use
- ▶ Operating the camera
- ▶ Shooting
- ▶ Viewing
- ▶ Useful shooting functions
- ▶ Useful viewing functions
- ▶ Changing settings
- ▶ Viewing images on a TV
- ▶ Using with your computer
- ▶ Printing
- ▶ Troubleshooting
- ▶ Precautions / About this camera

[➡ Contents list](#)

Viewing still images

1. Switch to playback mode.
2. Select an image.

Viewing images taken with a different camera

If you insert a memory card which has images taken with a different camera, registration screen with the message “Files found which were not recognized Import files” will be displayed.
To view unregistered images, register them by selecting [OK].

Viewing vertical images in full-screen display

If the camera is rotated, the horizontal or vertical orientation of the image is determined and the image being played back is automatically rotated.

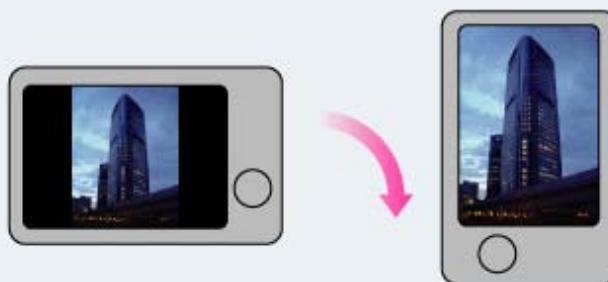

[▲ Back to top](#)

- ▶ Before Use
- ▶ Operating the camera
- ▶ Shooting
- ▶ Viewing
- ▶ Useful shooting functions
- ▶ Useful viewing functions
- ▶ Changing settings
- ▶ Viewing images on a TV
- ▶ Using with your computer
- ▶ Printing
- ▶ Troubleshooting
- ▶ Precautions / About this camera

[→ Contents list](#)

Playback zoom

Enlarges the image being played back.

1. Switch to playback mode.
2. Turn the W/T (zoom) lever to T side (Q) during still image playback.
3. Adjust the position using ▲ / ▼ / ◀ / ▶ .

The frame in the lower left of the image shows which part of the total image is being displayed.



4. Change the zoom scale with the W/T (zoom) lever.
Turn the W/T (zoom) lever to T side (Q) to zoom in, W side (Q) to zoom out.

To save enlarged images

You can save an enlarged image by using the trimming function.
Press MENU → [Retouch] → [Trimming (Resize)].

[▲ Back to top](#)

- ▶ Before Use
- ▶ Operating the camera
- ▶ Shooting
- ▶ Viewing
- ▶ Useful shooting functions
- ▶ Useful viewing functions
- ▶ Changing settings
- ▶ Viewing images on a TV
- ▶ Using with your computer
- ▶ Printing
- ▶ Troubleshooting
- ▶ Precautions / About this camera

[→ Contents list](#)

Image Index

Displays multiple images at the same time.

1. Switch to playback mode.
2. Turn the W/T (zoom) lever to the W side () to display the image index screen.
Turn the lever again to display an index screen with more images.

Displaying images of the desired date/folder

Select the left side bar, then select the desired date range or folder using ▲ / ▼ .





Viewing images with the Calendar

When [View Mode] is set to [Date View] and the screen display is in index mode, turn the W/T (zoom) lever to W side () to view images with the Calendar.



▲ / ▼ / ◀ / ▶ : Moves the selection frame to a different date.

⌋ : Displays the calendar of the next/previous month.

- To select the month you want to display, select  / , then the desired month.
- To view images in selected date in index mode, select the date and press ● .
- To cancel the calendar display and return to an index screen, select , then press ● .

[▲ Back to top](#)

- ▶ Before Use
- ▶ Operating the camera
- ▶ Shooting
- ▶ Viewing
- ▶ Useful shooting functions
- ▶ Useful viewing functions
- ▶ Changing settings
- ▶ Viewing images on a TV
- ▶ Using with your computer
- ▶ Printing
- ▶ Troubleshooting
- ▶ Precautions / About this camera

[⇒ Contents list](#)

Deleting images



Allows you to select unwanted images for deletion.

You can also delete images from the MENU button. [\[Details\]](#)

1. Switch to playback mode.
2.  (Delete) button → desired mode → ●
3. Press [OK] → ● .

All Images on This Date All in This Folder All AVCHD view files	Deletes all still images and movies in the selected date range or folder, or all AVCHD movies.
Multiple Images	Allows you to select and delete multiple images. ① After step 2, select an image to be deleted, then press ● . To cancel the selection, press ● again to cancel the ✓ mark. ② MENU → [OK] → ●
This Image	Deletes the currently displayed image.
All Imgs in This Cnt.Sht. Grp.	Deletes all images in the selected burst group at once.
All but This Image	Deletes all images in a burst group except the selected image in Display Cont. Shooting Group mode.
Cancel	Cancels the deletion.

You can switch between index and single-image mode when selecting images

Turn the W/T (zoom) lever to the T side () in index mode to return to single-image mode, and turn the lever to the W side () in single-image mode to return to index mode.



Notes

- When the internal memory is used to record images, View Mode is set to Folder View.
- To delete images in the internal memory, remove the memory card.

Related Topic

[Delete](#)

- ▶ Before Use
- ▶ Operating the camera
- ▶ Shooting
- ▶ Viewing
- ▶ Useful shooting functions
- ▶ Useful viewing functions
- ▶ Changing settings
- ▶ Viewing images on a TV
- ▶ Using with your computer
- ▶ Printing
- ▶ Troubleshooting
- ▶ Precautions / About this camera

[➔ Contents list](#)

Viewing burst images

- ▼ Tilt playback
- ▼ Unfold

You can select the playback method for continuous (burst) shots when [View Mode] is set to [Date View] and [Display Cont. Shooting Group] is set to [Display Main Image Only].

[View Mode] is set to [Date View] and [Display Cont. Shooting Group] is set to [Display Main Image Only] in its default setting.

1. Switch to playback mode.
2. Select the burst images then operate as following.



Operation	Action
●	Tilt playback
▶	Next image
◀	Previous image
▼	Unfold

● Tilt playback

The burst shots are played back smoothly as a movie.

1. Press ● to enter the Tilt playback screen.
2. Tilt the camera to the right or left, with the center of the camera as the axis.

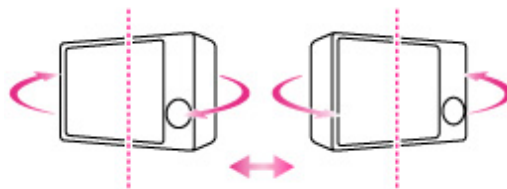

3. To exit Tilt playback, execute any operation, such as pressing ●.

▼ Unfold

The thumbnails of a series of burst shots are displayed on the bottom of the screen. A selected image is enlarged.

1. Press ▼ to unfold the burst shots.

A series of burst shots are displayed in an index.



When images are displayed in an index,  is displayed on the main image.

2. Press ◀ / ▶ to display each image in a burst group.
3. Switch the display between single-image display and index display by pressing ● .
4. To cancel the display, press ▼ .

Related Topic

[View Mode](#)

[Display Cont. Shooting Group](#)

[▲ Back to top](#)

Copyright 2013 Sony Corporation

- ▶ Before Use
- ▶ Operating the camera
- ▶ Shooting
- ▶ Viewing
- ▶ Useful shooting functions
- ▶ Useful viewing functions
- ▶ Changing settings
- ▶ Viewing images on a TV
- ▶ Using with your computer
- ▶ Printing
- ▶ Troubleshooting
- ▶ Precautions / About this camera

[→ Contents list](#)

Viewing movies

- ▼ [Displaying the control panel](#)
- ▼ [Capture a still image from a movie](#)

1. Switch to playback mode.
2. Select a movie.
3. Press ● .
Movie playback starts.

On the movie viewing screen

Select the image you want to display using ◀ / ▶ , and press ● .
The Playback bar appears, you can check a playback position of a movie.



The icon displayed may vary depending on image size and quality.



Operation	Action during playback
●	Stop
▶	Fast forward
◀	Fast rewind
⌋	Frame advance/Frame rewind
▼	Displays the control panel

To display only movies on the index screen

You can view only movie thumbnails on the index screen by pressing MENU → (View Mode) →

MP4 (Folder view (MP4)) or AVCHD (AVCHD view).

MP4 (Folder view (MP4)): Displays MP4-format movie thumbnails on the index screen.

AVCHD (AVCHD view): Displays AVCHD-format movie thumbnails on the index screen.

- When a movie file is played back to the end, the camera automatically starts playing back the next movie file.

Notes

- You may not be able to play back some images shot using other cameras.

Displaying the control panel

Display the control panel, you can control slow movie playback and adjust the volume.

1. Press **▼** .
The control panel appears.
2. Select a desired button with **◀ / ▶** , and press **●** .







Control panel	Action
▶	Playback
⏸	Pause
⏩	Fast forward
⏪	Fast rewind
⏮	Slow playback
⏭	Slow rewind playback
⏴	Chapter advance
⏴	Chapter rewind
⏴	Frame advance
⏴	Frame rewind
📷	Photo Capture
🔊	Volume settings
✕	Closes the control panel

Notes

- The buttons on the control panel will vary depending on the playback status.

Capture a still image from a movie

1. Press  during the scene you want to capture.
2. Select  using  / , then press  .
 - When the still image has been recorded, the camera will pause.
 - When the movie format is [MP4 3M], a still image is saved in [VGA]. Otherwise, the still image is saved in [16:9(2M)].

Related Topic

[View Mode](#)

[▲ Back to top](#)

Copyright 2013 Sony Corporation

- ▶ Before Use
- ▶ Operating the camera
- ▶ Shooting
- ▶ Viewing
- ▶ Useful shooting functions
- ▶ Useful viewing functions
- ▶ Changing settings
- ▶ Viewing images on a TV
- ▶ Using with your computer
- ▶ Printing
- ▶ Troubleshooting
- ▶ Precautions / About this camera

[➔ Contents list](#)

Scrolling the panorama images for display

You can scroll panorama images by pressing the center button while panorama images are being displayed.



A: Shows the displayed area of the whole panorama image



Control wheel	Action
●	Starts scrolling playback/pauses scrolling playback
⤵	Scrolls images

- Panorama images recorded using another camera may not scroll correctly when played.
- Turn the W/T (zoom) lever to the W side to display the whole image again.

Notes

- A panoramic image recorded in [High Resolution] size requires a longer time to scroll than a normal size panoramic image.

Related Topic

[Still Image Size/Panorama Image Size](#)

[▲ Back to top](#)

- ▶ Before Use
- ▶ Operating the camera
- ▶ Shooting
- ▶ Viewing
- ▶ Useful shooting functions
- ▶ Useful viewing functions
- ▶ Changing settings
- ▶ Viewing images on a TV
- ▶ Using with your computer
- ▶ Printing
- ▶ Troubleshooting
- ▶ Precautions / About this camera

[→ Contents list](#)

Functions available for each shooting mode





























- ▼ Functions available in REC modes
- ▼ Functions available in Scene Selection
- ▼ Functions available in Picture Effect

In the table below, a check mark indicates a function that can be changed, while — indicates function that cannot be changed.

The icons below [Self-Timer] and [Flash] indicate the available modes.

When the shooting modes below are registered and recalled in **MR** (Memory recall mode), the conditions for whether settings can be changed or not remain the same as in the table below.

Functions available in REC modes

	Flash	Face Detection	Tracking focus	Self-Timer	Continuous Shooting/Bracket	Exposure Compensation	Photo Creativity
 (Intelligent Auto)	  	✓	✓	    	✓*	—	✓
 (Superior Auto)	  	✓	✓	    	—	—	✓
P (Program Auto)	  	✓	✓	✓	✓	✓	—
S (Shutter Speed Priority Shooting)	 	✓	—	✓	✓	✓	—
A (Aperture Priority Shooting)	 	✓	—	✓	✓	✓	—
M (Manual Exposure Shooting)	 	✓	—	✓	✓	—	—
 (iSweep Panorama)		—	—	—	—	✓	—

* [Bracket] cannot be selected.

Functions available in Scene Selection

	Flash	Face Detection	Tracking focus	Self-Timer	Continuous Shooting/Bracket	Exposure Compensation
(Soft Skin)	AUTO	✓*	✓	✓	✓	—
(Defocus Effect)		✓*	✓		—	—
(Soft Snap)	AUTO	✓*	✓	✓	✓	—
(Anti Motion Blur)		✓	✓		—	—
(Landscape)		—	—		✓	—
(Backlight Correction HDR)		✓	✓		—	—
(Night Portrait)	SL	✓	✓		—	—
(Night Scene)		—	—		—	—
(Hand-held Twilight)		✓	✓		—	—
(High Sensitivity)		✓	✓		—	—
(Gourmet)		—	✓		—	—
(Pet)		—	✓		—	—
(Beach)		✓	✓	✓	✓	—
(Snow)		✓	✓	✓	✓	—
(Fireworks)		—	—		—	—
(Advanced Sports Shooting)		✓	✓	—	✓	—
(3D Still Image)		✓	✓		—	—

* [Off] cannot be selected for [Face Detection].

Functions available in Picture Effect

	Flash	Face Detection	Tracking focus	Self-Timer	Continuous Shooting/Bracket	Exposure Compensation
(Off)	✓	✓	✓	✓	✓	✓
(HDR Painting)		✓	✓		—	✓

 (Rich-tone Monochrome)		✓	✓		—	✓
 (Miniature)		—	—		—	✓
 (Toy camera)		✓	✓		✓*	✓
 (Pop Color)		✓	✓		✓*	✓
 (Partial Color)		✓	✓		✓*	✓
 (Soft High-key)		✓	✓		✓*	✓
 (Watercolor)		✓	✓		—	✓
 (Illustration)		✓	✓		—	✓

* [Bracket] cannot be selected.

[▲ Back to top](#)

[Top page](#) > [Useful shooting functions](#) > [Functions available for each shooting mode](#) > [MENU items available for each shooting mode](#)

- ▶ Before Use
- ▶ Operating the camera
- ▶ Shooting
- ▶ Viewing
- ▶ Useful shooting functions
- ▶ Useful viewing functions
- ▶ Changing settings
- ▶ Viewing images on a TV
- ▶ Using with your computer
- ▶ Printing
- ▶ Troubleshooting
- ▶ Precautions / About this camera

[→ Contents list](#)

MENU items available for each shooting mode

▼ MENU items not available in Scene Selection/Picture Effect mode











In the table below, a check mark indicates settings that can be changed, while – indicates settings that cannot be changed. A setting may be fixed or restricted depending on the shooting mode. For details, see each topic.

Menu items	iA	iA+	P/S/AM	iM	ii
Movie shooting scene	–	–	–	–	✓
Panorama Shooting Scene	–	–	–	✓	–
Picture Effect	–	–	✓	–	–
Scene Selection	–	–	–	–	–
Memory recall mode	–	–	–	–	–
Easy Mode	✓	–	–	–	–
HDR Painting effect	–	–	–	–	–
Area of emphasis	–	–	–	–	–
Color hue	–	–	–	–	–
Extracted Color	–	–	–	–	–
Illustration Effect	–	–	–	–	–
Defocus Effect	–	–	–	–	–
Soft Skin Effect* ¹	–	–	–	–	–
Ctrl with Smartphone	✓	✓	✓	✓	✓
Send to Computer	✓	✓	✓	✓	✓
Still Image Size(Dual Rec)	✓	✓	✓	✓	✓
Still Image Size	✓	✓	✓	–	–
Panorama Image Size	–	–	–	✓	–
Movie Quality / Movie Size	✓	✓	✓	✓	✓
ISO	–	–	✓	–	–
White Balance* ² White Balance Shift	–	–	✓	✓	–
Focus	–	–	✓	✓	–
Metering Mode	–	–	✓	✓	–
Cont. Shooting Interval	✓	–	✓	–	–







Bracket Setting	–	–	✓	–	–
Scene Recognition	✓	–	–	–	–
Smile Shutter	✓	–	✓	–	✓
Smile Detection Sensitivity	✓	–	✓	–	✓
Face Detection ⁺³	✓	✓	✓	–	✓
Color Mode	–	–	✓	–	–
Color Saturation	–	–	✓	✓	–
Contrast	–	–	✓	✓	–
Sharpness	–	–	✓	✓	–
Noise Reduction	–	–	✓	–	–
Anti Blink	–	–	–	–	–
Movie SteadyShot	✓	✓	✓	✓	✓
Position Information (DSC-HX50V)	✓	✓	✓	✓	✓
GPS Log REC (DSC-HX50V)	✓	✓	✓	✓	✓
Register Setting	–	–	✓	–	–
In-Camera Guide	✓	✓	✓	✓	✓
 (Settings)	✓	✓	✓	✓	✓

MENU items not available in Scene Selection/Picture Effect mode

The icons below **SCN** or  indicate the available modes.

Menu items	SCN (Still images)	SCN (Movies)	 (Still images)	 (Panorama images)
Movie shooting scene	–	✓	–	–
Panorama Shooting Scene	–	–	–	✓
Picture Effect	–	–	✓	  
Scene Selection	✓	✓	–	–
Memory recall mode	–	–	–	–
Easy Mode	–	–	–	–
HDR Painting effect	–	–		–
Area of emphasis	–	–		–
Color hue	–	–		–
Extracted Color	–	–		
Illustration Effect	–	–		–

Defocus Effect		–	–	–
Soft Skin Effect* ¹		–	–	–
Ctrl with Smartphone	✓	✓	✓	✓
Send to Computer	✓	✓	✓	✓
Still Image Size (Dual Rec)	✓	✓	✓	✓
Still Image Size	✓	–	✓	–
Panorama Image Size	–	–	–	✓
Movie Quality / Movie Size	✓	✓	✓	✓
ISO		–	✓* ⁴	–
White Balance* ² White Balance Shift		ISO	–	–
Focus		–		–
Metering Mode		–	✓	–
Cont. Shooting Interval		–		–
Bracket Setting		–	–	–
Scene Recognition	–	–	–	–
Smile Shutter			–	–
Smile Detection Sensitivity			–	–
Face Detection* ³				–
Color Mode	–	–	–	–
Color Saturation	–	–	–	–
Contrast	–	–	–	–
Sharpness	–	–	–	–
Noise Reduction	–	–	–	–
Anti Blink		–	–	–
Movie SteadyShot	✓	✓	✓	✓
Position Information (DSC-HX50V)	✓	✓	✓	✓
GPS Log REC (DSC-HX50V)	✓	✓	✓	✓
Register Setting	✓	–	✓	–
In-Camera Guide	✓	✓	✓	✓
(Settings)	✓	✓	✓	✓

- *1 [Off] cannot be selected for [Soft Skin Effect] when Scene Selection is set to  (Soft Skin).
- *2 [Flash] cannot be selected for [White Balance] when Scene Selection is set to  (Anti Motion Blur),  (Hand-held Twilight) or  (High Sensitivity).
- *3 [Off] cannot be selected for [Face Detection] when Scene Selection is set to  (Soft Skin) or  (Soft Snap).
- *4 You cannot select when the mode dial is set to **M** (Manual Exposure Shooting).

Notes

- When the above shooting modes are registered and recalled in **MR** (Memory recall mode), the conditions for whether settings can be changed or not remain the same as in the above table.

[▲ Back to top](#)

Copyright 2013 Sony Corporation

- ▶ Before Use
- ▶ Operating the camera
- ▶ Shooting
- ▶ Viewing
- ▶ Useful shooting functions
- ▶ Useful viewing functions
- ▶ Changing settings
- ▶ Viewing images on a TV
- ▶ Using with your computer
- ▶ Printing
- ▶ Troubleshooting
- ▶ Precautions / About this camera

[➡ Contents list](#)

Tracking focus

The camera tracks the subject and adjusts the focus automatically even if when the subject is moving.

1. Press ● on the control wheel.

The target frame appears.



2. Place the target frame over the subject you want to focus on, and press ● .
Tracking begins.
3. Press the shutter button to shoot the image.

Tracking a face

If you use the tracking focus function while the Face Detection function is activated, you can select a face to be given priority and register that face with the camera. Even if the registered face disappears from the screen, when it shows up on the screen again, the camera focuses on the registered face.

- When a specified face is registered in the camera memory and you use the Smile Shutter function, the camera searches only for that face's smile.

Notes

- Tracking focus is not available in the following situations:
 - When using zoom functions other than optical zoom
 - When [Focus] is set to [Flexible Spot AF], [Semi Manual] or [Manual Focus]
- Tracking focus will automatically be canceled when the subject disappears from the screen or has failed to be tracked. However, if the target of the tracking focus is a specified face, the camera keeps tracking on that face even if the face disappears from the screen.

Related Topic

[Face Detection](#)

[Functions available for each shooting mode](#)

[▲ Back to top](#)









- ▶ Before Use
- ▶ Operating the camera
- ▶ Shooting
- ▶ Viewing
- ▶ Useful shooting functions
- ▶ Useful viewing functions
- ▶ Changing settings
- ▶ Viewing images on a TV
- ▶ Using with your computer
- ▶ Printing
- ▶ Troubleshooting
- ▶ Precautions / About this camera

[→ Contents list](#)

DISP (Display Setting)

▼ Histogram

1. Press **DISP** (Display Setting) on the control wheel.
2. Select the desired mode with the control wheel.

 (OFF)	Displays only images. 
 (Level)	Displays an indicator guide shows the angle of inclination of the camera to the left or right side. When the camera is held on a level, this indicator guide appears green. 
 (Detailed Info)	Displays the information. Exif data for the recorded image and the histogram are also displayed. 
  (ON)	Displays the information. 

■ Histogram

A histogram is a graph showing the brightness of an image. The graph display indicates a bright image

when skewed to the right side (A), and a dark image when skewed to the left side (B).



1. Press **DISP** (Display Setting), then select [Detailed Info].

Notes

- The histogram also appears when playing back a single image, but you cannot adjust the exposure.
- The histogram does not appear when:
 - Recording/playing back movies
 - Viewing vertical orientation images
 - Rotating still images
 - Shooting/viewing in [iSweep Panorama]
 - When [Display Cont. Shooting Group] is set to [Display Main Image Only]
- The histogram may not appear for images recorded using other cameras.



[▲ Back to top](#)







Copyright 2013 Sony Corporation

- ▶ Before Use
- ▶ Operating the camera
- ▶ Shooting
- ▶ Viewing
- ▶ Useful shooting functions
- ▶ Useful viewing functions
- ▶ Changing settings
- ▶ Viewing images on a TV
- ▶ Using with your computer
- ▶ Printing
- ▶ Troubleshooting
- ▶ Precautions / About this camera

[➔ Contents list](#)

Flash

1. Press the  (flash pop-up) button to raise the flash.
 - When the flash unit is not raised, the flash mode is set to  (Off) automatically. You cannot change the setting.
2. Press  (Flash) on the control wheel.
3. Select the desired mode.
 - When you do not want to fire the flash, push the flash unit down by hand to retract it.



 Adv. (Advanced Flash)	Flash automatically operates in dark locations or when the subject is backlit. The ISO sensitivity is increased in a dark place to shoot a farther distance brighter.
  AUTO (Auto)	Flash automatically operates in dark locations or when there is backlight.
 (On)	Flash always operates.
 SL (Slow Synchro)	Flash always operates. The shutter speed is slow in a dark place to clearly shoot the background that is out of flash light.
 (Off)	Flash does not operate.

When the “White circular spots” appears in flash photos

This is caused by particles (dust, pollen, etc.) floating close to the lens. When they are accentuated by the camera’s flash, they appear as white circular spots.



How can the “White circular spots” be reduced?

- Light the room and shoot the subject without a flash.
- Select  (Anti Motion Blur) or  (High Sensitivity) mode in Scene Selection. ([Off] is automatically selected.)

Notes

- The flash strobos twice. The first flash adjusts the light quantity.
- While charging the flash,  is displayed.
- You cannot use the flash during burst shooting.
- [Advanced Flash] can be set only when shooting mode is set to [Intelligent Auto] or [Superior Auto].
- When shooting with the flash and the zoom is set to W, the shadow of the lens may appear on the screen, depending on the shooting conditions. If this happens, set the zoom to T and shoot with the flash again.

Related Topic

[Functions available for each shooting mode](#)



[▲ Back to top](#)



Copyright 2013 Sony Corporation





- ▶ Before Use
- ▶ Operating the camera
- ▶ Shooting
- ▶ Viewing
- ▶ Useful shooting functions
- ▶ Useful viewing functions
- ▶ Changing settings
- ▶ Viewing images on a TV
- ▶ Using with your computer
- ▶ Printing
- ▶ Troubleshooting
- ▶ Precautions / About this camera







[➡ Contents list](#)

Photo Creativity

Photo Creativity is a mode that you can operate the camera intuitively using unusual screen display. When shooting mode is set to  (Intelligent Auto) or  (Superior Auto), you can change the settings easily and shoot images.

1. Set the mode dial to  (Intelligent Auto) or  (Superior Auto).
2. Press  (Photo Creativity) on the control wheel.
3. Select the desired item with the control wheel.

 (Brightness)	Adjusts brightness.
 (Color)	Adjusts color.
 (Vividness)	Adjusts vividness.
 (Picture Effect)	Shoots a still image with an original texture according to the desired effect.

4. Change the settings.
 - You can combine some settings by repeating step 3 and 4.
 - To reset the changed settings to the default settings, press the  (In-Camera Guide) button.  (Brightness),  (Color) and  (Vividness) are set to [AUTO], and  (Picture Effect) is set to .
5. When shooting still images: Shoot with the shutter button.
When recording movies: Press the MOVIE button to start recording.

Notes

- When you record movies in Photo Creativity mode, you cannot change the settings during recording.
- If you switch the camera mode to Intelligent Auto mode or turn off the camera, the settings you changed are reverted to the default settings.
- When you set Photo Creativity in Superior Auto mode, overlaying images are disabled.

Related Topic

[Functions available for each shooting mode](#)[Picture Effect](#)[▲ Back to top](#)



- ▶ Before Use
- ▶ Operating the camera
- ▶ Shooting
- ▶ Viewing
- ▶ Useful shooting functions
- ▶ Useful viewing functions
- ▶ Changing settings
- ▶ Viewing images on a TV
- ▶ Using with your computer
- ▶ Printing
- ▶ Troubleshooting
- ▶ Precautions / About this camera

[➡ Contents list](#)

Cont. Shooting Settings

You can select Single (single-image), Continuous Shooting or Bracket as the shooting mode.

1. Press  (Cont. Shooting/Self-Timer) on the control wheel.
2. Select the desired mode with the control wheel.

	 (Single Shooting)	The camera shoots a single image.
	 (Continuous Shooting)	The camera shoots up to 10 continuous frames in one burst when you hold down the shutter button.
	BRK (Bracket)	The camera shoots a series of 3 images each with a different setting.

Notes

- [Flash] is set to [Off] in continuous or bracket shooting mode.
- When [Continuous Shooting] is selected, [Focus], [White Balance], and [Exposure Compensation] are adjusted for the first image, and these settings are also used for the other images.
- When the internal memory or a memory card is full, the burst stops.
- When you perform continuous shooting or bracket shooting, [VGA] image size will be set while recording on internal memory.

Related Topic

[Functions available for each shooting mode](#)

[Cont. Shooting Interval](#)

[Bracket Setting](#)

[▲ Back to top](#)









- ▶ Before Use
- ▶ Operating the camera
- ▶ Shooting
- ▶ Viewing
- ▶ Useful shooting functions
- ▶ Useful viewing functions
- ▶ Changing settings
- ▶ Viewing images on a TV
- ▶ Using with your computer
- ▶ Printing
- ▶ Troubleshooting
- ▶ Precautions / About this camera

[→ Contents list](#)

Self-Timer



▼ Automatic shooting with Self-portrait timer

1. Press  (Cont. Shooting/Self-Timer) on the control wheel.
2. Select the desired mode with the control wheel.

✓	 (Single Shooting)	Does not use the self-timer.
	(10sec)	Sets the self-timer to a 10-second delay. When you press the shutter button, the self-timer lamp flashes and a beep sounds until the shutter operates. To cancel, press  again.
	(2sec)	Sets the self-timer to a 2-second delay.
	(Self-portrait One Person)	Sets the self-timer to Self-portrait timer. When the camera detects the specified number of faces, a beep sounds, and the shutter operates 2 seconds later.
	(Self-portrait Two People)	
	(Self-Timer: Continuous Shooting)	The camera shoots 10 continuous frames 10 seconds later after you press the shutter button.
	(Self-Timer (Bracket))	The camera starts bracket shooting 10 seconds later after you press the shutter button.

Tips for preventing blur

If your hands or body moves while holding the camera and pressing the shutter button, “Camera shake” occurs.

Camera shake occurs frequently under low-light or slow shutter speed conditions, such as those encountered in  (Night Portrait) or  (Night Scene) mode.



To reduce camera shake, set the self-timer to a 2-second delay and brace your arms against your sides after pressing the shutter button.

Notes

- [Flash] is set to [Off] in continuous or bracket shooting mode.
- When [Continuous Shooting] is selected, [Focus], [White Balance], and [Exposure Compensation] are adjusted for the first image, and these settings are also used for the other images.
- When the internal memory or a memory card is full, the burst stops.
- In continuous or bracket shooting mode, [VGA] image size will be set while recording on internal memory.

Automatic shooting with Self-portrait timer

Point the lens at yourself so that the selected number of faces are reflected in the screen. The shutter operates automatically. Do not move your camera after the beep sounds.



Related Topic

[Functions available for each shooting mode](#)

[Cont. Shooting Interval](#)

[Bracket Setting](#)

[▲ Back to top](#)

Copyright 2013 Sony Corporation

[Top page](#) > [Useful shooting functions](#) > [Menu items available for shooting](#) > [Using the CUSTOM \(Custom\) button](#)

- ▶ [Before Use](#)
- ▶ [Operating the camera](#)
- ▶ [Shooting](#)
- ▶ [Viewing](#)
- ▶ [Useful shooting functions](#)
- ▶ [Useful viewing functions](#)
- ▶ [Changing settings](#)
- ▶ [Viewing images on a TV](#)
- ▶ [Using with your computer](#)
- ▶ [Printing](#)
- ▶ [Troubleshooting](#)
- ▶ [Precautions / About this camera](#)

[➡ Contents list](#)

Using the CUSTOM (Custom) button

Pressing the CUSTOM (Custom) button allows you to recall previously registered functions. During playback, you can set [Send to Smartphone] by pressing the CUSTOM button. [\[Details\]](#)

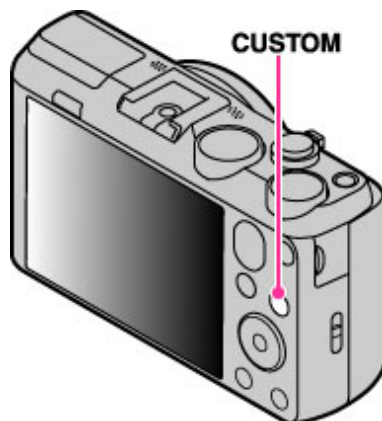

For details on registering settings, see "Custom Button." [\[Details\]](#)

Related Topic

[Custom Button](#)

[▲ Back to top](#)

[Top page](#) > [Useful shooting functions](#) > [Menu items available for shooting](#) > [Movie shooting scene](#)

- ▶ Before Use
- ▶ Operating the camera
- ▶ Shooting
- ▶ Viewing
- ▶ Useful shooting functions
- ▶ Useful viewing functions
- ▶ Changing settings
- ▶ Viewing images on a TV
- ▶ Using with your computer
- ▶ Printing
- ▶ Troubleshooting
- ▶ Precautions / About this camera

[→ Contents list](#)

Movie shooting scene

You can select the movie shooting mode when shooting movies.

1. MENU →  (Movie shooting scene) → desired mode → ●

✓	 (Intelligent Auto)	Allows you to shoot movies with the settings adjusted automatically. [Details]
	SCN (Scene Selection)	Allows you to shoot movies with preset settings according to the scene. [Details]

On Scene Recognition

Scene Recognition operates in Intelligent Auto mode. This function lets the camera automatically recognize the shooting conditions and shoot the image.



Related Topic

[MENU items available for each shooting mode](#)

[▲ Back to top](#)

[Top page](#) > [Useful shooting functions](#) > [Menu items available for shooting](#) > [Panorama Shooting Scene](#)



- ▶ Before Use
- ▶ Operating the camera
- ▶ Shooting
- ▶ Viewing
- ▶ Useful shooting functions
- ▶ Useful viewing functions
- ▶ Changing settings
- ▶ Viewing images on a TV
- ▶ Using with your computer
- ▶ Printing
- ▶ Troubleshooting
- ▶ Precautions / About this camera

[⇒ Contents list](#)

Panorama Shooting Scene

Select a panorama shooting mode in Sweep Panorama.

1. MENU →  (Panorama Shooting Scene) → desired mode → ●

<input checked="" type="checkbox"/>	 (iSweep Panorama)	Shoots a regular panorama image. [Details]
<input type="checkbox"/>	 (Picture Effect)	Allows you to shoot a panoramic image with a desired picture effect added.

Related Topic

[Picture Effect](#)

[MENU items available for each shooting mode](#)

[▲ Back to top](#)

- ▶ Before Use
- ▶ Operating the camera
- ▶ Shooting
- ▶ Viewing
- ▶ Useful shooting functions
- ▶ Useful viewing functions
- ▶ Changing settings
- ▶ Viewing images on a TV
- ▶ Using with your computer
- ▶ Printing
- ▶ Troubleshooting
- ▶ Precautions / About this camera

[⇒ Contents list](#)

Memory recall mode

Allows you to select a setting registered in advance when the mode dial is set to [Memory recall mode].

1. MENU → **MR** (Memory recall mode)
2. Press ◀ / ▶ to select the desired number → ● .

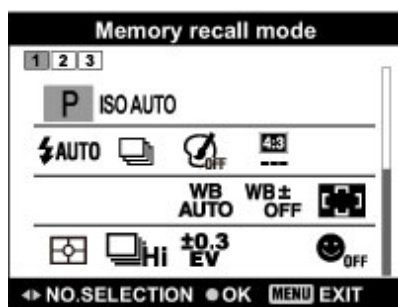

Notes

- Register shooting settings in advance using **MR^{SET}** (Register Setting).
- If you set **MR** (Memory recall mode) after completing the shooting settings, the registered settings are given priority and the original settings may become invalid. Check the indicators on the screen before shooting.

Related Topic

[Memory recall mode](#)[Register Setting](#)[▲ Back to top](#)

- ▶ Before Use
- ▶ Operating the camera
- ▶ Shooting
- ▶ Viewing
- ▶ Useful shooting functions
- ▶ Useful viewing functions
- ▶ Changing settings
- ▶ Viewing images on a TV
- ▶ Using with your computer
- ▶ Printing
- ▶ Troubleshooting
- ▶ Precautions / About this camera

[⇒ Contents list](#)

Easy Mode

▼ On Scene Recognition

▼ Shooting functions available in Easy Mode (Shooting)

Allows you to shoot still images using the minimum necessary functions. The text size increases and indicators become easier to see.

1. Set the mode dial to  (Intelligent Auto).
2. MENU → **EASY** (Easy Mode) → ●
3. [OK] → ●
4. Shoot with the shutter button.
 - To end Easy Mode, MENU → [Exit Easy Mode]

💡 On Easy Mode (Viewing)

When you press the  (Playback) button in Easy Mode, the playback screen text becomes larger and easier to see.

Delete currently displayed image:

 (Delete) button → [OK] → ● on the control wheel

Select between [1 image] and [All]:

MENU → [Delete] → ● on the control wheel → desired mode → ●

You can delete currently displayed image with [1 image] and delete all images in the selected date range or internal memory (if selected) with [All].

- [View Mode] is set to [Date View] when using a memory card.

Use GPS function (DSC-HX50V):

You can select the setting for [GPS setting] on the MENU screen in Easy Mode.

For details on the function, see [GPS setting]. [\[Details\]](#)

MENU → [GPS setting] → ● → desired mode → ●

Select between [On] and [Off] mode.

- When boarding an airplane while the camera is set to Easy Mode, set [GPS setting] to [Off].

Notes

- The battery power may decrease faster because the screen brightness increases automatically.

On Scene Recognition

Scene Recognition operates in Easy Mode. This function lets the camera automatically recognize the shooting conditions and shoot the image.



Shooting functions available in Easy Mode (Shooting)

MOVIE (Movie) button	Allows you to record movies with their audio.
Still Image Size	Select between [Large] or [Small] size.
GPS setting (DSC-HX50V)	Select between [On] or [Off] mode.
Self-Timer	Select between [On] or [Off] mode.
Flash	Select between [Auto] or [Off] mode.

Related Topic

[Scene Recognition](#)

[GPS setting \(DSC-HX50V\)](#)

[▲ Back to top](#)

Copyright 2013 Sony Corporation



- ▶ Before Use
- ▶ Operating the camera
- ▶ Shooting
- ▶ Viewing
- ▶ Useful shooting functions
- ▶ Useful viewing functions
- ▶ Changing settings
- ▶ Viewing images on a TV
- ▶ Using with your computer
- ▶ Printing
- ▶ Troubleshooting
- ▶ Precautions / About this camera

[⇒ Contents list](#)

HDR Painting effect

When you select [HDR Painting] in Picture Effect, set the effect level.

1. MENU →  (HDR Painting effect) → desired mode → ●

 (Low)	Select weak, medium or strong for effects that emphasize color, etc.
<input checked="" type="checkbox"/>  (Medium)	
 (High)	

Related Topic

[Picture Effect](#)

[MENU items available for each shooting mode](#)

[▲ Back to top](#)







- ▶ Before Use
- ▶ Operating the camera
- ▶ Shooting
- ▶ Viewing
- ▶ Useful shooting functions
- ▶ Useful viewing functions
- ▶ Changing settings
- ▶ Viewing images on a TV
- ▶ Using with your computer
- ▶ Printing
- ▶ Troubleshooting
- ▶ Precautions / About this camera

[⇒ Contents list](#)

Area of emphasis

When you select [Miniature] in Picture Effect, set the part you want attention on.

1. MENU →  (Area of emphasis) → desired mode → ●

	(Top)	Sets area of emphasis at the top.
	(Center)	Sets area of emphasis in the center.
<input checked="" type="checkbox"/> 	(Bottom)	Sets area of emphasis at the bottom.
	(Left)	Sets area of emphasis to the left.
	(Middle)	Sets area of emphasis in the middle.
	(Right)	Sets area of emphasis to the right.

Related Topic

[Picture Effect](#)

[MENU items available for each shooting mode](#)

[▲ Back to top](#)





- ▶ Before Use
- ▶ Operating the camera
- ▶ Shooting
- ▶ Viewing
- ▶ Useful shooting functions
- ▶ Useful viewing functions
- ▶ Changing settings
- ▶ Viewing images on a TV
- ▶ Using with your computer
- ▶ Printing
- ▶ Troubleshooting
- ▶ Precautions / About this camera

[⇒ Contents list](#)

Color hue

When you select [Toy camera] in Picture Effect, adjust the color hue.

1. MENU →  (Color hue) → desired mode → ●

✓	 (Normal)	Adds a normal hue and darkens the surroundings.
	 (Cool hue)	Adds a bluish cool hue and darkens the surroundings.
	 (Warm hue)	Adds a reddish warm hue and darkens the surroundings.
	 (Green hue)	Adds a green filter-like hue and darkens the surroundings.
	 (Magenta hue)	Adds a magenta filter-like hue and darkens the surroundings.

Notes

- It is recommended that you shoot a test image in advance for some subjects.

Related Topic

[Picture Effect](#)

[MENU items available for each shooting mode](#)

[▲ Back to top](#)



- ▶ Before Use
- ▶ Operating the camera
- ▶ Shooting
- ▶ Viewing
- ▶ Useful shooting functions
- ▶ Useful viewing functions
- ▶ Changing settings
- ▶ Viewing images on a TV
- ▶ Using with your computer
- ▶ Printing
- ▶ Troubleshooting
- ▶ Precautions / About this camera

[⇒ Contents list](#)

Extracted Color

When you select [Partial Color] in Picture Effect, select the color to extract.

1. MENU →  (Extracted Color) → desired mode → ●

✓	 (Red)	Extracts red only.
	 (Green)	Extracts green only.
	 (Blue)	Extracts blue only.
	 (Yellow)	Extracts yellow only.

Notes

- Images may not retain the selected color, depending on the subject.

Related Topic

[Picture Effect](#)

[MENU items available for each shooting mode](#)

[▲ Back to top](#)



- ▶ Before Use
- ▶ Operating the camera
- ▶ Shooting
- ▶ Viewing
- ▶ Useful shooting functions
- ▶ Useful viewing functions
- ▶ Changing settings
- ▶ Viewing images on a TV
- ▶ Using with your computer
- ▶ Printing
- ▶ Troubleshooting
- ▶ Precautions / About this camera

[⇒ Contents list](#)

Illustration Effect

When you select [Illustration] in Picture Effect, set the effect level.

1. MENU →  (Illustration Effect) → desired mode → ●

	 (Low)	Adds a strong, medium or weak Illustration effect.
✓	 (Medium)	
	 (High)	

Related Topic

[Picture Effect](#)

[MENU items available for each shooting mode](#)

[▲ Back to top](#)



- ▶ Before Use
- ▶ Operating the camera
- ▶ Shooting
- ▶ Viewing
- ▶ Useful shooting functions
- ▶ Useful viewing functions
- ▶ Changing settings
- ▶ Viewing images on a TV
- ▶ Using with your computer
- ▶ Printing
- ▶ Troubleshooting
- ▶ Precautions / About this camera

[⇒ Contents list](#)

Defocus Effect

Sets the level of background defocus effect when shooting in Background Defocus mode.

1. MENU →  (Defocus Effect) → desired mode → ●

 (Low)	Select a weak, medium or strong Background Defocus effect.
<input checked="" type="checkbox"/>  (Mid)	
 (High)	

Related Topic

[Background Defocus](#)

[▲ Back to top](#)





- ▶ Before Use
- ▶ Operating the camera
- ▶ Shooting
- ▶ Viewing
- ▶ Useful shooting functions
- ▶ Useful viewing functions
- ▶ Changing settings
- ▶ Viewing images on a TV
- ▶ Using with your computer
- ▶ Printing
- ▶ Troubleshooting
- ▶ Precautions / About this camera

[⇒ Contents list](#)

Soft Skin Effect

When the Face Detection function is activated, sets whether to use the Soft Skin effect, and the effect level.

1. MENU →  (Soft Skin Effect) → desired mode → ●

	 OFF (Off)	Does not use the Soft Skin Effect.
	 Lo (Low)	Adds a weak, medium or strong Soft Skin Effect.
	 Mid (Mid)	
	 Hi (High)	

Notes

- The [Soft Skin Effect] may not be visible depending on the subject.

Related Topic

[MENU items available for each shooting mode](#)

[▲ Back to top](#)

- ▶ Before Use
- ▶ Operating the camera
- ▶ Shooting
- ▶ Viewing
- ▶ Useful shooting functions
- ▶ Useful viewing functions
- ▶ Changing settings
- ▶ Viewing images on a TV
- ▶ Using with your computer
- ▶ Printing
- ▶ Troubleshooting
- ▶ Precautions / About this camera

[⇒ Contents list](#)

Ctrl with Smartphone

- ▼ [Connect to the camera from an Android smartphone](#)
- ▼ [Connect to the camera from an iOS smartphone](#)
- ▼ [Functions that can be set with the smartphone](#)

You can shoot still images and movies by controlling the camera remotely by a smartphone. You can also save recorded still images on your smartphone. Download the smartphone support application "PlayMemories Mobile" to your smartphone from the application store.

1. MENU →  (Ctrl with Smartphone)
2. Connect to the camera from your smartphone, using the information that appears on the screen when the camera is ready to be connected. Connection methods differ, depending on the type of smartphone. [\[Details\]](#) [\[Details\]](#)



3. Determine the composition on the screen of the smartphone, then press the shutter button (A) to shoot.
 - You can zoom with the zoom button (B).
 - You can switch between still images and movies (C).
 - You can configure settings for [Flash], [Self-Timer] or saving images on your smartphone (D). [\[Details\]](#)
 - You cannot operate on the camera.

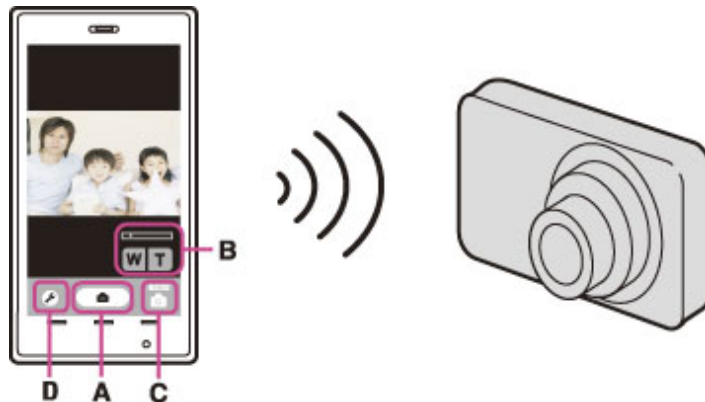

Notes

- Still images recorded on a smartphone are in [2M] format.
- Movies cannot be recorded on a smartphone.

Connect to the camera from an Android smartphone

1. Start "PlayMemories Mobile" on your smartphone.
2. Select (DIRECT-XXXX : DSC-XXXX).



3. Input the password displayed on the camera.



The smartphone is connected to the camera.

Connect to the camera from an iOS smartphone

1. Select (DIRECT-XXXX : DSC-XXXX) on the Wi-Fi settings screen of iOS.



2. Input the password displayed on the camera.



The smartphone is connected to the camera.

3. Start "PlayMemories Mobile" on your smartphone.

Functions that can be set with the smartphone

Flash	Select [Off] or [Auto].
Self-Timer	Select [Off], [2sec] or [10sec].
Review Check	Select [Off], [Review Only] or [Review, Save Image]. If you select [Review, Save Image], you can also save still pictures on your smartphone.

[▲ Back to top](#)

Copyright 2013 Sony Corporation

- ▶ Before Use
- ▶ Operating the camera
- ▶ Shooting
- ▶ Viewing
- ▶ Useful shooting functions
- ▶ Useful viewing functions
- ▶ Changing settings
- ▶ Viewing images on a TV
- ▶ Using with your computer
- ▶ Printing
- ▶ Troubleshooting
- ▶ Precautions / About this camera

[⇒ Contents list](#)

Send to Computer

You can easily back up images from the camera to a computer connected to your wireless access point or wireless broadband router.

Install "PlayMemories Home" [\[Details\]](#) before registering the wireless access point [\[Details\]](#) [\[Details\]](#).

1. Start your computer.

2. MENU →  (Send to Computer) → ●

Notes

- Depending on the application settings of your computer, the camera will turn off after saving the images to your computer.
- The images in the internal memory cannot be transferred.
- Set up the access point in advance.
- You can simultaneously transfer multiple images to a personal computer.
- To transfer images to another computer, use a USB cable to connect the camera to the personal computer, then operate the camera with "PlayMemories Home".

Related Topic

[WPS Push](#)

[Access point settings](#)

[▲ Back to top](#)

- ▶ Before Use
- ▶ Operating the camera
- ▶ Shooting
- ▶ Viewing
- ▶ Useful shooting functions
- ▶ Useful viewing functions
- ▶ Changing settings
- ▶ Viewing images on a TV
- ▶ Using with your computer
- ▶ Printing
- ▶ Troubleshooting
- ▶ Precautions / About this camera

[→ Contents list](#)





[Top page](#) > [Useful shooting functions](#) > [Menu items available for shooting](#) > [Still Image Size\(Dual Rec\)](#)

Still Image Size(Dual Rec)





Sets the still image size shot while recording a movie.

1. MENU →   (Still Image Size(Dual Rec)) → desired size

When [Movie Size] is set to other than [VGA]

✓	 	16:9(15M Level)	For viewing on a high-definition TV and printing up to A3+ size
	 	16:9(3M)	For viewing on a high-definition TV

When [Movie Size] is set to [VGA]

✓	 	4:3 11M Level	For prints up to A3(11×17")
	 	4:3 2M	For prints up to 10×15 cm (4×6") or 13×18 cm(5×7").

Related Topic

[MENU items available for each shooting mode](#)

[▲ Back to top](#)

- ▶ Before Use
- ▶ Operating the camera
- ▶ Shooting
- ▶ Viewing
- ▶ Useful shooting functions
- ▶ Useful viewing functions
- ▶ Changing settings
- ▶ Viewing images on a TV
- ▶ Using with your computer
- ▶ Printing
- ▶ Troubleshooting
- ▶ Precautions / About this camera

[→ Contents list](#)

[Top page](#) > [Useful shooting functions](#) > [Menu items available for shooting](#) > [Still Image Size/Panorama Image Size](#)

Still Image Size/Panorama Image Size

▼ Image size when shooting still images

▼ 3D Still Image Size

















▼ Image size in Easy Mode

▼ Image size when shooting Sweep Panorama

The image size determines the size of the image file that is recorded when you take an image. The larger the image size, the more detail will be reproduced when the image is printed on large-format paper. The smaller the image size, the more images can be recorded.

Image size when shooting still images

- MENU →  (Still Image Size) → desired size

	Image size (Horizontal x Vertical)	Usage guidelines	No. of images	Printing
✓	 20M (5184x3888)	For prints up to A3+ size	 ↑ ↓ 	Fine 
	 10M (3648x2736)	For prints up to A3 size		 ↑ ↓ 
	 5M (2592x1944)	For prints from 10x15 cm up to A4 size		
	 VGA (640x480)	For e-mail attachments	More 	Rough 
	 15M (5184x2920)	For viewing on a high-definition TV and printing up to A3+ size	Less 	Fine 
	 2M (1920x1080)	For viewing on a high-definition TV	More 	Rough 

3D Still Image Size

- MENU →  (Still Image Size) → desired size



<input checked="" type="checkbox"/>	 (5184×3888)	For prints up to A3+ size
<input type="checkbox"/>	 (5184×2920)	For viewing on a high-definition TV and printing up to A3+ size





Image size in Easy Mode

1. MENU → [Still Image Size] → desired size

<input checked="" type="checkbox"/>	Large	Shoots images in [20M] size.
<input type="checkbox"/>	Small	Shoots images in [5M] size.

Image size when shooting Sweep Panorama

1. MENU →  (Panorama Image Size) → desired size

<input checked="" type="checkbox"/>	 (Standard) (Horizontal: 4912 × 1080) (Vertical: 3424 × 1920)	Shoots images using standard size.
<input type="checkbox"/>	 (Wide) (Horizontal: 7152 × 1080) (Vertical: 4912 × 1920)	Shoots images using wide size.
<input type="checkbox"/>	 (360°) (Horizontal: 11520 × 1080)	Shoots images using a 360 degree.
<input type="checkbox"/>	 (High Resolution) (Horizontal: 10480 × 4096)	Shoots high-resolution panorama in 43 megapixel size.

Notes

- If you cannot print panoramic images recorded in [High Resolution] size due to the large size, use the resize function in the software "PlayMemories Home".

Related Topic

[MENU items available for each shooting mode](#)

[▲ Back to top](#)



[Top page](#) > [Useful shooting functions](#) > [Menu items available for shooting](#) > [Movie Quality/Movie Size](#)

- ▶ Before Use
- ▶ Operating the camera
- ▶ Shooting
- ▶ Viewing
- ▶ Useful shooting functions
- ▶ Useful viewing functions
- ▶ Changing settings
- ▶ Viewing images on a TV
- ▶ Using with your computer
- ▶ Printing
- ▶ Troubleshooting
- ▶ Precautions / About this camera

[⇒ Contents list](#)

Movie Quality/Movie Size

The larger the size of the movie image, the higher the image quality. The higher the amount of data used per second (average bit-rate), the higher the image quality.

Select a movie recording format by pressing MENU →  (Settings) →  (Shooting Settings) → [Movie format] in shooting mode. [\[Details\]](#)

If [Movie format] is [AVCHD], select the movie size from [Movie Quality], and if [Movie format] is [MP4], select from [Movie Size].

Movie quality (recording format: AVCHD)





1. MENU → [Movie Quality] → desired mode

FX/FH/HQ:

Movies shot are recorded in AVCHD format, at approximately 60 fields/sec (for 1080 60i-compatible devices) or 50 fields/sec (for 1080 50i-compatible devices), in interlaced mode, with Dolby Digital audio, AVCHD format.

PS:



Movies shot are recorded in AVCHD format, at approximately 60 frames/sec (for 1080 60i-compliant devices) or 50 frames/sec (for 1080 50i-compliant devices), in progressive mode, with Dolby Digital audio, AVCHD format.

	Movie quality	Average bit-rate	Description
	 AVC HD 28M (PS)	28 Mbps	Shoots at the highest picture quality of 1920×1080 (50p/60p) size
	 AVC HD 24M (FX)	24 Mbps	Shoots at the highest picture quality of 1920×1080 (50i/60i) size
	 AVC HD 17M (FH)	17 Mbps	Shoots at a high picture quality of 1920×1080 (50i/60i) size
	 AVC HD 9M (HQ)	9 Mbps	Shoots at a standard picture quality of 1440×1080 (50i/60i) size

Movie image size (recording format: MP4)

1. MENU → [Movie Size] → desired size

Movies shot are recorded in MPEG-4 format, at approximately 30 frames/sec (for 1080 60i-compatible devices) or approximately 25 frames/sec (for 1080 50i-compatible devices), in progressive mode, with AAC audio, mp4 format.

	Movie image size	Average bit-rate	Description
	 MP4 12M	12 Mbps	Shoots at 1440×1080 size
	 MP4 6M	6 Mbps	Shoots at 1280×720 size
	 MP4 3M	3 Mbps	Shoots at VGA size

Notes

- A telephoto image is produced when [MP4 3M] image size is selected.
- When you create AVCHD discs from movies recorded in [AVC HD 28M (PS)] or [AVC HD 24M (FX)], it will take time as the image quality must be converted. To save [AVC HD 28M (PS)] or [AVC HD 24M (FX)] movies without converting the image quality, use Blu-ray discs.

[▲ Back to top](#)

Copyright 2013 Sony Corporation

- ▶ Before Use
- ▶ Operating the camera
- ▶ Shooting
- ▶ Viewing
- ▶ Useful shooting functions
- ▶ Useful viewing functions
- ▶ Changing settings
- ▶ Viewing images on a TV
- ▶ Using with your computer
- ▶ Printing
- ▶ Troubleshooting
- ▶ Precautions / About this camera

[➡ Contents list](#)

Exposure Compensation

1. Turn the exposure compensation dial to select the desired Exposure Compensation setting.

Adjusting the exposure for better looking images



A: Overexposure (too much light)

B: Correct exposure

C: Underexposure (too little light)

- When the image shot is overexposed, adjust [Exposure Compensation] to the minus side.
- When the image shot is underexposed, adjust [Exposure Compensation] to the plus side.

Notes

- If you shoot a subject in extremely bright or dark conditions, or when you use the flash, the exposure adjustment may not be effective.

Related Topic

[Functions available for each shooting mode](#)

[▲ Back to top](#)

- ▶ Before Use
- ▶ Operating the camera
- ▶ Shooting
- ▶ Viewing
- ▶ Useful shooting functions
- ▶ Useful viewing functions
- ▶ Changing settings
- ▶ Viewing images on a TV
- ▶ Using with your computer
- ▶ Printing
- ▶ Troubleshooting
- ▶ Precautions / About this camera

[→ Contents list](#)

ISO

Adjusts the luminous sensitivity when the camera is set to Manual Exposure Shooting, Shutter Speed Priority Shooting, Aperture Priority Shooting, Program Auto or [Advanced Sports Shooting] in Scene Selection. Adjusts the sensitivity using the control wheel in Aperture Priority Shooting, Shutter Speed Priority Shooting, Manual Exposure Shooting Mode. In movie mode, [ISO] is fixed to [Auto]. You cannot change the settings.

1. MENU → ^{ISO}AUTO (ISO) → desired mode → ●

- When shooting in Aperture Priority Shooting, Shutter Speed Priority Shooting, Manual Exposure Shooting mode, press ● on the control wheel to select ISO sensitivity, then turn the control wheel to select the desired value.

✓	ISO AUTO (Auto)	Sets the ISO sensitivity automatically.
	ISO ISO ISO ISO ISO 80/100/200/400/800/ ISO ISO ISO ISO 1600/3200/6400/12800	You can reduce image blurring in dark locations or with moving subjects by increasing the ISO sensitivity (select a larger number). Higher ISO settings than [ISO6400] are achieved using Clear Image technology and overlay burst shooting.

Adjusting ISO Sensitivity (Recommended Exposure Index)

ISO sensitivity is a speed rating for recording media that incorporates an image sensor that receives light. Even when the exposure is the same, images differ depending on the ISO sensitivity.

High ISO sensitivity



Records a bright image even in dark locations while increasing shutter speed to reduce blur. However, the image tends to become noisy.

Low ISO sensitivity



Records a smoother image. However, when the exposure is insufficient, the image may become darker.

Notes

- When [ISO] is set to [ISO6400] or [ISO12800], it takes some time to record an image, because the camera overlays the image. The flash does not operate with these settings.
- You cannot select [Auto] when the camera is set to Manual Exposure Shooting. [ISO80] is the default setting.
- You can select only from [Auto], [ISO80] to [ISO800] when the shooting mode is set to burst or bracket shooting mode.

Related Topic

[MENU items available for each shooting mode](#)

[▲ Back to top](#)

Copyright 2013 Sony Corporation

- ▶ Before Use
- ▶ Operating the camera
- ▶ Shooting
- ▶ Viewing
- ▶ Useful shooting functions
- ▶ Useful viewing functions
- ▶ Changing settings
- ▶ Viewing images on a TV
- ▶ Using with your computer
- ▶ Printing
- ▶ Troubleshooting
- ▶ Precautions / About this camera











[⇒ Contents list](#)

White Balance

▼ To capture the basic white color in [One Push Set] mode

Adjusts color tones according to the surrounding light conditions. Use this function if image color appears unnatural.

1. MENU →  (White Balance) → desired mode → ●

✓	 (Auto)	Adjusts the white balance automatically so that the colors appear natural.
	 (Daylight)	Adjusts for outdoors conditions on a fine day, evening views, night scenes, neon signs, fireworks, etc.
	 (Cloudy)	Adjusts for a cloudy sky or a shady location.
	 (Fluorescent White Balance 1)  (Fluorescent White Balance 2)  (Fluorescent White Balance 3)	[Fluorescent White Balance 1]: Adjusts for white fluorescent lighting. [Fluorescent White Balance 2]: Adjusts for natural white fluorescent lighting. [Fluorescent White Balance 3]: Adjusts for daylight fluorescent lighting.
	 (Incandescent)	Adjusts for places under incandescent lamp, or under bright lighting, such as in a photo studio.
	 (Flash)	Adjusts for the flash conditions.
	 (One Push)	Adjusts the white balance depending on the light source. Use this mode when [Auto] and other settings don't provide accurate colors.
	 (One Push Set)	Memorizes the basic white color which will be used in [One Push] mode. [Details]

Effects of lighting conditions

The apparent color of the subject is affected by the lighting conditions.

The color tones are adjusted automatically, but you can adjust color tones manually using the White Balance function.



Daylight (White as Standard)



Cloudy (Bluish)



Fluorescent (Green-tinged)



Incandescent (Reddish)

To capture the basic white color in [One Push Set] mode

1. Frame a white object such as a piece of paper filling the screen under the same lighting conditions as you will shoot the subject.
2. MENU →  AUTO (White Balance) → [One Push Set] → ●
The screen momentarily turns black, and when the white balance has been adjusted and stored in the memory, the recording screen is displayed again.

Notes

- If the  indicator flashes while shooting, the white balance cannot be set. Use automatic white balance.
- Do not shake or strike the camera while [One Push Set] is in progress.
- When flash mode is set to other than [Auto] or [Off], the white balance is adjusted to the condition with the flash emitting.

Related Topic

[MENU items available for each shooting mode](#)

[▲ Back to top](#)

- ▶ Before Use
- ▶ Operating the camera
- ▶ Shooting
- ▶ Viewing
- ▶ Useful shooting functions
- ▶ Useful viewing functions
- ▶ Changing settings
- ▶ Viewing images on a TV
- ▶ Using with your computer
- ▶ Printing
- ▶ Troubleshooting
- ▶ Precautions / About this camera

[⇒ Contents list](#)

White Balance Shift

Allows you to use the selected white balance as the base value and apply the set correction value to change the color and record an image.

1. MENU → **WB±**
OFF (White Balance Shift) → desired mode → ●
 - When using for the first time, set the correction value to [Shift Amount Adjust].

✔	WB± OFF (Off)	Does not use [White Balance Shift].
	WB± ON (On)	Uses [White Balance Shift].
	WB± SET (Shift Amount Adjust)	Sets the correction value. If you set a correction value, [White Balance Shift] will be set to [On] automatically.

Set the White Balance Shift correction value

1. MENU → **WB±**
OFF (White Balance Shift) → [Shift Amount Adjust]
Set the correction value using ▲ / ▼ / ◀ / ▶ .



Operation	Action
▲ / ▼	G (Green) and M (Magenta) provide fine adjustments such as those achieved with a color correction (CC) filter.
◀ / ▶	B (Blue) and A (Amber) provide fine adjustments in the color temperature.

- If you set the [White Balance Shift] to [On] for the previously set correction value, it can be recalled.

Related Topic

[MENU items available for each shooting mode](#)

[▲ Back to top](#)

- ▶ Before Use
- ▶ Operating the camera
- ▶ Shooting
- ▶ Viewing
- ▶ Useful shooting functions
- ▶ Useful viewing functions
- ▶ Changing settings
- ▶ Viewing images on a TV
- ▶ Using with your computer
- ▶ Printing
- ▶ Troubleshooting
- ▶ Precautions / About this camera

[→ Contents list](#)

Focus







▼ Using Flexible Spot AF

▼ Using Semi Manual/Manual Focus

You can change the focus method. Use the menu when it is difficult to get the proper focus in auto focus mode.

AF stands for "Auto Focus," a function that adjusts the focus automatically.

1. MENU →  (Focus) → desired mode → ●

 (Multi AF)	<p>Focuses on a subject in all ranges of the finder frame automatically. When you press the shutter button halfway down in still image shooting mode, a green frame is displayed around the area that is in focus.</p> <ul style="list-style-type: none"> ● When the Face Detection function is active, AF operates with priority on faces.
 (Center AF)	<p>Focuses on a subject in the center of the finder frame automatically. Using the AF lock function together, you can compose the image the way you want.</p> 
 (Flexible Spot AF)	<p>Allows you to move the AF range finder frame to the desired point on the screen and focus on an extremely small subject in a narrow area.</p> 
 (Semi Manual)	<p>Automatically and quickly focuses on the area around a set distance. Focuses on a subject in all ranges of the finder frame automatically.</p> <ul style="list-style-type: none"> ● This mode is useful when repeatedly shooting a subject at the same distance.
 (Manual Focus)	<p>Allows you to focus on the subject manually.</p>

Notes

- When you use the following functions, the AF range finder frame is disabled and appears in a dotted line. In this case, the camera works to focus on the subjects at the center of the screen.
 - Zoom functions other than optical zoom
 - AF illuminator
- When the focus mode is set to other than [Multi AF], you cannot use the Face Detection function.
- If Tracking focus is activated, the camera focuses with priority on the subject to be tracked.

Using Flexible Spot AF

This is useful when you shoot using a tripod and the subject not in the center of the frame.

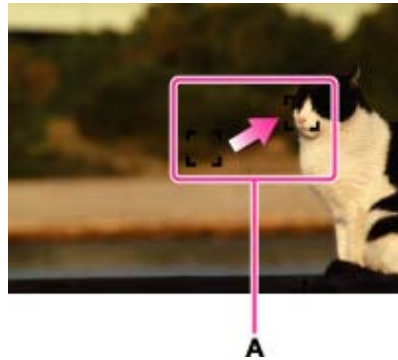

A: AF range finder frame (yellow: adjustable/white: fixed)

1. Adjust the position of the AF range finder frame where you want to focus, then press **OK**. To reset the setting, press **OK** again.

Notes

- Once you change the focus method, the AF range finder frame you set up is cleared.

Using Semi Manual/Manual Focus

This is useful when it is difficult to get the proper focus, such as shooting images through a window.

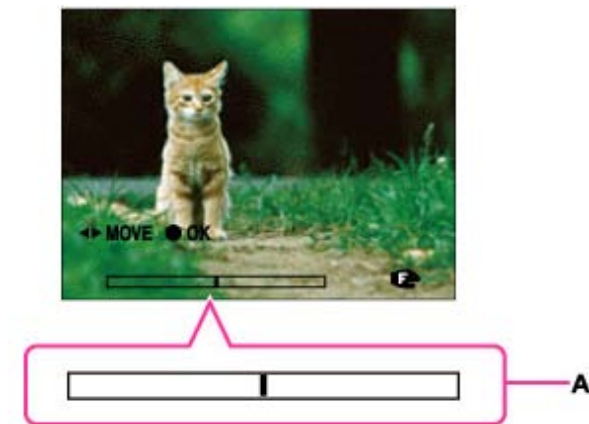

A: Manual Focus bar

1. Use the control wheel to set the desired focus distance on the manual focus bar, then press **OK**. To correct the setting, press **OK** again. Use **▲ / ▼ / ◀ / ▶** on the control wheel to set the position. You can turn the control wheel to make rough adjustments.

Notes

- If the focus distance is set very close, the image may show dust or fingerprints on the lens. Wipe the lens with a soft cloth, etc.
- The focus distance range is limited according to the zoom scaling.
- Once you change the focus method, the distance of the Manual Focus you set up is cleared.

Related Topic

[Tracking focus](#)





- ▶ Before Use
- ▶ Operating the camera
- ▶ Shooting
- ▶ Viewing
- ▶ Useful shooting functions
- ▶ Useful viewing functions
- ▶ Changing settings
- ▶ Viewing images on a TV
- ▶ Using with your computer
- ▶ Printing
- ▶ Troubleshooting
- ▶ Precautions / About this camera

[⇒ Contents list](#)

Metering Mode

Selects the metering mode that sets which part of the subject to measure to determine the exposure.

1. MENU →  (Metering Mode) → desired mode → ●

<input checked="" type="checkbox"/>	 (Multi)	Divides into multiple regions and measures each region. The camera determines a well-balanced exposure (Multi-pattern metering).
<input type="checkbox"/>	 (Center)	Measures the center of the image, and determines the exposure based on the brightness of the subject there (Center-weighted metering).
<input type="checkbox"/>	 (Spot)	Align the spot metering cross hairs (A) on the subject to meter one part of the subject (Spot metering). This function is useful when the subject is backlit or when there is strong contrast between the subject and the background. 

Notes

- In movie mode, the setting is fixed to [Multi].

Related Topic

[MENU items available for each shooting mode](#)

[▲ Back to top](#)



- ▶ Before Use
- ▶ Operating the camera
- ▶ Shooting
- ▶ Viewing
- ▶ Useful shooting functions
- ▶ Useful viewing functions
- ▶ Changing settings
- ▶ Viewing images on a TV
- ▶ Using with your computer
- ▶ Printing
- ▶ Troubleshooting
- ▶ Precautions / About this camera

[⇒ Contents list](#)

Cont. Shooting Interval

Selects the number of images taken per second for Burst shooting.
The camera shoots up to 10 continuous frames when you hold down the shutter button.

1. MENU →  (Cont. Shooting Interval) → desired mode → ●

<input checked="" type="checkbox"/>	 Hi (High)	Shoots from 2 to a maximum of 10 successive images.
<input type="checkbox"/>	 Lo (Low)	

Notes

- In slow shutter speed conditions, the burst of shots per second may be decreased.

Related Topic

[Cont. Shooting Settings](#)[MENU items available for each shooting mode](#)[▲ Back to top](#)

- ▶ Before Use
- ▶ Operating the camera
- ▶ Shooting
- ▶ Viewing
- ▶ Useful shooting functions
- ▶ Useful viewing functions
- ▶ Changing settings
- ▶ Viewing images on a TV
- ▶ Using with your computer
- ▶ Printing
- ▶ Troubleshooting
- ▶ Precautions / About this camera

[⇒ Contents list](#)

Bracket Setting

You can set the type of shooting when [Cont. Shooting/Self-Timer] is set to [Bracket] or [Self-Timer (Bracket)]. In the bracket shooting mode, you can record a series of 3 images with the setting changed. You can select the most suitable image afterwards.

1. MENU → ± 0.3 EV (Bracket Setting) → desired mode → ●

✓	± 0.3 EV (EXP ±0.3)	Records a series of 3 images with the exposure shifted in the following order: standard, dark, and bright. The larger the bracket step value, the larger the shift of the exposure value.
	± 0.7 EV (EXP ±0.7)	
	± 1.0 EV (EXP ±1.0)	
	BRK WB (White Balance)	Records a series of 3 images with the white balance shifted in the following order: current color tone, toward blue, and toward red. <ul style="list-style-type: none"> ● When you set [White Balance] to other than [Auto], the color tone is shifted based on the selected white balance.

Notes

- You cannot select [White Balance] when the mode dial is set to **SCN** (Scene Selection).

Related Topic

[Cont. Shooting Settings](#)[Self-Timer](#)[Functions available for each shooting mode](#)[MENU items available for each shooting mode](#)[▲ Back to top](#)

- ▶ Before Use
- ▶ Operating the camera
- ▶ Shooting
- ▶ Viewing
- ▶ Useful shooting functions
- ▶ Useful viewing functions
- ▶ Changing settings
- ▶ Viewing images on a TV
- ▶ Using with your computer
- ▶ Printing
- ▶ Troubleshooting
- ▶ Precautions / About this camera

[→ Contents list](#)

Scene Recognition

▼ Advanced mode

In Intelligent Auto mode, the camera automatically detects shooting conditions. When a motion is detected, the ISO sensitivity is increased according to the movement to reduce subject blur. When the camera is set to Intelligent Auto mode, you can select [Advanced] mode, in which the camera automatically shoots two images.



In Scene Recognition, the position of an icon displayed on the screen is different depending on the circumstances. It depends on whether the camera recognizes a scene or condition. If the camera recognizes a scene, icons and guides such as (Portrait), (Infant), (Night Portrait), (Night Scene), (Backlight Portrait), (Backlight), (Landscape), (Macro), (Spotlight) or (Low Light) are displayed on the first line. If the camera recognizes a condition, icons such as (Tripod), (Move) or (Walk) are displayed on the second line. The camera may recognize both the scene and condition, or just one.







1. MENU → (Scene Recognition) → desired mode → ●







✓	(Auto)	When the camera recognizes the scene, it switches to the optimal settings and shoots the image.
	(Advanced)	<p>When the camera recognizes the scene, it switches to the optimal settings. When the camera recognizes (Night Scene), (Night Portrait), (Backlight) or (Backlight Portrait), it automatically changes the setting and shoots another image.</p> <ul style="list-style-type: none"> When you shoot two images consecutively, the + mark on the icon will turn green. When [Anti Blink] is displayed, 2 images are taken automatically and the image with the eyes open is selected automatically. [Details]

Notes

- Scene Recognition function does not operate when you use zoom functions other than the optical zoom.
- The available flash settings are [Auto], [Advanced Flash] or [Off].
- These scenes may not be recognized depending on the situation.
- In Tracking focus mode, (Portrait), (Infant), (Night Portrait) or (Backlight Portrait) are not recognized.
- If the environment causes vibrations to be transferred to the camera when (Tripod) and (Night Scene) conditions are recognized at the same time, (Tripod) condition may not be recognized.
- Sometimes a slow shutter results when (Tripod) and (Night Scene) conditions are recognized at the same time. Keep the camera still during shooting.
- When shooting movies, Advanced mode is not available.



Advanced mode

In [Advanced] mode, the camera shoots two images consecutively with the different settings as follows when it recognizes  (Night Scene),  (Night Portrait),  (Backlight) or  (Backlight Portrait) scenes, which tend to blur or when  (Night Scene) and  (Tripod) conditions are recognized at the same time. You can select the desired image from the two images shot.

	First Image*	Second Image
	Shoots in Slow Synchro	Shoots with sensitivity increased and shake reduced
	Shoots in Slow Synchro with the face which the flash strobos on as guide	Shoots with sensitivity increased with the face as guide and shake reduced
 	Shoots in Slow Synchro	Shoots with a slower shutter speed without increasing sensitivity
	Shoots with the flash	Shoots with the brightness and contrast of the background adjusted
	Shoots with the face which the flash strobos on as guide	Shoots with the brightness and contrast of the face and the background adjusted

* When [Flash] is set to [Auto].

What is the Anti Blink function?

When set to [Advanced], the camera automatically shoots two images consecutively* when it recognizes  (Portrait) or  (Infant). The camera will select, display, and record the image which the eyes are not blinked automatically. If the eyes are closed in both images, the message “Blinked eye detected” is displayed.

* except when the flash strobos/when the shutter speed is slow.

Related Topic

[MENU items available for each shooting mode](#)

[▲ Back to top](#)

- ▶ Before Use
- ▶ Operating the camera
- ▶ Shooting
- ▶ Viewing
- ▶ Useful shooting functions
- ▶ Useful viewing functions
- ▶ Changing settings
- ▶ Viewing images on a TV
- ▶ Using with your computer
- ▶ Printing
- ▶ Troubleshooting
- ▶ Precautions / About this camera

[➡ Contents list](#)

Smile Shutter

When the camera detects a smile, the shutter is released automatically.



1. MENU → 😊 (Smile Shutter) → [On]
2. Wait for a smile to be detected.
When a smile is detected and the smile level exceeds the ◀ point on the indicator, the camera records images automatically.

☹️	ON (On)	Uses/Does not use the [Smile Shutter] function.
☑️	☹️ OFF (Off)	

💡 Tips for better capturing of smiles



- 1 Do not cover the eyes with the bangs. Do not obscure the face by hat, masks, sunglasses, etc.
 - 2 Try to orient the face in front of the camera and be as level as possible. Keep the eyes narrowed.
 - 3 Give a clear smile with an open mouth. The smile is easier to detect when the teeth are shown.
- The shutter operates when any person whose face is being detected smiles.
 - You can select or register the priority subject for face detection with [Face Detection]. When the selected face is registered in the camera memory, Smile Detection is performed only for that face. [\[Details\]](#)

- If a smile is not detected, select MENU → [Smile Detection Sensitivity], then set the value to [Slight Smile].

Notes

- Shooting using the Smile Shutter ends automatically when either the memory card or internal memory becomes full.
- Smiles may not be detected correctly depending on the conditions.
- The Smile Shutter function does not operate when you use zoom functions other than the optical zoom.

Related Topic

[Smile Detection Sensitivity](#)

[MENU items available for each shooting mode](#)

[▲ Back to top](#)

Copyright 2013 Sony Corporation

[Top page](#) > [Useful shooting functions](#) > [Menu items available for shooting](#) > [Smile Detection Sensitivity](#)

- ▶ Before Use
- ▶ Operating the camera
- ▶ Shooting
- ▶ Viewing
- ▶ Useful shooting functions
- ▶ Useful viewing functions
- ▶ Changing settings
- ▶ Viewing images on a TV
- ▶ Using with your computer
- ▶ Printing
- ▶ Troubleshooting
- ▶ Precautions / About this camera

[⇒ Contents list](#)

Smile Detection Sensitivity

Sets the sensitivity of the Smile Shutter function for detecting smiles.

1. MENU → 😊 (Smile Detection Sensitivity) → desired mode → ●

	😊 (Big Smile)	
✓	😊 (Normal Smile)	Detects a big, normal or slight smile.
	😊 (Slight Smile)	

Notes

- Smiles may not be detected correctly depending on the conditions.

Related Topic

[Smile Shutter](#)

[MENU items available for each shooting mode](#)

[▲ Back to top](#)

- ▶ Before Use
- ▶ Operating the camera
- ▶ Shooting
- ▶ Viewing
- ▶ Useful shooting functions
- ▶ Useful viewing functions
- ▶ Changing settings
- ▶ Viewing images on a TV
- ▶ Using with your computer
- ▶ Printing
- ▶ Troubleshooting
- ▶ Precautions / About this camera

[⇒ Contents list](#)



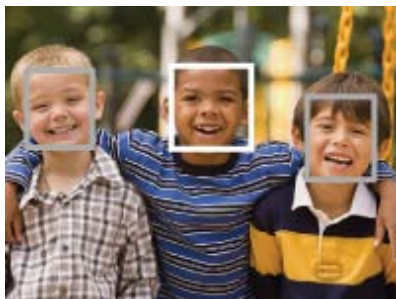

Face Detection

When the Face Detection function is used, the camera detects the faces of your subjects and adjusts the focus, flash, exposure, white balance and red-eye reduction settings automatically.



When the camera detects more than one subject, the camera will judge which is the main subject and set focus by priority. The frame for which the focus is set will turn green by pressing the shutter button halfway down.

1. MENU →  (Face Detection) → desired mode → ●

	[Off] (Off)	Cannot use Face Detection.
	 (Auto)	Selects the face the camera is to automatically focus on.
	(Child Priority)	Detects and shoots with priority on child's face.
	(Adult Priority)	Detects and shoots with priority on adult's face.

Notes

- [Off] is not available when [Self-Timer] is set to [Self-portrait One Person] or [Self-portrait Two People].
- You can select [Face Detection] only when the focus mode is set to [Multi AF] and the metering mode is set to [Multi].
- The Face Detection function does not work when you use zoom functions other than the optical zoom.
- Up to 8 faces of your subjects can be detected.
- Adults and children may not be recognized correctly depending on the conditions.
- During Smile Shutter shooting, [Face Detection] is automatically set to [Auto] even if it is set to [Off].

Related Topic

[Tracking focus](#)

[Functions available for each shooting mode](#)

[MENU items available for each shooting mode](#)

[▲ Back to top](#)











- ▶ Before Use
- ▶ Operating the camera
- ▶ Shooting
- ▶ Viewing
- ▶ Useful shooting functions
- ▶ Useful viewing functions
- ▶ Changing settings
- ▶ Viewing images on a TV
- ▶ Using with your computer
- ▶ Printing
- ▶ Troubleshooting
- ▶ Precautions / About this camera

[⇒ Contents list](#)

Color Mode

You can change the vividness of the image, and use special effects.

1. MENU →  (Color Mode) → desired mode → ●

✓  (Standard)	<p>Set the image to standard color.</p> 
 (Vivid)	<p>Set the image to bright and deep color.</p> 
 (Real)	<p>Set the image similar to real color.</p> 
 (Sepia)	<p>Set the image to sepia color.</p> 
 (B & W)	<p>Set the image to black and white.</p> 

Related Topic

[MENU items available for each shooting mode](#)

[▲ Back to top](#)

Copyright 2013 Sony Corporation



- ▶ Before Use
- ▶ Operating the camera
- ▶ Shooting
- ▶ Viewing
- ▶ Useful shooting functions
- ▶ Useful viewing functions
- ▶ Changing settings
- ▶ Viewing images on a TV
- ▶ Using with your computer
- ▶ Printing
- ▶ Troubleshooting
- ▶ Precautions / About this camera

[⇒ Contents list](#)

Color Saturation

Adjusts the vividness (color saturation) of the image.

1. MENU → [Color Saturation] → desired mode → ●

 (-)	Adjusts the vividness of the image.
<input checked="" type="checkbox"/>  (Standard)	
 (+)	

Related Topic

[MENU items available for each shooting mode](#)

[▲ Back to top](#)



- ▶ Before Use
- ▶ Operating the camera
- ▶ Shooting
- ▶ Viewing
- ▶ Useful shooting functions
- ▶ Useful viewing functions
- ▶ Changing settings
- ▶ Viewing images on a TV
- ▶ Using with your computer
- ▶ Printing
- ▶ Troubleshooting
- ▶ Precautions / About this camera

[⇒ Contents list](#)

Contrast

Adjusts the contrast of the image.

1. MENU → [Contrast] → desired mode → ●

	 (-)	Adjusts the contrast of the image.
<input checked="" type="checkbox"/>	 (Standard)	
	 (+)	

Related Topic

[MENU items available for each shooting mode](#)

[▲ Back to top](#)



- ▶ Before Use
- ▶ Operating the camera
- ▶ Shooting
- ▶ Viewing
- ▶ Useful shooting functions
- ▶ Useful viewing functions
- ▶ Changing settings
- ▶ Viewing images on a TV
- ▶ Using with your computer
- ▶ Printing
- ▶ Troubleshooting
- ▶ Precautions / About this camera

[⇒ Contents list](#)

Sharpness

Adjusts the sharpness of the image.

1. MENU → [Sharpness] → desired mode → ●

	(-)	Adjusts the sharpness of the image.
	(Standard)	
	(+)	

Related Topic

[MENU items available for each shooting mode](#)

[▲ Back to top](#)

- ▶ Before Use
- ▶ Operating the camera
- ▶ Shooting
- ▶ Viewing
- ▶ Useful shooting functions
- ▶ Useful viewing functions
- ▶ Changing settings
- ▶ Viewing images on a TV
- ▶ Using with your computer
- ▶ Printing
- ▶ Troubleshooting
- ▶ Precautions / About this camera

[⇒ Contents list](#)

Noise Reduction

Adjusts the resolution/noise balance of the recording images.

1. MENU → **NR_{STD}** (Noise Reduction) → desired mode → ●

	NR₋ (-)	Weakens noise reduction. This setting puts emphasis on resolution of images.
✓	NR_{STD} (Standard)	
	NR₊ (+)	Strengthens noise reduction. This setting puts emphasis on elimination of noise.

Notes

- Depending on the settings at the time of recording, the Noise Reduction level cannot be adjusted.

Related Topic

[MENU items available for each shooting mode](#)

[▲ Back to top](#)



- ▶ Before Use
- ▶ Operating the camera
- ▶ Shooting
- ▶ Viewing
- ▶ Useful shooting functions
- ▶ Useful viewing functions
- ▶ Changing settings
- ▶ Viewing images on a TV
- ▶ Using with your computer
- ▶ Printing
- ▶ Troubleshooting
- ▶ Precautions / About this camera

[⇒ Contents list](#)

Anti Blink

When Scene Selection is set to [Soft Skin] or [Soft Snap] and the subject blinks while you are shooting an image, the camera automatically shoots two images consecutively. The camera will select, display and record the image which the eyes are not blinked automatically.

1. MENU →  (Anti Blink) → desired mode → ●

	 (Auto)	When Face Detection is active, the Anti Blink function operates so that images with the subject's eyes open are recorded.
	(Off)	Does not use the Anti Blink function.

Notes

- Anti Blink does not function in the following situations:
 - When using the flash
 - During burst shooting
 - When the Face Detection function does not work
 - When the Smile Shutter function is activated
- Sometimes the Anti Blink function does not work depending on the situation.
- When the Anti Blink function is set to [Auto] but only images with the subject's eyes closed are recorded, the message "Blinked eye detected" is displayed on the screen. Shoot again as necessary.

Related Topic

[Scene Selection](#)[MENU items available for each shooting mode](#)[▲ Back to top](#)



- ▶ Before Use
- ▶ Operating the camera
- ▶ Shooting
- ▶ Viewing
- ▶ Useful shooting functions
- ▶ Useful viewing functions
- ▶ Changing settings
- ▶ Viewing images on a TV
- ▶ Using with your computer
- ▶ Printing
- ▶ Troubleshooting
- ▶ Precautions / About this camera

[⇒ Contents list](#)

Movie SteadyShot

The strength of the SteadyShot effect when shooting movies can be adjusted.

1. MENU →  (Movie SteadyShot) → desired mode → ●

	(Standard)	Reduces camera shake during movie shooting under stable conditions.
	(Active)	Reduces camera shake when shooting images while walking or zooming.

Notes

- If you change the setting for [Movie SteadyShot], the angle of view will change.

Related Topic

[Shooting movies](#)[MENU items available for each shooting mode](#)[▲ Back to top](#)

- ▶ Before Use
- ▶ Operating the camera
- ▶ Shooting
- ▶ Viewing
- ▶ Useful shooting functions
- ▶ Useful viewing functions
- ▶ Changing settings
- ▶ Viewing images on a TV
- ▶ Using with your computer
- ▶ Printing
- ▶ Troubleshooting
- ▶ Precautions / About this camera

[⇒ Contents list](#)

[Top page](#) > [Useful shooting functions](#) > [Menu items available for shooting](#) > [Position Information \(DSC-HX50V\)](#)

Position Information (DSC-HX50V)

The GPS triangulating status can be checked. Set the camera to triangulate when the position information is being displayed.

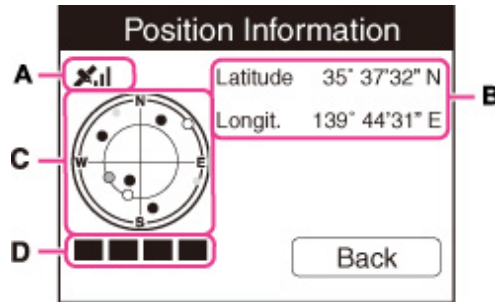

1. MENU →  (Position Information) → ●

The position information is displayed on your camera.



GPS indicators

The indicator (A) changes according to the strength of GPS signal reception when GPS is activated.

GPS indicators	Triangulating status	GPS reception status
No indicator	Off	[GPS setting] is set to [Off] or an error occurred.
	Difficult	Your camera cannot find a GPS signal, therefore, it cannot acquire the location information. Use your camera in an open area.
	Searching	Searching for GPS satellites. It may take several minutes to start triangulating.
	Triangulating	Your camera is receiving a GPS signal, and can acquire location information. Latitude and longitude (B) are displayed when triangulating.

Satellite and triangulating indicators

The satellite's position can be checked on the position information display (C). The satellite information acquisition status is displayed on the triangulating indicator (D). The triangulating indicator turns green when triangulation is successfully completed.

Notes

- Even when the camera acquires information from satellites, triangulation may take time or fail according to the time or place.
- Do not cover the GPS sensor with your finger when searching for GPS satellites or when triangulating. This decreases the sensitivity of the GPS sensor and triangulation may fail.

Related Topic

- [GPS setting \(DSC-HX50V\)](#)
- [GPS \(DSC-HX50V\)](#)

- ▶ Before Use
- ▶ Operating the camera
- ▶ Shooting
- ▶ Viewing
- ▶ Useful shooting functions
- ▶ Useful viewing functions
- ▶ Changing settings
- ▶ Viewing images on a TV
- ▶ Using with your computer
- ▶ Printing
- ▶ Troubleshooting
- ▶ Precautions / About this camera



[⇒ Contents list](#)

[Top page](#) > [Useful shooting functions](#) > [Menu items available for shooting](#) > [GPS Log REC \(DSC-HX50V\)](#)

GPS Log REC (DSC-HX50V)

You can set the camera to start and stop recording the route traveled by the camera. Even if the camera is not turned on, the route will be recorded.

To confirm the route, you will need a computer connected to the Internet and the software "PlayMemories Home."

1. Set the camera to shooting mode.
2. MENU →  (GPS Log REC) → ● → [OK]
3. To end [GPS Log REC], press MENU →  (GPS Log REC) → ● → [OK].

Notes

- If a memory card is not inserted into the camera or the memory card is full, [GPS Log REC] data cannot be saved.
- The recordable time for a route is up to 24 hours. If the recording time exceeds over 24 hours, recording will automatically stop.
- Sony does not collect location information and routing information.
- To display location information and routing information as a map on a computer, Sony provides data of location information and routing information to Google Inc.

Related Topic

[Dlt. GPS Log Data \(DSC-HX50V\)](#)

[MENU items available for each shooting mode](#)

[▲ Back to top](#)

- ▶ Before Use
- ▶ Operating the camera
- ▶ Shooting
- ▶ Viewing
- ▶ Useful shooting functions
- ▶ Useful viewing functions
- ▶ Changing settings
- ▶ Viewing images on a TV
- ▶ Using with your computer
- ▶ Printing
- ▶ Troubleshooting
- ▶ Precautions / About this camera

[⇒ Contents list](#)

Register Setting

▼ Items that can be registered

▼ To recall registered settings

Allows you to register up to 3 often-used modes or camera settings in the camera. You can recall the settings using [Memory recall mode].

1. Set the mode dial to **P** (Program Auto), **S** (Shutter Speed Priority Shooting), **A** (Aperture Priority Shooting), **M** (Manual Exposure Shooting) or **SCN** (Scene Selection).
2. Set the camera to the setting you want to register.
3. MENU → **MR**^{SET} (Register Setting) → desired number → ●

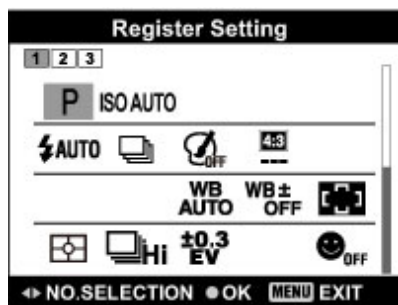

Notes

- When correcting settings, follow steps 2 – 3 again.

Items that can be registered

Available shooting settings are as follows:

- **P/S/A/M/SCN**
- **DISP** (OFF) (Flash)
- CUSTOM (Custom) button
- Shutter speed
- Aperture value (F value)
- Zoom scale
- MENU items (Shooting)

To recall registered settings

1. Set the mode dial to **MR** (Memory recall mode).
2. Press ◀ / ▶ to select the desired number → ●

Notes

- If you set **MR** (Memory recall mode) after completing the shooting settings, the registered settings are given priority and the original settings may become invalid. Check the indicators on the screen before shooting.

Memory recall mode
Memory recall mode
MENU items available for each shooting mode

[▲ Back to top](#)

Copyright 2013 Sony Corporation













- ▶ Before Use
- ▶ Operating the camera
- ▶ Shooting
- ▶ Viewing
- ▶ Useful shooting functions
- ▶ Useful viewing functions
- ▶ Changing settings
- ▶ Viewing images on a TV
- ▶ Using with your computer
- ▶ Printing
- ▶ Troubleshooting
- ▶ Precautions / About this camera

[→ Contents list](#)

[Top page](#) > [Useful viewing functions](#) > [Functions available for each view mode](#) > [MENU items available for each view mode](#)

MENU items available for each view mode

In the table below, a check mark indicates function that can be changed, while — indicates function that cannot be changed.

Menu items	Memory card				Internal Memory
	 Date View	 Folder view (Still)	 Folder view (MP4)	 AVCHD AVCHD view	Folder View
 (Send to Smartphone)	✓	—	—	—	✓
 (View on TV)	✓	✓	—	—	✓
 (Send to Computer)	✓	—	—	✓	—
 (Retouch)	✓	✓	—	—	✓
 (Picture Effect)	✓	✓	—	—	✓
 (Slideshow)	✓	✓	—	—	✓
 (Delete)	✓	✓	✓	✓	✓
 (3D Viewing)	✓	✓	—	—	✓
 (View Mode)	✓	✓	✓	✓	—
 (Display Cont. Shooting Group)	✓	—	—	—	—
 (Protect)	✓	✓	✓	✓	✓
Print (DPOF)	✓	✓	—	—	—
 (Rotate)	✓	✓	—	—	✓
 (In-Camera Guide)	✓	✓	✓	✓	✓
 (Settings)	✓	✓	✓	✓	✓

Notes

- Only the items that are available for each mode are displayed on the screen.

[▲ Back to top](#)

- ▶ Before Use
- ▶ Operating the camera
- ▶ Shooting
- ▶ Viewing
- ▶ Useful shooting functions
- ▶ Useful viewing functions
- ▶ Changing settings
- ▶ Viewing images on a TV
- ▶ Using with your computer
- ▶ Printing
- ▶ Troubleshooting
- ▶ Precautions / About this camera



[⇒ Contents list](#)

Send to Smartphone



Allows you to upload and transfer images to a smartphone.

Download the smartphone support application "PlayMemories Mobile" to your smartphone from the application store.

1. Switch to playback mode.
2. MENU →  (Send to Smartphone) → desired mode → ●
3. Operates according to the mode set.

 (Select on This Device)	<p>Select images on the camera to be transferred to the smartphone.</p> <p>① Select from [This Image], [All Imgs in This Cnt.Sht. Grp.], [All Images on This Date] or [Multiple Images].</p> <p>② [OK] → ●</p> <p>If you select [Multiple Images], select images, then press ● → MENU → [OK] → ● .</p>
 (Select on Smartphone)	<p>Uploads all still images in the internal memory or memory card.</p>

Notes

- Options for image size are the size in which the image was shot, [2M] or [VGA] format.
- To change the size of an image to be transferred to a smartphone, use "PlayMemories Mobile".
- Some images may not be played back on the smartphone depending on the data format.
- You cannot transfer AVCHD movies.
- When a memory card is inserted in the camera, [View Mode] is set to [Date View].
- The camera shares the connection information for [Send to Smartphone] with a device that has permission to connect. If you want to change the device that is permitted to connect to the camera, reset the connection information by pressing MENU →  (Settings) →  (Network Settings) → [SSID/PW Reset]. After resetting the connection information, you must set a smartphone.

[\[Details\]](#)

Related Topic

[Wi-Fi](#)[▲ Back to top](#)

- ▶ Before Use
- ▶ Operating the camera
- ▶ Shooting
- ▶ Viewing
- ▶ Useful shooting functions
- ▶ Useful viewing functions
- ▶ Changing settings
- ▶ Viewing images on a TV
- ▶ Using with your computer
- ▶ Printing
- ▶ Troubleshooting
- ▶ Precautions / About this camera

[⇒ Contents list](#)

View on TV

If the camera and TV are not connected using an HDMI cable, you can view images on a network-enabled TV by transferring the image from the camera. You may need to set the TV beforehand, depending on the model. For details, see the instruction manual of the TV.

1. Switch to playback mode.
2. MENU →  (View on TV) → desired device to be connected
3. When you want to play back images using slideshow, press ●.



- To play back images manually, press ◀ / ▶.
- To change the device to be connected, press ▼ to select [OPTION] → [Device list], and press ●.

Slideshow setting

You can change the settings for the slideshow by pressing ▼ → [Slideshow Set] → ●.

Playback Selection	Selects the group of images to be shown. The setting is fixed to [Folder] when the internal memory is used to record images. Folder View: Selects from [All] or [Folder]. Date View: Selects from [All] or [This Date].
Music*	Selects from [Music1] to [Music4] or [Muting].
Effects*	Selects from [On] and [Off].
Interval	Selects from [Short] to [Long].

* The settings are effective only for BRAVIA TV which is compatible with the functions.

Notes

- You can use this function on a TV that supports DLNA renderer.
- You can view images on a Wi-Fi Direct-enabled TV or network-enabled TV (including cable TV).
- If you connect TV and the camera and do not use Wi-Fi Direct, you need to register your access point on the camera first.
- Displaying the images on the TV may take time.
- Movies cannot be shown on TV using Wi-Fi. Use an HDMI cable (sold separately).
- Even if you transfer images shot in 3D Shooting mode to a TV, you cannot play them back as 3D images.
- Even if you set [Music] for slideshow settings to [Muting], sound may be produced. If this happens, confirm the music settings of TV.

- When burst images are transferred to a TV, the main image alone or all images will be transferred depending on the settings for [Display Cont. Shooting Group].

Related Topic

[WPS Push](#)

[Access point settings](#)

[▲ Back to top](#)

Copyright 2013 Sony Corporation

- ▶ Before Use
- ▶ Operating the camera
- ▶ Shooting
- ▶ Viewing
- ▶ Useful shooting functions
- ▶ Useful viewing functions
- ▶ Changing settings
- ▶ Viewing images on a TV
- ▶ Using with your computer
- ▶ Printing
- ▶ Troubleshooting
- ▶ Precautions / About this camera

[⇒ Contents list](#)

Send to Computer

You can easily back up images from the camera to a computer connected to your wireless access point or wireless broadband router.

Install "PlayMemories Home" [\[Details\]](#) before registering the wireless access point [\[Details\]](#) [\[Details\]](#).

1. Start your computer.
2. Switch to playback mode.
3. MENU →  (Send to Computer) → ●

Notes

- Depending on the application settings of your computer, the camera will turn off after saving the images to your computer.
- The images in the internal memory cannot be transferred.
- Set up the access point in advance.
- You can simultaneously transfer multiple images to a personal computer.
- To transfer images to another computer, use a USB cable to connect the camera to the personal computer, then operate the camera with "PlayMemories Home".

Related Topic

[WPS Push](#)

[Access point settings](#)

[▲ Back to top](#)





- ▶ Before Use
- ▶ Operating the camera
- ▶ Shooting
- ▶ Viewing
- ▶ Useful shooting functions
- ▶ Useful viewing functions
- ▶ Changing settings
- ▶ Viewing images on a TV
- ▶ Using with your computer
- ▶ Printing
- ▶ Troubleshooting
- ▶ Precautions / About this camera

[➔ Contents list](#)

Retouch

Retouches a recorded image and saves it as a new file. The original image is retained.

1. Switch to playback mode.
2. MENU →  (Retouch) → desired mode → ●
3. Perform retouching according to the operation method in each mode.

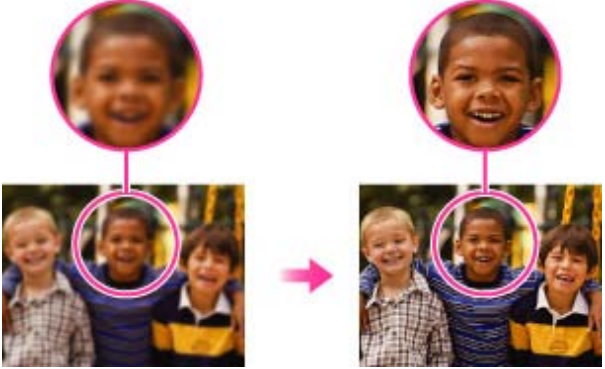
 (Trimming (Resize))	<p>Records the zoomed playback image.</p>  <ol style="list-style-type: none"> ① Turn the W/T (zoom) lever to the T () side to zoom in, and to the W side to zoom out. ② Set the zoom point using ▲ / ▼ / ◀ / ▶ . ③ MENU → select an image size to save → ● <ul style="list-style-type: none"> ● The quality of trimmed images may deteriorate. ● The image size that you can trim may vary depending on the image.
 (Unsharp masking)	<p>Sharpens the image within a chosen frame.</p>  <ol style="list-style-type: none"> ① Select the area (frame) of the desired image to retouch using ▲ / ▼ / ◀ / ▶ → MENU → [OK] → ● . <ul style="list-style-type: none"> ● Depending on the image, sufficient correction may not be applied and the image quality may deteriorate.

Notes

- You cannot retouch the following images:
 - Panoramic images
 - 3D images
 -

- Movies
- Images displayed in a burst group

[▲ Back to top](#)

Copyright 2013 Sony Corporation



- ▶ Before Use
- ▶ Operating the camera
- ▶ Shooting
- ▶ Viewing
- ▶ Useful shooting functions
- ▶ Useful viewing functions
- ▶ Changing settings
- ▶ Viewing images on a TV
- ▶ Using with your computer
- ▶ Printing
- ▶ Troubleshooting
- ▶ Precautions / About this camera

[➡ Contents list](#)

Picture Effect

Retouches a recorded image so that it looks like a watercolor or illustration, and saves it as a new file. The original image is retained.

1. Switch to playback mode.
2. MENU →  (Picture Effect) → desired mode → ●

 (Watercolor)	Adds ink bleed and gradational effects to images as if they were painted using watercolors.
 (Illustration)	Adds illustration-like effects to images by emphasizing the contours, etc.

Notes

- You cannot use [Picture Effect] for the following images:
 - Panoramic images
 - 3D images
 - Movies

[▲ Back to top](#)

- ▶ Before Use
- ▶ Operating the camera
- ▶ Shooting
- ▶ Viewing
- ▶ Useful shooting functions
- ▶ Useful viewing functions
- ▶ Changing settings
- ▶ Viewing images on a TV
- ▶ Using with your computer
- ▶ Printing
- ▶ Troubleshooting
- ▶ Precautions / About this camera

[⇒ Contents list](#)



Slideshow

▼ Continuous Playback

▼ Slideshow with music

Images are automatically played back in succession.

1. Switch to playback mode.
2. MENU →  (Slideshow) → desired slideshow → ●

 (Continuous Playback)	Starts playback from the currently displayed image.
 (Slideshow with music)	Plays back still images in succession along with effects and music.

Notes

- [Slideshow] is not available when [View Mode] is set to [Folder view (MP4)] or [AVCHD view].

Continuous Playback

1. Select the desired image for playing.
2. MENU →  (Slideshow) → [Continuous Playback] → ●
3. To change the playback method, follow the guide on the bottom of the screen.

Viewing panoramic images during continuous playback

The whole panoramic image is displayed for 3 seconds.

You can scroll a panoramic image by pressing ● .

Slideshow with music

1. MENU →  (Slideshow) → [Slideshow with music] → ●
Displays the setting screen.
2. Select a desired setting.
3. [Start] → ●
4. Press ● to end the slideshow.

Notes

- [Slideshow with music] is not available for the following images:
 - Panoramic images
 - 3D images recorded in [Standard] or [Wide] size

Playback Selection

Selects the group of images to be shown. The setting is fixed to [Folder] when the internal memory is used to record images.

<input checked="" type="checkbox"/>	All	Plays a slideshow of all the images in order.
	This Date	Plays a slideshow of images with the currently selected date range when View Mode is [Date View].
	Folder	Plays a slideshow of images in the currently selected folder in Folder View.

Effects		
Selects the playback speed and mood for slideshows. If the playback time of movie is long, an image is taken from it and displayed.		
<input checked="" type="checkbox"/>	Simple	A simple slideshow switching images at a preset interval. The playback interval is adjustable in [Interval] and you can thoroughly enjoy your images.
	Nostalgic	A moody slideshow reproducing the atmosphere of a movie scene.
	Stylish	A stylish slideshow proceeding at a middle tempo.
	Active	A high-tempo slideshow suitable for active scenes.

Music		
Specifies the music to be played during slideshows. You can select more than one background music track. Press ▼ to display the volume control screen, then press ◀ / ▶ to adjust the volume.		
<input checked="" type="checkbox"/>	Music1	The default setting for a [Simple] slideshow.
	Music2	The default setting for a [Nostalgic] slideshow.
	Music3	The default setting for a [Stylish] slideshow.
	Music4	The default setting for an [Active] slideshow.
	Muting	Does not use music.

Notes

- The movies are played back without their audio.

Interval		
Sets the screen switching interval. The setting is fixed to [Auto] when [Simple] is not selected as the [Effects].		
	1 sec	Sets the display interval of images for a [Simple] slideshow.
<input checked="" type="checkbox"/>	3 sec	
	5 sec	
	10 sec	
	Auto	The interval is set to suit the selected [Effects] item.

 **Selecting background music**

You can transfer a desired music file from your CDs or MP3 files to the camera to play back during slideshow. To transfer music, install the “Music Transfer” software to your computer.

Related Topic
[“Music Transfer”](#)







- ▶ Before Use
- ▶ Operating the camera
- ▶ Shooting
- ▶ Viewing
- ▶ Useful shooting functions
- ▶ Useful viewing functions
- ▶ Changing settings
- ▶ Viewing images on a TV
- ▶ Using with your computer
- ▶ Printing
- ▶ Troubleshooting
- ▶ Precautions / About this camera

[⇒ Contents list](#)

Delete

Allows you to select unwanted images for deletion. You can also delete images using the Delete button.

1. Switch to playback mode.
2. MENU →  (Delete) → desired mode → ●
3. [OK] → ●

 (All but This Image)	Deletes burst group images other than the selected image in Display Cont. Shooting Group mode.
 (All Imgs in This Cnt.Sht. Grp.)	Deletes all images in the selected burst group at once.
 (This Image)	Deletes the currently displayed image in single-image mode.
 (Multiple Images)	Allows you to select and delete multiple images. ① After step 2, select an image to be deleted, then press ● . To cancel the selection, press ● again to cancel the ✓ mark. ② MENU → [OK] → ●
 (All Images on This Date)  (All in This Folder)  (All AVCHD view files)	Deletes all still images and movies in the selected date range or folder, or all AVCHD movies at once.

Notes

- In Easy Mode, you can select from [1 image] or [All].
- When the internal memory is used to record images, View Mode is set to Folder View.

Related Topic

[Deleting images](#)[▲ Back to top](#)

- ▶ [Before Use](#)
- ▶ [Operating the camera](#)
- ▶ [Shooting](#)
- ▶ [Viewing](#)
- ▶ [Useful shooting functions](#)
- ▶ [Useful viewing functions](#)
- ▶ [Changing settings](#)
- ▶ [Viewing images on a TV](#)
- ▶ [Using with your computer](#)
- ▶ [Printing](#)
- ▶ [Troubleshooting](#)
- ▶ [Precautions / About this camera](#)

[⇒ Contents list](#)

3D Viewing

Select [3D Viewing] when you want to play back images shot in 3D mode on the 3D TV. Connect the camera and the 3D TV using an HDMI Cable (sold separately).

1. Switch to playback mode.
2. MENU →  (3D Viewing) → ●

Related Topic

[Viewing 3D images on a 3D TV](#)

[▲ Back to top](#)

- ▶ Before Use
- ▶ Operating the camera
- ▶ Shooting
- ▶ Viewing
- ▶ Useful shooting functions
- ▶ Useful viewing functions
- ▶ Changing settings
- ▶ Viewing images on a TV
- ▶ Using with your computer
- ▶ Printing
- ▶ Troubleshooting
- ▶ Precautions / About this camera





[⇒ Contents list](#)

View Mode

▼ Displaying the Calendar

Allows you to select the display format for images.





1. Switch to playback mode.
2. MENU →  (View Mode) → desired mode → ●

✓	 (Date View)	Displays images by date.
	 (Folder view (Still))	Displays still images.
	 (Folder view (MP4))	Displays MP4-format movies.
	 (AVCHD view)	Displays AVCHD-format movies.

Notes

- When the internal memory is used to record images, View Mode is set to Folder View.

■ Displaying the Calendar

1. MENU →  (View Mode) → [Date View] → ●
2. Turn the W/T (zoom) lever to W side () repeatedly until the Calendar is displayed. Select /, then select the month you want to display. Select the date and press ● to view images of the selected date in index mode.



[▲ Back to top](#)



- ▶ Before Use
- ▶ Operating the camera
- ▶ Shooting
- ▶ Viewing
- ▶ Useful shooting functions
- ▶ Useful viewing functions
- ▶ Changing settings
- ▶ Viewing images on a TV
- ▶ Using with your computer
- ▶ Printing
- ▶ Troubleshooting
- ▶ Precautions / About this camera

[⇒ Contents list](#)

Display Cont. Shooting Group

You can select to display burst images in groups or display all images during playback.

1. Switch to playback mode.
2. MENU →  (View Mode) → [Date View] → ●
3. MENU →  (Display Cont. Shooting Group) → desired mode → ●

  (Display Main Image Only)	<p>Groups burst images, then plays back the main image only.</p> <ul style="list-style-type: none"> ● When Face Detection is performed in burst mode, the camera determines and displays the optimum image as the main image. When Face Detection is not performed, the first image in the burst group is displayed as the main image.
 (Display All)	<p>Plays back all burst images one at a time.</p>

Related Topic

[Viewing burst images](#)

[▲ Back to top](#)

- ▶ Before Use
- ▶ Operating the camera
- ▶ Shooting
- ▶ Viewing
- ▶ Useful shooting functions
- ▶ Useful viewing functions
- ▶ Changing settings
- ▶ Viewing images on a TV
- ▶ Using with your computer
- ▶ Printing
- ▶ Troubleshooting
- ▶ Precautions / About this camera





[⇒ Contents list](#)

Protect

▼ To cancel the protection

Protects recorded images against accidental erasure. The  mark is displayed for registered images.

1. Switch to playback mode.
2. MENU →  (Protect) → desired mode → ●
3. [OK] → ●

 (This Image)	Protects the currently displayed image in single-image mode.
 (Multiple Images)	<p>You can select and protect multiple images.</p> <p>① After step 2, select an image to be protected, then press ● . To cancel the selection, press ● again to cancel the ✓ mark.</p> <p>② MENU → [OK] → ●</p>
 (Set All Cont. Shooting Imgs.)	Protect all images in the selected burst group at once in Display Cont. Shooting Group mode.
 (Rmv. All Cont. Shoot. Images.)	Release all protected images in the selected burst group at once in Display Cont. Shooting Group mode.

Notes

- When the internal memory is used to record images, View Mode is set to Folder View.

■ To cancel the protection

Select the image for which you want to cancel protection, and unlock it by pressing ● as the same procedure to protect it. The  indicator disappears, and the protection is released.

[▲ Back to top](#)

- ▶ Before Use
- ▶ Operating the camera
- ▶ Shooting
- ▶ Viewing
- ▶ Useful shooting functions
- ▶ Useful viewing functions
- ▶ Changing settings
- ▶ Viewing images on a TV
- ▶ Using with your computer
- ▶ Printing
- ▶ Troubleshooting
- ▶ Precautions / About this camera

[⇒ Contents list](#)



Print (DPOF)

▼ Clearing the DPOF mark

DPOF (Digital Print Order Format) is a function that allows you to specify the images of the memory card that you want to print out later.

The **DPOF** (Print order) mark is displayed for registered images.

1. Switch to playback mode.
2. MENU → Print (DPOF) → desired mode → ●

 (This Image)	Orders printing the currently displayed image in single-image mode.
 (Multiple Images)	<p>You can select and order multiple images to be printed.</p> <p>① After step 2, select an image to be printed, then press ● . To cancel the selection, press ● again to cancel the ✓ mark.</p> <p>② MENU → [OK] → ●</p>

Notes

- The **DPOF** (Print order) mark cannot be added to the following images:
 - Movies
 - Images in the internal memory
- You can add a **DPOF** (Print order) mark to a maximum 999 images.

Clearing the DPOF mark

Select the image to clear the DPOF registration, then press ● in the same procedure as when making a **DPOF** mark. The **DPOF** mark disappears and the DPOF registration is cleared.

Related Topic

[Printing still images](#)[▲ Back to top](#)

- ▶ Before Use
- ▶ Operating the camera
- ▶ Shooting
- ▶ Viewing
- ▶ Useful shooting functions
- ▶ Useful viewing functions
- ▶ Changing settings
- ▶ Viewing images on a TV
- ▶ Using with your computer
- ▶ Printing
- ▶ Troubleshooting
- ▶ Precautions / About this camera

[⇒ Contents list](#)

Rotate

Rotates a still image. Use this to display a horizontal orientation image in vertical orientation.



1. Switch to playback mode.
2. MENU →  (Rotate) → ●
3. Press ● .
The still image will be rotated counter-clockwise.
If you want to rotate the image again, repeat step 3.

Notes

- You cannot rotate the following images:
 - 3D images
 - Movies
 - Images displayed in a burst group
- You may not be able to rotate images shot with other cameras.
- When viewing images on a computer, the image rotation information may not be reflected depending on the software.

[▲ Back to top](#)

- ▶ Before Use
- ▶ Operating the camera
- ▶ Shooting
- ▶ Viewing
- ▶ Useful shooting functions
- ▶ Useful viewing functions
- ▶ Changing settings
- ▶ Viewing images on a TV
- ▶ Using with your computer
- ▶ Printing
- ▶ Troubleshooting
- ▶ Precautions / About this camera

[⇒ Contents list](#)

Movie format

You can set the recording method used to record movies.

1. Set the camera to shooting mode.
2. MENU →  (Settings) →  (Shooting Settings) → [Movie format] → desired mode → ●

✓	AVCHD	AVCHD movies are recorded. Sets the recording method to AVCHD, which is suitable for viewing smooth video images on a high-definition television. Blu-ray discs, AVCHD discs and DVD-Video discs can be created using the software “PlayMemories Home.” When you create AVCHD discs from movies recorded in [AVC HD 28M (PS)] or [AVC HD 24M (FX)], it will take time as the image quality must be converted. To save [AVC HD 28M (PS)] or [AVC HD 24M (FX)] movies without converting the image quality, use Blu-ray discs. [Details]
	MP4	MP4 (AVC) movies are recorded. Sets the recording method to MP4, which is suitable for WEB uploads and e-mail attachments. No discs can be created from MP4 movies, even if you use the software “PlayMemories Home.”

Related Topic

[AVCHD format](#)

[▲ Back to top](#)

- ▶ Before Use
- ▶ Operating the camera
- ▶ Shooting
- ▶ Viewing
- ▶ Useful shooting functions
- ▶ Useful viewing functions
- ▶ Changing settings
- ▶ Viewing images on a TV
- ▶ Using with your computer
- ▶ Printing
- ▶ Troubleshooting
- ▶ Precautions / About this camera

[⇒ Contents list](#)

AF Illuminator

The AF illuminator supplies fill light to focus more easily on a subject in dark surroundings. The AF illuminator emits red light allowing the camera to focus easily when the shutter button is pressed halfway, until the focus is locked.





The  ON indicator appears at this time.

1. Set the camera to shooting mode.
2. MENU →  (Settings) →  (Shooting Settings) → [AF Illuminator] → desired mode →



<input checked="" type="checkbox"/>	Auto	Uses/Does not use the AF illuminator.
<input type="checkbox"/>	Off	

Notes

- Focus is achieved as long as the AF illuminator light reaches the subject, regardless of whether light fails to reach the center of the subject.
- You cannot use the AF illuminator in the following situations:
 - In movie mode
 - In [iSweep Panorama]
 - When  (Landscape),  (Night Scene),  (Pet),  (Fireworks) or  (Advanced Sports Shooting) mode is selected in Scene Selection.
 - When [Self-Timer] is set to [Self-portrait One Person] or [Self-portrait Two People].
- When you use the AF illuminator, the normal AF range finder frame is disabled and a new AF range finder frame is displayed by a dotted line. AF operates with priority on subjects located near the center of the frame.
- The AF illuminator emits very bright light. Although there is no health hazard, do not look directly into the AF illuminator emitter at close range.

[▲ Back to top](#)

- ▶ Before Use
- ▶ Operating the camera
- ▶ Shooting
- ▶ Viewing
- ▶ Useful shooting functions
- ▶ Useful viewing functions
- ▶ Changing settings
- ▶ Viewing images on a TV
- ▶ Using with your computer
- ▶ Printing
- ▶ Troubleshooting
- ▶ Precautions / About this camera

[⇒ Contents list](#)

Grid Line

With reference to the grid lines, you can easily set a subject in a horizontal/vertical position.

1. Set the camera to shooting mode.
2. MENU →  (Settings) →  (Shooting Settings) → [Grid Line] → desired mode → ●

	On	Displays the grid lines. The grid lines are not recorded.
<input checked="" type="checkbox"/>	Off	Does not display the grid lines.

[▲ Back to top](#)

▶ Before Use
▶ Operating the camera
▶ Shooting
▶ Viewing
▶ Useful shooting functions
▶ Useful viewing functions
▶ Changing settings
▶ Viewing images on a TV
▶ Using with your computer
▶ Printing
▶ Troubleshooting
▶ Precautions / About this camera



[⇒ Contents list](#)

Clear Image Zoom

▼ Total zoom scale when [Clear Image Zoom] is selected (including 30x optical zoom)



[Clear Image Zoom] allows you to enlarge the image with close to the original image quality when shooting still images.

The camera zooms images with the original image quality first depending on the selected still image size. When [Clear Image Zoom] is set to [On], the camera automatically switches over to [Clear Image Zoom] when the zoom range without deterioration of the original image quality is exceeded.

1. Set the camera to shooting mode.
2. MENU →  (Settings) →  (Shooting Settings) → [Clear Image Zoom] → desired mode → ●

<input checked="" type="checkbox"/>	On	Zooms the images with close to the original image quality, depending on the image size. Switches to [Clear Image Zoom] within the range where  is displayed.
<input type="checkbox"/>	Off	Does not use [Clear Image Zoom].

Notes

- To zoom the images within the range where original image quality can be retained, set both [Clear Image Zoom] and [Digital Zoom] to [Off]. [\[Details\]](#)
- [Clear Image Zoom] function does not operate in the following situations:
 - In movie mode
 - In [iSweep Panorama]
 - In [Picture Effect]
 - In [Background Defocus]
 - When the Smile Shutter function is activated.
 - When [Cont. Shooting Settings] is set to [Continuous Shooting].
 - In [Photo Creativity].
 - When [Self-Timer] is set to [Self-portrait One Person], [Self-portrait Two People] or [Self-Timer: Continuous Shooting].
 - When  (Backlight Correction HDR) or  (Advanced Sports Shooting) mode is selected in Scene Selection.
- The Face Detection function does not operate in the range of [Clear Image Zoom].

Total zoom scale when [Clear Image Zoom] is selected (including 30x optical zoom)

The supported zoom scales are different depending on the image size.

Image size	Total zoom scale
20M	Approx. 60x
10M	Approx. 85x
5M	Approx. 120x
VGA	Approx. 486x

16:9(15M)	Approx. 60x
16:9(2M)	Approx. 162x

[▲ Back to top](#)

Copyright 2013 Sony Corporation

- ▶ Before Use
- ▶ Operating the camera
- ▶ Shooting
- ▶ Viewing
- ▶ Useful shooting functions
- ▶ Useful viewing functions
- ▶ Changing settings
- ▶ Viewing images on a TV
- ▶ Using with your computer
- ▶ Printing
- ▶ Troubleshooting
- ▶ Precautions / About this camera

[⇒ Contents list](#)

Digital Zoom



Sets the total zoom scale (including 30x optical zoom). When [Digital Zoom] is set to [On], the camera zooms images without deteriorating the original quality, but it automatically switches over to [Digital Zoom] when that zoom range (for achieving the original image quality) is exceeded.

When [Clear Image Zoom] is set to [On] to shoot still images, the camera automatically switches over to [Digital Zoom] when the [Clear Image Zoom] range is exceeded. [\[Details\]](#)

1. Set the camera to shooting mode.
2. MENU →  (Settings) →  (Shooting Settings) → [Digital Zoom] → desired mode → ●

On	The quality of the resulting image will deteriorate when  is displayed, since the zoom function is switched over to [Digital Zoom], but you can enlarge images 4x up to the maximum zoom scale.
<input checked="" type="checkbox"/> Off	Does not use [Digital Zoom].

Notes

- When using [Clear Image Zoom], the maximum zoom scale for [Digital Zoom] is 2x.
- [Digital Zoom] is not available in the following situations:
 - In [iSweep Panorama]
 - In [Picture Effect]
 - In [Background Defocus]
 - When the Smile Shutter function is activated.
 - When [Self-Timer] is set to [Self-portrait One Person] or [Self-portrait Two People].
 - In [Photo Creativity]
 - When  (Backlight Correction HDR) or  (Advanced Sports Shooting) mode is selected in Scene Selection.
- The Face Detection function does not operate in the range of [Digital Zoom].



[▲ Back to top](#)

- ▶ Before Use
- ▶ Operating the camera
- ▶ Shooting
- ▶ Viewing
- ▶ Useful shooting functions
- ▶ Useful viewing functions
- ▶ Changing settings
- ▶ Viewing images on a TV
- ▶ Using with your computer
- ▶ Printing
- ▶ Troubleshooting
- ▶ Precautions / About this camera

[⇒ Contents list](#)

Wind Noise Reduct.

Reduces the noise of the wind when shooting movies.

1. Set the camera to shooting mode.
2. MENU →  (Settings) →  (Shooting Settings) → [Wind Noise Reduct.] → desired mode
→ ●

<input type="checkbox"/>	On	Reduces/Does not reduce wind noise.
<input checked="" type="checkbox"/>	Off	

Notes

- If [Wind Noise Reduct.] is set to [On] even though the wind is not blowing strongly, the recorded sounds other than the wind may be hard to hear.

[▲ Back to top](#)

- ▶ Before Use
- ▶ Operating the camera
- ▶ Shooting
- ▶ Viewing
- ▶ Useful shooting functions
- ▶ Useful viewing functions
- ▶ Changing settings
- ▶ Viewing images on a TV
- ▶ Using with your computer
- ▶ Printing
- ▶ Troubleshooting
- ▶ Precautions / About this camera

[⇒ Contents list](#)

Micref Level

Selects the microphone level for recording.

1. Set the camera to shooting mode.
2. MENU →  (Settings) →  (Shooting Settings) → [Micref Level] → desired mode → ●

<input checked="" type="checkbox"/>	Normal	Records surrounding sounds within a fixed level. Suitable for recording daily conversations.
<input type="checkbox"/>	Low	Records surrounding sounds at actual level. Suitable for recording rich sound such as music at a concert.



[▲ Back to top](#)

- ▶ Before Use
- ▶ Operating the camera
- ▶ Shooting
- ▶ Viewing
- ▶ Useful shooting functions
- ▶ Useful viewing functions
- ▶ Changing settings
- ▶ Viewing images on a TV
- ▶ Using with your computer
- ▶ Printing
- ▶ Troubleshooting
- ▶ Precautions / About this camera

[➔ Contents list](#)

Red Eye Reduction

The flash strobos two or more times before shooting to reduce the red-eye phenomenon when using the flash.

1. Set the camera to shooting mode.
2. MENU →  (Settings) →  (Shooting Settings) → [Red Eye Reduction] → desired mode
→ ●

<input checked="" type="checkbox"/>	Auto	When the Face Detection function is activated, the flash strobos automatically to reduce the red-eye phenomenon.
<input type="checkbox"/>	On	The flash always strobos to reduce the red-eye phenomenon.
<input type="checkbox"/>	Off	Does not use Red Eye Reduction.

What causes the red-eye phenomenon?



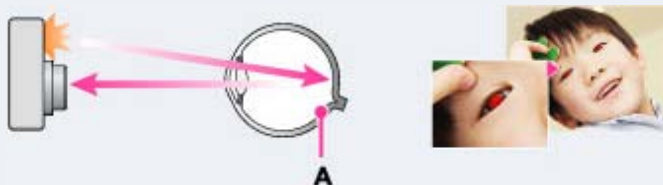





Pupils become dilated in dark environments. Flash light is reflected off the blood vessels at the back of the eye (retina) **(A)**, causing the “red-eye” phenomenon.



Other ways to reduce red-eye

- Select  (High Sensitivity) mode in Scene Selection. (The flash is set to [Off] automatically.)

Notes

- To avoid blurring of images, hold the camera firmly until the shutter is released. It usually takes a second until the shutter is released, and also be sure not to allow the subject to move during this period.
- Red Eye Reduction may not produce the desired effects. It depends on individual differences and conditions, such as distance to the subject, or if the subject looked away from the pre-strobe.
- If you do not use the Face Detection function, Red Eye Reduction does not work, even when you select [Auto].
- [Red Eye Reduction] is set to [Off] in the following situations:
 - In 3D shooting mode
 - When  (Background Defocus),  (Anti Motion Blur),  (Night Scene),  (Hand-held Twilight),  (High Sensitivity),  (Gourmet),  (Pet),  (Fireworks) or  (Advanced Sports Shooting) mode is selected in Scene Selection.
 - When Smile Shutter function is activated.

[▲ Back to top](#)

[▶ Before Use](#)[▶ Operating the camera](#)[▶ Shooting](#)[▶ Viewing](#)[▶ Useful shooting functions](#)[▶ Useful viewing functions](#)[▶ Changing settings](#)[▶ Viewing images on a TV](#)[▶ Using with your computer](#)[▶ Printing](#)[▶ Troubleshooting](#)[▶ Precautions / About this camera](#)[⇒ Contents list](#)

Blink Alert

When an image with the subject's eyes closed is recorded while Face Detection is activated, the message "Blinked eye detected" is displayed.

1. Set the camera to shooting mode.
2. MENU →  (Settings) →  (Shooting Settings) → [Blink Alert] → desired mode → ●

<input checked="" type="checkbox"/>	Auto	Displays/hides the "Blinked eye detected" message.
<input type="checkbox"/>	Off	

[▲ Back to top](#)

- ▶ Before Use
- ▶ Operating the camera
- ▶ Shooting
- ▶ Viewing
- ▶ Useful shooting functions
- ▶ Useful viewing functions
- ▶ Changing settings
- ▶ Viewing images on a TV
- ▶ Using with your computer
- ▶ Printing
- ▶ Troubleshooting
- ▶ Precautions / About this camera





[➡ Contents list](#)

Write Date

Sets whether to record a shooting date on the still image.



1. Set the camera to shooting mode.
2. MENU →  (Settings) →  (Shooting Settings) → [Write Date] → desired mode → ●

On ()	Records a shooting date. When [On] is selected, the  mark will appear on the screen while shooting. However, in some shooting modes that cannot record dates on images, the  mark will disappear.
 Off	Does not record a shooting date.

Notes

- You cannot record dates in the following situations:
 - In movie mode
 - When shooting still images while recording a movie (Dual Rec)
 - When shooting panoramic images
 - In burst shooting mode
 - In [Easy Mode]
 - In 3D shooting mode
- If you shot images with the date once, you cannot delete the date from the images later.
- The dates are doubly printed, if you set the camera to superimpose the dates when printing.
- The recorded time of the image cannot be superimposed on the image.

[▲ Back to top](#)

[▶ Before Use](#)[▶ Operating the camera](#)[▶ Shooting](#)[▶ Viewing](#)[▶ Useful shooting functions](#)[▶ Useful viewing functions](#)[▶ Changing settings](#)[▶ Viewing images on a TV](#)[▶ Using with your computer](#)[▶ Printing](#)[▶ Troubleshooting](#)[▶ Precautions / About this camera](#)[⇒ Contents list](#)

Expanded Focus

Expands the center part of the screen approximately 2x in Manual Focus mode.

1. Set the camera to shooting mode.

2. MENU →  (Settings) →  (Shooting Settings) → [Expanded Focus] → desired mode →



<input checked="" type="checkbox"/>	On	Expands/Does not expand approximately 2x.
<input type="checkbox"/>	Off	

[▲ Back to top](#)

- ▶ Before Use
- ▶ Operating the camera
- ▶ Shooting
- ▶ Viewing
- ▶ Useful shooting functions
- ▶ Useful viewing functions
- ▶ Changing settings
- ▶ Viewing images on a TV
- ▶ Using with your computer
- ▶ Printing
- ▶ Troubleshooting
- ▶ Precautions / About this camera

[➡ Contents list](#)

Custom Button

Set the often-used function to the CUSTOM (Custom) button.

1. Set the camera to shooting mode.
2. MENU →  (Settings) →  (Shooting Settings) → [Custom Button] → desired mode →



<input checked="" type="checkbox"/>	ISO	Sets the ISO.
<input type="checkbox"/>	White Balance	Sets the White Balance.
<input type="checkbox"/>	Metering Mode	Sets the Metering Mode.
<input type="checkbox"/>	Smile Shutter	Sets the Smile Shutter.

Notes

- [Custom Button] is not available in Easy Mode.
- During playback, the CUSTOM button function is fixed to [Send to Smartphone].

[▲ Back to top](#)

- ▶ Before Use
- ▶ Operating the camera
- ▶ Shooting
- ▶ Viewing
- ▶ Useful shooting functions
- ▶ Useful viewing functions
- ▶ Changing settings
- ▶ Viewing images on a TV
- ▶ Using with your computer
- ▶ Printing
- ▶ Troubleshooting
- ▶ Precautions / About this camera

[⇒ Contents list](#)

Disp. Resolution

Adjusts the image quality of the image displayed on the screen.

1. Set the camera to shooting mode.
2. MENU →  (Settings) →  (Shooting Settings) → [Disp. Resolution] → desired mode →



	Standard	Displays the image on the screen in standard image quality.
	High	Displays the image on the screen in high image quality. The battery power may decrease faster.

[▲ Back to top](#)

- ▶ Before Use
- ▶ Operating the camera
- ▶ Shooting
- ▶ Viewing
- ▶ Useful shooting functions
- ▶ Useful viewing functions
- ▶ Changing settings
- ▶ Viewing images on a TV
- ▶ Using with your computer
- ▶ Printing
- ▶ Troubleshooting
- ▶ Precautions / About this camera

[⇒ Contents list](#)

Beep

Selects the sound produced when you operate the camera.

1. MENU →  (Settings) →  (Main Settings) → [Beep] → desired mode → ●

	Shutter	Turns on the shutter sound when you press the shutter button.
<input checked="" type="checkbox"/>	On	Turns on the beep/shutter sound when operation buttons in addition to the shutter button are pressed.
<input type="checkbox"/>	Off	Turns off the beep/shutter sound.

[▲ Back to top](#)



- ▶ Before Use
- ▶ Operating the camera
- ▶ Shooting
- ▶ Viewing
- ▶ Useful shooting functions
- ▶ Useful viewing functions
- ▶ Changing settings
- ▶ Viewing images on a TV
- ▶ Using with your computer
- ▶ Printing
- ▶ Troubleshooting
- ▶ Precautions / About this camera

[⇒ Contents list](#)

Panel Brightness

You can select the screen brightness from levels 1 to 5. The screen becomes brighter as the number rises.

When you use the camera in bright outside light, select a higher number to see the screen easier.

1. MENU →  (Settings) →  (Main Settings) → [Panel Brightness] → desired mode → ●

Notes

- The brighter the screen, the faster the battery pack runs out.
- The screen grows dark if you do not operate the camera while the power is on.
- When the high-temperature indicator () is displayed, the screen may grow dark regardless of the settings. [\[Details\]](#)



[▲ Back to top](#)

- ▶ Before Use
- ▶ Operating the camera
- ▶ Shooting
- ▶ Viewing
- ▶ Useful shooting functions
- ▶ Useful viewing functions
- ▶ Changing settings
- ▶ Viewing images on a TV
- ▶ Using with your computer
- ▶ Printing
- ▶ Troubleshooting
- ▶ Precautions / About this camera

[⇒ Contents list](#)

Language Setting

Selects the language to be used in the menu items, warnings and messages.

1. MENU →  (Settings) →  (Main Settings) → [Language Setting] → desired mode → ●

[▲ Back to top](#)

- ▶ Before Use
- ▶ Operating the camera
- ▶ Shooting
- ▶ Viewing
- ▶ Useful shooting functions
- ▶ Useful viewing functions
- ▶ Changing settings
- ▶ Viewing images on a TV
- ▶ Using with your computer
- ▶ Printing
- ▶ Troubleshooting
- ▶ Precautions / About this camera

[⇒ Contents list](#)

Display color

Sets the color of the screen display.

1. MENU →  (Settings) →  (Main Settings) → [Display color] → desired mode → ●

<input checked="" type="checkbox"/>	Black	Sets the background color of the screen.
<input type="checkbox"/>	White	
<input type="checkbox"/>	Pink	

[▲ Back to top](#)

- ▶ Before Use
- ▶ Operating the camera
- ▶ Shooting
- ▶ Viewing
- ▶ Useful shooting functions
- ▶ Useful viewing functions
- ▶ Changing settings
- ▶ Viewing images on a TV
- ▶ Using with your computer
- ▶ Printing
- ▶ Troubleshooting
- ▶ Precautions / About this camera

[⇒ Contents list](#)

Demo Mode

You can set whether to use a demonstration of Smile Shutter or AVCHD movie playback. When there is no need to view a demonstration, set to [Off].

1. MENU →  (Settings) →  (Main Settings) → [Demo Mode] → desired mode → ●

	Demo Mode1	A demonstration of the shooting functions will be performed.
	Demo Mode2	Automatically starts the Smile Shutter demonstration when no operation is performed for 15 seconds.
	Demo Mode3	If no operation is performed for a set period of time while the camera is connected to an HD TV, a demonstration of AVCHD movie playback will automatically be performed.
	Off	Does not perform a demonstration.

Notes

- Pressing the shutter button during the Smile Shutter demonstration operates the shutter, but no image is recorded.
- During a demonstration, if the number of images saved in the internal memory increases, the camera may automatically delete the images. It is recommended to make a backup copy of the images on the internal memory before a demonstration.



[▲ Back to top](#)

- ▶ Before Use
- ▶ Operating the camera
- ▶ Shooting
- ▶ Viewing
- ▶ Useful shooting functions
- ▶ Useful viewing functions
- ▶ Changing settings
- ▶ Viewing images on a TV
- ▶ Using with your computer
- ▶ Printing
- ▶ Troubleshooting
- ▶ Precautions / About this camera

[⇒ Contents list](#)

Initialize

Initializes the setting to the default setting.
Even if you execute this function, the images are retained.

1. MENU →  (Settings) →  (Main Settings) → [Initialize] → desired mode → [OK] → ●

<input checked="" type="checkbox"/>	REC Settings	This operation will reset the settings made at the time of shooting to default settings.
	All Settings	Resets all settings to default settings.
	Network Settings	Resets all network settings.

Notes

- Be sure not to remove the battery pack while initializing.



[▲ Back to top](#)

- ▶ Before Use
- ▶ Operating the camera
- ▶ Shooting
- ▶ Viewing
- ▶ Useful shooting functions
- ▶ Useful viewing functions
- ▶ **Changing settings**
- ▶ Viewing images on a TV
- ▶ Using with your computer
- ▶ Printing
- ▶ Troubleshooting
- ▶ Precautions / About this camera

[⇒ Contents list](#)

Function Guide

You can select whether or not the function guide is displayed when you operate the camera.

1. MENU →  (Settings) →  (Main Settings) → [Function Guide] → desired mode → ●

<input checked="" type="checkbox"/>	On	Displays/hides the function guide.
<input type="checkbox"/>	Off	



[▲ Back to top](#)

- ▶ Before Use
- ▶ Operating the camera
- ▶ Shooting
- ▶ Viewing
- ▶ Useful shooting functions
- ▶ Useful viewing functions
- ▶ Changing settings
- ▶ Viewing images on a TV
- ▶ Using with your computer
- ▶ Printing
- ▶ Troubleshooting
- ▶ Precautions / About this camera

[⇒ Contents list](#)

HDMI Resolution

When you connect the camera to a High Definition (HD) TV with HDMI terminals using an HDMI Cable (sold separately), you can select HDMI Resolution to output images to the TV.

1. MENU →  (Settings) →  (Main Settings) → [HDMI Resolution] → desired mode → ●

	Auto	The camera automatically recognizes an HD TV and sets the output resolution.
	1080p	Outputs signals in HD picture quality (1080p).
	1080i	Outputs signals in HD picture quality (1080i).

Notes

- If you cannot display the screen properly with the [Auto] setting, select either [1080i] or [1080p] depending on the TV to be connected.



[▲ Back to top](#)

- ▶ Before Use
- ▶ Operating the camera
- ▶ Shooting
- ▶ Viewing
- ▶ Useful shooting functions
- ▶ Useful viewing functions
- ▶ Changing settings
- ▶ Viewing images on a TV
- ▶ Using with your computer
- ▶ Printing
- ▶ Troubleshooting
- ▶ Precautions / About this camera

[⇒ Contents list](#)

CTRL FOR HDMI

This setting allows (TV) remote control of a camera that is connected to a “BRAVIA” Sync TV using the HDMI Cable (sold separately).

1. MENU →  (Settings) →  (Main Settings) → [CTRL FOR HDMI] → desired mode → ●

<input checked="" type="checkbox"/>	On	Enables/disables remote-controlled operation.
<input type="checkbox"/>	Off	

Notes

- You can perform the operation of the camera with the remote controller of your TV by connecting your camera to a “BRAVIA” Sync-compatible TV.

Related Topic

[Viewing an image on a “BRAVIA” Sync-compatible TV](#)



[▲ Back to top](#)

- ▶ Before Use
- ▶ Operating the camera
- ▶ Shooting
- ▶ Viewing
- ▶ Useful shooting functions
- ▶ Useful viewing functions
- ▶ Changing settings
- ▶ Viewing images on a TV
- ▶ Using with your computer
- ▶ Printing
- ▶ Troubleshooting
- ▶ Precautions / About this camera

[➡ Contents list](#)

USB Connect Setting

Selects the USB mode when connecting the camera to a computer or a USB device using the micro USB cable.

1. MENU →  (Settings) →  (Main Settings) → [USB Connect Setting] → desired mode →

	Auto	Depending on the computer or other USB devices you connect to the camera, the connection mode is automatically selected from [MTP] or [Mass Storage]. When you use Windows 7 or Windows 8, [MTP] is selected and Windows 7 or Windows 8-specific functions become available.
	MTP	Establishes a MTP connection between the camera and a computer or other USB devices. When you use Windows 7 or Windows 8, [MTP] is selected and specific functions become available. When you use other operating systems (Vista/XP, Mac OS X), the AutoPlay Wizard appears, and the still images in the recording folder on the camera are imported to the computer.
	Mass Storage	Establishes a Mass Storage connection between the camera and a computer or other USB device.

Notes

- If Device Stage* does not appear when connecting the camera to a Windows 7 or Windows 8 computer, set [USB Connect Setting] to [Auto].
- * Device Stage is a menu screen to manage connected devices, such as a camera. (Function of Windows 7 or Windows 8)



[▲ Back to top](#)

- ▶ Before Use
- ▶ Operating the camera
- ▶ Shooting
- ▶ Viewing
- ▶ Useful shooting functions
- ▶ Useful viewing functions
- ▶ Changing settings
- ▶ Viewing images on a TV
- ▶ Using with your computer
- ▶ Printing
- ▶ Troubleshooting
- ▶ Precautions / About this camera

[⇒ Contents list](#)

USB Power Supply

Set whether to use the USB power supplied function when the camera is connected to a computer or a USB device using the micro USB cable.

1. MENU →  (Settings) →  (Main Settings) → [USB Power Supply] → desired mode →



<input checked="" type="checkbox"/>	On	Power is supplied when connected using the micro USB cable.
<input type="checkbox"/>	Off	Disables USB power supplied function even if you connect the camera to a device such as a computer using a micro USB cable.

[▲ Back to top](#)

- ▶ Before Use
- ▶ Operating the camera
- ▶ Shooting
- ▶ Viewing
- ▶ Useful shooting functions
- ▶ Useful viewing functions
- ▶ Changing settings
- ▶ Viewing images on a TV
- ▶ Using with your computer
- ▶ Printing
- ▶ Troubleshooting
- ▶ Precautions / About this camera

[⇒ Contents list](#)

LUN Setting

Sets the display method for the recording media displayed on a computer screen or other monitor when the camera is connected with a computer or AV component using a USB connection.

1. MENU →  (Settings) →  (Main Settings) → [LUN Setting] → desired mode → ●

<input checked="" type="checkbox"/>	Multi	The images both on the memory card and in the internal memory are displayed. Select this setting when you connect the camera to a computer.
<input type="checkbox"/>	Single	When the memory card is inserted into the camera, the images on the memory card are displayed; when it is not inserted, the images in the internal memory are displayed. Select this setting in cases where the images of both the memory card and the internal memory are not displayed when the camera is connected to a device other than a computer.



[▲ Back to top](#)

- ▶ Before Use
- ▶ Operating the camera
- ▶ Shooting
- ▶ Viewing
- ▶ Useful shooting functions
- ▶ Useful viewing functions
- ▶ Changing settings
- ▶ Viewing images on a TV
- ▶ Using with your computer
- ▶ Printing
- ▶ Troubleshooting
- ▶ Precautions / About this camera

[⇒ Contents list](#)

Download Music

You can change background music tracks using “Music Transfer”.

1. MENU →  (Settings) →  (Main Settings) → [Download Music] → ●
The message “Connect to PC” is displayed.
2. Make a USB connection between the camera and a computer, then start “Music Transfer”.
3. Follow the instructions on the screen to change music files.

[▲ Back to top](#)

- ▶ Before Use
- ▶ Operating the camera
- ▶ Shooting
- ▶ Viewing
- ▶ Useful shooting functions
- ▶ Useful viewing functions
- ▶ Changing settings
- ▶ Viewing images on a TV
- ▶ Using with your computer
- ▶ Printing
- ▶ Troubleshooting
- ▶ Precautions / About this camera

[⇒ Contents list](#)

Empty Music

You can delete all the background music files stored in the camera. It can be used in cases such as when the background music files are damaged and cannot be played.

1. MENU →  (Settings) →  (Main Settings) → [Empty Music] → [OK] → ●

Related Topic

[“Music Transfer”](#)



[▲ Back to top](#)

- ▶ [Before Use](#)
- ▶ [Operating the camera](#)
- ▶ [Shooting](#)
- ▶ [Viewing](#)
- ▶ [Useful shooting functions](#)
- ▶ [Useful viewing functions](#)
- ▶ [Changing settings](#)
- ▶ [Viewing images on a TV](#)
- ▶ [Using with your computer](#)
- ▶ [Printing](#)
- ▶ [Troubleshooting](#)
- ▶ [Precautions / About this camera](#)

[⇒ Contents list](#)

Airplane Mode

When you board an airplane, etc., you can set whether to disable all the settings using functions related to GPS (DSC-HX50V) and Wi-Fi. If you set [Airplane Mode] to [On], an airplane mark will be displayed on the screen.

1. MENU →  (Settings) →  (Main Settings) → [Airplane Mode] → desired mode → ●

Related Topic

[Position Information \(DSC-HX50V\)](#)

[GPS setting \(DSC-HX50V\)](#)

[GPS assist data \(DSC-HX50V\)](#)

[▲ Back to top](#)

- ▶ Before Use
- ▶ Operating the camera
- ▶ Shooting
- ▶ Viewing
- ▶ Useful shooting functions
- ▶ Useful viewing functions
- ▶ Changing settings
- ▶ Viewing images on a TV
- ▶ Using with your computer
- ▶ Printing
- ▶ Troubleshooting
- ▶ Precautions / About this camera

[→ Contents list](#)

GPS setting (DSC-HX50V)

▼ Checking triangulating status

The built-in GPS sensor of this camera acquires the information on location, and records it on images. Using the software "PlayMemories Home," you can import photos and movies recorded with location information to a computer and enjoy viewing them with a map which shows their shooting location. See "PlayMemories Home Help Guide" for details.

1. MENU →  (Settings) →  (Main Settings) → [GPS setting] → desired mode → ●

On	GPS setting is activated.
✔ Off	GPS setting is inactivated. Set this to not record location information.

To receive a GPS signal



- Proper triangulation is not possible indoors or near tall buildings. Use your camera in an open area outside, and turn on your camera again.
- If no triangulation icon appears, even if you wait for several minutes, you may be in an area where GPS signal reception is difficult or impossible. Begin shooting where you are, or move to an open area outside. If you shoot where you are, no location information will be recorded.



Notes

- During take off and landing of an airplane, set [Airplane Mode] to [On].
- Use GPS in accordance with the regulations of the place or situation.
- It may take from several tens of seconds to several minutes to acquire the location information when you use the GPS for the first time or use it again after long intervals. Triangulating time can be shortened by taking in GPS assist data. [\[Details\]](#)
- Do not cover the GPS sensor with your finger when searching for GPS satellites or when triangulating. This decreases the sensitivity of the GPS sensor and triangulation may fail.

Checking triangulating status

The indicator changes according to the strength of GPS signal reception when GPS is activated. The triangulating status can also be checked using [Position Information]. [\[Details\]](#)

Triangulating status	GPS indicators	GPS reception status
Off	No indicator	[GPS setting] is set to [Off] or an error occurred.

Difficult		Your camera cannot find a GPS signal, therefore, it cannot acquire the location information. Use your camera in an open area.
Searching		Searching for GPS satellites. It may take several minutes to start triangulating.
Triangulating		Your camera is receiving a GPS signal, and can acquire location information.

Related Topic

[Position Information \(DSC-HX50V\)](#)

[GPS assist data \(DSC-HX50V\)](#)

[Auto Clock ADJ \(DSC-HX50V\)](#)

[Auto Area ADJ \(DSC-HX50V\)](#)

[GPS \(DSC-HX50V\)](#)

[▲ Back to top](#)

Copyright 2013 Sony Corporation

- ▶ Before Use
- ▶ Operating the camera
- ▶ Shooting
- ▶ Viewing
- ▶ Useful shooting functions
- ▶ Useful viewing functions
- ▶ Changing settings
- ▶ Viewing images on a TV
- ▶ Using with your computer
- ▶ Printing
- ▶ Troubleshooting
- ▶ Precautions / About this camera

[⇒ Contents list](#)

GPS assist data (DSC-HX50V)

The time for the GPS acquiring location information can be shortened by taking in GPS assist data. The state of GPS assist data can be checked on the camera.

If connection via internet is made using the software, "PlayMemories Home," the GPS assist data can be updated automatically.

1. MENU →  (Settings) →  (Main Settings) → [GPS assist data] → ●

Using the GPS support tool

You can also update the GPS assist data by inserting a memory card into the computer. Display the main screen of the "PlayMemories Home," and select the connected model name → [GPS Support Tool] → the desired memory card drive to be installed from your computer, and then update the GPS assist data. If you insert this memory card, the GPS assist data will be reflected on the camera.

Notes

- If [Date & Time Setting] is not set, or set time is shifted greatly, the time for the GPS acquiring location information cannot be shortened.
Set the date and time correctly by MENU →  (Settings) → [Date & Time Setting].
- If the term of validity of GPS assist data has run out, the time until you can record location information cannot be shortened.

Related Topic

[GPS setting \(DSC-HX50V\)](#)

[GPS \(DSC-HX50V\)](#)



[▲ Back to top](#)

- ▶ [Before Use](#)
- ▶ [Operating the camera](#)
- ▶ [Shooting](#)
- ▶ [Viewing](#)
- ▶ [Useful shooting functions](#)
- ▶ [Useful viewing functions](#)
- ▶ [Changing settings](#)
- ▶ [Viewing images on a TV](#)
- ▶ [Using with your computer](#)
- ▶ [Printing](#)
- ▶ [Troubleshooting](#)
- ▶ [Precautions / About this camera](#)

[⇒ Contents list](#)

Dlt. GPS Log Data (DSC-HX50V)

You can delete all data recorded in [GPS Log REC].

1. MENU →  (Settings) →  (Main Settings) → [Dlt. GPS Log Data] → [OK] → ●

Related Topic

[GPS Log REC \(DSC-HX50V\)](#)

[▲ Back to top](#)

- ▶ Before Use
- ▶ Operating the camera
- ▶ Shooting
- ▶ Viewing
- ▶ Useful shooting functions
- ▶ Useful viewing functions
- ▶ Changing settings
- ▶ Viewing images on a TV
- ▶ Using with your computer
- ▶ Printing
- ▶ Troubleshooting
- ▶ Precautions / About this camera

[→ Contents list](#)





Eye-Fi

▼ Transferring image data using the Eye-Fi card

Sets whether to use the upload function of an Eye-Fi card (commercially available), when you use the Eye-Fi card with this camera.

[Eye-Fi] is displayed only when the Eye-Fi card is inserted in the camera.

1. MENU →  (Settings) →  (Main Settings) → [Eye-Fi] → desired mode → ●

✓	On	<p>Uses the upload function. The Eye-Fi mode display icon on the screen will change depending on the communication mode of the Eye-Fi card.</p> <ul style="list-style-type: none"> : Eye-Fi card is in standby mode. There is no image to be sent. : Eye-Fi card is in upload standby mode. : Eye-Fi card is in connecting mode. : Eye-Fi card is uploading images. : An error has occurred.
	Off	Does not use the upload function.



Notes

- As of December 2012, Eye-Fi cards are sold in the U.S.A., Canada, Japan and some countries in the European Union.
- For more information on the Eye-Fi card, contact the manufacturer or seller of Eye-Fi cards directly.
- Eye-Fi cards are permitted only in the countries and regions in which they were purchased. You may be held liable due to local restrictions.
- The Eye-Fi card has a wireless LAN function. Do not insert the Eye-Fi card where wireless LAN is prohibited, such as while aboard an airplane. If the Eye-Fi card is inserted, set [Airplane Mode] to [On]. When the uploading function of the Eye-Fi card is set to [Off],  OFF is displayed on the screen.

Transferring image data using the Eye-Fi card

1. Set the wireless LAN access point settings or the transferring direction settings of the Eye-Fi card. For details, refer to the operating instructions supplied with the Eye-Fi card.
2. After the settings are finished, insert the Eye-Fi card into the camera, and shoot the images. The recorded images are automatically transferred via the wireless LAN to the PC, etc.

Notes

- When uploading image data, [Power Save] is not available.
- If the  (error) icon is displayed, eject and re-insert the Eye-Fi card, or turn the power of the camera off and on again. If the  (error) icon is still displayed, the Eye-Fi card may be corrupted. For details, contact Eye-Fi, Inc.
- Wireless LAN communication may be interrupted by the other communication devices. If data reception is insufficient, move the camera closer to the access point.
- Some Eye-Fi cards have an “Endless Memory Mode.” This product does not support “Endless Memory Mode.” Make sure that Eye-Fi cards that you insert into this product have “Endless

Memory Mode” turned off. For details on setting “Endless Memory Mode”, refer to the operating instructions supplied with the Eye-Fi card.

[▲ Back to top](#)

Copyright 2013 Sony Corporation

- ▶ Before Use
- ▶ Operating the camera
- ▶ Shooting
- ▶ Viewing
- ▶ Useful shooting functions
- ▶ Useful viewing functions
- ▶ Changing settings
- ▶ Viewing images on a TV
- ▶ Using with your computer
- ▶ Printing
- ▶ Troubleshooting
- ▶ Precautions / About this camera

[➔ Contents list](#)

Power Save

Sets the length of time until the screen goes dark and the time until the camera turns off.

If you do not operate the camera for a certain period of time while the power is on using the battery pack, the screen goes dark and the camera later turns off automatically to prevent wearing down the battery pack (Auto power-off function).

1. MENU →  (Settings) →  (Main Settings) → [Power Save] → desired mode → ●

	Max	Saves battery power better than when set to [Standard]. If the camera is not operated for a certain period of time, the power turns off automatically. In shooting mode, the screen automatically goes dark before the power turns off.
	Standard	If the camera is not operated for a certain period of time, the power turns off automatically. In shooting mode, the screen automatically goes dark before the power turns off. It takes longer before the power turns off than when set to [Max].
	Off	Does not use the Auto power-off function.

Notes

- The camera does not enter Power Save under conditions such as during a slideshow, when recording movies or when the camera is connected to a computer.



[▲ Back to top](#)

- ▶ [Before Use](#)
- ▶ [Operating the camera](#)
- ▶ [Shooting](#)
- ▶ [Viewing](#)
- ▶ [Useful shooting functions](#)
- ▶ [Useful viewing functions](#)
- ▶ [Changing settings](#)
- ▶ [Viewing images on a TV](#)
- ▶ [Using with your computer](#)
- ▶ [Printing](#)
- ▶ [Troubleshooting](#)
- ▶ [Precautions / About this camera](#)

[⇒ Contents list](#)

Version

Displays the software version installed on this camera.

1. MENU →  (Settings) →  (Main Settings) → [Version] → ●

[▲ Back to top](#)



[Top page](#) > [Changing settings](#) > [Main Settings](#) > [Certification Logo \(Overseas model only\)](#)

- ▶ Before Use
- ▶ Operating the camera
- ▶ Shooting
- ▶ Viewing
- ▶ Useful shooting functions
- ▶ Useful viewing functions
- ▶ Changing settings
- ▶ Viewing images on a TV
- ▶ Using with your computer
- ▶ Printing
- ▶ Troubleshooting
- ▶ Precautions / About this camera

[⇒ Contents list](#)

Certification Logo (Overseas model only)

The certification can be displayed on the camera.

1. MENU →  (Settings) →  (Main Settings) → [Certification Logo] → ●



[▲ Back to top](#)

- ▶ Before Use
- ▶ Operating the camera
- ▶ Shooting
- ▶ Viewing
- ▶ Useful shooting functions
- ▶ Useful viewing functions
- ▶ Changing settings
- ▶ Viewing images on a TV
- ▶ Using with your computer
- ▶ Printing
- ▶ Troubleshooting
- ▶ Precautions / About this camera

[⇒ Contents list](#)

WPS Push

If your access point has the WPS button, you can register the access point to the camera easily by pushing the WPS button.

1. MENU →  (Settings) →  (Network Settings) → [WPS Push] → ●
2. Press the WPS button on the access point you want to register.

Notes

- To use [WPS Push], the security of your access point has to be set to WPA2 or WPA, and support the WPS push button system. In other cases, such as where security is set to WEP or the WPS push button system is not supported, register the access point manually. [\[Details\]](#)
- For details on the functions and settings of your access point, refer to the instruction manual of the access point, or contact the person who is managing the access point.
- Connection may not be established or communication distance may be shorter depending on the surrounding environment, such as obstacles between the camera and the access point, obstacle/wall materials, radio wave conditions, etc. In such cases, change the location of the camera or move the camera closer to the access point in.

Related Topic

[Access point settings](#)

[▲ Back to top](#)

- ▶ Before Use
- ▶ Operating the camera
- ▶ Shooting
- ▶ Viewing
- ▶ Useful shooting functions
- ▶ Useful viewing functions
- ▶ Changing settings
- ▶ Viewing images on a TV
- ▶ Using with your computer
- ▶ Printing
- ▶ Troubleshooting
- ▶ Precautions / About this camera

[⇒ Contents list](#)



Access point settings

▼ How to use the keyboard

▼ Other setting items

You can register your access point manually.

Before starting the procedure, check the SSID name of the access point, security system, and password. The password may be preset in some devices. For details, see the instruction manual of the wireless access point, or consult the network administrator.

1. MENU →  (Settings) →  (Network Settings) → [Access point settings] → ●
2. Select the access point you want to register.

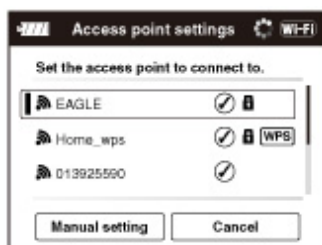

When the desired access point is displayed on the screen:

Select the desired access point.

When the desired access point is not displayed on the screen:

Select [Manual setting] and set the access point.

* For the input method, refer to “How to use the keyboard.”

- If you select [Manual regist.], input the SSID name of the access point → select the security system.

3. Input the password → [OK] → ●

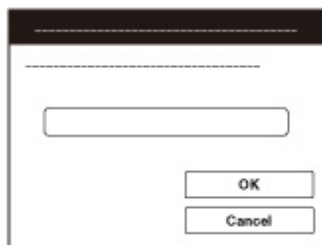

- Access points that do not display  do not require a password to be entered.

4. Select [Register], then press ● .

How to use the keyboard

When manual character entry is required, a keyboard is displayed on the screen.

Select the desired button using ▲ / ▼ / ◀ / ▶ , then press ● to enter the character.

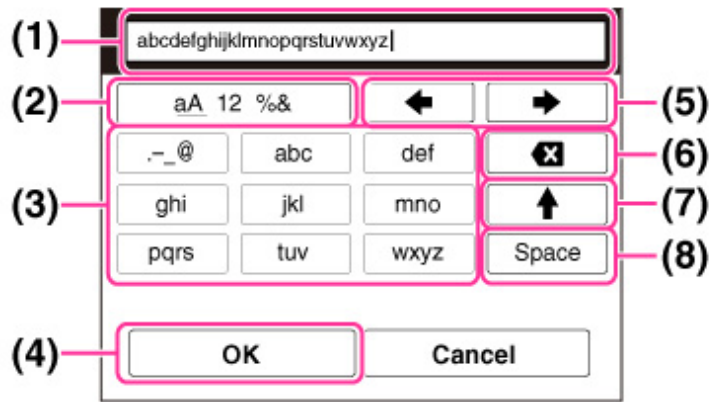

	Screen names	Functions
(1)	Input box	The characters you entered are displayed. If you input characters exceeding the set number of characters, ◀ is displayed on the screen.
(2)	Switch character types	Each time you press ●, character types are switched among alphabet letters, numerals and symbols.
(3)	Keyboard	Each time you press ●, the character that you enter will be displayed. For example: If you want to enter “abd” Select the key for “abc” and press ● once to display “a” → select “→” to move the cursor (5) and press ● → select the key for “abc” and press ● twice to display “b” → select the key for “def” and press ● once to display “d”
(4)	Fix	Fixes the entry.
(5)	Move cursor	Moves the cursor in the input box to the right or left.
(6)	Delete	Deletes the character preceding the cursor.
(7)	↑	Switches the next character to a capital or small letter.
(8)	Space	Enters a space.

- To cancel entering characters midway, select [Cancel].

Other setting items

Depending on the status or the setting method of your access point, you may want to set more items.

Screen names	Functions
WPS PIN	Displays the PIN code to enter into the connected device.
IP address setting	Selects [Auto] or [Manual setting].
IP address	If you are entering the IP address manually, enter the set address.
Subnet mask/Default gateway	When you set [IP address setting] to [Manual setting], enter the IP address to match your network environment.
Priority Connection	Selects [On] or [Off] for [Priority Connection].

Notes

- To give the registered access point priority, set [Priority Connection] to [On].

Related Topic

[WPS Push](#)



[▲ Back to top](#)

Copyright 2013 Sony Corporation

[▶ Before Use](#)[▶ Operating the camera](#)[▶ Shooting](#)[▶ Viewing](#)[▶ Useful shooting functions](#)[▶ Useful viewing functions](#)[▶ Changing settings](#)[▶ Viewing images on a TV](#)[▶ Using with your computer](#)[▶ Printing](#)[▶ Troubleshooting](#)[▶ Precautions / About this camera](#)[⇒ Contents list](#)

Edit Device Name

You can change the device name under Wi-Fi Direct.

1. MENU →  (Settings) →  (Network Settings) → [Edit Device Name] → ●
2. Select the input box, then input the device name → [OK] → ●
 - For input method, refer to "How to use the keyboard." [\[Details\]](#)

Related Topic

[WPS Push](#)[Access point settings](#)[▲ Back to top](#)

- ▶ [Before Use](#)
- ▶ [Operating the camera](#)
- ▶ [Shooting](#)
- ▶ [Viewing](#)
- ▶ [Useful shooting functions](#)
- ▶ [Useful viewing functions](#)
- ▶ [Changing settings](#)
- ▶ [Viewing images on a TV](#)
- ▶ [Using with your computer](#)
- ▶ [Printing](#)
- ▶ [Troubleshooting](#)
- ▶ [Precautions / About this camera](#)

[⇒ Contents list](#)

SSID/PW Reset

The camera shares the connection information for [Send to Smartphone] and [Ctrl with Smartphone] with a device that has permission to connect. If you want to change the device that is permitted to connect to the camera, reset the connection information by following these steps.

1. MENU →  (Settings) →  (Network Settings) → [SSID/PW Reset] → [OK] → ●

Notes

- After resetting the connection information, you must set a smartphone.

Related Topic

[MENU items \(Viewing\)](#)

[Ctrl with Smartphone](#)

[▲ Back to top](#)

- ▶ [Before Use](#)
- ▶ [Operating the camera](#)
- ▶ [Shooting](#)
- ▶ [Viewing](#)
- ▶ [Useful shooting functions](#)
- ▶ [Useful viewing functions](#)
- ▶ [Changing settings](#)
- ▶ [Viewing images on a TV](#)
- ▶ [Using with your computer](#)
- ▶ [Printing](#)
- ▶ [Troubleshooting](#)
- ▶ [Precautions / About this camera](#)

[⇒ Contents list](#)

Disp MAC Address

Displays the MAC address of the camera.

1. MENU →  (Settings) →  (Network Settings) → [Disp MAC Address] → ●

[▲ Back to top](#)



- ▶ Before Use
- ▶ Operating the camera
- ▶ Shooting
- ▶ Viewing
- ▶ Useful shooting functions
- ▶ Useful viewing functions
- ▶ Changing settings
- ▶ Viewing images on a TV
- ▶ Using with your computer
- ▶ Printing
- ▶ Troubleshooting
- ▶ Precautions / About this camera

[⇒ Contents list](#)

Format

Formats the memory card or the internal memory.

When you use a memory card with this camera for the first time, it is recommended to format the card using the camera for stable performance of the memory card before shooting. Note that formatting permanently erases all data on the memory card, and is unrecoverable. Save precious data on a computer, etc.

1. MENU →  (Settings) →  (Memory Card Tool) or  (Internal Memory Tool) → [Format] → [OK] → ●

Notes

- Note that formatting permanently erases all data including even protected images.

[▲ Back to top](#)

- ▶ Before Use
- ▶ Operating the camera
- ▶ Shooting
- ▶ Viewing
- ▶ Useful shooting functions
- ▶ Useful viewing functions
- ▶ Changing settings
- ▶ Viewing images on a TV
- ▶ Using with your computer
- ▶ Printing
- ▶ Troubleshooting
- ▶ Precautions / About this camera

[⇒ Contents list](#)

Create REC.Folder

Creates a folder in a memory card for recording images.

Images are recorded in the newly created folder until you create another folder or select another recording folder.

1. MENU →  (Settings) →  (Memory Card Tool) → [Create REC.Folder] → [OK] → ●

On the folders

After a new folder is created, you can change the storage destination folder. [\[Details\]](#)

Notes

- This item is not displayed when the internal memory is used to record images.
- When you insert a memory card that was used with other equipment into the camera and shoot images, a new folder may be automatically created.
- Up to 4,000 images can be stored in one folder. When the folder capacity is exceeded, a new folder is automatically created.



[▲ Back to top](#)

- ▶ Before Use
- ▶ Operating the camera
- ▶ Shooting
- ▶ Viewing
- ▶ Useful shooting functions
- ▶ Useful viewing functions
- ▶ Changing settings
- ▶ Viewing images on a TV
- ▶ Using with your computer
- ▶ Printing
- ▶ Troubleshooting
- ▶ Precautions / About this camera

[⇒ Contents list](#)

Change REC.Folder

Changes the folder in the memory card that is currently used for recording images.

1. MENU →  (Settings) →  (Memory Card Tool) → [Change REC.Folder] → ●
2. Select a folder with ◀ / ▶ .
3. [OK] → ●

Notes



- This item is not displayed when the internal memory is used to record images.
- You cannot select a folder with a number that has only “□ □ □ MSDCF” or “□ □ □ ANV01” as a recording folder.
- You cannot move recorded images to another folder.

[▲ Back to top](#)

[▶ Before Use](#)[▶ Operating the camera](#)[▶ Shooting](#)[▶ Viewing](#)[▶ Useful shooting functions](#)[▶ Useful viewing functions](#)[▶ Changing settings](#)[▶ Viewing images on a TV](#)[▶ Using with your computer](#)[▶ Printing](#)[▶ Troubleshooting](#)[▶ Precautions / About this camera](#)[⇒ Contents list](#)

Delete REC.Folder

Deletes a folder for recording images in a memory card.

1. MENU →  (Settings) →  (Memory Card Tool) → [Delete REC.Folder]
2. Select a folder with ◀ / ▶ .
3. [OK] → ●

Notes

- This item is not displayed when the internal memory is used to record images.
- If you delete the folder set as the recording folder using [Delete REC.Folder], the folder that has the largest folder number is selected as the next recording folder.
- If a folder contains protected images or files that cannot be played back by the camera, images other than these images are deleted and the folder will remain.



[▲ Back to top](#)

- ▶ Before Use
- ▶ Operating the camera
- ▶ Shooting
- ▶ Viewing
- ▶ Useful shooting functions
- ▶ Useful viewing functions
- ▶ Changing settings
- ▶ Viewing images on a TV
- ▶ Using with your computer
- ▶ Printing
- ▶ Troubleshooting
- ▶ Precautions / About this camera

[⇒ Contents list](#)

Copy

Copies all images in the internal memory to a memory card.

1. Insert a memory card with sufficient free capacity into the camera.
2. MENU →  (Settings) →  (Memory Card Tool) → [Copy] → [OK] → ●

Notes

- Use a fully charged battery pack. If you attempt to copy image files using a battery pack with little remaining charge, the battery pack may run out, causing copying to fail or possibly corrupting the data.
- Images cannot be copied individually.
- The original images in the internal memory are retained even after copying. To delete the contents of the internal memory, remove the memory card after copying, then format the internal memory ([Format] in [Internal Memory Tool]).
- The data will be copied to the recording folder that is currently being used, with a number one higher than the largest data number in that folder. [\[Details\]](#)

[▲ Back to top](#)

- ▶ Before Use
- ▶ Operating the camera
- ▶ Shooting
- ▶ Viewing
- ▶ Useful shooting functions
- ▶ Useful viewing functions
- ▶ Changing settings
- ▶ Viewing images on a TV
- ▶ Using with your computer
- ▶ Printing
- ▶ Troubleshooting
- ▶ Precautions / About this camera

[⇒ Contents list](#)

File Number

Selects the method used to assign file numbers to images.

1. MENU →  (Settings) →  (Memory Card Tool) → [File Number] → desired mode →



	Series	Assigns numbers to files in sequence even if the recording folder or the memory card is changed. (When the replaced memory card contains a file with a number higher than the last assigned number, a number one higher than the largest number is assigned.)
	Reset	Starts from 0001 each time the folder is changed. (When the recording folder contains a file, a number one higher than the largest number is assigned.)

[▲ Back to top](#)

- ▶ Before Use
- ▶ Operating the camera
- ▶ Shooting
- ▶ Viewing
- ▶ Useful shooting functions
- ▶ Useful viewing functions
- ▶ Changing settings
- ▶ Viewing images on a TV
- ▶ Using with your computer
- ▶ Printing
- ▶ Troubleshooting
- ▶ Precautions / About this camera

[⇒ Contents list](#)

Area Setting

DSC-HX50

Adjusts the time to the local time of a selected area.

Setting a frequently visited destination lets you easily adjust the time when you visit that destination.

1. MENU →  (Settings) →  (Clock Settings) → [Area Setting] → desired setting → ●

<input checked="" type="checkbox"/>	Home	You use the camera in your area. When the currently set area differs from your home area, you must make the Area Setting.
<input type="checkbox"/>	Destination	You use the camera set to the time at your destination. Set the destination area.

2. Select the area part for [Destination], then press ● .

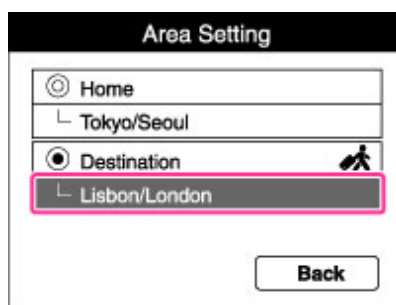

3. Press ◀ / ▶ on the control wheel or turn the control wheel to select the desired area, then select Summer Time using ▲ / ▼ .





DSC-HX50V

Sets the area in which you are using this camera.

If [Auto Area ADJ] is set to [On], the camera adjusts the area automatically when the area changes.

[\[Details\]](#)

1. MENU →  (Settings) →  (Clock Settings) → [Area Setting] → ●
2. Press ◀ / ▶ to select the desired area, then select Summer Time using ▲ / ▼ .

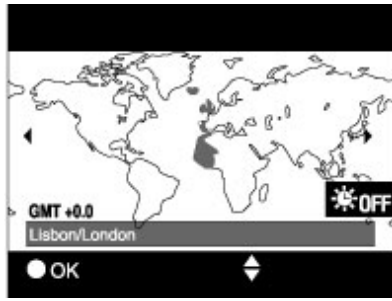

[▲ Back to top](#)



Copyright 2013 Sony Corporation

- ▶ Before Use
- ▶ Operating the camera
- ▶ Shooting
- ▶ Viewing
- ▶ Useful shooting functions
- ▶ Useful viewing functions
- ▶ Changing settings
- ▶ Viewing images on a TV
- ▶ Using with your computer
- ▶ Printing
- ▶ Troubleshooting
- ▶ Precautions / About this camera

[⇒ Contents list](#)

Date & Time Setting

Sets the date and time again.

1. MENU →  (Settings) →  (Clock Settings) → [Date & Time Setting] → desired setting → ●
2. Select the item to be changed using ▲ / ▼ / ◀ / ▶ → ● .
3. Press ▲ / ▼ to set the numeric value → ● .
4. [OK] → ●

Date & Time Format	You can select the date and time display format.
Summer Time	You can select Summer Time [On]/[Off].
Date & Time	You can set the date and time.



[▲ Back to top](#)

- ▶ Before Use
- ▶ Operating the camera
- ▶ Shooting
- ▶ Viewing
- ▶ Useful shooting functions
- ▶ Useful viewing functions
- ▶ Changing settings
- ▶ Viewing images on a TV
- ▶ Using with your computer
- ▶ Printing
- ▶ Troubleshooting
- ▶ Precautions / About this camera

[⇒ Contents list](#)

Auto Clock ADJ (DSC-HX50V)

Your camera maintains correct clock time by using GPS to acquire time information during starting up.

1. MENU →  (Settings) →  (Clock Settings) → [Auto Clock ADJ] → desired mode → ●

<input checked="" type="checkbox"/>	On	Adjusts/Does not adjust the clock automatically.
<input type="checkbox"/>	Off	

Notes

- [Auto Clock ADJ] is invalid if [GPS setting] is set to [Off].
- You must set [Date & Time Setting] on the camera before using it.
- There may be discrepancies of a few seconds.
- Depending on the area, it may not function correctly.

Related Topic

[GPS setting \(DSC-HX50V\)](#)[GPS \(DSC-HX50V\)](#)[▲ Back to top](#)

- ▶ Before Use
- ▶ Operating the camera
- ▶ Shooting
- ▶ Viewing
- ▶ Useful shooting functions
- ▶ Useful viewing functions
- ▶ Changing settings
- ▶ Viewing images on a TV
- ▶ Using with your computer
- ▶ Printing
- ▶ Troubleshooting
- ▶ Precautions / About this camera

[⇒ Contents list](#)

Auto Area ADJ (DSC-HX50V)

If a time-zone difference is detected, your camera adjusts the area by using the GPS to acquire location information.

1. MENU →  (Settings) →  (Clock Settings) → [Auto Area ADJ] → desired mode → ●

<input checked="" type="checkbox"/>	On	Adjusts/Does not adjust the area automatically.
<input type="checkbox"/>	Off	

Notes

- [Auto Area ADJ] is invalid if [GPS setting] is set to [Off].
- You must set [Date & Time Setting] on the camera before using it.
- Depending on the area, [Auto Area ADJ] may not function correctly. In that case, set [Auto Area ADJ] to [Off].

Related Topic

[GPS setting \(DSC-HX50V\)](#)[GPS \(DSC-HX50V\)](#)[▲ Back to top](#)

[Top page](#) > [Viewing images on a TV](#) > [Viewing an image on a High Definition \(HD\) TV](#) > [Viewing an image on an HD TV using the HDMI Cable \(sold separately\)](#)

- ▶ Before Use
- ▶ Operating the camera
- ▶ Shooting
- ▶ Viewing
- ▶ Useful shooting functions
- ▶ Useful viewing functions
- ▶ Changing settings
- ▶ Viewing images on a TV
- ▶ Using with your computer
- ▶ Printing
- ▶ Troubleshooting
- ▶ Precautions / About this camera

[➔ Contents list](#)

Viewing an image on an HD TV using the HDMI Cable (sold separately)

Connect the camera to an HD (High Definition) TV that has an HDMI jack using the HDMI Cable (sold separately).

1. Turn off both the camera and the TV.
2. Connect the HDMI micro jack of the camera **(A)** and the HDMI jack of the TV **(B)** using an HDMI Cable (sold separately) **(C)**.

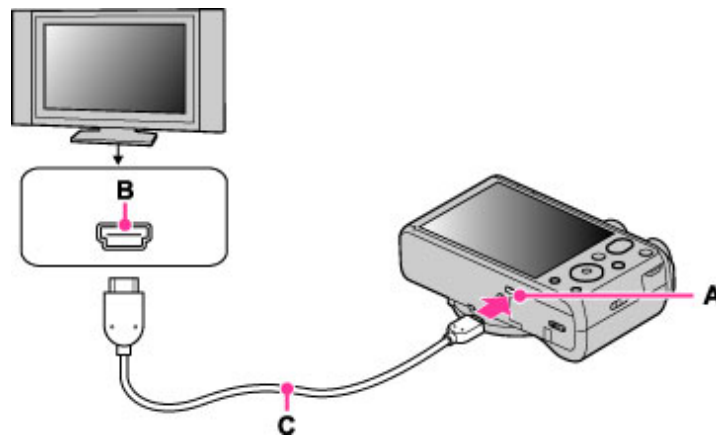

3. Turn on the TV and set the input.
4. Turn on the camera.
Select the desired image after images shot with the camera appear on the TV.



"PhotoTV HD"

This camera is compatible with the "PhotoTV HD" standard.

By connecting a Sony TV compatible with "PhotoTV HD" using an HDMI Cable (sold separately), a whole new world of photos can be comfortably enjoyed in breathtaking Full HD quality.

- "PhotoTV HD" allows for a highly-detailed, photo-like expression of subtle textures and colors.
- When the camera is connected to a Sony TV compatible with Video A mode using an HDMI Cable, your TV is automatically set to the picture quality suitable for still images. When the setting of the TV is set to Video, the picture quality is set to that suitable for movies.
- When playing back an AVCHD movie, it is recommended that you set [View Mode] to [AVCHD view].
- For details, see the operating instructions of the TV.

Notes

- Images shot in [VGA] image size cannot be played back in the HD format.
- MENU →  (Settings) →  (Main Settings), then set [HDMI Resolution] to [Auto], [1080p], [1080i].
- Do not connect the camera and equipment to be connected using both output terminals. When the camera and TV are connected using output terminals, no video or sound are produced. Such a connection can also cause problems with the camera and/or connected equipment.
- The camera may not work properly with some HD TVs. For example, you may not be able to view a video on your HD TV or hear sound from the HD TV.

- Use an HDMI Cable with the HDMI logo.
- Use an HDMI mini connector on one end (for the camera), and a connector suitable for connection to your TV on the other end. You cannot view images on a TV that does not have an HDMI connector.
- Recording may automatically stop to protect the camera after a period of time if you are shooting movies when the camera and TV are connected by an HDMI Cable (sold separately).
- Open the jack cover all the way when inserting the HDMI Cable into the camera.

Related Topic

[Viewing 3D images on a 3D TV](#)

[▲ Back to top](#)

Copyright 2013 Sony Corporation

- ▶ Before Use
- ▶ Operating the camera
- ▶ Shooting
- ▶ Viewing
- ▶ Useful shooting functions
- ▶ Useful viewing functions
- ▶ Changing settings
- ▶ Viewing images on a TV
- ▶ Using with your computer
- ▶ Printing
- ▶ Troubleshooting
- ▶ Precautions / About this camera

[⇒ Contents list](#)



[Top page](#) > [Viewing images on a TV](#) > [Viewing an image on a "BRAVIA" Sync-compatible TV](#) > [Viewing an image on a "BRAVIA" Sync-compatible TV](#)

Viewing an image on a "BRAVIA" Sync-compatible TV

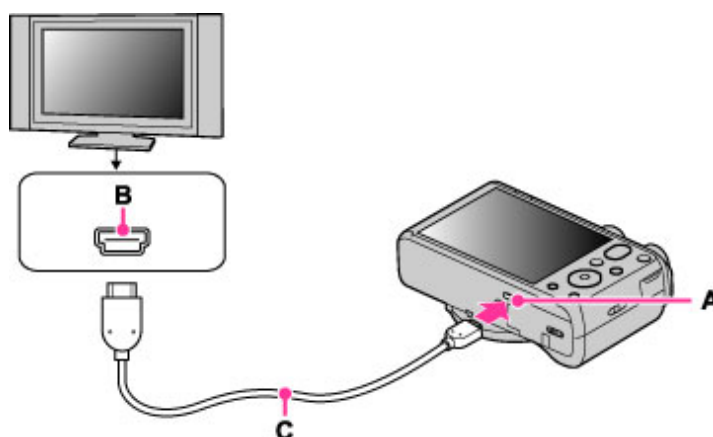

When you use a TV that has "BRAVIA" Sync (compatible with SYNC MENU) support, you can operate the playback functions of the camera using the remote controller supplied with the TV by connecting the camera to the TV using an HDMI Cable (sold separately).

1. Turn off both the camera and the TV.
2. Connect the HDMI micro jack of the camera **(A)** and the HDMI jack of the TV **(B)** using an HDMI Cable (sold separately) **(C)**.



3. Turn on the TV and set the input.
4. Turn on the camera.
5. MENU →  (Settings) →  (Main Settings) → [CTRL FOR HDMI] → [On] → ●
6. Press the SYNC MENU button of the TV's remote controller to select the desired mode.

Notes

- When the camera is connected to a TV set using an HDMI Cable, the functions that you can operate are limited.
- You can perform the operation of the camera with the remote controller of your TV by connecting your camera to a "BRAVIA" Sync-compatible TV. For details, see the operating instructions of the TV.
- If the camera functions in an undesired manner when you are controlling it using the TV's remote controller, such as when connected via HDMI to another manufacturer's TV, press MENU →  (Settings) →  (Main Settings) → [CTRL FOR HDMI] → [Off].
- When the camera is in Easy Mode, SYNC MENU does not appear on the TV.
- Open the jack cover all the way when inserting the HDMI Cable into the camera.

[▲ Back to top](#)

- ▶ Before Use
- ▶ Operating the camera
- ▶ Shooting
- ▶ Viewing
- ▶ Useful shooting functions
- ▶ Useful viewing functions
- ▶ Changing settings
- ▶ Viewing images on a TV
- ▶ Using with your computer
- ▶ Printing
- ▶ Troubleshooting
- ▶ Precautions / About this camera

[➡ Contents list](#)

Viewing 3D images on a 3D TV

You can view 3D images recorded on the camera in 3D format by connecting the camera to a 3D TV using an HDMI Cable (sold separately). Refer also to the operating instructions supplied with the TV.

1. Turn off both the camera and the TV.
2. Connect the camera to the TV using an HDMI Cable (sold separately).

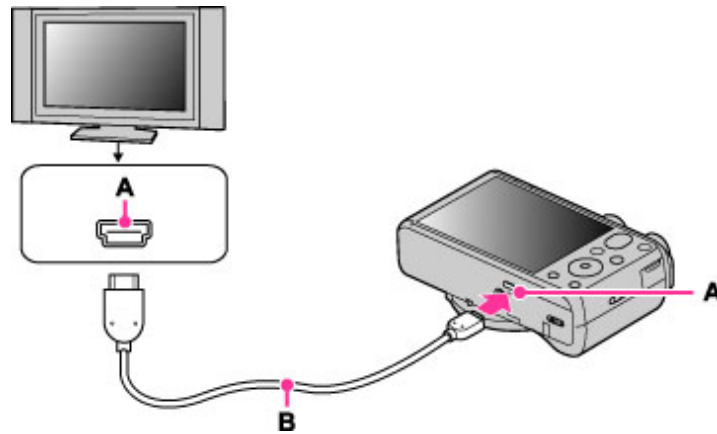

A: HDMI micro jack

B: HDMI Cable

3. Turn on the TV and set the input.
4. Switch to playback mode.
5. MENU → (3D Viewing) → ●
Images shot with the camera appear on the TV.
6. Select images and set the desired mode.

Operation	Action
▲	Continuously plays back only 3D images.
◀	Previous image
▶	Next image
▼	Ends 3D playback.

- You can change the zoom scale for 3D still images using the W/T (zoom) lever.

Notes

- When you select (3D Viewing) mode, only 3D images are displayed.
- Do not connect the camera and equipment to be connected using output terminals. When the camera and TV are connected using output terminals, no video and sound are produced. Such a connection can also cause trouble of the camera and/or connected equipment.

- This function may not work properly with some TVs. For example, you may not be able to view a video on your TV, output in 3D mode or hear sound from the TV.
- Use an HDMI Cable with the HDMI logo.
- When connecting the camera to a TV, use an HDMI Cable that can be connected to the HDMI micro jack on the camera end and to the TV jack.
- Recording may automatically stop to protect the camera after a period of time when you shoot movies in the condition where the camera and TV are connected by an HDMI Cable (sold separately).
- Open the jack cover all the way when inserting the HDMI Cable into the camera.

Related Topic

[3D Viewing](#)

[▲ Back to top](#)

Copyright 2013 Sony Corporation

[Top page](#) > [Using with your computer](#) > [Recommended computer environment](#) > [Recommended computer environment](#)

▶ Before Use
▶ Operating the camera
▶ Shooting
▶ Viewing
▶ Useful shooting functions
▶ Useful viewing functions
▶ Changing settings
▶ Viewing images on a TV
▶ Using with your computer
▶ Printing
▶ Troubleshooting
▶ Precautions / About this camera

[⇒ Contents list](#)

Recommended computer environment

The following computer environment is recommended when using the software “PlayMemories Home” (Windows), “Music Transfer” and “Wireless Auto Import”(Windows/Mac) and when importing images via a USB connection.

Windows

OS (pre-installed)	Microsoft Windows XP* SP3/Windows Vista SP2/Windows 7 SP1/ Windows 8
CPU	Intel Pentium III 800 MHz or faster (For playing/editing the High Definition movies: Intel Core Duo 1.66 GHz or faster/Intel Core 2 Duo 1.66 GHz or faster (Intel Core 2 Duo 2.26 GHz or faster is required when processing AVC HD (FX/FH) movies and Intel Core 2 Duo 2.40 GHz or faster is required when processing AVC HD (PS) movies.))
Memory	Windows XP: 512 MB or more (1 GB or more is recommended.) Windows Vista / Windows 7 / Windows 8: 1 GB or more
Hard Disk (Disk space required for installation)	Approximately 500 MB
Display	1,024 dots × 768 dots or more

* 64-bit editions and Starter (Edition) are not supported.

Windows Image Mastering API (IMAPI) Ver.2.0 or later is required to create a disc.

Mac

OS (pre-installed)	USB Connection: Mac OS X v10.5 to v10.8 Music Transfer: Mac OS X v10.5 to v10.8* Wireless Auto Import: Mac OS X v10.5 – v10.7
--------------------	-------------------------------------------------------------------------------------------------------------------------------------

* Equipped with Intel processor

Notes

- Operation is not assured in an environment based on an upgrade of the operating systems described above or in a multi-boot environment.
- If you connect two or more USB devices to a single computer at the same time, some devices, including the camera, may not operate, depending on the types of USB devices you are using.
- Connecting the camera using a USB interface that is compatible with Hi-Speed USB (USB 2.0) allows advanced transfer (high speed transfer), as the camera is compatible with Hi-Speed USB (USB 2.0).
- When your computer resumes activity from suspend or sleep mode, communication between the camera and your computer may not recover at the same time.

[▲ Back to top](#)

[Top page](#) > [Using with your computer](#) > [Using the software](#) > [“PlayMemories Home” \(Windows\)](#)

- ▶ Before Use
- ▶ Operating the camera
- ▶ Shooting
- ▶ Viewing
- ▶ Useful shooting functions
- ▶ Useful viewing functions
- ▶ Changing settings
- ▶ Viewing images on a TV
- ▶ Using with your computer
- ▶ Printing
- ▶ Troubleshooting
- ▶ Precautions / About this camera

[⇒ Contents list](#)

“PlayMemories Home” (Windows)

Below are examples of the functions available when you use “PlayMemories Home.”

- “PlayMemories Home” allows you to import images shot with the camera to a computer for display. Make a USB connection between the camera and your computer, and click [Import].
- You can display images stored on a computer by shooting date in a calendar display.
- You can save and print images with the date.
- You can edit still images, such as resizing (Resize) and cropping (Trimming).
- You can correct still images, and change the shooting date and time.
- Blu-ray discs, AVCHD discs and DVD-Video discs can be created from AVCHD movies imported to a computer.
- You can upload images to a network service. (An internet connection environment is required.)
- You can import photos and movies recorded with location information to a computer and enjoy viewing them with a map which shows their shooting location (DSC-HX50V only).
- For other details, see [?](#) (PlayMemories Home Help Guide).

Notes

- Mac does not support “PlayMemories Home.” Use the application bundled with the Mac to play back images.

[▲ Back to top](#)

Copyright 2013 Sony Corporation

Top page > Using with your computer > Using the software > Installing “PlayMemories Home” (Windows)

- ▶ Before Use
- ▶ Operating the camera
- ▶ Shooting
- ▶ Viewing
- ▶ Useful shooting functions
- ▶ Useful viewing functions
- ▶ Changing settings
- ▶ Viewing images on a TV
- ▶ Using with your computer
- ▶ Printing
- ▶ Troubleshooting
- ▶ Precautions / About this camera

➔ Contents list

Installing “PlayMemories Home” (Windows)

▼ Starting “PlayMemories Home” (Windows)

▼ Accessing to “PlayMemories Home Help Guide” (Windows)

1. Using the Internet browser on your computer, go to the following URL, then click [Install] → [Run].
www.sony.net/pm
2. Follow the instructions on the screen to complete the installation.
 - When the message to connect the camera to a computer is displayed, connect using the micro USB cable (supplied) (A).



A: To a USB jack of the PC



B: To the Multi/Micro USB Terminal

- For details on “PlayMemories Home”, see [?](#) (PlayMemories Home Help Guide) or the following PlayMemories Home support page (English only):
<http://www.sony.co.jp/pmh-se/>

Notes

- Log on as Administrator.
- It may be necessary to restart your computer. When the restart confirmation message appears, restart the computer following the instructions on the screen.
- DirectX may be installed depending on your computer’s system environment.
- Mac does not support “PlayMemories Home.” Use the application bundled with the Mac to play back images.
- If “PlayMemories Home” has already been installed on your computer, connect the camera with the computer and register your camera with “PlayMemories Home.” The available functions activate.
- If the software “PMB (Picture Motion Browser)” has already been installed on your computer, “PlayMemories Home” will overwrite it and will be installed. Although some “PlayMemories Home” functions differ from those of “PMB,” use “PlayMemories Home.”

Starting “PlayMemories Home” (Windows)

1. Double-click  (PlayMemories Home) on the desktop.
 - To start “PlayMemories Home” from the Start menu, select [Start] → [All Programs] →  (PlayMemories Home).
 - For Windows 8, select the [PlayMemories Home] icon on the Start screen.

Accessing to “PlayMemories Home Help Guide” (Windows)

1. Double-click  (PlayMemories Home Help Guide) on the desktop.
 - To start “PlayMemories Home Help Guide” from the Start menu, select [Start] → [All Programs] → [PlayMemories Home] → [PlayMemories Home Help Guide].
 - Windows 8: select the [PlayMemories Home Help Guide] from [Help] in [PlayMemories Home].

[▲ Back to top](#)

Copyright 2013 Sony Corporation

- ▶ Before Use
- ▶ Operating the camera
- ▶ Shooting
- ▶ Viewing
- ▶ Useful shooting functions
- ▶ Useful viewing functions
- ▶ Changing settings
- ▶ Viewing images on a TV
- ▶ Using with your computer
- ▶ Printing
- ▶ Troubleshooting
- ▶ Precautions / About this camera

[⇒ Contents list](#)

“Music Transfer”



“Music Transfer” allows you to replace the Music files provided in the camera at the factory with your favorite tracks, and to delete and add Music files.

You can also restore the tracks stored at the factory to your camera.

Download the software from the following URL and install it on your computer.

Windows: <http://www.sony.co.jp/imsoft/Win/>

Mac: <http://www.sony.co.jp/imsoft/Mac/>

- The following track types can be imported using “Music Transfer”.
 - MP3 files stored on the hard disk of your computer
 - Music CD tracks
 - Preset-music saved on the camera
- Before starting up “Music Transfer” perform MENU →  (Settings) →  (Main Settings) → [Download Music], and connect the camera to the computer.

For other details, see the help in “Music Transfer”.

Related Topic

[Download Music](#)

[Empty Music](#)

[▲ Back to top](#)

- ▶ Before Use
- ▶ Operating the camera
- ▶ Shooting
- ▶ Viewing
- ▶ Useful shooting functions
- ▶ Useful viewing functions
- ▶ Changing settings
- ▶ Viewing images on a TV
- ▶ Using with your computer
- ▶ Printing
- ▶ Troubleshooting
- ▶ Precautions / About this camera

[⇒ Contents list](#)

Software for Mac

For details on software for Macs, access the following URL:

<http://www.sony.co.jp/imsoft/Mac/>

“Wireless Auto Import”

Before saving to a Mac computer, “Wireless Auto Import” must be installed. Download the software from the URL shown above and install it on your computer. For details, see the help in “Wireless Auto Import”.

Note

- The available software varies depending on the area.

Related Topic

[Send to Computer](#)

[▲ Back to top](#)

- ▶ Before Use
- ▶ Operating the camera
- ▶ Shooting
- ▶ Viewing
- ▶ Useful shooting functions
- ▶ Useful viewing functions
- ▶ Changing settings
- ▶ Viewing images on a TV
- ▶ Using with your computer
- ▶ Printing
- ▶ Troubleshooting
- ▶ Precautions / About this camera

[⇒ Contents list](#)

[Top page](#) > [Using with your computer](#) > [Importing images to a computer](#) > [Connecting the camera to the computer](#)

Connecting the camera to the computer

1. Connect the camera to your computer using a micro USB cable (supplied) **(A)**.



- When connecting the camera to a computer using the micro USB cable, power feeding from the computer starts if [USB Power Supply] is set to [On]. ([On] is the default setting.)

Related Topic

[USB Connect Setting](#)

[LUN Setting](#)

[▲ Back to top](#)

- ▶ Before Use
- ▶ Operating the camera
- ▶ Shooting
- ▶ Viewing
- ▶ Useful shooting functions
- ▶ Useful viewing functions
- ▶ Changing settings
- ▶ Viewing images on a TV
- ▶ Using with your computer
- ▶ Printing
- ▶ Troubleshooting
- ▶ Precautions / About this camera

[⇒ Contents list](#)

Importing images to a computer

“PlayMemories Home” allows you to easily import images.

For details on “PlayMemories Home” functions, see the “PlayMemories Home Help Guide”.

Importing images to a Windows computer without using “PlayMemories Home”

When the AutoPlay Wizard appears after making a USB connection between the camera and a computer, click [Open folder to view files] → [OK] → [DCIM] or [MP_ROOT] → copy the desired images to the computer.

- If the Device Stage screen appears with Windows 7, double-click [Browse Files] → media icon → folder in which the image you want to import is stored.

Importing images to a Mac computer without using “PlayMemories Home”

Connect the camera to your Mac computer. Double-click the newly recognized icon on the desktop → the folder in which the image you want to import is stored. Then drag and drop the image file on to the hard disk icon.

Notes

- Use “PlayMemories Home” for operations such as when importing AVCHD movies to a computer (Windows). However, movies shot in 60p/50p mode cannot be imported.
- Use the “iMovie” software bundled with Mac for operations such as importing AVCHD movies to a computer (Mac).
- If operations are performed on an AVCHD movie file or folder on the camera from a PC while the camera is connected to a PC, it may destroy the image file or playback may become impossible. Do not delete or copy AVCHD movies on the camera’s memory card from a PC. Sony bears no responsibility for the result of operations of this type.
- Use “PlayMemories Home” to import the movies with GPS location information to a computer (DSC-HX50V).
- The camera creates a 3D image by combining a JPEG file with an MPO file. If you delete either file on a PC, you cannot playback the 3D image.

[▲ Back to top](#)

[Top page](#) > [Using with your computer](#) > [Importing images to a computer](#) > [Disconnecting the camera from the computer](#)

- ▶ Before Use
- ▶ Operating the camera
- ▶ Shooting
- ▶ Viewing
- ▶ Useful shooting functions
- ▶ Useful viewing functions
- ▶ Changing settings
- ▶ Viewing images on a TV
- ▶ Using with your computer
- ▶ Printing
- ▶ Troubleshooting
- ▶ Precautions / About this camera

[⇒ Contents list](#)



Disconnecting the camera from the computer

Perform the procedures from step 1 to 2 below before:

- Disconnecting the cable.
- Removing a memory card.
- Inserting a memory card into the camera after copying images from the internal memory.
- Turning off the camera.

1. Click the disconnect icon () on the tasktray.



- With Windows 7 or Windows 8, click  first, then click .

2. Click [Safely remove USB Mass Storage Device].

Notes

- Drag and drop the icon of the memory card or the drive icon to the “Trash” icon beforehand when you use a Mac computer, and the camera is disconnected from the computer.
- The disconnect icon may not appear when you use a Windows 7 computer. In this case, you can disconnect the camera from the computer without following the above steps.

[▲ Back to top](#)

- ▶ Before Use
- ▶ Operating the camera
- ▶ Shooting
- ▶ Viewing
- ▶ Useful shooting functions
- ▶ Useful viewing functions
- ▶ Changing settings
- ▶ Viewing images on a TV
- ▶ Using with your computer
- ▶ Printing
- ▶ Troubleshooting
- ▶ Precautions / About this camera

[➔ Contents list](#)

[Top page](#) > [Using with your computer](#) > [Creating a disc of movies](#) > [Selecting the method for creating a disc of movies](#)

Selecting the method for creating a disc of movies



- ▼ [Characteristics of each type of disc](#)
- ▼ [Creating a disc with a device other than a computer](#)
- ▼ [Creating Blu-ray discs](#)

You can create a disc from AVCHD movies that have been recorded with this camera.

Select the method that suits your disc player.



For details on the method for creating a disc using “PlayMemories Home”, see “PlayMemories Home Help Guide.”

To import movies into a PC, see [\[Details\]](#).

Disc type/Purpose	Recordable movie quality				Player
	PS	FX	FH	HQ	
 For saving images in high-definition image quality (HD)	✓	✓	✓	✓	Blu-ray disc playback devices (Sony Blu-ray disc player, PlayStation 3, etc.)
 For saving images in high-definition image quality (HD) (AVCHD disc)	— *	— *	✓	✓	AVCHD format playback devices (Sony Blu-ray disc player, PlayStation 3, etc.)
 For saving images in standard definition image quality (STD)	— *	— *	— *	— *	Ordinary DVD playback devices (DVD player, computer that can play DVDs, etc.)

*Movies can be saved by converting them to lower image quality when creating a disc using “PlayMemories Home.”

Characteristics of each type of disc

 High-definition image quality (HD)	Using a Blu-ray disc enables you to record high-definition image quality (HD) movies of a longer duration than DVD discs.
 High-definition image quality (HD) (AVCHD disc)	High-definition image quality (HD) movies can be recorded on DVD media, such as DVD-R discs, and a high-definition image quality (HD) disc is created. <ul style="list-style-type: none"> ● You can play a high-definition image quality (HD) disc on AVCHD format playback devices, such as a Sony Blu-ray disc player and a PlayStation 3. You cannot play the disc on ordinary DVD players.
 Standard definition image quality (STD)	Standard definition image quality (STD) movies converted from high-definition

Standard definition image quality (STD)	image quality (HD) movies can be recorded on DVD media, such as DVD-R discs, and a standard definition image quality (STD) disc is created.
-----------------------------------------	---------------------------------------------------------------------------------------------------------------------------------------------

Types of discs that can be used with “PlayMemories Home”

The following 12-cm discs can be used with “PlayMemories Home.” For information on Blu-ray discs, see [\[Details\]](#).





DVD-R / DVD+R / DVD+R DL: Cannot be re-written.

DVD-RW / DVD+RW: Can be re-written and used again.

- Always maintain your PlayStation 3 to use the latest version of the PlayStation 3 system software.
- The PlayStation 3 may not be available in some countries/regions.

Creating a disc with a device other than a computer

You can also create a disc using a Blu-ray recorder and so on. Depending on which device you use, the types of disc that can be created vary.

Devices	Disc type	
 Creates a Blu-ray disc or a disc in standard definition image quality (STD) using a Blu-ray recorder.	 High-definition image quality (HD)	 Standard definition image quality (STD)
 Creates a disc in standard definition image quality (STD) using a device such as an HDD recorder.	 Standard definition image quality (STD)	—

Notes

- To create a Blu-ray disc from movies recorded in [AVC HD 28M (PS)], you need to use device that is compliant with an AVCHD format Ver. 2.0. The created Blu-ray disc can be played back only on the device that is compliant with the AVCHD format Ver. 2.0.
- For details on how to create a disc, refer to the operating instructions of the device you use.

Creating Blu-ray discs

You can create Blu-ray discs from AVCHD movies imported to a PC.

The PC in question must be capable of creating Blu-ray discs. BD-R (not re-writable) or BD-RE (re-writable) discs can be used. Multi-session recordings cannot be made.

To create Blu-ray discs using “PlayMemories Home,” be sure to install the dedicated add-on software.

For details, see the following URL:

<http://support.d-imaging.sony.co.jp/BDUW/>

To install, your PC must be connected to the Internet.

For detailed operations, see “PlayMemories Home Help Guide.”

Notes

- To create a Blu-ray disc from movies recorded in [AVC HD 28M (PS)], you need to use device that is compliant with an AVCHD format Ver. 2.0.

[▲ Back to top](#)

- ▶ Before Use
- ▶ Operating the camera
- ▶ Shooting
- ▶ Viewing
- ▶ Useful shooting functions
- ▶ Useful viewing functions
- ▶ Changing settings
- ▶ Viewing images on a TV
- ▶ Using with your computer
- ▶ **Printing**
- ▶ Troubleshooting
- ▶ Precautions / About this camera

[⇒ Contents list](#)

Printing still images

You can print still images using the following methods.

- Printing directly using a printer which supports your memory card type.
For details, see the operating instructions supplied with the printer.
- Printing using a computer
You can import images to a computer using the “PlayMemories Home” software and print the images.
For details, see the “PlayMemories Home Help Guide”.
- Printing at a shop
You can take a memory card to a photo printing service shop. As long as the shop supports photo printing services conforming to DPOF, you can make a **DPOF** (Print order) mark on images in advance in the playback mode so that you do not have to reselect them when you print them out at the shop. Before you take image data to a shop, always copy (back up) your data.

Notes

- When you print still images shot in [16:9] mode, both edges may be cut off.
- You cannot print panorama images depending on the printer.

[▲ Back to top](#)

- ▶ Before Use
- ▶ Operating the camera
- ▶ Shooting
- ▶ Viewing
- ▶ Useful shooting functions
- ▶ Useful viewing functions
- ▶ Changing settings
- ▶ Viewing images on a TV
- ▶ Using with your computer
- ▶ Printing
- ▶ Troubleshooting
- ▶ Precautions / About this camera

[⇒ Contents list](#)

If you have problems

If you experience trouble with the camera, try the following solutions.

1. Check the items under “Troubleshooting”, then check your camera.

If a code such as “C/E: □ □ : □ □ ” appears on the screen, see “Self-diagnosis display”.

2. Remove the battery pack, wait for about one minute, re-insert the battery pack, then turn on the power.
3. Initialize the settings. [\[Details\]](#)
4. Consult your Sony dealer or local authorized Sony service facility.

- Be aware that by sending the camera for repair, you give consent that the contents of the internal memory, music files may be checked.
- Additional information on this product and answers to frequently asked questions can be found at our Customer Support Website.

<http://www.sony.net/>

[▲ Back to top](#)

- ▶ Before Use
- ▶ Operating the camera
- ▶ Shooting
- ▶ Viewing
- ▶ Useful shooting functions
- ▶ Useful viewing functions
- ▶ Changing settings
- ▶ Viewing images on a TV
- ▶ Using with your computer
- ▶ Printing
- ▶ Troubleshooting
- ▶ Precautions / About this camera

[⇒ Contents list](#)

Battery pack and power

Cannot insert the battery pack into the camera.

- Make sure the direction of the battery pack is correct, and insert it until the battery eject lever is locked.

Cannot turn on the camera.

- After inserting the battery pack into the camera, it may take a few moments for the camera to power up.
- Make sure that the battery pack is inserted correctly.
- The battery pack will discharge by itself even if you do not use it. Charge the battery pack before use.
- Check that the battery pack type is compatible. [\[Details\]](#)

The power turns off suddenly.

- Depending on the camera and battery temperature, the power may turn off automatically to protect the camera. In this case, a message is displayed on the screen before the power turns off.
- If you do not operate the camera for a certain period of time while the power is on and [Power Save] is set to [Standard] or [Max], the camera turns off automatically to prevent wearing down the battery pack. Turn on the camera again.

The remaining charge indicator is incorrect.

- This is caused when you use the camera in an extremely hot or cold location.
- Battery capacity decreases over time and through repeated use. If decreased usage time between charges becomes significant, it is probably time to replace it with a new one.

The charge lamp of the camera flashes while charging the battery.

- Check that the battery pack type is compatible. [\[Details\]](#)
- The charge lamp of the camera flashes infrequently when you use a battery pack that has not been used for a long time. In such cases, remove the battery pack from the camera and re-insert it.
- For details, see “Battery pack” [\[Details\]](#).

The battery is not charged even if the charge lamp turns off and charging is finished.

- This happens when you charge the battery pack in an extremely hot or cold location. Charge the battery pack within the proper charging temperature range of between 10°C to 30°C (50°F to 86°F).

[▲ Back to top](#)

- ▶ Before Use
- ▶ Operating the camera
- ▶ Shooting
- ▶ Viewing
- ▶ Useful shooting functions
- ▶ Useful viewing functions
- ▶ Changing settings
- ▶ Viewing images on a TV
- ▶ Using with your computer
- ▶ Printing
- ▶ Troubleshooting
- ▶ Precautions / About this camera

[⇒ Contents list](#)

Shooting still images/movies

Cannot record images.

- If images are recorded on the internal memory even when a memory card is inserted into the camera, make sure that the memory card is fully inserted into the camera.
- Check the free capacity of the internal memory or memory card. If it is full, do one of the following:
 - Delete unnecessary images. [\[Details\]](#) [\[Details\]](#)
 - Change the memory card.
- You cannot record images while charging the flash.
- When recording movies, it is recommended that you use the following memory cards:
 - “Memory Stick PRO Duo” (Mark2) media, “Memory Stick PRO-HG Duo” media, “Memory Stick XC-HG Duo” media
 - SD memory card, SDHC memory card or SDXC memory card (Class 4 or faster)
- Set [Demo Mode] to [Off]. [\[Details\]](#)

Smile Shutter function does not work.

- No image is shot if a smiling face is not detected. [\[Details\]](#)
- Set [Demo Mode] to [Off]. [\[Details\]](#)

Anti-blur function does not work.

- The anti-blur function may not work properly when shooting night scenes.
- Shoot after pressing the shutter button halfway down.

Recording takes a long time.

- When the shutter speed becomes slower than a certain speed, for example, when you shoot images in dark locations, the camera automatically reduces the image noise. This function is called NR (noise reduction) slow shutter and the shooting time takes longer.

The image is out of focus.

- The subject is too close. When shooting, make sure to position the lens farther away from the subject than the shortest shooting distance (approximately 5 cm (0.16 ft.) (W)/2 m (6.56 ft.) (T) from the lens).
- [Night Scene], [Landscape], [Fireworks] or [Advanced Sports Shooting] mode is selected in the Scene Selection when shooting still images.

Zoom does not work.

- You cannot use the optical zoom in Sweep Panorama mode.
- You cannot use zoom functions other than optical zoom when:
 - [Background Defocus], [Backlight Correction HDR] or [Advanced Sports Shooting] mode is selected in the Scene Selection

- The Smile Shutter is working.
- [Self-Timer] is set to [Self-portrait One Person] or [Self-portrait Two People].

Cannot select the Face Detection function.

- You can select Face Detection only when the focus mode is set to [Multi AF] and the metering mode is set to [Multi].

The flash does not work.

- You cannot use the flash when:
 - Burst mode is selected. [\[Details\]](#)
 - [Anti Motion Blur], [Night Scene], [Hand-held Twilight], [High Sensitivity], [Fireworks] or [Advanced Sports Shooting] mode is selected in Scene Selection.
 - Shooting in Sweep Panorama mode
 - Shooting in movie mode
- Set the flash to [On] when the Scene Selection mode is set to [Landscape], [Gourmet], [Pet], [Beach] or [Snow] mode. [\[Details\]](#)

Fuzzy white circular spots appear in images shot using the flash.

- Particles (dust, pollen, etc.) in the air reflected the flash light and appeared in the image. This is not a malfunction. [\[Details\]](#)

The close-up shoot function (Macro) does not work.

- The camera automatically adjusts the focus. Press and hold the shutter button halfway down. Focus adjustment may take some time when shooting a close subject.
- [Landscape], [Night Scene], [Fireworks] or [Advanced Sports Shooting] mode is selected in the Scene Selection.

The date and time are not displayed on the screen.

- While shooting, the date and time are not displayed. They are displayed only during playback.

The F value and shutter speed flash when you press and hold the shutter button halfway down.

- The exposure is incorrect. Correct the Exposure Compensation. [\[Details\]](#)

The image colors are not correct.

- Adjust the White Balance. [\[Details\]](#)
- Picture Effect is selected. [\[Details\]](#)

Noise appears in the image when you view the screen in a dark place.

- The camera is attempting to increase the visibility of the screen by temporarily brightening the image under conditions of low illumination. There is no effect on the recorded image.

You can see a dark shadow on the image.

- Depending on the brightness of the subject, you may see a dark shadow when you change the aperture. This is not a malfunction.

The eyes of the subject come out red.

- Set [Red Eye Reduction] to [Auto] or [On]. [\[Details\]](#)
- Shoot the subject at a distance closer than the flash range using the flash.
- Light the room and shoot the subject.

Dots appear and remain on the screen.

- This is not a malfunction. These dots are not recorded.

Cannot shoot images in succession.

- The internal memory or memory card is full. Delete unnecessary images. [\[Details\]](#) [\[Details\]](#)
- The battery level is low. Insert a charged battery pack.

The same image is shot several times.

- Set [Cont. Shooting Settings] to [Single Shooting]. [\[Details\]](#)
- [Scene Recognition] is set to [Advanced]. [\[Details\]](#)

The camera makes a sound.

- When you shake the camera, the camera makes a rattling sound because the image-stabilizing lenses or manual focus lenses move. It is not a malfunction.

[▲ Back to top](#)

- ▶ Before Use
- ▶ Operating the camera
- ▶ Shooting
- ▶ Viewing
- ▶ Useful shooting functions
- ▶ Useful viewing functions
- ▶ Changing settings
- ▶ Viewing images on a TV
- ▶ Using with your computer
- ▶ Printing
- ▶ Troubleshooting
- ▶ Precautions / About this camera

[⇒ Contents list](#)

Viewing images

Cannot play back images.

- Make sure that the memory card is fully inserted into the camera.
- The folder/file name has been changed on your computer.
- No guarantees are made for playing back, on this camera, files containing images which were processed on a computer or images which were shot using other cameras.
- The camera is in USB mode. Delete the USB connection. [\[Details\]](#)
- Use “PlayMemories Home” to play images stored on a PC with this camera. Use the application bundled with the Mac to play back the images.
- 3D images consist of a JPEG file and an MPO file. If either file is deleted on the PC, the camera may not operate correctly.

The date and time are not displayed.

- The screen display is set to display images only. Press **DISP** (Display Setting) to display information. [\[Details\]](#)

Cannot hear music during slideshow.

- Slideshow is played back with [Continuous Playback]. Select [Slideshow with music] and play back.
- Transfer music files to the camera with “Music Transfer”. [\[Details\]](#)

The image does not appear on the TV.

- For viewing movies, the camera and television must use the same color television system. [\[Details\]](#)
- Check whether the connection is correct. [\[Details\]](#)

The 3D images do not appear on the TV even though the camera is in [3D Viewing] mode.

- Check that the TV is set to display the 3D images.

[▲ Back to top](#)

- ▶ Before Use
- ▶ Operating the camera
- ▶ Shooting
- ▶ Viewing
- ▶ Useful shooting functions
- ▶ Useful viewing functions
- ▶ Changing settings
- ▶ Viewing images on a TV
- ▶ Using with your computer
- ▶ Printing
- ▶ Troubleshooting
- ▶ Precautions / About this camera

[➡ Contents list](#)

Wi-Fi



The wireless access point you want to connect to does not appear.

- Depending on the radio wave conditions, the wireless access point may not appear on the camera. Move the camera closer to the wireless access point.
- Depending on its setting, the wireless access point may not appear on the camera. Refer to the instruction manual for the wireless access point for the correct settings.

[WPS Push] does not work.

- Depending on the wireless access point setting, [WPS Push] may not be available. Confirm the password and SSID of the wireless access point to set [Access point settings]. [\[Details\]](#)

Cannot save images in the internal memory to the computer.

- Select MENU →  (Settings) →  (Memory Card Tool) → [Copy] before transferring images. [\[Details\]](#)



[Send to Computer] is not displayed on the menu.

- Insert a memory card before use.

[Send to Computer] terminate prematurely.

- If the battery level is low, [Send to Computer] may terminate prematurely. Charge the battery pack before use.

Cannot transfer movies to the smartphone.

- Before shooting a movie to be transferred to a smartphone, set MENU →  (Settings) →  (Shooting Settings) → [Movie format] → [MP4]. [\[Details\]](#)

[Send to Smartphone] terminate prematurely.

- If the battery level is low, [Send to Smartphone] may terminate prematurely. Charge the battery pack before use.

The shooting screen does not display smoothly, when the camera is disconnected from the computer.

- Depending on the radio wave conditions, communication between the smartphone and camera may not work correctly. Close the distance between the camera and smartphone.

Shooting with [Ctrl with Smartphone] terminate prematurely.

- If the battery level is low, shooting with [Ctrl with Smartphone] may terminate prematurely. Charge the battery pack before use.

[▲ Back to top](#)

Copyright 2013 Sony Corporation

[▶ Before Use](#)[▶ Operating the camera](#)[▶ Shooting](#)[▶ Viewing](#)[▶ Useful shooting functions](#)[▶ Useful viewing functions](#)[▶ Changing settings](#)[▶ Viewing images on a TV](#)[▶ Using with your computer](#)[▶ Printing](#)[▶ Troubleshooting](#)[▶ Precautions / About this camera](#)[⇒ Contents list](#)

GPS (DSC-HX50V)

The camera is not receiving a GPS signal.

- Set [GPS setting] to [On]. [\[Details\]](#)
- Your camera may not be able to receive radio signals from GPS satellites because of obstructions.
- To triangulate the location information correctly, bring your camera to an open area, and turn on the camera again.

Excessive error in location information.

- The margin of error can be up to several-hundred meters depending on surrounding buildings, weak GPS signals, etc.

It takes time to triangulate although [GPS assist data] is taken in.

- [Date & Time Setting] is not set, or set time is shifted greatly. Set the date and time correctly. [\[Details\]](#)
- The term of validity of GPS assist data has expired. Update GPS assist data. [\[Details\]](#)
- As the positions of GPS satellites vary constantly, it may take longer to determine the location or the receiver may not be able to determine the location at all, depending on the location and time you use the camera.
- “GPS” is a system for determining geographic location by triangulating radio signals from GPS satellites. Avoid using the camera in places where radio signals are blocked or reflected, such as a shadowy place surrounded by buildings or trees, etc. Use the camera in open sky environments.

The location information has not been recorded.

- Use “PlayMemories Home” to import the movies with GPS location information to your computer.

[▲ Back to top](#)

- ▶ Before Use
- ▶ Operating the camera
- ▶ Shooting
- ▶ Viewing
- ▶ Useful shooting functions
- ▶ Useful viewing functions
- ▶ Changing settings
- ▶ Viewing images on a TV
- ▶ Using with your computer
- ▶ Printing
- ▶ Troubleshooting
- ▶ Precautions / About this camera

[⇒ Contents list](#)

Computers

Your computer does not recognize the camera.

- Set [USB Connect Setting] to [Mass Storage]. [\[Details\]](#)
- Use the micro USB cable (supplied).
- Disconnect the USB cable from both the computer and the camera, and connect it again firmly.
- Disconnect all equipment other than the camera, the keyboard and the mouse from the USB connectors of your computer.
- Connect the camera directly to your computer without passing through a USB hub or other device.
- Set [USB Power Supply] to [Off]. Your computer may recognize the camera.

Cannot import images.

- Connect the camera and your computer correctly making a USB connection. [\[Details\]](#)
- When you shoot images with a memory card formatted by a computer, you may not be able to import the images to a computer. Shoot using a memory card formatted by the camera. [\[Details\]](#)

After making a USB connection, “PlayMemories Home” does not start automatically.

- Make the USB connection after the computer is turned on.

Cannot play back images on your computer.

- If you are using “PlayMemories Home”, refer to “PlayMemories Home Help Guide”. [\[Details\]](#)
- Consult the computer or software manufacturer.

The image and sound are interrupted by noise when you view a movie on a computer.

- You are playing back the movie directly from the memory card. Import the movie to your computer using “PlayMemories Home” and play it back. [\[Details\]](#)

Images once exported to a computer cannot be viewed on the camera.

- Use “PlayMemories Home” to play images stored on a PC with this camera. Use the application bundled with the Mac to play back the images.
- Register the image in the Image Database File and play in [Date View]. [\[Details\]](#)

[▲ Back to top](#)

[▶ Before Use](#)[▶ Operating the camera](#)[▶ Shooting](#)[▶ Viewing](#)[▶ Useful shooting functions](#)[▶ Useful viewing functions](#)[▶ Changing settings](#)[▶ Viewing images on a TV](#)[▶ Using with your computer](#)[▶ Printing](#)[▶ Troubleshooting](#)[▶ Precautions / About this camera](#)[⇒ Contents list](#)

Memory card

Cannot insert a memory card.

- Insert the memory card in the correct direction.

You have formatted a memory card by mistake.

- All the data on the memory card is deleted by formatting. You cannot restore it.

Images are recorded on the internal memory even when a memory card is inserted into the camera.

- Make sure that the memory card is fully inserted into the camera.

[▲ Back to top](#)

[▶ Before Use](#)[▶ Operating the camera](#)[▶ Shooting](#)[▶ Viewing](#)[▶ Useful shooting functions](#)[▶ Useful viewing functions](#)[▶ Changing settings](#)[▶ Viewing images on a TV](#)[▶ Using with your computer](#)[▶ Printing](#)[▶ Troubleshooting](#)[▶ Precautions / About this camera](#)[⇒ Contents list](#)

Internal memory

Cannot play back or record images using the internal memory.

- There is a memory card inserted in the camera. Remove it.

Cannot copy the data stored in the internal memory to a memory card.

- The memory card is full. Copy to a memory card with sufficient capacity.

Cannot copy the data on the memory card or the computer to the internal memory.

- This feature is not available.

[▲ Back to top](#)

- ▶ Before Use
- ▶ Operating the camera
- ▶ Shooting
- ▶ Viewing
- ▶ Useful shooting functions
- ▶ Useful viewing functions
- ▶ Changing settings
- ▶ Viewing images on a TV
- ▶ Using with your computer
- ▶ Printing
- ▶ Troubleshooting
- ▶ Precautions / About this camera

[⇒ Contents list](#)

Printing

Images are printed with both edges cut off.

- Depending on your printer, all the edges of the image may be cut off. Especially when you print an image shot with the image size set to [16:9], the lateral end of the image may be cut off.
- When printing images using your printer, cancel the trimming or borderless settings. Consult the printer manufacturer as to whether the printer provides these functions or not.
- When having images printed at a digital print shop, ask the shop whether they can print the images without cutting off both edges.

Cannot print images with the date.

- Select MENU →  (Shooting Settings) → [Write Date] → [On] to insert a date on the image. Make sure that once the date is inserted, you cannot remove that date from the image.
- Using “PlayMemories Home”, you can insert the date on still images that have been recorded without a date. [\[Details\]](#)

Cannot print the 3D images as they are displayed on the camera's screen.

- The 3D images displayed on the camera are MPO files, but the images to be printed are JPEG files, so in some cases, the images to be printed out are not the same as the ones displayed on the screen.

[▲ Back to top](#)

- ▶ Before Use
- ▶ Operating the camera
- ▶ Shooting
- ▶ Viewing
- ▶ Useful shooting functions
- ▶ Useful viewing functions
- ▶ Changing settings
- ▶ Viewing images on a TV
- ▶ Using with your computer
- ▶ Printing
- ▶ Troubleshooting
- ▶ Precautions / About this camera

[⇒ Contents list](#)

Others

The lens gets fogged.

- Moisture condensation has occurred. Turn off the camera and leave it for about an hour before using it.

The camera stops with the lens portion extended.

- Do not attempt to force a lens that has stopped moving.
- Insert a charged battery pack, then turn the camera on again.

The camera turns off with the lens portion extended.

- The battery pack is discharged. Replace it with a charged battery pack, then turn the camera on again.
- Do not attempt to force a lens that has stopped moving.

The camera becomes warm when you use it for a long time.

- This is not a malfunction.

The Clock Set screen appears when you turn on the camera.

- Set the date and time again. [\[Details\]](#)
- The internal rechargeable backup battery has discharged. Insert a charged battery, and set aside for 24 hours or more with the power left off.

The date or time is incorrect.

- The Area Setting is set to a different location than your current location. Change the setting by MENU →  (Settings) → [Clock Settings] → [Area Setting].

[▲ Back to top](#)

- ▶ Before Use
- ▶ Operating the camera
- ▶ Shooting
- ▶ Viewing
- ▶ Useful shooting functions
- ▶ Useful viewing functions
- ▶ Changing settings
- ▶ Viewing images on a TV
- ▶ Using with your computer
- ▶ Printing
- ▶ Troubleshooting
- ▶ Precautions / About this camera

[⇒ Contents list](#)

Self-diagnosis display

If a code starting with a letter of the alphabet appears, the self-diagnosis function on the camera is working. The last two digits (indicated by) will differ depending on the state of the camera.

If you cannot solve the problem even after trying the following corrective actions a few times, the camera may need repair.

Contact your Sony dealer or local authorized Sony service facility.

C:32:

E:95:

- There is trouble with the camera's hardware. Turn the power off and on again.
-

C:13:

- The camera cannot read or write data on the memory card. Try turning off and on the camera again, or taking out and inserting the memory card several times.
 - The internal memory has experienced a format error, or an unformatted memory card is inserted. Format the internal memory or the memory card. [\[Details\]](#)
 - The inserted memory card cannot be used with the camera, or the data is damaged. Insert a new memory card.
-

E:61:

E:62:

E:91:

- A camera malfunction has occurred. Initialize the camera, then turn the power on again. [\[Details\]](#)
-

E:94:

- There is a malfunction when writing or deleting data. Repair is required. Contact your Sony dealer or local authorized Sony service facility. Be prepared to give all numbers in the error code beginning from the E.

[▲ Back to top](#)

- ▶ Before Use
- ▶ Operating the camera
- ▶ Shooting
- ▶ Viewing
- ▶ Useful shooting functions
- ▶ Useful viewing functions
- ▶ Changing settings
- ▶ Viewing images on a TV
- ▶ Using with your computer
- ▶ Printing
- ▶ Troubleshooting
- ▶ Precautions / About this camera

[⇒ Contents list](#)

Messages

If the following messages appear, follow the instructions.



- The battery level is low. Charge the battery pack immediately. Depending on the conditions of use or the type of battery pack, the indicator may flash even though there are still 5 minutes to 10 minutes of remaining battery time left.

For use with compatible battery only

- The battery inserted is not an NP-BX1 (supplied) battery pack.

Camera overheating Allow it to cool

- The camera temperature has risen. The power may turn off automatically, or you may be unable to record movies. Leave the camera in a cool location until the temperature goes down.

Internal memory error

- Turn the power off and then on again.

Reinsert the memory card.

- The inserted memory card cannot be used in the camera. [\[Details\]](#)
- The terminal section of the memory card is dirty.
- The memory card is damaged.

This memory card is not formatted correctly.

- The inserted memory card cannot be used in the camera. [\[Details\]](#)

This memory card may not be able to record or play images correctly.

- The inserted memory card cannot be used in the camera. [\[Details\]](#)

Buffer overflow. Writing to the media was not completed in time.

- If you use a memory card that has been recorded and erased repeatedly, or that was formatted on a different camera, the data writing speed may be too slow. First back up any data on the card to a computer, and then reformat the card before using it. [\[Details\]](#)
- The writing speed of the memory card you are using is not sufficient for movie recordings. Use a “Memory Stick PRO-HG Duo” media, “Memory Stick PRO Duo” (Mark2) media, “Memory Stick XC-HG Duo” media, “Memory Stick Micro” (Mark2) media or an SD card (Class 4 or faster).

The memory card is locked. Check the tab.

- You are using the memory card with the write-protect switch, and the switch is set to the LOCK position. Set the switch to the recording position.

This is a read- only memory card.

- The camera cannot record or delete images on this memory card.

Writing to the memory card was not completed correctly Recover data

- Reinsert the memory card, and select [OK] to recover data.

No images

- No images that can be played back have been recorded in the internal memory.
- No images that can be played back have been recorded in this folder of the memory card.

No still images

- There are no 3D images that can be played back in [3D Viewing] mode.
- The selected folder or date does not contain a file that can be played back in a slideshow.

File found which was not recognized

- You tried to delete a folder containing a file that cannot be played on this camera. Delete the file on a computer and then delete the folder.

Folder error. Cannot record to the selected folder. Please select a different folder.

- A folder with the same first three digit number already exists on the memory card (for example: 123MSDCF and 123ABCDE). Select another folder [\[Details\]](#), or create a new folder [\[Details\]](#).

Cannot create more folders

- The folder with a name beginning with “999” exists on the memory card. You cannot create any folders if this is the case.

Empty folder contents

- You tried to delete a folder containing one or more files. Delete all of the files and then delete the folder.

Folder protected

- You tried to delete a folder that is protected as read only on a computer.

File Error.

- An error occurred while the image was playing back.
No guarantees are made for playing back, on this camera, files containing images which were processed on a computer or images which were shot using other cameras.

Read only folder

- You have selected a folder that cannot be set as a recording folder on the camera. Select another folder. [\[Details\]](#)

File protected

- Release the protection. [\[Details\]](#)

Image size over limit

- You are playing back an image with size that cannot be played back on the camera.

Unable to detect face for retouch

- You may not be able to retouch the image depending on the image.

 **(Vibration warning indicator)**

- Camera shake may occur due to insufficient light. Use the flash, or mount the camera on a tripod to secure the camera.

MP4 12M is not supported with this memory card.**MP4 6M is not supported with this memory card.**

- For recording movies, it is recommended that you use a “Memory Stick PRO Duo” (Mark2) media, a “Memory Stick PRO-HG Duo” media, a “Memory Stick XC-HG Duo” media or an SD card (Class 4 or faster).

Movie with different video signal format from this device recorded. Recording is unavailable in this movie format.

- Set [Movie format] to [MP4]. [\[Details\]](#)

Turn the power off and on again

- The lens malfunction.

Maximum number of images already selected.

- Up to 100 files can be selected when using [Multiple Images].
- You can add **DPOF** (Print order) marks to up to 999 files.

Error Playing Music

- Delete the Music file, or replace it with a normal Music file.
- Execute [Empty Music], then download a new Music file.

Error Formatting Music

- Execute [Empty Music].

Operation cannot be executed in unsupported files.

▲

- Processing and other editing functions of the camera cannot be performed on image files that have been processed using a computer or images that were recorded with other cameras.

Preparing image database file. Please wait.

- The camera restores the date information, etc., in cases where images have been deleted on a PC, etc.
- The necessary Image Database File is created after the memory card is formatted.



- The number of images exceeds that for which date management in a database file by the camera is possible. To register additional images in the Image Database File, delete images in [Date View].

Inconsistencies found in image database file. Recover data.

- AVCHD movies cannot be recorded or played because the Image Database File is corrupt. Follow the on-screen instructions to recover the Image Database File.



- It is not possible to record to the camera's Image Database File or play back using [Date View]. Use "PlayMemories Home" to back up all images to a PC and use it to restore a memory card.

Image Database File error. Cannot recover data.

- Import all of the images to the computer with "PlayMemories Home", and format the memory card or the internal memory. [\[Details\]](#)
To view the images again with the camera, export the imported images to the camera with "PlayMemories Home".

Recording function unavailable due to high internal temperature.

- The camera temperature has risen. You cannot record images until the temperature has gone down.

Recording has stopped due to increased camera temperature.

- Recording has stopped due to a rise in temperature while recording a movie. Please wait until the temperature goes down.



- When you record movies for a long time, the camera temperature rises. In this case, stop recording movies.

[▲ Back to top](#)

- ▶ Before Use
- ▶ Operating the camera
- ▶ Shooting
- ▶ Viewing
- ▶ Useful shooting functions
- ▶ Useful viewing functions
- ▶ Changing settings
- ▶ Viewing images on a TV
- ▶ Using with your computer
- ▶ Printing
- ▶ Troubleshooting
- ▶ Precautions / About this camera

⇒ [Contents list](#)

[Top page](#) > [Troubleshooting](#) > [Situations this camera has difficulty handling](#) > [Situations this camera has difficulty handling](#)

Situations this camera has difficulty handling

The camera cannot take full advantage of some features under certain circumstances.

When shooting under the following conditions, either recompose the shot or change the shooting mode, then shoot the images again.

Low light conditions

- [Intelligent Sweep Panorama](#)
- [Background Defocus](#)
- [Tracking focus](#)
- [3D Still Image](#)

Overly bright conditions

- [Background Defocus](#)
- [Tracking focus](#)

Varying levels of brightness

- [Tracking focus](#)

Flickering lights

- [Intelligent Sweep Panorama](#)

Subjects too close to the camera

- [Intelligent Sweep Panorama](#)
- [Background Defocus](#)

Subjects too far from the camera

- [Background Defocus](#)

Large moving subjects or subjects that move too quickly

- [Superior Auto](#)
- [Background Defocus](#)
- [Tracking focus](#)
- [3D Still Image](#)

Subjects too small or too large

- [Background Defocus](#)
- [Tracking focus](#)

Background the same color as the subject

- [Background Defocus](#)

Scenes with little contrast, such as the sky or a sandy beach

- [Intelligent Sweep Panorama](#)
- [Superior Auto](#)

Scenes changing constantly, such as waterfalls

- [Intelligent Sweep Panorama](#)
- [Superior Auto](#)

- ▶ [Before Use](#)
- ▶ [Operating the camera](#)
- ▶ [Shooting](#)
- ▶ [Viewing](#)
- ▶ [Useful shooting functions](#)
- ▶ [Useful viewing functions](#)
- ▶ [Changing settings](#)
- ▶ [Viewing images on a TV](#)
- ▶ [Using with your computer](#)
- ▶ [Printing](#)
- ▶ [Troubleshooting](#)
- ▶ [Precautions / About this camera](#)

[→ Contents list](#)

Precautions

- ▼ [Internal memory and memory card back up](#)
- ▼ [On database files](#)
- ▼ [Do not use/store the camera in the following places](#)
- ▼ [On operating temperatures](#)
- ▼ [On moisture condensation](#)
- ▼ [Functions built into this camera](#)
- ▼ [What is 1080 60p/50p?](#)
- ▼ [On image data compatibility](#)
- ▼ [Notes when playing movies on other devices](#)
- ▼ [Notes on the screen and lens](#)

Internal memory and memory card back up

Do not turn off the camera, remove the battery pack, or remove the memory card while the access lamp is lit. Otherwise, the internal memory data or the memory card may be damaged. Be sure to make a backup copy to protect your data.

On database files

When you insert a memory card without a database file into the camera and turn on the power, part of the memory card capacity is used to automatically create a database file. It may take some time until you can perform the next operation.

Do not use/store the camera in the following places

- In an extremely hot, cold or humid place
In places such as in a car parked in the sun, the camera body may become deformed and this may cause a malfunction.
- Storing under direct sunlight or near a heater
The camera body may become discolored or deformed, and this may cause a malfunction.
- In a location subject to rocking vibration
- Near strong magnetic place
- In sandy or dusty places
Be careful not to let sand or dust get into the camera. This may cause the camera to malfunction, and in some cases this malfunction cannot be repaired.

On operating temperatures

Your camera is designed for use under the temperatures between 0°C and 40°C (32°F to 104°F). Shooting in extremely cold or hot places that exceed this range is not recommended.

On moisture condensation

- If the camera is brought directly from a cold to a warm location, moisture may condense inside or outside the camera. This moisture condensation may cause a malfunction of the camera.
- If moisture condensation occurs, turn off the camera and wait about an hour for the moisture to

evaporate. Note that if you attempt to shoot with moisture remaining inside the lens, you will be unable to record clear images.

Functions built into this camera

- To check if your camera supports the GPS function, check for the model name.
 - GPS-compatible: DSC-HX50V
 - GPS-incompatible: DSC-HX50
- This manual describes the function of 1080 60p-compatible devices and 1080 50p-compatible devices.
- While aboard an airplane, set [Airplane Mode] to [On].
- Do not watch 3D images shot with this camera for extended periods of time on 3D-compatible monitors.
- When you view 3D images shot with this camera on 3D-compatible monitors, you may experience discomfort in the form of eye strain, fatigue, or nausea. To prevent these symptoms, we recommend that you take regular breaks.

However, you need to determine for yourself the length and frequency of breaks you require, as they vary according to the individual. If you experience any type of discomfort, stop viewing the 3D images until you feel better, and consult a physician as necessary. Also refer to the operating instructions supplied with the device or software you have connected or are using with this camera. Note that a child's eyesight is still at the development stage (particularly children below the age of 6). Consult a pediatrician or ophthalmologist before letting your child view 3D images, and make sure he/she observes the above precautions when viewing such images.

What is 1080 60p/50p?

- Unlike standard recording modes up to now, which record in an interlacing method, this camera records using a progressive method. This increases the resolution, and provides a smoother, more realistic image.

On image data compatibility

- The camera conforms with DCF (Design rule for Camera File system) universal standard established by JEITA (Japan Electronics and Information Technology Industries Association).
- Sony does not guarantee that the camera will play back images recorded or edited with other equipment, or that other equipment will play back images recorded with the camera.

Notes when playing movies on other devices

- This camera uses MPEG-4 AVC/H.264 High Profile for AVCHD format recording. Movies recorded in AVCHD format with this camera cannot be played by the following devices.
 - Other devices compatible with AVCHD format that does not support High Profile
 - Devices incompatible with the AVCHD formatThis camera also uses MPEG-4 AVC/H.264 Main Profile for MP4 format recording. For this reason, movies recorded in MP4 format with this camera cannot be played on devices other than those that support MPEG-4 AVC/H.264.
- You can play a high-definition image quality (HD) disc only on AVCHD format playback devices. A DVD player or DVD recorder cannot play back a disc recorded in high-definition image quality (HD) because they are not compatible with the AVCHD format. In addition, if you insert a high-definition image quality (HD) disc recorded in AVCHD format into a DVD player or DVD recorder, you may not be able to eject the disc.

Notes on the screen and lens

- The screen is manufactured using extremely high-precision technology so over 99.99% of the pixels are operational for effective use. However, some tiny black and/or bright dots (white, red, blue or green) may appear on the screen. These dots are a normal result of the manufacturing process and do not affect the recording.
- Exposing the screen or the lens to direct sunlight for long periods may cause malfunctions. Be careful when placing the camera near a window or outdoors.

- Do not press against the screen. The screen may be discolored and that may cause a malfunction.
- Images may trail across on the screen in a cold location. This is not a malfunction.
- Be careful not to bump the lens, and be careful not to apply force to it.

[▲ Back to top](#)

Copyright 2013 Sony Corporation

[Top page](#) > [Precautions / About this camera](#) > [Precautions](#) > [On the internal rechargeable backup battery](#)

- ▶ [Before Use](#)
- ▶ [Operating the camera](#)
- ▶ [Shooting](#)
- ▶ [Viewing](#)
- ▶ [Useful shooting functions](#)
- ▶ [Useful viewing functions](#)
- ▶ [Changing settings](#)
- ▶ [Viewing images on a TV](#)
- ▶ [Using with your computer](#)
- ▶ [Printing](#)
- ▶ [Troubleshooting](#)
- ▶ [Precautions / About this camera](#)

[⇒ Contents list](#)

On the internal rechargeable backup battery

This camera has an internal rechargeable battery for maintaining the date and time and other settings regardless of whether the power is on or off.

This rechargeable battery is continually charged as long as you are using the camera. However, if you use the camera for only short periods, it discharges gradually, and if you do not use the camera at all for about one month it becomes completely discharged. In this case, be sure to charge this rechargeable battery before using the camera.

However, even if this rechargeable battery is not charged, you can still use the camera, but the date and time will not be indicated.

Charging method of the internal rechargeable backup battery

Insert a charged battery pack in the camera, and then leave the camera for 24 hours or more with the power off.

[▲ Back to top](#)

- ▶ Before Use
- ▶ Operating the camera
- ▶ Shooting
- ▶ Viewing
- ▶ Useful shooting functions
- ▶ Useful viewing functions
- ▶ Changing settings
- ▶ Viewing images on a TV
- ▶ Using with your computer
- ▶ Printing
- ▶ Troubleshooting
- ▶ Precautions / About this camera

[→ Contents list](#)

Battery pack

- ▼ [On charging the battery pack](#)
- ▼ [Effective use of the battery pack](#)
- ▼ [Remaining battery charge](#)
- ▼ [How to store the battery pack](#)
- ▼ [On battery life](#)
- ▼ [Compatible battery pack](#)

On charging the battery pack

- Charge the battery pack (supplied) before using the camera for the first time.
- You can charge the battery pack even if it is not completely discharged. In addition, even if the battery pack is not fully charged, you can use the partially charged capacity of the battery pack as is.
- We recommend charging the battery pack in an ambient temperature of between 10°C to 30°C (50°F to 86°F). The battery pack may not be effectively charged in temperatures outside this range.

Effective use of the battery pack

- Battery performance decreases in low temperature surroundings. So in cold places, the operational time of the battery pack is shorter. We recommend the following to ensure longer battery pack use:
 - Put the battery pack in a pocket close to your body to warm it up, and insert it in the camera immediately before you start shooting.
 (If there are any metal objects such as keys in your pocket, be aware of short-circuits.)
- The battery pack will run out quickly if you use the flash or zoom frequently.
- We recommend having spare battery packs handy for two times or three times the expected shooting time, and making trial shots before taking the actual shots.
- Do not expose the battery pack to water. The battery pack is not water-resistant.
- Do not leave the battery pack in extremely hot places, such as in a car or under direct sunlight.
- You may not be able to turn on the camera or the battery pack may not be effectively charged if the terminal section of the battery is dirty. In this case, wipe any dust off lightly using a soft cloth or a cotton swab to clean the battery.

Remaining battery charge

- A remaining charge indicator appears on the screen.



A: High

B: Low

- It takes about one minute until the correct remaining charge indicator appears.
- The remaining charge indicator may not be correct under certain circumstances.
- When [Power Save] is set to [Standard] or [Max], if you do not operate the camera for a certain period of time while the power is on, the screen becomes dark, then the camera turns off automatically (Auto power-off function).

| How to store the battery pack

- Fully discharge the battery pack before storing and store the camera in a cool, dry place. To maintain the battery pack's function, charge the battery pack and then fully discharge it in the camera at least once a year while storing.
- To use the battery pack up, leave the camera in slideshow playback mode until the power goes off.
- To prevent staining the terminal, short-circuiting, etc., be sure to use a plastic bag to keep away from metal materials when carrying or storing.

| On battery life

- The battery life is limited. Battery capacity decreases over time and through repeated use. If decreased usage time between charges becomes significant, it is probably time to replace it with a new one.
- The battery life varies according to how it is stored and the operating conditions and environment in which each battery pack is used.

| Compatible battery pack

- The NP-BX1 (supplied) can be used in compatible Cyber-shot models.

[▲ Back to top](#)

Copyright 2013 Sony Corporation

▶ Before Use
▶ Operating the camera
▶ Shooting
▶ Viewing
▶ Useful shooting functions
▶ Useful viewing functions
▶ Changing settings
▶ Viewing images on a TV
▶ Using with your computer
▶ Printing
▶ Troubleshooting
▶ Precautions / About this camera

[⇒ Contents list](#)

Charging the battery pack

- The supplied AC Adaptor is dedicated to this camera. Do not connect with other electronic devices. Doing so may cause a malfunction. Also, make sure to use a genuine Sony AC Adaptor.
- If the charge lamp of the camera flashes during charging, remove the battery pack being charged, and then insert the same battery pack into the camera securely again. If the charge lamp flashes again, this may indicate a battery error or that a battery pack other than the specified type has been inserted. Check that the battery pack is the specified type. If the battery pack is the specified type, remove the battery pack, replace it with a new or different one and check that the battery is charged correctly. If the battery is charged correctly, a battery error may have occurred.
- If the charge lamp flashes even if the AC Adaptor is connected to the camera and the wall outlet (wall socket), this indicates that the charging has stopped temporarily and is on standby. Charging stops and enters standby status automatically when the temperature is outside of the recommended operating temperature. When the temperature returns to the appropriate range, charging resumes and the charge lamp lights up again. We recommend charging the battery pack in an ambient temperature of between 10°C to 30°C (50°F to 86°F).
- Using the supplied AC Adaptor, you can charge the battery pack inserted in the camera. In addition, power supply via AC Adaptor in playback mode is also available. However, in shooting mode, power supply via AC Adaptor is not available. You need AC Adaptor AC-UD10 (sold separately) or AC-UD11* (sold separately) to supply a power from a wall outlet (wall socket) while shooting.

* The AC Adaptor AC-UD11 (sold separately) may not be available in some countries/regions.

[▲ Back to top](#)

- ▶ Before Use
- ▶ Operating the camera
- ▶ Shooting
- ▶ Viewing
- ▶ Useful shooting functions
- ▶ Useful viewing functions
- ▶ Changing settings
- ▶ Viewing images on a TV
- ▶ Using with your computer
- ▶ Printing
- ▶ Troubleshooting
- ▶ [Precautions / About this camera](#)

[→ Contents list](#)

Memory card

- ▼ [Memory card](#)
- ▼ [Note on using the memory card adaptor \(sold separately\)](#)
- ▼ [“Memory Stick” media](#)
- ▼ [When using “Memory Stick PRO Duo” media or “Memory Stick XC Duo” media with standard sized “Memory Stick” media slot](#)
- ▼ [Notes on using a “Memory Stick Micro” media \(sold separately\)](#)

Memory card

Memory card	Representation in User Guide
Memory Stick XC-HG Duo	“Memory Stick XC Duo” media
Memory Stick PRO Duo	“Memory Stick PRO Duo” media
Memory Stick PRO-HG Duo	
Memory Stick Micro (M2)	“Memory Stick Micro” media
Memory Stick Micro (Mark2)	
SD memory card	SD card
SDHC memory card	
SDXC memory card	
microSD memory card	microSD memory card
microSDHC memory card	
microSDXC memory card	

- “Memory Stick XC Duo” media, “Memory Stick PRO Duo” media and SD cards of up to 64 GB have been tested and proven to operate with your camera.
- “Memory Stick Micro” media of up to 16 GB and microSD memory cards of up to 64 GB have been tested and proven to operate with your camera.
- When recording movies, it is recommended that you use the following memory cards:
 - **MEMORY STICK PRO DUO** (Mark2) (“Memory Stick PRO Duo” (Mark2) media)
 - **MEMORY STICK XC-HG DUO** (“Memory Stick XC-HG Duo” media)
 - **MEMORY STICK PRO-HG DUO** (“Memory Stick PRO-HG Duo” media)
 - **MEMORY STICK MICRO** (Mark2) (“Memory Stick Micro” (Mark2) media)
 - SD card (Class 4 or faster), microSD memory card (Class 4 or faster)

Notes

- To ensure stable operations of the memory card, we recommend that you use this camera to format any memory card being used with this camera for the first time. Note that formatting will erase all data recorded on the memory card. This data cannot be restored. Be sure to backup any important data to a PC or other storage location.
- If you repeatedly record/delete images, fragmentation of data may occur on the memory card. Movies may not be able to be saved or recorded. In such a case, save your images to a PC or other storage location, then [Format].

- A memory card formatted with a computer is not guaranteed to operate with the camera.
- Data read/write speeds differ depending on the combination of the memory card and the equipment used.
- Data may be corrupted in the following cases:
 - When the memory card is removed or the camera is turned off during a read or write operation
 - When the memory card is used in locations subject to static electricity or electrical noise
- We recommend backing up important data.
- Do not attach a label on the memory card itself nor on a memory card adaptor.
- Do not touch the terminal section of the memory card with your hand or a metal object.
- Do not strike, bend or drop the memory card.
- Do not disassemble or modify the memory card.
- Do not expose the memory card to water.
- Do not leave the memory card within the reach of small children. They might accidentally swallow it.
- Insert a memory card that fits the memory card slot size. Otherwise, it will cause a malfunction.
- Do not use or store the memory card under the following conditions:
 - High temperature locations such as the hot interior of a car parked in direct sunlight
 - Locations exposed to direct sunlight
 - Humid locations or locations with corrosive substances present

Note on using the memory card adaptor (sold separately)

- When inserting a memory card into a memory card adaptor, make sure the memory card is inserted facing in the correct direction, then insert it all the way in. Incorrect insertion may result in a malfunction.
- When using “Memory Stick Micro” media or a microSD memory card, use a specified memory card adaptor.

“Memory Stick” media

The types of “Memory Stick Duo” media that can be used with the camera are listed in the table below. However, proper operation cannot be guaranteed for all “Memory Stick Duo” media functions.

“Memory Stick” media type	Recording/Playback
Memory Stick PRO Duo	○ *1*2
Memory Stick PRO-HG Duo	○ *1*2
Memory Stick XC-HG Duo	○ *1*2
Memory Stick Micro (M2)	○ *1
Memory Stick Micro (Mark2)	○ *1*2

*1 “Memory Stick PRO Duo” media, “Memory Stick XC Duo” media and “Memory Stick Micro” media are equipped with MagicGate functions. MagicGate is copyright protection technology that uses encryption technology. Data recording/playback that requires MagicGate functions cannot be performed with the camera.

*2 Movies recorded in AVCHD format, [MP4 12M] and [MP4 6M] size movies cannot be recorded to “Memory Stick” media other than “Memory Stick PRO Duo” media, “Memory Stick PRO-HG Duo” media, “Memory Stick XC-HG Duo” media or “Memory Stick Micro” (Mark2) media.

When using “Memory Stick PRO Duo” media or “Memory Stick XC Duo” media with standard sized “Memory Stick” media slot

You can use “Memory Stick PRO Duo” media or “Memory Stick XC Duo” media by inserting it into the “Memory Stick Duo” media Adaptor (sold separately).



“Memory Stick Duo” media Adaptor

Notes on using a “Memory Stick Micro” media (sold separately)

- This product is compatible with “Memory Stick Micro” media (“M2”). “M2” is an abbreviation for “Memory Stick Micro” media.
- To use a “Memory Stick Micro” media with the camera, be sure to insert the “Memory Stick Micro” media into an “M2” Adaptor as large as of Duo size. If you insert a “Memory Stick Micro” media into the camera without an “M2” Adaptor as large as of Duo size, you might not be able to remove it from the camera.
- Do not leave the “Memory Stick Micro” media within the reach of small children. They might accidentally swallow it.

[▲ Back to top](#)

Copyright 2013 Sony Corporation

- ▶ [Before Use](#)
- ▶ [Operating the camera](#)
- ▶ [Shooting](#)
- ▶ [Viewing](#)
- ▶ [Useful shooting functions](#)
- ▶ [Useful viewing functions](#)
- ▶ [Changing settings](#)
- ▶ [Viewing images on a TV](#)
- ▶ [Using with your computer](#)
- ▶ [Printing](#)
- ▶ [Troubleshooting](#)
- ▶ [Precautions / About this camera](#)

[⇒ Contents list](#)

On cleaning

Cleaning the lens and flash

If the lens or flash becomes dirty (fingerprints, dust, etc.), gently wipe clean with a soft cloth.

Cleaning the flash

Clean the flash surface before use. The heat of the flash emission may cause dirt on the flash surface to start smoking or burning. Wipe the flash surface with a soft cloth to remove dirt or dust, etc.

Cleaning the camera surface

Clean the camera surface with a soft cloth slightly moistened with water, then wipe the surface with a dry cloth. To prevent damage to the finish or casing:

- Do not expose the camera to chemical products such as thinner, benzine, alcohol, disposable cloths, insect repellent, sunscreen or insecticide.
- Do not touch the camera with any of the above on your hand.
- Do not leave the camera in contact with rubber or vinyl for a long time.

[▲ Back to top](#)

[Top page](#) > [Precautions / About this camera](#) > [Number of still images and recordable time of movies](#) > [Number of still images](#)

- ▶ Before Use
- ▶ Operating the camera
- ▶ Shooting
- ▶ Viewing
- ▶ Useful shooting functions
- ▶ Useful viewing functions
- ▶ Changing settings
- ▶ Viewing images on a TV
- ▶ Using with your computer
- ▶ Printing
- ▶ Troubleshooting
- ▶ Precautions / About this camera

[⇒ Contents list](#)

Number of still images

The number of still images may vary depending on the shooting conditions and the memory card.
(Units: Images)

Size	Internal memory	Memory card formatted with this camera					
	Approx. 48 MB	2 GB	4 GB	8 GB	16 GB	32 GB	64 GB
20M	7	295	590	1200	2400	4800	9600
10M	9	385	780	1550	3150	6300	12500
5M	16	670	1300	2700	5400	10500	21000
VGA	155	6400	12500	25500	40000	40000	40000
16:9(15M)	8	325	660	1300	2650	5300	10500
16:9(2M)	29	1150	2350	4750	9500	19000	36000

Notes

- When an image shot with other cameras is played back on this camera, the image may not appear in the actual image size.

[▲ Back to top](#)

[Top page](#) > [Precautions / About this camera](#) > [Number of still images and recordable time of movies](#) > [Recordable time of movies](#)

- ▶ Before Use
- ▶ Operating the camera
- ▶ Shooting
- ▶ Viewing
- ▶ Useful shooting functions
- ▶ Useful viewing functions
- ▶ Changing settings
- ▶ Viewing images on a TV
- ▶ Using with your computer
- ▶ Printing
- ▶ Troubleshooting
- ▶ Precautions / About this camera

[⇒ Contents list](#)

Recordable time of movies

The table below shows the approximate maximum recording times. These are the total times for all movie files. The recordable time may vary depending on the shooting conditions and the memory card. (h (hour), m (minute))

Quality / Size	Internal memory	Memory card formatted with this camera					
	Approx. 48 MB	2 GB	4 GB	8 GB	16 GB	32 GB	64 GB
AVC HD 28M (PS)	—	8 m (8 m)	15 m (15 m)	35 m (35 m)	1 h 15 m (1 h 15 m)	2 h 30 m (2 h 30 m)	5 h 5 m (5 h 5 m)
AVC HD 24M (FX)	—	10 m (10 m)	20 m (20 m)	40 m (40 m)	1 h 30 m (1 h 30 m)	3 h (3 h)	6 h (6 h)
AVC HD 17M (FH)	—	10 m (10 m)	25 m (25 m)	1 h (1 h)	2 h (2 h)	4 h 5 m (4 h 5 m)	8 h 15 m (8 h 15 m)
AVC HD 9M (HQ)	—	25 m (15 m)	50 m (35 m)	1 h 45 m (1 h 20 m)	3 h 35 m (2 h 45 m)	7 h 20 m (5 h 30 m)	14 h 40 m (11 h 5 m)
MP4 12M	—	15 m	40 m	1 h 20 m	2 h 45 m	5 h 30 m	11 h 5 m
MP4 6M	—	35 m	1 h 15 m	2 h 40 m	5 h 20 m	10 h 50 m	21 h 45 m
MP4 3M	—	1 h 10 m	2 h 20 m	4 h 55 m	9 h 55 m	20 h	40 h 10 m

The number in () is the minimum recordable time.

Continuous shooting is possible for approximately 29 minutes (a product specification limit). The maximum continuous recording time of an MP4 (12M) format movie is about 15 minutes (limited by the 2 GB file size restriction).

Notes

- The recordable time of movies varies because the camera is equipped with VBR (Variable Bit Rate), which automatically adjusts image quality depending on the shooting scene. When you record a fast-moving subject, the image is clearer but the recordable time is shorter because more memory is required for recording. The recordable time also varies depending on the shooting conditions, the subject or the image quality/size settings.

[▲ Back to top](#)

[Top page](#) > [Precautions / About this camera](#) > [Using the camera abroad](#) > [Using the camera abroad](#)

- ▶ [Before Use](#)
- ▶ [Operating the camera](#)
- ▶ [Shooting](#)
- ▶ [Viewing](#)
- ▶ [Useful shooting functions](#)
- ▶ [Useful viewing functions](#)
- ▶ [Changing settings](#)
- ▶ [Viewing images on a TV](#)
- ▶ [Using with your computer](#)
- ▶ [Printing](#)
- ▶ [Troubleshooting](#)
- ▶ [Precautions / About this camera](#)

[⇒ Contents list](#)

Using the camera abroad

You can use the AC Adaptor (supplied) in any country or region where the power supply is within 100 V to 240 V AC, 50 Hz/60 Hz.

Notes

- An electronic voltage transformer is unnecessary and its use may cause a malfunction.

[▲ Back to top](#)

[Top page](#) > [Precautions / About this camera](#) > [Using the camera abroad](#) > [On TV color systems](#)

- ▶ Before Use
- ▶ Operating the camera
- ▶ Shooting
- ▶ Viewing
- ▶ Useful shooting functions
- ▶ Useful viewing functions
- ▶ Changing settings
- ▶ Viewing images on a TV
- ▶ Using with your computer
- ▶ Printing
- ▶ Troubleshooting
- ▶ Precautions / About this camera

[⇒ Contents list](#)

On TV color systems

To view movies shot using this camera on a television, the camera and television must use the same color television system. Check the color TV system for the country or region where you are using the camera.

NTSC system

Bahama Islands, Bolivia, Canada, Central America, Chile, Colombia, Ecuador, Jamaica, Japan, Korea, Mexico, Peru, Surinam, Taiwan, the Philippines, the U.S.A., Venezuela, etc.

PAL system

Australia, Austria, Belgium, China, Croatia, Czech Republic, Denmark, Finland, Germany, Holland, Hong Kong, Hungary, Indonesia, Italy, Kuwait, Malaysia, New Zealand, Norway, Poland, Portugal, Romania, Singapore, Slovak Republic, Spain, Sweden, Switzerland, Thailand, Turkey, United Kingdom, Viet Nam, etc.

PAL-M system

Brazil

PAL-N system

Argentina, Paraguay, Uruguay

SECAM system

Bulgaria, France, Greece, Guiana, Iran, Iraq, Monaco, Russia, Ukraine, etc.

[▲ Back to top](#)

- ▶ Before Use
- ▶ Operating the camera
- ▶ Shooting
- ▶ Viewing
- ▶ Useful shooting functions
- ▶ Useful viewing functions
- ▶ Changing settings
- ▶ Viewing images on a TV
- ▶ Using with your computer
- ▶ Printing
- ▶ Troubleshooting
- ▶ Precautions / About this camera

[⇒ Contents list](#)

AVCHD format

The AVCHD format has been developed for high-definition digital video cameras when recording an HD (High-Definition) signal at the 1080i*¹ or 720p*² specification using high-efficiency compression coding technology. The MPEG-4 AVC/H.264 format is adopted to compress video data, and the Dolby Digital or Linear PCM system is used to compress audio data.

The MPEG-4 AVC/H.264 format is capable of compressing images at higher efficiency than that of the conventional image compressing format. The MPEG-4 AVC/H.264 format enables a high definition video signal shot on a digital video camera recorder to be recorded on 8 cm DVD discs, hard disk drive, flash memory, memory card, etc.

Recording and playback on the camera

Based on the AVCHD format, your camera records with the high definition image quality (HD) mentioned below.

Video signal*³:

- 1080 60i-compatible device
- MPEG-4 AVC/H.264 1920×1080/60i, 1920×1080/60p, 1440×1080/60i
- 1080 50i-compatible device
- MPEG-4 AVC/H.264 1920×1080/50i, 1920×1080/50p, 1440×1080/50i

Audio signal: Dolby Digital 2ch

Recording media: Memory card

*1 1080i specification

A high definition specification which utilizes 1,080 effective scanning lines and the interlace system.

*2 720p specification

A high definition specification which utilizes 720 effective scanning lines and the progressive system.

*3 Data recorded in AVCHD format other than the above mentioned cannot be played on your camera.

[▲ Back to top](#)

- ▶ Before Use
- ▶ Operating the camera
- ▶ Shooting
- ▶ Viewing
- ▶ Useful shooting functions
- ▶ Useful viewing functions
- ▶ Changing settings
- ▶ Viewing images on a TV
- ▶ Using with your computer
- ▶ Printing
- ▶ Troubleshooting
- ▶ Precautions / About this camera

[⇒ Contents list](#)

GPS (DSC-HX50V)

On GPS

- As the positions of GPS satellites vary constantly, it may take longer to determine the location or the receiver may not be able to determine the location at all, depending on the location and time you use the camera.
- Avoid using the GPS feature on your camera in places where radio signals are blocked or reflected, such as a shadowy place surrounded by buildings or trees, etc Use the camera in open sky environments.
- You may not be able to record location information at locations or in situations where radio signals from the GPS satellites do not reach the camera as follows.
 - In tunnels, indoors or under the shade of buildings.
 - Between tall buildings or at narrow streets surrounded by buildings.
 - In underground locations, locations surrounded by dense trees, under an elevated bridge, or in locations where magnetic fields are generated, such as near high voltage cables.
 - Near devices that generate radio signals of the same frequency band as the camera: near 1.5 GHz band mobile telephones, etc.
- If you take images with the [GPS setting] set to [On], and upload those images to the internet, the shooting location may be available to third parties. To prevent this, set [GPS setting] to [Off] before shooting. [\[Details\]](#)

On triangulating errors

- If you move to another location right after turning on the camera, it may take a longer time for the camera to start triangulating, compared to when you stay in the same place.
- Error caused by the position of GPS satellites
The camera automatically triangulates your current location when the camera receives radio signals from 3 or more GPS satellites. The triangulating error allowed by the GPS satellites is about 10 m (33 ft). Depending on the environment of the location, the triangulating error can be greater. In this case, your actual location may not match the location on the map based on the GPS information. Meanwhile, the GPS satellites are controlled by the United States Department of Defense, and the degree of accuracy may be changed intentionally.
- Error during the triangulating process
The camera acquires location information periodically. There is a slight time difference between when the location information is acquired and when the location information is recorded on an image, therefore, the actual recording location may not match exactly the location on the map based on the GPS information.

On the restriction of use of GPS on an airplane

- During take off and landing of an airplane, set [Airplane Mode] to [On].
- If you do not want to record location information, set [GPS setting] to [Off].

On the other restriction

- Use GPS in accordance with the regulations of the place or situation.

On the geographic coordinate system

- The "WGS-84" geographic coordinate system is used.

[▲ Back to top](#)

- ▶ Before Use
- ▶ Operating the camera
- ▶ Shooting
- ▶ Viewing
- ▶ Useful shooting functions
- ▶ Useful viewing functions
- ▶ Changing settings
- ▶ Viewing images on a TV
- ▶ Using with your computer
- ▶ Printing
- ▶ Troubleshooting
- ▶ Precautions / About this camera

[⇒ Contents list](#)

License

Notes on the License

This camera comes with software that are used based on licensing agreements with the owners of that software. Based on requests by the owners of copyright of these software applications, we have an obligation to inform you of the following. Please read the following sections.

Licenses (in English) are recorded in the internal memory of your camera. Establish a Mass Storage connection between the camera and a computer to read licenses in the "PMHOME" - "LICENSE" folder.

THIS PRODUCT IS LICENSED UNDER THE AVC PATENT PORTFOLIO LICENSE FOR THE PERSONAL USE OF A CONSUMER OR OTHER USES IN WHICH IT DOES NOT RECEIVE REMUNERATION TO

(i) ENCODE VIDEO IN COMPLIANCE WITH THE AVC STANDARD ("AVC VIDEO")
AND/OR

(ii) DECODE AVC VIDEO THAT WAS ENCODED BY A CONSUMER ENGAGED IN A PERSONAL ACTIVITY AND/OR WAS OBTAINED FROM A VIDEO PROVIDER LICENSED TO PROVIDE AVC VIDEO.

NO LICENSE IS GRANTED OR SHALL BE IMPLIED FOR ANY OTHER USE.

ADDITIONAL INFORMATION MAY BE OBTAINED FROM MPEG LA, L.L.C. SEE [HTTP://WWW.MPEGLA.COM](http://WWW.MPEGLA.COM)

On GNU GPL/LGPL applied software

The software that is eligible for the following GNU General Public License (hereinafter referred to as "GPL") or GNU Lesser General Public License (hereinafter referred to as "LGPL") are included in the camera.

This informs you that you have a right to have access to, modify, and redistribute source code for these software programs under the conditions of the supplied GPL/LGPL.

Source code is provided on the web. Use the following URL to download it.

<http://www.sony.net/Products/Linux/>

We would prefer you do not contact us about the contents of source code.

Licenses (in English) are recorded in the internal memory of your camera. Establish a Mass Storage connection between the camera and a computer to read licenses in the "PMHOME" - "LICENSE" folder.

[▲ Back to top](#)

- ▶ Before Use
- ▶ Operating the camera
- ▶ Shooting
- ▶ Viewing
- ▶ Useful shooting functions
- ▶ Useful viewing functions
- ▶ Changing settings
- ▶ Viewing images on a TV
- ▶ Using with your computer
- ▶ Printing
- ▶ Troubleshooting
- ▶ Precautions / About this camera

[⇒ Contents list](#)

Trademarks

- The following marks are trademarks of Sony Corporation.
Cyber-shot, “Cyber-shot,” “Memory Stick,” , “Memory Stick PRO,” **MEMORY STICK PRO**, “Memory Stick Duo,” **MEMORY STICK DUO**, “Memory Stick PRO Duo,” **MEMORY STICK PRO DUO**, “Memory Stick PRO-HG Duo,” **MEMORY STICK PRO-HG DUO**, “Memory Stick XC-HG Duo,” **MEMORY STICK XC-HG DUO**, “Memory Stick Micro,” **MEMORY STICK MICRO**, “MagicGate,” **MAGICGATE**, “BRAVIA,” “PhotoTV HD.”
- “Blu-ray Disc™” and “Blu-ray™” are trademarks of the Blu-ray Disc Association.
- “AVCHD Progressive” and “AVCHD Progressive” logotype are trademarks of Panasonic Corporation and Sony Corporation.
- Dolby and the double-D symbol are trademarks of Dolby Laboratories.
- The terms HDMI and HDMI High-Definition Multimedia Interface, and the HDMI Logo are trademarks or registered trademarks of HDMI Licensing LLC in the United States and other countries.
- Microsoft, Windows, DirectX and Windows Vista are either registered trademarks or trademarks of Microsoft Corporation in the United States and/or other countries.
- Mac, Mac OS, iMovie and App Store are trademarks or registered trademarks of Apple Inc.
- iOS is a trademark or registered trademark of Cisco System Inc.
- Intel, Pentium and Intel Core are trademarks or registered trademarks of Intel Corporation.
- SDXC logo is a trademark of SD-3C, LLC.
- Android and Google Play are trademarks or registered trademark of Google Inc.
- Wi-Fi, the Wi-Fi logo and Wi-Fi PROTECTED SET-UP are registered trademarks of the Wi-Fi Alliance.
- DLNA and DLNA CERTIFIED are trademarks of Digital Living Network Alliance.
- “PlayStation” is a registered trademark of Sony Computer Entertainment Inc.
- Eye-Fi is a trademark of Eye-Fi, Inc.
- In addition, system and product names used in this manual are, in general, trademarks or registered trademarks of their respective developers or manufacturers. However, the ™ or ® marks are not used in all cases in this manual.

[▲ Back to top](#)