

How to Use

Before Use

Names of parts

- [Identifying parts \[1\]](#)

Icons and indicators

- [List of icons on the screen \[2\]](#)

Using the strap

- [Using the shoulder strap \[3\]](#)

Adjusting the viewfinder

- [Adjusting the viewfinder \(diopter-adjustment\) \[4\]](#)

In-Camera guide

- [About the \[In-Camera Guide\] \[5\]](#)
- [About the shooting advice \[6\]](#)

Confirming the operation method

Confirming the operation method

[Using the control button \[7\]](#)

- [Using MENU items \[8\]](#)
- [Using the Fn \(Function\) button \[9\]](#)

Shooting

Shooting still images/movies

- [Shooting still images \[10\]](#)
- [Shooting movies \[11\]](#)

Selecting a shooting mode

- [List of mode dial functions \[12\]](#)
- [Intelligent Auto \[13\]](#)
- [Superior Auto \[14\]](#)
- [About Scene Recognition \[15\]](#)
- [The advantages of automatic shooting \[16\]](#)
- [Program Auto \[17\]](#)
- [iSweep Panorama \[18\]](#)
- [Scene Selection \[19\]](#)
- [Shutter Priority \[20\]](#)
- [Aperture Priority \[21\]](#)
- [Manual Exposure \[22\]](#)
- [Memory recall \[23\]](#)
- [Movie \[24\]](#)

Using shooting functions

Using the zoom

- [Zoom \[25\]](#)
- [The zoom features available with this product \[26\]](#)
- [Zoom Setting \[27\]](#)
- [About zoom scale \[28\]](#)

Using the flash

- [Using flash \[29\]](#)
- [Flash Mode \[30\]](#)
- [Flash Comp. \[31\]](#)

Selecting a screen display mode

- [Switching the screen display \(Shooting\) \[32\]](#)

Selecting still image size/image quality

- [Image Size \(still image\) \[33\]](#)
- [Aspect Ratio \(still image\) \[34\]](#)
- [Quality \(still image\) \[35\]](#)
- [Panorama: Size \[36\]](#)
- [Panorama: Direction \[37\]](#)

Adjusting the focus

- [Changing the focus method using the zoom/focus switch \[38\]](#)
- [Focus Area \[39\]](#)
- [Focus-lock \[40\]](#)
- [Manual Focus \[41\]](#)
- [Direct manual focus \(DMF\) \[42\]](#)
- [MF Assist \(still image\) \[43\]](#)
- [Focus Magnifier \[44\]](#)
- [Focus Magnif. Time \[45\]](#)
- [Peaking Level \[46\]](#)
- [Peaking Color \[47\]](#)
- [Lock-on AF \[48\]](#)
- [Lock-on AF \(On\) \[49\]](#)
- [AF Illuminator \(still image\) \[50\]](#)

Adjusting the exposure

- [Exposure Comp. \[51\]](#)
- [Metering Mode \[52\]](#)
- [Exposure Set. Guide \[53\]](#)

Selecting a drive mode (Continuous shooting/Self-timer)

- [Drive Mode \[54\]](#)
- [Cont. Shooting \[55\]](#)
- [Self-timer \[56\]](#)
- [Self-portrait \[57\]](#)
- [Self-timer\(Cont\) \[58\]](#)
- [Cont. Bracket \[59\]](#)
- [WB bracket \[60\]](#)

Selecting the ISO sensitivity

- [ISO \[61\]](#)
- [Multi Frame NR \[62\]](#)

Correcting the brightness or contrast

- [D-Range Opt. \(DRO\) \[63\]](#)
- [Auto HDR \[64\]](#)

Adjusting color tones

- [White Balance \[65\]](#)
- [Capturing a basic white color in \[Custom Setup\] mode \[66\]](#)

Selecting an effect mode

- [Picture Effect \[67\]](#)
- [Creative Style \[68\]](#)

Recording movies

- [File Format \(movie\) \[69\]](#)

- [Record Setting \(movie\) \[70\]](#)
- [SteadyShot \(movie\) \[71\]](#)
- [Micref Level \[72\]](#)
- [Wind Noise Reduct. \[73\]](#)
- [Auto Slow Shut. \(movie\) \[74\]](#)
- [MOVIE Button \[75\]](#)

Customizing the shooting functions for convenient use

- [Memory \[76\]](#)
- [Function Menu Set. \[77\]](#)
- [Custom Key Settings \[78\]](#)
- [Function of the Custom key \[79\]](#)

Setting the other functions of this product

- [Photo Creativity \[80\]](#)
- [Smile/Face Detect. \[81\]](#)
- [Soft Skin Effect \(still image\) \[82\]](#)
- [Red Eye Reduction \[83\]](#)
- [Auto Obj. Framing \(still image\) \[84\]](#)
- [High ISO NR \(still image\) \[85\]](#)
- [Write Date \(still image\) \[86\]](#)
- [Grid Line \[87\]](#)
- [Auto Review \[88\]](#)
- [FINDER/MONITOR \[89\]](#)

Viewing

Viewing still images

- [Playing back images \[90\]](#)
- [Playback zoom \[91\]](#)
- [Image Index \[92\]](#)

- [Switching the screen display \(during playback\) \[93\]](#)

Deleting images

- [Deleting a displayed image \[94\]](#)
- [Deleting multiple selected images \[95\]](#)

Playing back movies

- [Playing back movies \[96\]](#)
- [Motion Shot Video \[97\]](#)

Viewing panoramic images

- [Playing back panoramic images \[98\]](#)

Printing

- [Specify Printing \[99\]](#)

Using viewing functions

- [View Mode \[100\]](#)
- [Slide Show \[101\]](#)
- [Rotate \[102\]](#)
- [Protect \[103\]](#)
- [4K Still Image PB \[104\]](#)

Viewing images on a TV

- [Viewing images on an HD TV \[105\]](#)
- [Viewing images on a “BRAVIA” Sync-compatible TV \[106\]](#)

Changing settings

Setup menu

- [Monitor Brightness \[107\]](#)

- [Volume Settings \[108\]](#)
- [Audio signals \[109\]](#)
- [GPS On/Off \(DSC-HX400V\) \[110\]](#)
- [GPS Auto Time Cor. \(DSC-HX400V\) \[111\]](#)
- [GPS Auto Area Adj. \(DSC-HX400V\) \[112\]](#)
- [Use GPS Assist Data \(DSC-HX400V\) \[113\]](#)
- [GPS Log REC \(DSC-HX400V\) \[114\]](#)
- [Delete GPS log data \(DSC-HX400V\) \[115\]](#)
- [Upload Settings\(Eye-Fi\) \[116\]](#)
- [Tile Menu \[117\]](#)
- [Mode Dial Guide \[118\]](#)
- [Display Quality \[119\]](#)
- [Pwr Save Start Time \[120\]](#)
- [PAL/NTSC Selector \[121\]](#)
- [Demo Mode \[122\]](#)
- [HDMI Resolution \[123\]](#)
- [CTRL FOR HDMI \[124\]](#)
- [USB Connection \[125\]](#)
- [USB LUN Setting \[126\]](#)
- [USB Power Supply \[127\]](#)
- [Language \[128\]](#)
- [Date/Time Setup](#)
- [Area Setting \[129\]](#)
- [Format \[130\]](#)
- [File Number \[131\]](#)
- [Select REC Folder \[132\]](#)
- [New Folder \[133\]](#)
- [Folder Name \[134\]](#)
- [Recover Image DB \[135\]](#)
- [Display Media Info. \[136\]](#)
- [Version \[137\]](#)
- [Setting Reset \[138\]](#)

Using Wi-Fi functions

Connecting this product and a Smartphone

- [PlayMemories Mobile \[139\]](#)
- [Connecting an Android smartphone to this product \[140\]](#)
- [Connecting the product to an iPhone or iPad \[141\]](#)
- [Calling up an application using \[One-touch\(NFC\)\] \[142\]](#)

Controlling this product using a Smartphone

- [Smart Remote Embedded \[143\]](#)
- [One-touch connection with an NFC-enabled Android smartphone \(NFC One-touch remote\) \[144\]](#)

Transferring images to a Smartphone

- [Send to Smartphone \[145\]](#)
- [Sending images to an Android smartphone \(NFC One-touch Sharing\) \[146\]](#)

Transferring images to a computer

- [Send to Computer \[147\]](#)

Transferring images to a TV

- [View on TV \[148\]](#)

Changing the settings of Wi-Fi functions

- [Airplane Mode \[149\]](#)
- [WPS Push \[150\]](#)
- [Access Point Set. \[151\]](#)
- [Edit Device Name \[152\]](#)
- [Disp MAC Address \[153\]](#)
- [SSID/PW Reset \[154\]](#)
- [Reset Network Set. \[155\]](#)

Adding applications to the product

PlayMemories Camera Apps

- [PlayMemories Camera Apps \[156\]](#)
- [Recommended computer environment \[157\]](#)

Installing the applications

- [Opening a service account \[158\]](#)
- [Downloading applications \[159\]](#)
- [Downloading applications directly to the product using the Wi-Fi function \[160\]](#)

Starting the applications

- [Launching the downloaded application \[161\]](#)

Managing the applications

- [Uninstalling applications \[162\]](#)
- [Changing the order of applications \[163\]](#)
- [Confirming the account information of PlayMemories Camera Apps \[164\]](#)

Viewing on computers

Recommended computer environment

- [Recommended computer environment \[165\]](#)

Using the software

- [PlayMemories Home \[166\]](#)
- [Installing PlayMemories Home \[167\]](#)
- [Software for Mac computers \[168\]](#)

Connecting this product and a computer

- [Connecting the product to a computer \[169\]](#)
- [Importing images to the computer \[170\]](#)
- [Disconnecting the product from the computer \[171\]](#)

Creating a movie disc

- [Disc type \[172\]](#)
- [Selecting the disc creation method \[173\]](#)
- [Creating a disc with a device other than a computer \[174\]](#)
- [Creating Blu-ray Discs \[175\]](#)

Precautions/This product

Precautions

- [Precautions \[176\]](#)
- [On the internal rechargeable battery \[177\]](#)
- [Notes on the battery pack \[178\]](#)
- [Charging the battery pack \[179\]](#)
- [Memory card \[180\]](#)

Cleaning this product

- [On cleaning \[181\]](#)

Number of recordable still images and recordable time of movies

- [Number of still images \[182\]](#)
- [Recordable time of movies \[183\]](#)

Using this product abroad

- [Plug adaptor \[184\]](#)
- [On TV color systems \[185\]](#)

Other information

- [ZEISS lens \[186\]](#)
- [GPS \(DSC-HX400V\) \[187\]](#)
- [AVCHD format \[188\]](#)
- [License \[189\]](#)

Trademarks

- [Trademarks \[190\]](#)
-

Troubleshooting

If you have problems

If you have problems

- [Troubleshooting \[191\]](#)

Troubleshooting

Battery pack and power

- [You cannot insert the battery pack into the product. \[192\]](#)
- [You cannot turn on the product. \[193\]](#)
- [The power turns off suddenly. \[194\]](#)
- [The remaining battery level indicator shows an incorrect level. \[195\]](#)
- [The charge lamp on the product flashes when charging the battery pack. \[196\]](#)
- [The battery pack has not been charged even if the charge lamp on the product has turned off. \[197\]](#)
- [The battery pack is not charged. \[198\]](#)

Shooting still images/movies

- [You cannot record images. \[199\]](#)
- [Recording takes a long time. \[200\]](#)

- The image is out of focus. [201]
- Zoom does not work. [202]
- The flash does not work. [203]
- Fuzzy white circular spots appear on images shot using the flash. [204]
- The close-up shoot function (Macro) does not work. [205]
- The recording date and time are not displayed on the screen. [206]
- The date and time are recorded incorrectly. [207]
- The aperture value and/or shutter speed flashes. [208]
- The image colors are not correct. [209]
- Noise appears in the image when you view the screen in a dark place. [210]
- Dark shadow appears on the image. [211]
- The eyes of the subject come out red. [212]
- Dots appear and remain on the screen. [213]
- You cannot shoot images continuously. [214]
- The image is not clear in the viewfinder. [215]
- The image is blurred. [216]
- The flash takes too long to recharge. [217]

Viewing images

- Images cannot be played back. [218]
- The date and time are not displayed. [219]
- The image cannot be deleted. [220]
- The image was deleted by mistake. [221]

GPS

- The product is not receiving a GPS signal. (DSC-HX400V) [222]
- There is an excessive error in location information. (DSC-HX400V) [223]
- It takes time to triangulate although the GPS assist data is taken in. (DSC-HX400V) [224]
- The location information has not been recorded. (DSC-HX400V) [225]

Wi-Fi

- You cannot find the wireless access point to be connected. [226]

- [WPS Push] does not work. [227]
- [Send to Computer] is canceled halfway. [228]
- You cannot send movies to a smartphone. [229]
- [Smart Remote Embedded] or [Send to Smartphone] is canceled halfway. [230]
- The shooting screen for [Smart Remote Embedded] is not displayed smoothly./The connection between this product and the smartphone is disconnected. [231]
- You cannot use One-Touch connection (NFC). [232]

Computers

- The computer does not recognize this product. [233]
- You cannot import images. [234]
- The image and sound are interrupted by noise when viewing a movie on a computer. [235]
- Images exported from a computer cannot be viewed on this product. [236]

Memory cards

- Formatted the memory card by mistake. [237]

Printing

- Images are printed with both edges cut off. [238]
- You cannot print images with the date. [239]

Others

- The lens gets fogged. [240]
- The product stops with the lens portion extended./The product turns off with the lens portion extended. [241]
- The product becomes warm when you use it for a long time. [242]
- The Clock Set screen appears when you turn on the product. [243]
- The number of recordable images does not decrease, or decreases two images at a time. [244]
- The product does not work properly. [245]

Messages

Messages

- [Self-diagnosis display \[246\]](#)
- [Warning messages \[247\]](#)

Situations this product has difficulty handling





Situations this product has difficulty handling

- [Situations this product has difficulty handling \[248\]](#)

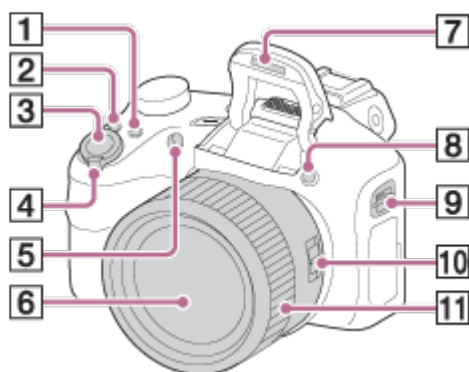
[1] How to Use | Before Use | Names of parts

Identifying parts



1. For shooting: Fn button
For viewing:  (Send to Smartphone) button
2. CUSTOM button
 - You can assign a desired function to the CUSTOM button.
3. Shutter button
4. For shooting: W/T (zoom) lever
For viewing:  (Index) lever/  (Playback zoom) lever
5. Self-timer lamp/AF illuminator
6. Lens
7. Flash
 - Press the  (Flash pop-up) button to use the flash.

When not using the flash, press it back into the camera body.

8. ⚡ (Flash pop-up) button
9. Hook for Shoulder Strap
10. Zoom/Focus switch
11. Manual ring

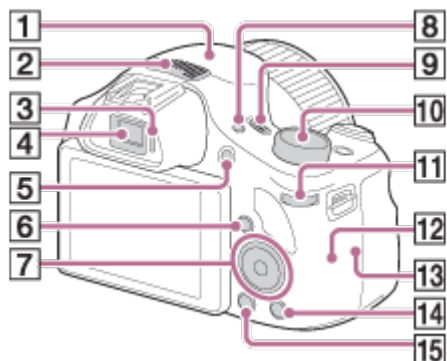

1. GPS receiver (built-in, DSC-HX400V only)
2. Stereo microphone
3. Eye sensor
4. Viewfinder
 - When you look into the viewfinder, the viewfinder display mode is activated, and when you move your face away from the viewfinder, the viewing mode returns to the monitor display mode.
5. MOVIE (Movie) button
6. ▶ (Playback) button
7. Control button
8. FINDER/MONITOR button
 - This button switches whether to display the image on the LCD screen or in the viewfinder.
9. ON/OFF (Power) button and Power/Charge lamp
10. Mode dial
11. Control dial
12. Wi-Fi sensor (built-in)
13. N (N mark)
 - This mark indicates the touch point for connecting this product and an NFC-enabled smartphone.
 - NFC (Near Field Communication) is an international standard of the short-range wireless communication technology.
14. ? (In-Camera Guide) button/ 🗑️ (Delete) button
15. MENU button

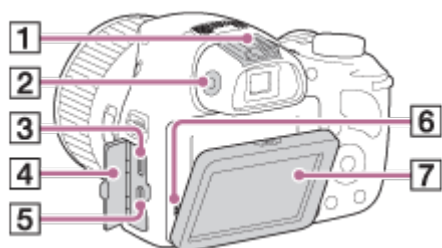

1. Multi interface shoe*
2. Diopter-adjustment dial
 - Adjust the diopter level using the diopter-adjustment dial when you set the display mode to the viewfinder mode.
 - When adjusting the diopter level, point the product to a bright area to make it easier to adjust the diopter level.
3. Multi/Micro USB Terminal*
 - Supports Micro USB compatible device.
4. Connector cover
5. HDMI micro jack
6. Speaker
7. LCD screen
 - You can adjust the angle of the LCD screen 60 degrees downwards and 90 degrees upwards. Adjust the angle of the LCD screen when you hold the camera at a high or low position for easier shooting. Do not move the LCD screen by force beyond its movable range.

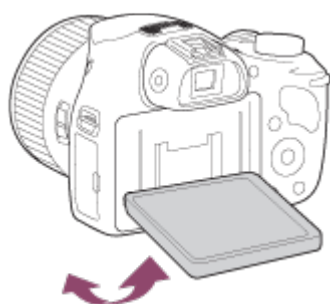

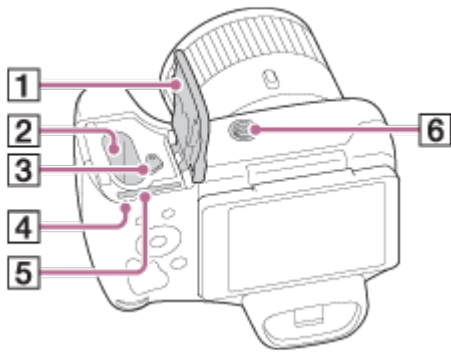

1. Battery/Memory card cover
2. Battery insertion slot
3. Battery eject lever
4. Access lamp
5. Memory card slot
6. Tripod socket hole

- Use a tripod with a screw less than 5.5 mm (7/32 inches) long. Otherwise, you cannot firmly secure the camera, and damage to the camera may occur.

*For details on compatible accessories for the multi interface shoe and the Multi/Micro USB Terminal, visit the Sony web site, or consult your Sony dealer or local authorized Sony service facility. You can also use accessories that are compatible with the accessory shoe. Operations with other manufacturers' accessories are not guaranteed.

ni Multi
Interface Shoe

Accessory Shoe

[2] How to Use | Before Use | Icons and indicators

List of icons on the screen

List of shooting mode icons

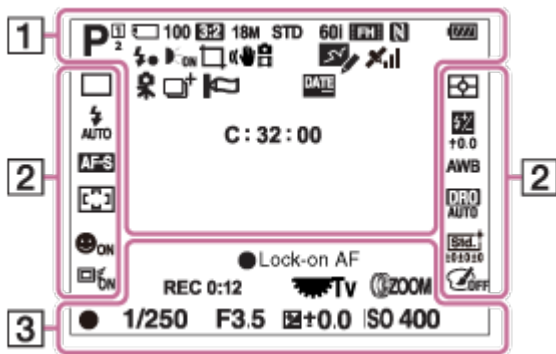

List of viewing mode icons

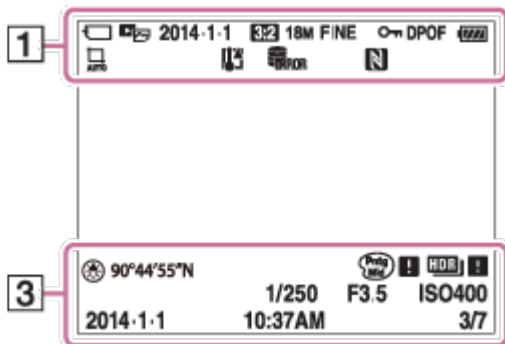

1. P P* A S M

Shooting mode

2

Memory number



Memory card/Uploading status



Scene Recognition icons



Scene Selection

100

Remaining number

3:2 **4:3** **16:9** **1:1**

Aspect ratio of still images

20M / 18M / 15M / 10M / 8.9M / 7.5M / 5.0M / 4.5M / 3.7M / 2.1M / VGA

WIDE **STD** **360**

Image size of still images

FINE STD

Image quality of still images

60p 60i 24p

Frame rate of movies

FX FH PS 1080 VGA

Recording settings of movies



NFC is activated



Remaining battery



Remaining battery warning



Flash charge in progress



AF Illuminator



SteadyShot



Camera-shake warning



Airplane Mode



GPS Log REC



GPS triangulating status



Overlay icon



Wind Noise Reduction



Write Date



Micref Level Low



Database file full/Database file error



Overheating warning



Smart zoom



Clear Image Zoom



Digital Zoom



Spot metering area

C:32:00

Self-diagnosis display

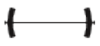

Digital level gauge



View Mode

100-0003

Folder – file number

AVCHD MP4

Recording format of movies



Protect

DPOF

DPOF set



Auto Object Framing

2. 

Drive Mode



Metering mode



Flash mode/Red-eye reduction

 ±0.0

Flash compensation

AF-S **AF-C** **DMF** **MF**

Focus mode

AWB 0 +1 +2 7500K A5 G5

White balance

Focus area

D-R **DRO** **HDR**
OFF AUTO AUTO

D-Range Optimizer/Auto HDR

Std. **Vivid** **Port.** **Land.** **Sunset** **B/W** **Sepia** ±0 ±0 ±0

Creative Style

OFF ON ON ON ON

Smile/Face Detect.

ON OFF

Lock-on AF

Toy **Pop** **Pos** **Pos** **Retro** **Strk** **Part** **Part** **Part** **Part** **HC** **Soft** **Prng** **Rich** **Mini** **WtrC** **Ilus**

Picture Effect



Smile detection sensitivity indicator

3. Lock-on AF

Guide display for Lock-on AF

Switch Av/Tv

Guide display for switching Aperture value/Shutter speed

REC 0:12

Recording time of the movie (m:s)

Manual ring function

Tv

Control dial function

Focus

1/250

Shutter speed

F3.5

Aperture value

 ±0.0

Metered Manual

 ±0.0

Exposure compensation

ISO400

ISO sensitivity



Shutter speed indicator



Aperture indicator



Histogram



GPS information

90°44'55"N

233°44'55"W

Latitude and longitude display



Picture Effect error



Auto HDR image warning

2014-1-1

10:37AM

Date of recording

3/7

File number/Number of images in the view mode

Using the shoulder strap

Attach the shoulder strap to prevent damage caused by dropping the product.

1. Attach both ends of the strap.

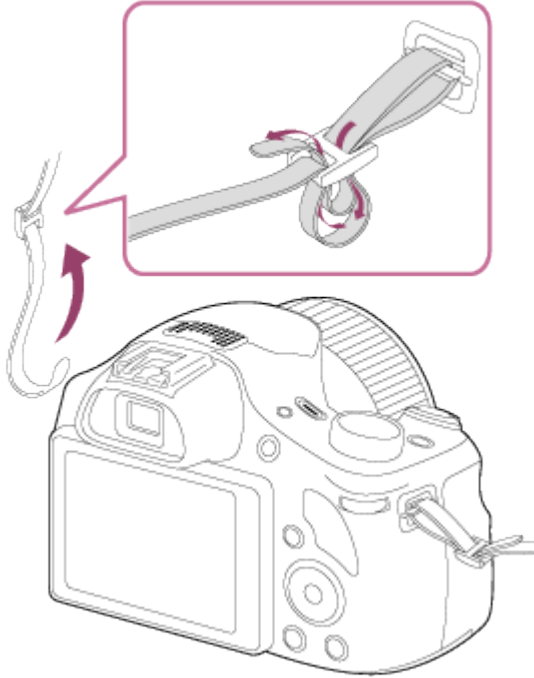

[4] How to Use | Before Use | Adjusting the viewfinder

Adjusting the viewfinder (diopter-adjustment)

Adjust the diopter-adjustment dial to your eyesight until the display appears clearly in the viewfinder.

1. Turn the diopter-adjustment dial.



[5] How to Use | Before Use | In-Camera guide

About the [In-Camera Guide]

The [In-Camera Guide] displays descriptions of MENU items, Fn (Function) button, and settings, and if a function cannot be set, the reason why.

1. Press the MENU or Fn button.
2. Select the desired MENU item using up/down/left/right side on the control button.
3. Press the ? (In-Camera Guide) button.

The operation guide for the MENU item you have selected in step 2 is displayed.

- If you press the ● on the center of the control button after selecting an item shown in gray, the reason the item cannot be set is displayed.

[6] How to Use | Before Use | In-Camera guide

About the shooting advice

Displays the shooting advice according to the selected shooting mode.

1. Press the ? (In-Camera Guide) button while the shooting screen is displayed.
2. Press the top/bottom button of the control button to select the desired shooting advice, then press ● on the center.
The shooting advice is displayed.

- You can scroll the screen by pressing the up/down button of the control button.





Hint

- To view all the shooting advice, select MENU →  (Camera Settings) → [Shooting Tip List].

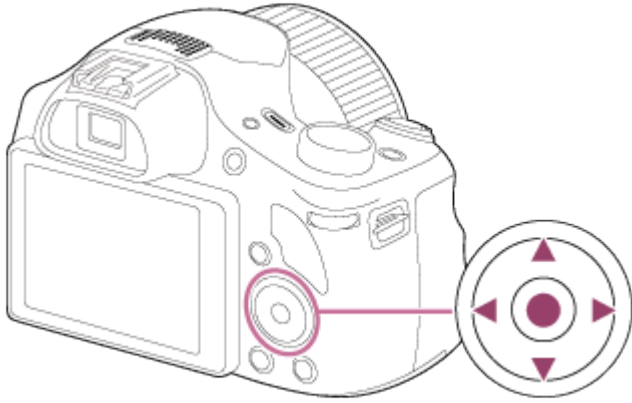
[7] How to Use | Confirming the operation method | Confirming the operation method

Using the control button



You can move the selection cursor by pressing the top/bottom/right/left side of the control button. Your selection is determined when you press ● on the center of the control button. The DISP (Display Setting),  (Exposure Comp.),  (Photo Creativity),  /  (Drive Mode) and  (Flash Mode) functions are assigned to the top/left/right side of the control button.

During playback, you can display the next/previous image by pressing the right/left button of the control button.

[8] How to Use | Confirming the operation method | Confirming the operation method

Using MENU items

In this section, you learn how to change settings related to all camera operations and execute camera functions including shooting, playback, and operation methods.

1. Press MENU button to display the Menu screen.

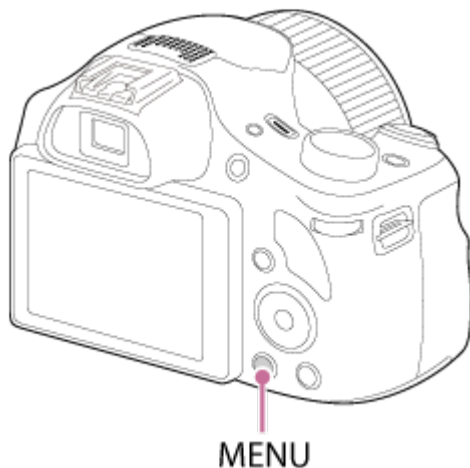

2. Select the desired MENU item using up/down/left/right button on the control button, and

then press ● on the center of the control button.

- The display may move directly from step 1 to step 3 depending on the [Tile Menu] setting.

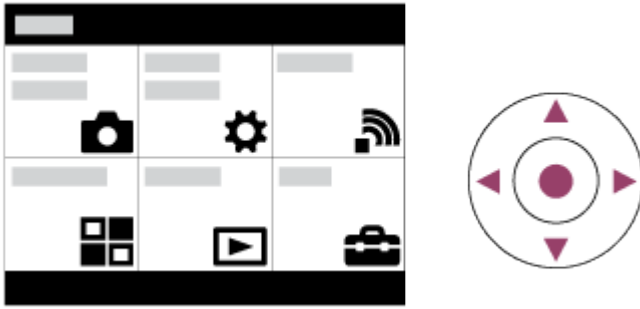

3. Select the desired setting item by pressing the control button, and then press ● on the center of the control button.
 - Select an icon at the top of the screen and press the left/right button on the control button to move to another MENU item.



4. Select the desired setting value, and press ● to confirm.

[9] How to Use | Confirming the operation method | Confirming the operation method

Using the Fn (Function) button

You can recall functions when shooting images. Up to 12 frequently used functions can be registered to the Fn (Function) button.

1. Press the Fn button in shooting mode.

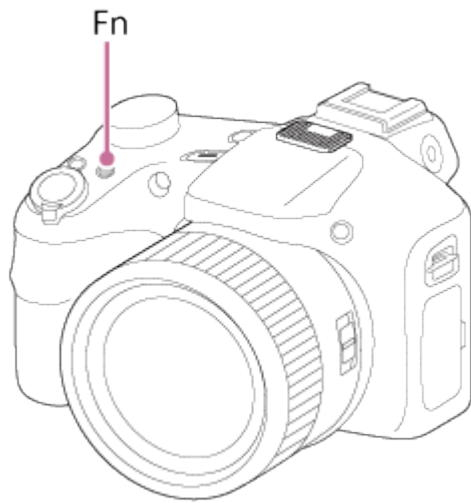

2. Select a function to be registered by pressing the up/down/left/right button on the control button.

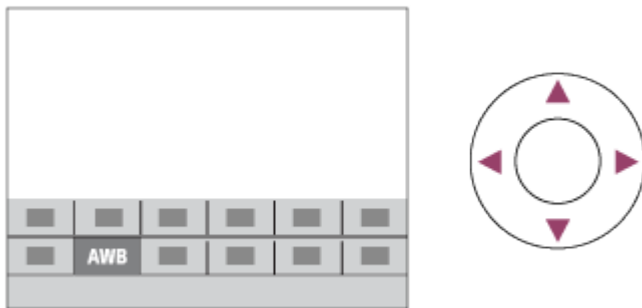

3. Set the desired setting by turning the control dial.

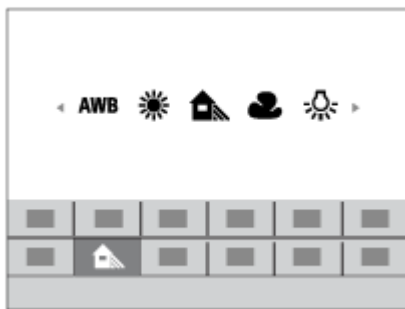

Performing settings on the dedicated screen

- Select the desired function in step 2, then press  on the center of the control button. The dedicated setting screen for the function appears. Follow the operating guides (A) to perform the settings.

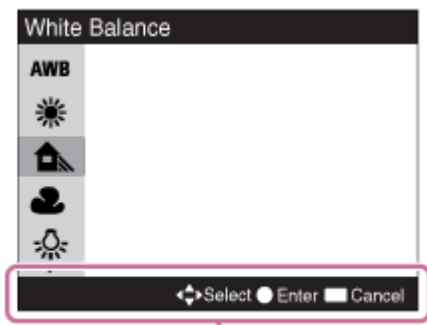

(A)

[10] How to Use | Shooting | Shooting still images/movies

Shooting still images

Shoots still images.

1. Set the shooting mode to **i** 📷 (Intelligent Auto).

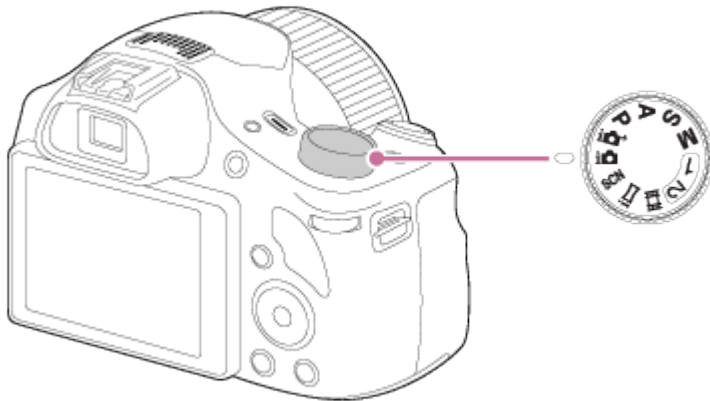

2. Adjust the monitor angle, and hold the camera. Or look through the viewfinder and hold the camera.
3. Press the shutter button halfway down to focus.
When the image is in focus, a beep sounds and the indicator (●) lights.

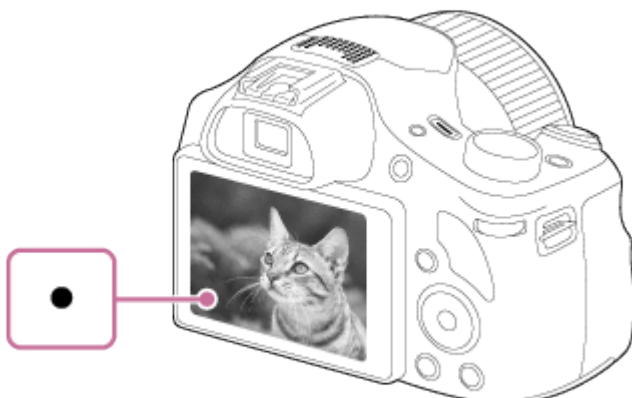

- The shortest shooting distance is approximately 1 cm (0.03 ft) (W), 240 cm (7.87 ft) (T) (from the lens).

4. Press the shutter button fully down.

Focus indicator

● lights:

Image is in the focus.

● flashes:

The focusing has failed.

Hint

- When the product cannot focus automatically, the focus indicator flashes and the beep does not sound. Either recompose the shot or change the focus setting.
- Focusing may be difficult in the following situations:

It is dark and the subject is distant.

The contrast between the subject and the background is poor.

The subject is seen through glass.

The subject is moving quickly.

There is reflective light or shiny surfaces.

There is a flashing light.

The subject is backlit.

[11] How to Use | Shooting | Shooting still images/movies

Shooting movies

You can record movies by pressing the MOVIE button.

1. Press the MOVIE button to start recording.

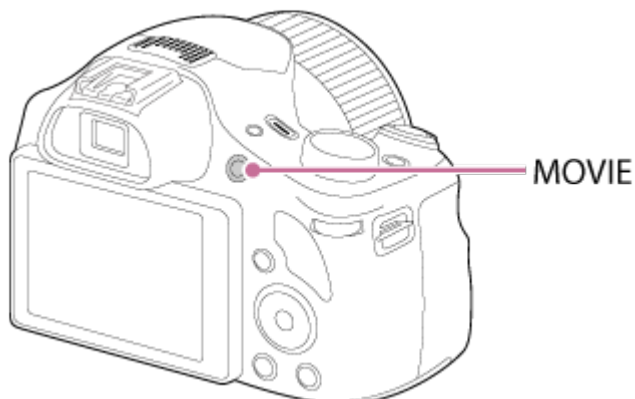

To adjust the shutter speed and aperture value to the desired settings, set the shooting mode to  (Movie).

2. Press the MOVIE button again to stop recording.

Note

- If you use a function such as zoom while shooting a movie, the noise of the product operating will be recorded. The sound of the MOVIE button operating may also be recorded when you press the MOVIE button to stop recording.
- For the continuous shooting time of a movie recording, refer to "Recordable time of movies." When movie recording is finished, you can restart recording by pressing the MOVIE button again. Recording may stop to protect the product depending on the ambient temperature.

[12] How to Use | Shooting | Selecting a shooting mode

List of mode dial functions

You can select the desired shooting mode by turning the mode dial.

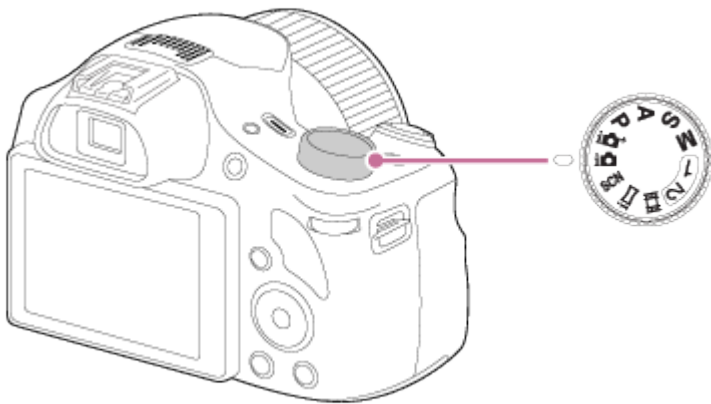

Available functions

 (Intelligent Auto):

Allows you to shoot still images with the settings adjusted automatically.

+ (Superior Auto):

Allows you to shoot still images in higher quality than with Intelligent Auto mode.

P (Program Auto):

Allows you to shoot with the exposure adjusted automatically (both the shutter speed and the aperture value (F value)). Also you can select various settings using the menu.

A (Aperture Priority):

Allows you to adjust the aperture and shoot when you want to blur the background, etc.

S (Shutter Priority):

Allows you to shoot fast-moving subjects etc., by manually adjusting the shutter speed.

M (Manual Exposure):

Allows you to shoot still images with the desired exposure by adjusting the shutter speed and the aperture value.

1/2 (Memory recall):

Allows you to shoot an image after recalling often-used modes or numeric settings registered in advance.

 (Movie):

Allows you to change the setting for movie recording.

 (iSweep Panorama):

Allows you to shoot a panoramic image by compositing the images.

SCN (Scene Selection):

Allows you to shoot with preset settings according to the scene.

[13] How to Use | Shooting | Selecting a shooting mode

Intelligent Auto

The product analyzes the subject, and allows you to shoot with appropriate settings.

1. Set the mode dial to  (Intelligent Auto).
2. Point the camera to the subject.
When the camera recognized the scene, the icon for the recognized scene appears on the screen.



3. Adjust the focus and shoot the image.



Note

- The product will not recognize the scene when you shoot images with zoom functions other than optical zoom.
- The product may not properly recognize these scenes under some shooting conditions.

Superior Auto

The product automatically recognizes and evaluates the shooting conditions, and the appropriate settings are set automatically.

The product may shoot multiple images and create a composite image, etc., using more shooting settings than in Intelligent Auto mode to record higher quality images.

1. Set the mode dial to  (Superior Auto).
2. Point the camera to the subject.
When the camera recognizes a scene, the scene recognition icon appears on the screen.
If necessary,  (overlay icon) may appear.

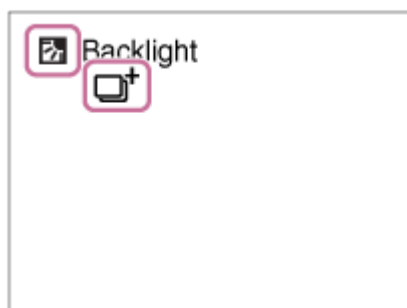

3. Adjust the focus and shoot the image.

Note











- When the product is used to create composite images, the recording process takes longer than usual.
- The product will not recognize the scene when you use zoom functions other than optical zoom.
- The product may not properly recognize a scene under some shooting conditions.





About Scene Recognition

Scene Recognition operates in [Intelligent Auto] mode and [Superior Auto] mode.

This function allows the product to automatically recognize the shooting conditions and shoot the image.

Scene Recognition:

If the product recognizes a scene, icons and guides such as  (Portrait),  (Infant),  (Night Portrait),  (Night Scene),  (Backlight Portrait),  (Backlight),  (Landscape),  (Macro),  (Spotlight), or  (Low Light) are displayed on the first line.

If the product recognizes a condition, icons such as  (Tripod),  (Walk)*,  (Move),  (Move (Bright)) or  (Move (Dark)) are displayed on the second line.

*The condition  (Walk) is recognized only when [ SteadyShot] is set to [Active] or [Intelligent Active].

Note

- When [Smile/Face Detect.] is set to [Off], the [Portrait], [Backlight Portrait], [Night Portrait], and [Infant] scenes are not recognized.

[16] How to Use | Shooting | Selecting a shooting mode

The advantages of automatic shooting

In [Superior Auto] mode, the product shoots with higher quality than [Intelligent Auto] mode and performs composite shooting as necessary.

In [Program Auto] mode, you can shoot after adjusting various functions, such as white balance, ISO, etc.

 (Intelligent Auto):

Select this mode when you want the camera automatically recognize the scene.

+ (Superior Auto):

Select this mode to shoot scenes under difficult circumstances, such as when it is dark or the subjects are back-lit. Select this mode to shoot a higher quality image than that provided by

 (Intelligent Auto).

P (Program Auto):

Select this mode to shoot with various functions other than the exposure (shutter speed and aperture) adjusted.

Note

- In [Intelligent Auto] mode, you may not be able to shoot dark scenes or back-lit subjects clearly.
- In [Superior Auto] mode, the recording process takes longer, since the product creates a composite image.

[17] How to Use | Shooting | Selecting a shooting mode

Program Auto

Allows you to shoot with the exposure adjusted automatically (both the shutter speed and the aperture value).

You can set shooting functions such as [ISO].

1. Set the mode dial to P (Program Auto).
2. Set the shooting functions to your desired settings.
3. Adjust the focus and shoot the subject.

Program Shift

You can change the shutter speed and aperture (F-value) combination by rotating the control dial, without changing the appropriate exposure that is set by this product. This function is available when you do not use the flash.

- “P” on the screen changes to “P*” when you turn the control dial.
- To cancel program shift, turn the control dial to return the indication to “P”.

Note

- According to the brightness of the environment, the program shift may not be used.
- Set the shooting mode to another one than “P” or turn off the power to cancel the setting you made.
- When the brightness changes, the aperture (F value) and shutter speed also change while maintaining the shift amount.

[18] How to Use | Shooting | Selecting a shooting mode

iSweep Panorama

Allows you to create a single panoramic image from multiple images shot while panning the camera.



1. Set the mode dial to (iSweep Panorama).



2. Point the camera at the subject for which you want to set the focus and brightness.
3. While pressing the shutter button halfway down, aim the camera at one end of the desired panoramic composition.

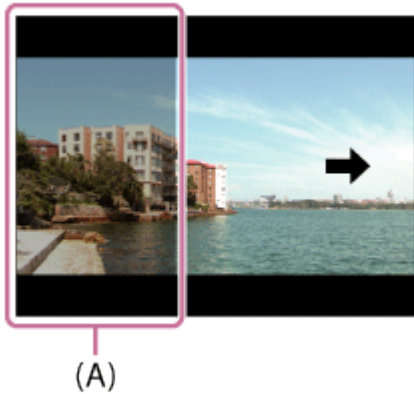

(A) This part will not be shot.

4. Press the shutter button fully down.
5. Pan the camera to the end of the guide in the direction of the arrow on the monitor.

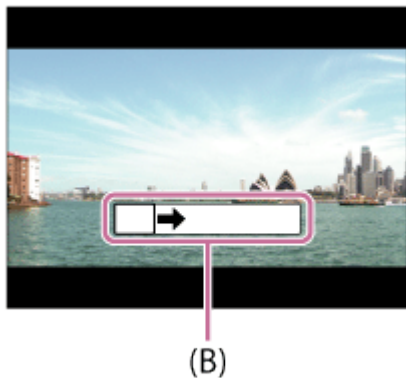

(B) Guidance bar

Note

- If the entire angle of the panoramic shot is not achieved within the set time, a gray area occurs in the composite image. If this happens, move the product faster to record the full panoramic image.
- When [Wide] is selected for [Panorama: Size], the entire angle of the panoramic shot may not be achieved within the given time. If this happens, try shooting after changing [Panorama: Size] to [Standard].
- Since several images are stitched together, the stitched part may not be recorded smoothly in some cases.
- The images may be blurred in dark scenes.

When a light source such as a fluorescent light flickers, the brightness and color of a stitched image may not be consistent.

- When the whole angle of panoramic shooting and the AE/AF locked angle are very different in brightness and focus, the shooting may not be successful. If this happens, change AE/AF locked angle and shoot again.
- The following situations are not suited for shooting Sweep Panorama:
 - Moving subjects.
 - Subjects that are too close to the product.
 - Subjects with continuously similar patterns, such as the sky, beach, or a lawn.
 - Subjects with constant change such as waves or water falls.
 - Subjects with brightness widely different from its surroundings such as the sun or a light bulb.
- The Sweep Panorama shooting may be interrupted in the following situations.
 - When the camera is panned too fast or too slow.
 - The subject is too blurry.

Hint

- You can turn the control dial on the shooting screen to select the shooting direction.

[19] How to Use | Shooting | Selecting a shooting mode

Scene Selection

Allows you to shoot with preset settings according to the scene.

1. Set the mode dial to SCN (Scene Selection).
2. MENU →  (Camera Settings) → [Scene Selection] → desired mode.
 - When [Mode Dial Guide] is set to [On], you can select the desired settings after you have changed the position of the mode dial.

Menu item details

 Portrait:

Blurs background and sharpens the subject. Accentuates the skin tones softly.



 Adv.Sports Shooting:

Allows you to shoot subjects with fast movements, such as sports. While the shutter is pressed

halfway, the movement of the subject is predicted and the focus will be adjusted.



🏔 Landscape:

Shoots the entire range of a scenery in sharp focus with vivid colors.



🌙 Night Scene:

Shoots night scenes without losing the dark atmosphere.



🌙👤 Hand-held Twilight:

Shoots night scenes with less noise and blur without using a tripod. A burst of shots are taken, and image processing is applied to reduce subject blur, camera-shake, and noise.



🌙👤 Night Portrait:

Shoots night scene portraits using the flash.



👤👤 Anti Motion Blur:

Allows you to shoot indoor shots without using the flash and reduces subject blur. The product shoots burst images and combines them to create the image, reducing subject blur and noise.



 Pet:

Allows you to shoot images of your pet with the best settings.



 Gourmet:

Allows you to shoot food arrangements in delicious and bright colors.



 Beach:

Allows you to shoot scenes on the beach in bright and vivid colors even under the sunlight.



 Snow:

Allows you to shoot clear images, preventing sunken colors in snowy scenes or other places where the whole screen appears white.



 Fireworks:

Allows you to shoot images of fireworks in all their splendor.



Soft Skin:

Allows you to shoot images of faces with a smoother look.



High Sensitivity:

Allows you to shoot still images even in dark locations without using the flash, and reduces subject blur. Also allows you to shoot dark movie scenes more brightly.

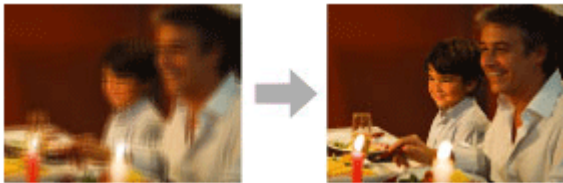

Note

- In the [Night Scene], [Night Portrait] and [Fireworks] modes, the shutter speed is slower, so use of a tripod is recommended to prevent the image from blurring.
- In the [Hand-held Twilight] or [Anti Motion Blur] mode, the shutter clicks 4 times and an image is recorded.
- Reducing blur is less effective even in [Hand-held Twilight] or [Anti Motion Blur] when shooting the following subjects:
 - Subjects with erratic movement.
 - Subjects that are too close to the product.
 - Subjects with continuously similar patterns, such as the sky, a beach, or a lawn.
 - Subjects with constant change such as waves or water falls.
- In the case of [Hand-held Twilight] or [Anti Motion Blur], block noise may occur when using a light source that flickers, such as fluorescent lighting.

Hint

- To change the scene, rotate the control dial on the shooting screen and select a new scene.

Shutter Priority

You can express the movement of a moving subject in various ways by adjusting the shutter speed, for example, at the instant of the movement with high speed shutter, or as a trailing image with low speed shutter.

1. Set the mode dial to S (Shutter Priority).
2. Select the desired value by turning the control dial.
3. Adjust the focus and shoot the subject.
The aperture is automatically adjusted to obtain proper exposure.

Note

- If proper exposure cannot be obtained after setup, the aperture value on the shooting screen blinks. Although you can shoot as it is, resetting is recommended.
- Use a tripod to prevent blurring when you use a slow shutter speed.
- The  (SteadyShot warning) indicator does not appear in shutter speed priority mode.
- When the shutter speed is 1/3 second(s) or longer, noise reduction will be done after shooting for the same amount of time that the shutter was open. However, you cannot shoot any more while noise reduction is in progress.
- The brightness of the image on the monitor may differ from the actual image being shot.

Hint

- When a faster shutter speed is used, moving subjects, such as a running person, cars, or sea spray appear as if they are stopped. When a slower shutter speed is used, a trailing image of the movement of the subject is captured to create a more natural and dynamic image.

[21] How to Use | Shooting | Selecting a shooting mode

Aperture Priority

You can shoot by adjusting the aperture and changing the range in focus, or by defocusing the background. The aperture value can be changed while recording movies.

1. Set the mode dial to A (Aperture Priority).
2. Select the desired value by turning the control dial.
 - Smaller F-value: The subject is in focus, but objects in front of and beyond the subject

are blurred.

Larger F-value: The subject and its foreground and background are all in focus.

3. Adjust the focus and shoot the subject.

The shutter speed is automatically adjusted to obtain proper exposure.

Note

- If proper exposure cannot be obtained after setup, the shutter speed on the shooting screen blinks. Although you can shoot as it is, resetting is recommended.
- The brightness of the image on the screen may differ from the actual image being shot.

Hint

- Smaller F-value (opening the aperture) narrows the range that is in focus. This allows you to put the subject in sharp focus and blur objects in front of and beyond the subject (depth of field becomes shallower). Larger F-value (narrowing down the aperture) widens the range that is in focus. This allows you to shoot the depth of the scenery (depth of field becomes deeper).

[22] How to Use | Shooting | Selecting a shooting mode

Manual Exposure

You can shoot with the desired exposure setting by adjusting both the shutter speed and aperture. The shutter speed and the aperture value can be changed while recording movies.

1. Set the mode dial to M (Manual Exposure).
2. Press the bottom button on the control button to select the shutter speed or aperture value, then turn the control dial to select a value.
Check the exposure value at “MM” (metered manual).
Toward +: Images become brighter.
Toward - : Images become darker.
0: Appropriate exposure analyzed by the product
3. Adjust the focus and shoot the subject.

Note

- [ISO AUTO] cannot be selected for [ISO] in manual exposure mode.
- In manual exposure mode, the [ISO AUTO] setting under [ISO] is switched to the minimum

ISO sensitivity. Change the ISO value to your desired setting if necessary.

- When the amount of ambient light exceeds the metering range of the Metered Manual, the Metered Manual indicator flashes.
- The  (SteadyShot warning) indicator does not appear in manual exposure mode.
- The brightness of the image on the monitor may differ from the actual image being shot.

[23] How to Use | Shooting | Selecting a shooting mode

Memory recall

Allows you to shoot an image after recalling often-used modes or camera settings registered in advance.

1. Set the mode dial to 1 or 2 (Memory recall).
2. Press  on the center of the control button.



Note

- Register shooting settings in advance by [Memory].
- If you set [Memory recall] after completing the shooting settings, the registered settings are given priority and the original settings may become invalid. Check the indicators on the screen before shooting.

[24] How to Use | Shooting | Selecting a shooting mode

Movie

You can adjust the shutter speed or aperture value to your desired settings for recording movies. You can also check the image angle before shooting.

1. Set the mode dial to  (Movie).
2. MENU →  (Camera Settings) → [Movie] → desired setting.
 - When [Mode Dial Guide] is set to [On], you can select the desired settings after you have changed the position of the mode dial.
3. Press the MOVIE button to start recording.

Press the MOVIE button again to stop recording.

Menu item details

 Program Auto:

Allows you to shoot with the exposure (both the shutter speed and the aperture value) adjusted automatically. The other settings can be adjusted manually.

 Aperture Priority:

Allows you to shoot after adjusting the aperture value manually.

 Shutter Priority:

Allows you to shoot after adjusting the shutter speed manually.

 Manual Exposure:

Allows you to shoot after adjusting the exposure (both the shutter speed and the aperture value) manually.

[25] How to Use | Using shooting functions | Using the zoom

Zoom

Enlarge images using the W/T (zoom) lever when shooting.

1. Enlarge images with the W/T (zoom) lever when shooting.
 - Move the W/T (zoom) lever to the T side to zoom in and to the W side to zoom out.

Hint

- When you select other than [Optical zoom only] for [Zoom Setting], you can exceed the zoom range of the optical zoom to zoom images.
- When the Zoom/Focus switch is set to AF/ZOOM, you can zoom images by rotating the manual ring.

[26] How to Use | Using shooting functions | Using the zoom

The zoom features available with this product

The zoom feature of the product provides a higher magnification zoom by combining various zoom features. The icon displayed on the screen changes, according to the selected zoom

feature.

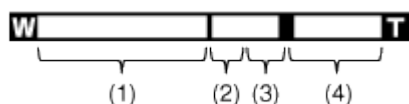

(1) Optical zoom range

Images are magnified within the optical zoom range of this product.

(2) Smart Zoom range ()

Zoom images without causing the original quality to deteriorate by partially cropping an image (only when the image size is [M], [S] or [VGA]).



(3) Clear Image Zoom range ()

Zoom images using an image process with less deterioration. Set [Zoom Setting] to [On:ClearImage Zoom] or [On : Digital Zoom] first.

(4) Digital Zoom range ()

You can magnify images using an image process. When you select [On : Digital Zoom] for [Zoom Setting], you can use this zoom function.

Note

- The default setting for [ Image Size] is [L]. To use the smart zoom change [ Image Size] to [M], [S] or [VGA].
- Zoom functions other than the optical zoom are not available when shooting in the following situations:
 - [Smile/Face Detect.] is set to [Smile Shutter]
- You cannot use the Smart Zoom function with movies.
- When you use a zoom function other than the optical zoom, the [Focus Area] setting is disabled and the focus area frame is shown by the dotted line. The AF operates with priority on and around the center area. Also, [Metering Mode] is fixed to [Multi].

[27] How to Use | Using shooting functions | Using the zoom

Zoom Setting

You can select the zoom setting of the product.

1. MENU →  (Custom Settings) → [Zoom Setting] → desired setting.

Menu item details

Optical zoom only:

Optical zoom is activated. You can use the Smart Zoom function if you set [ Image Size] to

[M], [S] or [VGA].

On:ClearImage Zoom (default setting):

Even if the zoom range of the optical zoom is exceeded, the product magnifies images within the range in which image quality does not deteriorate significantly.

On : Digital Zoom:

When the zoom range of the [Clear Image Zoom] is exceeded, the product magnifies images to the largest scale. However, the image quality will deteriorate.

Note

- Set [Optical zoom only] if you want to magnify images within the range in which image quality does not deteriorate.

[28] How to Use | Using shooting functions | Using the zoom

About zoom scale

The zoom scale changes according to the settings of this product. The zoom scale for each setting is as follows.

When [ Aspect Ratio] is [4:3]

[Zoom Setting]: [Optical zoom only (including smart zoom)]

[ Image Size]: L 50x, M 71x, S 100x, VGA 405x

[Zoom Setting]: [On:ClearImage Zoom]

[ Image Size]: L 100x, M 142x, S 200x, VGA 810x

[Zoom Setting]: [On : Digital Zoom]

[ Image Size]: L 200x, M 284x, S 400x, VGA 810x

[29] How to Use | Using shooting functions | Using the flash

Using flash

In dark environments, use the flash to light up the subject while shooting and to prevent camera-shake. When shooting against the sun, use the flash to lighten the image of the backlit subject.

1. Press the  (Flash pop-up) button to pop up the flash.

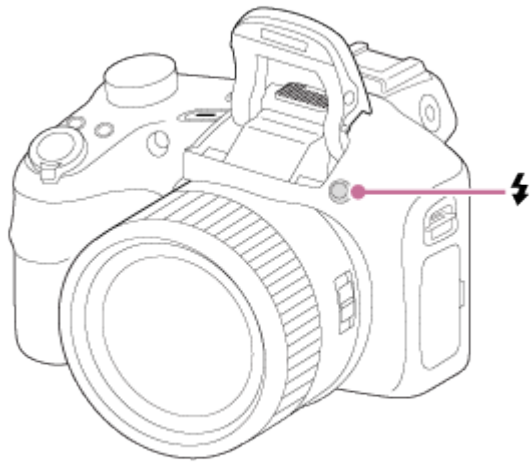

2. Press the shutter button fully down.

When you do not use the flash



When not using the flash, press it back into the camera body.



Note

- When not using the flash, press it back into the camera body.
- You cannot use the flash when recording movies.
- While charging the flash,  flashes. After charging is completed, the flashing icon will light up.
- When an external flash (sold separately) is attached to the Multi Interface Shoe, the state of the external flash has priority over the setting of the product. You cannot use the product's internal flash.
- Do not use a commercially available flash with high-voltage synchro terminals or with reverse polarity.
- When shooting with the flash and the zoom is set to W, the shadow of the lens may appear on the screen, depending on the shooting conditions. If this happens, shoot away from the subject or set the zoom to T and shoot with the flash again.

You can set the flash mode.

1. MENU →  (Camera Settings) → [Flash Mode] → desired setting.
 - You can also set the flash mode by pressing the  (Flash Mode) on the control button.

Menu item details

 Flash Off:

The flash does not operate.

 Autoflash (default setting):

The flash works in dark environments or when shooting towards bright light.

 Fill-flash:

The flash works every time you trigger the shutter.

 Slow Sync.:

The flash works every time you trigger the shutter. Slow sync shooting allows you to shoot a clear image of both the subject and the background by slowing the shutter speed.

 Advanced Flash:

The flash automatically operates in dark locations or when there is backlighting. In dark locations, the upper limit value of the ISO sensitivity increases in order to maximize the flash range.

 Rear Sync.:

The flash works right before the exposure is completed every time you trigger the shutter. Rear sync shooting allows you to shoot a natural image of the trail of a moving subject such as a moving car or a walking person.

 Wireless:

When using a wireless flash, the shading effect provides a more 3D appearance to a subject than when using an attached flash.

This mode is effective when you attach a remote control-compatible external flash (sold separately) to the product, and shoot with a wireless flash (sold separately), placed away from the product.

Note

- The default setting depends on the shooting mode.
- Available flash mode depends on the shooting mode.
- The [Wireless] setting cannot be used with the camera's internal flash.

Flash Comp.

Adjusts the amount of flash light in a range of -2.0 EV to $+2.0$ EV.

Flash compensation changes the amount of flash light only. Exposure compensation changes the amount of flash light along with the change of the shutter speed and aperture.

1. MENU →  (Camera Settings) → [Flash Comp.] → desired setting.
Selecting higher values (+ side) makes the flash level higher, and lower values (– side) makes the flash level lower.

Note

- The higher flash effect may not be visible due to the limited amount of flash light available, if the subject is outside the maximum range of the flash. If the subject is very close, the lower flash effect may not be visible.

Switching the screen display (Shooting)

You can change the display contents on the screen.

1. Press the DISP (Display Setting) button.
Each time you press the DISP button, the recording information display changes as follows:
Graphic Display → Display All Info. → No Disp. Info. → Histogram → Level → Graphic Display
Graphic Display

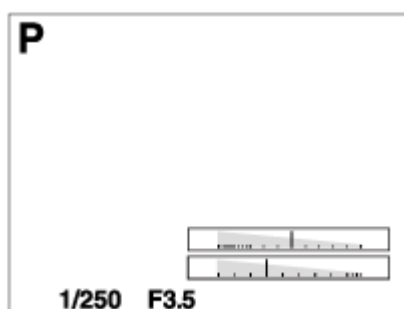

Display All Info.

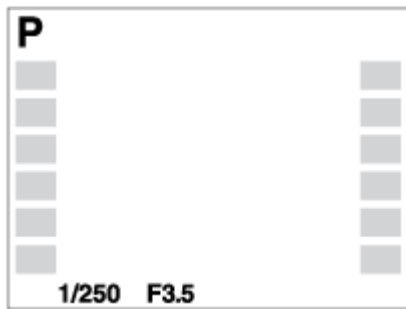

No Disp. Info.



Histogram

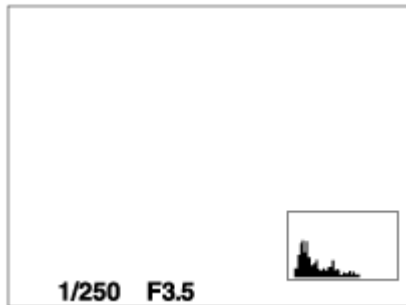

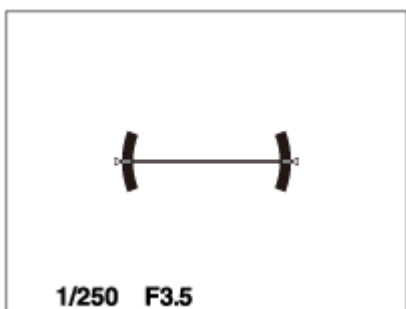

Level



Note

- Histogram is not displayed during panorama shooting.

The larger the image size, the more detail will be reproduced when the image is printed on large-format paper. The smaller the image size, the more images can be recorded.

1. MENU →  (Camera Settings) → [ Image Size] → desired setting.

Menu item details

Image size when [ Aspect Ratio] is 3:2

L: 18M 5184x3456 pixels

M: 8.9M 3648x2432 pixels

S: 4.5M 2592x1728 pixels

Image size when [ Aspect Ratio] is 4:3

L: 20M 5184x3888 pixels

M: 10M 3648x2736 pixels

S: 5.0M 2592x1944 pixels

VGA 640x480 pixels

Image size when [ Aspect Ratio] is 16:9

L: 15M 5184x2920 pixels

M: 7.5M 3648x2056 pixels

S: 2.1M 1920x1080 pixels

Image size when [ Aspect Ratio] is 1:1

L: 15M 3888x3888 pixels



M: 7.5M 2736x2736 pixels

S: 3.7M 1920x1920 pixels

[34] How to Use | Using shooting functions | Selecting still image size/image quality

Aspect Ratio (still image)

Sets the aspect ratio of still images.

1. MENU →  (Camera Settings) → [ Aspect Ratio] → desired setting.

Menu item details

3:2:

Suitable for standard prints.

4:3 (default setting):

Shoots in 4:3 aspect ratio.

16:9:

For viewing on a high-definition TV.



1:1:

For shooting in composition as a medium format camera.

[35] How to Use | Using shooting functions | Selecting still image size/image quality

Quality (still image)

Selects the compression format of still images.

1. MENU →  (Camera Settings) → [ Quality] → desired setting.

Menu item details

Fine (default setting):

File format: JPEG

The image is compressed in the JPEG format when recorded.

Standard:

File format: JPEG

The image is compressed in the JPEG format when recorded. Since the compression rate of [Standard] is higher than that of [Fine], the file size of [Standard] is smaller than that of [Fine]. This will allow more files to be recorded on 1 memory card, but the image quality will be lower.

[36] How to Use | Using shooting functions | Selecting still image size/image quality

Panorama: Size

Sets the image size when shooting panoramic images. The image size varies depending on the [Panorama: Direction] setting.

1. MENU →  (Camera Settings) → [Panorama: Size] → desired setting.

Menu item details

When [Panorama: Direction] is [Up] or [Down]

Standard: 3424×1920

Wide: 4912×1920

When [Panorama: Direction] is [Left] or [Right]

Standard: 4912×1080

Wide: 7152×1080

360°: Allows you to shoot in the size of 11520×1080, 360 degrees around.

[37] How to Use | Using shooting functions | Selecting still image size/image quality

Panorama: Direction

Sets the direction to pan the camera when shooting panoramic images.

1. MENU →  (Camera Settings) → [Panorama: Direction] → desired setting.

Menu item details

Right (default setting):

Pan the camera from the left to the right.

Left:

Pan the camera from the right to the left.

Up:

Pan the camera from the bottom to the top.

Down:

Pan the camera from the top to the bottom.

[38] How to Use | Using shooting functions | Adjusting the focus

Changing the focus method using the zoom/focus switch

You can select the focusing method to suit the movement of the subject.

1. Slide the zoom/focus switch to select the desired focus method.

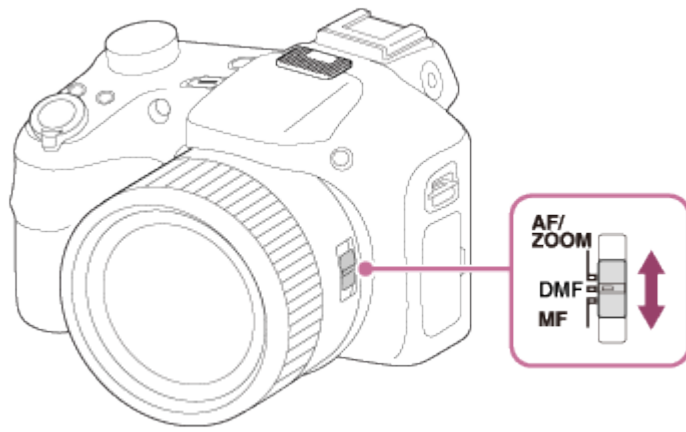

Focus mode details

AF/ZOOM (Single-shot AF):

The camera focuses and the focus is locked when the focus is achieved. Use this mode when the subject is motionless.

DMF (DMF):

After focusing automatically, make fine focus adjustment manually.

MF (Manual Focus):

Adjusts the focus manually.

Note

- Dust or fingerprints on the lens may show on the image if the subject is too close. Wipe the lens with a soft cloth, etc.
- Once you change the focus method, the set focus distance is erased.

Hint

- If you cannot achieve focus for the intended subject using auto focus, select MF or DMF, and then shoot again.
- When the zoom/focus switch is set to AF/ZOOM or DMF during movie recording, [Focus Mode] is switched to **AF-C** (Continuous AF), and the product keeps focusing on the subject.

[39] How to Use | Using shooting functions | Adjusting the focus

Focus Area

Selects the focusing area. Use this function when it is difficult to get the proper focus in auto focus mode.

1. MENU →  (Camera Settings) → [Focus Area] → desired setting.

Menu item details

 Wide:

Focuses automatically on a subject in all ranges of the image.

When you press the shutter button halfway down in still image shooting mode, a green frame is displayed around the area that is in focus.

 Center:

Focuses automatically on a subject in the center of the image. When used together with the AF lock function, you can compose the image you want.

 Flexible Spot:

Allows you to move the AF range frame to the desired point on the screen and focus on an extremely small subject in a narrow area.

On the Flexible Spot shooting screen, you can change the size of the AF range finder frame by rotating the control dial.

[40] How to Use | Using shooting functions | Adjusting the focus

Focus-lock

Shoots images with the focus locked on the desired subject in auto focus mode.

1. Set the zoom/focus switch to AF/ZOOM.
2. Place the subject within the AF area and press the shutter button halfway down.
The focus is locked.
3. Keep pressing the shutter button halfway down, and place the subject back in the original position to re-compose the shot.
4. Press the shutter button down fully to take the picture.

[41] How to Use | Using shooting functions | Adjusting the focus

Manual Focus

When it is difficult to get the proper focus in autofocus mode, you can adjust the focus manually.

1. Set the zoom/focus switch to MF.
2. Rotate the manual ring to achieve sharp focus.

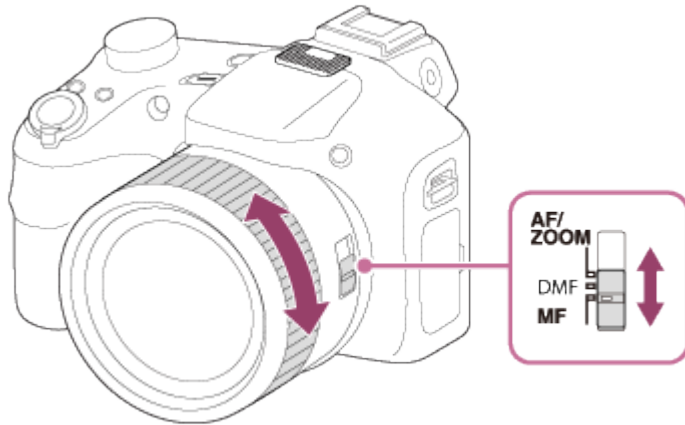

3. Press the shutter button fully down to shoot an image.
 - When you rotate the manual ring, the focus distance is displayed on the screen.

[42] How to Use | Using shooting functions | Adjusting the focus

Direct manual focus (DMF)

You can make fine adjustments manually after the focus is locked.

You can quickly focus on a subject rather than using the manual focus from the beginning. This is convenient in cases such as macro shooting.

1. Set the zoom/focus switch to DMF.
2. Press the shutter button halfway down to focus automatically.
3. Keep the shutter button halfway down, rotate the manual ring to achieve a sharper focus.

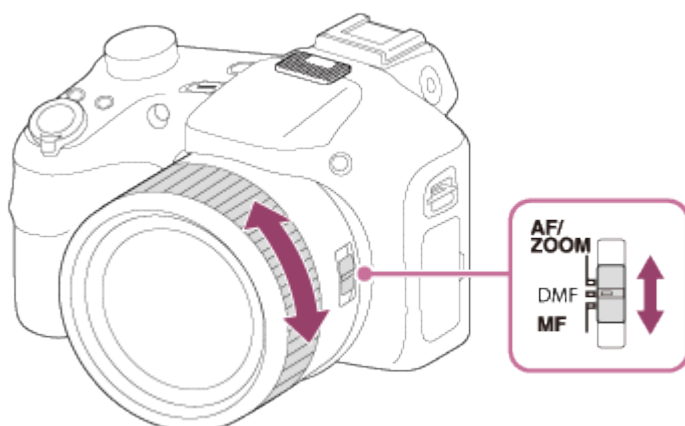



4. Press the shutter button fully down to shoot an image.
 - When you rotate the manual ring, the focus distance is displayed on the screen.

[43] How to Use | Using shooting functions | Adjusting the focus

MF Assist (still image)

Enlarges the image on the screen automatically to make manual focusing easier. This works in Manual Focus or Direct Manual Focus shooting.

1. MENU →  (Custom Settings) → [ MF Assist] → [On].
2. Turn the focus ring to adjust the focus.

- The image is enlarged.



Note

- You cannot use [ MF Assist] when shooting movies.

[44] How to Use | Using shooting functions | Adjusting the focus

Focus Magnifier

You can check the focus by enlarging the image before shooting.

1. MENU →  (Camera Settings) → [Focus Magnifier].
2. Press  on the center of the control button to enlarge the image and select the position you want to enlarge using up/down/left/right button on the control button.
3. Confirm the focus.
4. Press the shutter button fully down to shoot the image.

Hint

- Each time you press  in the center, the magnifier scaling changes.
- When focusing manually, you can adjust the focus while an image is magnified.

- The [Focus Magnifier] function will be released when the shutter button is pressed halfway.
- You can record images while an image is enlarged, but the product records a full-display image.
- The [Focus Magnifier] function will be released after shooting.

[45] How to Use | Using shooting functions | Adjusting the focus

Focus Magnif. Time

Set the duration for which an image is to be magnified using the [ MF Assist] or [Focus Magnifier] function.

1. MENU →  (Custom Settings) → [Focus Magnif. Time] → desired setting.

Menu item details

2 Sec (default setting):

Magnifies the images for 2 seconds.

5 Sec:

Magnifies the images for 5 seconds.

No Limit:

Magnifies the images until you press the shutter button.

[46] How to Use | Using shooting functions | Adjusting the focus

Peaking Level

Enhances the outline of in-focus ranges using a specific color in Manual Focus or Direct Manual Focus shooting. This function allows you to confirm the focus easily.

1. MENU →  (Custom Settings) → [Peaking Level] → desired setting.

Menu item details

High:

Sets the peaking level to high.

Mid:

Sets the peaking level to middle.

Low:

Sets the peaking level to low.

Off (default setting):

Does not use the peaking function.

Note

- Since the product determines that sharp areas are in focus, [Peaking Level] differs, depending on the subject and shooting situation.
- The outline of in-focus ranges is not enhanced when the product is connected using an HDMI cable.

[47] How to Use | Using shooting functions | Adjusting the focus

Peaking Color

Sets the color used for the peaking function in Manual Focus or Direct Manual Focus shooting.

1. MENU →  (Custom Settings) → [Peaking Color] → desired setting.

Menu item details

Red:

Enhances outlines in red.

Yellow:

Enhances outlines in yellow.

White (default setting):

Enhances outlines in white.

[48] How to Use | Using shooting functions | Adjusting the focus

Lock-on AF

Set up the tracking function to continue focusing on the subject.

1. MENU →  (Camera Settings) → [Lock-on AF] → desired setting.

Menu item details

 OFF Off:

Does not track a subject to be focused on.



 ON On:

Tracks a subject to be focused on.

[49] How to Use | Using shooting functions | Adjusting the focus

Lock-on AF (On)

Maintains the focus on a moving subject automatically.

1. MENU →  (Camera Settings) → [Lock-on AF] → [On].
2. Align the target frame and the subject to be tracked, and press  in the center.

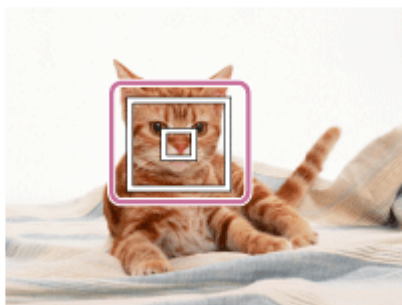

Note

- The [Lock-on AF] function may not operate well in the following situations:

The subject is moving too quickly.

The subject is too small, or too large.

The contrast between the subject and the background is poor.

It is dark.

The ambient light changes.



Hint

- If you lose track of the subject, this product can detect the subject and resume the Lock-on AF function when the subject reappears on the screen.

[50] How to Use | Using shooting functions | Adjusting the focus

AF Illuminator (still image)

The AF illuminator supplies fill light to focus more easily on a subject in dark surroundings. The red AF illuminator allows the product to focus easily when the shutter button is pressed halfway, until the focus is locked.

1. MENU →  (Camera Settings) → [ AF Illuminator] → desired setting.

Menu item details

Auto (default setting):

Uses the AF illuminator.

Off:

Does not use the AF illuminator.

Note

- Focus is achieved as long as the AF illuminator light reaches the subject, regardless of whether light fails to reach the center of the subject.
- You cannot use [ AF Illuminator] in the following situations:
 - In movie mode
 - In [iSweep Panorama] mode
 - When [Scene Selection] is set to [Landscape], [Adv.Sports Shooting], [Night Scene], [Pet] or [Fireworks].
- When [Focus Area] is set to [Wide], the AF range finder frame is indicated by a dotted line.
- The AF illuminator emits a very bright light. Although there is no health hazard, do not look directly into the AF illuminator at close range.

[51] How to Use | Using shooting functions | Adjusting the exposure

Exposure Comp.

Based on the exposure value set by auto exposure, you can make the entire image brighter or darker if you adjust [Exposure Comp.] to the plus side or minus side, respectively (exposure compensation). Normally, exposure is set automatically (auto exposure).

1. MENU →  (Camera Settings) → [Exposure Comp.] → desired setting.
You can adjust the exposure in a range of -2.0 EV to +2.0 EV.

Note

- If you shoot a subject in extremely bright or dark conditions, or when you use the flash, you may not be able to get a satisfactory effect.

[52] How to Use | Using shooting functions | Adjusting the exposure

Metering Mode

Selects the metering mode that sets which part of the screen to measure for determining the exposure.

1. MENU →  (Camera Settings) → [Metering Mode] → desired setting.

Menu item details

 Multi (default setting):

Measures light on each area after dividing the total area into multiple areas and determines the proper exposure of the entire screen (Multi-pattern metering).

 Center:

Measures the average brightness of the entire screen, while emphasizing the central area of the screen (Center-weighted metering).

 Spot:

Measures only the central area (Spot metering). This function is useful when the subject is backlit or when there is strong contrast between the subject and the background.

Note

- [Multi] is selected when using the following functions:
 - [Intelligent Auto]
 - [Superior Auto]
 - [Scene Selection]
 - Zoom functions other than optical zoom

[53] How to Use | Using shooting functions | Adjusting the exposure

Exposure Set. Guide

You can set whether to display a guide when you change the exposure.

1. MENU →  (Custom Settings) → [Exposure Set. Guide] → desired setting.

Menu item details

Off:

Does not display the guide.



On (default setting):

Displays the guide.

[54] How to Use | Using shooting functions | Selecting a drive mode (Continuous shooting/Self-timer)

Drive Mode

You can set the drive mode, such as continuous or self-timer shooting.

1. MENU →  (Camera Settings) → [Drive Mode] → desired setting.
 - You can also set the drive mode by pressing  /  (Drive Mode) button of the control button.

Menu item details

Single Shooting (default setting):

Shoots one still image. Normal shooting mode.

Cont. Shooting:

Shoots images continuously while you press and hold down the shutter button.

 Self-timer:

Shoots an image after 10 or 2 seconds.

 Self-portrait:

When the product detects the number of faces you have selected, a beep will sound and the shooting starts after two seconds.

 Self-timer(Cont):

Shoots images continuously after 10 seconds.

 Cont. Bracket:

Shoots images while holding the shutter button down, each with different degrees of brightness.

 WB bracket:

Shoots a total of three images, each with a different degree of brightness according to the selected settings for white balance, color temperature and color filter.

[55] How to Use | Using shooting functions | Selecting a drive mode (Continuous

Cont. Shooting

Shoots 10 images while you press the shutter button.

1. MENU →  (Camera Settings) → [Drive Mode] → [Cont. Shooting].
2. Select the desired mode using the right/left side of the control button.

Menu Item Details



Continuous Shooting: Hi (default setting):

Continuous shooting speed is set at a maximum of about 10 images per second.



Continuous Shooting: Lo:

Continuous shooting speed is set at a maximum of about 2 images per second.

Self-timer

The product shoots an image using the self-timer with a 10-second or 2-second delay.

1. MENU →  (Camera Settings) → [Drive Mode] → [Self-timer].
2. Select the desired mode using the right/left button on the control button.

Menu item details



Self-timer: 10 Sec (default setting):

Sets the 10-second delay self-timer.

When you press the shutter button, the self-timer lamp flashes and beeps until the shutter operates. To cancel the self-timer, press the shutter button again.



Self-timer: 2 Sec:

Sets the 2-second delay self-timer. This reduces the camera-shake caused by pressing the shutter button.

Self-portrait

Point the lens at yourself and shoot self-portrait images.

1. MENU →  (Camera Settings) → [Drive Mode] → [Self-portrait].
2. Select the desired mode using the right/left button on the control button.
3. Direct the lens toward yourself.
When the product detects the faces of the specified number of persons, it starts shooting after a beep sounds.

Menu item details

 Self-portrait: One Person (default setting):

The product starts shooting when it detects one person's face.

 Self-portrait: Two People:

The product starts shooting when it detects two person's faces.

Self-timer(Cont)

Continuously shoots the number of images you have set after 10 seconds. You can choose the best shot from several shots taken.

1. MENU →  (Camera Settings) → [Drive Mode] → [Self-timer(Cont)].
2. Select the desired mode using the right/left button on the control button.

Menu item details

 **C3** Self-timer(Cont.): 10 Sec. 3 Img. (default setting):

Shoots three frames in succession 10 seconds after you press the shutter button.

When you press the shutter button, the self-timer lamp flashes, a beep sounds, and the shutter operates after 10 seconds.

 **C5** Self-timer(Cont.): 10 Sec. 5 Img.:

Shoots five frames in succession 10 seconds after you press the shutter button.

When you press the shutter button, the self-timer lamp flashes, a beep sounds, and the shutter

operates after 10 seconds.

[59] How to Use | Using shooting functions | Selecting a drive mode (Continuous shooting/Self-timer)

Cont. Bracket

Shoots multiple images while automatically shifting the exposure from base to darker and then to lighter. Press and hold down the shutter button until the bracket recording is completed.

You can select an image that suits your intention, after recording.

1. MENU →  (Camera Settings) → [Drive Mode] → [Cont. Bracket]
2. Select the desired mode using the right/left button on the control button.

Menu item details

 Cont. Bracket: 0.3EV 3 Image (default setting):

This setting shoots three images continuously with an exposure value shifted by plus or minus 0.3 EV.

 Cont. Bracket: 0.7EV 3 Image:

This setting shoots three images continuously with an exposure value shifted by plus or minus 0.7 EV.

 Cont. Bracket: 1.0EV 3 Image:

This setting shoots three images continuously with an exposure value shifted by plus or minus 1.0 EV.

Note

- The last shot is shown on the Auto Review.
- In [Manual Exposure], the exposure is shifted by adjusting the shutter speed.
- When you adjust the exposure, the exposure is shifted based on the compensated value.
- When the flash is used, the product performs flash bracket shooting, which shifts the amount of flash light even if [Cont. Bracket] is selected. Press the shutter button for each image.

[60] How to Use | Using shooting functions | Selecting a drive mode (Continuous shooting/Self-timer)

WB bracket

Shoots three images, each with different color tones according to the selected settings of white balance, color temperature and color filter.

1. MENU →  (Camera Settings) → [Drive Mode] → [WB bracket].

Note

- The last shot is shown on the Auto Review.

[61] How to Use | Using shooting functions | Selecting the ISO sensitivity

ISO

Sensitivity to light is expressed by the ISO number (recommended exposure index). The larger the number, the higher the sensitivity.

1. MENU →  (Camera Settings) → [ISO] → desired setting.

Menu item details

Multi Frame NR :

Combines continuous shots to create an image with less noise.

ISO AUTO (default setting):

Sets the ISO sensitivity automatically.

80 / 100 / 125 / 160 / 200 / 250 / 320 / 400 / 500 / 640 / 800 / 1000 / 1250 / 1600 / 2000 / 2500 / 3200:

You can reduce image blurring in dark locations or with moving subjects by increasing the ISO sensitivity (select a larger number).

Note

- [ISO AUTO] is selected when using the following functions:
 - [Intelligent Auto]
 - [Superior Auto]
 - [Scene Selection]
 - [iSweep Panorama]
- The higher the ISO value, the more noise will appear on the images.
- The [ISO AUTO] setting is not available for [Manual Exposure]. If you change the exposure mode to [Manual Exposure] while set to [ISO AUTO], the ISO value is switched to the lowest value. Set the ISO in accordance with the shooting conditions.

- When you use [Multi Frame NR], it takes some time for the product to perform the overlay processing of images.

Hint

- You can change the automatically set range of ISO sensitivity in the [ISO AUTO] setting. Select [ISO AUTO] and press the right of the control button, and set the desired values for [ISO AUTO Maximum] and [ISO AUTO Minimum]. The settings [ISO AUTO Maximum] and [ISO AUTO Minimum] are also applied when shooting in [ISO AUTO] mode under [Multi Frame NR].

[62] How to Use | Using shooting functions | Selecting the ISO sensitivity

Multi Frame NR

The product automatically shoots multiple images continuously, combines them, reduces the noise, and records them as one image. With multi frame noise reduction, you can select larger ISO numbers than the maximum ISO sensitivity. The image recorded is one combined image.

1. MENU →  (Camera Settings) → [ISO] → [Multi Frame NR].
2. Press the right button on the control button to display the setting screen, then select a desired value using the up/down button.

Note

- The flash, [D-Range Opt.], and [Auto HDR] cannot be used.
- You cannot set [Multi Frame NR] in [Picture Effect].

Hint

- You can change the automatically set range of ISO sensitivity in the [ISO AUTO] setting. Select [ISO AUTO] and press the right button, and set the desired values for [ISO AUTO Maximum] and [ISO AUTO Minimum]. The settings [ISO AUTO Maximum] and [ISO AUTO Minimum] are also applied when shooting in [ISO AUTO] mode under [Multi Frame NR].

[63] How to Use | Using shooting functions | Correcting the brightness or contrast

D-Range Opt. (DRO)

By dividing the image into small areas, the product analyzes the contrast of light and shadow

between the subject and the background, and creates an image with the optimal brightness and gradation.

1. MENU →  (Camera Settings) → [DRO/Auto HDR] → [D-Range Opt.].
2. Select the desired setting using the left/right button on the control button.

Menu item details

 D-Range Optimizer: Auto (default setting):
Corrects the brightness automatically.

 D-Range Optimizer: Lv1 — D-Range Optimizer: Lv5:
Optimizes the gradation of a recorded image for each divided area. Select the optimization level from Lv1 (weak) to Lv5 (strong).

Note

- [DRO/Auto HDR] is fixed to [Off] when the shooting mode is set to [iSweep Panorama], or when [Multi Frame NR] or [Picture Effect] is used.
- [DRO/Auto HDR] is fixed to [Off] when [Night Scene], [Night Portrait], [Hand-held Twilight], [Anti Motion Blur], or [Fireworks] is selected in [Scene Selection]. The setting is fixed to [D-Range Optimizer: Auto] when other modes are selected in [Scene Selection].
- When shooting with [D-Range Opt.], the image may be noisy. Select the proper level by checking the recorded image, especially when you enhance the effect.

[64] How to Use | Using shooting functions | Correcting the brightness or contrast

Auto HDR

Widens the range (gradation) so that you can record from bright parts to dark parts with correct brightness (HDR: High Dynamic Range). One image with proper exposure and one overlaid image are recorded.

1. MENU →  (Camera Settings) → [DRO/Auto HDR] → [Auto HDR].
2. Select the desired setting using the left/right button on the control button.

Menu item details

 Auto HDR: Exposure Diff. Auto (default setting):
Corrects the exposure difference automatically.

 Auto HDR: Exposure Diff. 1.0EV — Auto HDR: Exposure Diff. 6.0EV:

Sets the exposure difference, based on the contrast of the subject. Select the optimal level between 1.0 EV (weak) and 6.0 EV (strong).

For example, if you set the exposure value to 2.0 EV, three images will be composed with the following exposure levels; -1.0 EV, optimal exposure and +1.0 EV.

Note

- When the shooting mode is set to [Intelligent Auto], [Superior Auto], [iSweep Panorama] or [Scene Selection], you cannot select [Auto HDR].
- When [Multi Frame NR] is selected, you cannot select [Auto HDR].
- You cannot start the next shot until the capture process is completed after you shoot.
- You may not obtain the desired effect depending on the luminance difference of a subject and the shooting conditions.
- When the flash is used, this function has little effect.
- When the contrast of the scene is low or when product shake or subject blur occurs, you may not obtain good HDR images. If the product has detected a problem, **HDR**  is displayed on the recorded image to inform you of this situation. Shoot again as necessary, paying attention to the contrast or blur.

[65] How to Use | Using shooting functions | Adjusting color tones

White Balance

Adjusts the color tones according to the ambient light conditions. Use this feature when the color tones of the image did not come out as you expected, or when you want to change the color tones on purpose for photographic expression.

1. MENU →  (Camera Settings) → [White Balance] → desired setting.

Menu item details

AWB Auto (default setting):

The product automatically detects the light source and adjusts the color tones.

 Daylight:

The color tones are adjusted for the daylight.

 Cloudy:

The color temperature is adjusted for a cloudy sky.

 Incandescent:

The color temperature is adjusted for places under an incandescent lamp, or under bright lighting, such as in a photo studio.

 Fluor.: Cool White:

The color temperature is adjusted for white fluorescent lighting.

 Fluor.: Day White:

The color temperature is adjusted for neutral white fluorescent lighting.

 Fluor.: Daylight:

The color temperature is adjusted for daylight fluorescent lighting.

 Flash:

The color temperature is adjusted for flash light.

 C.Temp./Filter:

Adjusts the color tones depending on the light source. Achieves the effect of CC (Color Compensation) filters for photography.

 Custom:

Uses the white balance setting saved in [Custom Setup].

 SET Custom Setup:

Memorizes the basic white color under the light conditions for the shooting environment.

Hint

- You can use the right button on the control button to display the fine adjustment screen and perform fine adjustments of the color temperature as required.
- In [C.Temp./Filter], you can use the right button to display the color temperature setting screen and perform a setting. When you press the right button again, the fine adjustment screen appears to allow you perform fine adjustments as required.

Note

- [White Balance] is fixed to [Auto] in the following situations:
 - [Intelligent Auto]
 - [Superior Auto]
 - [Scene Selection]

[66] How to Use | Using shooting functions | Adjusting color tones

Capturing a basic white color in [Custom Setup] mode

In a scene where the ambient light consists of multiple types of light sources, it is recommended to use the custom white balance in order to accurately reproduce the whiteness.

1. MENU →  (Camera Settings) → [White Balance] → [Custom Setup].
2. Hold the product so that the white area fully covers the AF area located in the center, and

then press  on the center of the control button.

The calibrated values (Color Temperature and Color Filter) are displayed and registered.

Note

- The message [Custom WB Error] indicates that the value is higher than the expected range, when the flash is used on a subject with too bright colors in the frame. If you register this value, the  indicator turns yellow on the recording information display. You can shoot at this point, but it is recommended that you set the white balance again to get a more accurate white balance value.

[67] How to Use | Using shooting functions | Selecting an effect mode

Picture Effect

Select the desired effect filter to achieve more impressive and artistic images.

1. MENU →  (Camera Settings) → [Picture Effect] → desired setting.

Menu item details

 Off (default setting):

Disables the [Picture Effect] function.

 Toy Camera:

Creates a soft image with shaded corners and reduced sharpness.

 Pop Color:

Creates a vivid look by emphasizing color tones.

 Posterization:

Creates a high contrast, abstract look by heavily emphasizing primary colors, or in black and white.

 Retro Photo:

Creates the look of an aged photo with sepia color tones and faded contrast.

 Soft High-key:

Creates an image with the indicated atmosphere: bright, transparent, ethereal, tender, soft.

 Partial Color:

Creates an image which retains a specific color, but converts others to black and white.

 High Contrast Mono.:

Creates a high-contrast image in black and white.

 Soft Focus:

Creates an image filled with a soft lighting effect.

 HDR Painting:

Creates the look of a painting, enhancing the colors and details.

 Rich-tone Mono.:

Creates an image in black and white with rich gradation and reproduction of details.

 Miniature:

Creates an image which enhances the subject vividly, with the background defocused considerably. This effect may often be found in pictures of miniature models.

 Watercolor:

Creates an image with ink bleed and blurring effects as if painted using watercolors.

 Illustration:

Creates an illustration-like image by emphasizing the outlines.

Hint

- You can perform detailed settings for the following [Picture Effect] modes using the left/right button on the control button.

[Toy Camera]

[Posterization]

[Partial Color]

[Soft Focus]

[HDR Painting]

[Miniature]

[Illustration]

Note

- When [Partial Color] is selected, images may not retain the selected color, depending on the subject or shooting conditions.
- You cannot check the following effects on the shooting screen, because the product processes the image after the shot. Also, you cannot shoot another image until image processing is finished. You cannot use these effects with movies.

[Soft Focus]

[HDR Painting]

[Rich-tone Mono.]

[Miniature]



[Watercolor]

[Illustration]

- In the case of [HDR Painting] and [Rich-tone Mono.], the shutter is released three times for one shot. Be careful about the following:

Use this function when the subject is motionless or does not flash light.

Do not change the composition before shooting.

When the contrast of the scene is low or when significant camera-shake or subject blur has occurred, you may not be able to obtain good HDR images. If the product detects such a situation,  /  appear on the recorded image to inform you of this situation. If necessary, change the composition or otherwise adjust the settings, be careful of blurring, and shoot again.

[68] How to Use | Using shooting functions | Selecting an effect mode

Creative Style

Allows you to select the desired image processing. You can adjust exposure (shutter speed and aperture) as you like with [Creative Style], unlike with [Scene Selection] where the product adjusts the exposure.

1. MENU →  (Camera Settings) → [Creative Style] → desired setting.

Menu item details

 Standard (default setting):

For shooting various scenes with rich gradation and beautiful colors.

 Vivid:

The saturation and contrast are heightened for shooting striking images of colorful scenes and subjects such as flowers, spring greenery, blue sky, or ocean views.

 Portrait:

For shooting the skin color in a soft tone, ideally suited for shooting portraits.

 Landscape:

The saturation, contrast, and sharpness are heightened for shooting vivid and crisp scenery. Distant landscapes also stand out more.

 Sunset:

For shooting the beautiful red of the setting sun.

 Black & White:

For shooting images in black and white monotone.

 Sepia:

For shooting images in sepia monotone.

To set [Contrast], [Saturation] and [Sharpness]

[Contrast], [Saturation] and [Sharpness] can be adjusted for each [Creative Style] item.

Select an item to be set by pressing the right/left button on the control button, then set the value using the top/bottom button on the control button.

 Contrast:

The higher the value selected, the more the difference of light and shadow is accentuated, and the bigger the effect on the image.

 Saturation:

The higher the value selected, the more vivid the color. When a lower value is selected, the color of the image is restrained and subdued.

 Sharpness:

Adjusts the sharpness. The higher the value selected, the more the contours are accentuated, and the lower the value selected, the more the contours are softened.



Note

- [Standard] is selected when using the following functions:
 - [Intelligent Auto]
 - [Superior Auto]
 - [Scene Selection]
 - [Picture Effect]
- When [Creative Style] is set to [Black & White] or [Sepia], [Saturation] cannot be adjusted.

[69] How to Use | Using shooting functions | Recording movies

File Format (movie)

Selects the movie file format.

1. MENU →  (Camera Settings) → [ File Format] → desired setting.

Menu item details

AVCHD (default setting):

Records high-definition movies. This file format is suitable for viewing movies on a high-definition TV.

You can create a Blu-ray Disc, an AVCHD recording disc, or a DVD-Video disc using the software PlayMemories Home.



MP4:

Records mp4 (AVC) movies. This format is suitable for WEB uploads, e-mail attachments, etc.

You cannot create a disc using the software PlayMemories Home with a movie that was recorded when [ File Format] was set to [MP4].

Record Setting (movie)

Selects the image size, frame rate, and image quality for movie recording. The higher the bit-rate, the higher the image quality.

1. MENU →  (Camera Settings) → [ Record Setting] → desired setting.

When [ File Format] is set to [AVCHD]

60i/50i: Movies are recorded at approximately 60 fields/sec (for 1080 60i-compatible devices) or 50 fields/sec (for 1080 50i-compatible devices), in interlaced mode, with Dolby Digital audio, in AVCHD format.

24p/25p: Movies are recorded at approximately 24 frames/sec (for 1080 60i-compatible devices) or 25 frames/sec (for 1080 50i-compatible devices), in progressive mode, with Dolby Digital audio, in AVCHD format.

60p/50p: Movies are recorded at approximately 60 frames/sec (for 1080 60i-compatible devices) or 50 frames/sec (for 1080 50i-compatible devices), in progressive mode, with Dolby Digital audio, in AVCHD format.

When [ File Format] is set to [MP4]

Movies shot are recorded in MPEG-4 format, at approximately 30 frames/sec (for 1080 60i-compatible devices) or approximately 25 frames/sec (for 1080 50i-compatible devices), in progressive mode, with AAC audio, mp4 format.

Menu items details

When [ File Format] is set to [AVCHD]

60i 24M(FX)*:

50i 24M(FX)**:

Records high image quality movies of 1920 × 1080 (60i/50i).

Bit-rate: Maximum 24 Mbps

60i 17M(FH) (default setting)*:

50i 17M(FH) (default setting)**:

Records standard image quality movies of 1920 × 1080 (60i/50i).

Bit-rate: Average 17 Mbps

60p 28M(PS)*:

50p 28M(PS)**:

Records the highest image quality movies of 1920 × 1080 (60p/50p).

Bit-rate: Maximum 28 Mbps

24p 24M(FX)*:

25p 24M(FX)**:

Records high image quality movies of 1920 × 1080 (24p/25p). This produces a cinema-like atmosphere.

Bit-rate: Maximum 24 Mbps

24p 17M(FH)*:

25p 17M(FH)**:

Records standard image quality movies of 1920× 1080 (24p/25p). This produces a cinema-like atmosphere.

Bit-rate: Average 17 Mbps

[ File Format]: [MP4]

1440×1080 12M (default setting):

Records movies of 1440 × 1080.

Bit-rate: Average 12 Mbps

VGA 3M:

Records movies of VGA size.

Bit-rate: Average 3 Mbps

* 1080 60i (NTSC) compatible device

** 1080 50i (PAL) compatible device



Note

- 60p/50p movies can be played back only on compatible devices.
- Movies recorded with the [60p 28M(PS)]/[50p 28M(PS)]/[60i 24M(FX)]/[50i 24M(FX)]/[24p 24M(FX)]/[25p 24M(FX)] setting in [ Record Setting] are converted by PlayMemories Home in order to create an AVCHD recording disc. This conversion can take a long time. Also, you cannot create a disc in the original image quality. If you want to keep the original image quality, store your movies on a Blu-ray Disc.
- To play back 24p/25p movies on a TV, the TV must be compatible with the 24p/25p formats. If the TV is not compatible with the 24p/25p format, 24p/25p movies will be output as 60i/50i movies.

[71] How to Use | Using shooting functions | Recording movies

SteadyShot (movie)

Sets [SteadyShot] effect when shooting movies.

1. MENU →  (Camera Settings) → [ SteadyShot] → desired setting.

Menu item details

Intelligent Active (default setting):

Provides the most powerful SteadyShot effect.

Active:

Provides a more powerful SteadyShot effect.

Standard:

Reduces camera shake under stable movie shooting conditions.

Note

- If you change the setting for [ SteadyShot], the angle of view will change.

[72] How to Use | Using shooting functions | Recording movies

Micref Level

You can select the microphone level for movie recording.

1. MENU →  (Camera Settings) → [Micref Level] → desired setting.

Menu item details

Normal (default setting):

Records the ambient sounds within a certain level. This setting is suitable for recording everyday conversations.

Low:

Records the ambient sounds faithfully. This setting is suitable for recording realistic sounds, for example at a concert.

[73] How to Use | Using shooting functions | Recording movies

Wind Noise Reduct.

Sets whether or not to reduce wind noise during movie recording.

1. MENU →  (Camera Settings) → [Wind Noise Reduct.] → desired setting.

Menu item details

On:

Reduces wind noise.

Off (default setting):

Does not reduce wind noise.



Note

- Setting this item to [On] where wind is not blowing sufficiently hard may cause normal sound to be recorded with too low volume.

[74] How to Use | Using shooting functions | Recording movies

Auto Slow Shut. (movie)

Sets whether or not to adjust the shutter speed automatically when recording movies if the subject is dark.

1. MENU →  (Camera Settings) → [ Auto Slow Shut.] → desired setting.

Menu item details

On (default setting):

Uses [ Auto Slow Shut.]. The shutter speed automatically slows when recording in dark locations. You can reduce noise in the movie by using a slow shutter speed when recording in dark locations.

Off:

Does not use [ Auto Slow Shut.]. The recorded movie will be darker than when [On] is selected, but you can record movies with smoother motion and less object blur.

Note

- [ Auto Slow Shut.] does not function in the following situations:
 - When [Movie] in shooting mode is set to [Shutter Priority] or [Manual Exposure].
 - When [ISO] is set to other than [ISO AUTO].

[75] How to Use | Using shooting functions | Recording movies

MOVIE Button

Sets whether or not to activate the MOVIE button.

1. MENU →  (Custom Settings) → [MOVIE Button] → desired setting.

Menu item details

Always (default setting):

Starts movie recording when you press the MOVIE button in any mode.

Movie Mode Only:

Starts movie recording when you press the MOVIE button only if the shooting mode is set to [Movie] mode.

[76] How to Use | Using shooting functions | Customizing the shooting functions for convenient use

Memory

Allows you to register up to 2 often-used modes or product settings in the product. You can recall the settings using just the mode dial.

1. Set the product to the setting you want to register.
2. MENU →  (Camera Settings) → [Memory] → desired number.

Items that can be registered

- Shooting mode
- Aperture (F number)
- Shutter speed
-  Camera Settings
- Optical zoom scale

To recall registered settings

Select the memory number from “1” or “2” on the mode dial.

To change registered settings

Change the setting to the desired one and re-register the setting to the same mode number.

Note

- Program Shift cannot be registered.
-

Function Menu Set.

You can assign the functions to be called up when you press the Fn (Function) button.

1. MENU →  (Custom Settings) → [Function Menu Set.] → set a function to the desired location.

The functions that can be assigned are displayed on the setup item selection screen.

Custom Key Settings

Assigning functions to the various keys allows you to speed up operations by pressing the appropriate key when the shooting information screen is displayed.

1. MENU →  (Custom Settings) → [Custom Key Settings] → set a function to the desired key.

Note

- Some functions cannot be assigned to certain keys.
-

Function of the Custom key



Once you assign a function to the Custom key, you can perform that function by simply pressing the Custom key when the shooting information screen is displayed.



1. MENU →  (Custom Settings) → [Custom Key Settings] → [Custom Button] → desired setting.

The functions that can be assigned are displayed on the setup item selection screen.

[80] How to Use | Using shooting functions | Setting the other functions of this product

Photo Creativity

[Photo Creativity] is a mode that allows you to operate the camera intuitively with a different screen display. When the shooting mode is set to  (Intelligent Auto) or  (Superior Auto), you can change the settings easily and shoot images.







1. Set the shooting mode to  (Intelligent Auto) or  (Superior Auto).
2. Press  (Photo Creativity) on the control button.
3. Select the item to be changed using the control button.

 (Brightness):
Adjusts brightness.

 (Color):
Adjusts color.

 (Vividness):
Adjusts vividness.

 (Picture Effect):
You can select a desired effect and shoot images with the specific texture.

4. Select the desired settings.
 - You can use some settings together by repeating steps 3 and 4.
 - To reset the changed settings to the default settings, press the  (Delete) button.  (Brightness),  (Color) and  (Vividness) are set to [AUTO], and  (Picture Effect) is set to .
5. For shooting still images: Press the shutter button.
When recording movies: Press the MOVIE button to start recording.

Note

- When you record movies using the [Photo Creativity] function, you cannot change any settings during the recording.
- If you switch the shooting mode to [Intelligent Auto] mode or [Superior Auto] mode, or turn off the product, the settings you have changed revert to the default settings.

- When the shooting mode is set to [Superior Auto], and you use [Photo Creativity], the product does not perform the overlay processing of images.

[81] How to Use | Using shooting functions | Setting the other functions of this product

Smile/Face Detect.

Detects the faces of your subjects and adjusts the focus, exposure, flash settings and performs image processing automatically.

1. MENU →  (Camera Settings) → [Smile/Face Detect.] → desired setting.

Menu item details

 Off:

Does not use the [Face Detection] function.

 On (default setting):

Automatically selects a face to be brought into focus.

 Smile Shutter:

Automatically detects and shoots a smile.

Face Detection frame

- When the product detects a face, the gray face detection frame appears. When the product determines that autofocus is enabled, the face detection frame turns white. When you press the shutter button halfway down, the frame turns green.



Tips for capturing smiles more effectively

- Do not cover the eyes with front hair and keep the eyes narrowed.
- Do not obscure the face by a hat, masks, sunglasses, etc.
- Try to orient the face in front of the product and be as level as possible.
- Give a clear smile with an open mouth. The smile is easier to be detected when the teeth are shown.
- If you press the shutter button during Smile Shutter, the product shoots the image. After

shooting, the product returns to Smile Shutter mode.

Hint

- When the [Smile/Face Detect.] is set to [Smile Shutter], you can select the Smile Detection Sensitivity from [On: Slight Smile], [On: Normal Smile] and [On: Big Smile].



Note

- You cannot use [Face Detection] with the following functions:
 - When using zoom functions other than the optical zoom
- Up to eight faces of your subjects can be detected.
- The product may not detect faces at all or may accidentally detect other objects as faces in some conditions.
- If the product cannot detect a face, set the Smile Detection Sensitivity.
- If you track a face using [Lock-on AF] while executing [Smile Shutter], Smile Detection is performed only for that face.

[82] How to Use | Using shooting functions | Setting the other functions of this product

Soft Skin Effect (still image)

Sets the effect used for shooting the skin smoothly in the [Face Detection] function.

1. MENU →  (Camera Settings) → [ Soft Skin Effect] → desired setting.

Menu item details

 Off (default setting):

Does not use the [ Soft Skin Effect] function.

 On:

Uses the [ Soft Skin Effect].

Hint

- When [ Soft Skin Effect] is set to [On], you can select the effect level.

[83] How to Use | Using shooting functions | Setting the other functions of this product

Red Eye Reduction

When using the flash, it is fired two or more times before shooting to reduce the red-eye

phenomenon.

1. MENU →  (Camera Settings) → [Red Eye Reduction] → desired setting.

Menu item details

On:

The flash is always fired to reduce the red-eye phenomenon.

Off (default setting):

Does not use Red Eye Reduction.

Note



- Red Eye Reduction may not produce the desired effects. It depends on individual differences and conditions, such as distance to the subject, or whether the subject looks at the pre-strobe or not.

[84] How to Use | Using shooting functions | Setting the other functions of this product

Auto Obj. Framing (still image)

When this product detects and shoots faces, macro shooting subjects or subjects that are tracked by [Lock-on AF], the product automatically trims the image into an appropriate composition, and then saves it. Both the original and the trimmed images are saved. The trimmed image is recorded in the same size as the original image size.



1. MENU →  (Camera Settings) → [ Auto Obj. Framing] → desired setting.
 - If trimming is enabled when Live View Display mode is used,  will be displayed.
 - After the shot, a frame showing the trimmed area is displayed on the Auto Review screen.

Menu item details

Off (default setting):

Does not trim images.

Auto:

Automatically trims images into an appropriate composition.



Note

- The trimmed image may not be the best possible composition, depending on the shooting conditions.

[85] How to Use | Using shooting functions | Setting the other functions of this product

High ISO NR (still image)

When shooting with high ISO sensitivity, the product reduces noise that becomes more noticeable when the product sensitivity is high. A message may be displayed during noise reduction processing; you cannot shoot another image until the message disappears.

1. MENU →  (Camera Settings) → [ High ISO NR] → desired setting.

Menu item details

Normal (default setting):

Activates high ISO noise reduction normally.



Low:

Activates high ISO noise reduction moderately. Select this to prioritize the timing of shooting.

[86] How to Use | Using shooting functions | Setting the other functions of this product

Write Date (still image)

Sets whether to record a shooting date on the still image.

1. MENU →  (Custom Settings) → [ Write Date] → desired setting.

Menu item details

On:

Records a shooting date.

When [On] is selected, the **DATE** mark will appear on the screen while shooting. However, in some shooting modes that cannot record dates on images, the **DATE** mark will disappear.

Off (default setting):

Does not record a shooting date.

Note

- If you shoot images with the date once, you cannot delete the date from the images later.
- The dates are doubly printed if you set the product to print dates when printing the images.
- The recorded time of the image cannot be superimposed on the image.

[87] How to Use | Using shooting functions | Setting the other functions of this product

Grid Line

Sets whether the grid line is displayed or not. The grid line will help you to adjust the composition of images.

1. MENU →  (Custom Settings) → [Grid Line] → desired setting.

Menu item details

Off (default setting):

Does not display the grid line.

On:

Displays the grid line.

[88] How to Use | Using shooting functions | Setting the other functions of this product

Auto Review

You can check the recorded image on the screen right after the shooting. You can also set the display time for Auto Review.

1. MENU →  (Custom Settings) → [Auto Review] → desired setting.

Menu item details

10 Sec/5 Sec/2 Sec (default setting):

Displays the recorded image on the screen right after shooting for the selected duration of time. If you perform a magnifying operation during Auto Review, you can check that image using the magnified scale.

Off:

Does not display the Auto Review.

Note

- When the product is enlarging an image using image processing, it may temporarily display the original image prior to enlarging and then display the enlarged image.
- The DISP (Display Setting) settings are applied for the Auto Review display.

[89] How to Use | Using shooting functions | Setting the other functions of this product

FINDER/MONITOR

Sets the method for switching the display between Electronic Viewfinder and the screen.

1. MENU →  (Custom Settings) → [FINDER/MONITOR] → desired setting.

Menu item details

Auto (default setting):

When you look into the Electronic Viewfinder, the display is switched to the Electronic Viewfinder automatically.

Manual:

The product does not switch between the monitor display and the Electronic Viewfinder display automatically.

You can switch the display by pressing the FINDER/MONITOR button.

Hint

- If you want to switch the display mode temporarily when the [FINDER/MONITOR] setting is [Auto], press the FINDER/MONITOR button.

[90] How to Use | Viewing | Viewing still images

Playing back images

Plays back the recorded images.

1. Press the  (Playback) button to switch to the playback mode.

2. Select the image with the control button.

Hint

- The product creates an image database file on a memory card to record and play back images. An image that is not registered in the image database file may not be played back correctly. To play back images shot using other devices, register those images to the image database file using MENU → [Setup] → [Recover Image DB].

[91] How to Use | Viewing | Viewing still images

Playback zoom

Enlarges the image being played back.

1. Display the image you want to enlarge, and slide the W/T (zoom) lever to the T side.
 - If the image is too large, slide the W/T (zoom) lever to the W side to adjust the zoom scale.
2. Select the portion you want to enlarge by pressing the top/bottom/right/left button on the control button.

Hint

- You can also enlarge an image being played back using MENU.

Note

- You cannot use the enlarged playback function with movies.

[92] How to Use | Viewing | Viewing still images

Image Index

You can display multiple images at the same time in playback mode.

1. Slide the W/T (zoom) lever to the W side while the image is being played back.
To change the number of images to be displayed
MENU →  (Playback) → [Image Index] → desired setting.

Menu item details

9 Images (default setting)/25 Images

To return to single-image playback

Select the desired image and press ● on the center of the control button.

Displaying a desired image quickly

Select the bar on the left of the image index screen using the control button, then press the top/bottom button on the control button. When the bar is being selected, you can display the calendar screen or folder selection screen by pressing ● in the center. In addition, you can switch View Mode by selecting an icon.

[93] How to Use | Viewing | Viewing still images

Switching the screen display (during playback)

Switches the screen display.

1. Press the DISP (Display Setting) button.
 - The screen display switches in the order “Display Info. → Histogram → No Disp. Info. → Display Info.” each time you press the DISP button.
 - The DISP (Display Setting) settings are applied for the Auto Review display.



Note

- The histogram is not displayed in the following situations:
 - During movie playback
 - During scrolling playback of panoramic images
 - During slideshows
 - During Folder View (MP4)
 - During AVCHD View

[94] How to Use | Viewing | Deleting images

Deleting a displayed image

You can delete an image displayed.

1. Display the image you want to delete.
2. Press the  (Delete) button.
3. Select [Delete] using the control button, then press  on the center of the control button.

[95] How to Use | Viewing | Deleting images

Deleting multiple selected images





You can delete multiple selected images.

1. MENU →  (Playback) → [Delete] → desired setting.

Menu item details

Multiple Img.:

Deletes the selected images.

(1) Select the images to be deleted, then press  on the center of the control button. The  mark is displayed in the check box. To cancel the selection, press  again to remove the  mark.

(2) To delete other images, repeat step (1).

(3) MENU → [OK] → Press  on the center.

All in this Folder:

Deletes all images in the selected folder.

All with this date:

Deletes all images in the selected date range.

[96] How to Use | Viewing | Playing back movies

Playing back movies













Plays back the recorded movies.

1. Press the  (playback) button to switch to playback mode.

2. Select the movie to be played back using the control button.
3. To play back movies, press  on the center.

Available operations during movie playback

You can perform slow playback and sound volume adjustment, etc. by pressing the bottom button on the control button.

-  : Playback
-  : Pause
-  : Fast-forward
-  : Fast-rewind
-  : Forward slow playback
-  : Reverse slow playback
-  : Next movie file
-  : Previous movie file
-  : Displays the next frame
-  : Displays the previous frame
-  : Motion Shot Video (Shows the tracking of a subject in motion.)
-  : Sound volume adjustment
-  : Closes the operation panel



Hint

- “Forward slow playback,” “Reverse slow playback,” “Displays the next frame” and “Displays the previous frame” are available during pause.

[97] How to Use | Viewing | Playing back movies

Motion Shot Video

You can see the tracking of the subject's motion in high-speed, like a stroboscopic image.

1. Press the bottom side of the control wheel during movie playback, then select  .
 - To exit [Motion Shot Video] playback, select  .
 - If you fail to make the trail, you can adjust the interval of the image tracking using  .

Note

- You cannot save the images made with [Motion Shot Video] as a movie file.
- If the motion of the subject is too slow or the subject does not move enough, the product

may fail to create the image.



Hint

- You can also change the interval of the image tracking using MENU →  (Playback) → [Motion Interval ADJ].

[98] How to Use | Viewing | Viewing panoramic images

Playing back panoramic images

The product automatically scrolls a panoramic image from end to end.

1. Press the  (playback) button to switch to playback mode.
2. Select the panoramic image to be played back using the control button.
3. Press  on the center to play back the image.

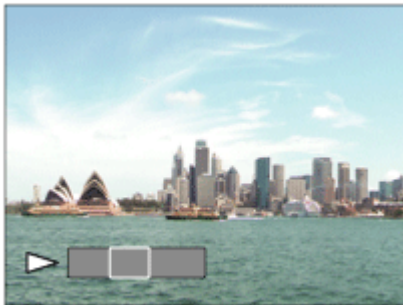

- To pause playback, press  on the center again.
- To return to the display of the entire image, press the MENU key.

Note

- Panoramic images shot using other product may be displayed in a different size from the actual size, or may not scroll correctly.

[99] How to Use | Viewing | Printing

Specify Printing

You can specify in advance on the memory card which still images you want to print out later. The **DPOF** (print order) icon will appear on the specified images. DPOF refers to “Digital Print





Order Format.”

1. MENU →  (Playback) → [Specify Printing] → desired setting.

Menu item details

Multiple Img.:

Selects images to order printing.

(1) Select an image and press  on the center of the control button. A  mark is displayed in the check box. To cancel the selection, press  and delete the  mark.

(2) Repeat step 1 to print other images.

(3) MENU → [OK] →  on the center.

Cancel All:

Clears all DPOF marks.

Print Setting:

You can set whether to print the date on images registered with DPOF marks.

(1) Select [On] or [Off] → [Enter] in [Date Imprint].

Note

- You cannot add the DPOF mark to the following files:

Movies

[100] How to Use | Viewing | Using viewing functions

View Mode

Sets the View Mode (image display method).

1. MENU →  (Playback) → [View Mode] → desired setting.

Menu item details

 Date View:

Displays the images by date.

 Folder View(Still):

Displays only still images.

 Folder View(MP4):

Displays only MP4-format movies.

 AVCHD View:

Displays only AVCHD-format movies.

Slide Show

Automatically plays back images continuously.

1. MENU →  (Playback) → [Slide Show] → desired setting.
2. Select [Enter].

Menu item details

Repeat:

Select [On], in which images are played back in a continuous loop, or [Off] (default setting), in which the product exits the slideshow when all the images are played back once.

Interval:

Select the display interval for images from among [1 Sec], [3 Sec] (default setting), [5 Sec], [10 Sec] or [30 Sec].

To quit the slideshow in the middle of playback



- Press the MENU key to quit the slideshow. You cannot pause the slideshow.

Hint

- You can activate a slideshow only when [View Mode] is set to [Date View] or [Folder View(Still)].

Rotate

Rotates a recorded still image counter-clockwise.

1. MENU →  (Playback) → [Rotate].
2. Press  on the center of the control button.
The image is rotated counter-clockwise. The image rotates as you press  on the center.
If you rotate the image once, the image remains rotated even after the product is turned off.

Note

- You cannot rotate the movies.
- You may not be able to rotate images shot using other products.
- When viewing rotated images on a computer, the images may be displayed in their original orientation depending on the software.

[103] How to Use | Viewing | Using viewing functions

Protect





Protects recorded images against accidental erasure. The  mark is displayed on protected images.

1. MENU →  (Playback) → [Protect] → desired setting.

Menu item details

Multiple Img.:

Applies or cancels the protection of the selected multiple images.

- (1) Select the image to be protected, then press  on the center of the control button. The  mark is displayed in the check box. To cancel the selection, press  again to remove the  mark.
- (2) To protect other images, repeat step (1).
- (3) MENU → [OK] → Press  on the center.

All in this Folder:

Protects all still images in the selected folder.

All with this date:

Protects all still images in the selected date range.

Cancel All in this Folder:

Cancels the protection of all still images in the selected folder.

Cancel All with this date:

Cancels the protection of all still images in the selected date range.

[104] How to Use | Viewing | Using viewing functions

4K Still Image PB

Outputs still images in 4K resolution to an HDMI-connected TV that supports 4K.

1. Turn off this product and the TV.
2. Connect the HDMI micro terminal of this product to the HDMI jack of the TV using an HDMI cable (sold separately).

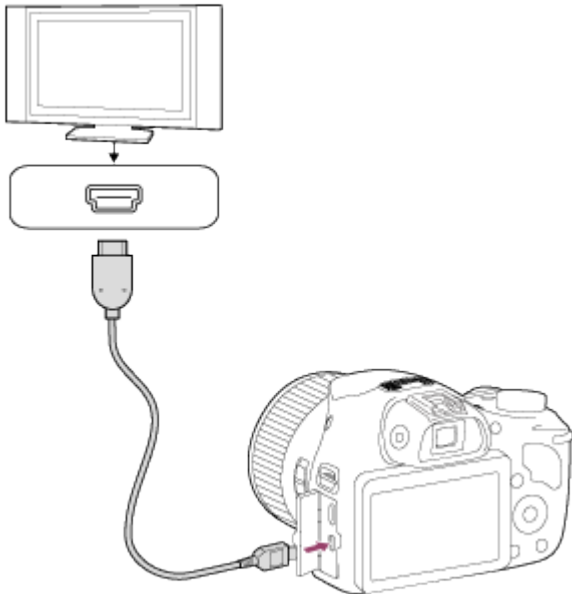

3. Turn on the TV and switch the input.
4. Turn on this product.
5. MENU →  (Playback) → [4K Still Image PB] → [OK].

Note

- This menu is only available with 4K-compatible TVs. For details, refer to the operating instructions of the TV.

[105] How to Use | Viewing | Viewing images on a TV

Viewing images on an HD TV

To view images stored on this product using a TV, an HDMI cable (sold separately) and an HD TV equipped with an HDMI jack are required.

1. Turn off both this product and the TV.
2. Connect the HDMI micro terminal of this product to the HDMI jack of the TV using an HDMI cable (sold separately).

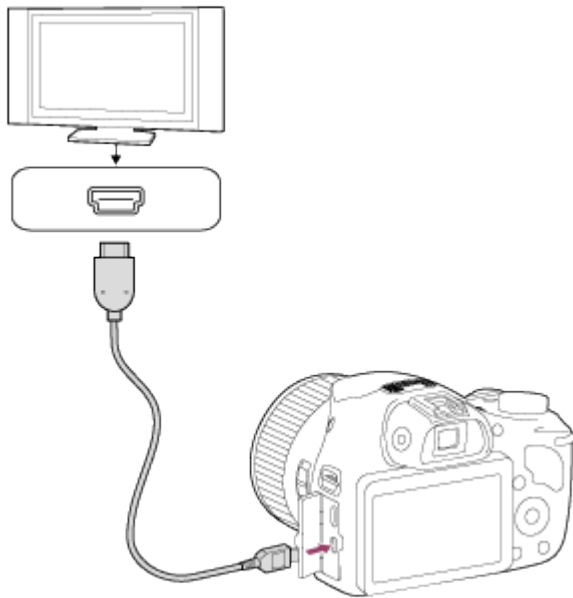

3. Turn on the TV and switch the input.
4. Turn on this product.
Images shot with the product appear on the TV screen.

Hint

- This product is compatible with the PhotoTV HD standard. If you connect Sony PhotoTV HD-compatible devices using an HDMI cable (sold separately), the TV is set to the image quality suitable for viewing still images, and a whole new world of photos can be enjoyed in breathtaking high quality.
- The PhotoTV HD allows for a highly-detailed, photo-like expression of subtle textures and colors.
- For details, refer to the operating instructions supplied with the compatible TV.

Note

- Do not connect this product and another device using the output terminals of both. Doing so may cause a malfunction.
- Some devices may not work properly when connected to this product. For example, they may not output video or audio.
- Use an HDMI cable with the HDMI logo or a genuine Sony cable.
- Use an HDMI cable that is compatible with the HDMI micro terminal of the product and the HDMI jack of the TV.

By connecting this product to a TV that supports “BRAVIA” Sync using an HDMI cable (sold separately), you can operate this product with the TV Remote Control.

1. Turn off both this product and the TV.
2. Connect the HDMI micro terminal of the product to the HDMI jack of the TV using an HDMI cable (sold separately).

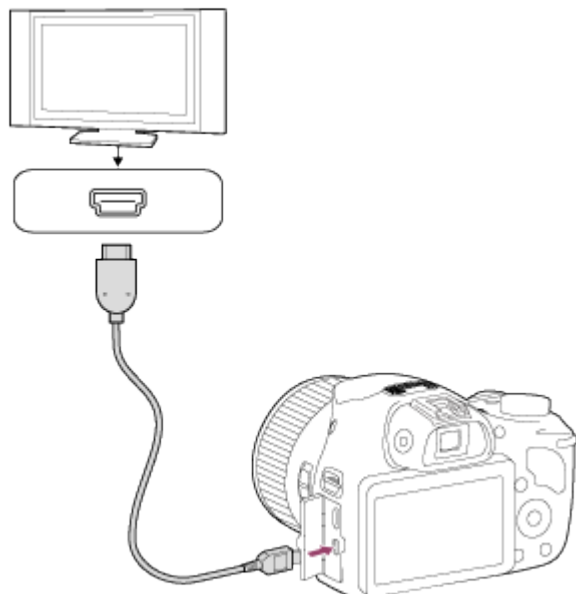

3. Turn on the TV and switch the input.
4. Turn on this product.
5. MENU →  (Setup) → [CTRL FOR HDMI] → [On].
6. Press the SYNC MENU button on the TV Remote Control, and select the desired mode.

Note

- Only TVs that support “BRAVIA” Sync can provide SYNC MENU operations. For details, refer to the operating instructions supplied with the TV.
- If the product performs unwanted operations in response to the TV Remote Control when the product is connected to another manufacturer’s TV using an HDMI connection, select MENU →  (Setup) → [CTRL FOR HDMI] → [Off].

[107] How to Use | Changing settings | Setup menu

Monitor Brightness

You can adjust the brightness of the screen.

1. MENU →  (Setup) → [Monitor Brightness] → desired setting.

Menu item details

Manual:

Adjusts the brightness within the range of -2 to +2.

[108] How to Use | Changing settings | Setup menu

Volume Settings

Adjusts the sound volume.

1. MENU →  (Setup) → [Volume Settings] → desired setting.

Adjusting the volume during playback

Press the bottom of the control button while playing back movies to display the operation panel, then adjust the volume. You can adjust the volume while listening to the actual sound.

[109] How to Use | Changing settings | Setup menu

Audio signals

Selects whether the product produces a sound or not.

1. MENU →  (Setup) → [Audio signals] → desired setting.

Menu item details

On (default setting):

Produces sound when the focus is achieved or the self-timer is operated.

Shutter:

Produces the shutter sound only.

Off:

Does not produce sound.

GPS On/Off (DSC-HX400V)

You can record the location information with the images when the built-in GPS sensor of this product can acquire the location information. Using the supplied software PlayMemories Home, you can import the images recorded with the location information to a computer and enjoy viewing them on a map which shows their shooting location. Refer to the Help of PlayMemories Home for details.

1. MENU →  (Setup) → [GPS Settings] → [GPS On/Off] → desired setting.

Menu item details

On:

The GPS function is activated.

Off (default setting):

The GPS function is turned off.

The status icon on the screen may differ depending on the conditions of the signals emitted from the satellites.

No icon is displayed:

[GPS On/Off] is set to [Off].



The product cannot find a GPS signal, therefore, it cannot acquire the location information. Use the product in an open area.



The product is searching for GPS satellites. It may take some time to start triangulating.



The product can acquire the current location information.



An error occurred with the GPS function. Turn off the product, and turn it on again.

To receive a GPS signal

- Proper triangulation is not possible indoors or near tall buildings. Use the product in an open area outside, and turn the product off and on again.
- It may take from ten seconds to several minutes to acquire the location information.
- You can shorten the time of triangulation by using the GPS assist data.

Note

- It may take from ten seconds to several minutes to acquire the location information when you turn on this product. If you shoot images before the product acquires the location information, the information is not recorded on the images. To record a correct location information, first make sure the product receives the GPS signal, then shoot the images.
- During take off and landing of an airplane, set [Airplane Mode] to [On].
- Use GPS in accordance with the regulations of the countries or regions where you use the product.

[111] How to Use | Changing settings | Setup menu

GPS Auto Time Cor. (DSC-HX400V)

The product acquires the time information using GPS while the product is turned on, and the information is used for maintaining the accurate time setting. The product adjusts the time setting when it is turned off.

1. MENU →  (Setup) → [GPS Settings] → [GPS Auto Time Cor.] → desired setting.

Menu item details

On:

Uses GPS auto time correction.

Off (default setting):

Does not use GPS auto time correction.

Note

- [GPS Auto Time Cor.] is not available when [GPS On/Off] is set to [Off].
- Before using the [GPS Auto Time Cor.] function, set [Date/Time Setup].
- The corrected time may differ from the actual time for a few seconds.
- [GPS Auto Time Cor.] may not activate correctly in some areas.

[112] How to Use | Changing settings | Setup menu

GPS Auto Area Adj. (DSC-HX400V)

Corrects the time difference automatically if the product detects the difference by acquiring current location information via the GPS system.

1. MENU →  (Setup) → [GPS Auto Area Adj.] → desired setting.

Menu item details

On:

Corrects the time difference automatically.

Off (default setting):

Does not correct the time difference automatically.

Note

- When [GPS On/Off] is set to [Off], this function is disabled.
- Set [Date/Time Setup] in advance.
- [GPS Auto Area Adj.] may not function correctly depending on the location. In that case, set this setting to [Off].

[113] How to Use | Changing settings | Setup menu

Use GPS Assist Data (DSC-HX400V)

The time taken for the GPS acquiring location information can be shortened by using GPS assist data. To update the GPS assist data automatically, connect this product to a computer via a USB cable. (The supplied software PlayMemories Home should be installed on the computer in advance.)

Confirming the expiry date of the GPS assist data

1. MENU →  (Setup) → [GPS Settings] → [Use GPS Assist Data].

Note

- The computer should be connected to the internet for updating the GPS assist data.
- If the term of validity of the GPS assist data has expired, it cannot be used to shorten the time for recording the location information. We recommend you to update the GPS assist data regularly. The expiry date of the GPS assist data is approximately within 30 days.
- If [Date/Time Setup] has not been set, or the set time is shifted greatly, the time for the GPS acquiring location information cannot be shortened.
- For various reasons, Sony may stop providing the GPS assist data.

Updating the GPS assist data by inserting the memory card to your computer

Start up PlayMemories Home and display the main screen, then launch [GPS Support Tool]. Select the drive of the memory card and update the GPS assist data. Then insert the updated memory card to this product.

GPS Log REC (DSC-HX400V)

You can set the start/end of the GPS log recording. The product continues to record the track even when the power is off. To confirm the track, a computer with an internet connection and the software PlayMemories Home is required.

1. MENU →  (Setup) → [GPS Settings] → [GPS Log REC] → desired setting.

Menu item details

On:

Starts the GPS log recording.

Off (default setting):

Ends the GPS log recording.

Note

- When the memory card is not inserted, or there is no space on the memory card, the product cannot save the GPS log data.
- Up to 24 hours of GPS log data can be recorded at one time. When the recorded time of the GPS log data exceeds 24 hours, the recording stops automatically.
- Sony does not collect the location information and the track information.
- Sony provides the location information and the track information to Google Inc., so that this information can be displayed on a map on the computer.

Delete GPS log data (DSC-HX400V)

You can delete all the GPS log data which are recorded with [GPS Log REC].

1. MENU →  (Setup) → [GPS Settings] → [Delete GPS log data].
-

Upload Settings(Eye-Fi)

Sets whether to use the upload function when using an Eye-Fi card (commercially available). This item appears when an Eye-Fi card is inserted into the product's memory card slot.

1. MENU →  (Setup) → [Upload Settings] → desired setting.
2. Set your Wi-Fi network or destination on the Eye-Fi card.
For details, refer to the manual supplied with the Eye-Fi card.
3. Insert the Eye-Fi card you have set up into the product, and shoot still images.
Images are transferred to your computer, etc., automatically via the Wi-Fi network.

Menu item details

On (default setting):

Enables the upload function.

Off:

Disables the upload function

Communication status screen display

: Standby. No images are to be sent.



: Upload standby.

: Connecting.

: Uploading.

: Error

Note

- Eye-Fi cards are only sold in certain countries/regions.
- For more information on Eye-Fi cards, please contact the manufacturer or vendor directly.
- Eye-Fi cards can be used only in the countries/regions where they were purchased. Use Eye-Fi cards in accordance with the law of the countries/regions where you purchased the card.
- Eye-Fi cards are equipped with a wireless LAN function. Do not insert an Eye-Fi card into the product on an airplane. When an Eye-Fi card is inserted into the product, set [Upload Settings] to [Off]. When the upload function is set to [Off], the  indicator will be displayed on the product.
- Power save mode will not function during uploading.
- If  (error) is displayed, remove the memory card and reinsert it, or turn the product off and then on again. If the indicator appears again, the Eye-Fi card may be damaged.
- Wireless LAN communication may be influenced by other communication devices. If the communication status is poor, move closer to the access point to be connected.
- Third parties may know where you shot the image if you upload the image containing GPS

information. This is because [GPS On/Off] is set to [On]. Set [GPS On/Off] to [Off] before shooting.

- This product does not support Eye-Fi “Endless Memory Mode.” Before using an Eye-Fi card, be sure that “Endless Memory Mode” is turned off.

[117] How to Use | Changing settings | Setup menu

Tile Menu

Selects whether to always display the first screen of the menu when you press the MENU button.

1. MENU →  (Setup) → [Tile Menu] → desired setting.

Menu item details

On:

Always displays the first screen of the menu (Tile Menu).

Off (default setting):

Deactivates the Tile Menu display.

[118] How to Use | Changing settings | Setup menu

Mode Dial Guide

You can display the description of a shooting mode when you turn the mode dial and change the settings available for that shooting mode.

1. MENU →  (Setup) → [Mode Dial Guide] → desired setting.

Menu item details

On:

Displays the Mode Dial Guide.

Off (default setting):

Does not display the Mode Dial Guide.

Display Quality

You can change the display quality.

1. MENU →  (Setup) → [Display Quality] → desired setting.

Menu item details

High:

Displays in high quality.

Standard:

Displays in standard quality.

Note

- When [High] is set, battery consumption will be higher than when [Standard] is set.

Pwr Save Start Time

You can set the time by which the power goes off automatically.

1. MENU →  (Setup) → [Pwr Save Start Time] → desired setting.

Menu item details

30 Min/5 Min/2 Min (default setting)/1 Min

Note

- The power save function is not activated during playing back slideshow or recording movies, or when connected to a computer.

PAL/NTSC Selector

Plays back movies recorded with the product on a PAL/NTSC system TV.

1. MENU →  (Setup) → [PAL/NTSC Selector] → [Enter]

Note

- This function is provided with 1080 50i-compatible devices only. It is not provided with 1080 60i-compatible devices. The 1080 50i-compatible devices have a “50i” mark on the bottom of the product.
- If you insert a memory card that has previously been formatted with the PAL system, a message telling you that you must re-format the card appears. When you record using the NTSC system, re-format the memory card or use another memory card.
- When the NTSC mode is selected, the “Running on NTSC.” message always appears on the start-up screen each time you turn the product on.

[122] How to Use | Changing settings | Setup menu

Demo Mode

The [Demo Mode] function displays the movies recorded on the memory card automatically (demonstration), when the camera has not been operated for a certain time.

Normally select [Off].

1. MENU →  (Setup) → [Demo Mode] → desired setting.

Menu item details

On:

The movie playback demonstration starts automatically if the product is not operated for about one minute. Only protected AVCHD movies are played back.

Set the view mode to [AVCHD View], and protect the movie file with the oldest recorded date and time.

Off (default setting):

Does not show the demonstration.

Note

- You can set this item only when the product is powered by the AC-UD10/AC-UD11 AC Adaptor (sold separately).
- Even if [On] is selected, the product does not start a demonstration if there is no movie file on the memory card.
- When [On] is selected, the product does not switch to power save mode.

HDMI Resolution

When you connect the product to a High Definition (HD) TV with HDMI terminals using an HDMI cable (sold separately), you can select HDMI Resolution to output images to the TV.

1. MENU →  (Setup) → [HDMI Resolution] → desired setting.

Menu item details

Auto (default setting):

The product automatically recognizes an HD TV and sets the output resolution.

1080p:

Outputs signals in HD picture quality (1080p).

1080i:

Outputs signals in HD picture quality (1080i).

Note

- If the images are not displayed properly using the [Auto] setting, select either [1080i] or [1080p], based on which TV is to be connected.

CTRL FOR HDMI

When connecting this product to a “BRAVIA” Sync-compatible TV using an HDMI cable (sold separately), you can operate this product by aiming the TV remote control at the TV.

1. MENU →  (Setup) → [CTRL FOR HDMI] → desired setting.

Menu item details

On (default setting):

You can operate this product with a TV's remote control.

Off:

You cannot operate this product with a TV's remote control.

Note

- [CTRL FOR HDMI] is available only with a “BRAVIA” Sync-compatible TV.

USB Connection

Selects the appropriate USB connection method for each computer or USB device connected to this product.

1. MENU →  (Setup) → [USB Connection] → desired setting.

Menu item details

Auto (default setting):

Establishes a Mass Storage or MTP connection automatically, depending on the computer or other USB devices to be connected. Windows 7 or Windows 8 computers are connected in MTP, and their unique functions are enabled for use.

Mass Storage:

Establishes a Mass Storage connection between this product, a computer, and other USB devices.

MTP:

Establishes an MTP connection between this product, a computer, and other USB devices. Windows 7 or Windows 8 computers are connected in MTP, and their unique functions are enabled for use. With computers running a different OS (Windows Vista, Mac OS X), the AutoPlay Wizard appears, and the still images in the recording folder on this product are imported to the computer.

Note

- If Device Stage* is not displayed with Windows 7 or Windows 8, set [USB Connection] to [Auto].

* Device Stage is a menu screen used to manage connected devices, such as a camera (Function of Windows 7 or Windows 8).

USB LUN Setting

Enhances compatibility by limiting of USB connection functions.

1. MENU →  (Setup) → [USB LUN Setting] → desired setting.

Menu item details

Multi (default setting):

Normally, use [Multi].

Single:

Set [USB LUN Setting] to [Single] only if you cannot make a connection.

[127] How to Use | Changing settings | Setup menu

USB Power Supply

Sets whether to supply power via the micro USB cable when the product is connected to a computer or an USB device.

1. MENU →  (Setup) → [USB Power Supply] → desired setting.

Menu item details

On (default setting):

Power is supplied to the product via a micro USB cable when the product is connected to a computer, etc.

Off:

Power is not supplied to the product via a micro USB cable when the product is connected to a computer, etc.

[128] How to Use | Changing settings | Setup menu

Language

Selects the language to be used in the menu items, warnings and messages.

1. MENU →  (Setup) → [ Language] → desired language.
-

How to Use | Changing settings | Setup menu

Date/Time Setup

Sets the date and time again.

1. MENU →  (Setup) → [Date/Time Setup] → desired setting.

Menu item details

Daylight Savings:

Selects Daylight Savings [On]/[Off].

Date/Time:

Sets the date and time.

Date Format:

Selects the date and time display format.

[129] How to Use | Changing settings | Setup menu

Area Setting

Sets the area where you are using the product.

1. MENU →  (Setup) → [Area Setting] → desired area.

[130] How to Use | Changing settings | Setup menu

Format

Formats (initializes) the memory card. When you use a memory card with this product for the first time, it is recommended that you format the card using the product for stable performance of the memory card. Note that formatting permanently erases all data on the memory card, and is unrecoverable. Save valuable data on a computer, etc.

1. MENU →  (Setup) → [Format].

Note

- Formatting permanently erases all data including even protected images.

File Number

Selects how to assign file numbers to recorded images.

1. MENU →  (Setup) → [File Number] → desired setting.

Menu item details

Series (default setting):

Even if you change the recording destination folder or change the memory card, the product continues to assign numbers to files in sequence.

(If there is a larger file number on the new memory card than the latest image file, a number one higher than the largest number is assigned.)

Reset:

The product resets numbers when a file is recorded in a new folder and assigns numbers to files starting with “0001.”

(When the recording folder contains a file, a number one higher than the largest number is assigned.)

Select REC Folder

You can change the recording folder to which images are recorded.

1. MENU →  (Setup) → [Select REC Folder] → desired folder.

Note

- You cannot select the folder when you select the [Date Form] setting.

New Folder

Creates a new folder in the memory card. A new folder is created with a folder number one greater than the largest folder number currently used. Images are recorded in the newly created folder. A folder for still images and a folder for MP4 movies that have the same number are created at the same time.

1. MENU →  (Setup) → [New Folder].

Note

- When you insert a memory card that was used with other equipment into this product and shoot images, a new folder may be automatically created.
- Up to 4,000 images in total can be stored in one folder. When the folder capacity is exceeded, a new folder may be automatically created.

[134] How to Use | Changing settings | Setup menu

Folder Name

Still images you shoot are recorded in a folder that is automatically created under the DCIM folder on the memory card. You can change the way folder names are assigned.

1. MENU →  (Setup) → [Folder Name] → desired setting.

Menu item details

Standard Form (default setting):

The folder name form is as follows: folder number + MSDCF.

Example: 100MSDCF

Date Form:

The folder name form is as follows: folder number + Y (the last digit)/MM/DD.

Example: 10040405 (Folder number: 100, date: 04/05/2014)

Note

- The MP4 movie folder form is fixed as “folder number + ANV01”.

[135] How to Use | Changing settings | Setup menu

Recover Image DB

If image files were processed on a computer, problems may occur in the image database file. In such cases, the images on the memory card will not be played back on this product. If these problems happen, repair the file using [Recover Image DB].

1. MENU →  (Setup) → [Recover Image DB] → [Enter].

Note

- Use a sufficiently charged battery pack. Low battery power during repairing can cause damage to data.

[136] How to Use | Changing settings | Setup menu

Display Media Info.

Displays the recordable time of movies and the number of recordable still images for the inserted memory card.

1. MENU →  (Setup) → [Display Media Info.].

[137] How to Use | Changing settings | Setup menu

Version

Displays the version of this product's software.

1. MENU →  (Setup) → [Version].

[138] How to Use | Changing settings | Setup menu

Setting Reset

Resets the product to the default settings. Even if you perform [Setting Reset], the recorded

images are retained.

1. MENU →  (Setup) → [Setting Reset] → desired setting.

Menu item details

Camera Settings Reset:

Initializes the main shooting settings to the default settings.

Initialize:

Initializes all the settings to the default settings.

Note

- Be sure not to eject the battery pack while resetting.
- When you perform [Initialize], downloaded applications on the product may be uninstalled. To use these applications again, re-install them.

[139] How to Use | Using Wi-Fi functions | Connecting this product and a Smartphone

PlayMemories Mobile

To use [Smart Remote Embedded] or [Send to Smartphone], etc., the application PlayMemories Mobile should be installed on your smartphone.

Download and install the application PlayMemories Mobile from your smartphone's application store. If PlayMemories Mobile is already installed on your smartphone, be sure to update it to the latest version.

For details on PlayMemories Mobile, refer to the support page (<http://www.sony.net/pmm/>).

[140] How to Use | Using Wi-Fi functions | Connecting this product and a Smartphone

Connecting an Android smartphone to this product

1. Launch PlayMemories Mobile on your smartphone.
2. Select the model name of this product (DIRECT-xxxx: xxxx).



3. Input the password that is displayed on this product.

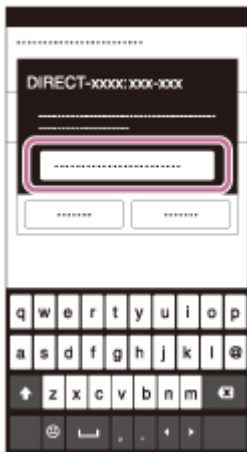

The smartphone is connected to the product.

[141] How to Use | Using Wi-Fi functions | Connecting this product and a Smartphone

Connecting the product to an iPhone or iPad

1. Select the model name of this product (DIRECT-xxxx: xxx-xxx) on the Wi-Fi setting screen of your iPhone or iPad.



2. Input the password displayed on this product.



The iPhone or iPad is connected to the product.

3. Confirm that your iPhone or iPad was connected to the “SSID” shown on this product.

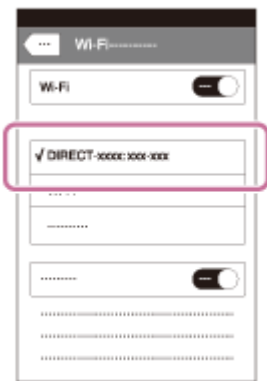

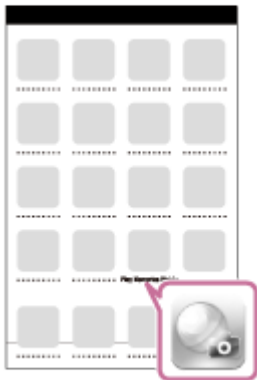

4. Return to the “Home” screen and launch PlayMemories Mobile.



[142] How to Use | Using Wi-Fi functions | Connecting this product and a Smartphone
Calling up an application using [One-touch(NFC)]

You can call up a desired application from the application menu of this product by touching an NFC-enabled Android smartphone to the product. If the application you call up has a feature

that works with the smartphone, the product and the smartphone will be connected via Wi-Fi. To use this function, register the desired application in advance.

1. MENU →  (Wireless) → [One-touch(NFC)] → desired application.
2. Switch this product to shooting mode, then touch an NFC-enabled smartphone to the  (N mark) on the product for 1-2 seconds.
 - PlayMemories Mobile launches on the smartphone, and the application you have registered launches on this product.

Note

- When the product is in playback mode, the registered application will not launch even if you touch the smartphone to the product.
- When you call up an application with one touch, even if that application does not work with a smartphone, PlayMemories Mobile on smartphone will launch. Exit PlayMemories Mobile without performing an operation. If you do not exit PlayMemories Mobile, the smartphone stays in standby connection status.

[143] How to Use | Using Wi-Fi functions | Controlling this product using a Smartphone Smart Remote Embedded

You can use a smartphone as the remote controller for this product, and shoot still images. Still images shot via remote control are sent to the smartphone from the product. The application PlayMemories Mobile must be installed on your smartphone.

1. MENU →  (Application) → [Application List] → [Smart Remote Embedded].
2. When the product is ready for the connection, an information screen appears on the product. Connect the smartphone and the product using that information.
 - Connection setting methods differ among smartphones.

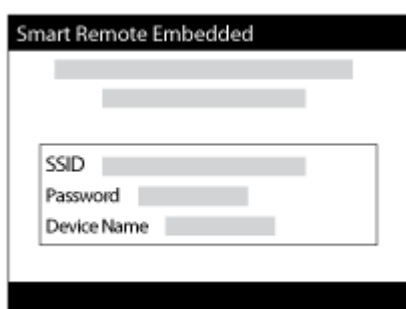

3. Check the composition of the image on the smartphone screen, and then press the shutter button (A) on the smartphone to shoot an image.
 - Use button (B) to change settings such as [EV], [Self-Timer] and [Review Check].

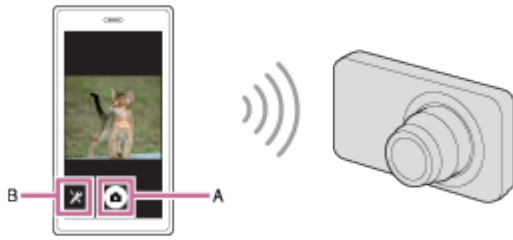

Note

- This product shares the connection information for [Smart Remote Embedded] with a device that has permission to connect. If you want to change the device that is permitted to connect to the product, reset the connection information by following these steps. MENU →  (Wireless) → [SSID/PW Reset]. After resetting the connection information, you must register the smartphone again.
- Depending on future version upgrades, the operational procedures or screen displays are subject to change without notice.

[144] How to Use | Using Wi-Fi functions | Controlling this product using a Smartphone One-touch connection with an NFC-enabled Android smartphone (NFC One-touch remote)

You can connect this product and an NFC-enabled Android smartphone with one touch, without performing a complex setup operation.

1. Activate the NFC function of the smartphone.
2. Switch this product to shooting mode.
 - The NFC function is available only when the  (N mark) is displayed on the screen.
3. Touch the product to the smartphone.

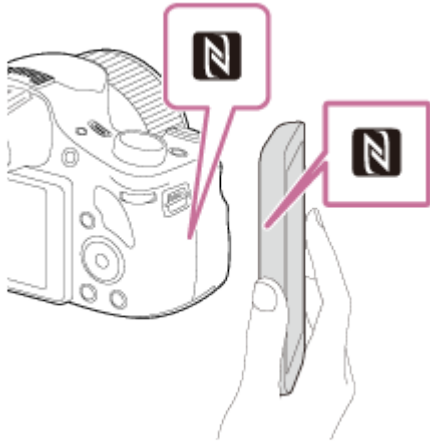

The smartphone and the product are connected, and PlayMemories Mobile launches on the smartphone.

- Touch the smartphone to the product for 1-2 seconds until PlayMemories Mobile launches.

About “NFC”

NFC is a technology that enables short-range wireless communication between various devices, such as mobile phones or IC tags, etc. NFC makes data communication simpler with just a touch on the designated touch-point.

- NFC (Near Field Communication) is an international standard of short-range wireless communication technology.



Note

- If you cannot make a connection, do as the following:
 - Launch PlayMemories Mobile on your smartphone, and then move the smartphone slowly toward the **N** (N mark) of this product.
 - If the smartphone is in a case, remove it.
 - If the product is in a case, remove it.
 - Check whether the NFC function is activated on your smartphone.
- When [Airplane Mode] is set to [On], you cannot connect this product and the smartphone. Set [Airplane Mode] to [Off].
- If this product and the smartphone are connected when the product is in playback mode, the displayed image is sent to the smartphone.

[145] How to Use | Using Wi-Fi functions | Transferring images to a Smartphone

Send to Smartphone

You can transfer still images to a smartphone and view them. The application PlayMemories Mobile must be installed on your smartphone.

1. MENU →  (Wireless) → [Send to Smartphone] → desired setting.
 - If you press the  (Send to Smartphone) button in playback mode, the setting screen for [Send to Smartphone] will appear.
2. If the product is ready for the transfer, the information screen appears on the product. Connect the smartphone and the product using that information. The setting method for connecting the smartphone and the product varies depending on the smartphone.

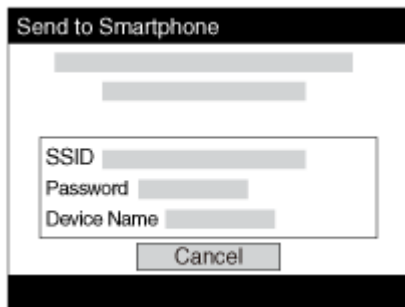

Menu item details

Select on This Device:

Selects an image on the product to be transferred to the smartphone.

(1) Select from among [This Image], [All Still Images on Date]/[All Movie(MP4) on Date], [All Images on This Date] or [Multiple Images].

(2) If you select [Multiple Images], select the desired images using  on the control button, then press MENU → [Enter].

Select on Smartphone:

Displays all images recorded on the product's memory card on the smartphone.

Note

- You can select an image size to be sent to the smartphone from [Original], [2M] or [VGA]. To change the image size, refer to the following steps.
 - For Android smartphone
Start PlayMemories Mobile, and change the image size by [Settings] → [Copy Image Size].
 - For iPhone/iPad
Select PlayMemories Mobile in the setting menu, and change the image size by [Copy Image Size].
- Some images may not be displayed on the smartphone depending on the recording format.
- You cannot send AVCHD format movies.
- This product shares the connection information for [Send to Smartphone] with a device that has permission to connect. If you want to change the device that is permitted to connect to the product, reset the connection information by following these steps. MENU → [Wireless] → [SSID/PW Reset]. After resetting the connection information, you must register the smartphone again.
- When [Airplane Mode] is set to [On], you cannot connect this product and the smartphone.

Set [Airplane Mode] to [Off].

[146] How to Use | Using Wi-Fi functions | Transferring images to a Smartphone

Sending images to an Android smartphone (NFC One-touch Sharing)

With just one touch, you can connect this product and an NFC-enabled Android smartphone, and send an image displayed on the product screen directly to the smartphone.

1. Activate the NFC function of the smartphone.
2. Display a single image on the product.
3. Touch the smartphone to the product.

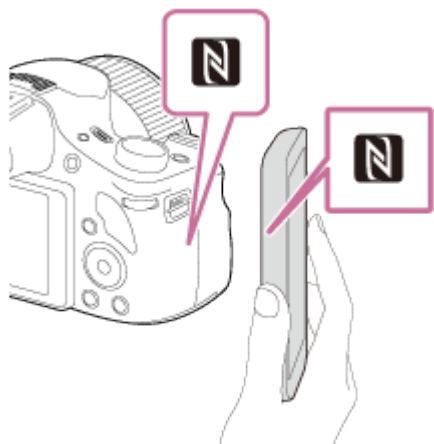

The product and the smartphone are connected, and PlayMemories Mobile automatically launches on the smartphone, and then the displayed image is sent to the smartphone.

- Before you touch the smartphone, cancel the sleep and lock-screen functions of the smartphone.
- The NFC function is available only when the **N** (N mark) is displayed on the product.
- Touch the smartphone to the product for 1-2 seconds until PlayMemories Mobile launches.
- To transfer two or more images, select MENU →  (Wireless) → [Send to Smartphone] to select images. After the connection enabled screen appears, use NFC to connect the product and the smartphone.

About "NFC"

NFC is a technology that enables short-range wireless communication between various devices, such as mobile phones or IC tags, etc. NFC makes data communication simpler with

just a touch on the designated touch-point.

- NFC (Near Field Communication) is an international standard of short-range wireless communication technology.

Note

- You can select an image size to be sent to the smartphone from [Original], [2M], or [VGA]. To change the image size, refer to the following steps.
 - For Android smartphone
Start PlayMemories Mobile, and change the image size by [Settings] → [Copy Image Size].
 - For iPhone/iPad
Select PlayMemories Mobile in the setting menu, and change the image size by [Copy Image Size].
- If the Image Index is displayed on the product, you cannot transfer images using the NFC function.
- If you cannot make a connection, perform the following:
 - Launch PlayMemories Mobile on your smartphone, and then move the smartphone slowly toward the  (N mark) of this product.
 - If the smartphone is in a case, remove it.
 - If the product is in a case, remove it.
 - Confirm that the NFC function is activated on the smartphone.
- When [Airplane Mode] is set to [On], you cannot connect the product and the smartphone. Set [Airplane Mode] to [Off].
- You cannot send AVCHD format movies.

[147] How to Use | Using Wi-Fi functions | Transferring images to a computer

Send to Computer

You can transfer images stored in the product to a computer connected to a wireless access point or wireless broadband router and easily make backup copies using this operation. Before starting this operation, install PlayMemories Home on your computer and register the access point on the product.

1. Start your computer.
2. MENU →  (Wireless) → [Send to Computer].

Note



- Depending on the application settings of your computer, the product will turn off after saving the images to your computer.
- You can transfer images from the product to only one computer at a time.

- If you want to transfer images to another computer, connect the product and the computer via a USB connection and follow the instructions in PlayMemories Home.

[148] How to Use | Using Wi-Fi functions | Transferring images to a TV

View on TV

You can view images on a network-enabled TV by transferring them from the product without connecting the product and TV with a cable. For some TVs, you may need to perform operations on the TV. For details, refer to the operating instructions supplied with the TV.

1. MENU →  (Wireless) → [View on TV] → desired device to be connected.
2. When you want to play back images using slideshow, press  on the center of the control button.

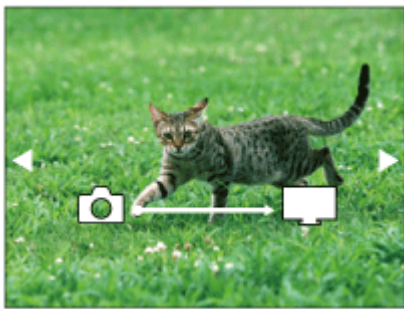

- To display the next/previous image manually, press the right/left button on the control button.
- To change the device to be connected, press the bottom button on the control button, then select [Device list].

Slideshow settings

You can change the slideshow settings by pressing the bottom button on the control button.

Playback Selection:

Selects the group of images to be shown.

Folder View(Still):

Selects from [All] and [All in Folder].

Date View:

Selects from [All] and [All in Date Rng.].

Interval:

Selects from [Short] and [Long].

Effects*:

Select from [On] and [Off].

Playback Image Size:

Select from [HD] and [4K].

*The settings are effective only for BRAVIA TV which is compatible with the functions.

Note

- You can use this function on a TV that supports DLNA renderer.
- You can view images on a Wi-Fi Direct-enabled TV or network-enabled TV (including cable TV).
- If you connect TV and this product and do not use Wi-Fi Direct, you need to register your access point first.
- Displaying the images on the TV may take time.
- Movies cannot be shown on a TV via Wi-Fi. Use an HDMI cable (sold separately).

[149] How to Use | Using Wi-Fi functions | Changing the settings of Wi-Fi functions

Airplane Mode

When you board an airplane, etc., you can turn off all Wi-Fi functions temporarily.

1. MENU →  (Wireless) → [Airplane Mode] → desired setting.
If you set [Airplane Mode] to [On], an airplane mark will be displayed on the screen.

[150] How to Use | Using Wi-Fi functions | Changing the settings of Wi-Fi functions

WPS Push

If your access point has the WPS button, you can register the access point to this product easily by pushing the WPS button.

1. MENU →  (Wireless) → [WPS Push].
2. Press the WPS button on the access point you want to register.

Note

- [WPS Push] works only if the security setting of your access point is set to WPA or WPA2 and your access point supports the WPS button method. If the security setting is set to WEP or your access point does not support the WPS button method, perform [Access Point Set.].

- For details about the available functions and settings of your access point, see the access point operating instructions or contact the administrator of the access point.
- A connection may not be enabled depending on the surrounding conditions, such as the type of wall material or if there is an obstruction or poor wireless signal between the product and access point. If that happens, change the location of the product or move the product closer to the access point.

[151] How to Use | Using Wi-Fi functions | Changing the settings of Wi-Fi functions

Access Point Set.

You can register your access point manually. Before starting the procedure, check the SSID name of the access point, security system, and password. The password may be preset in some devices. For details, see the access point operating instructions, or consult the access point administrator.

1. MENU →  (Wireless) → [Access Point Set.].
2. Select the access point you want to register.

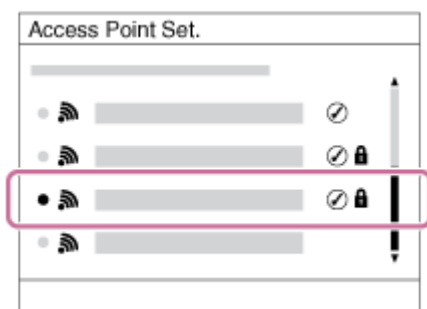

When the desired access point is displayed on the screen: Select the desired access point.

When the desired access point is not displayed on the screen: Select [Manual Setting] and set the access point.

*For the input method, refer to "How to use the keyboard."

- If you select [Manual Setting], input the SSID name of the access point, then select the security system.

3. Input the password, and select [OK].

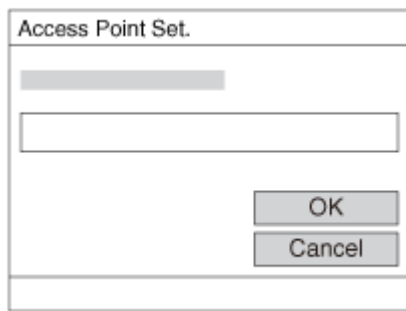



- Access points without the  mark do not require a password.

4. Select [OK].





How to use the keyboard



When manual character entry is required, a keyboard is displayed on the screen.



1. Input box The characters you entered are displayed.
2. Switch character types Each time you press  on the center of the control button, the character type switches among alphabet letters, numerals and symbols.
3. Keyboard Each time you press  on the center, the character that you enter will be displayed.

For example: If you want to enter "abd"

Select the key for "abc" and press  once to display "a" → select " ((5) Move cursor) and press  → select the key for "abc" and press  twice to display "b" → select the key for "def" and press  once to display "d".

4. Finalize Finalizes the entered characters.
5. Move cursor Moves the cursor in the input box to the right or left.
6. Delete Deletes the character preceding the cursor.
7.  Switches the next character to a capital or small letter.
8.  Enters a space.

- To cancel the input, select [Cancel].

Other setting items

Depending on the status or the setting method of your access point, you may want to set more items.

WPS PIN:

Displays the PIN code you enter into the connected device.

Priority Connection:

Select [On] or [Off].

IP Address Setting:

Select [Auto] or [Manual].

IP Address:

If you are entering the IP address manually, enter the set address.

Subnet Mask/Default Gateway:

When you set [IP Address Setting] to [Manual], enter the IP address to match your network environment.

Note

- To give the registered access point priority, set [Priority Connection] to [On].

[152] How to Use | Using Wi-Fi functions | Changing the settings of Wi-Fi functions

Edit Device Name

You can change the device name under Wi-Fi Direct.

1. MENU →  (Wireless) → [Edit Device Name].
2. Select the input box, then input the device name → [OK].
 - For input method, refer to “[How to use the keyboard.](#)”

[153] How to Use | Using Wi-Fi functions | Changing the settings of Wi-Fi functions

Disp MAC Address

Displays the MAC address of this product.

1. MENU →  (Wireless) → [Disp MAC Address].

[154] How to Use | Using Wi-Fi functions | Changing the settings of Wi-Fi functions

SSID/PW Reset

This product shares the connection information for [Send to Smartphone] and [Smart Remote Embedded] with a device that has permission to connect. If you want to change the device that is permitted to connect, reset the connection information.

1. MENU →  (Wireless) → [SSID/PW Reset] → [OK].

Note

- After resetting the connection information, and if you connect this product to the smartphone, you must register the smartphone again.

[155] How to Use | Using Wi-Fi functions | Changing the settings of Wi-Fi functions

Reset Network Set.

Resets all the network settings to default settings.

1. MENU →  (Wireless) → [Reset Network Set.] → [OK].

[156] How to Use | Adding applications to the product | PlayMemories Camera Apps

PlayMemories Camera Apps

You can add the desired functions to this product by connecting to the application download website  (PlayMemories Camera Apps) via the Internet. For example, the following operations are available:

- You can use various effects for shooting images.
- You can upload images to network services directly from the product.
- Press MENU →  (Application) → [Introduction] for information about the service and available countries and regions.

[157] How to Use | Adding applications to the product | PlayMemories Camera Apps

Recommended computer environment

For details on the recommended computer environments for downloading an application and adding functions to the product, use the following URL:

“PlayMemories Camera Apps” website (www.sony.net/pmca)

[158] How to Use | Adding applications to the product | Installing the applications

Opening a service account

You can open a service account, which is required to download applications.

1. Access the application download website.

<http://www.sony.net/pmca>

2. Follow the instructions on the screen and acquire a service account.

- Follow the instructions on the screen to download the desired application to the product.
-

[159] How to Use | Adding applications to the product | Installing the applications

Downloading applications

You can download applications using your computer.

1. Access the application downloading website.

<http://www.sony.net/pmca>

2. Select the desired application and download the application to the product following the instructions on the screen.

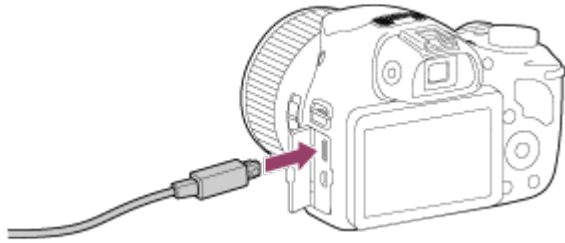

- Connect the computer and the product using the micro USB cable (supplied), following the instructions on the screen.



[160] How to Use | Adding applications to the product | Installing the applications

Downloading applications directly to the product using the Wi-Fi function

You can download applications using the Wi-Fi function without connecting to a computer.

1. MENU →  (Application) → Application List →  (PlayMemories Camera Apps), then follow the instructions on the screen to download applications.

Acquire a service account in advance.

Note

- When the IP address setting of this product is [Manual], you cannot download an application. Set [IP Address Setting] to [Auto].

[161] How to Use | Adding applications to the product | Starting the applications

Launching the downloaded application

Launch an application that has been downloaded from the application download website PlayMemories Camera Apps.

1. MENU →  (Application) → [Application List] → desired application to launch.

Hint

How to launch the applications faster



Assign [Download Appli.] and [Application List] to the custom key. You can launch the

applications or display application list only by pressing the custom key during the shooting information screen is displayed.

[162] How to Use | Adding applications to the product | Managing the applications

Uninstalling applications

You can uninstall applications from this product.

1. MENU →  (Application) → Application List → [Application Management] → [Manage and Remove].
 2. Select the application to be uninstalled.
 3. Select  to uninstall the application.
- The uninstalled application can be re-installed. For details, see the application download website.
-

[163] How to Use | Adding applications to the product | Managing the applications

Changing the order of applications

You can change the order in which added applications are displayed on this product.

1. MENU →  (Application) → Application List → [Application Management] → [Sort].
 2. Select the application of which you want to change the order.
 3. Select the destination.
-

[164] How to Use | Adding applications to the product | Managing the applications

Confirming the account information of PlayMemories Camera Apps

The account information for the “Sony Entertainment Network” that is registered on the product is displayed.

1. MENU →  (Application) → Application List → [Application Management] → [Display Account Information].

[165] How to Use | Viewing on computers | Recommended computer environment

Recommended computer environment

You can confirm the operating computer environment of the software from the following URL:
www.sony.net/pcenv/

[166] How to Use | Viewing on computers | Using the software

PlayMemories Home

With PlayMemories Home, you can do the following:

- You can import images shot with this product to your computer.
- You can play back the images imported to your computer.
- You can share your images using PlayMemories Online.

Also for Windows, you can do the following:

- You can organize images on the computer on a calendar by shooting date to view them.
 - You can edit and correct images, such as by trimming and resizing.
 - You can create a Blu-ray Disc, AVCHD disc or DVD-Video disc from AVCHD movies imported to a computer.
 - You can upload images to a network service. (An internet connection is required.)
 - You can import still images and movies recorded with location information to a computer and view them on a map.
 - For other details, please refer to the Help of PlayMemories Home.
-

[167] How to Use | Viewing on computers | Using the software

Installing PlayMemories Home

1. Using the Internet browser on your computer, go to the following URL and install PlayMemories Home.

www.sony.net/pm/

- Proceed the installation by following the instructions on the screen.
- When installation is completed, PlayMemories Home starts up.
- If PMB (Picture Motion Browser) supplied with a product that was purchased before 2011 has already been installed on the computer, PMB will be overwritten by PlayMemories Home. Please use PlayMemories Home.

2. Connect the product and your computer using the supplied micro USB cable.

- New functions may be added to PlayMemories Home. Even if PlayMemories Home has already been installed on your computer, connect this product and your computer again.

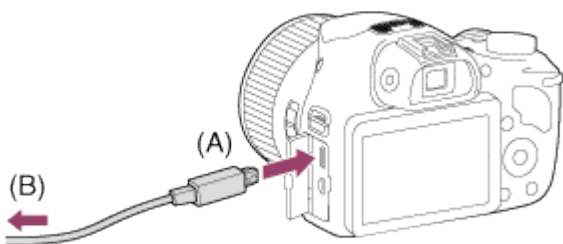

A: To the Multi/Micro USB Terminal

B: To the USB jack of the computer

Note

- Log on as Administrator.
- It may be necessary to restart your computer. When the restart confirmation message appears, restart the computer following the instructions on the screen.
- DirectX may be installed depending on your computer's system environment.

Hint

- For details on PlayMemories Home, refer to the Help of PlayMemories Home or the PlayMemories Home support page (<http://www.sony.co.jp/pmh-se/>) (English only).

For details on software for Mac computers, access the following URL:

<http://www.sony.co.jp/imsoft/Mac/>

Wireless Auto Import

“Wireless Auto Import” is required if you are using a Mac computer and want to import images to the computer using Wi-Fi function. Download “Wireless Auto Import” from the URL above, and install it on your Mac computer. For details, see Help for “Wireless Auto Import.”

Note

- The software that can be used varies depending on the region.

[169] How to Use | Viewing on computers | Connecting this product and a computer

Connecting the product to a computer

1. Insert a sufficiently charged battery pack into the product.
2. Turn on the product and the computer.
3. Connect the product and your computer using the micro USB cable (A) (supplied).

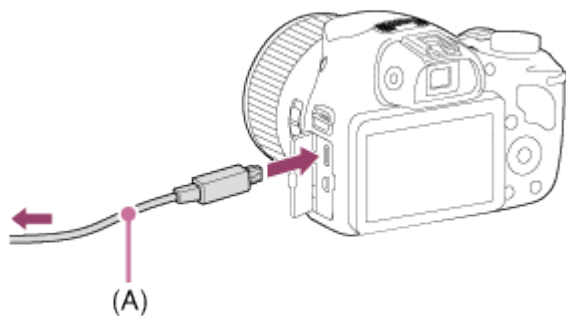

- If you connect the product to your computer using the micro USB cable when [USB Power Supply] is set to [On], power is supplied from your computer. (Default setting: [On])

[170] How to Use | Viewing on computers | Connecting this product and a computer

Importing images to the computer

PlayMemories Home allows you to easily import images. For details on PlayMemories Home functions, see the Help of PlayMemories Home.

Importing images to the computer without using PlayMemories Home (For Windows)

When the AutoPlay Wizard appears after making a USB connection between this product and a computer, click [Open folder to view files] → [OK] → [DCIM] or [MP_ROOT]. Then copy the desired images to the computer.

- If Device Stage appears on a Windows 7 or Windows 8 computer, double-click [Browse Files] → media icon → folder in which the images you want to import are stored.

Importing images to the computer without using PlayMemories Home (For Mac)

Connect the product to your Mac computer. Double-click the newly recognized icon on the desktop → the folder in which the image you want to import is stored. Then drag and drop the image file on to the hard disk icon.

Note

- For operations such as importing AVCHD movies to the computer, use PlayMemories Home.
- Do not edit or otherwise process AVCHD movie files/folders from the connected computer. Movie files may be damaged or become unplayable. Do not delete or copy AVCHD movies on the memory card from the computer. Sony is not held liable for consequences resulting from such operations via the computer.



[171] How to Use | Viewing on computers | Connecting this product and a computer

Disconnecting the product from the computer

Disconnects the USB connection between this product and the computer.

Perform the procedures from step 1 to 2 below before performing the following operations:

- Disconnecting the cable.
- Removing a memory card.
- Turning off the product.

1. Click  on the taskbar and then click the  (disconnect icon).

- For Windows Vista, click  on the taskbar.

2. Click the displayed message.

Note

- For Mac computers, drag and drop the icon of the memory card or the drive icon in the “Trash” icon. The product is disconnected from the computer.
- For Windows 7/Windows 8 computers, the disconnect icon may not appear. In that case, you can skip steps 1 and 2 above.

[172] How to Use | Viewing on computers | Creating a movie disc

Disc type



High-definition image quality (HD)

A Blu-ray Disc enables you to record longer duration of high definition image quality (HD) movies than DVD discs.



High-definition image quality (HD) (AVCHD recording disc)

High definition image quality (HD) movie can be recorded on DVD media, such as DVD-R discs, and a high definition image quality (HD) disc is created.

- You can play a high definition image quality (HD) disc on AVCHD format playback devices, such as a Sony Blu-ray Disc player and a PlayStation®3. You cannot play the disc on ordinary DVD players.



Standard definition image quality (STD)

Standard definition image quality (STD) movie converted from high definition image quality (HD) movie can be recorded on DVD media, such as DVD-R discs, and a standard image quality (STD) disc is created.

Hint

You can use the following types of 12 cm discs with PlayMemories Home. For Blu-ray discs, see “Creating Blu-ray Discs”.

DVD-R/DVD+R/DVD+R DL: Non-rewritable

DVD-RW/DVD+RW: Rewritable

- Always maintain your “PlayStation 3” to use the latest version of the “PlayStation 3” system software.
- “PlayStation 3” may not be available in some countries/regions.

Selecting the disc creation method

You can create a disc from an AVCHD format movie recorded using this product. Depending on the disc type, playable devices may vary. Select a method suitable for your disc player. For details on creating a disc using PlayMemories Home, see the Help of PlayMemories Home. (Only for Windows)



Creates a disc with high-definition image quality (HD)

Writable movie format: PS, FX, FH

Player: Blu-ray Disc playback devices (Sony Blu-ray Disc player, PlayStation®3, etc.)



Creates a disc with high-definition image quality (HD) (AVCHD recording disc)

Writable movie format: PS*, FX*, FH*

Player: AVCHD format playback devices (Sony Blu-ray Disc player, PlayStation®3, etc.)



Creates a disc with standard definition image quality (STD)

Writable movie format: PS*, FX*, FH*

Player: Ordinary DVD playback devices (DVD player, computer that can play back DVD discs, etc.)

*You can create a disc with movies recorded in these formats using PlayMemories Home by down-converting the image quality.

Creating a disc with a device other than a computer

You can also create discs using a Blu-ray recorder, etc. Depending on which device you use, the types of disc that can be created vary.

Blu-ray recorder:



High-definition image quality (HD)



Standard definition image quality (STD)

HDD recorder, etc:



Standard definition image quality (STD)

Note

- When creating AVCHD discs using PlayMemories Home from movies recorded with the [ Record Setting] of [60p 28M(PS)]/[50p 28M(PS)], [60i 24M(FX)]/[50i 24M(FX)] or [24p 24M(FX)]/[25p 24M(FX)], the image quality is converted and it is not possible to create discs that have the original image quality. Converting the image quality takes time. To record movies with the original image quality, use Blu-ray Discs.
- To create a Blu-ray Disc from movies recorded in [60p 28M(PS)]/[50p 28M(PS)], you need to use a device that is compliant with AVCHD format Ver. 2.0. The created Blu-ray Disc can be played back only on a device that is compliant with AVCHD format Ver. 2.0.
- For details on how to create a disc, refer to the operating instructions of the device you use.

[175] How to Use | Viewing on computers | Creating a movie disc

Creating Blu-ray Discs

You can create Blu-ray Discs from AVCHD movies imported to a computer. The computer must be capable of creating Blu-ray Discs. BD-R (not re-writable) or BD-RE (rewritable) discs can be used. Multi-session recordings cannot be made. To create Blu-ray Discs using PlayMemories Home, be sure to install the dedicated add-on software. For details, see the following URL:

<http://support.d-imaging.sony.co.jp/BDUW/>

To install, your computer must be connected to the Internet. For detailed operations, see the Help of PlayMemories Home.

Note

- To play back a Blu-ray Disc that was created using movies recorded in [60p 28M(PS)]/[50p 28M(PS)], you must use a device that is compliant with AVCHD format Ver. 2.0.

Precautions

Backing up memory cards

Data may be corrupted in the following cases. Be sure to back up the data for protection.

- When the memory card is removed or the product is turned off during a read or write operation.
- When the memory card is used in locations subject to static electricity or electrical noise.

Creating an image database file

If you insert a memory card that does not contain an image database file into the product and turn on the power, the product automatically creates an image database file using some of the memory card's capacity. The process may take a long time and you cannot operate the product until the process is completed.

If a database file error occurs, export all images to your computer using PlayMemories Home, and then format the memory card using this product.

Do not use/store the product in the following places

- In an extremely hot, cold or humid place
In places such as in a car parked in the sun, the camera body may become deformed and this may cause a malfunction.
- Storing under direct sunlight or near a heater
The camera body may become discolored or deformed, and this may cause a malfunction.
- In a location subject to rocking vibration
- Near strong magnetic place
- In sandy or dusty places
Be careful not to let sand or dust get into the product. This may cause the product to malfunction, and in some cases this malfunction cannot be repaired.

On operating temperatures

Your product is designed for use under the temperatures between 0°C and 40 °C (32 °F and 104 °F). Shooting in extremely cold or hot places that exceed this range is not recommended.

On moisture condensation

- If the product is brought directly from a cold to a warm location, moisture may condense inside or outside the product. This moisture condensation may cause a malfunction of the

product.

- If moisture condensation occurs, turn off the product and wait about an hour for the moisture to evaporate. Note that if you attempt to shoot with moisture remaining inside the lens, you will be unable to record clear images.

On the functions available with the product

This manual describes the functions of 1080 60i-compatible devices and 1080 50i-compatible devices. To check whether this product is a 1080 60i-compatible device or 1080 50i-compatible device, look for the following marks on the bottom of the product.

- 1080 60i-compatible device: 60i
- 1080 50i-compatible device: 50i

Notes for when on board an airplane

- In an airplane, set [Airplane Mode] to [On].

On image data compatibility

This product conforms with DCF (Design rule for Camera File system) universal standard established by JEITA (Japan Electronics and Information Technology Industries Association).

- Playback of images recorded with your product on other equipment and playback of images recorded or edited with other equipment on your product are not guaranteed.

Notes on playing movies on other devices

- This product uses MPEG-4 AVC/H.264 High Profile for AVCHD format recording. For this reason, movies recorded in AVCHD format with this product cannot be played by the following devices.

Other devices compatible with AVCHD format that does not support High Profile

Devices incompatible with the AVCHD format

This product also uses MPEG-4 AVC/H.264 Main Profile for MP4 format recording. For this reason, play back movies recorded in MP4 format with this product on MPEG-4 AVC/H.264 supported devices.

- Discs recorded with HD (high definition) image quality can be played back only on AVCHD format-compatible devices.
DVD-based players or recorders cannot play back HD image quality discs, as they are incompatible with the AVCHD format. Also, DVD-based players or recorders may fail to eject HD image quality discs that are recorded using the AVCHD format.

On the monitor and lens

- The monitor is manufactured using extremely high-precision technology so over 99.99 % of the pixels are operational for effective use. However, there may be some tiny black points and/or bright points (white, red, blue or green in color) that constantly appear on the monitor.

These points are normal in the manufacturing process and do not affect the images in any way.

- Exposing the monitor or lens to direct sunlight for long periods may cause a malfunction. Exercise caution when placing the product near a window or outdoors.
- Do not press against the monitor. The monitor may be discolored and that may cause a malfunction.
- Images may trail across on the monitor in a cold location. This is not a malfunction.
- If the monitor has drops of water or other liquids on it, wipe it with a soft cloth. If the monitor stays wet, the surface of the monitor may change or deteriorate. This may cause a malfunction.
- When the battery pack is discharged, the product may shut off while the lens is still extended. Insert a charged battery pack, then turn the product on again.
- Make sure not to bump the lens or subject it to force.

Notes on the flash

- Do not cover the flash with your fingers.
- Do not carry the product by the flash unit, or use excessive strength on it.
- If water, dust or sand get into the open flash unit, it may cause a malfunction.

Notes on discarding or transferring this product to others

When discarding or transferring this product to others, make sure to perform the following operation to protect private information.

- Perform [Setting Reset] to reset all the settings.

[177] How to Use | Precautions/This product | Precautions

On the internal rechargeable battery

This camera has an internal rechargeable battery for maintaining the date and time and other settings regardless of whether the power is on or off, or whether the battery pack is charged or discharged. This rechargeable battery is continually charged as long as you are using the product. However, if you use the product for only short periods, it gradually discharges. If you do not use the product at all for about 1 month(s) it becomes completely discharged. In this case, be sure to charge this rechargeable battery before using the product. However, even if this rechargeable battery is not charged, you can still use the product as long as you do not record the date and time.

Charging method of the internal rechargeable battery

Insert a charged battery pack into the product, or connect the product to a wall outlet (wall

socket) using the AC Adaptor (supplied), and leave the product for 24 hours or more with the power off.

[178] How to Use | Precautions/This product | Precautions

Notes on the battery pack

Charging the battery pack

- Charge the battery pack (supplied) before using the product for the first time.
- The charged battery pack will discharge little by little even if you do not use it. Charge the battery pack each time before you use the product so that you do not miss any opportunities to shoot images.
- You can charge the battery pack even if it is not completely discharged. You can use a partially charged battery pack.
- If the Charge lamp flashes and charging is canceled halfway, remove the battery pack once then reinsert it.
- We recommend charging the battery pack in an ambient temperature of between 10 °C and 30 °C (50 °F and 86 °F). The battery pack may not be effectively charged in temperatures outside this range.
- When you connect this product and a laptop computer that is not connected to a power source, the laptop's battery charge may decrease. Do not charge this product using the laptop computer for too long.
- Do not turn on/restart a computer, wake a computer from sleep mode, or turn off a computer while this product is connected to the computer via USB cable. Doing so may cause a malfunction of this product. Disconnect the product and the computer before performing the above operations.
- We do not guarantee charging if you are using a self-built or modified computer.

Charging time (Full charge)

The charging time is approximately 230 minutes using the AC adaptor (supplied). The above charging time applies when charging a fully depleted battery pack at a temperature of 25°C (77°F). Charging may take longer depending on conditions of use and circumstances.

Effective use of the battery pack

- Battery performance decreases in low temperature environments. So in cold places, the operational time of the battery pack is shorter. To ensure longer battery pack use, we recommend putting the battery pack in your pocket close to your body to warm it up, and insert it in the product immediately before you start shooting. If there are any metal objects such as keys in your pocket, be careful of causing a short-circuit.

- The battery pack will run down quickly if you use the flash or zoom frequently.
- We recommend preparing spare battery packs and taking trial shots before taking the actual shots.
- Do not expose the battery pack to water. The battery pack is not water-resistant.
- Do not leave the battery pack in extremely hot places, such as in a car or under direct sunlight.
- If the battery terminal is dirty, you may not be able to turn on the product or the battery pack may not be properly charged. In that case, clean the battery by lightly wiping off any dust using a soft cloth or a cotton swab.

Remaining battery indicator

- The remaining battery indicator appears on the screen.



A: Battery level high

B: Battery exhausted

- It takes about one minute for the correct remaining battery indicator to appear.
- The correct remaining battery indicator may not be displayed under some operating or environmental conditions.
- If you do not operate the product for a certain period of time while the power is on, the product turns off automatically (Auto power-off function).
- If the remaining battery time does not appear on the screen, press the DISP (Display Setting) button to display it.

How to store the battery pack

- To maintain the battery pack's function, charge the battery pack and then fully discharge it in the product at least once a year before storing it. Store the battery pack in a cool, dry place.
- To use the battery pack up, leave the product in slide show playback mode until the power goes off.
- To prevent staining the terminal, short-circuiting, etc., be sure to use a plastic bag to keep away from metal materials when carrying or storing the battery pack.

On battery life

- The battery life is limited. If you use the same battery repeatedly, or use the same battery for a long period, the battery capacity decreases gradually. If the available time of the battery is shortened significantly, it is probably time to replace the battery pack with a new one.
- The battery life varies according to how the battery pack is stored and the operating conditions and environment in which each battery pack is used.

Charging the battery pack

- The supplied AC Adaptor is dedicated to this product. Do not connect with other electronic devices. Doing so may cause a malfunction.
- Make sure to use a genuine Sony AC Adaptor.
- If the product's Charge lamp flashes while charging, remove the battery pack being charged, and then insert the same battery pack firmly back into the product. If the Charge lamp flashes again, this may indicate a faulty battery or that a battery pack other than the specified type has been inserted. Check that the battery pack is the specified type.
If the battery pack is the specified type, remove the battery pack, replace it with a new or different one and check that the newly inserted battery is charging correctly. If the newly inserted battery is charging correctly, the previously inserted battery may be faulty.
- If the Charge lamp flashes even if the AC Adaptor is connected to the product and the wall outlet (wall socket), this indicates that charging has stopped temporarily and is on standby. Charging stops and enters standby status automatically when the temperature is outside of the recommended operating temperature. When the temperature returns to the appropriate range, charging resumes and the Charge lamp lights up again. We recommend charging the battery pack in an ambient temperature of between 10°C to 30°C (50°F to 86°F).
- Even if the supplied AC Adaptor is used with the product when you shoot or play back images, power is not supplied from the wall outlet (wall socket). If you use the AC-UD10/AC-UD11 AC Adaptor (sold separately), you will be able to shoot or play back images while power is supplied from the wall outlet (wall socket).

Memory card

Memory card

Card Type Indications in Help Guide

“Memory Stick PRO Duo” media

(“Memory Stick XC-HG Duo” media/“Memory Stick PRO Duo” media/“Memory Stick PRO-HG Duo” media)

“Memory Stick Micro” media

“Memory Stick Micro” (M2) media/“Memory Stick Micro” (Mark2) media)

SD card

(SD memory card/SDHC memory card/SDXC memory card)

microSD memory card

(microSD memory card/microSDHC memory card/microSDXC memory card)

- “Memory Stick PRO Duo” media, “Memory Stick XC-HG Duo” media and SD cards up to 64 GB have been tested and proven to operate with this product.
- “Memory Stick Micro” media up to 16 GB and microSD memory cards up to 64 GB have been tested and proven to operate with this product.
- When recording movies, the following memory cards are recommended:

MEMORY STICK PRO DUO (Mark2) (“Memory Stick PRO Duo” media (Mark2))

MEMORY STICK XC-HG DUO (“Memory Stick XC-HG Duo” media (Mark2))

MEMORY STICK PRO-HG DUO (“Memory Stick PRO-HG Duo” media)

MEMORY STICK MICRO (Mark2) (“Memory Stick Micro” media (Mark2))

Class 4 SD card or faster, Class 4 microSD memory card or faster

Note

- When you use a memory card with this product for the first time, it is recommended that you format the card using the product for stable performance of the memory card before shooting.
Note that formatting permanently erases all data on the memory card, and is unrecoverable. Save precious data on a computer, etc.
- If you repeatedly shoot and delete images for a long time, fragmentation of data in a file in the memory card may occur, and movie recording may be interrupted in the middle of shooting. If this happens, save your images to a computer or other storage location, then execute [Format].
- Memory card formatted with a computer is not guaranteed to operate with the product.
- Data read/write speeds differ depending on the combination of the memory card and the equipment used.
- We recommend backing up important data, such as to a hard disk of a computer.
- Do not attach a label on the memory card itself nor on a memory card adaptor.
- Do not touch the terminal section of the memory card with your hand or a metal object.
- Do not strike, bend or drop the memory card.
- Do not disassemble or modify the memory card.
- Do not expose the memory card to water.
- Do not leave the memory card within the reach of small children. They might accidentally swallow it.
- The memory card may be hot just after it has been used for a long time. Be careful when you handle it.
- Do not insert a memory card that does not fit the memory card slot. Doing so will cause a malfunction.
- Do not use or store the memory card under the following conditions:

High temperature locations such as in a car parked under the sun

Locations exposed to direct sunlight

Humid locations or locations with corrosive substances present

- Images recorded on “Memory Stick XC-HG Duo” media, SDXC memory cards and micro SDXC memory cards cannot be imported to or played on computers or AV devices that are not compatible with exFAT when connected using a micro USB cable. Make sure that the device is compatible with exFAT before connecting it to the product. If you connect your product to an incompatible device, you may be prompted to format the card. Never format the card in response to this prompt, as doing so will erase all data on the card. (exFAT is the file system used on “Memory Stick XC-HG Duo” media, SDXC memory cards and micro SDXC memory cards.)

Notes on using the memory card adaptor (sold separately)

- When inserting a memory card into a memory card adaptor, be sure that the memory card is inserted in the correct direction and then insert it as far as it will go. If the card is not inserted properly, it may result in a malfunction.
- When you use “Memory Stick Micro” media or a microSD memory card with this product, be sure to insert it into a dedicated memory card adaptor first.

“Memory Stick” media

The types of “Memory Stick” media that can be used with the product are as follows. However, proper operation cannot be guaranteed for all “Memory Stick” media functions.

- “Memory Stick PRO Duo” media: *1*2*3
- “Memory Stick PRO-HG Duo” media: *1*2
- “Memory Stick XC-HG Duo” media: *1*2
- “Memory Stick Micro (M2)” media: *1
- “Memory Stick Micro (Mark2)” media: *1

*1 This “Memory Stick” is equipped with MagicGate function. MagicGate is copyright protection technology that uses encryption technology. Data recording/playback that requires MagicGate functions cannot be performed with this product.

*2 High-speed data transfer using a parallel interface is supported.

*3 When recording movies, only media marked with Mark2 can be used.

Notes on using “Memory Stick Micro” media (sold separately)

- This product is compatible with “Memory Stick Micro” media (“M2”). “M2” is an abbreviation for “Memory Stick Micro” media.
- To use a “Memory Stick Micro” media with this product, be sure to insert the “Memory Stick Micro” media into an “M2” Adaptor as large as Duo size. If you insert a “Memory Stick Micro” media into the product without an “M2” Adaptor as large as Duo size, you might not be able to remove it from the product.
- Do not leave the “Memory Stick Micro” media within the reach of small children. They might

accidentally swallow it.

[181] How to Use | Precautions/This product | Cleaning this product

On cleaning

Cleaning the lens and flash

Wipe the lens and flash with a soft cloth to remove fingerprints, dust, etc.

Cleaning the lens

- Do not use a cleaning solution containing organic solvents, such as thinner, or benzene.
- When cleaning the lens surface, remove dust with a commercially available blower. In case of dust that sticks to the surface, wipe it off with a soft cloth or tissue paper slightly moistened with lens cleaning solution. Wipe in a spiral pattern from the center to the outside. Do not spray lens cleaning solution directly onto the lens surface.

Cleaning the flash

Clean the flash surface before use. The heat of the flash emission may cause dirt on the flash surface to start smoking or burning. Wipe the flash surface with a soft cloth to remove dirt or dust, etc.

Cleaning the product surface

Clean the product surface with a soft cloth slightly moistened with water, then wipe the surface with a dry cloth. To prevent damage to the finish or casing:

- Do not expose the product to chemical products such as thinner, benzene, alcohol, disposable cloths, insect repellent, sunscreen or insecticide.
- Do not touch the product with any of the above on your hand.
- Do not leave the product in contact with rubber or vinyl for a long time.

Cleaning the monitor

- If oil from your hand or hand cream, etc., remain on the monitor, the original coating may become easily removable. Wipe oil or hand cream off as soon as possible.
 - If you wipe the monitor firmly using tissue paper, etc., the coating may be scratched.
 - If the monitor becomes dirty with fingerprints or dust, gently remove the dust from the surface, and then clean the monitor using soft cloth, etc.
-

Number of still images

The number of still images may vary depending on the shooting conditions and the memory card.

[ Image Size]: [L: 20M]

When [ Aspect Ratio] is set to [4:3]*

Standard

2GB: 295 images

4GB: 590 images

8GB: 1200 images

16GB: 2400 images

32GB: 4800 images

64GB: 9600 images

Fine

2GB: 200 images

4GB: 400 images

8GB: 810 images

16GB: 1600 images

32GB: 3250 images

64GB: 6500 images

*When the [ Aspect Ratio] is set to other than [4:3], you can record more pictures than shown above.

Note

- Even if the number of remaining shootable images is greater than 9,999, the “9999” indicator appears.
- When an image shot with other products is played back on this product, the image may not appear in the actual image size.

Recordable time of movies

The table below shows the approximate maximum recording times which can be recorded on the memory card that is formatted with this product. These numbers are the total times of all

movie files on the memory card. The recordable time may vary depending on the shooting conditions and the memory card.

(h (hour), m (minute))

60i 24M(FX)

50i 24M(FX)

2GB: 10 m

4GB: 20 m

8GB: 40 m

16GB: 1 h 30 m

32GB: 3 h

64GB: 6 h

60i 17M(FH)

50i 17M(FH)

2GB: 10 m

4GB: 30 m

8GB: 1 h

16GB: 2 h

32GB: 4 h 5 m

64GB: 8 h 15 m

60p 28M(PS)

50p 28M(PS)

2GB: 9 m

4GB: 15 m

8GB: 35 m

16GB: 1 h 15 m

32GB: 2 h 30 m

64GB: 5 h 5 m

24p 24M(FX)

25p 24M(FX)

2GB: 10 m

4GB: 20 m

8GB: 40 m

16GB: 1 h 30 m

32GB: 3 h

64GB: 6 h

24p 17M(FH)

25p 17M(FH)

2GB: 10 m

4GB: 30 m

8GB: 1 h

16GB: 2 h

32GB: 4 h 5 m

64GB: 8 h 15 m
1440×1080 12M
2GB: 15 m
4GB: 40 m
8GB: 1 h 20 m
16GB: 2 h 45 m
32GB: 5 h 30 m
64GB: 11 h 5 m
VGA 3M
2GB: 1 h 10 m
4GB: 2 h 25 m
8GB: 4 h 55 m
16GB: 9 h 55 m
32GB: 20 h
64GB: 40 h 10 m

Continuous shooting is possible for approximately 29 minutes for each shooting (limited by product specifications). For [MP4 12M] size movies, continuous shooting is possible for approximately 15 minutes (limited by 2 GB file size).

Note

- The recordable time of movies varies because the product is equipped with VBR (Variable Bit Rate), which automatically adjusts image quality depending on the shooting scene. When you record a fast-moving subject, the image is clearer but the recordable time is shorter because more memory is required for recording. The recordable time also varies depending on the shooting conditions, the subject or the image quality/size settings.

[184] How to Use | Precautions/This product | Using this product abroad

Plug adaptor

You can use the AC Adaptor (supplied) in any country or region where the power supply is within 100 V to 240 V AC, 50 Hz/60 Hz.

Note

- Do not use an electronic voltage transformer as doing so may cause a malfunction.
-

[185] How to Use | Precautions/This product | Using this product abroad

On TV color systems

To view movies shot using this product on a television, the product and television must use the same color television system. Check the TV color system for the country or region where you are using the product.

- NTSC system:
Bahama Islands, Bolivia, Canada, Central America, Chile, Colombia, Ecuador, Jamaica, Japan, Korea, Mexico, Peru, Surinam, Taiwan, the Philippines, the U.S.A., Venezuela, etc.
- PAL system:
Australia, Austria, Belgium, China, Croatia, Czech Republic, Denmark, Finland, Germany, Holland, Hong Kong, Hungary, Indonesia, Italy, Kuwait, Malaysia, New Zealand, Norway, Poland, Portugal, Rumania, Singapore, Slovak Republic, Spain, Sweden, Switzerland, Thailand, Turkey, United Kingdom, Viet Nam, etc.
- PAL-M system:
Brazil
- PAL-N system:
Argentina, Paraguay, Uruguay
- SECAM system:
Bulgaria, France, Greece, Guiana, Iran, Iraq, Monaco, Russia, Ukraine, etc.

[186] [How to Use](#) | [Precautions/This product](#) | [Other information](#)

ZEISS lens

The camera is equipped with a ZEISS lens which is capable of reproducing sharp images with excellent contrast. The lens for the camera has been produced under a quality assurance system certified by ZEISS in accordance with the quality standards of ZEISS in Germany.

[187] [How to Use](#) | [Precautions/This product](#) | [Other information](#)

GPS (DSC-HX400V)

GPS

- As the positions of GPS satellites vary constantly, it may take longer to determine the location or the receiver may not be able to determine the location at all, depending on the location and time you use this product.

- GPS is a system for determining geographic location by triangulating radio signals from GPS satellites. Avoid using the camera in places where radio signals are blocked or reflected, such as a shadowy place surrounded by buildings or trees, etc. Use the camera in open sky environments.
- You may not be able to record location information at locations or in situations where radio signals from the GPS satellites do not reach the product as follows.
 - In tunnels, indoors or under the shade of buildings.
 - Between tall buildings or at narrow streets surrounded by buildings.
 - In underground locations, locations surrounded by dense trees, under an elevated bridge, or in locations where magnetic fields are generated, such as near high voltage cables.
 - Near devices that generate radio signals of the same frequency band as the camera: near 1.5 GHz band mobile telephones, etc.
- If you upload and share the images which are recorded with the setting [GPS On/Off] is [On], the record location may be exposed on the internet even if you do not intend to do so. If you do not want to record location information, select [Off] for [GPS On/Off].

On triangulating errors

- If you move to another location right after turning on the camera, it may take a longer time for the product to start triangulating, compared to when you stay in the same place.
- Error caused by the position of GPS satellites

The product automatically triangulates your current location when the product receives radio signals from 3 or more GPS satellites. The triangulating error allowed by the GPS satellites is about 10 m (32.81 feet). Depending on the environment of the location, the triangulating error can be greater. In this case, your actual location may not match the location on the map based on the GPS information. Meanwhile, the GPS satellites are controlled by the United States Department of Defense, and the degree of accuracy may be changed intentionally.
- Error during the triangulating process

The camera acquires location information periodically. There is a slight time difference between when the location information is acquired and when the location information is recorded on an image, therefore, the actual recording location may not match exactly the location on the map based on the GPS information.

On the restriction of use of GPS on an airplane

- During take off and landing of an airplane, set [Airplane Mode] to [On].
- If you do not want to record location information, set [GPS On/Off] to [Off].

The AVCHD format was developed for high-definition digital video cameras when recording an HD (High-Definition) signal using high-efficiency compression coding technology. The MPEG-4 AVC/H.264 format is used to compress video data, and the Dolby Digital or Linear PCM system is used to compress audio data.

The MPEG-4 AVC/H.264 format is capable of compressing images at higher efficiency than that of the conventional image compressing format.

- As the AVCHD format uses compression coding technology, the picture may be unstable in scenes where the screen, angle of view, or brightness, etc. change drastically, but this is not a malfunction.

[189] How to Use | Precautions/This product | Other information

License

Notes on the License

This product comes with software that are used based on licensing agreements with the owners of that software. Based on requests by the owners of copyright of these software applications, we have an obligation to inform you of the following. Please read the following sections.

Licenses (in English) are recorded in the internal memory of your product. Establish a Mass Storage connection between the product and a computer to read licenses in the “PMHOME” - “LICENSE” folder.

THIS PRODUCT IS LICENSED UNDER THE AVC PATENT PORTFOLIO LICENSE FOR THE PERSONAL USE OF A CONSUMER OR OTHER USES IN WHICH IT DOES NOT RECEIVE REMUNERATION TO

(i) ENCODE VIDEO IN COMPLIANCE WITH THE AVC STANDARD (“AVC VIDEO”)

AND/OR

(ii) DECODE AVC VIDEO THAT WAS ENCODED BY A CONSUMER ENGAGED IN A PERSONAL ACTIVITY AND/OR WAS OBTAINED FROM A VIDEO PROVIDER LICENSED TO PROVIDE AVC VIDEO.

NO LICENSE IS GRANTED OR SHALL BE IMPLIED FOR ANY OTHER USE. ADDITIONAL INFORMATION MAY BE OBTAINED FROM MPEG LA, L.L.C. SEE

[HTTP://WWW.MPEGLA.COM](http://www.mpegla.com)

On GNU GPL/LGPL applied software

The software that is eligible for the following GNU General Public License (hereinafter referred to as “GPL”) or GNU Lesser General Public License (hereinafter referred to as “LGPL”) are included in the product.

This informs you that you have a right to have access to, modify, and redistribute source code for these software programs under the conditions of the supplied GPL/LGPL.

Source code is provided on the web.

Use the following URL to download it.

<http://www.sony.net/Products/Linux/>

We would prefer you do not contact us about the contents of source code.

Licenses (in English) are recorded in the internal memory of your product. Establish a Mass Storage connection between the product and a computer to read licenses in the “PMHOME” - “LICENSE” folder.

[190] How to Use | Precautions/This product | Trademarks

Trademarks

- The following marks are registered trademarks or trademarks of Sony Corporation.

Cyber-shot, Cyber-shot,  , Memory Stick, **MEMORY STICK PRO**, Memory Stick PRO, **MEMORY STICK DUO**, Memory Stick Duo, **MEMORY STICK PRO DUO**, Memory Stick PRO Duo, **MEMORY STICK PRO-HG DUO**, Memory Stick PRO-HG Duo, **MEMORY STICK XC-HG DUO**, Memory Stick XC-HG Duo, **MEMORY STICK MICRO**, Memory Stick Micro, **MAGIC GATE**, MagicGate, BRAVIA, PhotoTV HD, PlayMemories Online, PlayMemories Online logo, PlayMemories Home, PlayMemories Home logo, PlayMemories Mobile, PlayMemories Mobile logo
PlayMemories Camera Apps, PlayMemories Camera Apps logo
Multi Interface Shoe, Multi Interface Shoe logo

- Blu-ray Disc™ and Blu-ray™ are trademarks of the Blu-ray Disc Association.
- AVCHD Progressive and AVCHD Progressive logotype are trademarks of Panasonic Corporation and Sony Corporation.
- Dolby and the double-D symbol are trademarks of Dolby Laboratories.
- HDMI, the HDMI logo and High-Definition Multimedia Interface are trademarks or registered trademarks of HDMI Licensing LLC.
- Microsoft, Windows, DirectX and Windows Vista are either registered trademarks or trademarks of Microsoft Corporation in the United States and/or other countries.
- Mac and Mac OS are trademarks of Apple Inc.
- iOS is a registered trademark or trademark of Cisco Systems Inc.
- iPhone and iPad are trademarks of Apple Inc., registered in the U.S. and other countries.
- SDXC logo is a trademark of SD-3C, LLC.

- Android and Google Play are trademarks or registered trademarks of Google Inc.
- Wi-Fi, the Wi-Fi logo, Wi-Fi PROTECTED SET-UP are registered trademarks or trademarks of the Wi-Fi Alliance.
- The N Mark is a trademark or registered trademark of NFC Forum, Inc. in the United States and in other countries.
- DLNA and DLNA CERTIFIED are trademarks of Digital Living Network Alliance.
- "  " and "PlayStation" are registered trademarks of Sony Computer Entertainment Inc.



- Add further enjoyment with your PlayStation 3 by downloading the application for PlayStation 3 from PlayStation Store (where available.)
- The application for PlayStation 3 requires PlayStation Network account and application download. Accessible in areas where the PlayStation Store is available.
- Eye-Fi is a trademark of Eye-Fi Inc.
- In addition, system and product names used in this manual are, in general, trademarks or registered trademarks of their respective developers or manufacturers. However, the ™ or ® marks may not be specified in all cases in this manual.

[191] Troubleshooting | If you have problems | If you have problems

Troubleshooting

If you experience trouble with the product, try the following solutions.

1. Check the items under "Troubleshooting", then check the product.
If a message such as "C/E:□□:□□" appears on the screen, refer to the self-diagnosis display.
2. Remove the battery pack, wait for about one minute, re-insert the battery pack, then turn on the power.
3. Initialize the settings.
4. Consult your dealer or local authorized service facility. Additional information on this product and answers to frequently asked questions can be found at our Customer Support Website.
<http://www.sony.net/>

[192] Troubleshooting | Troubleshooting | Battery pack and power

You cannot insert the battery pack into the product.

- Make sure the direction of the battery pack is correct, and insert it until the lock lever is locked.

[193] Troubleshooting | Troubleshooting | Battery pack and power

You cannot turn on the product.

- After inserting the battery pack into the product, it may take a few moments for the product to power up.
- Make sure that the battery pack is inserted correctly.
- The battery pack will discharge by itself even if you do not use it. Charge the battery pack before use.
- Make sure that the battery is NP-BX1.

[194] Troubleshooting | Troubleshooting | Battery pack and power

The power turns off suddenly.

- Depending on the product and battery pack temperature, the product may turn off automatically to protect itself. In this case, a message is displayed on the product screen before the product turns off.
- If you do not operate the product for a certain period of time, it turns off automatically to prevent wearing down the battery pack. Turn on the product again.

[195] Troubleshooting | Troubleshooting | Battery pack and power

The remaining battery level indicator shows an incorrect

level.

- This phenomenon occurs when you use the product in an extremely hot or cold location.
 - Battery capacity decreases over time and through repeated use. If decreased usage time between charges becomes significant, it is probably time to replace it with a new one.
-

[196] Troubleshooting | Troubleshooting | Battery pack and power

The charge lamp on the product flashes when charging the battery pack.

- This phenomenon occurs when you charge the battery pack in an extremely hot or cold location. The optimum temperature for charging the battery pack is between 10 °C and 30 °C (50 °F and 86 °F).
-

[197] Troubleshooting | Troubleshooting | Battery pack and power

The battery pack has not been charged even if the charge lamp on the product has turned off.

- Make sure that the battery is NP-BX1.
 - Batteries which have not been used for more than a year may have deteriorated.
-

[198] Troubleshooting | Troubleshooting | Battery pack and power

The battery pack is not charged.

- When the battery pack is not charged (the charge lamp does not light) even if you follow the proper charging procedure, remove the battery pack and re-insert the same battery pack securely, or disconnect and reconnect the USB cable.
-

You cannot record images.

- You are using a memory card with a write-protect switch, and the switch is set to the LOCK position. Set the switch to the record position.
 - Check the free capacity of the memory card.
 - You cannot record images while charging the flash.
 - [Self-timer] is working.
-

Recording takes a long time.

- The noise reduction function is processing an image. This is not a malfunction.
 - The [Auto HDR] function is processing an image.
 - The product is compiling images.
-

The image is out of focus.

- The subject is too close. Shoot from the shortest shooting distance (W side: Approx. 1 cm (0.03 ft), T side: Approx. 240 cm (7.87 ft (from the lens))).
 - Press the shutter button halfway down, then shoot images.
 - Ambient light is insufficient.
 - The subject you are shooting is not suitable for auto-focusing. Shoot in [Flexible Spot] mode or manual focus mode.
-

Zoom does not work.

- You cannot use zoom functions during Sweep Panorama shooting.

You can use only the optical zoom in the following situations:

When using Smile Shutter function.

[Drive Mode] is set to [Self-portrait].

[203] Troubleshooting | Troubleshooting | Shooting still images/movies

The flash does not work.

- Raise the flash.
 - You cannot use a flash in the following situations:
 - [Anti Motion Blur], [Night Scene], [Hand-held Twilight], [Fireworks] or [High Sensitivity] in Scene Selection is selected.
 - During Sweep Panorama shooting.
 - During movie recording.
-

[204] Troubleshooting | Troubleshooting | Shooting still images/movies

Fuzzy white circular spots appear on images shot using the flash.

- Particles (dust, pollen, etc.) in the air reflected the flash light and appeared on the image. This is not a malfunction.
-

[205] Troubleshooting | Troubleshooting | Shooting still images/movies

The close-up shoot function (Macro) does not work.

- The product automatically adjusts the focus. Press and hold the shutter button halfway down. Focus adjustment may take some time when shooting a close subject.
 - The close-up shoot function does not work when [Adv.Sports Shooting] or [Fireworks] in Scene Selection is selected.
-

The recording date and time are not displayed on the screen.

- While shooting, the date and time are not displayed. They are displayed only during playback.

The date and time are recorded incorrectly.

- Set the correct date and time.
- The area selected using [Area Setting] differs from the actual area. Select the actual area.

The aperture value and/or shutter speed flashes.

- The subject is too bright or too dark to shoot using the current aperture value and/or shutter speed settings. Readjust the settings.

The image colors are not correct.

- Adjust [White Balance].
- [Picture Effect] is set. Set [Picture Effect] to [Off].
- To reset settings to default, perform [Setting Reset].

Noise appears in the image when you view the screen in a dark place.

- The product is attempting to increase the visibility of the screen by temporarily brightening the monitor under conditions of low illumination. There is no effect on the recorded image.
-

[211] Troubleshooting | Troubleshooting | Shooting still images/movies

Dark shadow appears on the image.

- Depending on the brightness of the subject, you may see a dark shadow when you change the aperture. This is not a malfunction.
-

[212] Troubleshooting | Troubleshooting | Shooting still images/movies

The eyes of the subject come out red.

- Set [Red Eye Reduction] to [On].
 - Shoot the subject at a distance closer than the flash range using the flash.
 - Light the room and shoot the subject.
-

[213] Troubleshooting | Troubleshooting | Shooting still images/movies

Dots appear and remain on the screen.

- This is not a malfunction. These dots are not recorded.
-

[214] Troubleshooting | Troubleshooting | Shooting still images/movies

You cannot shoot images continuously.

- The memory card is full. Delete unnecessary images.
 - The battery level is low. Insert a charged battery pack.
-

[215] Troubleshooting | Troubleshooting | Shooting still images/movies

The image is not clear in the viewfinder.

- Adjust the diopter scale properly using the diopter-adjustment dial.
-

[216] Troubleshooting | Troubleshooting | Shooting still images/movies

The image is blurred.

- Activate the SteadyShot function by pressing the shutter button halfway down and then shoot images.
 - The picture was taken in a dark location without the flash, resulting in product-shake. The use of a tripod or the flash is recommended. [Hand-held Twilight] and [Anti Motion Blur] in [Scene Selection] are also effective in reducing blur.
-

[217] Troubleshooting | Troubleshooting | Shooting still images/movies

The flash takes too long to recharge.

- The flash has been fired in succession in a short period. When the flash has been fired in succession, the recharging process may take longer than usual to avoid overheating of the camera.
-

[218] Troubleshooting | Troubleshooting | Viewing images

Images cannot be played back.

- Make sure that the memory card is fully inserted into the product.

- The folder/file name has been changed on your computer.
 - When an image file has been processed by a computer or when the image file was recorded using a model other than this product, playback on this product is not guaranteed.
 - The product is in USB mode. Disconnect the product from the computer.
 - Use PlayMemories Home to play back on this product images that are stored on your computer.
-

[219] Troubleshooting | Troubleshooting | Viewing images

The date and time are not displayed.

- The screen display is set to display images only. Press DISP (Display Setting) on the control button to display the information.
-

[220] Troubleshooting | Troubleshooting | Viewing images

The image cannot be deleted.

- Cancel the protection.
-

[221] Troubleshooting | Troubleshooting | Viewing images

The image was deleted by mistake.

- Once you have deleted an image, you cannot restore it. We recommend that you protect images that you do not want to delete.
-

[222] Troubleshooting | Troubleshooting | GPS

The product is not receiving a GPS signal. (DSC-HX400V)

- Set [GPS On/Off] to [On].

The product may not be able to receive radio signals from GPS satellites because of obstructions.

- To triangulate the location information correctly, bring the product to an open area, and turn on the product again.

[223] Troubleshooting | Troubleshooting | GPS

There is an excessive error in location information. (DSC-HX400V)

- The margin of error can be up to several-hundred meters depending on surrounding buildings, weak GPS signals, etc.

[224] Troubleshooting | Troubleshooting | GPS

It takes time to triangulate although the GPS assist data is taken in. (DSC-HX400V)

- [Date/Time Setup] has not been set, or set time differs greatly from the actual time. Set the date and time correctly.
- The term of validity of the GPS assist data has expired. Update the GPS assist data.
- As the GPS satellites move constantly, it may take longer to determine the location or the receiver may not be able to determine the location at all, depending on the location and time you use the product.
- GPS is a system for determining geographic location by triangulating radio signals from GPS satellites. Avoid using the product in places where radio signals are blocked or reflected, such as a shadowy place surrounded by buildings or trees, etc. Use the product in open sky environments.

[225] Troubleshooting | Troubleshooting | GPS

The location information has not been recorded. (DSC-HX400V)

- For importing movies with GPS location information to your computer, use PlayMemories Home.
-

[226] Troubleshooting | Troubleshooting | Wi-Fi

You cannot find the wireless access point to be connected.

- Wireless access points may not be displayed on the product due to signal conditions. Place the product closer to the wireless access point.
 - Wireless access points may not be displayed on the product depending on the access point settings. Refer to the instruction manual of the wireless access point.
-

[227] Troubleshooting | Troubleshooting | Wi-Fi

[WPS Push] does not work.

- [WPS Push] may not work depending on the access point settings. Check the SSID and password of the wireless access point, and perform [Access Point Set.].
-

[228] Troubleshooting | Troubleshooting | Wi-Fi

[Send to Computer] is canceled halfway.

- When the battery remaining level is low, [Send to Computer] may be canceled halfway. Charge the battery pack and try again.
-

[229] Troubleshooting | Troubleshooting | Wi-Fi

You cannot send movies to a smartphone.

- You cannot send AVCHD movies to a smartphone. Set [ File Format] to [MP4] to record movies.

[230] Troubleshooting | Troubleshooting | Wi-Fi

[Smart Remote Embedded] or [Send to Smartphone] is canceled halfway.

- When the remaining battery level is low, [Smart Remote Embedded] or [Send to Smartphone] may be canceled halfway. Charge the battery pack and try again.
-



[231] Troubleshooting | Troubleshooting | Wi-Fi

The shooting screen for [Smart Remote Embedded] is not displayed smoothly./The connection between this product and the smartphone is disconnected.

- Data communication between this product and the smartphone may fail due to signal conditions. Place this product closer to the smartphone.
-

[232] Troubleshooting | Troubleshooting | Wi-Fi

You cannot use One-Touch connection (NFC).

- Place the  (N mark) on the smartphone and the  (N mark) on the product as close together as possible. If there is no response, move the smartphone a few millimeters or move the smartphone away from this product, wait more than 10 seconds, and then touch them together again.
 - [Airplane Mode] is set to [On]. Set [Airplane Mode] to [Off].
 - Check whether the NFC function is activated on your smartphone. For details, refer to the instruction manual of the smartphone.
 - Do not place any metal objects other than a smartphone near the  (N mark).
 - Do not contact two or more smartphones to this product at the same time.
 - If another NFC-based application is running on your smartphone, terminate that application.
-

The computer does not recognize this product.

- Set [USB Connection] to [Mass Storage].
 - Use the micro USB cable (supplied) to connect the devices.
 - Disconnect the USB cable, and connect it again firmly.
 - Disconnect all equipment other than this product, the keyboard and the mouse from the USB terminals of your computer.
 - Connect this product directly to your computer without passing through a USB hub or other device.
 - If you set [USB Power Supply] to [Off], the computer may be able to recognize this product.
-

You cannot import images.

- Connect this product and your computer correctly making a USB connection.
 - When you shoot images with a memory card formatted by a computer, you may not be able to import the images to a computer. Shoot using a memory card formatted by this product.
-

The image and sound are interrupted by noise when viewing a movie on a computer.

- You are playing back the movie directly from the memory card. Import the movie to your computer using PlayMemories Home and play it back.
-

Images exported from a computer cannot be viewed on this product.

- Use PlayMemories Home to copy images that are stored on a computer onto a memory card inserted into this product and view them on this product.
-

[237] Troubleshooting | Troubleshooting | Memory cards

Formatted the memory card by mistake.

- All the data on the memory card is deleted by formatting. You cannot restore the data.
-

[238] Troubleshooting | Troubleshooting | Printing

Images are printed with both edges cut off.

- Depending on your printer, the left, right, top, and bottom edges of the image may be cut off. Especially when you print an image shot with [ Aspect Ratio] set to [16:9], the lateral end of the image may be cut off.
 - When printing images using your printer, cancel the trimming or borderless settings of the printer. Consult the printer manufacturer as to whether the printer provides these functions or not.
 - When you print images at a shop, ask the shop whether they can print the images without cutting off both edges.
-

[239] Troubleshooting | Troubleshooting | Printing

You cannot print images with the date.

- If you set [ Write Date] to [On], you can print still images with the date. Note that you cannot delete the date from the image on the camera.
- If you want to print images with the date, use [Print Setting] under [Specify Printing].
- You can print images with the date superimposed if the printer or the software can recognize Exif information. For compatibility with Exif information, consult the manufacturer of the printer or the software.
- Using PlayMemories Home, you can print images with the date without recording the date.
- When you print images at a shop, images can be printed with the date if you ask them to do

so.

[240] Troubleshooting | Troubleshooting | Others

The lens gets fogged.

-
- Moisture condensation has occurred. Turn off the product and leave it for about an hour before using it.

[241] Troubleshooting | Troubleshooting | Others

The product stops with the lens portion extended./The product turns off with the lens portion extended.

-
- Do not attempt to force lens that has stopped moving.
 - Insert a charged battery pack, then turn the product on again.

[242] Troubleshooting | Troubleshooting | Others

The product becomes warm when you use it for a long time.

-
- This is not a malfunction. Turn off the product and do not use it for a while.

[243] Troubleshooting | Troubleshooting | Others

The Clock Set screen appears when you turn on the product.

-
- Set the date and time again.
 - The internal rechargeable backup battery has discharged. Insert a charged battery, and set

aside for 24 hours or more with the power left off.

[244] Troubleshooting | Troubleshooting | Others

The number of recordable images does not decrease, or decreases two images at a time.

- This is because the compression rate and the image size after compression change depending on the image when you shoot a JPEG image.
-

[245] Troubleshooting | Troubleshooting | Others

The product does not work properly.

- Turn off the product. Remove the battery pack and insert it again. If the product is hot, remove the battery pack, and allow it to cool down before trying this corrective procedure.
 - If an AC-UD10/AC-UD11 AC Adaptor (sold separately) is used, disconnect the power cord. Connect the power cord and turn on the product again. If the product repeats the same error often or still does not work after trying these solutions, consult your Sony dealer or local authorized Sony service facility.
-

[246] Troubleshooting | Messages | Messages

Self-diagnosis display

If a code starting with a letter of the alphabet appears, the self-diagnosis function on this product is working. The last two digits (indicated by □□) will differ depending on the state of this product.

If you cannot solve the problem even after trying the following corrective actions a few times, this product may need repair. Contact your Sony dealer or local authorized Sony service facility.

C:32:□□

C:95:□□

- There is trouble with the product's hardware. Turn the power off and on again.

C:13:□□

- This product cannot read or write data on the memory card. Try turning off and on this product again, or taking out and inserting the memory card several times.
- An unformatted memory card is inserted. Format the memory card.
- The inserted memory card cannot be used with this product, or the data is damaged. Insert a new memory card.

E:61:□□

E:62:□□

E:91:□□

- A product malfunction has occurred. Initialize this product, then turn the power on again.

E:94:□□

- There is a malfunction when writing or deleting data. Repair is required. Contact your Sony dealer or local authorized Sony service facility. Be prepared to give all numbers in the error code beginning from the E.

[247] Troubleshooting | Messages | Messages

Warning messages

Set Area/Date/Time.

- Set the area, date and time. If you have not used the product for a long time, charge the internal rechargeable backup battery.

Unable to use memory card. Format?

- The memory card was formatted on a computer and the file format was modified. Select [Enter], and then format the memory card. You can use the memory card again, however, all previous data in the memory card is erased. It may take some time to complete the format. If the message still appears, change the memory card.

Memory Card Error

- An incompatible memory card is inserted.
- Formatting has failed. Format the memory card again.

Unable to read memory card. Reinsert memory card.

- An incompatible memory card is inserted.

- The memory card is damaged.
- The terminal section of the memory card is dirty.

This memory card may not be capable of recording and playing normally.

- An incompatible memory card is inserted.

Processing...

- When performing noise reduction, the reduction process takes place. You cannot do any further shooting during this reduction process.

Unable to display.

- Images recorded with other products or images modified with a computer may not be displayed.

Internal temp. high. Allow it to cool.

- The product has become hot because you have been shooting continuously. Turn the power off. Cool the product and wait until the product is ready to shoot again.



- You have been recording images for a long time, the product temperature has risen. Stop recording images until the product cools.

Recording is unavailable in this movie format.

- Set [ File Format] to [MP4].



- The number of images exceeds that for which date management in a database file by the product is possible.



- Unable to register to the database file. Import all the images to a computer and recover the memory card.

Image DataBase File error

- There is something wrong in the Image Database File. Select [Setup] → [Recover Image DB].

System Error

Camera Error. Turn power off then on.

- Remove the battery pack, and then re-insert it. If the message appears frequently, consult your Sony dealer or local authorized Sony service facility.

Unable to magnify.

Unable to rotate image.

- Images recorded with other products may not be enlarged or rotated.

[248] Troubleshooting | Situations this product has difficulty handling | Situations this product has difficulty handling

Situations this product has difficulty handling

The product cannot take full advantage of some features under certain circumstances. When shooting under the following conditions, either recompose the shot or change the shooting mode, then shoot the images again.

Low light conditions

- iSweep Panorama
- Lock-on AF

Overly bright conditions

- Lock-on AF

Varying levels of brightness

- Lock-on AF

Flickering lights

- iSweep Panorama

Subjects too close to the product

- iSweep Panorama

Large moving subjects or subjects that move too quickly

- Superior Auto
- iSweep Panorama
- Auto HDR
- Lock-on AF

Subjects too small or too large

- iSweep Panorama
- Lock-on AF

Scenes with little contrast, such as the sky or a sandy beach

- iSweep Panorama
- Superior Auto

Scenes changing constantly, such as a waterfall

- iSweep Panorama
- Superior Auto