

Digital Video Camera Recorder ^{Mini DV} Digital Cassette

Operating Instructions

Before operating the unit, please read this manual thoroughly, and retain it for future reference.

Owner's Record

The model and serial numbers are located on the bottom. Record the serial number in the space provided below. Refer to these numbers whenever you call upon your Sony dealer regarding this product.

Model No. **DCR-PC3**

Model No. **AC-**_____

Serial No. _____ Serial No. _____

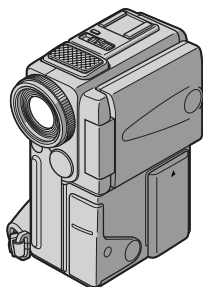

Digital Handycam



C/M Cassette
Memory



DCR-PC3

Welcome!

Congratulations on your purchase of this Sony Digital Handycam camcorder. With your Digital Handycam, you can capture life's precious moments with superior picture and sound quality. Your Digital Handycam is loaded with advanced features, but at the same time it is very easy to use. You will soon be producing home video that you can enjoy for years to come.

WARNING

To prevent fire or shock hazard, do not expose the unit to rain or moisture.

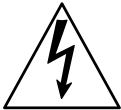
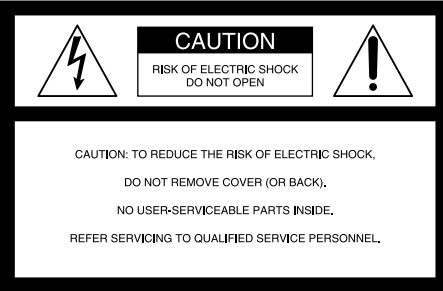

This symbol is intended to alert the user to the presence of uninsulated "dangerous voltage" within the product's enclosure that may be of sufficient magnitude to constitute a risk of electric shock to persons.



This symbol is intended to alert the user to the presence of important operating and maintenance (servicing) instructions in the literature accompanying the appliance.

Never expose the battery pack to temperatures above 140°F (60°C) such as in a car parked in the sun or under direct sunlight.

For customers in CANADA

DISPOSAL OF LITHIUM ION BATTERY.

LITHIUM ION BATTERY. DISPOSE OF PROPERLY.

You can return your unwanted lithium ion batteries to your nearest Factory Service Center.

Note: In some areas the disposal of lithium ion batteries in household or business trash may be prohibited.

For the Sony Factory Service Center nearest you call 416-499-SONY (Canada only)

Caution: Do not handle damaged or leaking lithium ion battery.

For customers in CANADA

CAUTION

TO PREVENT ELECTRIC SHOCK, MATCH WIDE BLADE OF PLUG TO WIDE SLOT, FULLY INSERT.

"Memory Stick"

For customers in CANADA

This Class B digital apparatus complies with Canadian ICES-003.

Battery pack

For customers in CANADA

THIS CLASS [B] DIGITAL APPARATUS COMPLIES WITH CANADIAN ICES-003.

CET APPAREIL NUMÉRIQUE DE LA CLASSE [B] EST CONFORME À LA NORME NMB-003 DU CANADA.

Table of contents

Quick Start Guide	4
-------------------------	---

Getting started

Using this manual	6
Checking supplied accessories	8
Step 1 Preparing the power supply	9
Charging the battery pack	9
Installing the battery pack	12
Connecting to a wall outlet	13
Step 2 Inserting a cassette	14
Step 3 Using a touch panel	15

Recording – Basics

Recording a picture	17
Shooting backlit subjects (BACK LIGHT)	23
Shooting in the dark (NightShot)	23
END SEARCH	25

Playback – Basics

Playing back a tape	26
Viewing the recording on TV	30

Advanced Recording Operations

Photo recording	31
Using the wide mode	33
Using the fader function	34
Using special effects – Picture effect ..	37
Using special effects – Digital effect ...	39
Adjusting the white balance manually	42
Using the PROGRAM AE function	43
Adjusting the exposure manually	45
Focusing manually	46

Advanced Playback Operations

Playing back a tape with picture effects	47
Playing back a tape with digital effects	48
Quickly locating a scene using the zero set memory function	49
Searching a recording by date – Date search	50
Searching the boundaries of recorded tape by title – Title search	52
Searching for a photo – Photo search/ Photo scan	53

Editing

Dubbing a tape	55
Editing partially on a DV tape – DV synchro-editing	57
Recording video or TV programs	59

Inserting a scene from a VCR	63
Audio dubbing	65
Superimposing a title	69
Making your own titles	72
Labeling a cassette	74

Customizing Your Camcorder

Changing the menu settings	76
Resetting the date and time	82

“Memory Stick” operations

Using a “Memory Stick” – introduction	83
Recording still images on “Memory Stick”s – Memory photo recording	90
Superimposing a still picture in a “Memory Stick” on a moving picture – MEMORY MIX	93
Recording an image from a mini DV tape as a still image	96
Copying still images from a mini DV tape – Photo save	98
Viewing a still picture – Memory photo playback	100
Playing back images in a continuous loop – SLIDE SHOW	104
Preventing accidental erasure – Image protection	105
Deleting images	106
Writing a print mark – PRINT MARK	109

Additional Information

Using the viewfinder	110
Usable cassettes	111
Troubleshooting	113
Self-diagnosis display	118
Warning indicators and messages	119
Using your camcorder abroad	121
Maintenance information and precautions	122
Specifications	127

Quick Reference

Identifying the parts and controls	128
Quick Function Guide	135
Index	Back cover

- Windows is registered trademarks licensed to Microsoft Corporation, registered in the U.S.A. and other countries.
 - All other product names mentioned herein may be the trademarks or registered trademarks of their respective companies.
- Furthermore, “TM” and “®” are not mentioned in each case in this manual.

Quick Start Guide



This chapter introduces you to the basic features of your camcorder. See the page in parentheses “()” for more information.

1 Connecting the power cord (p. 13)

Use the battery pack when using your camcorder outdoors (p. 12).

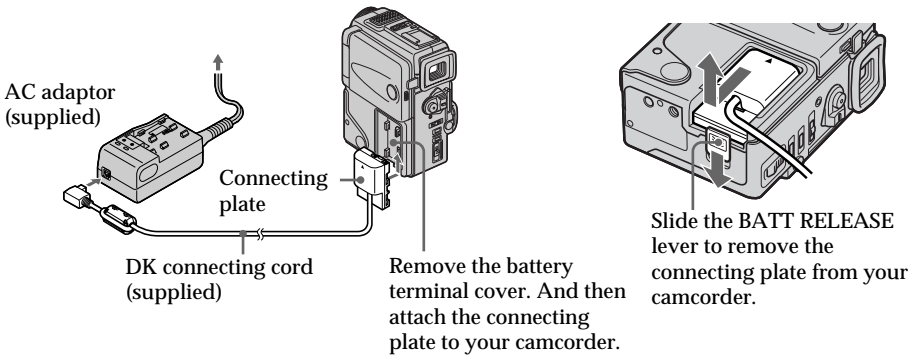

2 Inserting a cassette (p. 14)

- 1 Slide OPEN/▲EJECT in the direction of the arrow and open the lid.

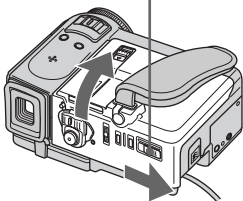

- 2 Push the middle portion of the back of the cassette to insert. Insert the cassette in a straight line deeply into the cassette compartment with the window facing out.

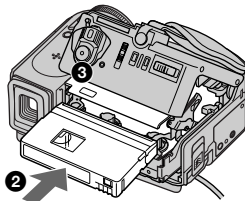

- 3 Close the cassette compartment by pressing the PUSH mark on the cassette compartment.
- 4 After the cassette compartment going down completely, close the lid until it clicks.

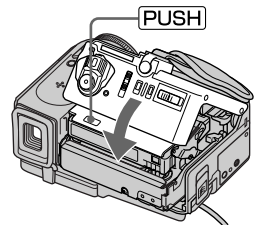

3

Recording a picture (p. 17)

- 1 Remove the lens cap.

Viewfinder

When the LCD panel is closed, pull out the viewfinder until it clicks. Use the viewfinder placing your eye against its eyecup.

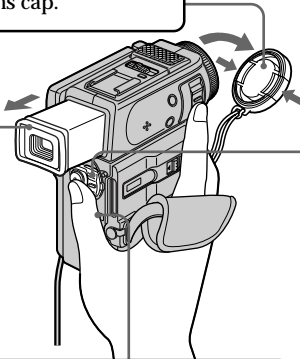

- 2 Set the START/STOP MODE switch to .



- 3 Set the POWER switch to CAMERA while pressing the small green button. The power lamp lights up.

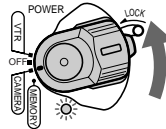

- 4 Press START/STOP. Your camcorder starts recording. To stop recording, press START/STOP again.

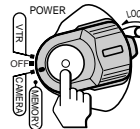

4

Monitoring the playback picture on the LCD screen (p. 26)

- 1 Set the POWER switch to VTR while pressing the small green button.

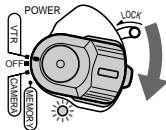

- 2 Press OPEN to OPEN the LCD panel.

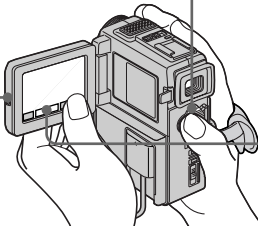

- 3 Press of the touch panel to rewind the tape.



- 4 Press of the touch panel to start playback.



NOTE

When using the touch panel, press operation buttons lightly with your thumb supporting the LCD screen from the backside of it. Do not press the LCD screen with sharp-pointed objects such as pens.

NOTE

Do not pick up your camcorder by holding the viewfinder, the LCD panel or the battery pack.

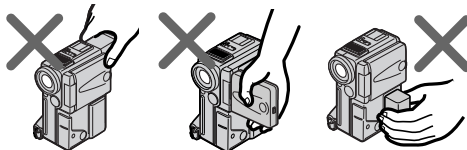

Using this manual

As you read through this manual, buttons and settings on your camcorder are shown in capital letters.

e.g. Set the POWER switch to CAMERA.

When you carry out an operation, you can hear a beep sound to indicate that the operation is being carried out.

Note on Cassette Memory

Your camcorder is based on the DV format. You can only use mini DV cassettes with your camcorder. We recommend that you use a tape with cassette memory **CM**.

The functions which require different operations depending on whether the tape has the cassette memory or not are:

- End search (p. 25, 29)
- Searching a recording by date – date search (p. 50)
- Photo search (p. 53).

The functions you can operate only with the cassette memory are:

- Searching the boundaries of recorded tape by title – title search (p. 52)
- Superimposing a title (p. 69)
- Making your own titles (p. 72)
- Labeling a cassette (p. 74).

For details, see page 111.

CM only You see this mark in the introduction of the features that operate only with cassette memory.

Tapes with cassette memory are marked by **CM** (Cassette Memory).

Using this manual

Note on TV color systems

TV color systems differ from country to country. To view your recordings on a TV, you need an NTSC system-based TV.

Copyright precautions

Television programs, films, video tapes, and other materials may be copyrighted. Unauthorized recording of such materials may be contrary to the provision of the copyright laws.

Precautions on camcorder care

- The LCD screen and/or the color viewfinder are manufactured using high-precision technology. However, there may be some tiny black spots and/or bright spots (red, blue or green in color) that constantly appear on the LCD screen and/or in the color viewfinder. These spots occur normally in the manufacturing process and do not affect the recorded picture in any way. Effective number of pixels is 99.99% or more.
- Do not let your camcorder get wet. Keep your camcorder away from rain and sea water. Letting your camcorder get wet may cause your camcorder to malfunction. Sometimes this malfunction cannot be repaired [a].
- Never leave your camcorder exposed to temperatures above 140°F (60°C), such as in a car parked in the sun or under direct sunlight [b].
- Do not place your camcorder so as to point the viewfinder or the LCD screen toward the sun. The inside of the viewfinder or LCD screen may be damaged [c].

[a]



[b]

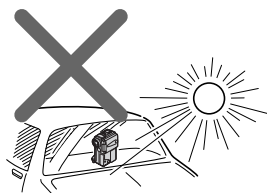

[c]

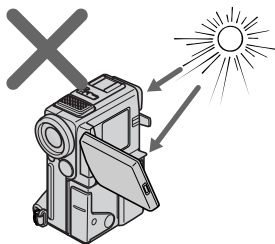

Contents of the recording cannot be compensated if recording or playback is not made due to a malfunction of the camcorder, video tape, etc.

Checking supplied accessories

Make sure that the following accessories are supplied with your camcorder.

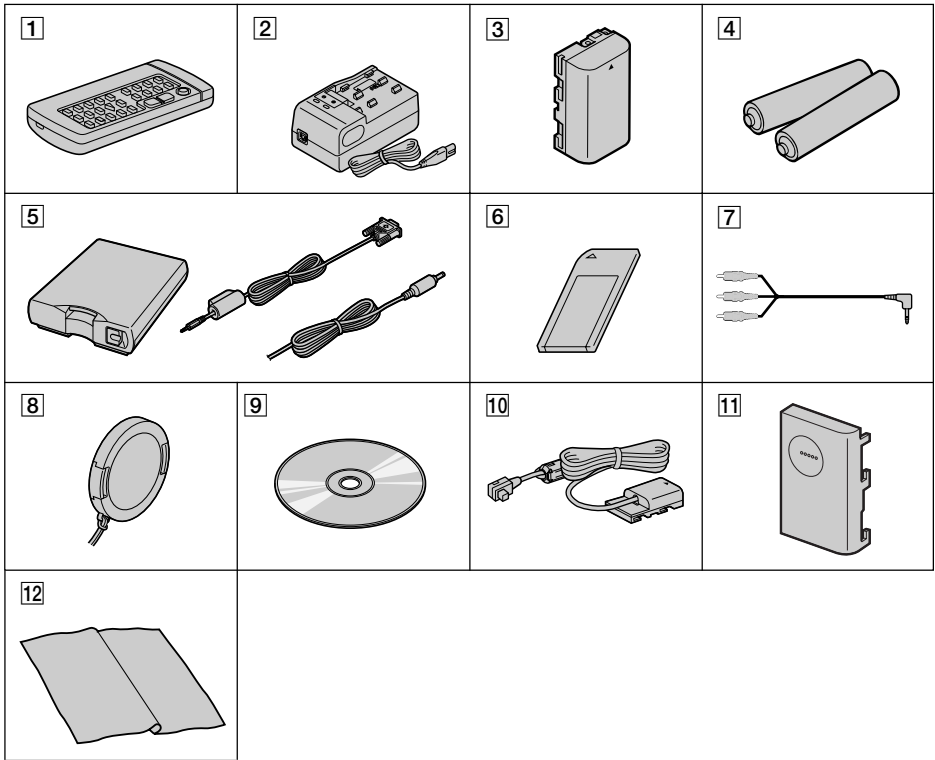

- 1** RMT-811 Wireless Remote Commander (1) (p. 133)
- 2** AC-VF10 power adaptor (1), Power cord (1) (p. 9)
- 3** NP-FS11 battery pack (1) (p. 9, 12)
- 4** Size AA (R6) battery for Remote Commander (2) (p. 133).
- 5** Serial port adaptor for "Memory Stick" (1), PC serial cable (1), AC adaptor for Serial port adaptor (1) (p. 103)
- 6** "Memory Stick" (1) (p. 83)
- 7** A/V connecting cable (1) (p. 30, 59)
- 8** Lens cap (1) (p. 17)
- 9** Application software: PictureGear 3.2Lite (CD ROM) (1) (p. 103)
- 10** DK-115 Connecting cord (1) (p. 13)
- 11** Battery terminal cover (1) (p. 12)
- 12** Cleaning cloth (1) (p. 123)

Step 1 Preparing the power supply

Charging the battery pack

Use the battery pack after charging it for your camcorder.
Your camcorder operates only with the “InfoLITHIUM” battery pack (S series).

“InfoLITHIUM” is a trademark of Sony Corporation.

- (1) Connect the power cord to the AC adaptor.
- (2) Align the hooks of the battery pack with the AC adaptor. Then fit the battery pack in the direction of the arrow.
- (3) Connect the power cord to a wall outlet. The CHARGE lamp (orange) lights up. Charging begins.

When the CHARGE lamp goes out, **normal charge** is completed. For **full charge**, which allows you to use the battery longer than usual, leave the battery pack in place for approximately one hour after the CHARGE lamp goes out.

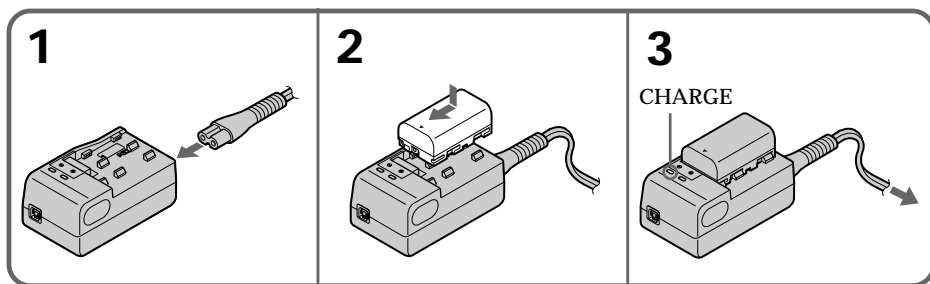

Charging time

Battery pack	Full charge (Normal charge)
NP-FS11 (supplied)	170 (110)
NP-FS21	265 (205)
NP-FS31	360 (300)
NP-F10	145 (85)
NP-F20	220 (160)
NP-F30	295 (235)

Approximate number of minutes to charge an empty battery pack

Step 1 Preparing the power supply

Recording time

Battery pack	Recording with the viewfinder		Recording with the LCD screen	
	Continuous*	Typical**	Continuous*	Typical**
NP-FS11 (supplied)	70 (60)	35 (30)	55 (50)	30 (25)
NP-FS21	150 (135)	85 (70)	120 (110)	60 (55)
NP-FS31	235 (210)	120 (105)	185 (170)	95 (85)
NP-F10	60 (50)	30 (25)	45 (40)	25 (20)
NP-F20	120 (105)	65 (55)	95 (85)	50 (40)
NP-F30	175 (160)	90 (80)	140 (125)	70 (60)

Approximate number of minutes when you use a fully charged battery

Numbers in parentheses “ () ” indicate the time using a normally charged battery.

* Approximate continuous recording time at 77°F (25°C). The battery life will be shorter if you use your camcorder in a cold environment.

** Approximate number of minutes when recording while you repeat recording start/stop, zooming and turning the power on/off. The actual battery life may be shorter.

Playing time

Battery pack	Playing time on LCD screen	Playing time with LCD closed
	NP-FS11 (supplied)	60 (50)
NP-FS21	130 (115)	165 (145)
NP-FS31	200 (145)	250 (235)
NP-F10	50 (45)	60 (55)
NP-F20	100 (90)	130 (115)
NP-F30	150 (135)	190 (170)

Approximate number of minutes when you use a fully charged battery

Numbers in parentheses “ () ” indicate the time using a normally charged battery. The battery life will be shorter if you use your camcorder in a cold environment.

Step 1 Preparing the power supply

To remove the battery pack

Slide the battery pack in the direction of the arrow.

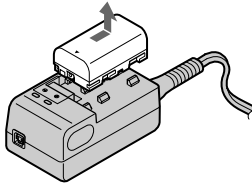

Note on NP-F10/FS11

The battery life will be shorter when you carry out recording in a cold place or with the LCD panel opened. We recommend that you use the NP-FS21/FS31 large capacity battery pack (not supplied).

If there is a slight difference in shape between the plug of power cord and the terminal of AC power adaptor

It is ignorable for their mutual connection and power supply.

Plug the power cord deeply

Be sure to plug the power cord deeply into the terminal of AC power adaptor so that it is firmly locked. If there is a gap between the plug of power cord and the terminal of AC power adaptor, it does not affect the efficiency of the AC power adaptor.

What is "InfoLITHIUM"?

The "InfoLITHIUM" is a lithium ion battery pack which can exchange data such as battery consumption with compatible video equipment. This unit is compatible with the "InfoLITHIUM" battery pack (S series). Your camcorder operates only with the "InfoLITHIUM" battery. "InfoLITHIUM" S series battery packs have the  mark.

"InfoLITHIUM" is a trademark of Sony Corporation.

Step 1 Preparing the power supply

Installing the battery pack

Install the battery pack to use your camcorder outdoors.

- (1) While sliding BATT RELEASE in the direction of the arrow ①, slide the battery terminal cover in the direction of the arrow ②.
- (2) Insert the battery pack in the direction of the arrow.

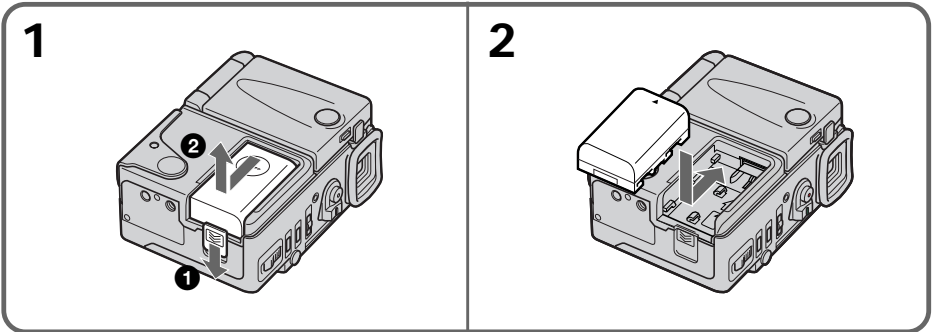

To remove the battery pack

The battery pack is removed in the same way as the battery terminal cover.

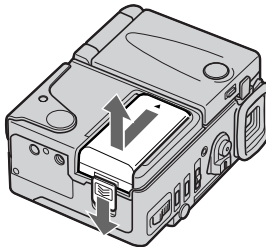

Note on the remaining battery time indicator

The remaining battery time indicator on the LCD screen or in the viewfinder roughly indicates the recording time. The indicator may not be correct, depending on the conditions in which you recording. When you close the LCD panel and open it again, it takes about 1 minute for the correct remaining battery time to be displayed.

Note on battery terminal cover

To protect the battery terminals, install the battery terminal cover after the battery pack is removed.

Step 1 Preparing the power supply

Connecting to a wall outlet

When you use your camcorder for a long time, we recommend that you power it from a wall outlet using the AC adaptor.

- (1) Connect the supplied connecting cord to the DC OUT jack on the AC adaptor.
- (2) Slide the connecting plate in the direction of the arrow.
- (3) Connect the power cord to the AC adaptor.
- (4) Connect the power cord to a wall outlet.

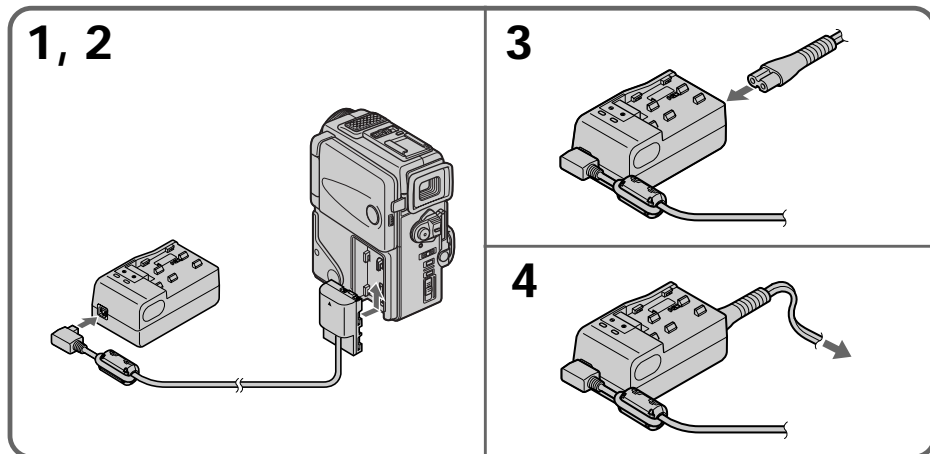

To remove the connecting plate

The connecting plate is removed in the same way as the battery pack.

WARNING

The power cord must only be changed at a qualified service shop.

PRECAUTION

The set is not disconnected from the AC power source (house current) as long as it is connected to the wall outlet, even if the set itself has been turned off.

Note

Keep the AC adaptor away from your camcorder if the picture is disturbed.

Using a car battery

Use Sony DC Adaptor/Charger (not supplied).

Step 2 Inserting a cassette

- (1) Prepare the power supply (p. 9).
- (2) Slide OPEN/▲EJECT in the direction of the arrow and open the lid. The cassette compartment automatically lifts up and opens.
- (3) Push the middle portion of the back of the cassette to insert. Insert the cassette in a straight line deeply into the cassette compartment with the window facing out.
- (4) Close the cassette compartment by pressing the **PUSH** mark on the cassette compartment. The cassette compartment automatically goes down.
- (5) After the cassette compartment going down completely, close the lid until it clicks.

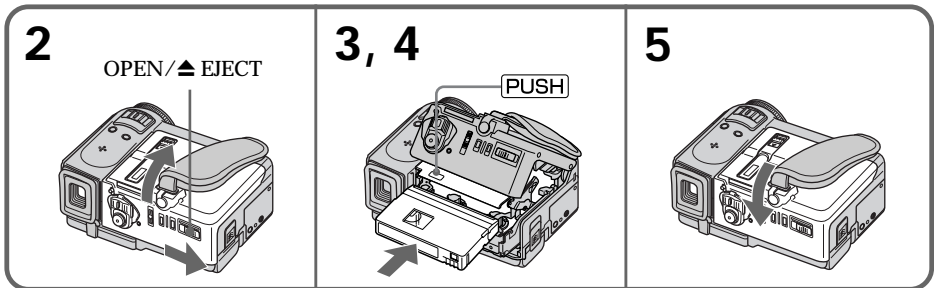

To eject a cassette

Follow the procedure above, and take out the cassette in step 3.

Notes

- Do not press the cassette compartment down. Doing so may cause malfunction.
- The cassette compartment may not be closed when you press any part of the lid other than the **PUSH** mark.

When you use mini DV cassette with cassette memory

Read the instruction about cassette memory to use this function properly (p. 111).

To prevent misoperation of your camcorder

Set the POWER switch to OFF when you insert and eject a cassette.

To prevent accidental erasure

Slide the write-protect tab on the cassette to expose the red mark.

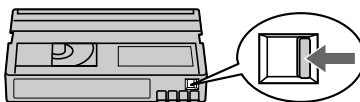

Step 3 Using a touch panel

Your camcorder has operation buttons on the LCD screen. Touch the LCD panel directly to operate each function.

In the recording/playback mode

- (1) Prepare the power supply (p. 9).
- (2) Set the POWER switch to CAMERA (in the recording mode)/VTR (in the playback mode) while pressing the small green button.
- (3) Press OPEN to open the LCD panel.
- (4) Press FN. Operation buttons appear on the LCD screen.
- (5) Press PAGE2 to go to PAGE2. Operation buttons appear on the LCD screen.
- (6) Press a desired operation item. Refer to relevant pages for each function.

Getting started

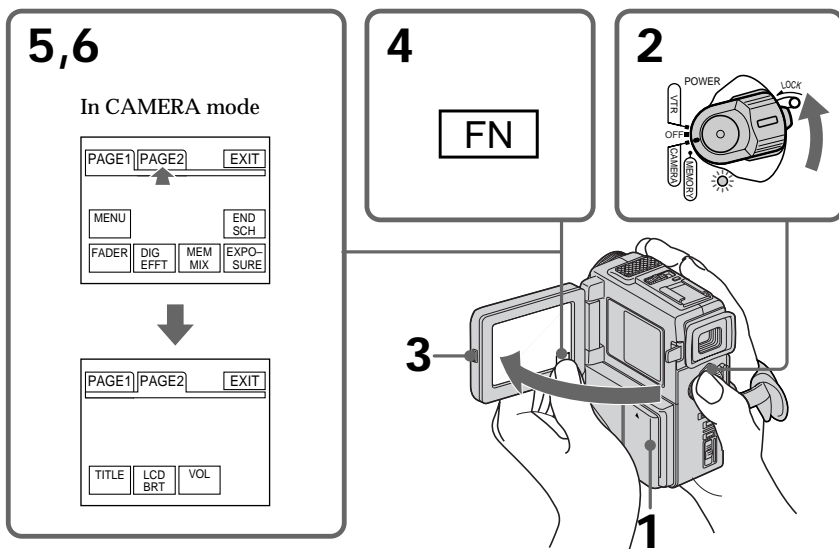

To return to FN

Press EXIT.

To execute settings

Press EXEC or ↵ OK.

To cancel settings

Press ↵ OFF to return to PAGE1/PAGE2.

Step 3 Using a touch panel

Notes

- When using the touch panel, press operation buttons with your thumb supporting the LCD screen from the back side of it or press those buttons lightly with your index finger. Do not press them with sharp-pointed objects such as pens.
- Do not touch the LCD screen with wet hands.
- If FN is not on the LCD screen, touch the LCD screen lightly to make it appear. You can control the display with DISPLAY/TOUCH PANEL on your camcorder.
- When operation buttons do not work even if you press them, an adjustment is required (CALIBRATION) (p. 124).

When executing each item

The green bar appears above the item.

If the items are not available

The color of items changes to gray.

Touch panel

You can operate with the touch panel using the viewfinder (p. 110).

Press FN to display the following buttons:

In CAMERA mode

PAGE1	MENU, END SEARCH, FADER, DIGITAL EFFECT, MEMORY MIX, EXPOSURE
PAGE2	TITLE, LCD BRIGHT, VOLUME

In VTR mode

PAGE1	MENU, LCD BRIGHT, VOLUME, END SEARCH
PAGE2	TITLE, DIGITAL EFFECT, REC CONTROL

See p. 86 for MEMORY mode.

Recording a picture

Your camcorder automatically focuses for you.

- (1) Remove the lens cap and pull the lens cap string to fix it.
- (2) Install the power source and insert a cassette. See “Step 1” and “Step 2” for more information (p. 9 to p. 14).
- (3) Pull out the viewfinder until it clicks.
- (4) Set the POWER switch to CAMERA while pressing the small green button. The power lamp under the POWER switch flashes, and then your camcorder is set to the standby mode. (It takes about five seconds.)
- (5) Press START/STOP. Your camcorder starts recording. The “REC” indicator appears. The camera recording lamp located on the front of your camcorder lights up. To stop recording, press START/STOP again.

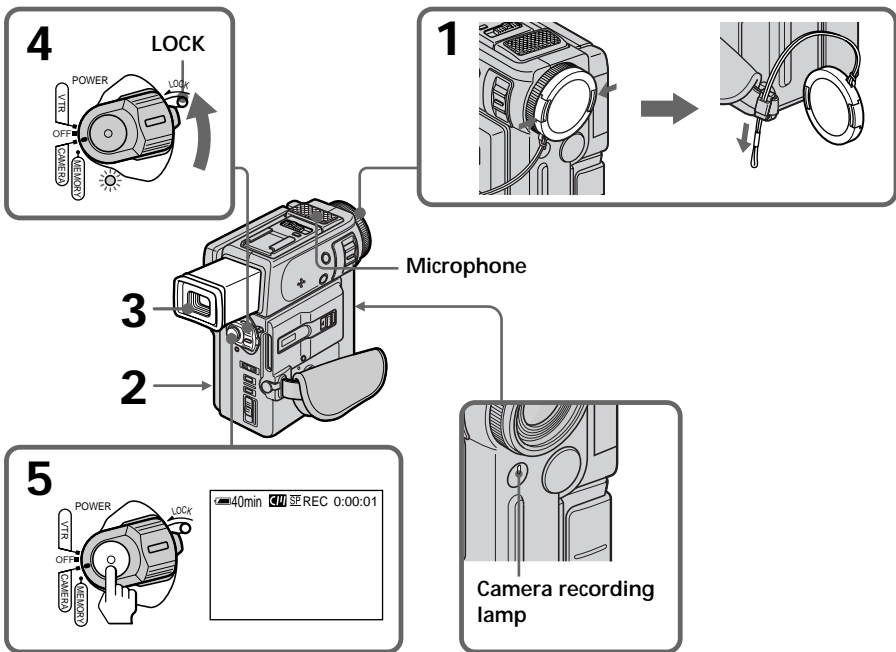

After recording

- (1) Set the POWER switch to OFF.
- (2) Set the viewfinder back to the previous position.
- (3) Eject the cassette.
- (4) Remove the battery pack.

Recording a picture

Notes

- Fasten the grip strap firmly. Do not touch the built-in microphone during recording.
- When the viewfinder is not pull out until it clicks, the picture does not appear in the viewfinder even if the LCD panel is closed.

Note on Recording mode

Your camcorder records and plays back in the SP (standard play) mode and in the LP (long play) mode. Select SP or LP in the menu settings. (p. 76) In the LP mode, you can record 1.5 times as long as in the SP mode. The picture is not distorted.

When you record a tape in the LP mode on your camcorder, we recommend playing the tape on your camcorder.

While the POWER lamp is flashing

Images do not appear on the LCD screen or in the viewfinder.

Note on the LOCK

When you slide the LOCK to the left, the POWER switch can no longer be set to MEMORY accidentally. The LOCK is set to the right as a default setting.

To enable smooth transition

Transition between the last scene you recorded and the next scene is smooth as long as you do not eject the cassette even if you turn off your camcorder. When you change the battery pack, set the POWER switch to OFF.

When you use a tape with cassette memory, however, you can make the transition smooth even after ejecting the cassette if you use the END SEARCH function (p. 25).

If you leave your camcorder in the standby mode for 5 minutes while the cassette is inserted

Your camcorder automatically turns off. This is to save battery power and to prevent battery and tape wear. To resume the standby mode, set the POWER switch to OFF, and to CAMERA again.

When you record in the SP and LP modes on one tape or you record in the LP mode

- The transition between scenes is not smooth.
- The playback picture may be distorted or the time code may not be written properly between scenes.

Recording a picture

Adjusting the viewfinder

If you record pictures with the LCD panel closed, check the picture with the viewfinder. Adjust the viewfinder lens to your eyesight so that the indicators in the viewfinder come into sharp focus.

Pull out the viewfinder and move the viewfinder lens adjustment lever.

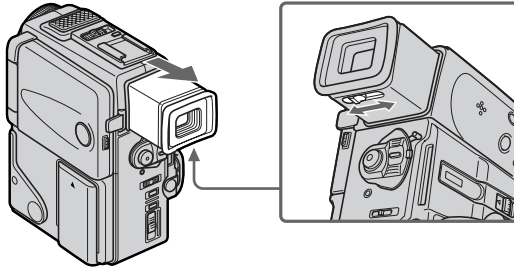

Note

When the viewfinder is not pulled out until it clicks, the picture does not appear in the viewfinder.

Shooting with the LCD screen

Press OPEN to open the LCD panel.

The LCD panel moves about 90 degrees to the viewfinder side and about 180 degrees to the lens side.

If you turn the LCD panel over so that it faces the other way, the ☺ indicator appears in the viewfinder and on the LCD screen (**Mirror mode**).

When closing the LCD panel, set it vertically until it clicks, and swing it into the camcorder body.

Note

Shooting with the LCD screen makes battery life shorter than using the viewfinder.

Recording a picture

Adjusting the brightness of the LCD screen

- (1) In the standby/recording mode, press FN and select PAGE2 (p. 15).
- (2) Press LCD BRT. The screen to adjust the brightness of the LCD screen appears.
- (3) Adjust the brightness of the LCD screen using -/+.
- : to dim
+ : to brighten
- (4) Press ↵OK to return to PAGE1/PAGE2.

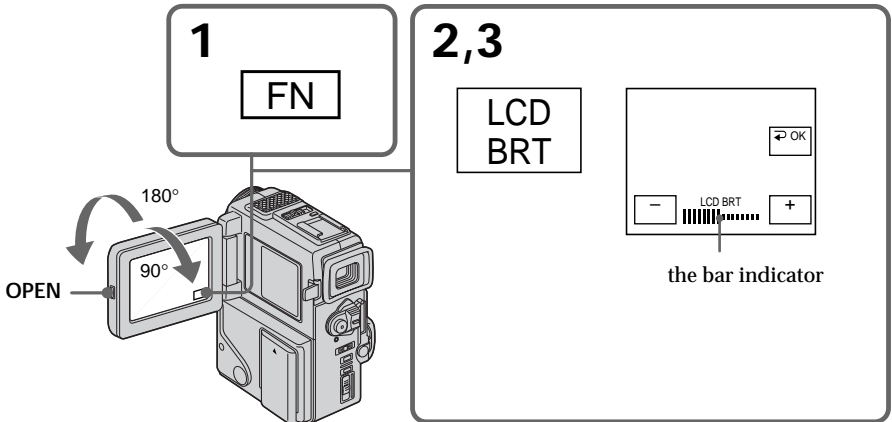

To return to FN

Press EXIT.

Note

When using the LCD screen except in the mirror mode, the viewfinder automatically turns off.

When you use the LCD screen outdoors in direct sunlight

The LCD screen may be difficult to see. If this happens, we recommend that you use the viewfinder.

When you adjust angles of the LCD panel

Make sure if the LCD panel is opened up to 90 degrees.

Picture in the mirror mode

The picture on the LCD is a mirror-image. However, the picture will be normal when recorded.

During recording in the mirror mode

ZERO SET MEMORY on the Remote Commander does not work.

Indicators in the mirror mode

The STBY indicator appears as ■● and REC as ●. Some of the other indicators appear mirror-reversed and others are not displayed.

When you press FN

The ☺ does not appear on the LCD screen or in the viewfinder.

LCD screen backlight

You can change the brightness of the backlight. Select LCD B.L. in the menu settings (p. 76).

Even if you adjust the LCD screen backlight or brightness of the LCD screen

The recorded picture will not be affected.

Recording a picture

Using the zoom feature

Move the power zoom lever a little for a slower zoom. Move it further for a faster zoom. Using the zoom function sparingly results in better-looking recordings.

“T” side: for telephoto (subject appears closer)

“W” side: for wide-angle (subject appears farther away)

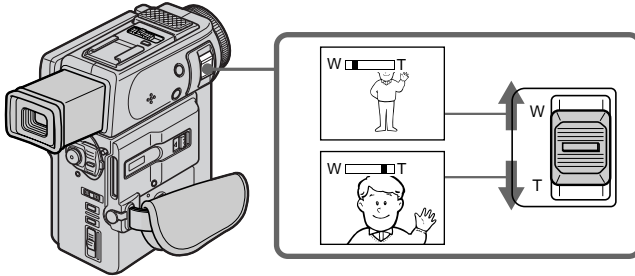

Zoom greater than 10× is performed digitally, if you set D ZOOM to ON in the menu settings. The digital zoom function is set to OFF as a default setting (p. 76).

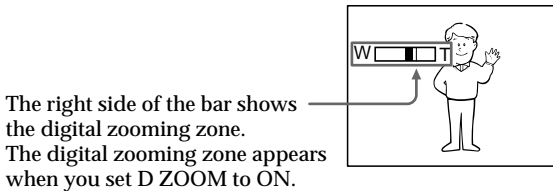

The right side of the bar shows the digital zooming zone. The digital zooming zone appears when you set D ZOOM to ON.

When you shoot close to a subject

If you cannot get a sharp focus, move the power zoom lever to the “W” side until the focus is sharp. You can shoot a subject that is at least about 2 feet 5/8 inch (about 80 cm) away from the lens surface in the telephoto position, or about 1/2 inch (about 1 cm) away in the wide-angle position.

Notes on digital zoom

- Digital zoom starts to function when zoom exceeds 10×.
- The picture quality deteriorates as you go toward the “T” side. Set D ZOOM to OFF in the menu settings. Otherwise the digital zoom activates without notice (p. 76).

Recording a picture

START/STOP MODE setting

- : Recording starts when you press START/STOP, and stops when you press it again (default setting).
- ANTI GROUND SHOOTING : Your camcorder records only while you press START/STOP. Use this mode to avoid recording unnecessary scenes.
- 5SEC: When you press use this mode to START/STOP, your camcorder records for 5 seconds and then stops automatically.

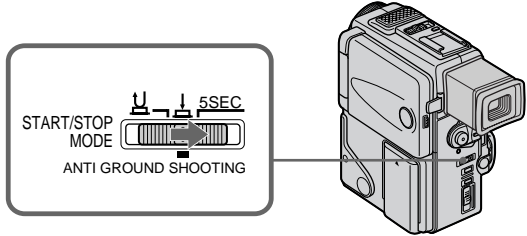

Notes

- You cannot use the fader function in the 5SEC or mode.
- The time code does not appear in the 5SEC mode.

To extend the recording time in the 5SEC mode

Five dots (●●●●●) appear, and then disappear at a rate of one per second. To extend the recording time, press START/STOP again before all the dots disappear. Recording continues for about 5 seconds from the moment you press START/STOP.

Indicators displayed in the recording mode

The indicators are not recorded on tape.

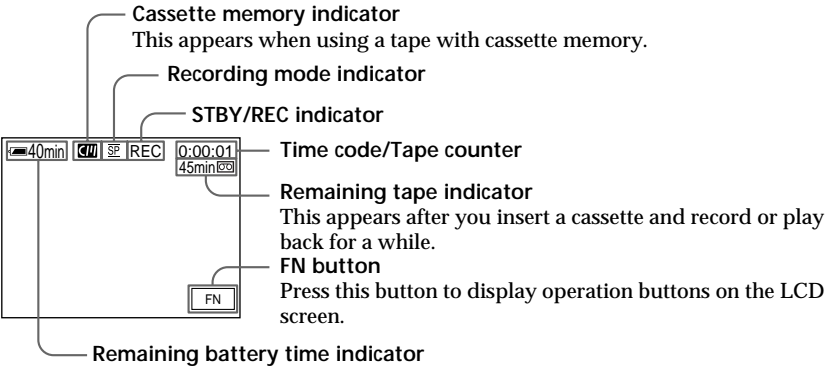

Time code

The time code indicates the recording or playback time, "0:00:00" (hours : minutes : seconds) in CAMERA mode and "0:00:00:00" (hours : minutes : seconds : frames) in VTR mode. You cannot rewrite only the time code.

Remaining tape indicator

The indicator may not be displayed accurately depending on the tape.

Recording date and time

Recording date and time will not be displayed on the LCD screen during recording. It is recorded on the tape automatically and displayed when you press the DATA CODE button on the remote commander during playing back.

Recording a picture

Shooting backlit subjects (BACK LIGHT)

When you shoot a subject with the light source behind the subject or a subject with a light background, use the backlight function.

Press BACK LIGHT in the recording or standby mode.

The  indicator appears in the viewfinder or on the LCD screen.

To cancel, press BACK LIGHT again.

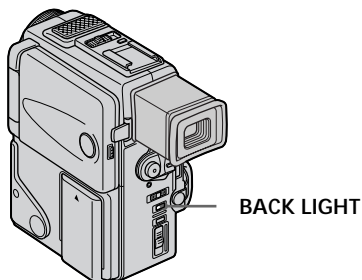

If you press EXPOSURE and MANUAL when shooting backlit subjects

The backlight function will be canceled.

Shooting in the dark (NightShot)

The NightShot function enables you to shoot a subject in a dark place. For example, you can satisfactorily record the environment of nocturnal animals for observation when you use this function.

While your camcorder is in the standby mode, slide NIGHTSHOT to ON.



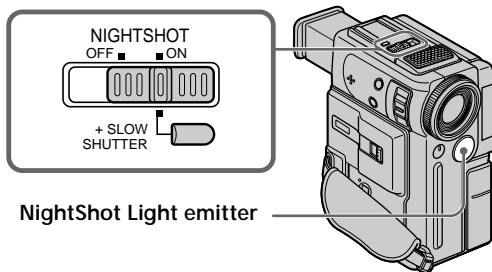

 and "NIGHTSHOT" indicators flash on the LCD screen or in the viewfinder. To cancel the NightShot function, slide NIGHTSHOT to OFF.



Recording a picture

Using +SLOW SHUTTER

The NightShot +Slow shutter mode makes subjects more than four times brighter than those recorded in the NightShot mode.

- (1) Slide NIGHTSHOT to ON in the standby mode.  indicator appears in the viewfinder or on the LCD screen.
- (2) Press +SLOW SHUTTER until the desired NIGHTSHOT indicator flashes.
The indicator changes as follows:
 (NIGHTSHOT) →  (NIGHTSHOT1) →  (NIGHTSHOT2) →  (NIGHTSHOT)
To cancel the NightShot +Slow shutter mode, slide NIGHTSHOT to OFF.

Using the NightShot Light

The picture will be clearer with the NightShot Light on. To enable NightShot Light, set N.S.LIGHT to ON in the menu settings (p. 76).

Notes



- Do not use the NightShot function in bright places (ex. outdoors in the daytime). This may cause your camcorder to malfunction.
- When you keep NIGHTSHOT set to ON in normal recording, the picture may be recorded in incorrect or unnatural colors.
- If focusing is difficult with the autofocus mode when using the NightShot function, focus manually.
- Do not cover the NightShot Light emitter when using the NightShot function.

While using the NightShot function, you cannot use the following functions:

- Exposure
- PROGRAM AE
- White balance
- Fader*
- Digital effect*

* You cannot use these functions only in the NightShot +Slow shutter mode.

Shutter speed in the NightShot +Slow shutter mode

Indicator	Shutter speed
 (NIGHTSHOT1)	1/15
 (NIGHTSHOT2)	1/4

The +SLOW SHUTTER button does not work:

- while the fader function is set or in use
- while the digital effect function is in use
- when NIGHTSHOT is set to OFF
- in the MEMORY mode

NightShot Light

NightShot Light rays are infrared and so are invisible. The maximum shooting distance using the NightShot Light is about 10 feet (3 m). The shooting distance will be twice or more in the NightShot +Slow shutter mode.

When recording in the mirror mode using NP-F10/FS11 battery
NightShot Light does not work.

END SEARCH

You can go to the end of the recorded section after you record.

(1) In the standby mode, press FN to display PAGE1 (p. 15).

(2) Press END SCH.

The last 5 seconds of the recorded section are played back and playback stops. You can monitor the sound from the speaker or headphones.

To return to FN

Press EXIT.

To stop searching

Press END SCH again.



End search function

When you use a tape without cassette memory, the end search function does not work once you eject the cassette after you have recorded on the tape. If you use a tape with cassette memory, the end search function works even once you eject the cassette.

If there is a blank portion in the recorded portion, the end search function may not work correctly (p. 111).

Playing back a tape

You can monitor the playback picture on the LCD screen. You can control playback using the Remote Commander supplied with your camcorder.

- (1) Install the power source and insert the recorded tape.
- (2) Press OPEN to open the LCD panel.
- (3) Set the POWER switch to VTR while pressing the small green button. The power lamp lights up.
- (4) Press  to rewind the tape.
- (5) Press  to start playback.
- (6) Adjust the volume following the steps below.
 - ① Press FN to make PAGE1 appear (p. 15).
 - ② Press VOL. The screen to adjust volume appears.
 - ③ Press -/+ to adjust the volume.
 - : to make the volume down
 - + : to make the volume up
- (7) Press  OK. to return to PAGE1/PAGE2.

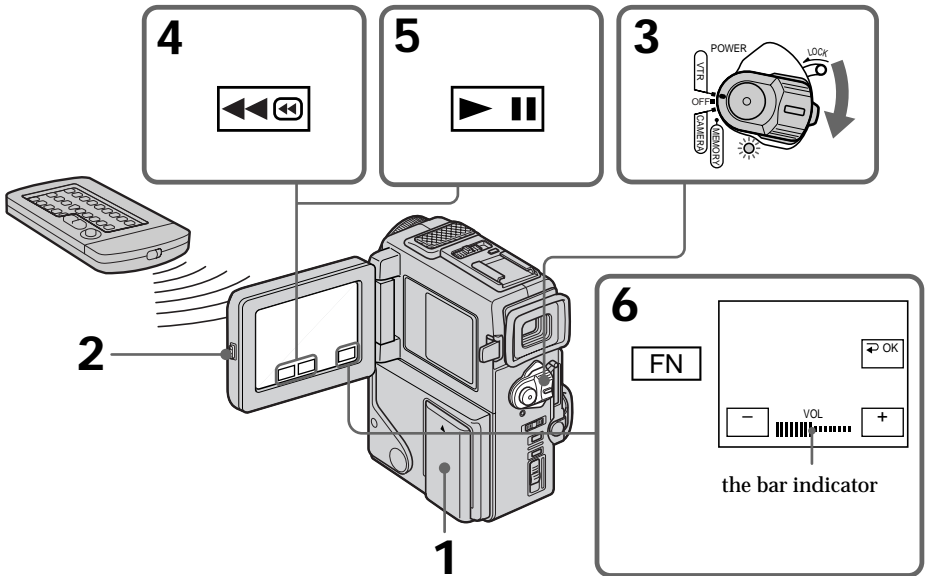

To return to FN

Press EXIT.

To stop playback

Press .

Playing back a tape

When monitoring on the LCD screen

You can turn the LCD panel over and move it back to the camcorder body with the LCD screen facing out.

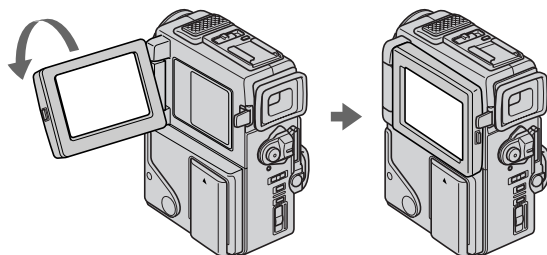

If you leave the power on for a long time

Your camcorder gets warm. This is not a malfunction.

When you open/close the LCD panel

Open/close the LCD panel vertically.

When monitoring in the viewfinder

Turn the LCD panel over and move it back to the camcorder body with the LCD screen facing out, and pull out the viewfinder until it clicks (p. 110). In this case, the picture is not displayed on the LCD screen.

Playing back a tape

To control the display of the screen indicators

Press DISPLAY/TOUCH PANEL on your camcorder or DISPLAY on the Remote Commander supplied with your camcorder. The indicators disappear on the LCD screen. To make the indicators appear, press DISPLAY/TOUCH PANEL again.

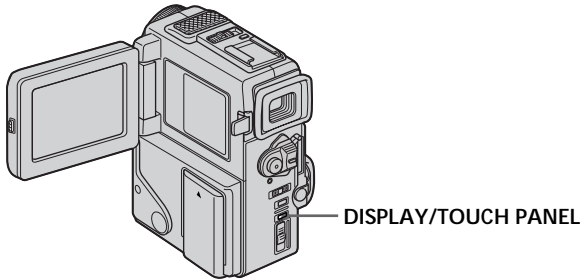

Using the data code function

Your camcorder automatically records not only images on the tape but also the recording data (date/time or various settings when recorded) (**Data code**). You can only operate with the Remote Commander.

Press DATA CODE on the Remote Commander in the playback mode.

The display changes as follows:

date/time → various settings (SteadyShot, exposure, white balance, gain, shutter speed, aperture value) → no indicator

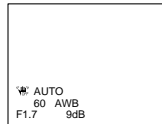
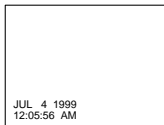

Not to display various settings

Set DATA CODE to DATE in the menu settings (p. 76).

The display changes as follows:

date/time → no indicator

Note

The pictures taken on the “Memory Stick” are not recorded with various settings.

Recording data

Recording data is your camcorder’s information when you have recorded. In the recording mode, the recording data will not be displayed.

When you use data code function, bars (-- -- --) appear if:

- A blank section of the tape is being played back.
- The tape is unreadable due to tape damage or noise.
- The tape was recorded by a camcorder without the date and time set.

Data code

When you connect your camcorder to the TV, the data code also appears on the TV screen (p. 30).

Various playback modes

To operate video control buttons, set the POWER switch to VTR.

To view a still picture (playback pause)

Press during playback. To resume playback, press again.

To advance the tape

Press in the stop mode. To resume normal playback, press .

To rewind the tape

Press in the stop mode. To resume normal playback, press .

To change the playback direction

Press < on the Remote Commander during playback to reverse the playback direction. To resume normal playback, press .

To locate a scene monitoring the picture (picture search)

Keep pressing or during playback. To resume normal playback, release the button.

To monitor the high-speed picture while advancing or rewinding the tape (skip scan)

Keep pressing while rewinding or while advancing the tape. To resume rewinding or advancing, release the button.

To view the picture at slow speed (slow playback)

Press on the Remote Commander during playback. For slow playback in the reverse direction, press <, then press on the Remote Commander. To resume normal playback, press .

To view the picture at double speed

Press ×2 on the Remote Commander during playback. For double speed playback in the reverse direction, press <, then press ×2 on the Remote Commander. To resume normal playback, press .

To view the picture frame-by-frame

Press on the Remote Commander in the playback pause mode. For frame-by-frame playback in the reverse direction, press . To resume normal playback, press .

To search the last scene recorded (END SEARCH)

Press END SEARCH in the stop mode. The last 5 seconds of the recorded section plays back and stops.

Control buttons

Marks on your camcorder are different from those on the Remote Commander supplied with your camcorder.

Your camcorder : , ,

Remote Commander : , ,

In the various playback modes

Sound is muted.

When the playback pause mode lasts for 5 minutes

Your camcorder automatically enters the stop mode. To resume playback, press .

Slow playback

The slow playback can be performed smoothly on your camcorder; however, this function does not work for an output signal from the DV IN/OUT jack.

When you play back a tape in reverse

Horizontal noise appears at the center or top and bottom of the screen. This is not a malfunction.

Viewing the recording on TV

Connect your camcorder to your TV or VCR with the A/V connecting cable supplied with your camcorder to watch the playback picture on the TV screen. You can operate the playback control buttons in the same way as when you monitor playback pictures on the LCD screen. When monitoring the playback picture on the TV screen, we recommend that you power your camcorder from a wall outlet using the AC adaptor (p. 13). Refer to the operating instructions of your TV or VCR.

Open the jack cover. Connect your camcorder to the TV using the A/V connecting cable. Then, set the TV/VCR selector on the TV to VCR.

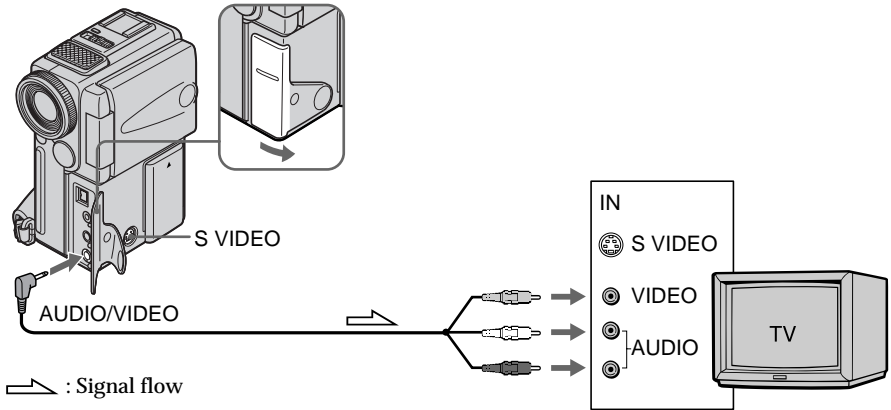

If your TV is already connected to a VCR

Connect your camcorder to the LINE IN input on the VCR by using the A/V connecting cable supplied with your camcorder. Set the input selector on the VCR to LINE.

If your TV or VCR is a monaural type

Connect the yellow plug of the A/V connecting cable to the video input jack and the white or the red plug to the audio input jack on the VCR or the TV. If you connect the white plug, the sound is L (left) signal. If you connect the red plug, the sound is R (right) signal.

If your TV or VCR has an S video jack

Connect using an S video cable (not supplied) to obtain high-quality pictures. With this connection, you do not need to connect the yellow (video) plug of the A/V connecting cable.

Connect the S video cable (not supplied) to the S video jacks on both your camcorder and the TV or the VCR.

This connection produces higher quality DV format pictures.

To display the screen indicators on TV

Set DISPLAY to V-OUT/LCD in the menu settings (p. 76).

Then press DISPLAY/TOUCH PANEL on your camcorder. To turn off the screen indicators, press DISPLAY/TOUCH PANEL on your camcorder again.

Photo recording

You can record a still picture like a photograph. This mode is useful when you want to record a picture such as a photograph or when you print a picture using a video printer (not supplied).

You can record about 510 pictures in the SP mode and about 765 pictures in the LP mode on a 60-minute tape.

Besides the operation described here, your camcorder can record still pictures on “Memory Stick”s (p. 90).

(1) Set the POWER switch to CAMERA.

(2) In the standby mode, keep pressing PHOTO lightly until a still picture appears. The CAPTURE indicator appears. Recording does not start yet.

To change the still picture, release PHOTO, select a still picture again, and then press and hold PHOTO lightly.

(3) Press PHOTO deeper.

The still picture in the viewfinder or on the LCD screen is recorded for about seven seconds. The sound during those seven seconds is also recorded.

The still image is displayed in the viewfinder or on the LCD screen until recording is completed.

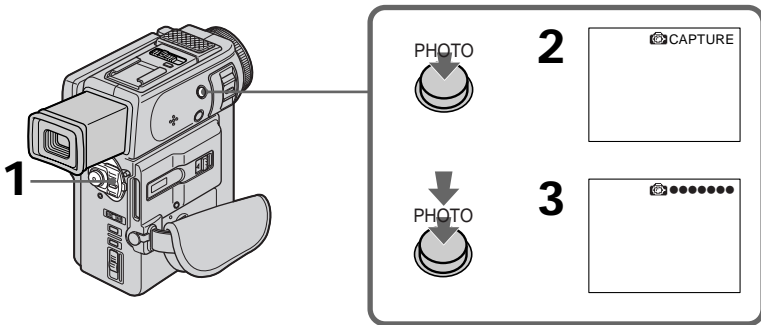

Notes

- During photo recording, you cannot change the mode or setting.
- During photo recording, you cannot turn your camcorder off or press the PHOTO button.
- When recording a still picture, do not shake your camcorder. The picture may fluctuate.
- The photo recording function does not work:
 - while the fader function is set or in use
 - while the digital effect function is set or in use

Photo recording

To use the photo recording function using the Remote Commander

Press PHOTO on the Remote Commander. Your camcorder records a picture on the LCD screen or in the viewfinder immediately.

To use the photo recording function during normal CAMERA recording

Press PHOTO deeper. The still picture is then recorded for about seven seconds and your camcorder returns to the standby mode. You cannot select another still picture.

If you record a moving subject with photo recording function

When you play back the still picture on other equipment, the picture may fluctuate.

When shooting in the dark

Attach the video flash (not supplied) to the accessory shoe.

Printing the still picture

You can print a still picture by using the video printer (not supplied). Connect the video printer using the A/V connecting cable supplied with your camcorder.

Connect it to the AUDIO/VIDEO jack and connect the yellow plug of the cable to the video input of the video printer. Refer to the operating instructions of the video printer as well.

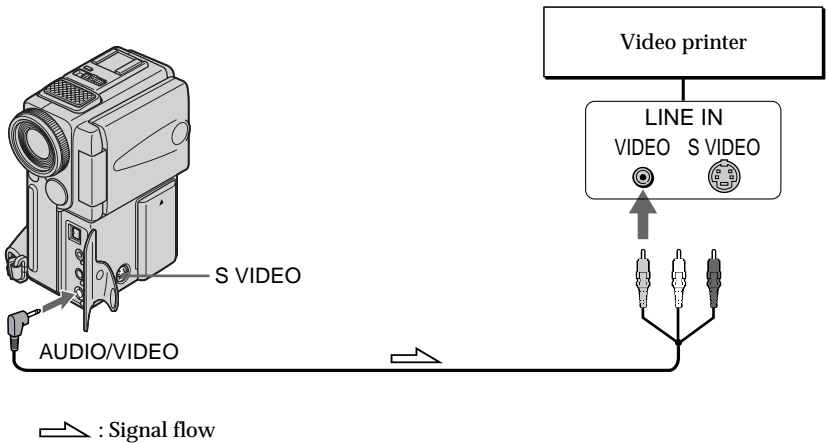



If the video printer is equipped with S video input

Use the S video connecting cable (not supplied). Connect it to the S VIDEO jack and the S video input of the video printer.

Using the wide mode

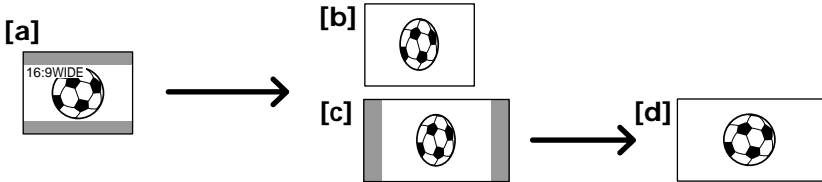
You can record a 16:9 wide picture to watch on the 16:9 wide-screen TV (16:9WIDE). Black bands appear on the screen during recording in 16:9WIDE mode [a]. The picture during playing back on a normal TV [b] or a wide -screen TV [c] are compressed in the widthwise direction. If you set the screen mode of the wide-screen TV to the full mode, you can watch pictures of normal images [d].



- (1) In the standby mode, press FN to display PAGE1 (p. 15).
- (2) Press MENU, then set 16:9WIDE to ON in  in the menu settings (p. 76).

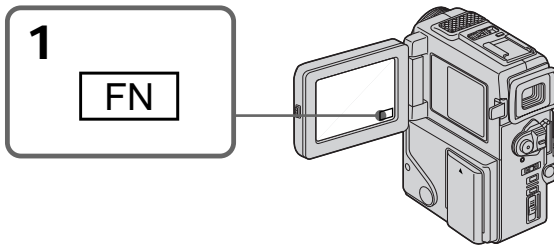

To return to FN

Press EXIT.

To cancel the wide mode

Set 16:9WIDE to OFF in the menu settings.

In the wide mode

You cannot select the old movie function with DIG EFFT and the bounce function with FADER.

During recording

You cannot select or cancel the wide mode. When you cancel the wide mode, set your camcorder to the standby mode and then set 16:9WIDE to OFF.

Connection for a TV

Pictures recorded in the 16:9WIDE mode automatically appear on the TV screen at full size when you connect your camcorder to a TV that is compatible with the video ID (ID-1/ID-2) system.

ID-1 system

The ID-1 system communicates the aspect ratio (16:9, 4:3 or letterbox) information of the screen by adding signals to the gaps between video signals. If a TV supporting this system is connected to your camcorder, the TV's wide mode is switched to automatically.

ID-2 system

The ID-2 system sends a copyright protection signal with ID-1 signals inserted between video signals when you connect your camcorder to other equipment by an A/V connecting cable.

Using the fader function

You can fade in or out to give your recording a professional appearance.

[a]

STBY

REC

NORMAL FADER



M.FADER
(mosaic)

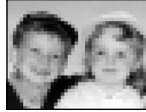

BOUNCE*
(Fade in only)



OVERLAP
(Fade in only)



[b]

STBY

REC

MONOTONE

When fading in, the picture gradually changes from black-and-white to color.

When fading out the picture gradually changes from color to black-and-white.

* You cannot use this function when D ZOOM is set to ON in the menu settings.

Using the fader function

- (1) When fading in [a]
In the standby mode, press FN to display PAGE1 (p. 15).
When fading out [b]
In the recording mode, press FN to display PAGE1 (p. 15).
- (2) Press FADER. The screen to select the fader mode appears.
- (3) Select a desired fader mode.
- (4) Press \rightarrow OK to return to PAGE1/PAGE2, and press EXIT to return to FN.
- (5) Press START/STOP. After the fade in/out is carried out, your camcorder automatically returns to the normal mode.

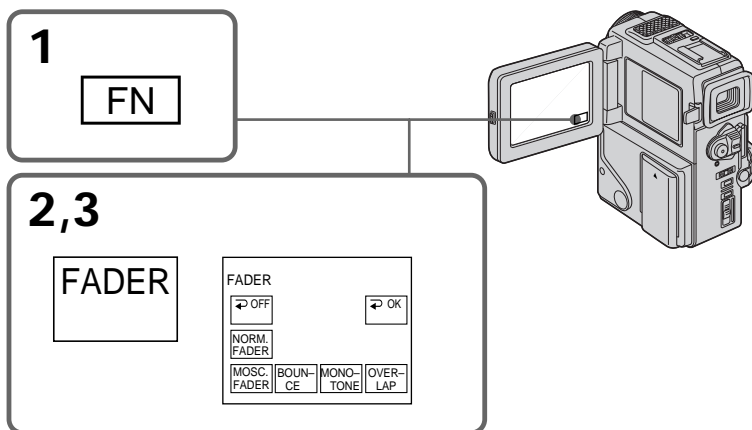

To cancel the fader function

After the fade in/out is carried out : Your camcorder automatically returns to the normal mode.

Before the fade in/out is carried out : Before pressing START/STOP, press \rightarrow OFF to return to PAGE1/PAGE2, and press EXIT to return to FN.

Using the fader function

Note

You cannot use the following functions while using the fader function. Also, you cannot use the fader function while using the following functions.

- Digital effect
- Low lux mode of PROGRAM AE (Overlap function only)
- NightShot +Slow shutter
- Photo recording

When the OVERLAP indicator appears

Your camcorder automatically stores the image recorded on a tape. As the image is being stored, the OVERLAP indicator flashes fast, and the playback picture is displayed.

At this stage, the picture may not be recorded clearly, depending on the tape condition.

When START/STOP MODE is set to \perp or 5SEC

You cannot use the fader function.

While using the bounce function, you cannot use the following functions:

- Exposure
- Focus
- Zoom
- Picture effect

Note on the bounce function

The BOUNCE indicator does not appear in the following mode or functions:

- D ZOOM is set to ON in the menu settings
- Wide mode
- Picture effect
- PROGRAM AE

Using special effects – Picture effect

You can digitally process images to obtain special effects like those in films or on the TV.

NEG. ART [a] : The color and brightness of the picture is reversed.

SEPIA : The picture is sepia.

B&W : The picture is monochrome (black-and-white).

SOLARIZE [b] : The light intensity is clearer, and the picture looks like an illustration.

PASTEL [c] : The contrast of the picture is emphasized, and the picture looks like an animated cartoon.

MOSAIC [d] : The picture is mosaic.

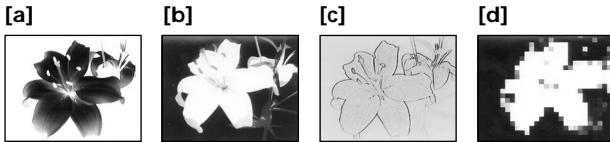

- (1) In the standby/recording mode, press FN to display PAGE1 (p. 15).
- (2) Press MENU, then select P EFFECT in  in the menu settings to select a desired picture effect mode (p. 76).

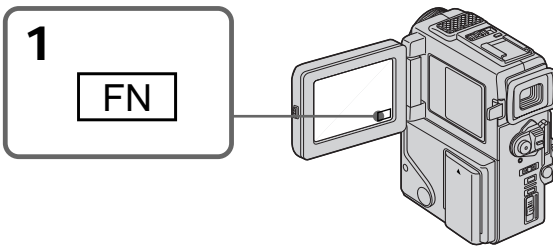

To return to FN

Press EXIT.

To turn the picture effect function off

Select OFF in P EFFECT in the menu settings.

Using special effects – Picture effect

While using the picture effect function

You cannot select the old movie mode with DIG EFFT.

When you turn the power off

Your camcorder automatically returns to the normal mode.

If you select the picture effect mode in the recording mode

Pictures processed by the picture effect function will be recorded.

Using special effects – Digital effect

You can add special effects to recorded pictures using the various digital functions. The sound is recorded normally.

STILL

You can record a still picture so that it is superimposed on a moving picture.

FLASH (FLASH MOTION)

You can record still pictures successively at constant intervals.

LUMI. (LUMINANCEKEY)

You can swap a brighter area in a still picture with a moving picture.

TRAIL

You can record the picture so that an incidental image like a trail is left.

SLOW SHTR (SLOW SHUTTER)

You can slow down the shutter speed. The slow shutter mode is good for recording dark pictures more brightly.

OLD MOVIE

You can add an old movie type atmosphere to pictures. Your camcorder automatically sets the wide mode to ON and picture effect to SEPIA.

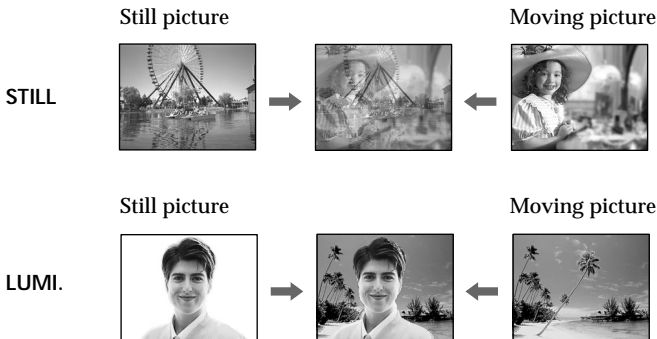

Using special effects – Digital effect

- (1) In the standby mode, press FN to display PAGE1 (p. 15).
- (2) Press DIG EFFT. The screen to select a desired digital effect mode.
- (3) Select a desired digital effect mode.
- (4) Press -/+ to adjust the effect.

Items to adjust

STILL	The rate of the still picture you want to superimpose on the moving picture
FLASH	The interval of flash motion
LUMI.	The color scheme of the area in the still picture which is to be swapped with a moving picture
TRAIL	The vanishing time of the incidental image
SLOW SHTR	Shutter speed. The larger the shutter speed number, the slower the shutter speed.

- (5) Press ↵OK to return to PAGE1/PAGE2.

1

FN

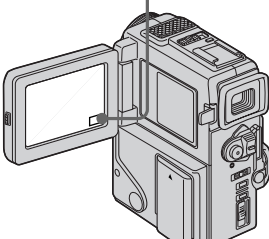

2~4

DIG
EFFT

DIG EFFT

↵ OFF ↵ OK

SLOW SHTR | OLD MOVIE

STILL | FLASH | LUMI. | TRAIL

↵ OFF ↵ OK

- LUMI. +

|||||

The bar appears when setting following digital effect modes : STILL, FLASH, LIMI., TRAIL.

To return to FN

Press EXIT.

To cancel the digital effect

Press ↵OFF to return to PAGE1/PAGE2.

Using special effects – Digital effect

Notes

- The following functions do not work during digital effect:
 - Fader
 - Low lux mode of PROGRAM AE
 - Photo recording
 - NightShot +Slow shutter
- The following function does not work in the slow shutter mode:
 - PROGRAM AE
- The following functions do not work in the old movie mode:
 - Wide mode
 - Picture effect
 - PROGRAM AE

When you turn the power off

The digital effect will be automatically canceled.

When recording in the slow shutter mode

Auto focus may not be effective. Focus manually using a tripod.

Shutter speed

Shutter speed number	Shutter speed
SLOW SHTR 1	1/30
SLOW SHTR 2	1/15
SLOW SHTR 3	1/8
SLOW SHTR 4	1/4

Adjusting the white balance manually

You can manually adjust and set the white balance. This adjustment makes white subjects look white and allows more natural color balance. Normally white balance is automatically adjusted.

- (1) In the standby/recording mode, press FN to display PAGE1 (p. 15).
- (2) Select WHT BAL in  in the menu settings to select a desired white balance mode (p. 76).

 (IN DOOR) :

- Lighting condition changes quickly
- Too bright place such as photography studios
- Under sodium lamps or mercury lamps

 (OUT DOOR) :

- Recording a sunset/sunrise, just after sunset, just before sunrise, neon signs, or fireworks
- Under a color matching fluorescent lamp

HOLD : Recording a single-colored subject or background

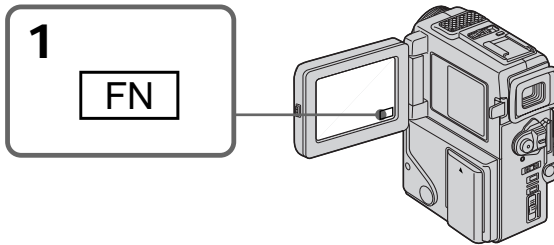

To return to FN

Press EXIT.

To return to the automatic white balance mode

Set WHT BAL to AUTO in the menu settings (p. 76).

If the picture is being taken in a studio lit by TV lighting

We recommend that you record in the  indoor mode.

When you record under fluorescent lighting

Use the automatic white balance or hold mode.

Your camcorder may not adjust the white balance correctly in the  indoor mode.

In the automatic white balance mode

Point your camcorder at white subject for about 10 seconds after setting the power switch to CAMERA to get better adjustment when:

- You detach the battery for replacement.
- You bring your camcorder from indoors to outdoors and vice versa.

In the hold white balance mode

Set the white balance to AUTO and reset to HOLD after few seconds when:

- You change the PROGRAM AE mode.
- You bring your camcorder from indoors to outdoors and vice versa.

Using the PROGRAM AE function

You can select PROGRAM AE (Auto Exposure) mode to suit your specific shooting requirements.

Spotlight mode

This mode prevents people's faces, for example, from appearing excessively white when shooting subjects lit by strong light at weddings or in the theater.

Soft portrait mode

This mode brings out the subject while creating a soft background for subjects such as people or flowers.

Sports lesson mode

This mode minimizes shake on fast-moving subjects such as in tennis or golf.

Beach & ski mode

This mode prevents people's faces from appearing dark in strong light or reflected light, such as at a beach in midsummer or on a ski slope.

Sunset & moon mode

This mode allows you to maintain atmosphere when you are recording sunsets, general night views, fireworks displays and neon signs.

Landscape mode

This mode is for when you are recording distant subjects such as mountains and prevents your camcorder from focusing on glass or metal mesh in windows when you are recording a subject behind glass or a screen.

Low lux mode

This mode makes subjects brighter in insufficient light.



Using the PROGRAM AE function

- (1) In the standby mode, press FN to display PAGE1 (p. 15).
- (2) Press MENU, then select a desired PROGRAM AE mode in  in the menu settings (p. 76).

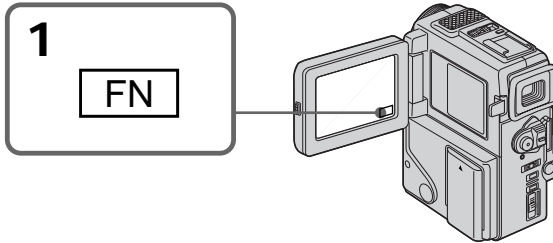

To return to FN

Press EXIT.

To turn the PROGRAM AE function off

Select AUTO in PROGRAM AE in the menu settings.

Notes

- In the spotlight, sports lesson and beach & ski modes, you cannot take close-ups. This is because your camcorder is set to focus only on subjects in the middle to far distance.
- In the sunset & moon and landscape modes, your camcorder is set to focus only on distant subjects.
- The following functions do not work in the PROGRAM AE mode:
 - Slow shutter
 - Old movie
 - Bounce
- The following functions do not work in the low lux mode:
 - Digital effect
 - Overlap
- If you press PROGRAM AE when using the NightShot function, the PROGRAM AE indicator flashes and the PROGRAM AE function does not work.

While WHT BAL is set to AUTO in the menu settings

The white balance is adjusted even if the PROGRAM AE function is selected.

Even if the PROGRAM AE function is selected

You can adjust the exposure.

If you are recording under a discharge tube such as a fluorescent lamp, sodium lamp or mercury lamp

Flickering or changes in color may occur in the following modes. If this happens, turn the PROGRAM AE function off.

- Soft portrait mode
- Sports lesson mode

Adjusting the exposure manually

You can manually adjust and set the exposure. Adjust the exposure manually in the following cases:

- The subject is backlit
- Bright subject and dark background
- To record dark pictures (e.g. night scenes) faithfully

- (1) In the standby/recording/memory camera mode, press FN to display PAGE1 (p. 15).
- (2) Press EXPOSURE. The screen to adjust exposure appears.
- (3) Press MANUAL, then adjust exposure using -/+.
- (4) Press \Rightarrow OK to return to PAGE1/PAGE2.

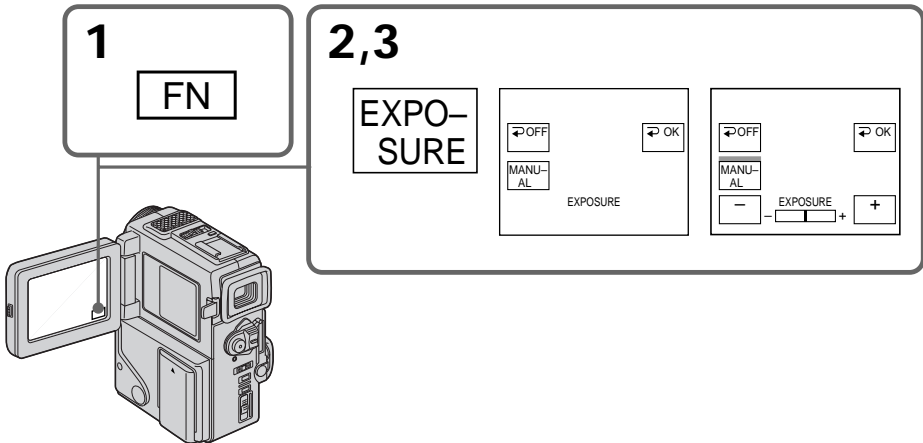

To return to FN

Press EXIT.

To return to the automatic exposure mode

Press \Rightarrow OFF to return to PAGE1/PAGE2.

Note

When you adjust the exposure manually, the backlight function does not work.

If you change the PROGRAM AE mode or slide NIGHTSHOT to ON
Your camcorder automatically returns to the automatic exposure mode.

Focusing manually

You can gain better results by manually adjusting the focus in the following cases:

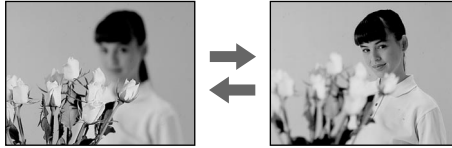

- The autofocus mode is not effective when shooting
 - subjects through glass coated with water droplets
 - horizontal stripes
 - subjects with little contrast with backgrounds such as walls and sky
- When you want to change the focus from a subject in the foreground to a subject in the background
- Shooting a stationary subject when using a tripod

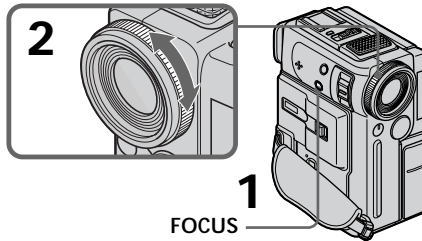

- (1) Press FOCUS lightly in the standby/recording mode. The  indicator appears on the LCD screen or in the viewfinder.
- (2) Turn the focus ring to sharpen focus.



To return to the autofocus mode

Press FOCUS lightly to turn off ,  or  indicator.

To record distant subjects

When you press FOCUS down to INFINITY. The lens focuses on and  indicator appears. When you release FOCUS, your camcorder returns to the manual focus mode. Use this mode when your camcorder focuses on near objects even though you are trying to shoot a distant object.

Not to make subjects out of focus when using zoom function

Focus after focusing at the “T” (telephoto) position. It will be harder to focus on when using digital zoom function.



Shooting in relatively dark places or shooting fast-moving subjects in relatively bright places

Shoot at the “W” (wide-angle) position after focusing at the “T” (telephoto) position.

When you shoot close to the subject

Focus at the end of the “W” (wide-angle) position.

 changes as follows:

-  when recording a distant subject.
-  when the subject is too close to focus on.

Playing back a tape with picture effects

During playback, you can process a scene using the picture effect functions: NEG.ART, SEPIA, B&W and SOLARIZE.

- (1) In the playback mode or the playback pause mode, press FN to display PAGE1 (p. 15).
- (2) Press MENU, then select P EFFECT in  in the menu settings to select a desired picture effect mode (p. 76).
Refer to 37 page for details of each picture effect function.

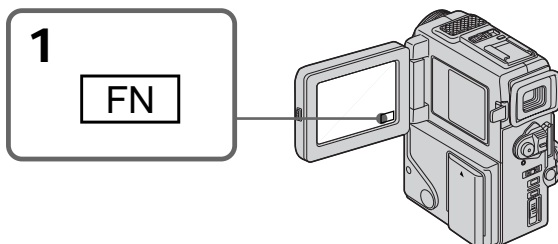

To return to FN

Press EXIT.

To cancel the picture effect function

Set P EFFECT to OFF in the menu settings.

Notes

- You cannot process externally input scenes using the picture effect function.
- To record pictures that you have processed using the picture effect function, record the pictures on the VCR using your camcorder as a player.

Pictures processed by the picture effect function

Pictures processed by the picture effect function are not output through the  DV IN/OUT jack.

When you set the POWER switch to OFF or stop playing back

The picture effect function is automatically canceled.

Playing back a tape with digital effects

During playback, you can process a scene using the digital effect functions: STILL, FLASH, LUMI. and TRAIL.

- (1) In the playback mode or the playback pause mode, press FN and select PAGE2 (p. 15).
- (2) Press DIG EFFT. The screen to select a desired digital effect mode appears.
- (3) Select a desired digital effect mode. In the STILL or LUMI. mode, the picture where you select the mode is stored in memory as a still picture.
- (4) Press -/+ to adjust the effect. Refer to page 39 for details.
- (5) Press \Rightarrow OK to return to PAGE1/PAGE2.

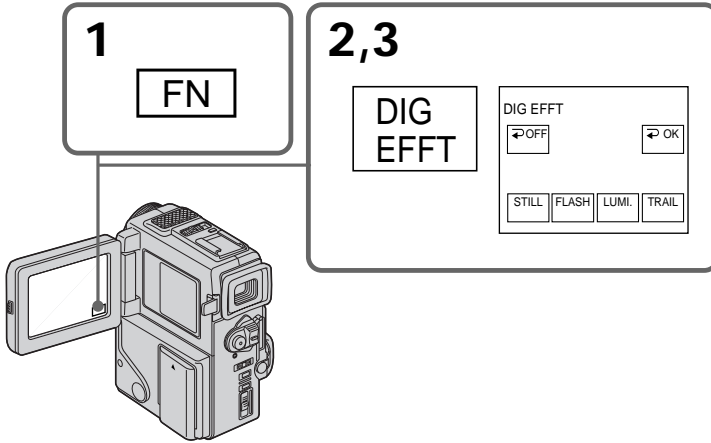

To return to FN

Press EXIT.

To cancel the digital effect function

Press \Rightarrow OFF to return to PAGE1/PAGE2.

Notes

- You cannot process externally input scenes using the digital effect function.
- To record pictures that you have processed using the digital effect, record the pictures on the VCR using your camcorder as a player.

Pictures processed by the digital effect function

Pictures processed by the digital effect function are not output through the \mathbb{I} DV IN/OUT jack.

When you set the POWER switch to OFF or stop playing back
The digital effect function is automatically canceled.

Quickly locating a scene using the zero set memory function

Your camcorder goes forward or backward to automatically stop at a desired scene having a tape counter value of "0:00:00". You can do this with the Remote Commander. Use this function, for example, to view a desired scene later on during playback.

- (1) In the playback mode, press DISPLAY if the counter is not on the LCD screen or in the viewfinder.
- (2) Press ZERO SET MEMORY at the point you want to locate later. The tape counter shows "0:00:00" and the ZERO SET MEMORY indicator flashes.
- (3) Press ■ when you want to stop playback.
- (4) Press ◀ to rewind the tape to the tape counter's zero point. The tape stops automatically when the tape counter reaches approximately zero. The ZERO SET MEMORY indicator disappears and the time code appears.
- (5) Press ▶. Playback starts.

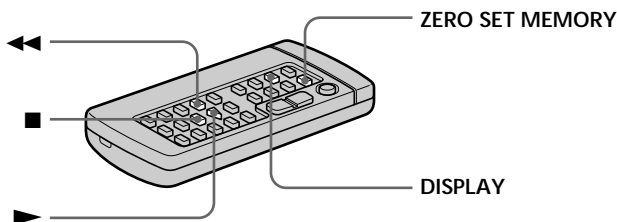

Notes

- When you press ZERO SET MEMORY before rewinding the tape, the zero set memory function will be canceled.
- There may be a discrepancy of several seconds from the time code.
- The zero set memory function may not work when there is a blank portion between pictures on a tape.
- The ZERO SET MEMORY indicator disappears when you press FN.

ZERO SET MEMORY functions also in the recording standby mode

When you insert a scene in the middle of a recorded tape, press ZERO SET MEMORY at the point you want to end the insertion. Rewind the tape to the insert start point, and start recording. Recording stops automatically at the tape counter zero point. Your camcorder returns to the standby mode.

Searching a recording by date

- Date search

You can automatically search for the point where the recording date changes and start playback from that point (**Date search**). Use a tape with cassette memory for convenience. Use the Remote Commander for this operation.

Use this function to check where recording dates change or to edit the tape at each recording date.



Searching for the date by using cassette memory

You can use this function only when playing back a tape with cassette memory (p. 111).

- (1) Set the POWER switch to VTR.
- (2) Press FN to display PAGE1 (p. 15).
- (3) Press MENU, then set CM SEARCH in  to ON in the menu settings (p. 76). Default setting is ON.
- (4) Press SEARCH MODE on the Remote Commander repeatedly, until the date search indicator appears.

The indicator changes as follows:

TITLE SEARCH → DATE SEARCH → PHOTO SEARCH → PHOTO SCAN
→ no indicator

- (5) Press  or  on the Remote Commander to select the date for playback. Your camcorder automatically starts playback at the beginning of the selected date.

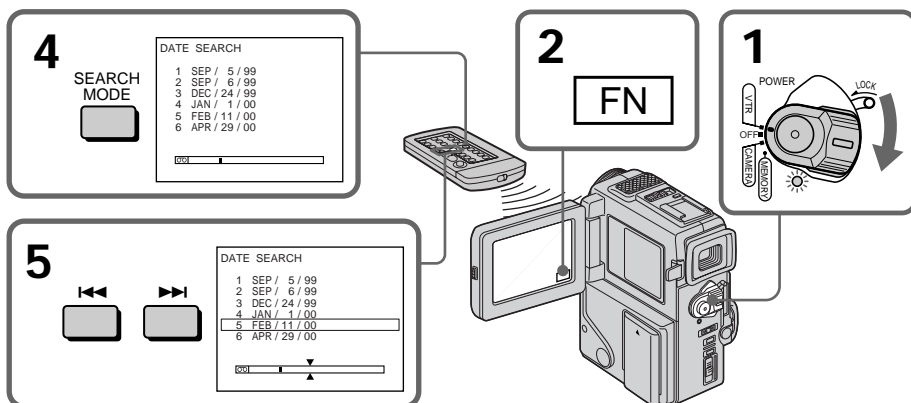





To stop searching

Press  on the Remote Commander.

Searching a recording by date

Searching for the date without using cassette memory

- (1) Set the POWER switch to VTR.
- (2) Press FN to display PAGE1 (p. 15).
- (3) Press MENU, then set CM SEARCH in  to OFF in the menu settings (p. 76).
If using a tape without cassette memory, skip this step.
- (4) Press SEARCH MODE on the Remote commander repeatedly, until the date search indicator appears.
The indicator changes as follows:
TITLE SEARCH → DATE SEARCH → PHOTO SEARCH → PHOTO SCAN
→ no indicator
- (5) Press  on the Remote Commander to search for the previous date or press  on the Remote Commander to search for the next date. Your camcorder automatically starts playback at the point where the date changes. Each time you press  or , your camcorder searches for the previous or next date.



To stop searching

Press  on the Remote Commander or on your camcorder.

Note

If one day's recording is less than two minutes, your camcorder may not accurately find the point where the recording date changes.

In the mark

- The bar in the  mark indicates the present point on the tape.
- The  mark in the  indicates the actual point you are trying to search.

If a tape has a blank portion between recorded portions

The date search function may not work correctly.



Cassette memory

The tape cassette memory can hold six recording date data.

Searching the boundaries of recorded tape by title – Title search

CM
only

If you use a tape with cassette memory, you can search for the boundaries of recorded tape by title (Title search). Use the Remote Commander for this operation.

- (1) Set the POWER switch to VTR.
- (2) Press FN to display PAGE1 (p. 15).
- (3) Press MENU, then set CM SEARCH in  to ON in the menu settings (p. 76). Default setting is ON.
- (4) Press SEARCH MODE on the Remote Commander repeatedly, until the title search indicator appears.
The indicator changes as follows:
TITLE SEARCH → DATE SEARCH → PHOTO SEARCH → PHOTO SCAN → no indicator
- (5) Press  or  on the Remote Commander to select the title for playback.
Your camcorder automatically starts playback of the scene having the title that you selected.

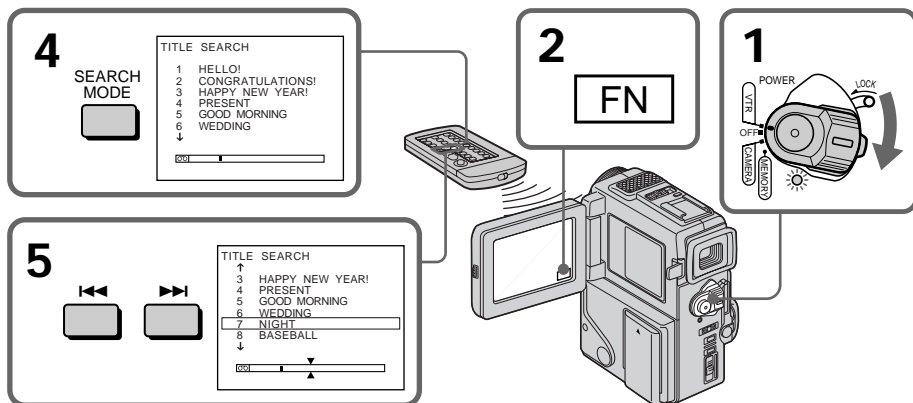





To stop searching

Press  on the Remote Commander.

If you use a tape without cassette memory

You cannot superimpose or search a title.

In the  mark

- The bar in the  mark indicates the present point on the tape.
- The  mark in the  indicates the actual point you are trying to search.

If a tape has a blank portion between recorded portions

The title search function may not work correctly.

To superimpose a title



See page 69.

Searching for a photo – Photo search/ Photo scan

You can search for a still picture you have recorded on a mini DV tape (photo search). You can also search for still pictures one after another and display each picture for five seconds automatically regardless of cassette memory (photo scan). Use the Remote Commander for these operations. Use this function to check or edit still pictures.

Searching for a photo by using cassette memory

You can use this function only when playing back a tape with cassette memory (p. 111).

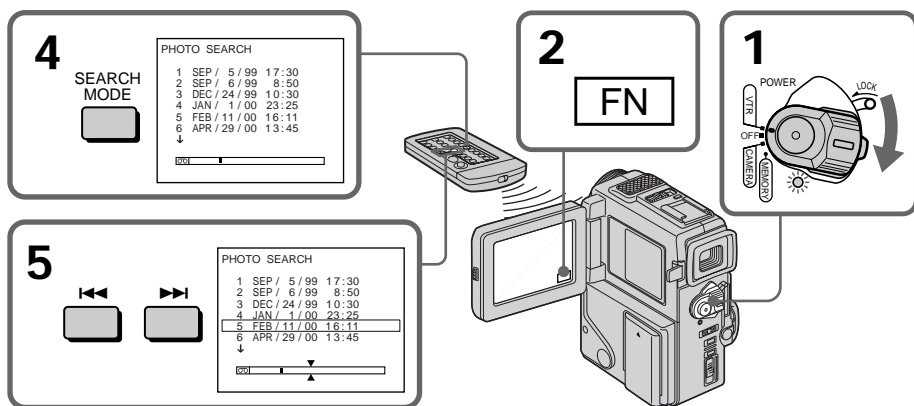

- (1) Set the POWER switch to VTR.
- (2) Press FN to display PAGE1 (p. 15).
- (3) Press MENU, then set CM SEARCH in  to ON in the menu settings (p. 76). Default setting is ON.
- (4) Press SEARCH MODE on the Remote Commander repeatedly, until the photo search indicator appears.
The indicator changes as follows:
TITLE SEARCH → DATE SEARCH → PHOTO SEARCH → PHOTO SCAN → no indicator
- (5) Press  or  on the Remote Commander to select the date for playback. Your camcorder automatically starts playback of the photo having the date that you selected.



To stop searching

Press  on the Remote Commander.

In the  mark

- The bar in the  mark indicates the present point on the tape.
- The  mark in the  indicates the actual point you are trying to search.

If a tape has a blank portion between recorded portions





The photo search function may not work correctly.

The number of data to search displayed on the LCD screen

Up to 12 data can be displayed to search on the LCD screen. Use photo scan function to search the one among more than 12 photos.

Searching for a photo – Photo search/Photo scan



Searching for a photo without using cassette memory

- (1) Set the POWER switch to VTR.
- (2) Press FN to display PAGE1 (p. 15).
- (3) Press MENU, then set CM SEARCH in  to OFF in the menu settings (p. 76).
- (4) Press SEARCH MODE on the Remote Commander repeatedly, until the photo search indicator appears.
The indicator changes as follows:
TITLE SEARCH → DATE SEARCH → PHOTO SEARCH → PHOTO SCAN
→ no indicator
- (5) Press  or  on the Remote Commander to select the photo for playback.
Each time you press  or , your camcorder searches for the previous or next photo.
Your camcorder automatically starts playback of the photo.

To stop searching

Press  on the Remote Commander or on your camcorder.

Scanning photo

- (1) Set the POWER switch to VTR.
- (2) Press SEARCH MODE on the Remote Commander repeatedly, until the photo scan indicator appears.
The indicator changes as follows:
TITLE SEARCH → DATE SEARCH → PHOTO SEARCH → PHOTO SCAN
→ no indicator
- (3) Press  or  on the Remote Commander.
Each photo is played back for about 5 seconds automatically.

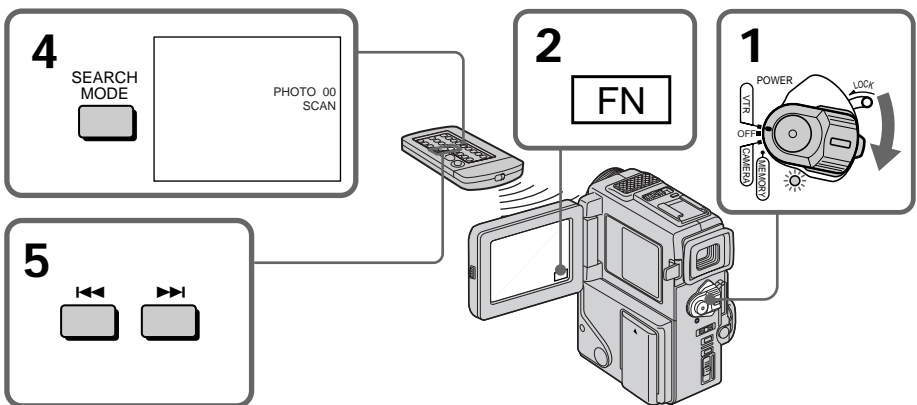

To stop scanning

Press  on the Remote Commander or on your camcorder.

Dubbing a tape

Using the A/V connecting cable

Connect your camcorder to the VCR using the A/V connecting cable supplied with your camcorder.

Set the input selector on the VCR to LINE, if available.

- (1) Insert a blank tape (or a tape you want to record over) into the VCR, and insert the recorded tape into your camcorder.
- (2) Set the POWER switch to VTR.
- (3) Play back the recorded tape on your camcorder.
- (4) Start recording on the VCR.

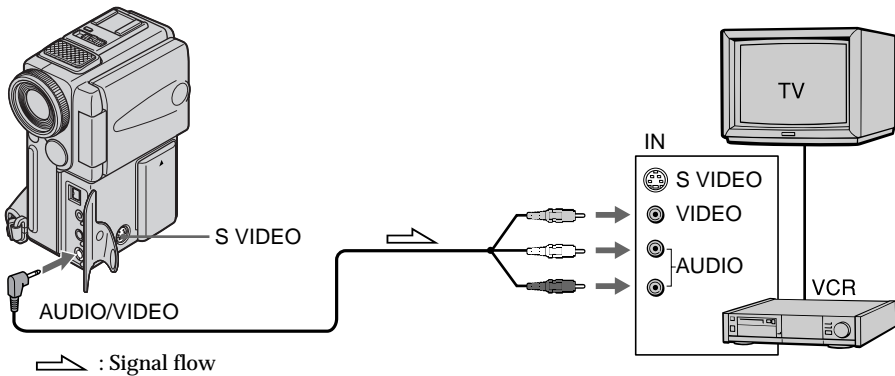

When you have finished dubbing a tape

Press **■** on both your camcorder and the VCR.

When you dub a tape

Turn off indicators displayed on the LCD screen by pressing following buttons. Otherwise, those indicators will be also recorded.

On your camcorder: DISPLAY/TOUCH PANEL

On the remote commander: DISPLAY, DATA CODE, SEARCH

You can edit on VCRs that support the following systems

8 8 mm, **Hi8** Hi8, **D** Digital8, **VHS** VHS, **S-VHS** S-VHS, **VHS-C** VHS-C, **S-VHS-C** S-VHS-C, **B** Betamax, **ED Beta** ED Betamax, **Mini DV** mini DV or **DV** DV

If your VCR is a monaural type

Connect the yellow plug of the A/V connecting cable to the video input jack and the white or the red plug to the audio input jack on the VCR or the TV. When the white plug is connected, the left channel audio is output, and the red plug is connected, the right channel audio is output.

Connect using an S video cable (not supplied) to obtain high-quality pictures

With this connection, you do not need to connect the yellow (video) plug of the A/V connecting cable.

Connect an S video cable (not supplied) to the S video jacks of both your camcorder and the VCR.

This connection produces higher quality DV format pictures.

Dubbing a tape

Using the i.LINK cable (DV connecting cable)

Simply connect the VMC-IL4435/2DV/4DV i.LINK cable (DV connecting cable) (not supplied) to DV IN/OUT and to DV IN/OUT of the DV products. With digital-to-digital connection, video and audio signals are transmitted in digital form for high-quality editing. You cannot dub the titles, display indicators or the contents of cassette memory.

- (1) Insert a blank tape (or a tape you want to record over) into the VCR, and insert the recorded tape into your camcorder.
- (2) Set the POWER switch to VTR.
- (3) Play back the recorded tape on your camcorder.
- (4) Start recording on the VCR.

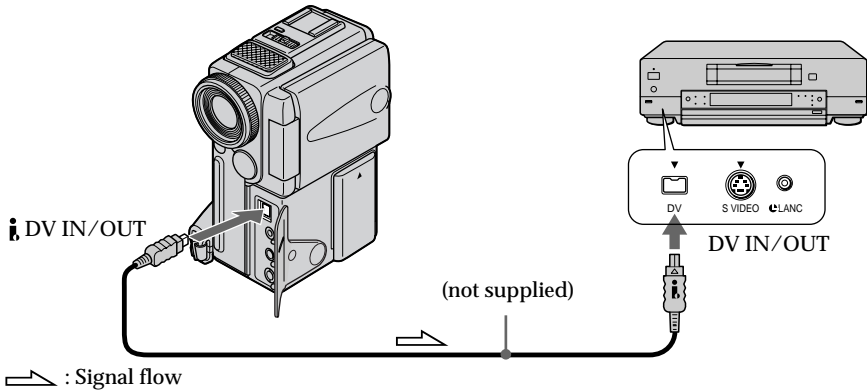

When you have finished dubbing a tape

Press ■ on both your camcorder and the VCR.

You can connect one VCR only using the i.LINK cable (DV connecting cable).

Pictures processed by the digital effect function

Pictures processed by the digital effect function are not output through the DV IN/OUT jack.

You can also use your camcorder as a recorder

You can use your camcorder as a player or recorder without changing the connection.

If you record playback pause picture with the DV IN/OUT jack

The recorded picture becomes rough. And when you play back the picture using the other video equipment, the picture may jitter.

To perform a more precise editing

Use DV synchro-editing function (p. 57).

Editing partially on a DV tape

- DV synchro-editing

By simply selecting the scenes to edit, you can duplicate the desired portion on a tape, using other equipment connected with an i.LINK cable (DV connecting cable). The scenes can be selected by frame. You can also use the Remote Commander for this operation. Since your camcorder exchanges digital signals, you can edit with little audio and video deterioration.

You cannot duplicate titles, display indicators, or the contents of cassette memory. The connection is the same as on page 56.

- (1) Insert a recorded tape into your camcorder and insert a blank tape (or a tape you want to record over) into the DV product.
- (2) Connect your camcorder to the DV product with an i.LINK cable (DV connecting cable).
- (3) Set the POWER switch on your camcorder to VTR.
- (4) Set the input selector to DV input on the DV product. If the DV product is another DV camcorder, set its POWER switch to VTR.
- (5) Press FN on your camcorder to display PAGE1 (p. 15).
- (6) Press MENU, then select DV EDITING in **ETC** in the menu settings (p. 76).
- (7) Using the control buttons, locate the point where you want to start editing, then press **▶||** to set your camcorder in the playback pause mode.
- (8) Press MARK on your camcorder or the Remote Commander to set DV EDITING IN.
- (9) Using the control buttons, locate the point where you want to end editing, then press **▶||** to set your camcorder in the playback pause mode.
- (10) Press MARK on your camcorder or the Remote Commander to set DV EDITING OUT. The editing process starts. When the process ends, your camcorder and the DV product automatically set to pause mode.

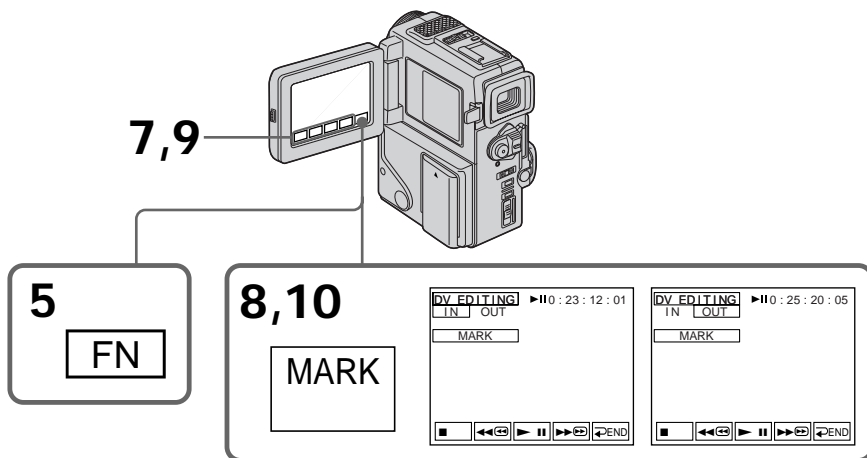

Editing partially on a DV tape – DV synchro-editing

Notes

- If you use other than Sony equipment with the  DV jack, you cannot perform DV synchro-editing.
- If a tape has a blank portion between recorded portions, DV synchro-editing may not work correctly.

Errors in duplicating

If you connect your camcorder to Sony equipment with DV jack, the range of errors is within ± 5 frames.

The range may become wider in the following conditions.

- The interval between DV EDITING IN and OUT is less than five seconds.
- DV EDITING IN or OUT is set at the beginning of the tape.

If you do not make connections with i.LINK cable (DV connecting cable)

The screen shows NOT READY, and you cannot select DV EDITING.

On a blank portion of the tape

You cannot set DV EDITING IN or OUT.

Recording video or TV programs

Using the A/V connecting cable

You can record a tape from another VCR or a TV program from a TV that has video/audio outputs. Use your camcorder as a recorder.

- (1) Insert a blank tape (or a tape you want to record over) into your camcorder. If you are recording a tape from the VCR, insert a recorded tape into the VCR.
- (2) Set the POWER switch to VTR.
- (3) Press MENU, then set DISPLAY in ETC to LCD in the menu settings. (p.76)
And press EXIT to return to FN.
- (4) Press FN, then select PAGE2 (p. 15).
- (5) Press REC CTRL.
- (6) Press REC PAUSE.
- (7) Press ▶ on the VCR to start playback if you are recording a tape from VCR.
Select a TV program if you are recording from TV. The picture from TV or VCR appears in the viewfinder or on the LCD screen.
- (8) Press REC START at the scene where you want to start recording from.

When you have finished dubbing a tape

Press ■ on both your camcorder and the VCR.

Using the Remote Commander

In the step 6 above, press ● REC and the button on its right simultaneously, then immediately press ■. And in the step 8, press ■ at the scene where you want to start recording from.

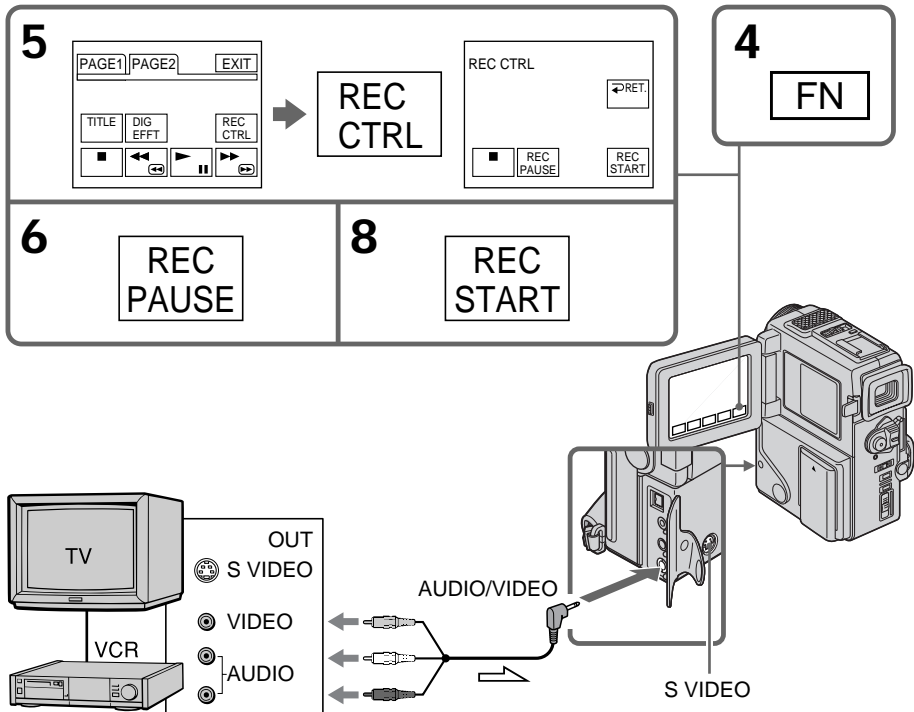

: Signal flow

Recording video or TV programs

If your VCR is a monaural type

Connect the yellow plug of the A/V connecting cable to the video output jack and the white or the red plug to the audio output jack on the VCR or the TV. When the white plug is connected, the left channel audio is output, and the red plug is connected, the right channel audio is output.

Connect using an S video cable (not supplied) to obtain high-quality pictures

With this connection, you do not need to connect the yellow (video) plug of the A/V connecting cable.



Connect an S video cable (not supplied) to the S video jacks of both your camcorder and the VCR.

This connection produces higher quality DV format pictures.

Recording video or TV programs

Using the i.LINK cable (DV connecting cable)



Simply connect the VMC-IL4435/2DV/4DV i.LINK cable (DV connecting cable) (not supplied) to DV IN/OUT and to DV IN/OUT of the DV products. With digital-to-digital connection, video and audio signals are transmitted in digital form for high-quality editing.

- (1) Insert a blank tape (or a tape you want to record over) into the your camcorder, and insert the recorded tape into VCR.
- (2) Set the POWER switch to VTR.
- (3) Press MENU, then set DISPLAY in  to LCD in the menu settings. (p.76)
And press EXIT to return to FN.
- (4) Press FN, then select PAGE2 (p. 15).
- (5) Press REC CTRL.
- (6) Press REC PAUSE.
- (7) Press  on the VCR to start playback.
- (8) Press REC START at the scene where you want to start recording.

When you have finished dubbing a tape

Press  on both your camcorder and the VCR.

Using the Remote Commander

In the step 6 press  REC and the button on its right simultaneously, then immediately press . And in the step 8, press  at the scene where you want to start recording from.

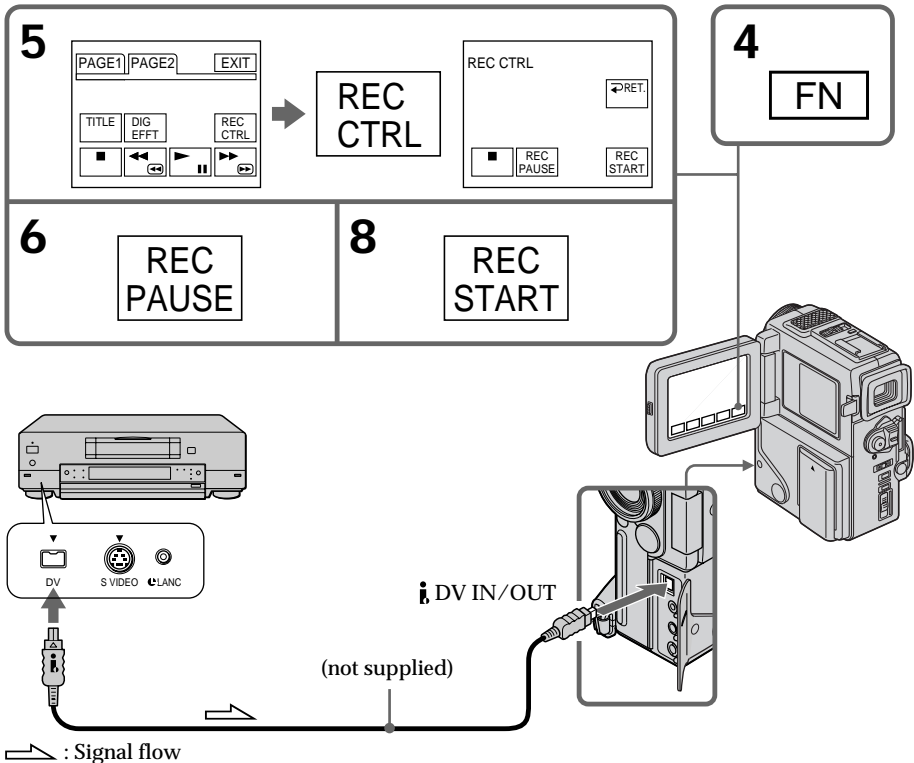

Recording video or TV programs

You can connect one VCR only using the i.LINK cable (DV connecting cable).

When you dub a picture in digital form

The color of the display may be uneven. However this does not affect the dubbed picture.

You can also use your camcorder as a player

You can use your camcorder as a player or recorder without changing the connection.

If you record playback pause picture with the DV IN/OUT jack

The recorded picture becomes rough. And when you play back the picture using your camcorder, the picture may jitter.

Before recording

Make sure if the DV IN indicator appears in the viewfinder or on the LCD screen. The DV IN indicator may appear on both equipment.

Inserting a scene from a VCR

Replacing recording on a tape - Insert Editing

You can insert a new scene from a VCR onto your originally recorded tape by specifying the insert start and end points. Use the Remote Commander for this operation. Connections are the same as on page 55 or 56.

Insert a cassette containing the desired scene to insert into the VCR.

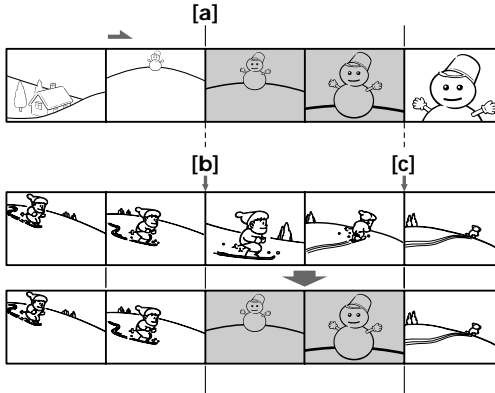

Inserting a scene from a VCR

- (1) Set the POWER switch to VTR.
- (2) On the VCR, locate just before the insert start point [a], then press **II** to set the VCR to the playback pause mode.
- (3) On your camcorder, locate the insert end point [c] by pressing **◀◀** or **▶▶**. Then press **II** to set it to the playback pause mode.
- (4) Press ZERO SET MEMORY on the Remote Commander. The ZERO SET MEMORY indicator flashes and the end point of the insert is stored in memory.
- (5) On your camcorder, locate the insert start point [b] by pressing **◀◀**. Press FN and select REC CTRL in PAGE2.
- (6) Press REC PAUSE.
- (7) First press **II** on the VCR, and after a few seconds press REC START on your camcorder to start inserting the new scene.
Inserting automatically stops near the zero point on the tape counter. Your camcorder automatically returns to the recording stop mode.

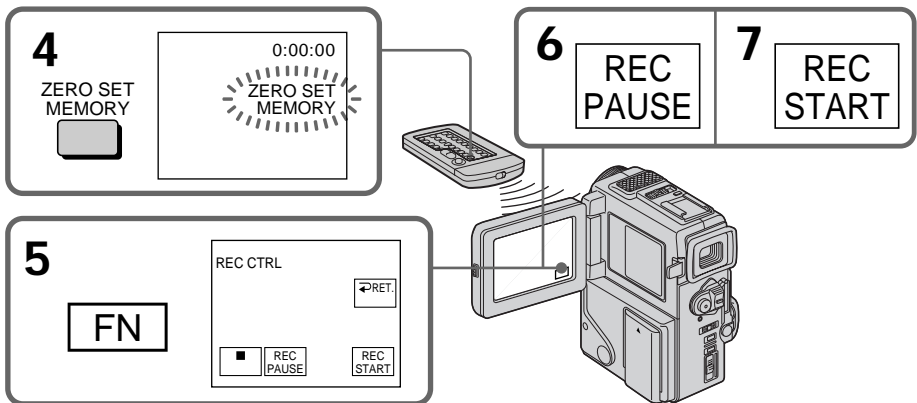

To change the insert end point

Press ZERO SET MEMORY again after step 5 to erase the ZERO SET MEMORY indicator and begin from step 3.

Using the Remote Commander

Press REC and the button on its right simultaneously, then immediately press **II** in the step 5 and 6. And in the step 7, press **II** at the scene where you want to start recording from.

Note

The picture and sound recorded on the section between the insert start and end points will be erased when you insert the new scene.

If you insert scenes on the tape recorded with other camcorder (including other DCR-PC3)

The picture and sound may be distorted. We recommend that you insert scenes on a tape recorded with your camcorder.

When the inserted picture is played back

The picture and sound may be distorted at the end of the inserted section. This is not a malfunction.

The sound at the start point and the end point may be distorted in the LP mode.

To insert a scene without setting the insert end point

Skip step 3 and 4. Press **■** when you want to stop inserting.

If you press FN

The ZERO SET MEMORY indicator is not disappeared.

Audio dubbing

You can record an audio sound to add to the original sound on a tape by connecting audio equipment or a microphone. If you connect the audio equipment, you can add sound to your recorded tape by specifying starting and ending points. The original sound will not be erased.

Use the Remote Commander for this operation.

Connecting the microphone with the MIC jack

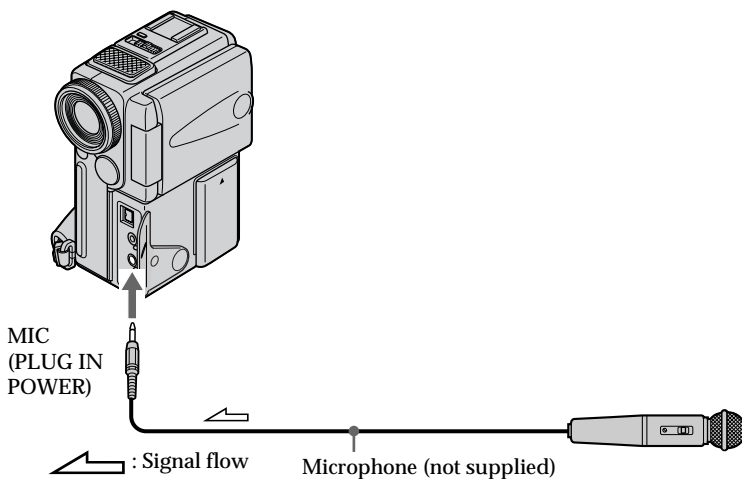

You can check the recorded picture and sound by connecting the AUDIO/VIDEO jack to a TV.

The recorded sound is not output from a speaker. Check the sound by using the TV or headphones.

Audio dubbing

Dubbing with the AUDIO/VIDEO jack

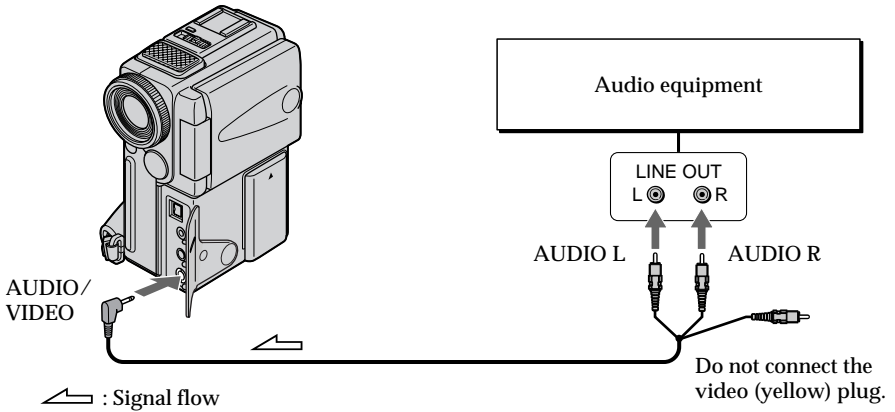

Note

The picture is not output from the AUDIO/VIDEO jack. Check the recorded picture on the LCD screen or in the viewfinder, as well as check the recorded sound by using a speaker or headphones.

Dubbing with the built-in microphones

No connection is necessary.

Note

The picture is not output from the AUDIO/VIDEO jack. Check the recorded picture on the LCD screen or in the viewfinder, as well as check the recorded sound by using a speaker or headphones.

Audio dubbing

Adding an audio sound on a recorded tape

- (1) Insert your recorded tape into your camcorder.
- (2) Set the POWER switch to VTR.
- (3) Locate the recording start point by pressing ► on the Remote Commander. Then press ■ at the point where you want to start recording to set your camcorder to playback pause mode.
- (4) Press AUDIO DUB on the Remote Commander. The green ●■ appears on the LCD screen.
- (5) Press ►■ on your camcorder or ■ on the Remote Commander and at the same time start playing back the audio you want to record. The new sound is recorded in stereo 2 (ST2) during playback. During recording new sound, the red ● appears on the LCD screen.
- (6) Press ■ on your camcorder or on the Remote Commander at the point where you want to stop recording.

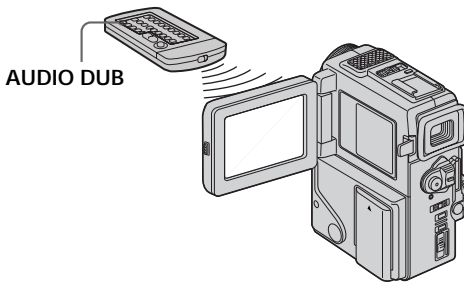

Monitoring the new recorded sound

To play back the sound

Adjust the balance between the original sound (ST1) and the new sound (ST2) by selecting AUDIO MIX in the menu settings (p. 76).

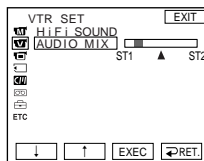

Five minutes after when you disconnect the power source or remove the battery pack, the setting of AUDIO MIX returns to the original sound (ST1) only. The default setting is original sound only.

Audio dubbing

Notes

- New sound cannot be recorded on a tape already recorded in the 16-bit mode (32 kHz, 44.1 kHz or 48 kHz) (p. 80).
- New sound cannot be recorded on a tape already recorded in the LP mode.
- You cannot add audio with the  DV IN/OUT jack.

If you make all the connections

The audio input to be recorded will take precedence over others in the following order.

- MIC (PLUG IN POWER) jack
- AUDIO/VIDEO jack
- Built-in microphone

If an i.LINK cable (DV connecting cable) is connected to your camcorder

You cannot add a sound to a recorded tape.

If you set the write-protect tab of the tape to lock

You cannot record on a tape. Slide the write-protect tab to release the write protection.

We recommend that you add new sound on a tape recorded with your camcorder

If you add new sound on a tape recorded with another camcorder (including other DCR-PC3), the sound quality may become worse.

To add new sound more precisely

Press ZERO SET MEMORY at the point where you want to stop recording later in the playback mode.

Carry out steps 3 to 5. Recording automatically stops at the point where ZERO SET MEMORY was pressed.

Superimposing a title

CM
only

If you use a tape with cassette memory, you can superimpose the title while recording or after recording. When you play back the tape, the title is displayed for five seconds from the point where you superimposed it.

You can select one of eight preset titles and two custom titles (p. 72). You can also select the color, size and position of titles.



- (1) In the standby/recording/playback/playback pause mode, press FN and select PAGE2 (p. 15).
- (2) Press TITLE. The screen to select a title appears on the LCD screen.
- (3) Select with ↓/↑, and then press EXEC.
- (4) Press ↓/↑ to select a desired title, and then press EXEC. The title appears on the LCD screen.
- (5) If necessary, change the color, size, or position by pressing COLOR, SIZE, POS ↓ or POS ↑.
- (6) Press TITLE OK.
- (7) Press SAVE TITLE.

In the playback, playback pause or recording mode:

The "TITLE SAVE" indicator appears on the screen for 5 seconds and the title is set.

In the standby mode:

The "TITLE" indicator appears. And when you press START/STOP to start recording,

"TITLE SAVE" appears on the screen for 5 seconds and the title is set.

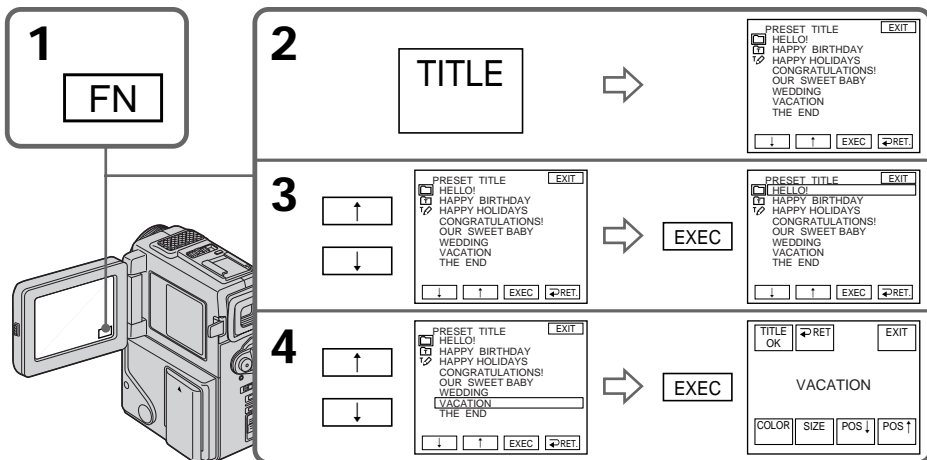

Superimposing a title

If you set the write-protect tab to lock

You cannot superimpose or erase the title. Slide the write-protect tab to release the write protection.

To use the custom title

If you want to use the custom title, select  in step 3.

If the tape has a blank portion

You cannot superimpose a title on the tape.

If the tape has a blank portion in the middle of the recorded parts

The title may not be displayed correctly.

The titles superimposed with your camcorder

- They are displayed by only the DV ^{Mini} DV format video equipment with index titler function.
- The point you super imposed the title may be detected as an index signal when searching a recording with other video equipment.

If the tape has too many index signals

You may not be able to superimpose a title because the memory is full. In this case, delete titles you do not need.

Not to display title

Set TITLE DISP to OFF in the menu settings.

Title setting

- The title color changes as follows:
WHITE → YELLOW → VIOLET → RED → CYAN → GREEN → BLUE
- The title size changes as follows:
SMALL ↔ LARGE
You cannot input more than 12 characters in LARGE size.
- If you select the title size "SMALL", you have nine choices for the title position.
If you select the title size "LARGE", you have eight choices for the title position.

One cassette can have up to about 20 titles, if one title consists of 5 characters

However, if the cassette memory is full with date, photo and cassette label data, one cassette can have only up to about 11 titles with 5 characters each.

Cassette memory capacity is as follows:

- 6 date data (maximum)
- 12 photo data (maximum)
- 1 cassette label (maximum)

Superimposing a title

Erasing a title

- (1) Set the POWER switch to VTR.
- (2) Press to FN to display PAGE1 (p. 15).
- (3) Press MENU to display the menu.
- (4) Select  with ↓/↑, and then EXEC.
- (5) Select TITLEERASE with ↓/↑, and then EXEC. The screen to erase a title appears.
- (6) Select the title you want to erase with ↓/↑, and then press EXEC.
“ERASE OK?” indicator appears.
- (7) Make sure the title is the one you want to erase, and press OK.

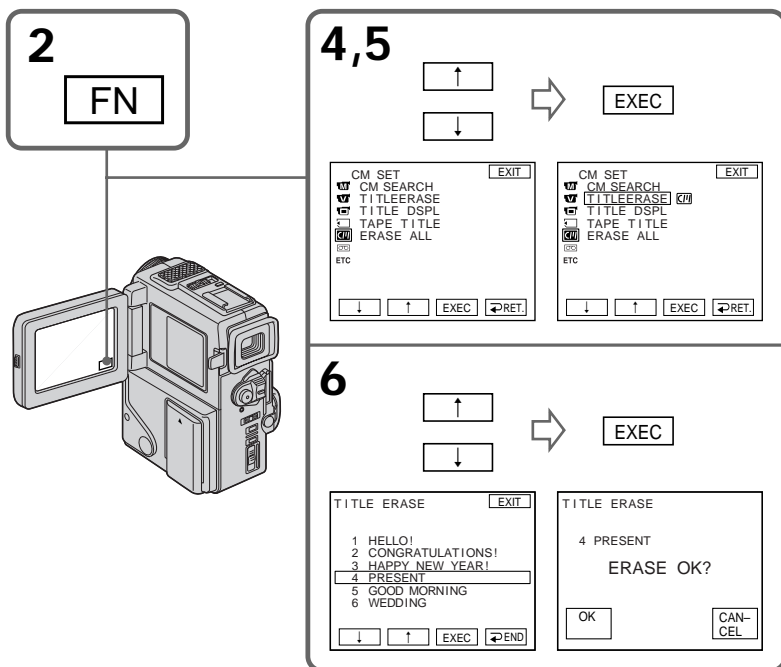

To return to FN

Press EXIT.

To cancel erasing

Press CANCEL in step 7.

Making your own titles

CM
only

You can make up to two titles and store them in Cassette Memory. Each title can have up to 20 characters.

- (1) In the standby/playback/playback pause mode, press FN, and select PAGE2 (p. 15).
- (2) Press TITLE.
- (3) Select CUSTOM1 SET or CUSTOM2 SET with ↓/↑, and press EXEC.
- (4) Select the desired character. Repeat pressing a key to select the desired character on the key.
- (5) Press → to move the cursor for the next character. Repeat the same procedure as step 5 and 6 to complete your title.
- (7) Press SET. The title is stored in memory.

1

FN

2

↑

↓

TITLE SET
CUSTOM1 SET
CUSTOM2 SET

EXEC

3

↑

↓

TITLE SET
CUSTOM1 SET
CUSTOM2 SET

EXEC

5,6

TITLE SET
[PAR] [ABC] [DEF] [←] [→]

SET

Making your own titles

To return to FN

Press EXIT.

To change a title you have stored

In step 4, select CUSTOM1 SET or CUSTOM2 SET, depending on which title you want to change, then press EXEC. and then enter the new title as desired.

If you take 5 minutes or longer to enter characters in the standby mode while a cassette is in your camcorder

The power automatically goes off. The characters you have entered remain stored in memory. Set the POWER switch to OFF once and then to CAMERA again, then complete your title.

We recommend setting the playback or playback pause mode or removing the cassette so that your camcorder does not automatically turn off while you are entering title characters.

To erase the title

Press ←. The last character is erased.

To enter a space

Press →.

To enter the same character on the same button in succession

Press → to move the cursor to the next position, and enter the character.

Labeling a cassette

CM only

If you use a tape with cassette memory, you can label a cassette. The label can consist of up to 10 characters and is stored in cassette memory. When you insert the labeled cassette and set the POWER switch to VTR, the label is displayed for about 5 seconds.

- (1) Insert the cassette you want to label.
- (2) Set the POWER switch to VTR.
- (3) Press FN to display PAGE1 (p. 15).
- (4) Press MENU to display the menu.
- (5) Select **CM** with ↓/↑, and then EXEC.
- (6) Select TAPE TITLE, then press EXEC. The screen to enter the label appears.
- (7) Select a desired character. Repeat pressing a key to select the desired character on the key.
- (8) Press → to move the cursor for the next character. Repeat the same procedure as step 7 and 8 to complete the label.
- (9) Press SET. The label is stored in memory.

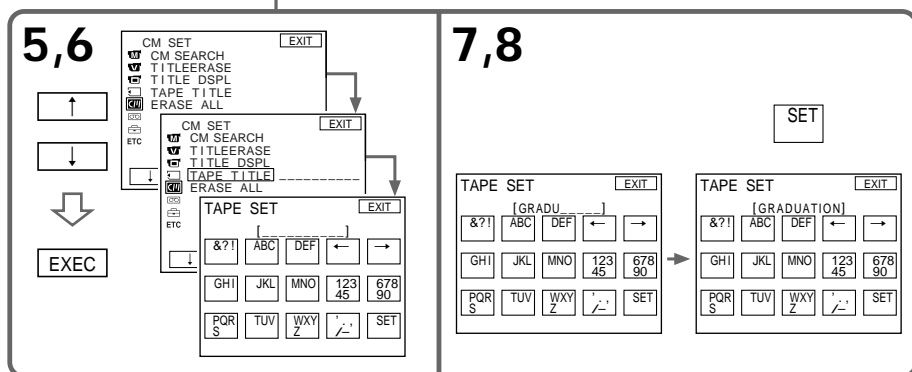
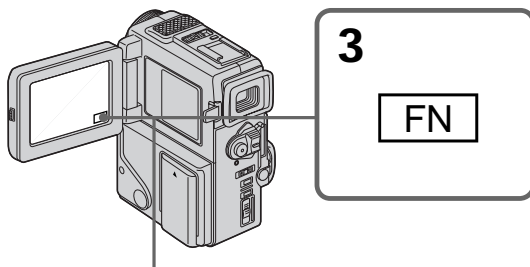

Labeling a cassette

To return to FN

Press EXIT.

To erase a character

Select ← in step 6. The last character is erased.

To change the label you have made

Insert the cassette to change the label, and operate in the same way to make a new label.

If you set the write-protect tab of the tape to lock

You cannot label the tape. Slide the write-protect tab to release the write protection.

If the mark appears

The cassette memory is full. If you erase the title in the cassette, you can label it.

If you have superimposed titles in the cassette

When the label is displayed, up to 4 titles also appear.

When you set the POWER switch to CAMERA

The label you have superimposed on is displayed for two seconds.

When the "-----" indicator has fewer than 10 spaces

The cassette memory is full.

The "-----" indicates the number of characters you can select for the label.

To erase the title

Press ←. The last character is erased.

To enter a space

Press →.

To enter the same character on the same button in succession

Press → to move the cursor to the next position, and enter the character.

Changing the menu settings

To change the mode settings in the menu settings, select the menu items with ↓/↑ dial. The default settings can be partially changed. First, select the icon, then the menu item and then the mode.

- (1) In the standby, VTR, or MEMORY mode, press FN to display PAGE1 (p. 15).
- (2) Press MENU to display the menu.
- (3) Press ↓/↑ to select a desired icon, and press EXEC.
- (4) Press ↓/↑ to select a desired item, and press EXEC.
- (5) Press ↓/↑ to select a desired setting.
- (6) Repeat steps from 3 to 5 if you want to change other items. Press ↶ RET. to return to step 3.

For details, see “Selecting the mode setting of each item” (p. 77).

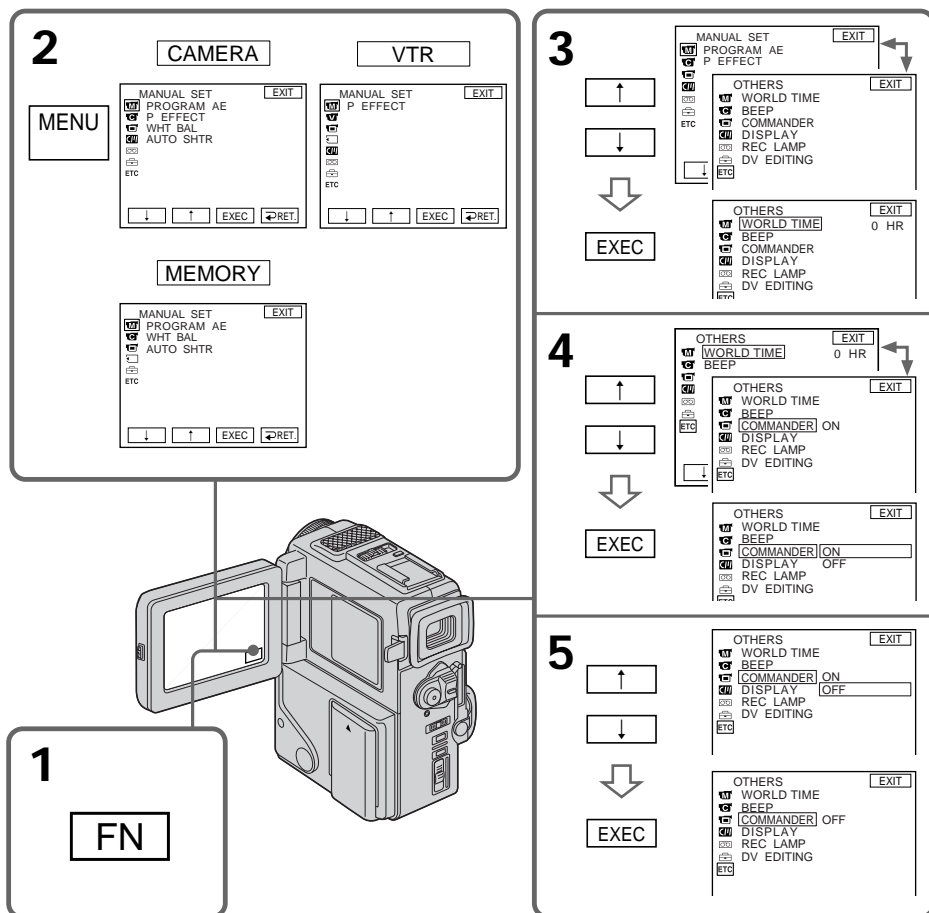

Changing the menu settings

To return to FN



Press EXIT.

Menu items are displayed as the following icons:

-  MANUAL SET
-  CAMERA SET
-  VTR SET
-  LCD/VF SET
-  MEMORY SET
-  CM SET
-  TAPE SET
-  SETUP MENU
-  OTHERS

Selecting the mode setting of each item ● is the default setting.

Menu items differ depending on the position of the POWER switch.
The LCD screen shows only the items you can operate at the moment.

Icon/item	Mode	Meaning	POWER switch
 PROGRAM AE		To suit your specific shooting requirement (p. 43)	CAMERA MEMORY
P EFFECT		To add special effects like those in films or on the TV to images (p. 37)	CAMERA VTR
WHT BAL		To adjust the white balance (p. 42)	CAMERA MEMORY
AUTO SHTR	● ON	To automatically activate the electronic shutter when shooting in bright conditions	CAMERA MEMORY
	OFF	To not automatically activate the electronic shutter even when shooting in bright conditions	
 D ZOOM	● OFF	To deactivate digital zoom. Up to 10× zoom is carried out.	CAMERA MEMORY
	ON	To activate digital zoom. More than 10× to 120× zoom is performed digitally (p. 21)	
16:9WIDE	● OFF	—	CAMERA
	ON	To record a 16:9 wide picture (p. 33)	
STEADYSHOT	● ON	To compensate for camera-shake	CAMERA MEMORY
	OFF	To cancel the SteadyShot function. Natural pictures are produced when shooting a stationary object with a tripod.	
N.S. LIGHT	● ON	To use the NightShot Light function (p. 24)	CAMERA MEMORY
	OFF	To cancel the NightShot Light function	





Notes on the SteadyShot function

- The SteadyShot function will not correct excessive camera-shake.
- Attachment of a conversion lens (not supplied) may influence the SteadyShot function.

If you cancel the SteadyShot function

The SteadyShot off indicator  appears. Your camcorder prevents excessive compensation for camera-shake.

Changing the menu settings

Icon/item	Mode	Meaning	POWER switch
 HIFI SOUND	● STEREO	To play back a stereo tape or dual sound track tape with main and sub sound	VTR
	1	To play back a stereo tape with the left sound or a dual sound tape with main sound	
	2	To play back a stereo tape with the right sound or a dual sound track tape with sub sound	
AUDIO MIX		To adjust the balance between the stereo 1 and stereo 2 (p. 67)	VTR
			
 LCD B. L.	● BRT NORMAL	To set the brightness on the LCD screen normal	VTR
	BRIGHT	To brighten the LCD screen	CAMERA MEMORY
LCD COLOR		To adjust the color on the LCD screen with -/+	VTR CAMERA MEMORY
			
		To lighten ← → To darken	
VF BRIGHT		To adjust the brightness on the viewfinder screen with -/+	VTR CAMERA MEMORY
			
		To darken ← → To lighten	

Notes on LCD B.L.

When you use power sources other than the battery pack, "BRIGHT" is automatically selected.



Note on NP-F10/FS11 battery pack

You cannot select BRIGHT in LCD B.L.

Changing the menu settings

Icon/item	Mode	Meaning	POWER switch
☐ CONTINUOUS	● OFF	Not to record continuously	MEMORY
	ON	To record 3 or 4 pictures continuously (p. 91)	
	MULTI SCRΝ	To record 9 pictures continuously (p. 91)	
QUALITY	● FINE	To record still pictures in the fine image quality mode, using the “Memory Stick”	VTR MEMORY
	STANDARD	To record still pictures in the standard image quality mode, using the “Memory Stick”	
FLD./FRAME	● FIELD	To record moving subjects	MEMORY
	FRAME	To record stopping subjects in high quality	
SLIDE SHOW		To play back images in a continuous loop (p. 104)	MEMORY
DELETE ALL		To delete all the images (p. 106)	MEMORY
FORMAT		To format “Memory Stick”s	MEMORY
PHOTO SAVE		To duplicate still pictures (p. 98)	VTR
☑ CM SEARCH	● ON	To search using cassette memory (p. 50)	VTR
	OFF	To search without using cassette memory	
TITLEERASE		To erase the title you have superimposed (p. 71)	VTR CAMERA
TITLE DSPL	● ON	To display the title you have superimposed	VTR
	OFF	Not to display the title	
TAPE TITLE		To label a cassette (p. 74)	VTR CAMERA
ERASE ALL		To erase all the data in cassette memory	VTR CAMERA

Changing the menu settings

Icon/item	Mode	Meaning	POWER switch
 REC MODE	● SP	To record in the SP (Standard Play) mode	VTR CAMERA
	LP	To increase the recording time to 1.5 times the SP mode	
AUDIO MODE	● 12BIT	To record in the 12-bit mode (two stereo sounds)	VTR CAMERA
	16BIT	To record in the 16-bit mode (the one stereo sound with high quality)	
 REMAIN	● AUTO	To display the remaining tape bar: <ul style="list-style-type: none"> • for about 8 seconds after your camcorder is turned on and calculates the remaining amount of tape • for about 8 seconds after a cassette is inserted and your camcorder calculates the remaining amount of tape • for about 8 seconds after the playback button is pressed in VTR mode • for about 8 seconds after DISPLAY is pressed to display the screen indicators • for the period of tape rewinding, forwarding or picture search in the VTR mode 	VTR CAMERA
	ON	To always display the remaining tape indicator	
DATA CODE	● DATE/CAM	To display date, time and various settings during playback	VTR
	DATE	To display date and time during playback	
 CLOCK SET		To reset the date or time (p. 82)	CAMERA MEMORY
DEMO MODE	● ON	To make the demonstration appear	CAMERA
	OFF	To cancel the demonstration mode	

Notes on the LP mode

- When you record a tape in the LP mode on your camcorder, we recommend playing the tape on your camcorder. When you play back the tape on other camcorders or VCRs, noise may occur in pictures or sound.
- When you record in the LP mode, we recommend using a Sony Excellence/Master mini DV cassette so that you can get the most out of your camcorder. Noise may occur in pictures and sound when you record image on other than a Sony Excellence/Master mini DV cassette.
- You cannot make audio dubbing on a tape recorded in the LP mode. Use the SP mode for the tape to be audio dubbed.
- When you record in the SP and LP modes on one tape or you record some scenes in the LP mode, the playback picture may be distorted or the time code may not be written properly between scenes.

Notes on AUDIO MODE

- You cannot dub audio sound on a tape recorded in the 16BIT mode.
- When playing back a tape recorded in the 16-bit mode, you cannot adjust the balance in AUDIO MIX.

Changing the menu settings

Icon/item	Mode	Meaning	POWER switch
WORLD TIME		To set the clock to the local time. Press ↓/↑ to set a time difference. The clock changes by the time difference you set here. If you set the time difference to 0, the clock returns to the originally set time.	CAMERA MEMORY
BEEP	● MELODY	To output the melody when you start/stop recording or when an unusual condition occurs on your camcorder	VTR CAMERA MEMORY
	NORMAL	To output the beep instead of the melody	
	OFF	To cancel the melody and beep sound	
COMMANDER	● ON	To activate the Remote Commander supplied with your camcorder	VTR CAMERA MEMORY
	OFF	To deactivate the Remote Commander to avoid remote control misoperation caused by other VCR's remote control	
DISPLAY	● LCD	To show the display on the LCD screen and viewfinder	VTR CAMERA MEMORY
	V-OUT/LCD	To show the display on the TV screen, LCD screen and viewfinder	
REC LAMP	● ON	To light up the camera recording lamp at the front of your camcorder	CAMERA MEMORY
	OFF	To turn the camera recording lamp off so that the subject is not aware of the recording	
DV EDITING		To duplicate the desired portion on a tape by simply selecting the scenes to edit, using other equipment connected with an i.LINK cable (DV connecting cable) (p. 57)	VTR

Notes on DEMO MODE

- You cannot select DEMO MODE when a cassette is inserted in your camcorder.
- DEMO MODE is set to STBY (Standby) at the factory and the demonstration starts about 10 minutes after you have set the POWER switch to CAMERA without a cassette inserted.
To cancel the demonstration, insert a cassette, set the POWER switch to other than CAMERA, or set DEMO MODE to OFF.
- If you press the touch panel during the demonstration, the demonstration stops for a while, then it starts again after about 10 minutes.
- When NIGHTSHOT is set to ON, the NIGHTSHOT indicator appears in the viewfinder or on the LCD screen and you cannot select DEMO MODE in the menu settings.

Note

If you press DISPLAY/TOUCH PANEL with "DISPLAY" set to "V-OUT/LCD" in the menu settings, the picture from a TV or VCR will not appear on the LCD screen even when your camcorder is connected to outputs on the TV or VCR.

In more than 5 minutes after removing the power source

The "AUDIO MIX", "COMMANDER" and "HiFi SOUND" items are returned to their default settings.

The other menu items are held in memory even when the battery is removed.

When recording a close subject

When REC LAMP is set to ON, the red camera recording lamp on the front of the camcorder may reflect on the subject if it is close. In this case, we recommend you set REC LAMP to OFF.

Resetting the date and time

The default clock setting is set to East Coast Standard Time.

If you do not use your camcorder for about three months, the date and time settings may be released (bars may appear) because the vanadium-lithium battery installed in your camcorder will have been discharged.

First, set the year, then the month, the day, the hour and then the minute.

- (1) In the standby mode, press FN to display PAGE1 (p. 15).
- (2) Press MENU to display the menu.
- (3) Select  with ↓/↑, and press EXEC.
- (4) Select CLOCK SET with ↓/↑, and press EXEC.
- (5) Adjust the desired year, then press EXEC.
- (6) Set the month, day and hour with the same procedure as step 5.
- (7) Set the minute with ↓/↑, and press EXEC by the time signal.

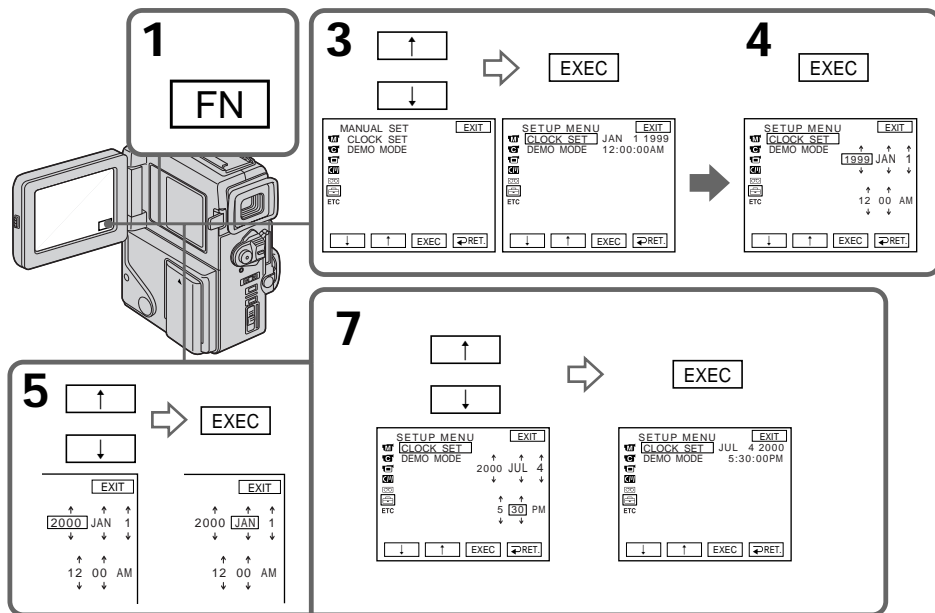

The year changes as follows:

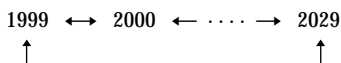

To return to FN

Press EXIT.

If you do not set the date and time

“--:--:--” is recorded on the data code of the tape and the “Memory Stick”.

Note on the time indicator

The internal clock of your camcorder operates on a 12-hour cycle.

- 12:00 AM stands for midnight.
- 12:00 PM stands for noon.

Using a “Memory Stick” –introduction

You can record and play back still images on a “Memory Stick” supplied with your camcorder. You can easily play back, record or delete still images. You can format “Memory Stick”s. You can also protect still images and write print marks on still images in “Memory Stick”s. You can exchange image data with other equipment such as a personal computer etc., using the Serial port adaptor for “Memory Stick” supplied with your camcorder or MSAC-PC1 PC card adaptor for “Memory Stick” (not supplied).

Using a “Memory Stick”

When you use a “Memory Stick”

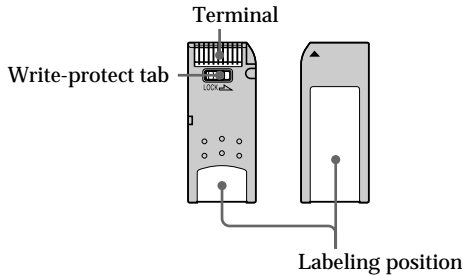

- You cannot record or erase still images when the write-protect tab on the “Memory Stick” is set to LOCK.
- We recommend backing up important data.
- When the ACCESS lamp is flashing, never remove the “Memory Stick”.
- Image data may be damaged in the following cases:
 - If you remove the “Memory Stick”, turn the power off, or detach the battery for replacement when the ACCESS lamp is flashing
 - If you use “Memory Stick”s near magnets or magnet fields such as those of speakers and televisions.

On file format (JPEG)

Your camcorder compresses image data in JPEG format (extension .jpg).

Typical image data file name

DSC00001.jpg.

Using a “Memory Stick”–introduction

Notes

- Prevent metallic objects or your finger from coming into contact with the metal parts of the connecting section.
- Stick its label on the labeling position.
- Do not bend, drop or apply strong shock to “Memory Stick”s.
- Do not disassemble or modify “Memory Stick”s.
- Do not let “Memory Stick”s get wet.
- Do not use or keep “Memory Stick”s in locations that are:
 - Extremely hot such as in a car parked in the sun or under the scorching sun
 - Under direct sunlight
 - Very humid or subject to corrosive gases
- When you carry or store a “Memory Stick”, put it in its case.

You do not need to format the “Memory Stick” supplied with your camcorder

The “Memory Stick” supplied with your camcorder is already formatted in FAT format. FAT format is the standard format for “Memory Stick”s and is supported by your camcorder.

Note

Sample images are already recorded on the “Memory Stick” supplied with your camcorder. All of these sample images will be deleted if you format the “Memory Stick”.

“Memory Stick”s formatted on a personal computer

“Memory Stick” operations on your camcorder cannot be assured if the “Memory Stick” is formatted on a Windows machine or Macintosh.

Note on image data compatibility

- Image data files recorded on “Memory Stick”s by your camcorder conform with the Design Rules for Camera File Systems universal standard established by the JEIDA (Japan Electronic Industry Development Association). You cannot play back on your camcorder still images recorded on other equipment (DCR-TRV890E/TRV900/TRV900E or DSC-D700) that does not conform with this universal standard. (These models are not sold in some areas.)
- If you cannot use a “Memory Stick” that has been used on other equipment, format the “Memory Stick” on your camcorder following the steps on page 89. Note that all images on the “Memory Stick” will be deleted if you format it.

“Memory Stick” is a trademark of Sony Corporation.

Using a "Memory Stick"-introduction

Inserting a "Memory Stick"

Insert a "Memory Stick" in as far as it can go with the ▲ mark facing up.

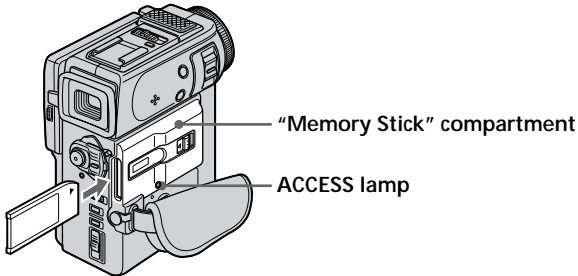

To eject a "Memory Stick"

Slide MEMORY RELEASE in the direction of the arrow.

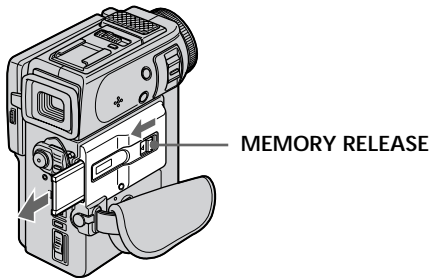

When the ACCESS lamp is lit or flashing

Never shake or strike your camcorder. Do not turn the power off, eject a "Memory Stick" or remove the battery pack. Otherwise, the image data breakdown may occur.

Using a "Memory Stick"—introduction

Using a touch panel

Your camcorder has operation buttons on the LCD screen. Press the LCD panel directly to operate each function.

- (1) Set the POWER switch to MEMORY while pressing the small green button. Make sure that the LOCK is set to the right (unlock) position.
- (2) Press OPEN to open the LCD panel. Operation buttons appear on the LCD screen. You can switch the memory playback/the memory camera mode by pressing PLAY/CAM. You can also use the Remote Commander for this operation.
- (3) Press FN. Operation buttons appear on the LCD screen.
- (4) Press PAGE2 to go to PAGE2. Operation buttons appear on the LCD screen.
- (5) Press a desired operation item.
Refer to relevant pages for each function.

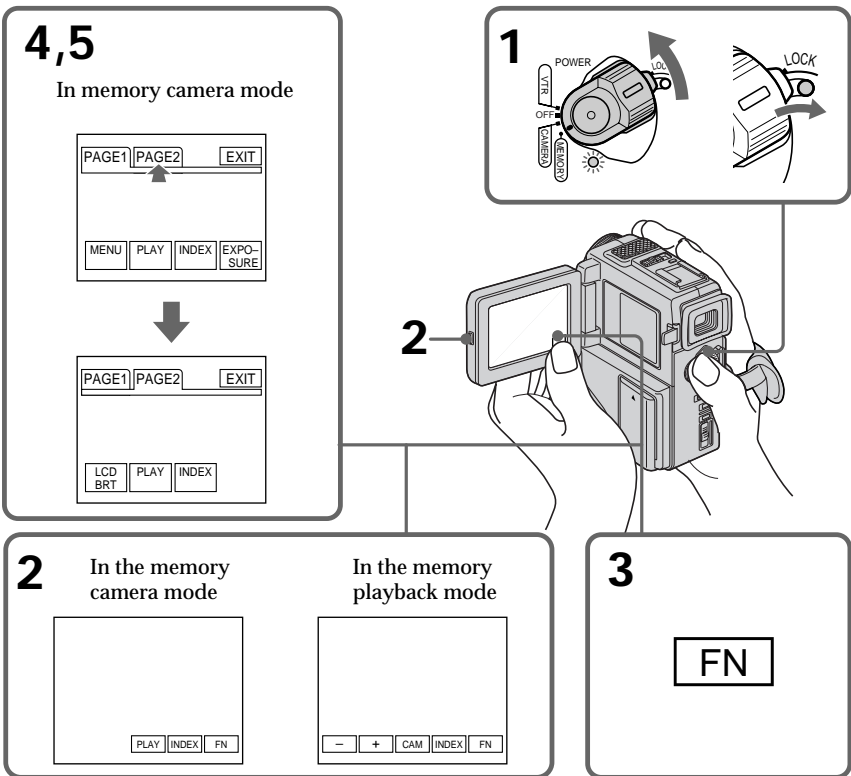

To execute settings

Press EXEC or ↵ OK.

To cancel settings

Press ↵ OFF to return to PAGE1/PAGE2.

To return to FN

Press EXIT.

Using a “Memory Stick”–introduction

Note

- When using the touch panel, press operation buttons with your thumb supporting the LCD screen from the back side of it or press those buttons lightly with your index finger. Do not press them with sharp objects such as pens.
- Do not touch the LCD screen with wet hands.
- If FN is not on the LCD screen, touch the LCD screen lightly to make it appear. You can control the display with DISPLAY/TOUCH PANEL on your camcorder.
- When operation buttons do not work even if you press them, an adjustment (CALIBRATION) is required (p. 124).
- When executing each item, the green bar appears above the item.
- The color of the items changes to grey if they are not available.
- You can operate with the touch panel using the viewfinder (p. 110).

Press FN to display the following buttons:

In memory camera mode

PAGE1	MENU, PLAY, INDEX, EXPOSURE
PAGE2	LCD BRIGHT, PLAY, INDEX

In memory playback mode

PAGE1	MENU, CAM, INDEX, DELETE,  , 
PAGE2	LCD BRIGHT, CAM, INDEX,  , 

Selecting image quality mode

You can select image quality mode in still picture recording. If you do not make any selection, the unit automatically records in FINE mode.

- (1) Set the POWER switch to MEMORY. Make sure that the LOCK is set to the right (unlock) position.
- (2) Press FN to display PAGE1 (p. 86).
- (3) Press MENU, then select QUALITY in  in the menu settings to select a desired image quality.

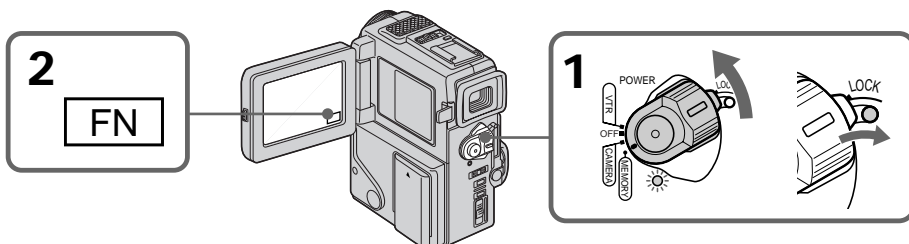

To return to FN

Press EXIT.

Using a “Memory Stick”–introduction

Note

In some cases, changing the image quality mode may not affect the image quality, depending on the types of images you are shooting.

Image quality settings

Setting	Meaning
FINE (FINE)	Use this mode when you want to record high quality images. The image is compressed to about 1/6. FINE appears on the screen.
STANDARD (STD)	This is the standard image quality. The image is compressed to about 1/10. STD appears on the screen.

Differences in image quality mode

Recorded images are compressed in JPEG format before being stored into memory. The memory capacity allotted to each image varies depending on the selected image quality mode. Details are shown in the table below. (The number of pixels is 640×480 , regardless of image quality mode. The data size before compression is about 600 KB.)

Image quality mode	Memory capacity
FINE	About 100 KB
STANDARD	About 60 KB

Approximate number of images you can record on a “Memory Stick”

The number of images you can record varies depending on which image quality mode you select and the complexity of the subject.

4MB type:

FINE (FINE)	40 images (maximum)
STANDARD (STD)	60 images (maximum)

8MB type:

FINE (FINE)	81 images (maximum)
STANDARD (STD)	122 images (maximum)

16MB type:

FINE (FINE)	164 images (maximum)
STANDARD (STD)	246 images (maximum)

Using a “Memory Stick”

Formatting (initializing) a “Memory Stick”

Your camcorder can format (initialize) a “Memory Stick”. If you format a “Memory Stick”, all data stored in the “Memory Stick” will be deleted. This function is convenient when you want to delete all data including protected images.

New “Memory Stick”s are already formatted so that formatting is not required for them.

Sample images are stored in the supplied “Memory Stick”. Note that these sample images will be deleted if you format the “Memory Stick”.

- (1) Insert a “Memory Stick” into your camcorder.
- (2) Set the POWER switch to MEMORY while pressing the small green button. Make sure that the LOCK is set to the right (unlock) position.
- (3) Press FN to display PAGE1 (p. 86).
- (4) Press MENU, then select FORMAT in  in the menu settings.
- (5) Press ↓/↑ to select FORMAT on the right and then press EXEC. The display shows “OK.”
- (6) Press EXEC. again. The display shows “FORMATTING”, and formatting procedure begins. When formatting is finished, the display shows “COMPLETE.”

To return to FN

Press EXIT.

Check the contents of the “Memory Stick” before formatting

Note that all data in the “Memory Stick” including protected images will be deleted.

While “FORMATTING” is displayed

Do not turn the POWER switch nor press any button.

If “” is displayed during /after formatting

Format the “Memory Stick” again.

Note

You cannot format the “Memory Stick” if the write-protect tab on the “Memory Stick” is set to LOCK.

Recording still images on “Memory Stick”s – Memory photo recording

You can select the FIELD or FRAME mode in still picture recording. Your camcorder compensates for camera-shake when recording moving subjects in the FIELD mode. Your camcorder records still images in high quality in the FRAME mode. Select the FIELD or FRAME in the menu settings (p. 76).

Before operation

Insert a “Memory Stick” into your camcorder.

- (1) Set the POWER switch to MEMORY while pressing the small green button. The power lamp lights up. Make sure that the LOCK is set to the right (unlock) position.
- (2) Keep pressing PHOTO lightly. The picture freezes and “CAPTURE” appears on the LCD screen or in the viewfinder. Recording does not start yet.
- (3) Press PHOTO deeper. The image displayed on the screen will be recorded on a “Memory Stick”. Recording is complete when the bar scroll indicator disappears.

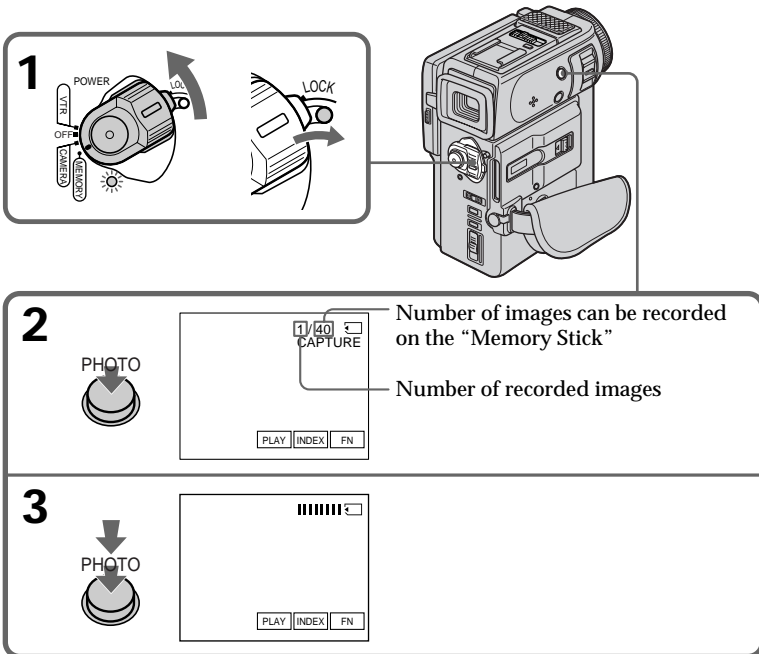

Notes

- When recording fast-moving subjects in the FRAME mode, the recorded image blurry.
- When recording in the FRAME mode, your camcorder may not correct camera-shake. We recommend that you shoot objects with a tripod.

When the POWER switch is set to MEMORY

The following functions do not work:

wide TV mode, digital effect, picture effect, title.

Recording still images on “Memory Stick”s – Memory photo recording

When you are recording a still image

You can neither turn off the power nor press PHOTO.

When you press the PHOTO button on the Remote Commander

Your camcorder immediately records the image that is on the screen when you press the button.

Recording images continuously

You can record still pictures continuously. Select one of the two modes described below before recording.

Continuous mode [a]

You can record 3 or 4 pictures continuously.

Multi screen mode [b]

You can record 9 still pictures continuously on a single page.

[a]



[b]



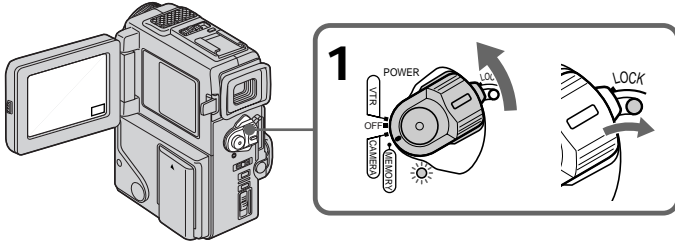

Recording still images on “Memory Stick”s – Memory photo recording

- (1) Set the POWER switch to MEMORY while pressing the small green button. Make sure that the LOCK is set to the right (unlock) position.
- (2) Press FN to display PAGE1 (p. 86).
- (3) Press MENU, then set CONTINUOUS to ON in  in the menu settings.



Continuous shooting settings

Setting	Meaning (indicator on the screen)
OFF	Your camcorder shoots one image at a time. (no indicator)
ON	Your camcorder shoots 3 or 4 still images at about 0.8 sec intervals. ()
MULTI SCRN	Your camcorder shoots 9 still images at about 0.3 sec intervals and displays the images on a single page divided into 9 boxes. ()

To return to FN

Press EXIT.

Number of images in continuous shooting

The number of images you can shoot continuously varies depending on the image quality mode.

FINE: 3 images

STANDARD: 4 images

Superimposing a still picture in a “Memory Stick” on a moving picture – MEMORY MIX

You can superimpose a still picture you have recorded on a “Memory Stick” on top of the moving picture you are recording.

M. CHROM (Memory chromakey)

You can swap a blue area of a still picture such as an illustration or a frame with a moving picture.

M. LUMI (Memory luminancekey)

You can swap a brighter area of a still picture such as a handwritten illustration or title with a moving picture. Record a title on a “Memory Stick” before a trip or event for convenience.

C. CHROM (Camera chromakey)

You can superimpose a moving picture on top of a still picture such as a picture can be used as background. Shoot the subject against a blue background. The blue area of the moving picture will be swapped with a still picture.

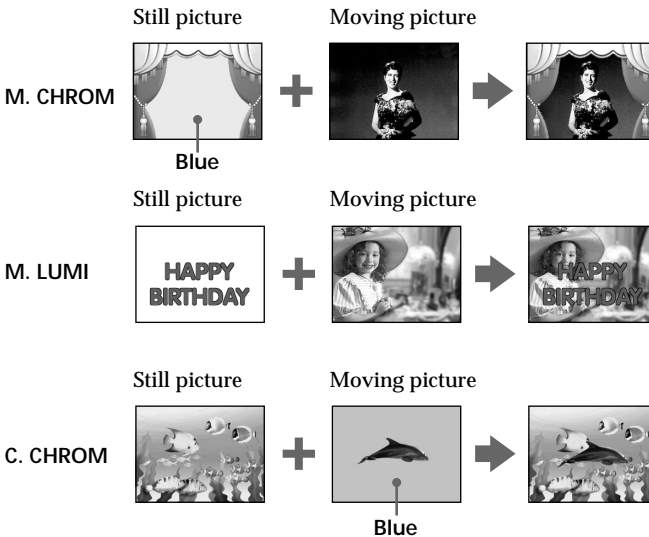

Superimposing a still picture in a “Memory Stick” on a moving picture – MEMORY MIX

Before operation

Insert a recorded “Memory Stick” on your camcorder.

- (1) Set the POWER switch to CAMERA while pressing the small green button.
- (2) In the standby mode, press FN to display PAGE1 (p. 15).
- (3) Press MEM MIX. The last recorded or last composed image appears on the lower part of the screen as a thumbnail image.
- (4) Press -/+ on the right lower corner of the screen or the Remote Commander to select the still picture which you want to superimpose.
- : to see the previous image
+ : to see the next image
- (5) Press a desired mode. The still picture is superimposed on the moving picture.
- (6) Press -/+ on the left lower corner of the screen to adjust the effect, then press \rightarrow OK to return to PAGE1.
- (7) Press EXIT to return to FN.
- (8) Press START/STOP to start recording.

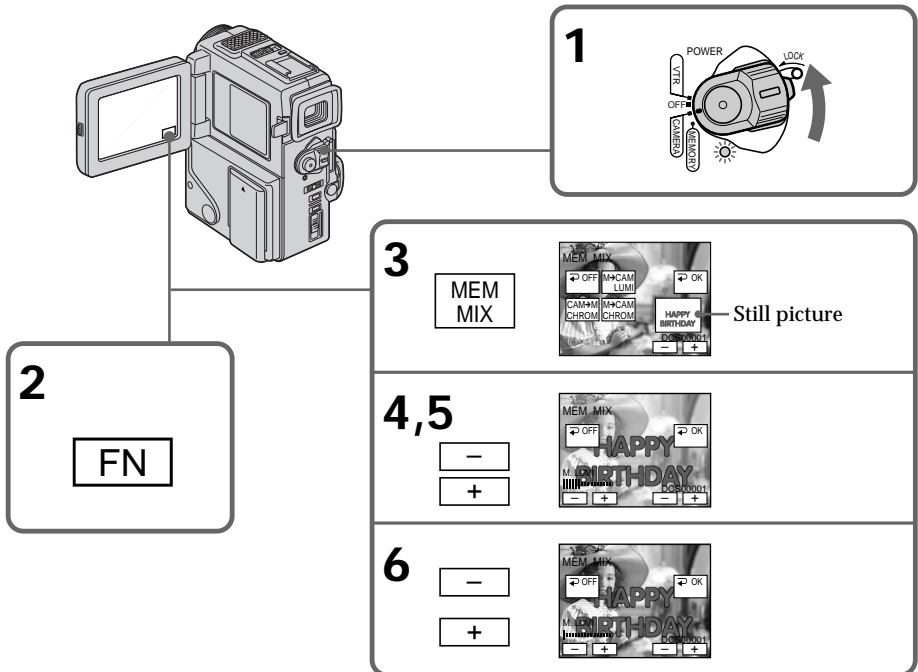

Superimposing a still picture in a “Memory Stick” on a moving picture – MEMORY MIX

Items to adjust

M. CHROM	The color (blue) scheme of the area in the still picture which is to be swapped with a moving picture
M. LUMI	The color (bright) scheme of the area in the still picture which is to be swapped with a moving picture
C. CHROM	The color (blue) scheme of the area in the moving picture which is to be swapped with a still picture

The fewer bars there are on the screen, the stronger the effect.

To change the still picture to superimpose

Press -/+ on the right lower corner before step 6.

To change the mode setting

Press \Rightarrow OFF before step 7, and repeat the procedure from step 2.

To cancel M. CHROM/M. LUMI/C. CHROM

Press \Rightarrow OFF to return to PAGE1/PAGE2.

During recording

You cannot change the mode setting.

The “Memory Stick” supplied with your camcorder stores 30 images

- For M. CHROM: 26 images (such as a frame) DSC00001~DSC00026
- For C. CHROM: 4 images (such as a background) DSC00027~DSC00030

Sample images

Sample images stored in the “Memory Stick” supplied with your camcorder are protected (p. 105).

If you format the “Memory Stick”

Sample images will be deleted.

To record a still picture which is added no effect on a mini DV tape

Press -/+ on the left corner to increase the bars to maximum in the M. LUMI mode in step 6.

Recording an image from a mini DV tape as a still image

Your camcorder can read moving picture data recorded on a mini DV tape and record it as a still image on a "Memory Stick". Your camcorder can also take in moving picture data through the input connector and record it as a still image on a "Memory Stick".

Before operation

Insert a recorded mini DV tape and a "Memory Stick" into your camcorder.

- (1) Set the POWER switch to VTR.
- (2) Press . The picture recorded on the mini DV tape is played back.
- (3) Keep pressing PHOTO lightly until the picture from the mini DV tape freezes. "CAPTURE" appears on the LCD screen or in the viewfinder. Recording does not start yet.
- (4) Press PHOTO deeper. The image displayed on the screen will be recorded on a "Memory Stick". Recording is complete when the bar scroll indicator disappears.

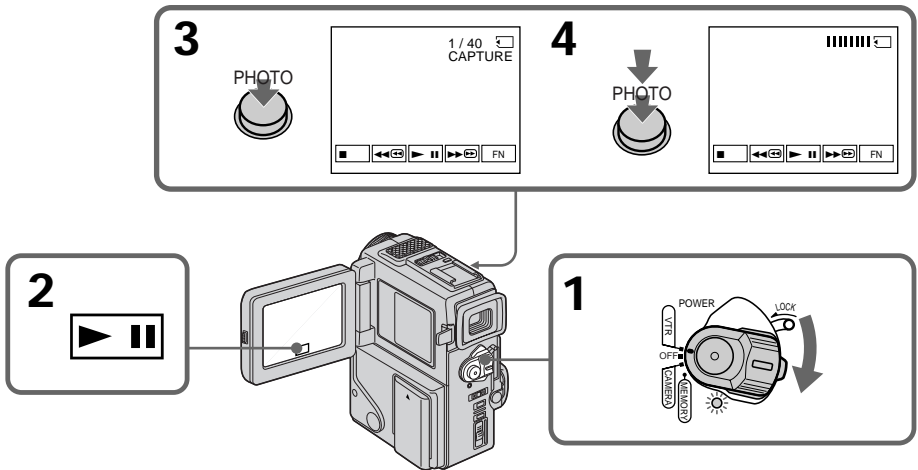

When the ACCESS lamp is lit or flashing

Never shake or strike the unit. As well do not turn the power off, eject a "Memory Stick" or remove the battery pack. Otherwise, the image data breakdown may occur.

If "E" appears on the LCD screen or in the viewfinder

The inserted "Memory Stick" is incompatible with your camcorder because its format does not conform with your camcorder. Check the format of the "Memory Stick".

If you press PHOTO lightly in the playback mode

Your camcorder stops momentarily.

Sound recorded on a mini DV tape

You cannot record the audio from a mini DV tape.

Titles have already recorded on mini DV tapes

You cannot record the titles on "Memory Stick"s. The title does not appear while you are recording a still picture with PHOTO.

When you press the PHOTO button on the Remote Commander

Your camcorder immediately records the image that is on the screen when you press the button.

Recording an image from a mini DV tape as a still image

Recording a still image from other equipment

- (1) Set the POWER switch to VTR.
- (2) Play back the recorded tape, or turn the TV on to see the desired program.
- (3) Follow the steps 3 and 4 on page 96.

When recording the image through the AUDIO/VIDEO jack

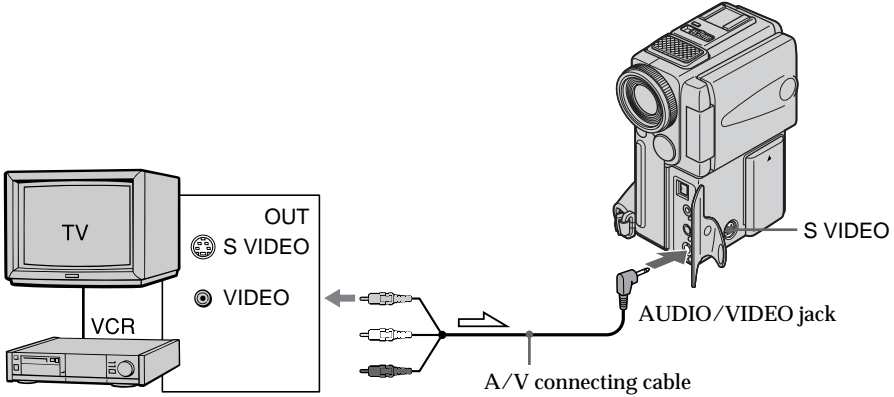

↗ : Signal flow

Connect the yellow plug of the A/V connecting cable to the video jack on the VCR or the TV.

When recording the image through the i DV IN/OUT jack

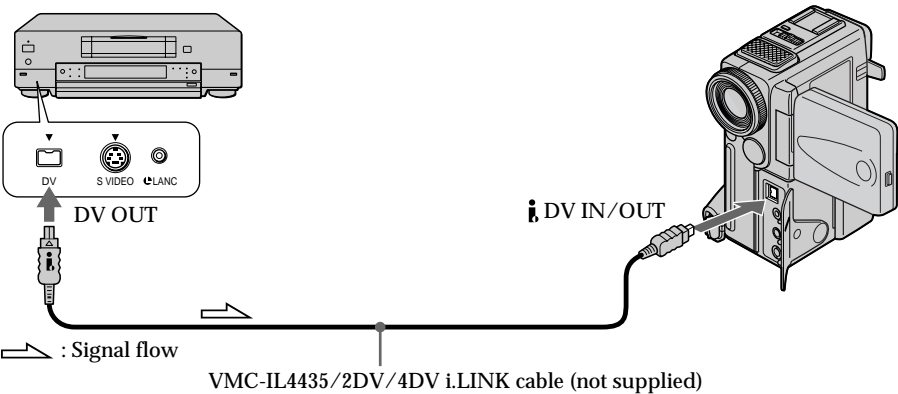

↗ : Signal flow

VMC-IL4435/2DV/4DV i.LINK cable (not supplied)

Connect using an S video cable (not supplied) to obtain high-quality pictures

With this connection, you do not need to connect the yellow (video) plug of the A/V connecting cable.

Connect an S video cable (not supplied) to the S (S1) video jacks of both your camcorder and the VCR/TV.

This connection produces higher quality DV format pictures.

Copying still images from a mini DV tape – Photo save

Using the search function, you can automatically take in only still images from mini DV tapes and record them on a “Memory Stick” in sequence.

Before operation

- Insert a recorded mini DV tape and rewind the tape.
- Insert a “Memory Stick” into your camcorder.

- (1) Set the POWER switch to VTR while pressing the small green button.
- (2) Press FN to display PAGE1 (p. 86).
- (3) Press MENU, then select PHOTO SAVE in  in the menu settings. “PHOTO BUTTON” appears on the LCD screen.
- (4) Press PHOTO deeper. The still image from the mini DV tape is recorded on a “Memory Stick”. The number of still images copied is displayed. “END” is displayed when copying is completed.

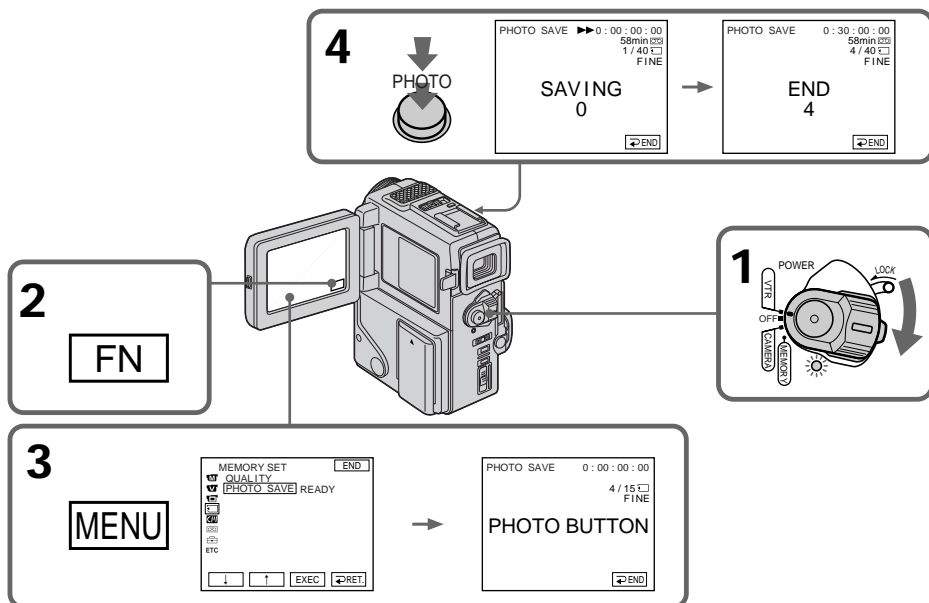

Copying still images from a mini DV tape – Photo save

To stop or end copying

Press **↵** END.

To return to FN

Press **↵** END to return to PAGE1/PAGE2, then press EXIT.

When the memory of the “Memory Stick” is full

“MEMORY FULL” appears on the LCD screen, and the copying stops. Press **↵** END, insert another “Memory Stick” and repeat the procedure from step 2.

When the ACCESS lamp is lit or flashing

Never shake or strike your camcorder. As well do not turn the power off, eject a “Memory Stick” or remove the battery pack. Otherwise, the image data breakdown may occur.

To record all the images recorded on the mini DV tape

Rewind the tape all the way back and start copying.

If the write-protect tab on the “Memory Stick” is set to LOCK

“NOT READY” appears when you select the item in the menu settings.

When you change “Memory Stick”s in the middle of copying

Your comcorder resumes copying from the last image recorded on the previous “Memory Stick”.

Viewing a still picture – Memory photo playback

You can play back still images recorded on a “Memory Stick”. You can also play back 6 images at a time by selecting the index screen.

Before operation

Insert a “Memory Stick” into your camcorder.

- (1) Set the POWER switch to MEMORY while pressing the small green button.
Make sure that the LOCK is set to the right (unlock) position.
- (2) Press PLAY to set the memory playback mode (p. 86). The last recorded image is displayed.
- (3) Press $-/+$ on your camcorder or the Remote Commander to select the desired still image.
- : to see the previous image
+ : to see the next image

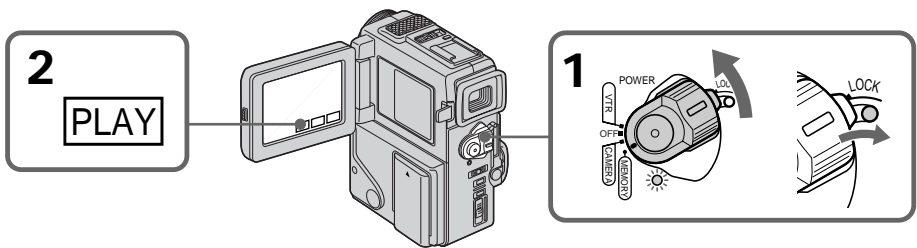

To play back recorded images on a TV screen

- Connect your camcorder to the TV with the A/V connecting cable supplied with your camcorder before the operation.
- When operating memory photo playback on a TV or the LCD screen, the image quality may appear to have deteriorated. This is not a malfunction. The image data is as good as ever.
- Turn the audio volume of the TV down before operation, or noise (howling) may be output from the TV speakers.

Image data modified with personal computers or shot with other equipment

You may not be able to play them back with your camcorder.

Still image

You can select still images also with $-/+$ on PAGE1/PAGE2.

Viewing a still picture – Memory photo playback

Screen indicators during still image playback

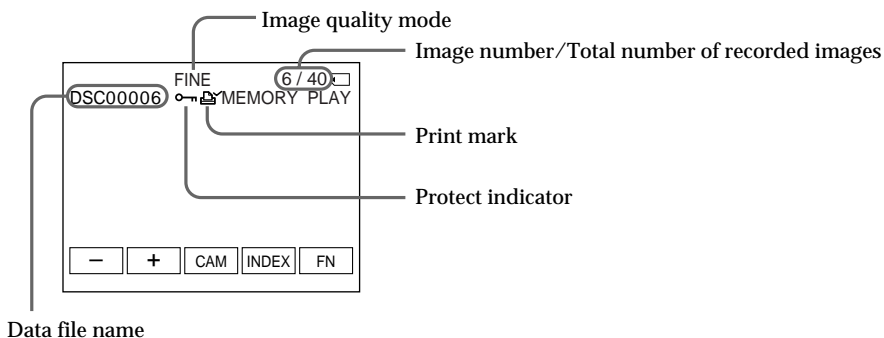

The image quality mode indicator

The indicator may show a mode different to the one in which you recorded. This is not a malfunction. The indicator shows the size of the data file. For instance, if the size of FINE image is small enough, it may be displayed as STD. Or if the size of image is large enough, it may be displayed as SFN.

Viewing a still picture – Memory photo playback

Playing back 6 recorded images at a time (index screen)

You can play back 6 recorded images at a time. This function is especially useful when searching for a particular image.

- (1) Set the POWER switch to MEMORY. Make sure that the LOCK is set to the right (unlock) position.
- (2) Press INDEX on your camcorder or the Remote Commander to display the index screen.

A red ► mark appears above the image that is displayed before changing to the index screen mode.

- ← : to display the previous 6 images
→ : to display the following 6 images

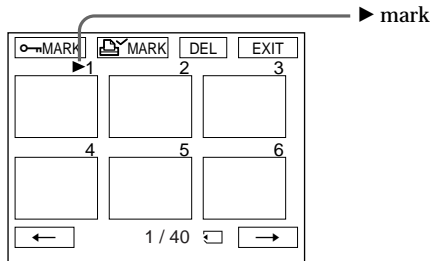

To return to FN

Press EXIT.

To return to the normal playback screen (single screen)

Press the image you want to display.

Note

When displaying the index screen, the number appears above each image. This indicates the order in which images are recorded on the "Memory Stick". These numbers are different from the data file names.

Index screen

Index screen is available in both the memory camera/the memory playback mode.

Files modified with personal computers

These files may not be displayed on the index screen. Image files shot with other equipment may not be displayed on the index screen either.

Viewing a still picture – Memory photo playback

Viewing the recorded images using a personal computer

The image data recorded with your camcorder is compressed in the JPEG format. If you use the application software, "PictureGear 3.2Lite" supplied with your camcorder, you can see images recorded on a "Memory Stick" on a computer screen. Use the serial port adaptor for "Memory Stick" supplied with your camcorder, the MSAKIT-PC4A "Memory Stick"/PC card kit or MSAC-PC1 PC card adaptor for "Memory Stick" (not supplied) for this operation. For detailed instructions on operation, refer to the operating instructions of the serial port adaptor, "Memory Stick"/PC card kit or PC card adaptor and application software.

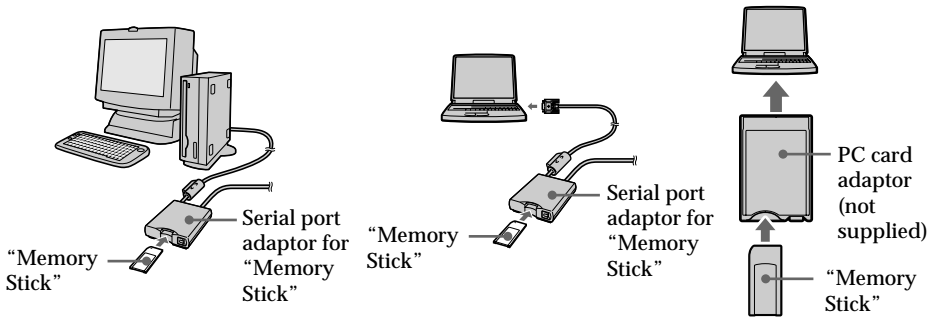

"Memory Stick" operations

Playing back images in a continuous loop – SLIDE SHOW

You can automatically play back images in sequence. This function is useful especially when checking recorded images or during a presentation.

Before operation

Insert a “Memory Stick” into your camcorder.

- (1) Set the POWER switch to MEMORY while pressing the small green button. Make sure that the LOCK is set to the right (unlock) position.
- (2) Press FN to display PAGE1 (p. 86).
- (3) Press MENU, then select SLIDE SHOW in  in the menu settings (p. 76). And press EXEC. READY appears on the LCD screen.
- (4) Press START. Your camcorder plays back the images recorded on a “Memory Stick” in sequence.

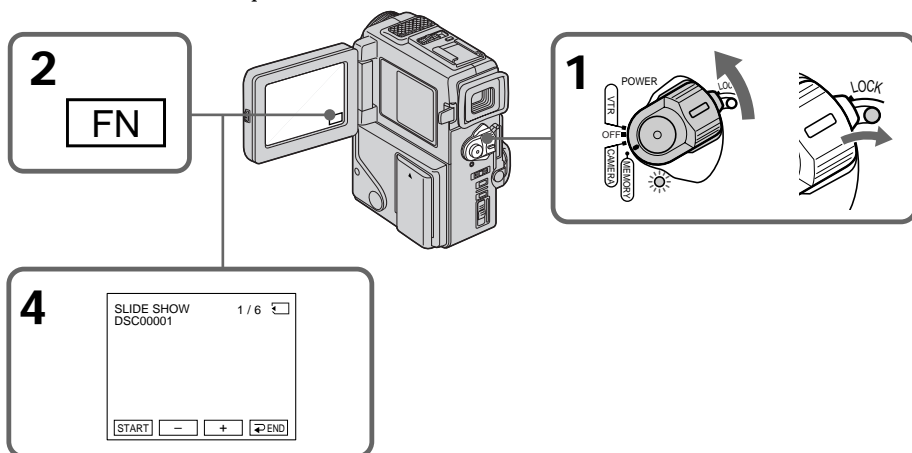

To stop or end the slide show

Press .

To pause during a slide show

Press PAUSE.

To return to FN

Press EXIT.

To start the slide show from a particular image

Select the desired image using MEMORY -/+ buttons before step 3.

To view the recorded images on TV

Connect your camcorder to a TV with the A/V connecting cable supplied with your camcorder before operation.

If you change the “Memory Stick” during operation



The slide show does not operate. If you change the “Memory Stick”, be sure to follow the steps again from the beginning.

Preventing accidental erasure – Image protection

To prevent accidental erasure of important images, you can protect selected images.

Before operation

Insert a “Memory Stick” into your camcorder.

- (1) Set the POWER switch to MEMORY while pressing the small green button. Make sure that the LOCK is set to the right (unlock) position.
- (2) Press INDEX on your camcorder or the Remote Commander to display the index.
- (3) Press “ MARK.” The screen to protect the image appears.
- (4) Press the image you want to protect. The “ ” appears on the protected image.

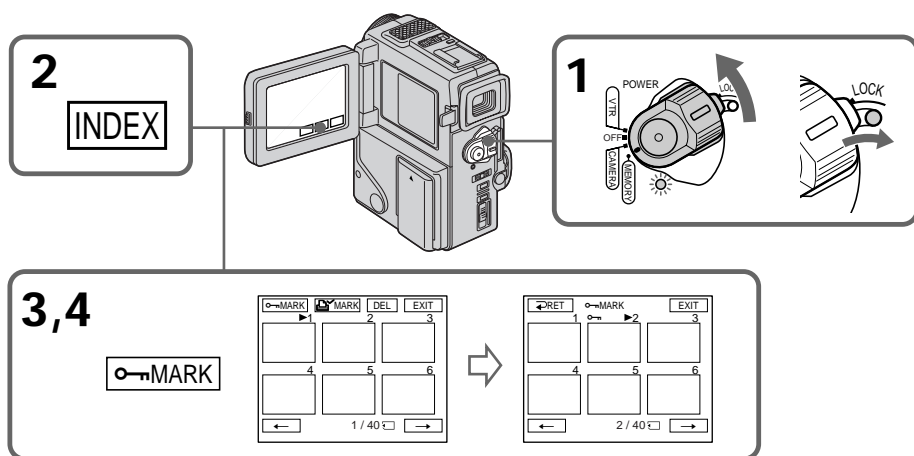

“Memory Stick” operations

To return to FN

Press EXIT.

To cancel image protection

Press the image you want to cancel image protection in step 4. The “ ” disappears.

Note

Formatting erases all information on the “Memory Stick”, including the protected image data. Check the contents of the “Memory Stick” before formatting.

If the write-protect tab on the “Memory Stick” is set to LOCK
You cannot carry out image protection.

Deleting images

You can delete images stored in a “Memory Stick”.

Deleting selected images on the single screen

Before operation

Insert a “Memory Stick” into your camcorder.

- (1) Set the POWER switch to MEMORY while pressing the small green button. Make sure that the LOCK is set to the right (unlock) position.
- (2) Play back the image you want to delete by pressing -/+ (p. 100).
- (3) Press FN to display PAGE1 (p. 86).
- (4) Press DELETE. “DELETE?” appears on the LCD screen.
- (5) Press OK. The selected image is deleted.

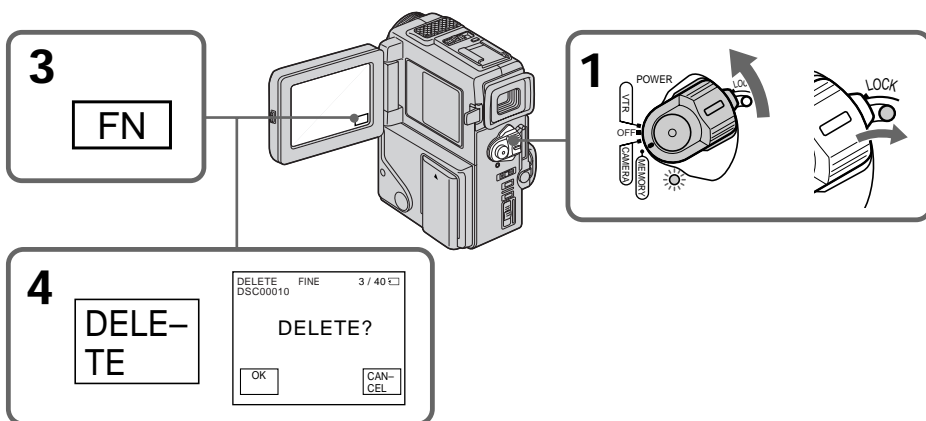

To return to FN

Press FN.

To cancel deleting an image

Press CANCEL in step 5.

Notes

- To delete a protected image, first cancel image protection.
- Once you delete an image, you cannot restore it. Check the images to delete carefully before deleting them.
- You cannot delete images if the write-protect tab is set to LOCK.

Deleting images

Deleting selected images on the index screen

Before operation

Insert a "Memory Stick" into your camcorder.

- (1) Set the POWER switch to MEMORY while pressing the small green button. Make sure that the LOCK is set to the right (unlock) position.
- (2) Press INDEX on your camcorder or the Remote Commander to display the index.
- (3) Press DEL. Then press the image you want to delete. The number of the selected image is highlighted.
- (4) Press EXEC. "DELETE?" appears on the LCD screen.
- (5) Press OK. The selected images are deleted.

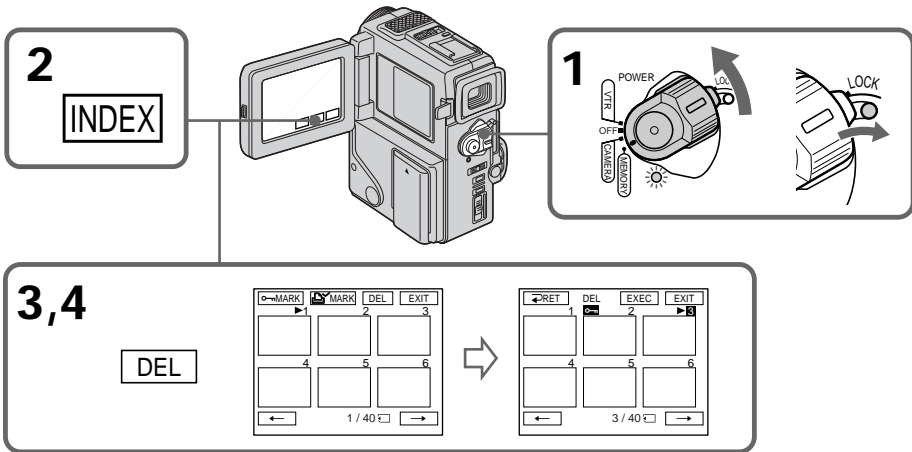

"Memory Stick" operations

To return to FN

Press FN.

To cancel deleting an image

Press CANCEL in step 5.

Deleting images

Deleting all the images

You can delete all the unprotected images in a “Memory Stick”.

Before operation

Insert a “Memory Stick” into your camcorder.

- (1) Set the POWER switch to MEMORY while pressing the small green button. Make sure that the LOCK is set to the right (unlock) position.
- (2) Press FN to display PAGE1 (p. 86).
- (3) Press MENU, then select DELETE ALL in  in the menu settings (p. 76).
- (4) Select DELETE, then press EXEC.
“OK” changes to “EXECUTE”.
- (5) Select EXECUTE. Then press EXEC.
“DELETING” appears on the LCD screen. When all the unprotected images are deleted, “COMPLETE” is displayed.

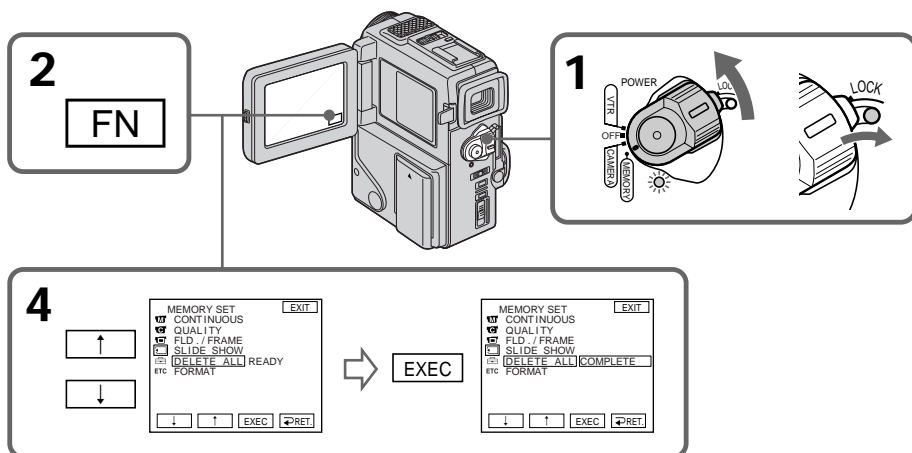

To return to FN

Press EXIT.

To cancel deleting all the images in the “Memory Stick”

Select  RET in step 3, then press EXEC.

While “DELETING” appears

Do not turn the POWER switch or press any buttons.



Writing a print mark – PRINT MARK

You can specify the recorded still image to print out. This function is useful for printing out still images later.

Your camcorder conforms with the DPOF (Digital Print Order Format) standard for specifying the still images to print out.

Before operation

Insert a “Memory Stick” into your camcorder.

- (1) Set the POWER switch to MEMORY while pressing the small green button. Make sure that the LOCK is set to the right (unlock) position.
- (2) Press INDEX on your camcorder or the Remote Commander to display the index.
- (3) Press  MARK. The screen to write a print mark appears.
- (4) Press the image you want to write a print mark. The  appears on the selected image.

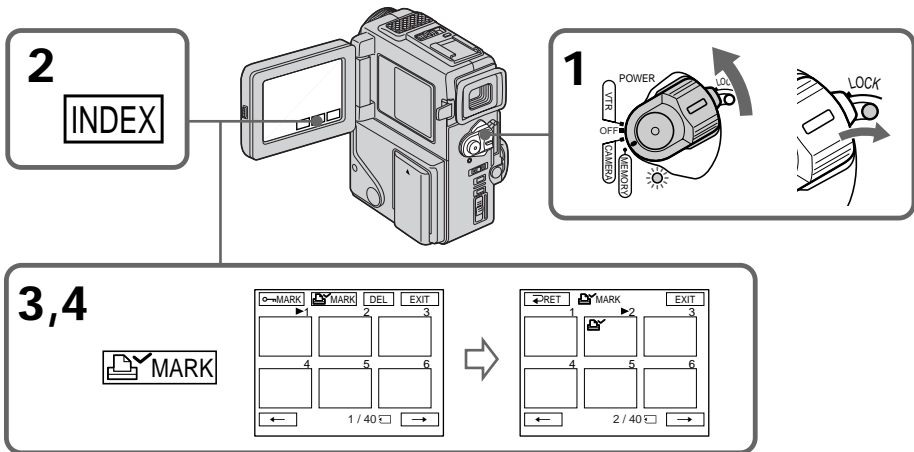

“Memory Stick” operations

To return to FN

Press EXIT.



To cancel writing print marks

Press the image you want to cancel the print mark. The  on the selected image disappears.

If the write-protect tab on the “Memory Stick” is set to LOCK
You cannot write print marks on still images.

Using the viewfinder

You can operate with the touch panel using the viewfinder.

- (1) Pull out the viewfinder until it clicks, and then turn the LCD panel over and move it back to your camcorder body with the LCD screen facing out (p. 19). The same display as the LCD screen appears in the viewfinder. The LCD screen is turned off.
- (2) Press the LCD screen. The  appears in the viewfinder.
- (3) Move  by pressing the LCD screen to select a desired item.

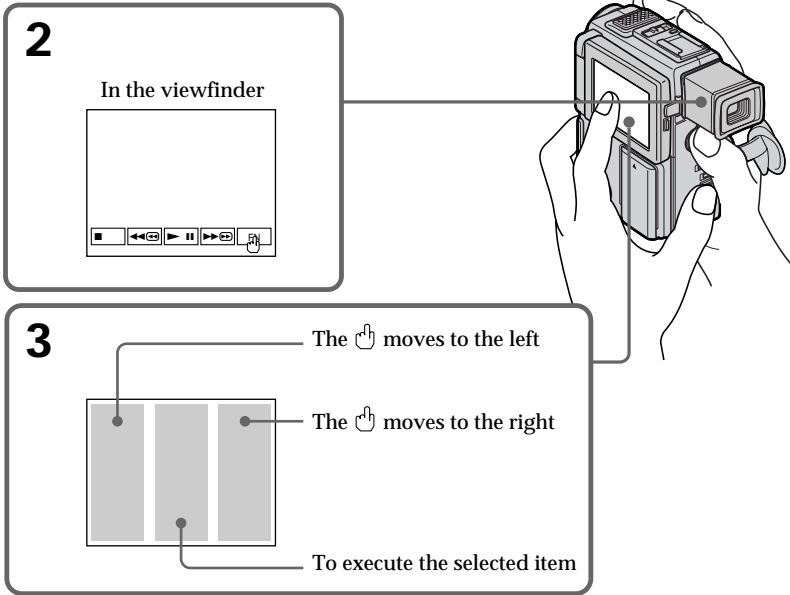

Notes

- Do not touch the LCD screen with wet hands.
- Do not press them with sharp objects such as pens.



After a while

The  disappears. Press the LCD screen to display  again.

When you press the two points on the LCD screen simultaneously

The  does not move.

When you keep pressing the left/right edge of the LCD screen

The  moves to one button to another continuously. Release your finger to make  stop.

Usable cassettes

Selecting cassette types

You can use the ^{Mini}**DV** mini DV cassette only*. You cannot use any other **8** 8 mm, **Hi8** Hi8, **D** Digital8, **VHS** VHS, **VHS-C** VHSC, **S-VHS** S-VHS, **S-VHS-C** S-VHSC, **β** Betamax, **ED Beta** ED Betamax or **DV** DV cassette.

* There are two types of mini DV cassettes: with cassette memory and without cassette memory. We recommend you to use the tape with cassette memory.

The IC memory is built in the cassette with cassette memory. Using this IC memory, your camcorder can read, write, and search data such as the date of recording or titles. The functions using the cassette memory require successive signals recorded on the tape. If the tape has a blank portion in the beginning or between the recorded portions, a title may not be displayed properly or the search functions may not work correctly. Not to make any blank portion on the tape, press END SEARCH to return to the end of the recorded portion before you begin the next recording when:

- you have ejected the cassette while recording.
- you have played back the tape in the VTR mode.

If there is a blank portion or discontinuous signal on your tape, re-record from the beginning to the end of the tape concerning above.

When you record, using a digital video camera recorder without a cassette memory function, on a tape recorded by one with the cassette memory function, the same result may occur.

Tapes with cassette memory have **C//** (Cassette Memory) mark. Sony recommends that you use a tape with **C//** mark to enjoy your camcorder fully.

C//4K mark on the cassette

The memory capacity of tapes marked with **C//4K** is 4KB. Your camcorder can accommodate up to 16KB. 16KB tape is marked with **C//16K**.

When you play back

Copyright signal

When playing back

Using any other video camera recorder, you cannot record on a tape that has recorded a copyright control signals for copyright protection of software which is played back on your camcorder.

When you record

You cannot record software on your camcorder that contains copyright control signals for copyright protection of software.

"COPY INHIBIT" appears on the LCD screen, in the viewfinder or on the TV screen if you try to record such software.

Your camcorder does not record copyright control signals on the tape when it records.

Usable cassettes

Audio mode

12-bit mode: The original sound can be recorded in stereo 1, and the new sound in stereo 2 in 32 kHz. The balance between stereo 1 and stereo 2 can be adjusted by selecting AUDIO MIX in the menu settings during playback. Both sounds can be played back.

16-bit mode: A new sound cannot be recorded but the original sound can be recorded in high quality. Moreover, it can also play back sound recorded in 32 kHz, 44.1 kHz or 48 kHz. When playing back a tape recorded in the 16-bit mode, 16BIT indicator appears on the LCD screen or in the viewfinder.

When you play back a dual sound track tape

When you play back a dual sound track tape recorded in a stereo system, set "HiFi SOUND" to the desired mode in the menu settings (p. 76).

Sound from speaker

HiFi Sound Mode	Playing back a stereo tape	Playing back a dual sound track tape
STEREO	Stereo	Main sound and sub sound
1	Left sound	Main sound
2	Right sound	Sub sound

You cannot record dual sound programs on your camcorder.

Notes on the mini DV cassette

When affixing a label on the mini DV cassette

Be sure to affix a label only on the locations as illustrated below [a] so as not to cause malfunction of your camcorder.

After using the mini DV cassette

Rewind the tape to the beginning, put the cassette in its case, and store it in an upright position.

If the cassette memory function does not work

Reinsert a cassette few times. The gold-plated connector of mini DV cassettes may be dirty or dusty.

Cleaning gold-plated connector

If the gold-plated connector of mini DV cassettes is dirty or dusty, you may not operate the function using cassette memory. Clean up the gold-plated connector with cotton-wool swab, about every 10 times ejection of a cassette. [b]

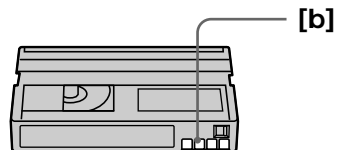
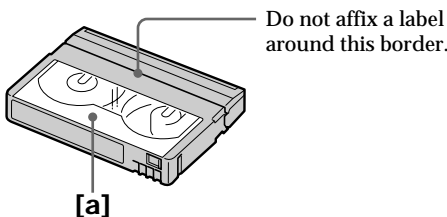

Troubleshooting

If you run into any problem using your camcorder, use the following table to troubleshoot the problem. If the problem persists, disconnect the power source and contact your Sony dealer. If “C:□□:□□” appears on the LCD screen or in the viewfinder, the self-diagnosis display function has worked. See page 118.

In the recording mode

Symptom	Cause and/or Corrective Actions
START/STOP does not operate.	<ul style="list-style-type: none"> • The POWER switch is set to OFF or VTR. → Set it to CAMERA. (p. 17) • The tape has run out. → Rewind the tape or insert a new one. (p. 14, 26) • The write-protect tab is set to expose the red mark. → Use a new tape or slide the tab. (p. 14) • The tape is stuck to the drum (moisture condensation). → Remove the cassette and leave your camcorder for at least 1 hour to acclimatize. (p. 122)
Recording stops in a few seconds.	<ul style="list-style-type: none"> • START/STOP MODE is set to 5SEC or $\frac{1}{2}$. → Set it to $\frac{1}{4}$. (p. 22)
The power goes off.	<ul style="list-style-type: none"> • While being operated in the CAMERA mode, your camcorder has been in the standby mode for more than 5 minutes. → Set the POWER switch to OFF and then to CAMERA again. (p. 17)
The image on the viewfinder screen is not clear.	<ul style="list-style-type: none"> • The viewfinder lens is not adjusted. → Adjust the viewfinder lens. (p. 19)
The SteadyShot function does not work.	<ul style="list-style-type: none"> • STEADYSHOT is set to OFF in the menu settings. → Set it to ON. (p. 76)
The autofocus function does not work.	<ul style="list-style-type: none"> • FOCUS is set to MANUAL. → Set it to AUTO. (p. 46) • Shooting conditions are not suitable for autofocus. → Set FOCUS to MANUAL to focus manually. (p. 46)
The fader function does not work.	<ul style="list-style-type: none"> • START/STOP MODE is set to 5SEC or $\frac{1}{2}$. → Set it to $\frac{1}{4}$. (p. 22) • The digital effect function is working. → Cancel it. (p. 40)
The \otimes indicator flashes in the viewfinder or on the LCD screen.	<ul style="list-style-type: none"> • The video heads may be dirty. → Clean the heads using the Sony DVM12CL cleaning cassette (not supplied). (p. 123)
A vertical band appears when you shoot a subject such as lights or a candle flame against a dark background.	<ul style="list-style-type: none"> • The contrast between the subject and background is too high. Your camcorder is not a malfunction.
A vertical band appears when you shoot a very bright subject.	<ul style="list-style-type: none"> • Your camcorder is not a malfunction.
Some tiny white spots appear in the viewfinder or on the LCD screen.	<ul style="list-style-type: none"> • Slow shutter, low lux or NightShot +Slow shutter mode is activated. This is not a malfunction.

(continued on the following page)

Troubleshooting

Symptom	Cause and/or Corrective Actions
An unknown picture is displayed in the viewfinder or on the LCD screen.	<ul style="list-style-type: none"> • If 10 minutes elapse after you set the POWER switch to CAMERA or DEMO MODE is set to ON in the menu settings without a cassette inserted, your camcorder automatically starts the demonstration. → Insert a cassette or press the LCD screen. The demonstration stops. You can also cancel DEMO MODE. (p. 81)
The picture is recorded in incorrect or unnatural colors.	<ul style="list-style-type: none"> • NIGHTSHOT is set to ON. → Set it to OFF. (p. 23)
Picture appears too bright, and the subject does not appear in the viewfinder or on the LCD screen.	<ul style="list-style-type: none"> • NIGHTSHOT is set to ON in a bright place. → Set it to OFF, or use the NightShot function in a dark place. (p. 23)
The click of the shutter does not sound.	<ul style="list-style-type: none"> • BEEP is set to OFF in the menu settings. → Set it to MELODY or NORMAL. (p. 76)
The picture does not appear in the viewfinder.	<ul style="list-style-type: none"> • The LCD panel is open. → Close the LCD panel. (p. 19) • The viewfinder is not fully pulled out. → Pull it out until it clicks. (p. 19)
A horizontal band appears when shooting a TV screen or computer screen	<ul style="list-style-type: none"> • Set STEADYSHOT to OFF in the menu settings. (p. 76)
The picture does not appear on the LCD screen or in the viewfinder.	<ul style="list-style-type: none"> • The picture disappears when you insert or eject a cassette. (The power lamp flashes.) This is not a malfunction.





In the playback mode

Symptom	Cause and/or Corrective Actions
The tape does not move when a video control button is pressed.	<ul style="list-style-type: none"> • The tape has run out. → Rewind the tape. (p. 26)
The playback picture is not clear or does not appear.	<ul style="list-style-type: none"> • The television's video channel is not adjusted correctly. → Adjust it. (p. 30)
There are nine horizontal lines on the picture or the playback picture is not clear or does not appear.	<ul style="list-style-type: none"> • The video head may be dirty. → Clean the heads using the Sony DVM12CL cleaning cassette (not supplied). (p. 123)
No sound or only a low sound is heard when playing back a tape.	<ul style="list-style-type: none"> • The volume is turned to minimum. → Turn up the volume. (p. 26) • AUDIO MIX is set to ST2 in the menu settings. → Adjust AUDIO MIX. (p. 76)
Displaying the recorded date, date search function does not work.	<ul style="list-style-type: none"> • The tape has no cassette memory. → Use a tape with cassette memory. (p. 50, 111) • CM SEARCH is set to OFF in the menu settings. → Set it to ON. (p. 76) • The tape has a blank portion in the recorded portion. (p. 51)
The title search function does not work.	<ul style="list-style-type: none"> • The tape has no cassette memory. → Use a tape with cassette memory. (p. 111) • CM SEARCH is set to OFF in the menu settings. → Set it to ON. (p. 76) • There is no title in the tape. → Superimpose the titles. (p. 69) • The tape has a blank portion in the recorded portion. (p. 52)

Troubleshooting

Symptom	Cause and/or Corrective Actions
The new sound added to the recorded tape is not heard.	<ul style="list-style-type: none"> • AUDIO MIX is set to ST1 side in the menu settings. → Adjust AUDIO MIX in the menu settings. (p. 76)
The title is not displayed.	<ul style="list-style-type: none"> • TITLE DSPL is set to OFF in the menu settings. → Set it to ON in the menu settings. (p. 76) • Screen indicators are displayed on the screen. → Make the screen indicators disappear. (p. 28)
The sound is muted or images do not appear when monitoring images through TV.	<ul style="list-style-type: none"> → Pull out A/V connecting cable from AUDIO/VIDEO jack, then connect it again.

In the recording and playback modes

Symptom	Cause and/or Corrective Actions
The power does not turn on.	<ul style="list-style-type: none"> • The battery pack is not installed, or is dead or nearly dead. → Install a charged battery pack. (p. 9, 12) • The AC adaptor is not connected to a wall outlet. → Connect the AC adaptor to a wall outlet. (p. 13)
The end search function does not work.	<ul style="list-style-type: none"> • The tape was ejected after recording when using a tape without cassette memory. • You have not recorded on the new cassette yet.
The end search function does not work correctly.	<ul style="list-style-type: none"> • The tape has a blank portion in the beginning or middle.
The picture does not appear in the viewfinder.	<ul style="list-style-type: none"> • The LCD panel is open. → Close the LCD panel. (p. 19) • When the viewfinder is not pulled out until it clicks, the picture does not appear in the viewfinder. → Pull out the viewfinder until it clicks.
The battery pack is quickly discharged.	<ul style="list-style-type: none"> • The operating temperature is too low. • The battery pack is not fully charged. → Charge the battery pack again. (p. 9) • The battery pack is completely dead, and cannot be recharged. → Replace with a new battery pack. (p. 12)
The battery remaining indicator does not indicate the correct time.	<ul style="list-style-type: none"> • You have used the battery pack in an extremely hot or cold environment for a long time. • The battery pack is completely dead, and cannot be recharged. → Replace with a new battery pack. (p. 12) • The battery is dead. → Use a charged battery pack. (p. 9, 12)
The cassette cannot be removed from the holder.	<ul style="list-style-type: none"> • The power source is disconnected. → Connect it firmly. (p. 12, 13) • The battery is dead. → Use a charged battery pack. (p. 12, 13)
The  and  indicators flash and no functions except for cassette ejection work.	<ul style="list-style-type: none"> • Moisture condensation has occurred. → Remove the cassette and leave your camcorder for at least 1 hour to acclimatize. (p. 122)
 indicator does not appear when using a tape with cassette memory.	<ul style="list-style-type: none"> • The gold-plated connector of the tape is dirty or dusty. → Clean the gold-plated connector. (p. 112)
Remaining tape indicator is not displayed.	<ul style="list-style-type: none"> • The  REMAIN is set to AUTO in the menu settings. → Set it to ON to always display the remaining tape indicator. (p. 76)

Troubleshooting

When operating using the “Memory Stick”

Symptom	Cause and/or Corrective Actions
The “Memory Stick” does not function.	<ul style="list-style-type: none">• The POWER switch is set to CAMERA. → Set it to MEMORY. (p. 87)• The “Memory Stick” is not inserted. → Insert a “Memory Stick”. (p. 85)
Recording does not function.	<ul style="list-style-type: none">• The “Memory Stick” has already been recorded to its full capacity. → Erase unnecessary images and record again. (p. 90, 106)• The “Memory Stick” formatted incorrectly is inserted. → Format the “Memory Stick”. (p. 89)• The write-protect tab on the “Memory Stick” is set to LOCK. → Slide the tab to write. (p. 83)
The image cannot be deleted.	<ul style="list-style-type: none">• The image is protected. → Cancel image protection. (p. 105)• The write-protect tab on the “Memory Stick” is set to LOCK. → Set the tab to write. (p. 83)
You cannot format the “Memory Stick”. Deleting all the images cannot be carried out.	<ul style="list-style-type: none">• The write-protect tab on the “Memory Stick” is set to LOCK. → Set the tab to write. (p. 83)
You cannot protect the image.	<ul style="list-style-type: none">• The write-protect tab on the “Memory Stick” is set to LOCK. → Set the tab to write. (p. 83)• The image to protect is not be played back. → Press INDEX to play back the image. (p. 100)
You cannot write a print mark on the still image.	<ul style="list-style-type: none">• The write-protect tab on the “Memory Stick” is set to LOCK. → Set the tab to write. (p. 83)• The image to write a print mark is not be played back. → Press INDEX to play back the image. (p. 100)
The photo save function does not work.	<ul style="list-style-type: none">• The write-protect tab on the “Memory Stick” is set to LOCK. → Set the tab to write. (p. 83)• The battery pack is dead. → Install a charged battery pack or use the AC adaptor instead of the battery pack. (p. 9, 12)

Others

Symptom	Cause and/or Corrective Actions
The title is not recorded.	<ul style="list-style-type: none">• The tape has no cassette memory. → Use a tape with cassette memory. (p. 111)• The cassette memory is full. → Erase another title. (p. 71)• The tape is set to prevent accidental erasure. → Slide the write-protect tab so that red portion is not visible. (p. 14)• Nothing is recorded in that position on the tape. → Superimpose the title to the recorded position. (p. 69)

Troubleshooting

Symptom	Cause and/or Corrective Actions
The cassette label is not recorded.	<ul style="list-style-type: none">• The tape has no cassette memory. → Use a tape with cassette memory. (p. 111)• The cassette memory is full. → Erase some titles. (p. 71)• The tape is set to prevent accidental erasure. → Slide the write-protect tab so that red portion is not visible. (p. 14)
While editing using the i.LINK cable (DV connecting cable), recording picture cannot be monitored.	<ul style="list-style-type: none">• Remove the i.LINK cable (DV connecting cable), and connect it again.
DV synchro-editing does not function.	<ul style="list-style-type: none">• The input selector on the VCR is not set correctly. → Set the selector to DV input position. If you use another DV camcorder, set the power switch to VTR.• The camcorder is connected to DV equipment of other than Sony. → Operate normal editing.• Setting program on a blank portion of the tape is attempted. → Set the program again on a recorded portion.
The Remote Commander supplied with your camcorder does not work.	<ul style="list-style-type: none">• COMMANDER is set to OFF in the menu settings. → Set it to ON. (p. 76)• Something is blocking the infrared rays. → Remove the obstacle.• The batteries are inserted in the battery holder with the + - polarities incorrectly matching the + - marks. → Insert the batteries with the correct polarity. (p. 133)• The batteries are dead. → Insert new ones. (p. 133)
The picture from a TV or VCR does not appear even when your camcorder is connected to outputs on the TV or VCR.	<ul style="list-style-type: none">• DISPLAY is set to V-OUT/LCD in the menu settings. → Set it to LCD. (p. 76)
The melody or beep sounds for 5 seconds.	<ul style="list-style-type: none">• Moisture condensation has occurred. → Remove the cassette and leave your camcorder for at least 1 hour to acclimatize. (p. 122)• Some troubles have occurred in your camcorder. → Remove the cassette and insert it again, then operate your camcorder.
No function works though the power is on.	<ul style="list-style-type: none">• Disconnect the Connecting plate of the AC adaptor or remove the battery, then reconnect it in about 1 minute. Turn the power on. If the functions still do not work, press the RESET button beside the Grip strap using a sharp-pointed object. (If you press the RESET button, all the settings including the date and time return to the default.) (p. 131)
The buttons do not appear on the touch panel.	<ul style="list-style-type: none">• The DISPLAY/TOUCH PANEL button is pressed. → Press the LCD screen lightly. → Press the DISPLAY/TOUCH PANEL button on your camcorder or the Remote Commander.
The buttons on the LCD screen do not work.	<ul style="list-style-type: none">→ Adjust the screen (CALIBRATION). (p. 124)

Self-diagnosis display

Your camcorder has a self-diagnosis display function.

This function displays the current condition of your camcorder as a 5-digit code (a combination of a letter and figures) in the viewfinder or on the LCD screen. If a 5-digit code is displayed, check the following code chart. The last two digits (indicated by □□) will differ depending on the state of your camcorder.

Viewfinder (or LCD screen)

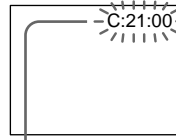

Self-diagnosis display

- C:□□:□□
You can service your camcorder yourself.
- E:□□:□□
Contact your Sony dealer.

Five-digit display	Cause and/or Corrective Actions
C:04:□□	<ul style="list-style-type: none"> • You are using a battery pack that is not an "InfoLITHIUM" battery pack. → Use an "InfoLITHIUM" battery pack. (p. 11)
C:21:□□	<ul style="list-style-type: none"> • Moisture condensation has occurred. → Remove the cassette and leave your camcorder for at least 1 hour to acclimatize. (p. 122)
C:22:□□	<ul style="list-style-type: none"> • The video heads are dirty. → Clean the heads using the Sony DVM12CL cleaning cassette (not supplied). (p. 123)
C:31:□□ C:32:□□	<ul style="list-style-type: none"> • A malfunction other than the above that you can service has occurred. → Remove the cassette and insert it again, then operate your camcorder. → Disconnect the power cord of the AC adaptor or remove the battery pack. After reconnecting the power source, operate your camcorder.
E:61:□□ E:62:□□	<ul style="list-style-type: none"> • A malfunction that you cannot service has occurred. → Contact your Sony dealer and inform them of the 5-digit code. (example: E:61:10)

If you are unable to rectify the problem even if you try corrective actions a few times, contact your Sony dealer.

Warning indicators and messages

If indicators and messages appear in the viewfinder, on the LCD screen or in the display window, check the following:

See the page in parentheses “()” for more information.

The indicators and messages are displayed in yellow.

Warning indicators

The video heads are dirty

Slow flashing:

- You need to clean the heads using the Sony DVM12CL cleaning cassette (not supplied) (p. 123).

The battery is dead or nearly dead

Slow flashing:

- The battery is nearly dead.

Fast flashing:

- The battery is dead (p. 9).

Depending on conditions, the  indicator may flash, even if there are 5 to 10 minutes remaining.

Warning indicator as to tape

Slow flashing:

- The tape is near the end.
- No tape is inserted (p. 14).*
- The write-protect tab on the cassette is out (red) (p. 14).*

Fast flashing:

- The tape has run out (p. 14, 26).*

You need to eject the cassette

Slow flashing:

- The write-protect tab on the cassette is out (red) (p. 14).*

Fast flashing:

- Moisture condensation has occurred (p. 122).
- The tape has run out (p. 14, 26).*
- The self-diagnosis display function is activated (p. 118).*

Moisture condensation has occurred*

Fast flashing:

- Eject the cassette, turn off your camcorder, and leave it for about 1 hour with the cassette compartment open (p. 122).

Warning indicator as to cassette memory

Slow flashing:

- No tape with cassette memory is inserted (p. 111).*

Self-diagnosis display (p. 118)

Warning indicator as to “Memory Stick”

Slow flashing:

- No “Memory Stick” is inserted (p. 85).*

Fast flashing:

- “Memory Stick” is not formatted correctly (p. 89).











The still image is protected

Slow flashing:

- The still image is protected (p. 105).*

Warning indicators and messages

Warning messages

- **CLOCK SET** Reset the date and time (p. 82).
- For “InfoLITHIUM” BATTERY ONLY Use an “InfoLIHIUM” battery pack (p. 11).
-  **CLEANING CASSETTE** The video heads are dirty (p. 123).
-  **FULL** The tape cassette memory is full.
-  The tape has no cassette memory (p. 111).
-  **16BIT** AUDIO MODE is set to 16BIT.* You cannot dub new sound (p. 80).
-  **REC MODE** REC MODE is set to LP.* You cannot dub new sound (p. 80).
-  **TAPE** There is no recorded portion on the tape. You cannot dub new sound.
-  **“i.LINK” CABLE** i.LINK cable is connected (p. 68).* You cannot dub new sound.
-  **FULL** The “Memory Stick” is full.* (p. 99)
-  **LOCK** The write-protect tab on the “Memory Stick” is set to LOCK (p. 83).*
-  **NO FILE** No still image is recorded on the “Memory Stick” (p. 90).*
-  **NO MEMORY STICK** No “Memory Stick” is inserted. (p. 85)

* You hear the melody or beep sound.

Using your camcorder abroad

Using your camcorder abroad

You can use your camcorder in any country or area with the AC adaptor supplied with your camcorder within 100 V to 240 V AC, 50/60 Hz.

When charging the battery pack, use a commercially available AC plug adaptor [a], if necessary, depending on the design of the wall outlet [b].

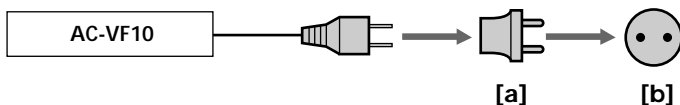

Your camcorder is an NTSC system based camcorder. If you want to view the playback picture on a TV, it must be an NTSC system based TV with VIDEO/AUDIO input jack. The following shows TV color systems used overseas.

NTSC system

Bahama Islands, Bolivia, Canada, Central America, Chile, Colombia, Ecuador, Jamaica, Japan, Korea, Mexico, Peru, Surinam, Taiwan, the Philippines, the U.S.A., Venezuela, etc.

PAL system

Australia, Austria, Belgium, China, Czech Republic, Denmark, Finland, Germany, Great Britain, Holland, Hong Kong, Italy, Kuwait, Malaysia, New Zealand, Norway, Portugal, Singapore, Slovak Republic, Spain, Sweden, Switzerland, Thailand, etc.

PAL-M system

Brazil

PAL-N system

Argentina, Paraguay, Uruguay

SECAM system



Bulgaria, France, Guyana, Hungary, Iran, Iraq, Monaco, Poland, Russia, Ukraine, etc.

Simple setting of clock by time difference

You can easily set the clock to the local time by setting a time difference. Select WORLD TIME in the menu settings. See page 76 for more information.

Maintenance information and precautions

Moisture condensation

If your camcorder is brought directly from a cold place to a warm place, moisture may condense inside your camcorder, on the surface of the tape, or on the lens. In this condition, the tape may stick to the head drum and be damaged or your camcorder may not operate correctly. If there is moisture inside your camcorder, the beep sounds and the  indicator flashes. When the  indicator flashes at the same time, the cassette is inserted in your camcorder. If moisture condenses on the lens, the indicator will not appear.

If moisture condensation occurred

None of the functions except cassette ejection will work. Eject the cassette, turn off your camcorder, and leave it for about 1 hour with the cassette compartment open. Your camcorder can be used again if the  indicator does not appear when the power is turned on again.

Note on moisture condensation

Moisture may condense when you bring your camcorder from a cold place into a warm place (or vice versa) or when you use your camcorder in a hot place as follows:

- You bring your camcorder from a ski slope into a place warmed up by a heating device
- You bring your camcorder from an air-conditioned car or room into a hot place outside
- You use your camcorder after a squall or a shower
- You use your camcorder in a high temperature and humidity place

How to prevent moisture condensation



When you bring your camcorder from a cold place into a warm place, put your camcorder in a plastic bag and tightly seal it. Remove the bag when the air temperature inside the plastic bag has reached the surrounding temperature (after about 1 hour).

Maintenance information and precautions

Maintenance information

Cleaning the video head

To ensure normal recording and clear pictures, clean the video heads. The video head may be dirty when:

- mosaic-pattern noise appears on the playback picture.
- playback pictures do not move.
- playback pictures do not appear.
- the  indicator and “ CLEANING CASSETTE” message appear one after another or the  indicator flashes on the LCD screen or in the viewfinder.



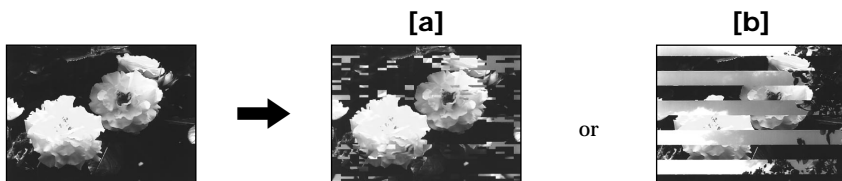

If the above problem, [a] or [b] occurs, clean the video heads for 10 seconds with the Sony DVM12CL cleaning cassette (not supplied). Check the picture and if the above problem persists, repeat cleaning.





Cleaning the LCD screen

If fingerprints or dust make the LCD screen dirty, we recommend using a LCD Cleaning Cloth (supplied) to clean the LCD screen.

Removing dust from inside the viewfinder

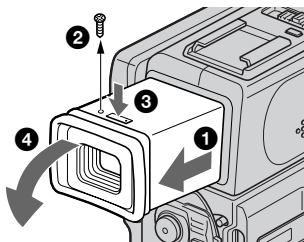
- (1) Pull out the viewfinder .
- Remove the screw  with a screwdriver (not supplied).
- While pressing the right side of the catch  using a sharp-pointed object, remove the eyecup .



- (2) Remove dust from inside the eyecup and viewfinder with a commercially available blower.
- (3) In the reverse way of (1), attach the eyecup. Then replace the screw .

Maintenance information and precautions

Charging the vanadium-lithium battery in your camcorder

Your camcorder is supplied with a vanadium-lithium battery installed so as to retain the date and time, etc., regardless of the setting of the POWER switch. The vanadium-lithium battery is always charged as long as you are using your camcorder. The battery, however, will get discharged gradually if you do not use your camcorder. It will be completely discharged in about three months if you do not use your camcorder at all. Even if the vanadium-lithium battery is not charged, it will not affect the camcorder operation. To retain the date and time, etc., charge the battery if the battery is discharged.

Charging the vanadium-lithium battery:

- Connect your camcorder to house current using the AC adaptor supplied with your camcorder, and leave your camcorder with the POWER switch turned off for more than 24 hours.
- Or install the fully charged battery pack in your camcorder, and leave your camcorder with the POWER switch turned off for more than 24 hours.

Ajusting the LCD screen (CALIBRATION)

The buttons on the touch panel may not work correctly. If this happens, follow the procedure below.

- (1) Turn the POWER switch off.
- (2) Eject the tape from your camcorder, then disconnect any connecting cable from your camcorder.
- (3) Set the POWER switch to VTR while pressing DISPLAY/TOUCH PANEL on your camcorder, then keep pressing DISPLAY/TOUCH PANEL for about five seconds.
- (4) Follow the procedure below with the corner of a “Memory Stick” supplied with your camcorder.
 - ① Touch ✕ at the upper left corner.
 - ② Touch ✕ at the lower right corner.
 - ③ Touch ✕ in the middle of the screen.

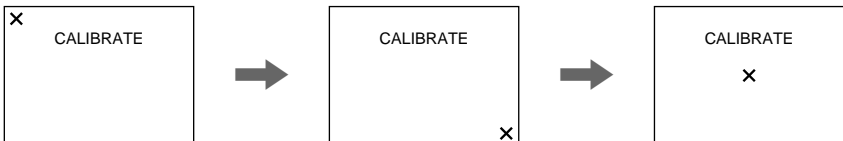

Note

If you do not press the right spot, ✕ always returns to the position at the upper left corner. In this case, start from step 4 again.

Precautions

Camcorder operation

- Operate your camcorder on 3.6 V (battery pack) or 4.2 V (AC adaptor).
- For DC or AC operation, use the accessories recommended in this operating instructions.
- If any solid object or liquid get inside the casing, unplug your camcorder and have it checked by a Sony dealer before operating it any further.
- Avoid rough handling or mechanical shock. Be particularly careful of the lens.
- Keep the POWER switch set to OFF when you are not using your camcorder.
- Do not wrap your camcorder with a towel, for example, and operate it. Doing so might cause heat to build up inside.
- Keep your camcorder away from strong magnetic fields or mechanical vibration.
- Do not touch the LCD screen with a sharp-pointed object.
- If your camcorder is used in a cold place, a residual image may appear on the LCD screen. This is not a malfunction.
- While using your camcorder, the back of the LCD screen may heat up. This is not a malfunction.

On handling tapes

- Do not insert anything into the small holes on the rear of the cassette. These holes are used to sense the type and thickness of the tape and if the recording tab is in or out.
- Do not open the tape protect cover or touch the tape.
- Avoid touching or damaging the terminals. To remove dust, clean the terminals with a soft cloth.

Camcorder care

- Remove the tape, and periodically turn on the power, operate the CAMERA and VTR sections and play back a tape for about 3 minutes when your camcorder is not to be used for a long time.
- Clean the lens with a soft brush to remove dust. If there are fingerprints on the lens, remove them with a soft cloth.
- Clean the camcorder body with a dry soft cloth, or a soft cloth lightly moistened with a mild detergent solution. Do not use any type of solvent which may damage the finish.
- Do not let sand get into your camcorder. When you use your camcorder on a sandy beach or in a dusty place, protect it from the sand or dust. Sand or dust may cause your camcorder to malfunction, and sometimes this malfunction cannot be repaired.

AC adaptor

- Unplug the unit from the wall outlet when you are not using the unit for a long time. To disconnect the power cord, pull it out by the plug. Never pull the power cord itself.
- Do not operate the unit with a damaged cord or if the unit has been dropped or damaged.
- Do not bend the power cord forcibly, or place a heavy object on it. This will damage the cord and may cause fire or electrical shock.
- Prevent metallic objects from coming into contact with the metal parts of the connecting section. If this happens, a short may occur and the unit may be damaged.
- Always keep metal contacts clean.
- Do not disassemble the unit.
- Do not apply mechanical shock or drop the unit.
- While the unit is in use, particularly during charging, keep it away from AM receivers and video equipment. AM receivers and video equipment disturb AM reception and video operation.

Maintenance information and precautions

- The unit becomes warm during use. This is not a malfunction.
- Do not place the unit in locations that are:
 - Extremely hot or cold
 - Dusty or dirty
 - Very humid
 - Vibrating

Battery pack

- Use only the specified charger or video equipment with the charging function.
- To prevent accident from a short circuit, do not allow metal objects to come into contact with the battery terminals.
- Keep the battery pack away from fire.
- Never expose the battery pack to temperatures above 140°F (60°C), such as in a car parked in the sun or under direct sunlight.
- Keep the battery pack dry.
- Do not expose the battery pack to any mechanical shock.
- Do not disassemble nor modify the battery pack.
- Attach the battery pack to the video equipment securely.
- Charging while some capacity remains does not affect the original battery capacity.

Notes on dry batteries

To avoid possible damage from battery leakage or corrosion, observe the following:

- Be sure to insert the batteries with the + – polarities matched to the + – marks.
- Dry batteries are not rechargeable.
- Do not use a combination of new and old batteries.
- Do not use different types of batteries.
- Current flows from batteries when you are not using them for a long time.
- Do not use leaking batteries.

If batteries are leaking

- Wipe off the liquid in the battery compartment carefully before replacing the batteries.
- If you touch the liquid, wash it off with water.
- If the liquid get into your eyes, wash your eyes with a lot of water and then consult a doctor.

If any problem occurs, unplug your camcorder and contact your nearest Sony dealer.

Specifications

Video camera recorder

System

Video recording system

2 rotary heads

Helical scanning system

Audio recording system

Rotary heads, PCM system

Quantization: 12 bits (Fs 32 kHz,

stereo 1, stereo 2), 16 bits

(Fs 48 kHz, stereo)

Video signal

NTSC color, EIA standards

Usable cassette

Mini DV cassette with the **Mini DV**

mark printed

Tape speed

SP: Approx. 18.81 mm/s

LP: Approx. 12.56 mm/s

Recording/playback time (using cassette DVM60)

SP: 1 hour

LP: 1.5 hours

Fastforward/rewind time (using cassette DVM60)

Approx. 3 min. and 30 seconds

(using cassette DVM60)

Viewfinder

Electric viewfinder (color)

Image device

1/4 inch CCD (Charge Coupled Device)

Approx. 680,000 pixels

(Effective: Approx. 340,000 pixels)

Lens

Carl Zeiss

Combined power zoom lens

Filter diameter 30 mm.

(1 3/16 in.)

10× (Optical), 120× (Digital)

Focal length

5/32 - 1 5/16 in. (3.3 - 33 mm)

When converted to a 35 mm still camera

1 11/16 - 16 5/8 in. (42 - 420 mm)

Color temperature

Auto, HOLD (Hold),  Indoor

(3200K),  Outdoor (5800K)

Minimum illumination

5 lux (F 1.7)

0 lux (in the NightShot mode)**

** Objects unable to be seen due to the dark can be shot with infrared lighting.

Input/Output connectors

S video input/output

Input/output auto switch

4-pin mini DIN

Luminance signal: 1 Vp-p,

75 ohms, unbalanced

Chrominance signal: 0.286 Vp-p,

75 ohms, unbalanced

Audio/Video input/output

Input/output auto switch

AV MINI JACK, 1 Vp-p, 75 ohms, unbalanced, sync negative

327 mV, (at output impedance

more than 47 kilohms)

Output impedance with less than

2.2 kilohms/Stereo minijack

(ø 3.5mm)

Input impedance more than

47 kilohms

DV input/output

4-pin connector

Headphone jack

Stereo minijack (ø 3.5 mm)

LANC control jack

Stereo mini-minijack (ø 2.5 mm)

MIC jack

Minijack, 0.388 mV low

impedance with 2.5 to 3.0 V DC,

output impedance 6.8 kilohms

(ø 3.5 mm)

Stereo type

LCD screen

Picture

2.5 inches measured diagonally

2 × 1 1/2 in. (50 × 37 mm)

Total dot number

200,640 (880 × 228)

General

Power requirements

3.6 V (battery pack)

4.2 V (AC adaptor)

Average power consumption

(when using the battery pack)

During camera recording using

LCD

3.8 W

Viewfinder

3.1 W

Operating temperature

32 °F to 104 °F (0 °C to 40 °C)

Storage temperature

-4 °F to +140 °F (-20 °C to +60 °C)

Dimensions (approx.)

2 1/4 × 4 3/4 × 3 3/4 in.

(56 × 119 × 94 mm) (w/h/d)

Mass (approx.)

1 lb 1 oz (490 g)

excluding the battery pack and cassette

1 lb 3 oz (560 g)

including the battery pack,

NP-FS11, cassette DVM60 and

lens cap

Supplied accessories

See page 8.

AC adaptor

Power requirements

100 - 240 V AC, 50/60 Hz

Power consumption

13 W

Output voltage

DC OUT: 4.2 V, 1.8 A in the operating mode

Operating temperature

32 °F to 104 °F (0 °C to 40 °C)

Storage temperature

-4 °F to +140 °F (-20 °C to +60 °C)

Dimensions (approx.)

1 15/16 × 1 9/16 × 3 3/8 in.

(49 × 39 × 85 mm) (w/h/d)

excluding projecting parts

Mass (approx.)

4.2 oz (120 g)

excluding power cord

Cord length (approx.)

Power cord: 6.6 feet (2 m)

Connecting cord: 5.2 feet (1.6 m)

Battery pack

Output voltage

DC 3.6 V

Capacity

4.1 Wh

Dimensions (approx.)

1 1/4 × 2 1/32 × 2 in.

(30.3 × 16.3 × 50.2 mm) (w/h/d)

Mass (approx.)

1.4 oz (40 g)

Type

Lithium ion

"Memory Stick"

Memory

Flash memory

4MB: MSA-4A

Operating voltage

2.7-3.6 V

Power consumption

Approx. 45 mA in the operating mode

Approx. 130 µA in the standby mode

Dimensions (approx.)

2 × 1/8 × 7/8 in.

(50 × 2.8 × 21.5 mm) (w/h/d)

Mass (approx.)

0.14 oz (4 g)

Design and specifications are subject to change without notice.

Identifying the parts and controls

Camcorder

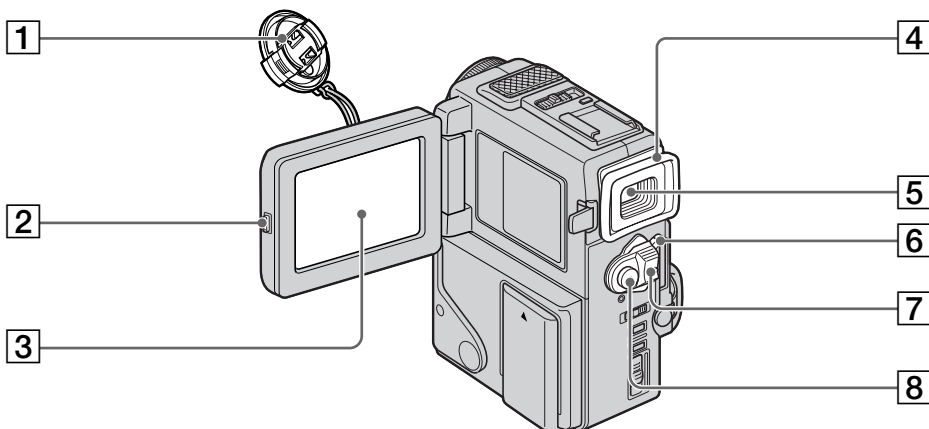

1 Lens cap (p. 17)

2 OPEN button (p. 15)

3 LCD screen (p. 20)

4 Eyecup

5 Viewfinder (p. 19)

6 LOCK (p. 18)

7 POWER switch (p. 17)

8 START/STOP button (p. 17)



This mark indicates that this product is a genuine accessory for Sony video products.

When purchasing Sony video products, Sony recommends that you purchase accessories with this "GENUINE VIDEO ACCESSORIES" mark.



These are trademarks.

Identifying the parts and controls

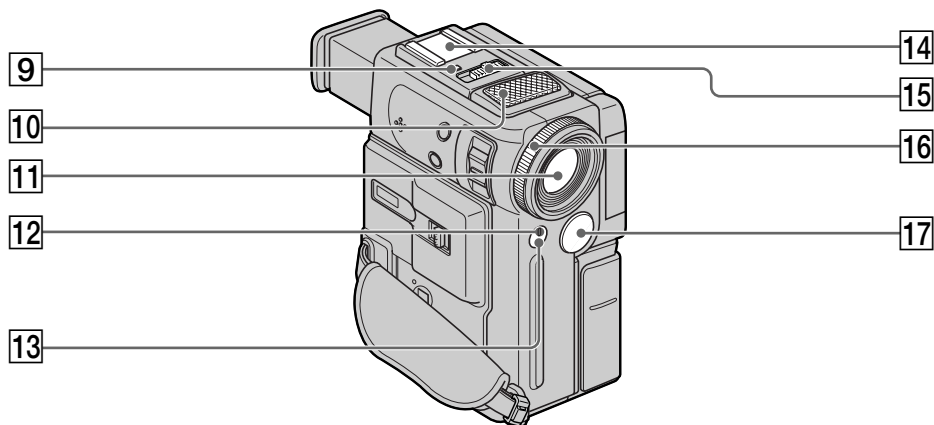

9 +SLOW SHUTTER button (p. 23)

10 Microphone

11 Lens

12 Camera recording lamp (p. 17)

13 Remote sensor (p. 133)

14 Accessory shoe

15 NIGHTSHOT switch (p. 23)

16 Focus ring (p. 46)

17 Infrared rays emitter (p. 23)

Note on the Carl Zeiss lens

Your camcorder is equipped with a Carl Zeiss lens which can reproduce a fine image.

The lens for your camcorder was developed jointly by Carl Zeiss, in Germany, and Sony Corporation. It adopts the MTF* measurement system for video camera and offers a quality as the Carl Zeiss lens.

* MTF is an abbreviation of Modulation Transfer Function/Factor.

The value number indicates the amount of light of a subject penetrating into the lens.

Identifying the parts and controls

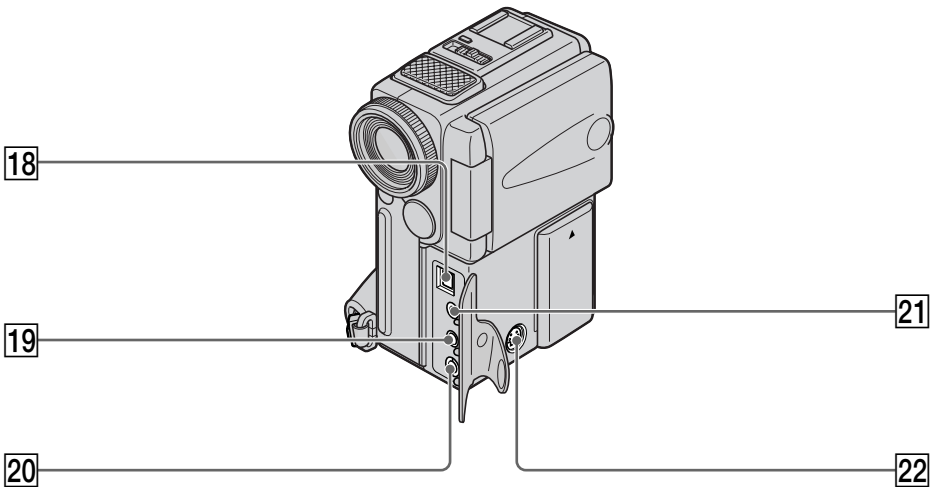

18 **i DV IN/OUT jack** (p. 56)

This “i.LINK” mark is a trademark of Sony Corporation and indicates that this product is in agreement with IEEE 1394-1995 specifications and their revisions.

The **i** DV IN/OUT jack is i.LINK compatible.

19 **MIC jack (PLUG IN POWER)** (p. 65)

Connect an external microphone (not supplied). This jack also accepts a “plug-in-power” microphone.

20 **AUDIO/VIDEO jack** (p. 30, 55, 59)

21 **LANC  control jack**

LANC stands for Local Application Control Bus System. The  control jack is used for controlling the tape transport of video equipment and other peripherals connected to the video equipment. This jack has the same function as the jack indicated as CONTROL L or REMOTE.

22 **S VIDEO jack** (p. 30, 55, 59)

Identifying the parts and controls

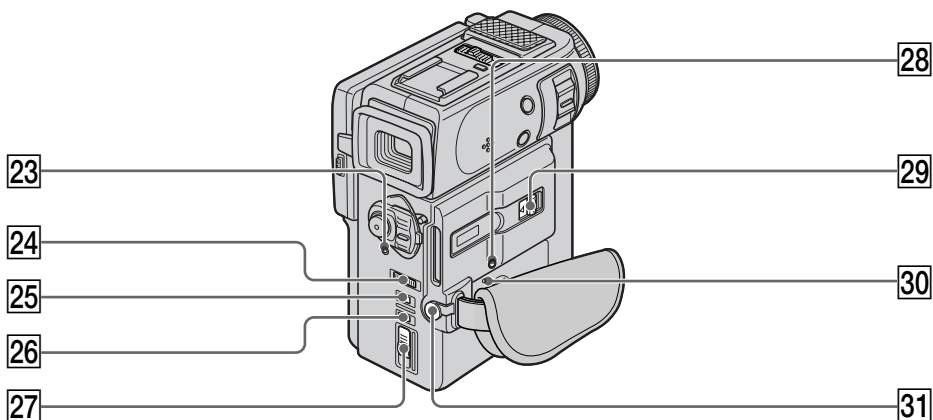

23 Power lamp (p. 5, 17)

24 START/STOP MODE switch (p. 22)

25 BACK LIGHT button (p. 23)

26 DISPLAY/TOUCH PANEL button (p. 28)

27 OPEN/▲ EJECT lever (p. 14)

28 ACCESS lamp (p. 85)

29 MEMORY RELEASE lever (p. 85)

30 RESET button (p. 117)

31  (headphones) jack
When you use headphones, the speaker on your camcorder is silent.

Identifying the parts and controls

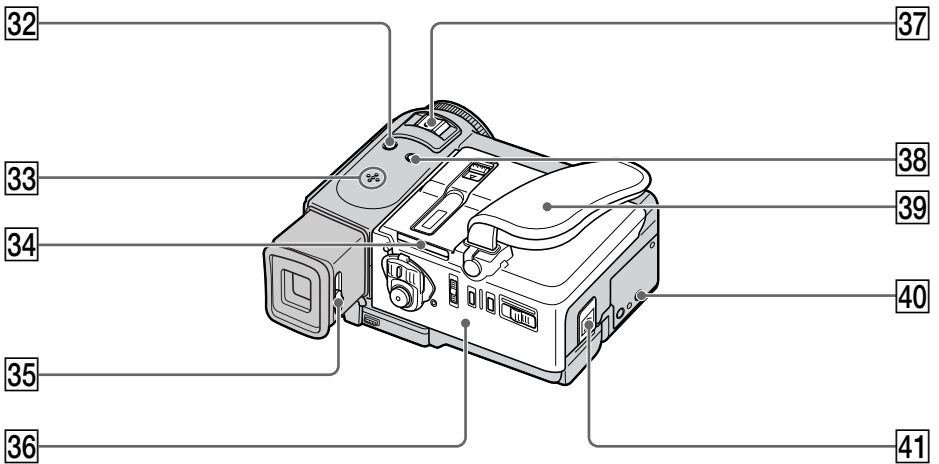

32 PHOTO button (p. 31, 90)

33 Speaker

34 "Memory Stick" slot (p. 85)

35 Viewfinder lens adjustment lever
(p. 19)

36 Cassette lid (p. 14)

37 Power zoom lever (p. 21)

38 FOCUS switch (p. 46)

39 Grip strap

40 Tripod receptacle

Make sure that the length of the tripod screw is less than 9/32 inch (6.5 mm). Otherwise, you cannot attach the tripod securely and the screw may damage your camcorder.

41 BATT (battery) RELEASE lever (p. 12)

Identifying the parts and controls

Remote Commander

The buttons that have the same name on the Remote Commander as on your camcorder function identically to the buttons on your camcorder.

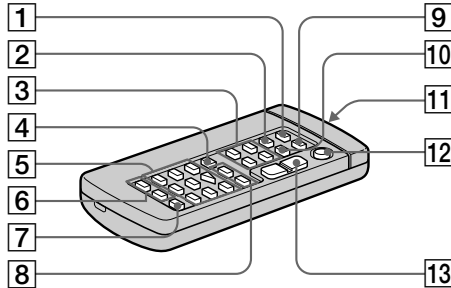

- | | |
|---|--|
| 1 PHOTO button (p. 31, 90) | 8 ◀▶ buttons (p. 50, 52, 53) |
| 2 DISPLAY button (p. 28) | 9 ZERO SET MEMORY button (p. 49, 64) |
| 3 Memory control buttons (p. 94, 100, 101) | 10 DATA CODE button (p. 28) |
| 4 SEARCH MODE button (p. 50, 52, 53) | 11 Transmitter
Point toward the remote sensor to control your camcorder after turning on your camcorder. |
| 5 Video control buttons (p. 29) | 12 START/STOP button (p. 17) |
| 6 REC button (p. 59)/MARK button (p. 58) | 13 Power zoom button (p. 21) |
| 7 AUDIO DUB button (p. 67) | |

To prepare the Remote Commander

Insert 2 size AA (R6) batteries by matching the + and - polarities on the batteries to the + - marks inside the battery compartment.

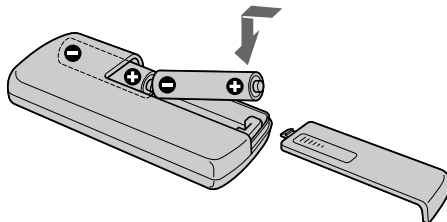

Notes on the Remote Commander

- Point the remote sensor away from strong light sources such as direct sunlight or overhead lighting. Otherwise, the Remote Commander may not function properly.
- Your camcorder works in the commander mode VTR 2. Commander modes 1, 2 and 3 are used to distinguish your camcorder from other Sony VCRs to avoid remote control misoperation. If you use another Sony VCR in the Commander mode VTR 2, we recommend changing the commander mode or covering the sensor of the VCR with black paper.

Identifying the parts and controls

Operation indicators

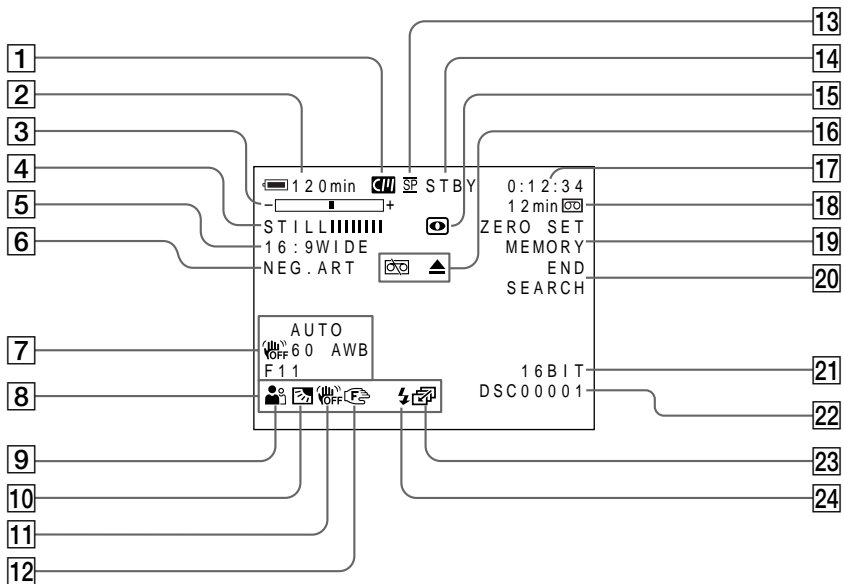

- 1** Cassette memory indicator (p. 111)
- 2** Remaining battery time indicator (p. 22)
- 3** Zoom indicator (p. 21)/Exposure indicator (p. 45)/Data file name indicator (p. 83)
- 4** Digital effect indicator (p. 40)/MEMORY MIX indicator (p. 94)
- 5** FLD./FRAME indicator (p. 90)/16:9WIDE indicator (p. 33)/FADER indicator (p. 26)
- 6** Picture effect indicator (p. 37)
- 7** Data code indicator (p. 28)
- 8** LCD bright indicator (p. 20)/Volume indicator (p. 26)
- 9** PROGRAM AE indicator (p. 43)
- 10** Backlight indicator (p. 23)
- 11** SteadyShot off indicator (p. 77)
- 12** Manual focus/Infinity indicator (p. 46)
- 13** Recording mode indicator (p. 80)
- 14** Standby/Recording indicator (p. 17)/Video control mode indicator (p. 29)/Image quality mode indicator (p. 87)
- 15** NIGHTSHOT indicator (p. 23)
- 16** Warning indicators (p. 119)
- 17** Tape counter indicator (p. 48)/5SEC mode indicator (p. 22)/Time code indicator (p. 22)/Self-diagnosis indicator (p. 118)/Photo mode indicator (p. 31)/Image number indicator (p. 111)
- 18** Remaining tape indicator (p. 22)/Memory playback indicator (p. 101)
- 19** ZERO SET MEMORY indicator (p. 49)
- 20** END SEARCH indicator (p. 25)
- 21** Audio mode indicator (p. 80)
- 22** Data file name indicator
This indicator appears when the MEMORY MIX functions work.
- 23** Continuous mode indicator (p. 91)
- 24** Video flash ready indicator (p. 32)
This indicator appears when you use the video flash light (not supplied).

Quick Function Guide

Functions to adjust exposure (in the recording mode)

- In a dark place NIGHTSHOT (p. 23)
- In insufficient light Low lux mode (p. 43)
- In dark environments such as sunset, fireworks, or general night views Sunset & moon mode (p. 43)
- Shooting backlit subjects BACK LIGHT (p. 23)
- In spotlight, such as at the theater or a formal event Spotlight mode (p. 43)
- In strong light or reflected light, such as at a beach in midsummer or on a ski slope Beach & ski mode (p. 43)

Functions to give images more impact (in the recording mode)

- Smooth transition between scenes FADER (p. 34)
- Taking a still picture PHOTO (p. 31)
- Digital processing of images PICTURE EFFECT (p. 37)/
DIGITAL EFFECT (p. 39)
- Creating a soft background for subjects Soft portrait mode (p. 43)
- Superimposing a title TITLE (p. 69)

Functions to give a natural appearance to your recordings (in the recording mode)

- Preventing deterioration of picture quality in digital zoom D ZOOM [MENU] (p. 76)
- Focusing manually Manual focus (p. 46)
- Shooting distant subjects Landscape mode (p. 43)
- Recording fast-moving subjects Sports lesson mode (p. 43)

Functions to use in editing (in the recording mode)

- Watching the picture on a wide-screen TV Wide mode (p. 33)
- Viewing images using a personal computer "Memory Stick" (p. 83)

Functions to use after recording (in the playback mode)

- Digital processing of recorded images PICTURE EFFECT (p. 47)/
DIGITAL EFFECT (p. 48)
- Displaying the date/time or various settings when you recorded Data code (p. 28)
- Quickly locating a desired scene Zero set memory (p. 49)
- Searching for scenes having a title Title search (p. 52)
- Searching for scenes recorded in the photo mode Photo search (p. 53)
- Scanning scenes recorded in the photo mode Photo scan (p. 54)
- Playing back on monaural sound or sub sound HiFi SOUND [MENU] (p. 76)

Index

A, B

AC adaptor	9
Adjusting viewfinder	19
ANTI GROUND SHOOTING	22
.....	22
Audio dubbing	65
AUDIO MIX	67
Audio mode	80
AUTO SHTR.....	77
A/V connecting cable	30, 55, 57
BACK LIGHT	23
Battery pack	9
Beep	81
BOUNCE	34

C, D

Camera chromakey	93
Carl Zeiss lens	129
Cassette memory	6, 111
Charging battery	9
Charging vanadium-lithium battery	124
Clock set	82
Connection (viewing on TV)	30
(dubbing a tape)	55
Continuous	91
Data code	28
Date search	50
DEMO	81
DIGITAL EFFECT	39
DISPLAY	27
Dual sound track tape	112
Dubbing a tape	55
DV connecting cable	56

E

END SEARCH	25, 29
Exposure	45
External microphone (not supplied)	130

F, G, H

FADER	34
Fade in/out	34
FLASH MOTION	39
FOCUS	46
Format	89
Full charge	9
Grip strap	132
Heads	123
Headphone jack	131
HiFi SOUND	78

I, J, K, L

i.LINK	130
Image protection	105
Image quality mode	87
INDEX (Multiple) display ...	101
“InfoLITHIUM” battery	11
Infrared rays emitter	23
JPEG	83
Labeling a cassette	74
LANC	130
LCD screen	19
LUMINANCEKEY	39

M, N

Main sound	78
Manual focus	46
Memory chromakey	93
Memory luminancekey	93
Memory mix	93
“Memory Stick”	83
Menu settings	76
Mirror mode	19
Moisture condensation	122
MONOTONE	34
Mosaic fader	34
NIGHTSHOT	23
NightShot +Slow shutter	24
Normal charge	9
NTSC system	121

O, P, Q

OLD MOVIE	39
Operation indicators	134
OVERLAP	34
Photo scan	54
Photo search	53
Photo recording	31
PICTURE EFFECT	37
Picture search	29
Playback pause	29
Power sources (house current)	13
(car battery)	13
(battery pack)	12
Power zoom	21
Print mark	109
PROGRAM AE	43

R

Recording time	10
Remaining battery time indicator	22
Remaining tape indicator	22
Remote commander	133
Remote control jack (LANC)	130
Remote sensor	133
RESET	117

S

S video jack	30, 55, 57
Self-diagnosis display	118
Serial port adaptor	103
Skip scan	29
Slide show	104
Slow playback	29
SLOW SHUTTER	39
+SLOW SHUTTER	24
START/STOP MODE	22
STEADYSHOT	77
Stereo tape	112
STILL	39
Sub sound	78

T, U, V

Tape counter	22, 49
Telephoto	21
Time code	22
Title	69
Title search	52
Touch panel	15
TRAIL	39
Transition	18
TV color systems	121

W, X, Y, Z

Warning indicators	119
White balance	42
Wide-angle	21
Wide mode	33
WORLD TIME	81
Write-protect tab	14
Zero set memory	49
Zoom	21