

Digital Video Camera Recorder

Operating Instructions

Before operating the unit, please read this manual thoroughly, and retain it for future reference.

Owner's Record

The model and serial numbers are located on the bottom. Record the serial number in the space provided below. Refer to these numbers whenever you call upon your Sony dealer regarding this product.

Model No. **DCR-TRV9**

Model No. **AC-V316**

Serial No. _____

Serial No. _____

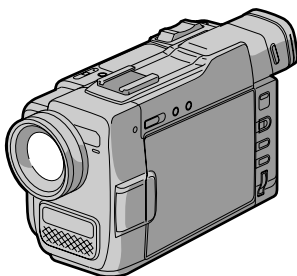

DCR-TRV9

Mini **DV** Digital
Video
Cassette

Handycam Vision™

CI Cassette
Memory



Welcome !

Congratulations on your purchase of this Sony Handycam Vision™ camcorder. With your Handycam Vision, you can capture life's precious moments with superior picture and sound quality. Your Handycam Vision is loaded with advanced features, but at the same time it is very easy to use. You will soon be producing home video that you can enjoy for years to come.

WARNING

To prevent fire or shock hazard, do not expose the unit to rain or moisture.

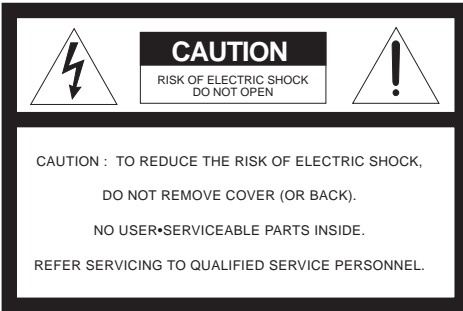

This symbol is intended to alert the user to the presence of uninsulated "dangerous voltage" within the product's enclosure that may be of sufficient magnitude to constitute a risk of electric shock to persons.



This symbol is intended to alert the user to the presence of important operating and maintenance (servicing) instructions in the literature accompanying the appliance.

For the Customers in the U.S.A. CAUTION

You are cautioned that any changes or modifications not expressly approved in this manual could void your authority to operate this equipment.

Note:

This equipment has been tested and found to comply with the limits for a Class B digital device, pursuant to Part 15 of the FCC Rules. These limits are designed to provide reasonable protection against harmful interference in a residential installation. This equipment generates, uses, and can radiate radio frequency energy and, if not installed and used in accordance with the instructions, may cause harmful interference to radio communications. However, there is no guarantee that interference will not occur in a particular installation. If this equipment does cause harmful interference to radio or television reception, which can be determined by turning the equipment off and on, the user is encouraged to try to correct the interference by one or more of the following measures:

- Reorient or relocate the receiving antenna.
- Increase the separation between the equipment and receiver.
- Connect the equipment into an outlet on a circuit different from that to which the receiver is connected.
- Consult the dealer or an experienced radio/TV technician for help.

For the Customers in CANADA CAUTION

TO PREVENT ELECTRIC SHOCK, MATCH WIDE BLADE OF PLUG TO WIDE SLOT, FULLY INSERT.

For the Customers in the U.S.A. and CANADA

DISPOSAL OF LITHIUM ION BATTERY. LITHIUM ION BATTERY. DISPOSE OF PROPERLY.

You can return your unwanted lithium ion batteries to your nearest Sony Service Center or Factory Service Center.

Note: In some areas the disposal of lithium ion batteries in household or business trash may be prohibited.

For the Sony Service Center nearest you call 1-800-222-SONY (United States only).

For the SONY Factory Service Center nearest you call 416-499-SONY (Canada only).

Caution: Do not handle damaged or leaking lithium ion batteries.

Table of contents

Before you begin

Using this manual	4
Checking supplied accessories	6

Getting started

Charging and installing the battery pack	7
Inserting a cassette	10

Basic operations

Camera recording	11
Using the zoom feature	13
Selecting the start/stop mode	14
Shooting with the LCD screen	15
Letting the subject monitor the shot	16
Hints for better shooting	17
Checking the recorded picture	19
Playing back a tape	20
Searching for the end of the picture	22

Advanced operations

Using alternative power sources	23
Using the house current	23
Using a car battery	23
Changing the mode settings	24

—for camera recording—

Shooting with backlighting	28
Using the FADER function	29
Shooting in the dark (NightShot)	30
Photo recording	31
Using the wide mode function	33
Using the PROGRAM AE function	34
Focusing manually	36
Enjoying picture effect	38
Adjusting the exposure	40
Superimposing a title	41

Making a custom title	44
Labeling a cassette	46
Releasing the STEADYSHOT function ..	49

—for playing back/editing—

Watching on a TV screen	50
Searching the boundaries of recorded tape with date – date search	52
Searching the boundaries of recorded tape with title – title search	55
Searching for a photo – photo search/ photo scan	56
Returning to a pre-registered position ..	59
Displaying recording data – data code function	60
Editing onto another tape	61
Recording from a VCR or TV	63
Replacing recording on a tape – insert editing	64
Audio dubbing	65

Additional information

Usable cassettes and playback modes ...	67
Charging the vanadium-lithium battery in the camcorder	68
Resetting the date and time	69
Tips for using the battery pack	70
Maintenance information and precautions	74
Using your camcorder abroad	77
Trouble check	78
Self-diagnosis function	83
Specifications	84
Identifying the parts	85
Warning indicators	93
Index	94

Using this manual

As you read through this manual, buttons and settings on the camcorder are shown in capital letters.

e.g., Set the POWER switch to CAMERA.

As indicated with  in the illustrations, you can hear the beep sound to confirm your operation.

Note on Cassette Memory

This camcorder is based on the DV format. You can only use mini DV cassettes with this camcorder. We recommend you to use a tape with cassette memory .

The functions which depend on whether the tape has the cassette memory or not are:

- End Search (p. 19)
- Date Search (p. 52)
- Photo Search (p. 56).

The functions you can operate only with the cassette memory are:

- Title Search (p. 55)
- Superimposing a title (p. 41)
- Making a custom title (p. 44)
- Labeling a cassette (p. 46)

For details, see page 67.

Note on TV color systems

TV color systems differ from country to country. To view your recordings on a TV, you need an NTSC system-based TV.

Precaution on copyright

Television programs, films, video tapes, and other materials may be copyrighted. Unauthorized recording of such materials may be contrary to the provision of the copyright laws.

Precautions on camcorder care

- The LCD screen and/or the color viewfinder are manufactured using high-precision technology. However, there may be some tiny black points and/or bright points (red, blue or green in color) that constantly appear on the LCD screen and/or in the viewfinder. These points are normal in the manufacturing process and do not affect the recorded picture in any way. Over 99.99% are operational for effective use.
- Do not let the camcorder get wet. Keep the camcorder away from rain and sea water. Letting the camcorder get wet may cause the unit to malfunction, and sometimes this malfunction cannot be repaired [a].
- Never leave the camcorder exposed to temperatures above 140°F (60°C), such as in a car parked in the sun or under direct sunlight [b].

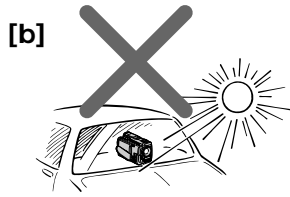
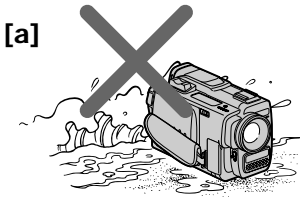

Checking supplied accessories

Check that the following accessories are supplied with your camcorder.

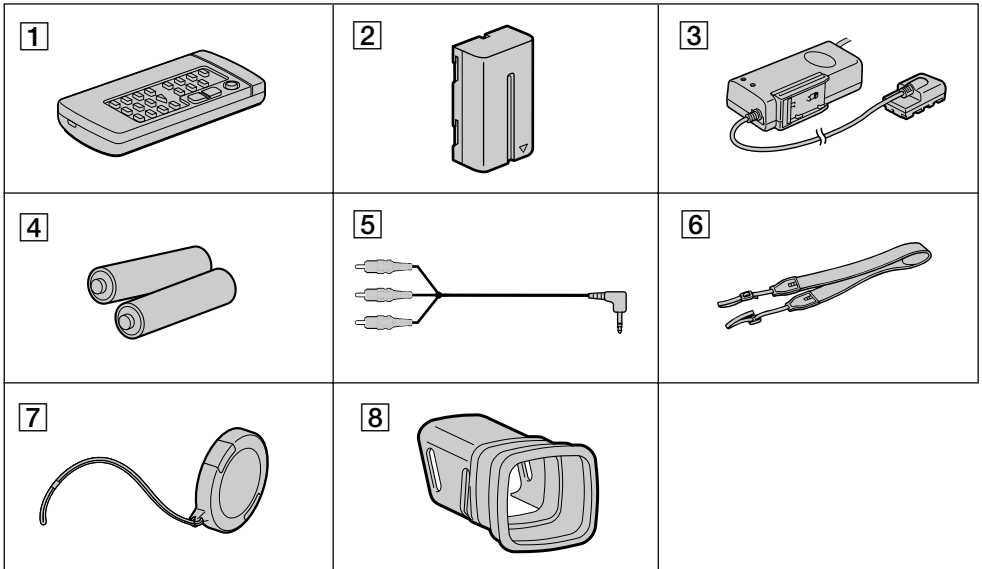

1 Wireless Remote Commander (1) (p. 89)

5 A/V connecting cable (1) (p. 50, 62)

2 NP-F330 battery pack (1) (p. 7)

6 Shoulder strap (1) (p. 90)

3 AC-V316 AC power adaptor (1) (p. 7, 23)
The shape of the plug varies from region to region.

7 Lens cap (1) (p. 11)

4 Size AA (R6) battery for Remote Commander (2) (p. 89)

8 Viewfinder adaptor (1) (p. 9)

Contents of the recording cannot be compensated if recording or playback is not made due to a malfunction of the camcorder, video tape, etc.

Charging and installing the battery pack

Before using your camcorder, you first need to charge and install the battery pack. To charge the battery pack, use the supplied AC power adaptor.

Charging the battery pack

Charge the battery pack on a flat surface without vibration.

- (1) Connect the power cord to a wall outlet.
- (2) Align the surface of the battery pack indicated by the ► mark with the edge of the terminal shutter of the AC power adaptor. Then fit and slide the battery pack in the direction of the arrow. The CHARGE lamp (orange) lights up. Charging begins.

When the CHARGE lamp goes out, **normal charge** is completed. For **full charge**, which allows you to use the battery longer than usual, leave the battery pack in place for approximately one hour. Unplug the unit from the wall outlet, then remove the battery pack and install it into the camcorder. You can also use the battery pack before it is completely charged.

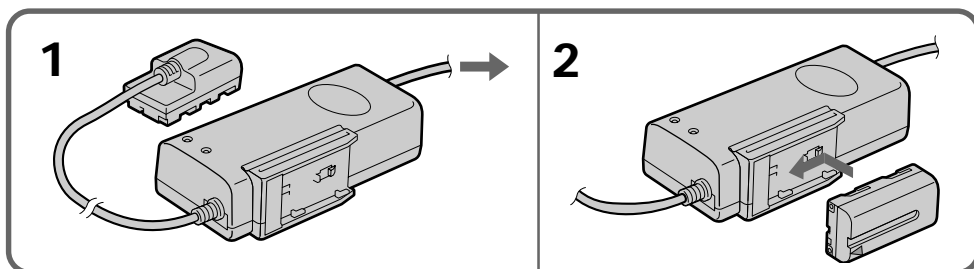

Charging time

Battery pack	Charging time *
NP-F330 (supplied)	130 (70)
NP-F530	170 (110)
NP-F550	180 (120)
NP-F730	250 (190)
NP-F750/NP-F730H**	270 (210)
NP-F930	330 (270)
NP-F950	360 (300)

The time required for a normal charge is indicated in parentheses.

* Approximate minutes to charge an empty battery pack using the supplied AC power adaptor. (Lower temperatures require a longer charging time.)

** NP-F730H is sold only in the U.S.A.

Battery life

While using with viewfinder

Battery pack	Continuous recording time *	Typical recording time **
NP-F330 (supplied)	80 (70)	40 (35)
NP-F530	125 (115)	65 (60)
NP-F550	155 (140)	85 (75)
NP-F730	275 (250)	150 (135)
NP-F750/NP-F730H	325 (285)	175 (155)
NP-F930	430 (385)	235 (210)
NP-F950	495 (450)	270 (245)

While using with LCD

Battery pack	Continuous recording time *	Typical recording time **	Playing time with LCD
NP-F330 (supplied)	60 (55)	30 (30)	60 (55)
NP-F530	100 (85)	55 (45)	100 (85)
NP-F550	125 (110)	70 (60)	125 (110)
NP-F730	215 (195)	120 (110)	215 (195)
NP-F750/NP-F730H	260 (230)	145 (130)	260 (230)
NP-F930	355 (315)	200 (175)	355 (315)
NP-F950	395 (350)	220 (195)	395 (350)

Numbers in parentheses indicate the time when you use a normally charged battery.

Battery life will be shorter if you use the camcorder in a cold environment.

* Approximate continuous recording time indoors.

** Approximate minutes when recording while you repeat recording start/stop, zooming and turning the power on/off. The actual battery life may be shorter.

Notes on remaining battery time indication during recording

- Remaining battery time is displayed in the viewfinder or on the LCD screen. However, the indication may not be displayed properly, depending on using conditions and circumstances.
- When you close the LCD panel and open it again, it takes about 1 minute for the correct remaining time to be displayed.

To remove the battery pack

Slide the battery pack in the direction of the arrow.

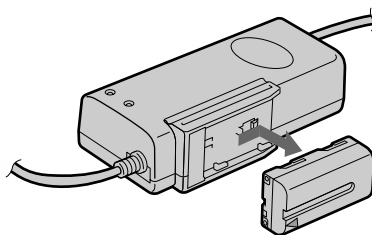

Charging and installing the battery pack

Notes on charging the battery pack

- The CHARGE lamp will remain lit for a while even if the battery pack is removed and the power cord is unplugged after charging the battery pack. This is normal.
- If the CHARGE lamp does not light, disconnect the power cord. After about one minute, reconnect the power cord again.
- You cannot charge the battery pack while you operate the camcorder using the AC power adaptor.
- When a fully charged battery pack is installed, the CHARGE lamp will light once, then go out.

Installing the battery pack

(1) Lift up the viewfinder.

(2) Insert the battery pack in the direction of the ▼ mark on the battery pack. Slide the battery pack down until it is locked.

Attach the battery pack to the camcorder securely.

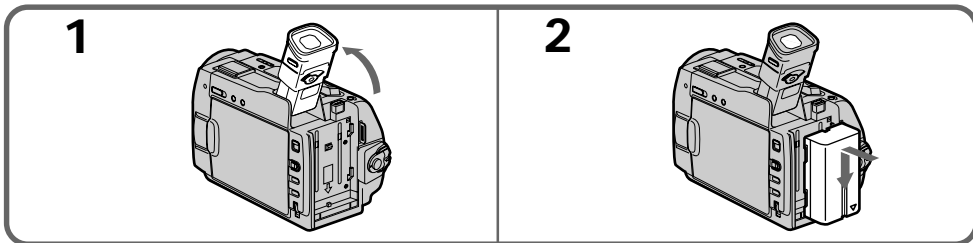

Note on installing the NP-F730/F730H/F750 battery pack

Use the camcorder while stretching out the viewfinder. Be careful not to catch your finger in when you fold the viewfinder back to the original position.

Note on installing the NP-F930/F950 battery pack [a]

Use the camcorder while lifting up the viewfinder.

When you install the viewfinder adaptor, you can record a picture with stretching out the viewfinder while using the NP-F930/F950 battery pack.

Install the viewfinder adaptor by matching the adaptor groove and the finder tip shown in the figure. An eclipse may appear in the finder if you use the adaptor. This will not affect the recorded image.

Note on the battery pack

Do not carry the camcorder by grasping the battery pack.

To remove the battery pack [b]

While pressing ↓ BATT, slide the battery pack in the direction of the arrow.

[a] Viewfinder adaptor

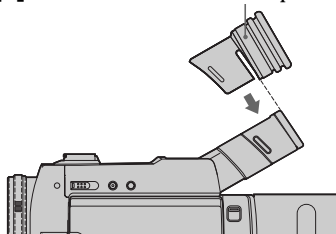

[b]

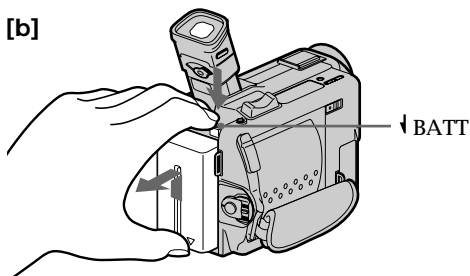

You can look at the demonstration of the functions available with this camcorder (p. 26).

Inserting a cassette

You can use mini DV cassette with ^{Mini} DV logo* only.

Make sure that the power source is installed.

- (1) Slide EJECT in the direction of the arrow. The cassette lid opens, then the cassette compartment opens automatically.
- (2) Insert a cassette with the window facing out into the cassette compartment.
- (3) Close the cassette compartment by pressing the **PUSH** mark on the cassette compartment.
- (4) Close the lid by pressing the **PUSH** mark until it clicks.

* ^{Mini} DV is a trademark.

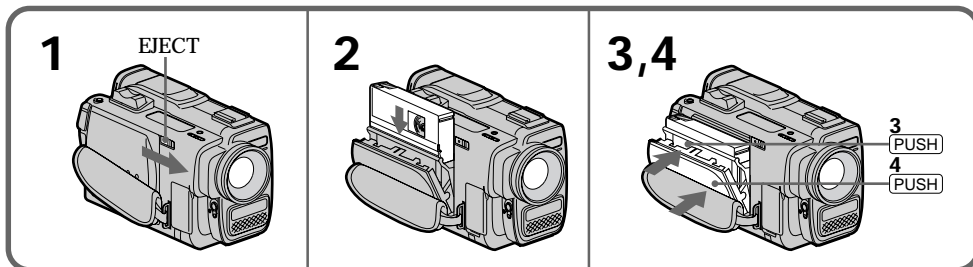



Notes

- When you open the lid immediately after you install the battery, the cassette compartment may not open. Close the lid and open it again.
- The cassette lid and the cassette compartment may not be closed when you press any part of the lid other than the **PUSH** mark.

To eject the cassette

Follow the procedure above and in step 2, take out the cassette.

To prevent accidental erasure

Slide and open the tab on the cassette to expose the red mark. If you try to record with the red mark exposed, the  and  indicators flash on the LCD screen or in the viewfinder, and you cannot record on the tape. To re-record on this tape, slide and close the tab to cover the red mark.

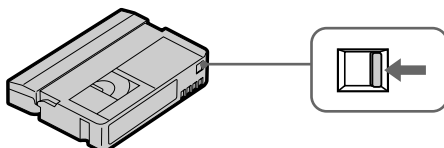

Camera recording

Make sure that the power source is installed and a cassette is inserted and that the START/STOP MODE switch inside the LCD panel is set to **STBY**. Before you record one-time events, you may want to make a trial recording to make sure that the camcorder is working correctly.

When you use the camcorder for the first time, power on it and reset the date and time to your time before you start recording (p. 69).

(1) Remove the lens cap and pull the lens cap string to fix it.

(2) While pressing the small green button on the POWER switch, set it to CAMERA. The camcorder is set to Standby mode.

(3) Press START/STOP.

The camcorder starts recording. "REC" appears in the viewfinder. The camera recording lamp on the front of the camcorder also lights up.

You can also select Recording mode, SP (standard play) mode or LP (long play) mode. Set REC MODE in the menu system according to the length of your planned recording before you start.

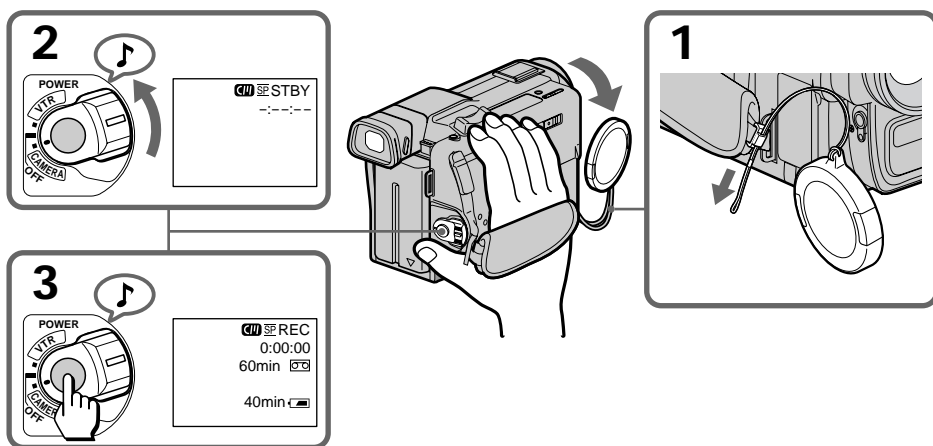

To stop recording momentarily [a]

Press START/STOP. The "STBY" indicator appears in the viewfinder (Standby mode).

To finish recording [b]

Press START/STOP again to stop recording. Set the POWER switch to OFF. Then, eject the cassette and remove the battery pack.

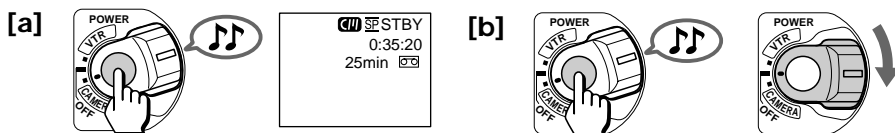

When you use mini DV cassette with cassette memory

Read the instruction about cassette memory to use this function properly (p. 67).

To focus the viewfinder lens

If you cannot see the indicators in the viewfinder clearly, or after someone else has used the camcorder, focus the viewfinder lens. Move the viewfinder lens adjustment lever so that the indicators in the viewfinder come into sharp focus.

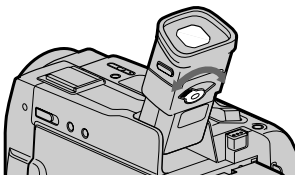

Note on Standby mode

If you leave the camcorder in Standby mode for 5 minutes while the cassette is inserted, the camcorder turns off automatically. This prevents wearing down the battery and wearing out the tape. To resume Standby mode, while pressing the small green button on the POWER switch, set it to OFF once, and then to CAMERA. To start recording, press START/STOP.

Note on Recording mode

This camcorder records and plays back in SP (standard play) mode and in LP (long play) mode. Select SP or LP in the menu system. In LP mode, you can record 1.5 times as long as in SP mode.

Notes on LP mode

- We recommend to use this camcorder to play back a tape recorded on this camcorder. If a tape recorded on other camcorder is played back on this camcorder, or vice versa, mosaic-pattern noise may appear.
- When you record in SP and LP modes on one tape or you record some scenes in LP mode, the playback picture may be distorted or the time code may not be written properly between scenes.
- When you record in LP mode, we recommend you to use a Sony Excellence/Master mini DV cassette so that you can get the most out of your camcorder.
- You cannot make audio dubbing on a tape recorded in LP mode. Use the SP mode for the tape to be audio dubbed.

Notes on the time code

- The time code indicates the recording or playback time, “0:00:00” (hours : minutes : seconds) in CAMERA mode and “0:00:00:00” (hours : minutes : seconds : frames) in VTR mode.
- Be sure not to make a blank portion when recording, because the time code will start from “0:00:00:00” again.
- This camcorder uses the drop frame mode.

Note on the beep sound

As indicated with  in the illustrations, a beep sounds when you turn the power on or when you start recording, and two beeps sound when you stop recording, confirming the operation. Several beeps also sound as a warning of any unusual condition of the camcorder.

Note that the beep sound is not recorded on the tape. If you do not want to hear the beep sound, select OFF in the menu system.

Note on remaining tape indicator

The indicator may not be displayed accurately depending on the tape. Though the indicator does not appear at the time of recording, it will appear in a few seconds.

Using the zoom feature

Zooming is a recording technique that lets you change the size of the subject in the scene. For more professional-looking recordings, use the zoom function sparingly.

“T” side: for telephoto (subject appears closer)

“W” side: for wide-angle (subject appears farther away)

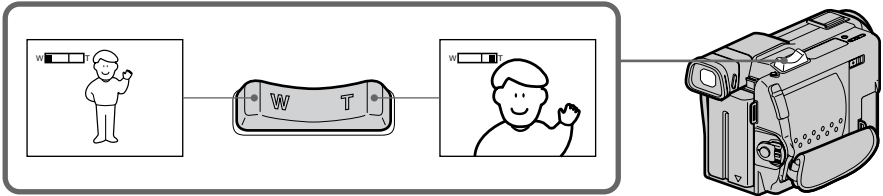

Zooming speed (Variable speed zooming)

Press the power zoom switch a little for a relatively slow zoom; press it still more for a high-speed zoom.

When you shoot a subject using a telephoto zoom

If you cannot get a sharp focus while in extreme telephoto zoom, press the “W” side of the power zoom switch until the focus is sharp. You can shoot a subject that is at least about 2 5/8 feet (about 80 cm) away from the lens surface in the telephoto position, or about 1/2 inch (about 1 cm) away in the wide-angle position.

Notes on digital zoom

- More than 15x zoom is performed digitally, and the picture quality deteriorates as you go toward the “T” side. If you do not want to use the digital zoom, set the D ZOOM function to OFF in the menu system.
- The right side [a] of the power zoom indicator shows the digital zooming zone, and the left side [b] shows the optical zooming zone. If you set the D ZOOM function to OFF, the [a] zone disappears.

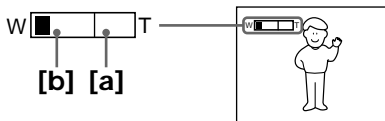



Selecting the start/stop mode

Your camcorder has two modes besides normal start/stop mode. These modes enable you to take a series of quick shots resulting in a lively video.

(1) Slide OPEN in the direction of the arrow and open the LCD panel.

(2) Set START/STOP MODE to the desired mode.

 : Recording starts when you press START/STOP, and stops when you press it again (normal mode).

 **ANTI GROUND SHOOTING** : The camcorder records only while you press down START/STOP so that you can avoid recording unnecessary scenes.

5SEC : When you press START/STOP, the camcorder records for 5 seconds and then stops automatically.

(3) Press START/STOP. Recording starts.

If you selected 5SEC, five dots appear in the viewfinder or on the LCD screen. The dots disappear at a rate of one per second as illustrated below. When five seconds elapse and all the dots disappear, the camcorder switches to Standby mode automatically.

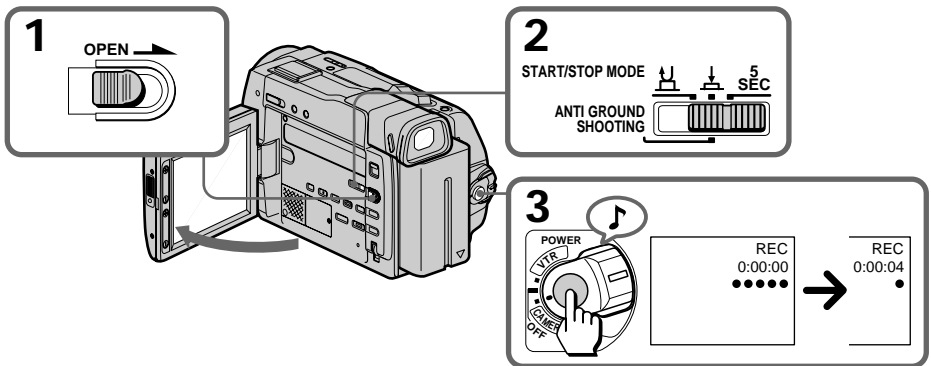

To extend the recording time in 5SEC mode

Press START/STOP again before all the dots disappear. Recording continues for about 5 seconds from the moment you press START/STOP.

Note on 5SEC recording

If you have turned off the indicators on the LCD screen, the dots do not appear.

Shooting with the LCD screen

You can also record the picture while looking at the LCD screen.

When using the LCD screen, the viewfinder turns off automatically except in mirror mode. You cannot monitor the sound from the speaker during recording.

- (1) Slide OPEN in the direction of the arrow and open the LCD panel.
- (2) Adjust angle of the LCD panel.

The LCD panel moves about 90 degrees to this side and about 180 degrees to the other side.

To adjust the brightness of the LCD screen, press LCD BRIGHT + or -.

The battery life is longer when the LCD panel is closed. Use the viewfinder instead of the LCD screen to save the battery power.

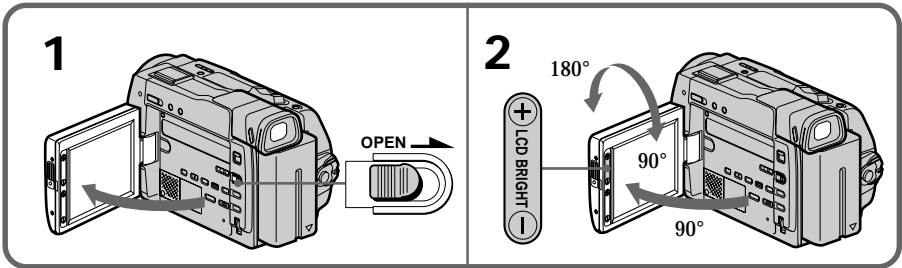

Notes on the LCD panel

- When closing the LCD panel, turn it vertically until it clicks [a].
- When turning the LCD panel, turn it always vertically; otherwise, the camcorder body may be damaged or the LCD panel may not close properly [b].
- Close the LCD panel completely when not in use.
- Do not push nor touch the LCD panel while operating the camcorder.
- You may find it difficult to view the LCD screen due to glare when using the camcorder outdoors.

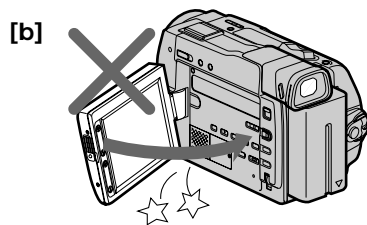
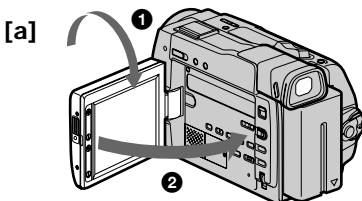

Letting the subject monitor the shot

You can turn the LCD panel over so that it faces the other way and you can let the subject monitor the shot while shooting with the viewfinder.

Turn the LCD panel up vertically. When you turn the LCD panel 180 degrees, the ☺ indicator appears on the LCD screen (**mirror mode**) and the time code and remaining tape indicators disappear.

You can also use the Remote Commander.

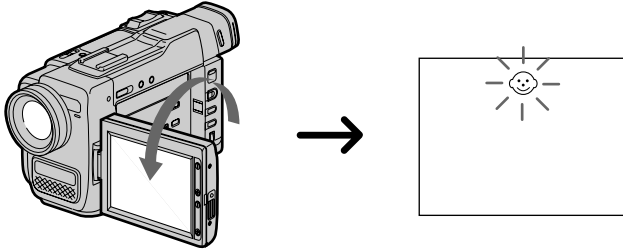

To cancel mirror mode

Turn the LCD panel down toward the camcorder body.

Notes on mirror mode

- When you turn the LCD panel about 90 degrees to 180 degrees, the camcorder enters mirror mode.
- Using the mirror mode, you can record yourself while watching yourself on the LCD.
- The picture on the LCD looks like a mirror-image while recording in mirror mode. The STBY indicator appears as **||●** and REC as **●**. Other indicators appear as mirror-image. Some indicators may not appear in mirror mode.
- While recording in mirror mode, you cannot operate the following functions: MENU, TITLE, and ZERO SET MEMORY on the Remote Commander.

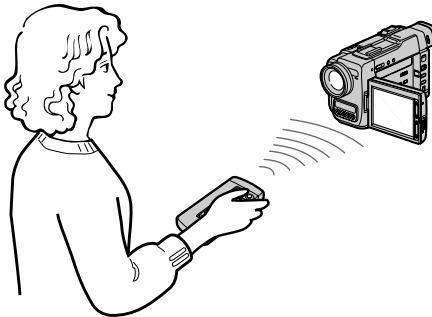

Hints for better shooting

For hand-held shots, you will get better results by holding the camcorder according to the following suggestions:

- Hold the camcorder firmly and secure it with the grip strap so that you can easily manipulate the controls with your thumb. **[a]**

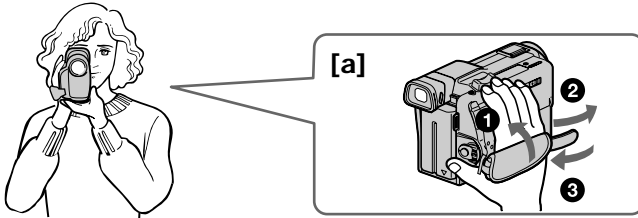

- Place your elbows against your side.
- Place your left hand under the camcorder to support it.
- Place your eye against the viewfinder eyecup.
- Be sure not to touch the built-in microphone.
- Use the LCD panel frame or the viewfinder frame as a guide to determine the horizontal plane.
- You can also record in a low position to get an interesting angle. Lift the viewfinder up for record from a low position. **[b]**
- You can also record in a low position or even in a high position using the LCD panel. **[c]**
- When you use the LCD screen outdoors in direct sunlight, the LCD screen may be difficult to see. If this happens, we recommend that you use the viewfinder.



Hints for better shooting

Place the camcorder on a flat surface or use a tripod

Try placing the camcorder on a table top or any other flat surface of suitable height. If you have a tripod for a still camera, you can also use it with the camcorder. When attaching a non-Sony tripod, make sure that the length of the tripod screw is less than 9/32 inch (6.5 mm). Otherwise, you cannot attach the tripod securely and the screw may damage the camcorder.

Cautions on the LCD panel and on the viewfinder

- Do not pick up the camcorder by the viewfinder or the LCD panel. [d]
- Do not place the camcorder so as to point the viewfinder or the LCD panel toward the sun. The inside of the viewfinder or the LCD panel may be damaged. Be careful when placing the camcorder under sunlight or by a window. [e]

[d]

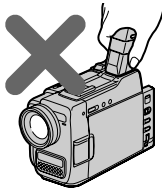

[e]

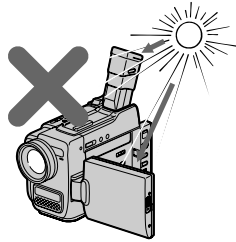

Checking the recorded picture

Using the EDITSEARCH, you can review the last recorded scene or check the recorded picture on the LCD screen or in the viewfinder.

- (1) While pressing the small green button on the POWER switch, set it to CAMERA.
- (2) Press the - side of EDITSEARCH momentarily; the last few seconds of the recorded portion plays back (Rec Review). Hold down the - side of EDITSEARCH until the camcorder goes back to the scene you want. The last recorded portion is played back. To go forward, hold down the + side (Edit Search).

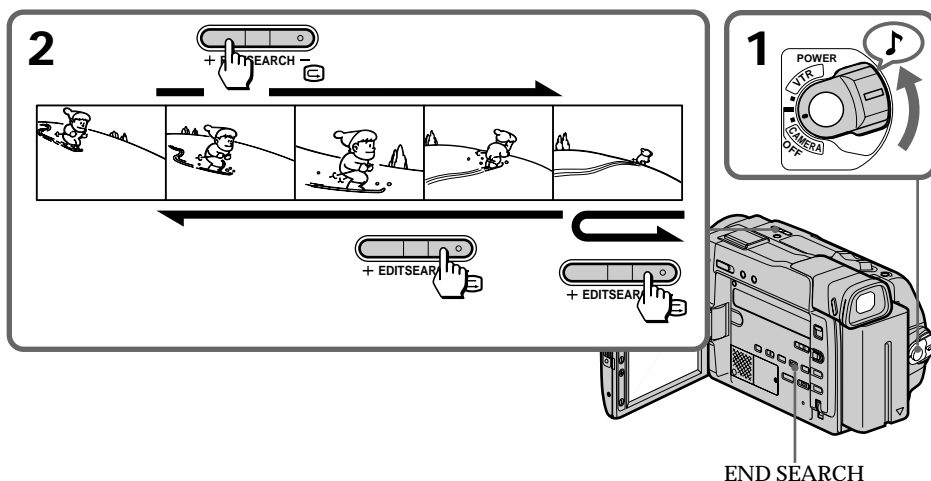

To stop playback

Release EDITSEARCH.

To go back to the last recorded point (END SEARCH)

Press END SEARCH. The last recorded point is played back for about 5 seconds and stops. Note that when you use a tape without cassette memory, this function does not work once you eject the cassette after recording.

To begin re-recording

Press START/STOP. Re-recording begins from the point you released EDITSEARCH. Provided you do not eject the tape, the transition between the last scene you recorded and the next scene you record will be smooth.

Playing back a tape

You can monitor the playback picture on the LCD screen or in the viewfinder.

(1) Insert the recorded tape with the window facing out.

(2) Slide OPEN in the direction of the arrow and open the LCD panel.

(3) While pressing the small green button on the POWER switch, set it to VTR.

(4) Press ◀◀ to rewind the tape.

(5) Press ▶▶ to start playback.

(6) Adjust the volume using VOL +/- and the brightness of the LCD screen using LCD BRIGHT +/-.

You can also monitor the picture on a TV screen, after connecting the camcorder to a TV or VCR.

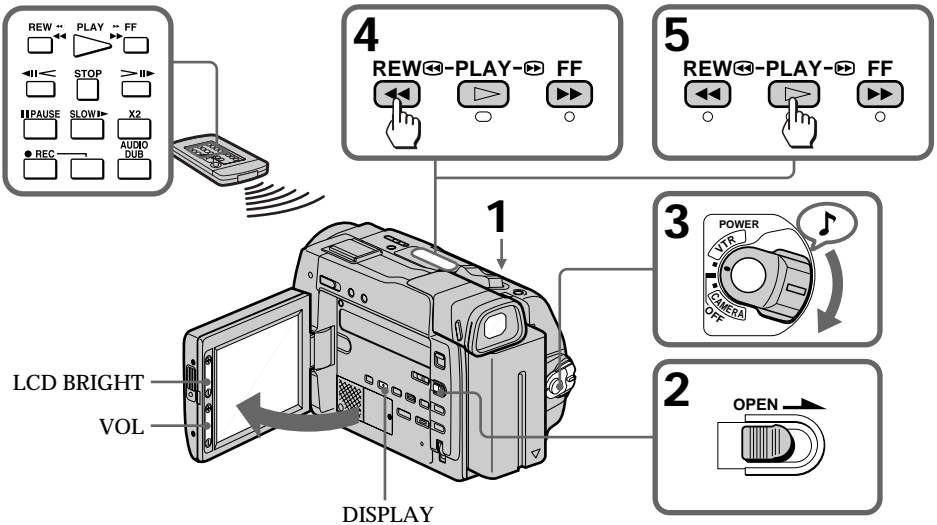

To stop playback, press □.

To rewind the tape, press ◀◀.

To fast-forward the tape rapidly, press ▶▶.

Using the Remote Commander

You can control playback using the supplied Remote Commander. Before using the Remote Commander, insert the size AA (R6) batteries.

To display the LCD screen/viewfinder screen indicators

Press DISPLAY.

To erase the indicators, press again.

Notes on screen indicators

- The screen indicator disappears when the title is displayed.
- When you play back a tape using a "InfoLITHIUM" battery,  indicates the remaining battery capacity. The remaining battery time in minutes is not displayed.

Using headphones

Connect headphones (not supplied) to the  jack. You can adjust the volume of the headphones using VOL +/-.

To view the playback picture in the viewfinder



Close the LCD panel. The viewfinder turns on automatically.

When using the viewfinder, you can monitor the sound only by using headphones.



To view on the LCD screen again, open the LCD panel. The viewfinder turns off automatically.

Various playback modes

To view a still picture (playback pause)

Press  during playback. To resume playback, press  or .





To locate a scene (picture search)

Keep pressing  or  during playback. To resume normal playback, release the button.



To monitor the high-speed picture while advancing the tape or rewinding (skip scan)

Keep pressing  while rewinding or  while advancing the tape. To resume normal rewinding or fast-forward, release the button.



To view the picture at 1/3 speed (slow playback)

Press  on the Remote Commander during playback. For slow playback in reverse direction, press  then press . To resume normal playback, press .



To view the picture at double speed

For double speed playback in the reverse direction, press  then press $\times 2$ on the Remote Commander during playback. For double speed playback in the forward direction, press  then press $\times 2$ during playback. To resume normal playback, press .

To view the picture frame-by-frame

Press  or  on the Remote Commander in playback pause mode. If you keep pressing the button, you can view the picture at 1/30 speed. To resume normal playback, press .

To change the playback direction

Press  on the Remote Commander for reverse direction or  on the Remote Commander for forward direction during playback. To resume normal playback, press .

Notes on playback

- The sound is muted in the various playback modes.
- During playback other than normal playback, the previous recording may appear in mosaic image. This is not malfunction.
- When playback pause mode lasts for 5 minutes, the camcorder automatically enters stop mode. To resume playback, press .

Note on slow playback

The slow playback can be performed smoothly on this camcorder; however, this function does not work for an output signal from the DV IN/OUT jack.

Searching for the end of the picture

You can go to the end of the recorded portion after you record and play back the tape. The tape starts rewinding or fast-forwarding and the last about 5 seconds of the recorded portion plays back. Then the tape stops at the end of the recorded picture (**End Search**).

Open the LCD panel and press **END SEARCH** during recording standby. This function works when the **POWER** switch is set to **CAMERA** or **VTR**.

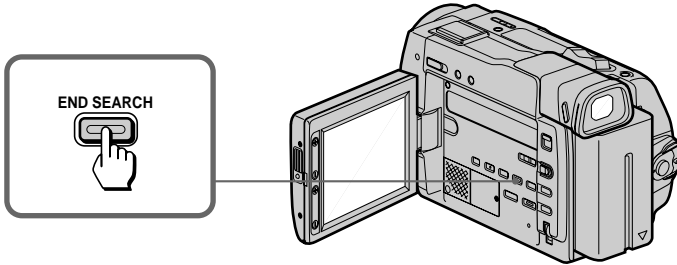

Notes on End Search

- When you use a tape without cassette memory, the End Search function does not work once you eject the cassette after recording.
- When you use a tape with cassette memory, the End Search function works once you eject the cassette. When you play back a tape which has a blank portion in the beginning or between the recorded portions, the End Search function will not work correctly.

Using alternative power sources

You can choose any of the following power sources for your camcorder: battery pack, house current, and 12/24 V car battery. Choose the appropriate power source depending on where you want to use your camcorder.

Place	Power source	Accessory to be used
Indoors	House current	Supplied AC power adaptor
Outdoors	Battery pack	Battery pack NP-F330 (supplied), NP-F530, NP-F550, NP-F730, NP-F730H*, NP-F750, NP-F930, NP-F950
In the car	12 V or 24 V car battery	Sony DC adaptor/charger DC-V700

* NP-F730H is sold only in the U.S.A.

Note on power sources

Disconnecting the power source or removing the battery pack during recording or playback may damage the inserted tape. If this happens, restore the power supply again immediately.

Using the house current

To use the supplied AC power adaptor:

- (1) Connect the power cord to a wall outlet.
- (2) Lift up the viewfinder.
- (3) Slide the connecting plate down into the guides at the rear of the camcorder until it clicks.

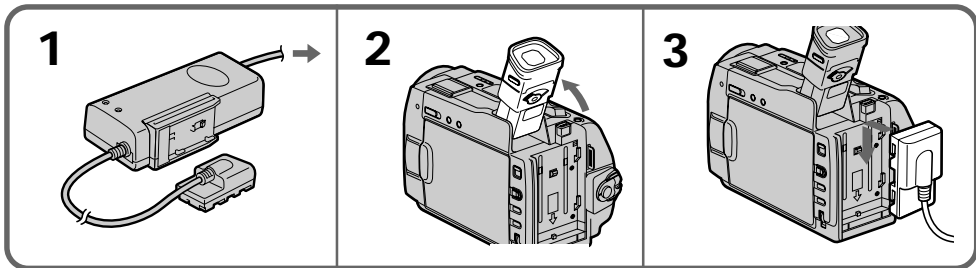

To remove the connecting plate

The connecting plate is removed in the same way as the battery pack.

WARNING

The power cord must only be changed at a qualified service shop.

PRECAUTION

The set is not disconnected from the AC power source (house current) as long as it is connected to the power cord, even if the set itself has been turned off.

Using a car battery

Use a DC adaptor/charger such as Sony DC-V700 (not supplied). Connect the car battery cord to the cigarette lighter socket of a car (12 V or 24 V). Connect the DC adaptor/charger and the camcorder using the DK-415 (supplied with DC-V700) connecting cord.



This mark indicates that this product is a genuine accessory for Sony video product.

When purchasing Sony video products, Sony recommends that you purchase accessories with this "GENUINE VIDEO ACCESSORIES" mark.

Changing the mode settings

You can change the mode settings in the menu system to further enjoy the features and functions of the camcorder.

- (1) Press MENU to display the menu on the LCD screen.
- (2) Turn the CONTROL dial to select the desired item, then press the CONTROL dial. Only the selected item is displayed.
- (3) Turn the CONTROL dial to select the desired mode, then press the CONTROL dial. If you want to change the other modes, repeat steps 2 and 3.
- (4) Press MENU to erase the menu display.

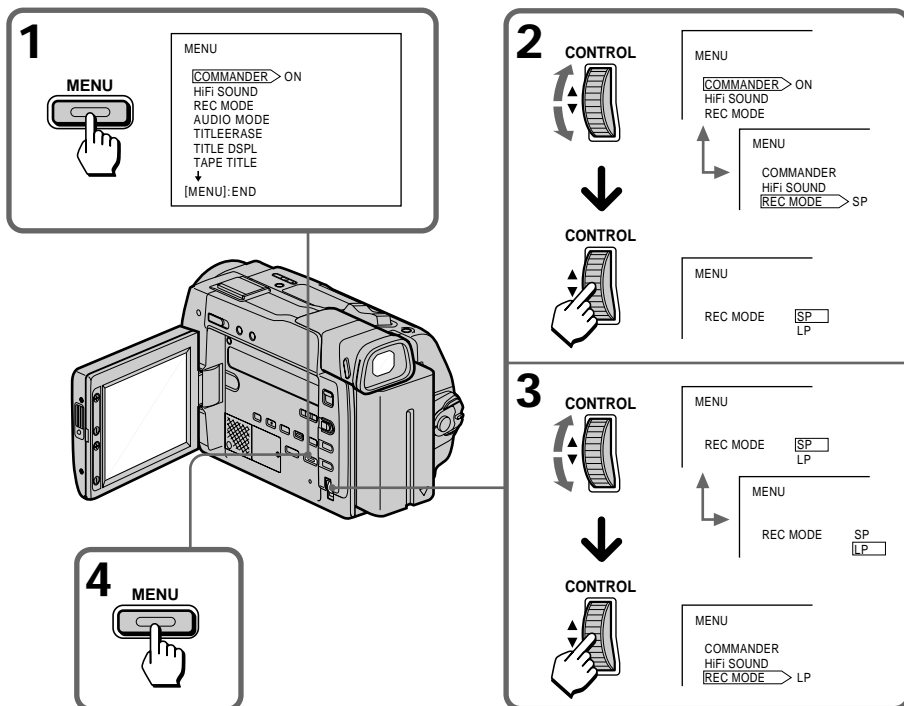

While recording in mirror mode, you cannot operate the menu system.

Note on changing the mode settings

Menu items differ depending on the setting of the POWER switch to VTR or CAMERA.

Selecting the mode setting of each item

Items for both CAMERA and VTR modes

COMMANDER* <ON/OFF>

- Select ON when using the supplied Remote Commander for the camcorder.
- Select OFF when not using the Remote Commander.

REC MODE <SP/LP>

- Select SP when recording in SP (standard play) mode.
- Select LP when recording in LP (long play) mode.

AUDIO MODE <12BIT/16BIT>

- Normally select 12BIT to record two stereo sound.
- Select 16BIT to record the one stereo sound with high quality.

BEEP <ON/OFF>

- Select ON so that beeps sound when you start/stop recording, etc.
- Select OFF when you do not want to hear the beep sound.

TITLEERASE

Erase the title you have superimposed.

LCD B.L. <BRT NORMAL/BRIGHT>

- Normally select BRT NORMAL.
- Select BRIGHT when the LCD panel is dark.

Even if you adjust the LCD B.L., the recorded picture is not affected.

LCD COLOR

Select this item and change the level of the indicator by turning the CONTROL dial up (+) or down (-) to adjust the color intensity of the picture.

VF BRIGHT

Close the LCD panel.

Select this item to adjust the brightness of the viewfinder. The viewfinder becomes brighter when you turn the CONTROL dial up (+), and darker when you turn it down (-).

DISPLAY <LCD or V-OUT/LCD >

- Normally select LCD.
- Select V-OUT/LCD to display indicator both on the LCD panel and TV screen.

AUTO TV ON <ON/OFF>

You can use this feature only with Sony TVs.

- Select ON to turn on the TV automatically when using the LASER LINK function.
- Select OFF not to turn on the TV.

TV INPUT <VIDEO1/VIDEO2/VIDEO3/OFF>

Select 1, 2 or 3 of the video input on the TV which the IR receiver (not supplied) is connected to when using the LASER LINK function.

Items for CAMERA mode only

D ZOOM <ON/OFF>

- Select ON to activate digital zooming.
- Select OFF not to use the digital zoom. The camcorder goes back to 15x optical zoom.

STEADYSHOT <ON/OFF>

- Normally select ON.
- Select OFF when you do not have to worry about camera-shake.

REC LAMP <ON/OFF>

- Normally select ON.
- Select OFF when you do not want the camera recording lamp at the front of the unit to light up.

N.S.LIGHT <ON/OFF>

- Select ON when you use the NightShot Light.
- Select OFF when you do not use the NightShot Light.

CLOCK SET

Select this item to reset the date or time.

DEMO MODE <STBY/ON or OFF>

- Select STBY/ON to glance over the function of camcorder.
- Select OFF not to display demonstration.

Notes on DEMO MODE

- DEMO MODE is set to STBY (Standby)/ON at the factory and the demonstration starts about 10 minutes after you set the POWER switch to CAMERA without inserting a cassette.
Note that you cannot select STBY/ON of DEMO MODE in the menu system.
- You cannot select DEMO MODE when a cassette is inserted in the camcorder.
- If you insert a cassette during the demonstration, the demonstration stops. You can start recording as usual. DEMO MODE automatically returns to STBY/ON.
- When you set NIGHTSHOT to ON, NIGHTSHOT indicator appears in the viewfinder or on the LCD screen. At this time, you cannot select DEMO MODE in the menu system.

To look at the demonstration at once

Eject the cassette, if inserted. Select STBY/ON of DEMO MODE and erase the menu display. The demonstration will begin.

When you turn off the camcorder once, DEMO MODE automatically returns to STBY/ON.

Items for VTR mode only

HiFi SOUND* <STEREO/1/2>

- Select STEREO to play back stereo sound or main and sub sound (for dual sound).
- Select 1 to play back the left sound (for stereo sound) or main sound (for dual sound).
- Select 2 to play back the right sound (for stereo sound) or sub sound (for dual sound).

TITLE DSPL <ON/OFF>

- Select ON to display the title you have superimposed.
- Select OFF not to display the title.

TAPE TITLE

Select this item to label the cassette tape.

AUDIO MIX*

Select this item and adjust the balance between the stereo 1 and stereo 2 by turning the CONTROL dial.

CM SEARCH <ON/OFF>

- Select ON to search using cassette memory.
- Select OFF to search without using cassette memory.

DATA CODE <DATE/CAM or DATE>

- Select DATE/CAM to display date and recording data during playback.
- Select DATE to display date during playback.

* These settings return to the default 5 minutes or more after the power source is disconnected or battery is removed. As far as the items without an asterisk are concerned, their settings are retained even when the power source is disconnected or battery is removed, as long as the vanadium-lithium battery is charged.

When recording a close subject

When REC LAMP is set to ON, the red camera recording lamp on the front of the camcorder may reflect on the subject if it is close. In this case, we recommend you set REC LAMP to OFF.

Notes

- When playing back a tape recorded in the 16-bit mode, you cannot adjust the balance in AUDIO MIX.
- If you select 16BIT in AUDIO MODE menu, you cannot add an audio sound.
- If you select BRIGHT in LCD B.L. menu, the battery life while recording becomes 10 to 20% shorter. When you use the power sources except for a battery, the menu item LCD B.L. is set to BRIGHT automatically and the item does not appear in the screen.

Shooting with backlighting

When you shoot a subject with the light source behind the subject or a subject with a light background, use the BACK LIGHT function.

Press BACK LIGHT. The  indicator appears on the LCD screen or in the viewfinder.

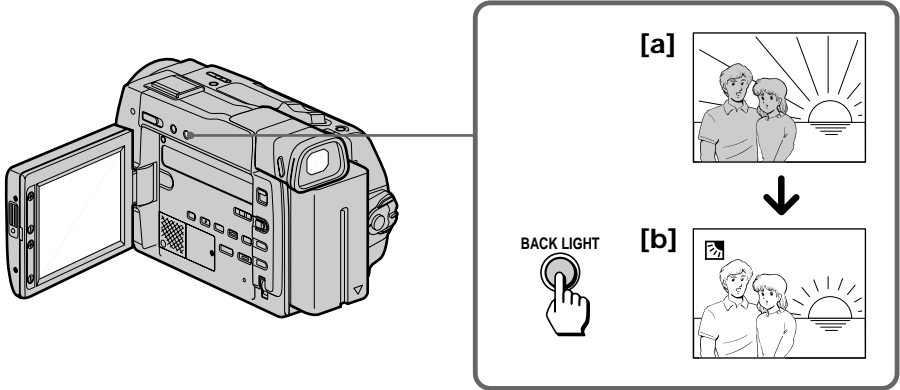

[a] Subject is too dark because of backlight.

[b] Subject becomes bright with backlight compensation.

After shooting

Be sure to release this adjustment condition by pressing BACK LIGHT again. The  indicator disappears. Otherwise, the picture will be too bright under normal lighting condition.

This function is also effective under the following conditions:

- A subject with a light source nearby or a mirror reflecting light.
- A white subject against a white background. Especially when you shoot a person wearing shiny clothes made of silk or synthetic fiber, his or her face tends to become dark if you do not use this function.

Note on the BACK LIGHT function

When you press EXPOSURE, the BACK LIGHT function is cancelled.

Using the FADER function

You can fade in or out to give your recording a professional appearance.

When fading in, the picture gradually fades in from black while the sound increases. When fading out, the picture gradually fades to black while the sound decreases.

When fading in [a]

- (1) While the camcorder is in Standby mode, press FADER until the desired indicator flashes.
- (2) Press START/STOP to start recording. The fade indicator stops flashing.

When fading out [b]

- (1) During recording, press FADER until the desired indicator flashes.
- (2) Press START/STOP to stop recording. The fade indicator stops flashing, and then recording stops.

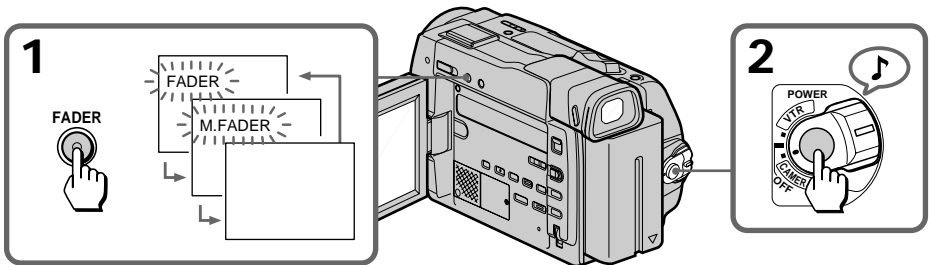
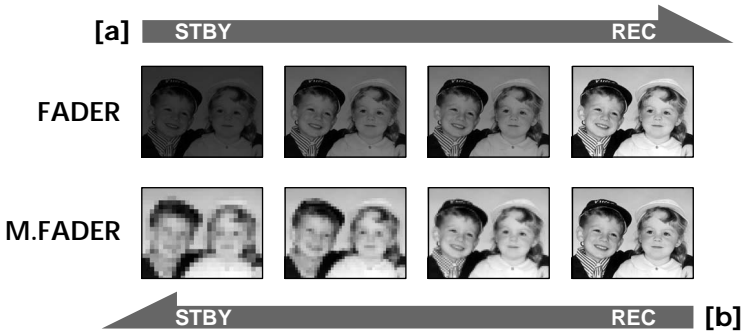

To cancel the fader function

Before pressing START/STOP, press FADER until the fade indicator disappears.





You cannot use the fader function in the following situations

- The START/STOP MODE switch is set to \perp ANTI GROUND SHOOTING or 5SEC.
- The camcorder is in the photo recording.
- A title is displayed in the viewfinder or on the LCD screen.

Shooting in the dark (NightShot)

The NightShot function enables you to shoot a subject in a dark place. You can achieve a satisfactory recording of the ecology of nocturnal animals for observation with this function. This function may record picture nearly in monochrome.



- (1) While the camcorder is in Standby mode, slide NIGHTSHOT to ON. After both  indicator and “NIGHTSHOT” flash, only  indicator lights up.
- (2) Press START/STOP to start recording. After both  indicator and “NIGHTSHOT” flash, only  indicator lights up.

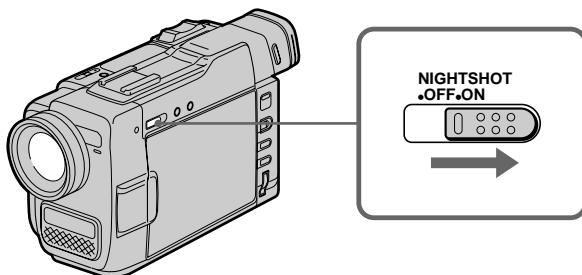

To cancel the NightShot function

Slide NIGHTSHOT to OFF.

Using the NightShot Light

- When you set N.S.LIGHT to ON in the menu system, the picture will be more clear.
- Set N.S.LIGHT to OFF in the menu system to save the battery power. The NightShot effect becomes weak instead.
- NightShot Light rays are infrared and are therefore invisible. The maximum limit of NightShot Light is about 10 feet (3 m).

Notes on the NightShot

- When you keep setting NIGHTSHOT to ON in normal recording, the color may not be recorded properly.
- If focusing is difficult with the autofocus mode when using the NightShot function, use manual focus.

Photo recording

You can record a still picture like a photograph for about seven seconds. This photo recording is useful when you want to enjoy a picture such as a photograph or when you print a picture using a video printer (not supplied). You can record about 510 pictures on a 60-minute tape in SP mode.

- (1) While pressing the small green button on the POWER switch, set it to CAMERA.
- (2) Keep pressing PHOTO lightly until a still picture and "PHOTO CAPTURE" appear on the LCD screen or in the viewfinder.

Recording does not start yet. To change the still picture, release PHOTO, select still picture again, and keep pressing PHOTO lightly again.

If you press PHOTO on the Remote Commander when a still picture appears on the LCD screen or in the viewfinder, the camcorder will record that still picture. However, you cannot select other still pictures by using this button.

- (3) Press PHOTO deeper.

"PHOTO REC" flashes and the still picture on the LCD screen or in the viewfinder is recorded for about seven seconds. The sound during those seven seconds is also recorded and the pictures appear like an animation on the LCD screen or in the viewfinder. You cannot change the POWER switch or press PHOTO during recording.

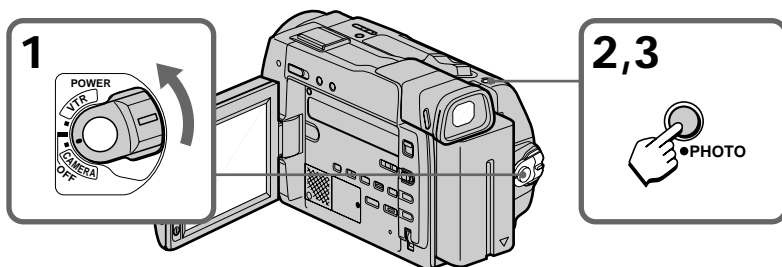

Note on the still picture

When the still picture recorded on this camcorder is played back on another VCR, the picture may be blurred. This is not a malfunction.

When you press PHOTO while recording a photo

The picture on the LCD screen or in the viewfinder whenever you press PHOTO will be recorded. You cannot check the recorded picture by pressing PHOTO lightly.

After the moving picture is recorded as a still picture for about seven seconds, the camcorder will go back to Standby mode.

Printing the still picture

You can print a still picture by using the video printer (not supplied). Connect the video printer using the S video connecting cable (not supplied). Refer to the operating instruction of the video printer as well.

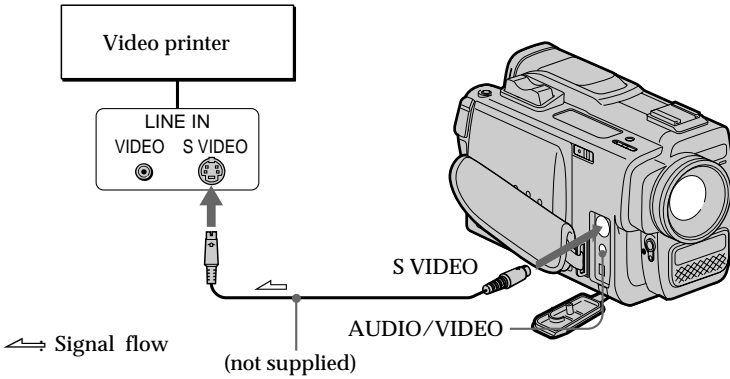

If the video printer is not equipped with S VIDEO input

Use the supplied A/V connecting cable. Connect it to the AUDIO/VIDEO jack and connect the yellow plug of the cable to the VIDEO input of the video printer.

Using the wide mode function

You can record a 16:9 wide picture to watch on the 16:9 wide-screen TV (16:9WIDE).

The picture with black bands at the top and the bottom on the LCD screen or in the viewfinder [a] is normal. The picture on a normal TV [b] is horizontally compressed. You can watch the picture of normal images on a wide-screen TV [c].

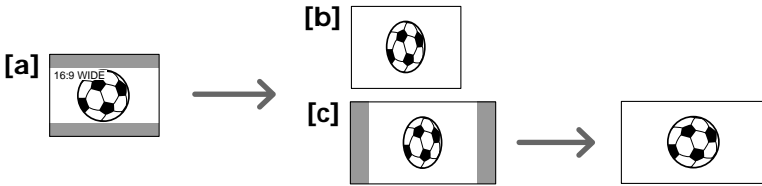

While in Standby mode, press 16:9WIDE. 16:9WIDE appears on the LCD screen.

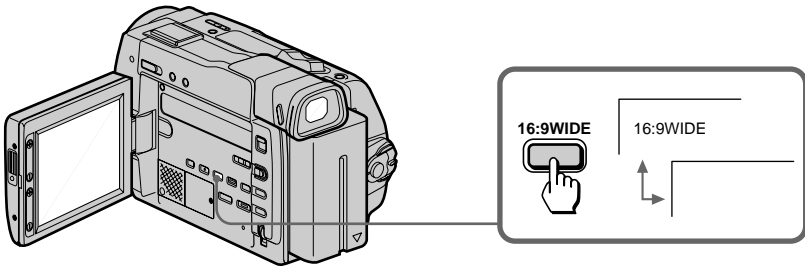

To cancel wide mode

Press 16:9WIDE again.

To watch the tape recorded in wide mode

To watch the tape recorded in 16:9WIDE mode, set it to full mode. For details, refer to the operating instruction of your TV.

Note that the picture recorded in 16:9WIDE mode looks compressed on a normal TV.

Note on wide mode

You cannot select or cancel the wide mode during recording.

Using the PROGRAM AE function

You can select from six PROGRAM AE (Auto Exposure) modes to suit your shooting situation. When you use PROGRAM AE, you can get a portrait effect (the subject is in focus and the background is out of focus), capture high-speed action, record night views, etc.

Selecting the best mode

Select a proper PROGRAM AE mode referring to the following description.



: Spotlight mode

Recording a subject spotlighted on a stage or at a wedding ceremony, etc.

: Soft portrait mode

To record

- A still subject such as a person or flower
- A softened picture
- A person in clearer flesh tones

: Sports lesson mode

Capturing high-speed action in sports such as golf or tennis

: Beach & Ski mode

Recording a person in a place such as on the beach or in the ski slopes where there is a lot of reflection

: Sunset & Moon mode

Recording sunset, night views, fireworks or neon signs

: Landscape mode

Recording a landscape through a window or wire net

Notes on focus setting

- In the Spotlight, Sports lesson and Beach & Ski modes, you cannot take close-ups because the camcorder is set to focus only on subjects in the middle to far distance.
- In the Sunset & Moon and Landscape modes, the camcorder is set to focus only on distant subjects.

Using the PROGRAM AE function

Using the PROGRAM AE function

- (1) While the camcorder is in recording or Standby mode, press PROGRAM AE.
- (2) Turn the CONTROL dial so that the symbol of the desired PROGRAM AE mode matches the indicator on the LCD screen or in the viewfinder.

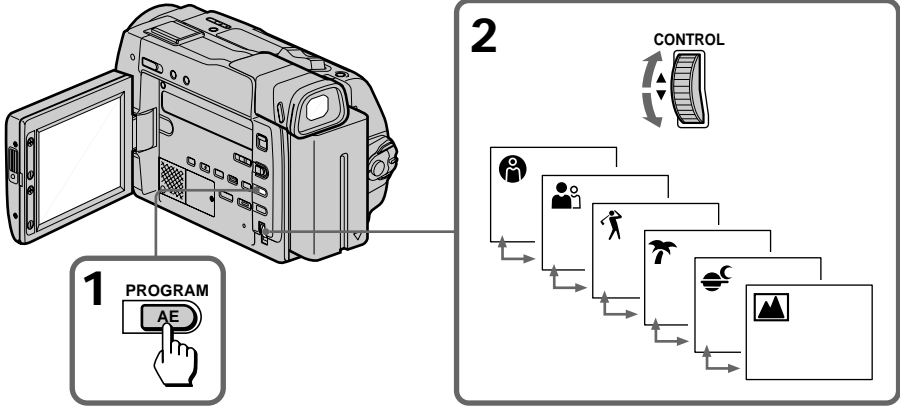

To return to automatic adjustment mode

Press PROGRAM AE so that the indicator disappears.

Note on shutter speed

The shutter speed in each PROGRAM AE mode is as follows:

Soft portrait mode – from 1/60 to 1/500

Sports lesson mode – from 1/250 to 1/4000

Beach & Ski mode – from 1/60 to 1/250

Focusing manually

When to use manual focus

In the following cases you should obtain better results by adjusting the focus manually.

[a]

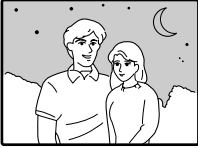

[b]

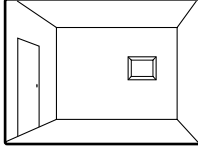

[c]



[d]

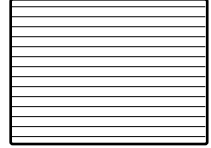

- Insufficient light [a]
- Subjects with little contrast — walls, sky, etc. [b]
- Too much brightness behind the subject [c]
- Horizontal stripes [d]
- Subjects through frosted glass
- Subjects beyond nets, etc.
- Bright subject or subject reflecting light
- Shooting a stationary subject when using a tripod

Focusing manually

When focusing manually, first focus in telephoto before recording, and then reset the shot length.

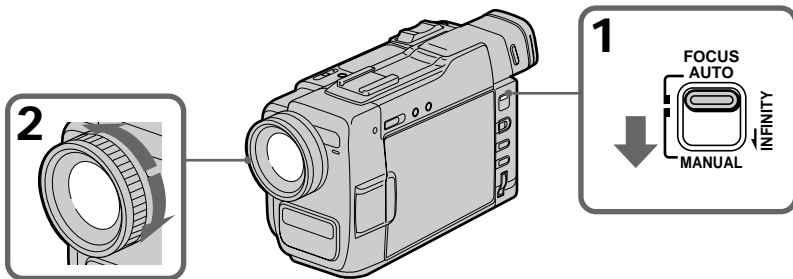

- (1) Slide FOCUS down to MANUAL. The  indicator appears on the LCD screen or in the viewfinder.
- (2) Turn the focus ring to focus on the subject.



To focus in infinity

Slide FOCUS to INFINITY.  indicator appears on the LCD screen or in the viewfinder. This function is useful when the nearer subject is focused automatically, and you want to focus the subject faraway.

To return to the autofocus mode

Slide FOCUS up to AUTO to turn off   indicator.

To shoot in relatively dark places or to shoot the subject moving quickly outside
Shoot at wide-angle after focusing in the telephoto position.

If lights up

Subject is too close.

Enjoying picture effect

Selecting picture effect

You can make pictures like those of television with the Picture Effect function.

[a]



[b]



[c]



[d]



[e]



[f]



PASTEL [a]

The picture is in pastel tones.

NEG. ART [b]

The color of the picture is reversed.

SEPIA

The picture is sepia.

B&W

The picture is monochrome (black and white).

SOLARIZE [c]

The light intensity is clearer, and the picture looks like an illustration.

MOSAIC [d]

The picture is mosaic.

SLIM [e]

The picture expands vertically.

STRETCH [f]

The picture expands horizontally.

Using picture effect function

- (1) While in Standby mode, press PICTURE EFFECT.
- (2) Turn the CONTROL dial to select the desired picture effect mode.

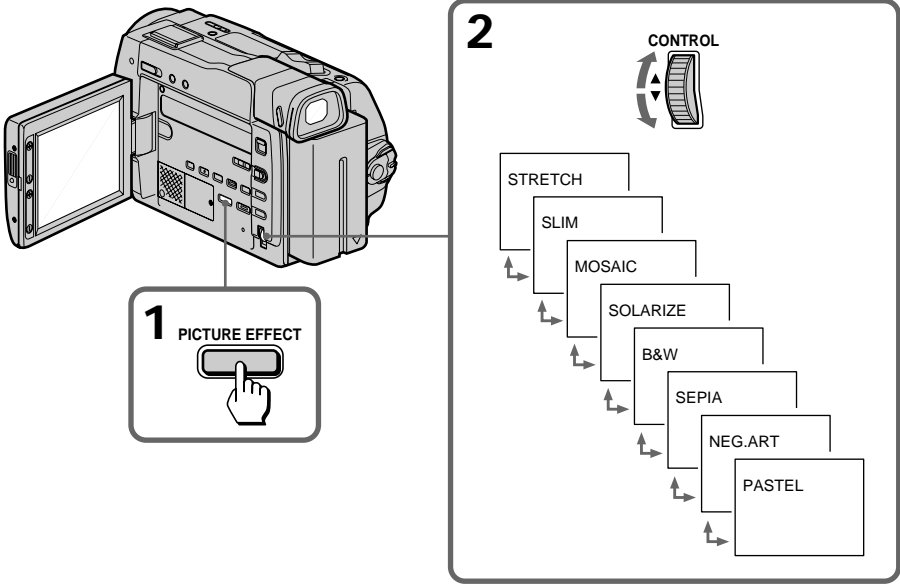

To return to normal mode

Press PICTURE EFFECT so that the indicator disappears.

Note on the picture effect

When you turn the power off, the camcorder returns automatically to normal mode.

Adjusting the exposure

When to adjust the exposure

Adjust the exposure manually under the following cases.

[a]



[a]

- The background is too bright (back lighting)
- Insufficient light: most of the picture is dark

[b]



[b]

- Bright subject and dark background
- To record the darkness faithfully

Adjusting the exposure

(1) Press EXPOSURE. The exposure indicator appears on the LCD screen or in the viewfinder.

(2) Turn the CONTROL dial to adjust the exposure. The exposure is locked at the adjusted brightness.

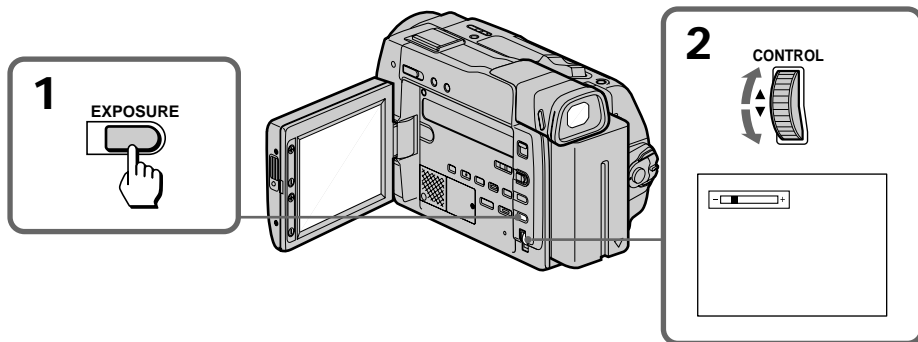

To return to automatic exposure mode

Press EXPOSURE to turn off the exposure indicator.

Notes

- The CONTROL dial does not have a stop position.
- If you press PROGRAM AE, the exposure comes back to automatic adjustment again.
- When you adjust the exposure manually, you cannot use the BACK LIGHT function.

Superimposing a title

If you use a tape with cassette memory, you can superimpose the titles while recording or after recording. When you play back the tape, the title is displayed for 5 seconds from the point where you superimposed it.

You can select from eight preset titles and one original (CUSTOM TITLE) to superimpose over the picture.

Superimposing titles

- (1) Press TITLE to display the titles on the LCD screen or in the viewfinder.
- (2) Turn the CONTROL dial to select the title, then press the CONTROL dial.
- (3) Turn the CONTROL dial to select the color, size, or position, then press the CONTROL dial.
- (4) Turn the CONTROL dial to select the desired item, then press the CONTROL dial.
- (5) Repeat steps 3 and 4 until the title is arranged as desired.
- (6) Press the CONTROL dial again to complete the setting.

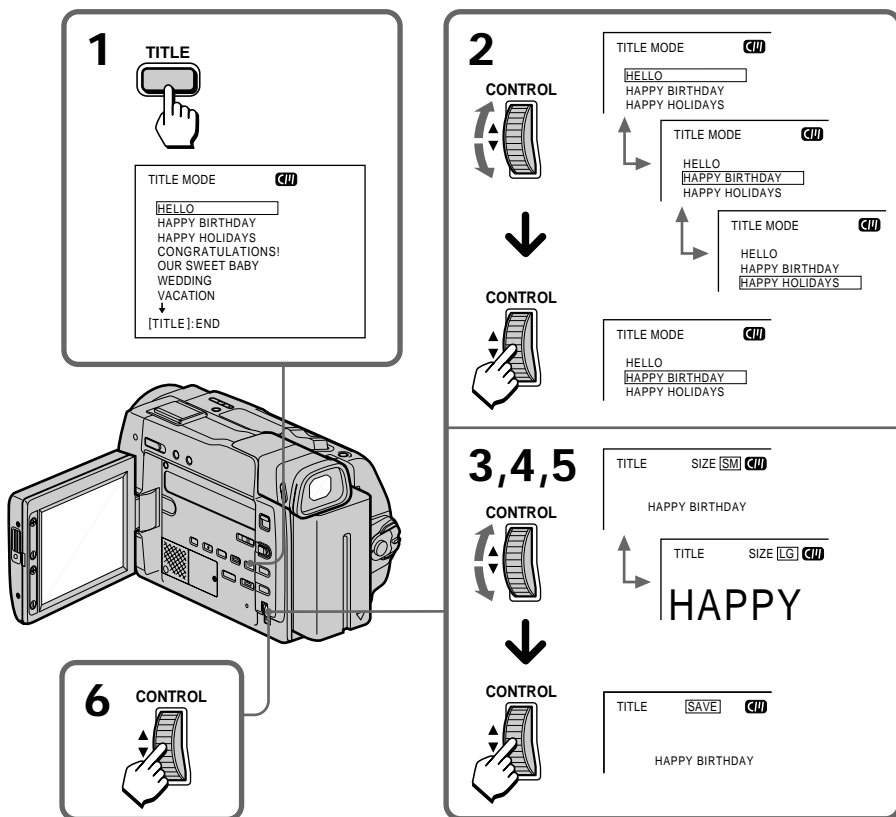

While you are playing back, pausing, or recording

After step 6, "SAVE" appears on the screen for 5 seconds and the title is set.

While in Standby mode

After step 6, the "TITLE" indicator appears. And when you press START/STOP to start recording, "SAVE" appears on the screen for 5 seconds and the title is set.

Titles placed from the top of the screen as follows:

HELLO ← ~~HAPPY BIRTHDAY~~ ← ~~HAPPY HOLIDAYS~~ ← ~~GONGRATULATIONS!~~ ↔
OUR SWEET BABY ← ~~WEDDING~~ ← ~~VACATION~~ ← ~~THE END~~ ← ~~CUSTOM TITLE~~.

When you have stored an original title

The title appears above "CUSTOM TITLE".

Title colors ("COL") changes as follows:

WHT (White) ← ~~YEL~~ (Yellow) ← ~~CYAN~~ (Cyan) ← ~~GRN~~ (Green) ← ~~VIO~~ (Violet) ← ~~RED~~ (Red) ← ~~BLUE~~ (Blue).

Title size ("SIZE") changes as follows:

LG (Large) ← ~~SM~~ (Small).

Title position ("POS") changes as follows:

If you select the title size "LG", you can choose 8 positions. When you select the title size "SM", you can choose 9 positions at all.

To display no title

Select OFF in the TITLE DSPL menu. But the title is displayed in case of Edit Search or Rec Review regardless of the menu settings.

Notes on titles

- While the title is displayed, the picture does not fade in or out.
- You cannot superimpose a title to a blank portion of the tape.
- The titles you superimposed are displayed by only using the DV format video equipment with index titler function.
- When you are searching the tape using the other video equipment, the portion of the tape you superimpose the title may be detected as an index signal.

Notes on the cassettes

- If you use a cassette tape set to prevent accidental erasure, you cannot superimpose the title. Slide the protect tab so that the red portion is not visible.
- You can superimpose about 11 to 20 titles in one cassette, if one title consists of about 5 characters.
- If the tape has too many index signals and photo data, you may not be able to superimpose a title because the memory is full.

Erasing a title

- (1) Press MENU to display the menu.
- (2) Turn the CONTROL dial to select TITLEERASE, then press the CONTROL dial.
- (3) Turn the CONTROL dial to select the title you want to erase, then press the CONTROL dial.
- (4) Make sure the title is the one you want to erase, then press the CONTROL dial again.
- (5) Press MENU to erase the menu display.

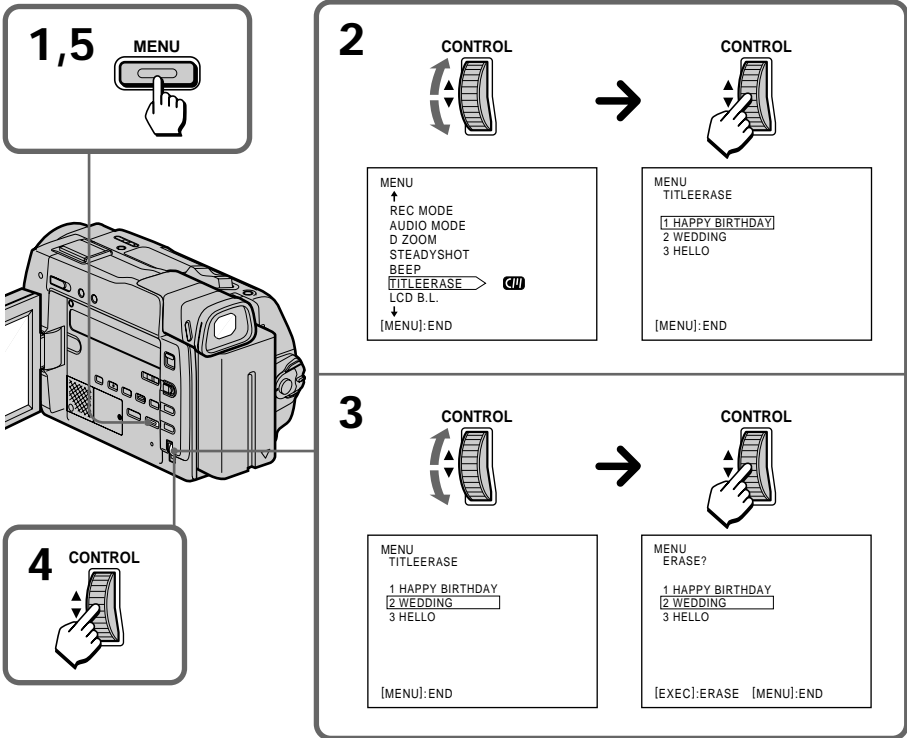

Note

If you use a cassette tape set to prevent accidental erasure, you cannot erase the title. Slide the protect tab so that the red portion is not visible.

Making a custom title

If you use a tape with cassette memory, you can make one title of up to 20 characters and store it in memory.

- (1) Press TITLE to display the titles on the LCD screen or in the viewfinder.
- (2) Turn the CONTROL dial to select CUSTOM TITLE, then press the CONTROL dial.
- (3) Turn the CONTROL dial to select the column of the desired character, then press the CONTROL dial.
- (4) Turn the CONTROL dial to select the desired character, then press the CONTROL dial.
- (5) Repeat steps 3 and 4 until you finish the title.
- (6) Turn the CONTROL dial to select [↵], then press the CONTROL dial.

1



TITLE

HELLO

HAPPY BIRTHDAY
HAPPY HOLIDAYS
CONGRATULATIONS!
OUR SWEET BABY
WEDDING
VACATION

[TITLE]:END

2

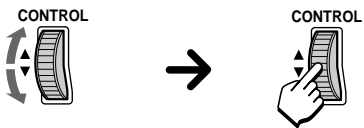

TITLE

HAPPY HOLIDAYS
CONGRATULATIONS!
OUR SWEET BABY
WEDDING
VACATION
THE END
CUSTOM TITLE

[TITLE]:END

CUSTOM TITLE

ABCDE 12345
FGHIJ 67890
KLMNO . . . / -
PQRST [←]
UVWXY [←]
Z& ?!

[TITLE]:END

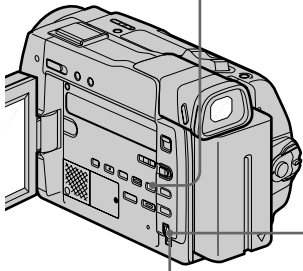

3,4,5



CUSTOM TITLE

ABCDE 12345
FGHIJ 67890
KLMNO . . . / -
PQRST [←]
UVWXY [←]
Z& ?!

[TITLE]:END

CUSTOM TITLE

ABCDE 12345
FGHIJ 67890
KLMNO . . . / -
PQRST [←]
UVWXY [←]
Z& ?!

[TITLE]:END

6

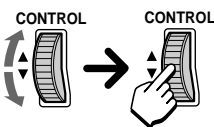

CUSTOM TITLE

MUSIC

ABCDE 12345
FGHIJ 67890
KLMNO . . . / -
PQRST [←]
UVWXY [←]
Z& ?!

[TITLE]:END

CUSTOM TITLE

ABCDE 12345
FGHIJ 67890
KLMNO . . . / -
PQRST [←]
UVWXY [←]
Z& ?!

[TITLE]:END

CUSTOM TITLE

M

ABCDE 12345
FGHIJ 67890
KLMNO . . . / -
PQRST [←]
UVWXY [←]
Z& ?!

[TITLE]:END

Making a custom title

To erase a character

In step 3, turn the CONTROL dial to select [←] then press the CONTROL dial. The last character is erased.

To change the title you have made

In step 2, turn the CONTROL dial to select CUSTOM TITLE, then press the CONTROL dial. Erase characters one after another, then make the new title again.

If it takes more than 5 minutes to make a title

If the Standby mode lasts for more than 5 minutes with a cassette inserted, the power will be turned off automatically. If the power is turned off while you are making a title, set the POWER switch to OFF once, then to CAMERA. The title you have made remains stored in memory.

Labeling a cassette

If you use a tape with cassette memory, you can label a cassette. The label can consist of up to 10 characters and is stored in cassette memory. When you insert the labeled cassette and turn the power on, the label is displayed on the LCD screen, in the viewfinder, or on the TV screen.

- (1) Insert the cassette you want to label.
- (2) Set the POWER switch to VTR.
- (3) Press MENU to display the menu.
- (4) Turn the CONTROL dial to select TAPE TITLE, then press the CONTROL dial.
- (5) Turn the CONTROL dial to select the column of the desired character, then press the CONTROL dial.
- (6) Turn the CONTROL dial to select the desired character, then press the CONTROL dial.
- (7) Repeat steps 5 and 6 until you finish the label.
- (8) Turn the CONTROL dial to select [↵], then press the CONTROL dial.

Labeling a cassette

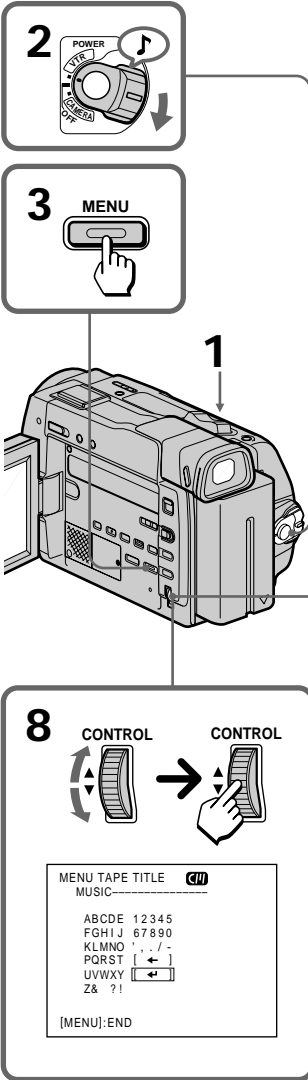

4

CONTROL

MENU
 ↑
 HI-FI SOUND
 REC MODE
 AUDIO MODE
 TITLEERASE
 TITLE DSPL
 TAPE TITLE
 BEEP
 ↓
 [MENU]:END

CONTROL

MENU TAPE TITLE

ABCDE 12345
 FGHIJ 67890
 KLMNO . . / -
 PQRST [←]
 UVWXY [→]
 Z & ?!

[MENU]:END

5,6,7

CONTROL

MENU TAPE TITLE

ABCDE 12345
 FGHIJ 67890
 KLMNO . . / -
 PQRST [←]
 UVWXY [→]
 Z & ?!

[MENU]:END

CONTROL

MENU TAPE TITLE

ABCDE 12345
 FGHIJ 67890
 KLMNO . . / -
 PQRST [←]
 UVWXY [→]
 Z & ?!

[MENU]:END

MENU TAPE TITLE

ABCDE 12345
 FGHIJ 67890
 KLMNO . . / -
 PQRST [←]
 UVWXY [→]
 Z & ?!

[MENU]:END

CONTROL

MENU TAPE TITLE

M-----
 ABCDE 12345
 FGHIJ 67890
 KLMNO . . / -
 PQRST [←]
 UVWXY [→]
 Z & ?!

[MENU]:END

Advanced operations

To erase a character

In step 5 turn the CONTROL dial to select [←], then press the CONTROL dial. The last character is erased.

To change the label you have made

Insert the cassette to change the label, and operate in the same way to make a new label.

If the mark appears in step 4

The cassette memory is full. If you erase the title in the cassette, you can label it.

If you have superimposed titles in the cassette

When the label is displayed, up to 4 titles also appear.

Note on “-----” indicator displayed on the LCD screen or in the viewfinder

The “-----” indicates the number of characters you can select for the label. When the “-----” indicator has fewer than 10 spaces, the cassette memory is full.

Note on the cassettes

If you use a cassette tape set to prevent accidental erasure, you cannot label it. Slide the protect tab so that the red portion is not visible.

Releasing the STEADYSHOT function

When you shoot, the  indicator appears on the LCD screen or in the viewfinder. This indicates that the SteadyShot function is working and the camcorder compensates for camera-shake.

You can release the SteadyShot function when you do not need to use the SteadyShot function. Do not use the SteadyShot function when shooting a stationary object with a tripod.

- (1) Press MENU to display the menu on the LCD screen.
- (2) Turn the CONTROL dial to select STEADYSHOT, then press the CONTROL dial.
- (3) Turn the CONTROL dial to select OFF, then press the CONTROL dial.
- (4) Press MENU to erase the menu display.

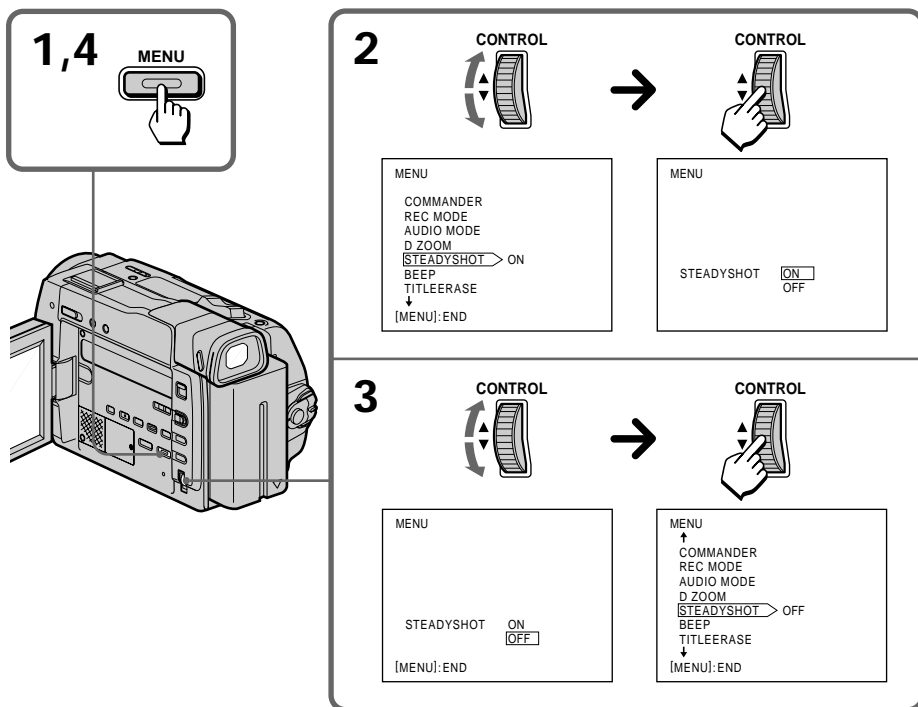

To activate the SteadyShot function again

Select ON in step 3, then press the CONTROL dial.

Notes on the SteadyShot function

- The SteadyShot function will not correct excessive camera-shake.
- When you switch the SteadyShot function on or off, the exposure may fluctuate.
- When the SteadyShot function is released, the  indicator does not appear.
- If you use a tele conversion lens (not supplied) or a wide conversion lens (not supplied), the SteadyShot function may not work.

Watching on a TV screen

Connect the camcorder to your VCR or TV to watch the playback picture on the TV screen. When monitoring the playback picture by connecting the camcorder to your TV, we recommend you to use house current for the power source.

Connecting directly to a VCR/TV with Audio/Video input jacks

Open the jack cover and connect the camcorder to the inputs on the TV by using the supplied A/V connecting cable. Set the TV/VCR selector on the TV to VCR. Turn down the volume of the camcorder.

To get higher quality pictures in DV format, connect the camcorder to your TV using the S video connecting cable (not supplied).

If you are going to connect the camcorder using the S video connecting cable (not supplied) **[a]** you do not need to connect the yellow (video) plug of the A/V connecting cable **[b]**

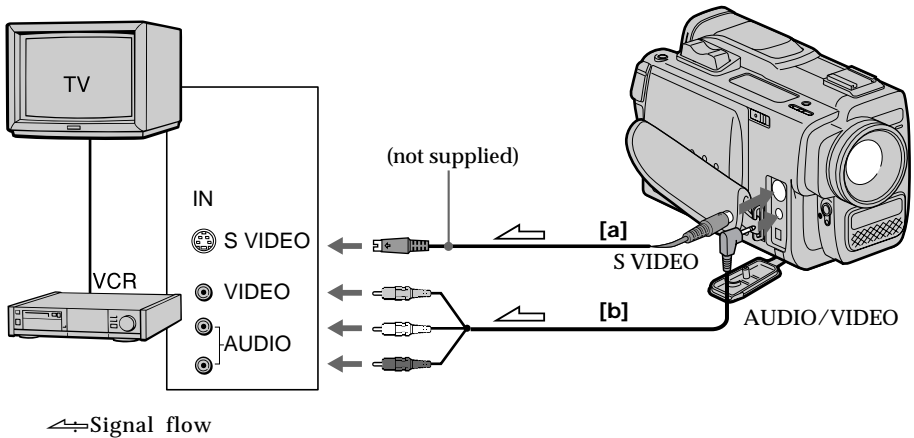

If your VCR or TV is a monaural type

Connect only the white plug for audio on both the camcorder and the VCR or the TV. If you connect the white plug, the sound is L (left) signal. If you connect the red plug, the sound is R (right) signal.

Using the AV cordless IR receiver — LASER LINK

Once you connect the AV cordless IR receiver (not supplied) having the  LASER LINK mark to your TV or VCR, you can easily view the picture on your TV. For details, refer to the operating instruction of the AV cordless IR receiver.

LASER LINK is a system which transmits and receives a picture and sound between video equipment having the  mark by using infrared rays. LASER LINK is a trademark of Sony Corporation.



To play back on a TV

- (1) Set the POWER switch on the camcorder to VTR.
- (2) After connecting your TV and AV cordless IR receiver, set the POWER switch on the AV cordless IR receiver to ON.
- (3) Turn the TV on the TV/VCR selector on the TV to VCR.
- (4) Press LASER LINK. The lamp of the LASER LINK button is flashing.
- (5) Press  on the camcorder to start playback.
- (6) Adjust the angle and direction of both the camcorder and AV cordless IR receiver.

To cancel the LASER LINK function

Press LASER LINK.

If you use a Sony TV

- You can turn on the TV automatically when you press LASER LINK or . To do so, set AUTO TV ON to ON in the menu system and turn the TV's main switch on, then do either of the following:
 - Point the LASER LINK emitter towards the TV's remote sensor and press LASER LINK.
 - Turn on the LASER LINK button and press .
- You can switch the video input of the TV automatically to the one which the AV cordless IR receiver is connected. To do so, set AUTO TV ON to ON and TV INPUT to the same video input (1, 2, 3) in the menu system. With some models, however, the picture and sound may be disconnected momentarily when the video input is switched.
- The above features may not work with some TV models.

Notes on LASER LINK

- When LASER LINK is activated (the LASER LINK button is lit), the camcorder consumes power. Press and turn off the LASER LINK button when it is not needed.
- When the conversion lens (not supplied) is installed, the transmission of infrared rays may be blocked.

Searching the boundaries of recorded tape with date – date search

You can search for the boundaries of recorded tape with date – Date Search function. To search the beginning of the specific date and play back from the point, there are two ways:

- Using cassette memory, you can select the date displayed on the LCD screen or in the viewfinder.
- Without using cassette memory.

You can only operate with the Remote Commander.

Searching for the date by using cassette memory

You can use this function only when playing back a tape with cassette memory (p.67).

- (1) Set the POWER switch to VTR.
 - (2) Press MENU to display the menu on the LCD screen.
 - (3) Turn the CONTROL dial to select CM SEARCH, then press the CONTROL dial.
 - (4) Turn the CONTROL dial to select ON, then press the CONTROL dial.
 - (5) Press SEARCH MODE on the Remote Commander repeatedly, until the date search indicator appears.
 - (6) Press ◀◀ or ▶▶ to select the date for playback.
- Playback starts from the beginning of the selected date automatically.

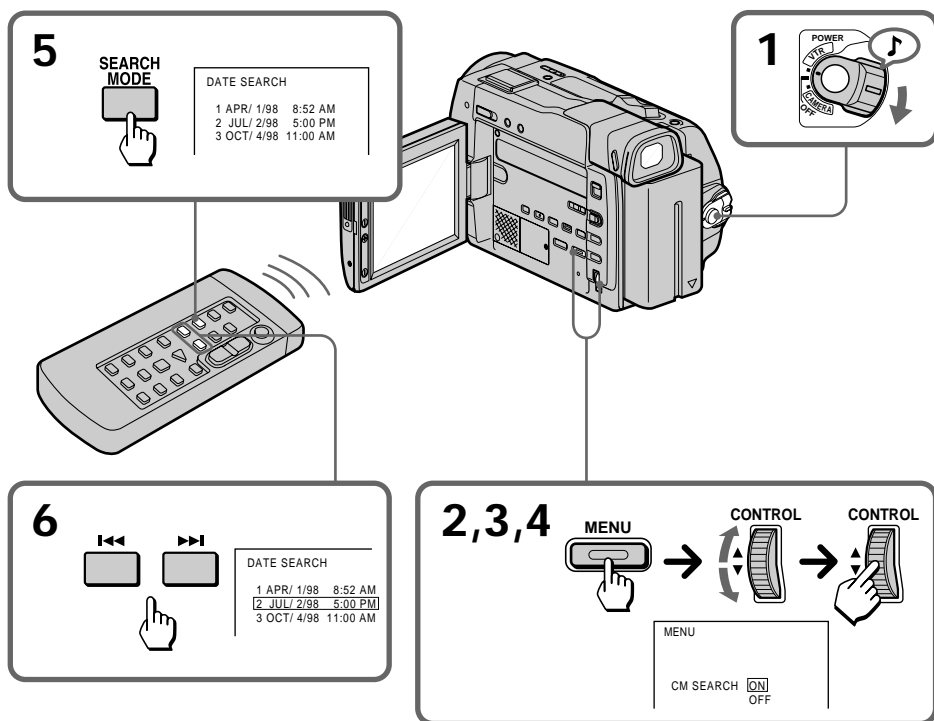

To stop searching

Press ■.

Notes

- The interval of the boundaries between the dates needs more than two minutes. The camcorder may not search if the beginning of the recorded date is too close to the next one.
- The short cursor on the screen suggests the date selected in the previous time.
- If a tape has a blank portion in the beginning or between recorded portions, the Date Search function will not work correctly.

Searching for the date without using cassette memory

You can use this function whether the tape has cassette memory or not.

- (1) Set the POWER switch to VTR.
 - (2) Press MENU to display the menu on the LCD screen.
 - (3) Turn the CONTROL dial to select CM SEARCH, then press the CONTROL dial.
 - (4) Turn the CONTROL dial to select OFF, then press the CONTROL dial.
 - (5) Press SEARCH MODE on the Remote Commander repeatedly, until the date search indicator appears.
 - (6) When the current position is [b], press ◀◀ to search towards [a] or press ▶▶ to search towards [c]. Each time you press ◀◀ or ▶▶, the camcorder searches for the previous or next date.
- Playback starts automatically when date changed.

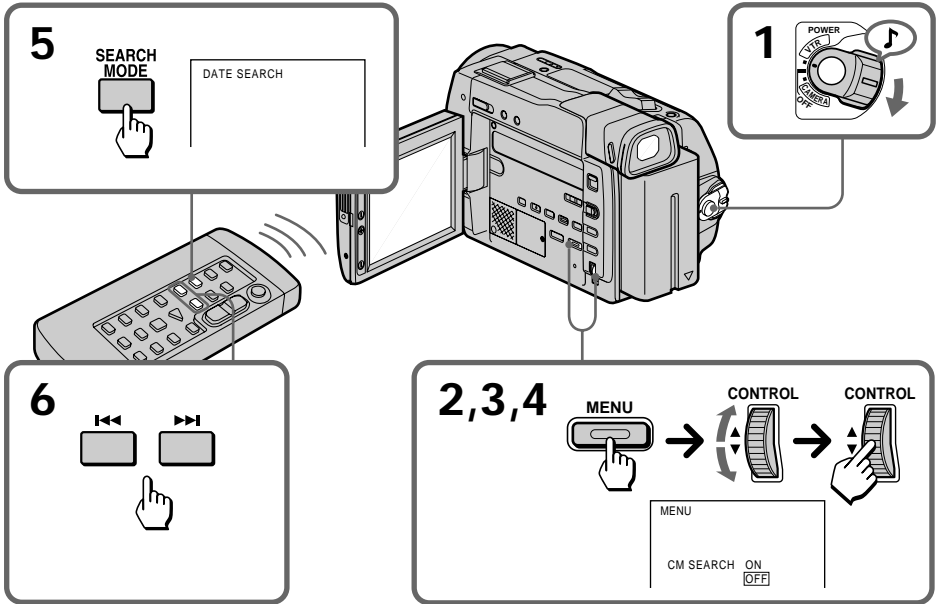
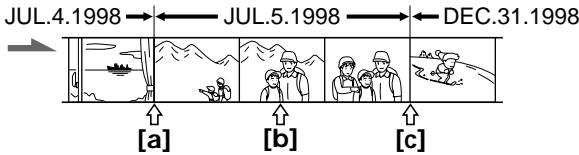

To stop searching
Press ■.

Searching the boundaries of recorded tape with title – title search

You can search for the boundaries of recorded tape with title – Title Search function. If you use a tape with cassette memory, you can select the title displayed on the LCD screen or in the viewfinder.

You can only operate with the Remote Commander.

Searching for the title by using cassette memory

You can use this function only when playing back a tape with cassette memory (p.67).

- (1) Set the POWER switch to VTR.
 - (2) Press MENU to display the menu on the LCD screen.
 - (3) Turn the CONTROL dial to select CM SEARCH, then press the CONTROL dial.
 - (4) Turn the CONTROL dial to select ON, then press the CONTROL dial.
 - (5) Press SEARCH MODE on the Remote Commander repeatedly, until the title search indicator appears.
 - (6) Press ◀◀ or ▶▶ to select the title for playback.
- Playback starts from the scene of the selected title automatically.

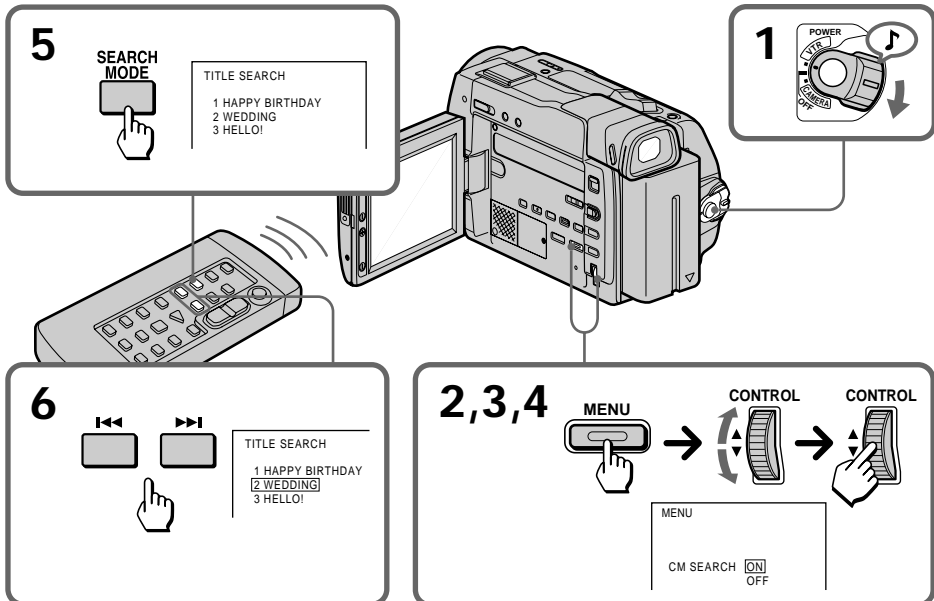

To stop searching
Press ■.

Notes

- You cannot superimpose or search a title, if you use a cassette tape without cassette memory.
- The camcorder may not search, if a tape has a blank portion in the beginning or between the recorded portions.

Searching for a photo – photo search/photo scan

You can search for the recorded still picture – Photo Search function. There are two modes in Photo Search:

- Using cassette memory, you can select the recorded date which is displayed on the LCD screen or in the viewfinder.
- Without using cassette memory.

You can also search for still pictures one after another and display each picture for five seconds automatically – Photo Scan function. Even if your tape has no cassette memory, you can use the Photo Scan function.

You can only operate with the Remote Commander.

Searching for a photo by using cassette memory – photo search

You can use this function only when playing back a tape with cassette memory (p.67).

- (1) Set the POWER switch to VTR.
 - (2) Press MENU to display the menu.
 - (3) Turn the CONTROL dial to select CM SEARCH, then press the CONTROL dial.
 - (4) Turn the CONTROL dial to select ON, then press the CONTROL dial.
 - (5) Press SEARCH MODE on the Remote Commander repeatedly, until the photo search indicator appears.
 - (6) Press **◀◀** or **▶▶** to select the date for playback.
- Playback starts from the photo of the selected date automatically.

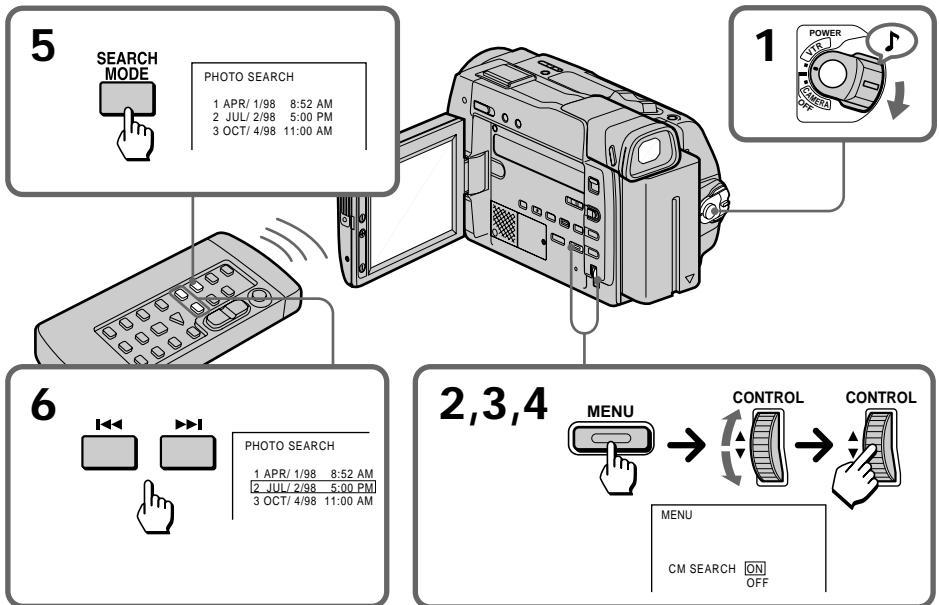

Searching for a photo – photo search/photo scan

To stop searching

Press ■.

Note

When you play back a tape which has a blank portion in the beginning or between the recorded portions, the Photo Search function will not work correctly.

Searching for a photo without using cassette memory – photo search

You can use this function whether the tape has cassette memory or not.

- (1) Set the POWER switch to VTR.
- (2) Press MENU to display the menu on the LCD screen.
- (3) Turn the CONTROL dial to select CM SEARCH, then press the CONTROL dial.
- (4) Turn the CONTROL dial to select OFF, then press the CONTROL dial.
- (5) Press SEARCH MODE on the Remote Commander repeatedly, until the photo search indicator appears.
- (6) Press ◀◀ or ▶▶ to select the photo for playback. Each time you press ◀◀ or ▶▶, the camcorder searches for the previous or next scene. Playback starts from the photo automatically.

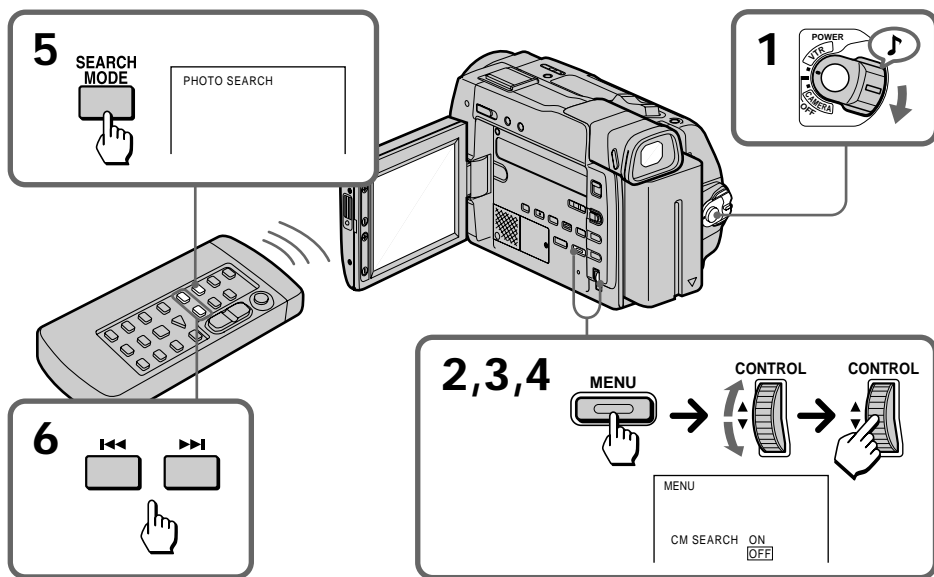

To stop searching

Press ■.

Scanning photo – photo scan

You can use this function whether the tape has cassette memory or not.

- (1) Set the POWER switch to VTR.
- (2) Press SEARCH MODE on the Remote Commander repeatedly until the photo scan indicator displayed on the LCD screen.
- (3) Press ◀◀ or ▶▶.

Each photos are displayed for about 5 seconds automatically.

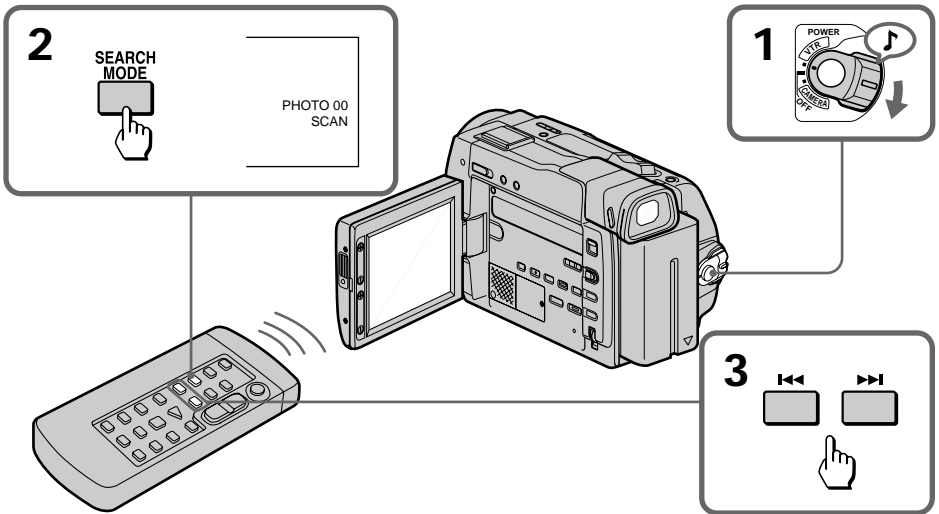

To stop searching
Press ■.

Returning to a pre-registered position

Using the Remote Commander, you can easily go back to the desired point on a tape after playback.

- (1) During playback, press ZERO SET MEMORY at the point you later want to locate. The counter shows "0:00:00" and "ZERO SET MEMORY" appears on the LCD screen or in the viewfinder.
- (2) Press ■ when you want to stop playback.
- (3) Press ◀◀ to rewind or press ▶▶ to fast-forward the tape to the counter's zero point. The tape stops automatically when the counter reaches approximately zero. "ZERO SET MEMORY" disappears and the time code appears.
- (4) Press ▷.

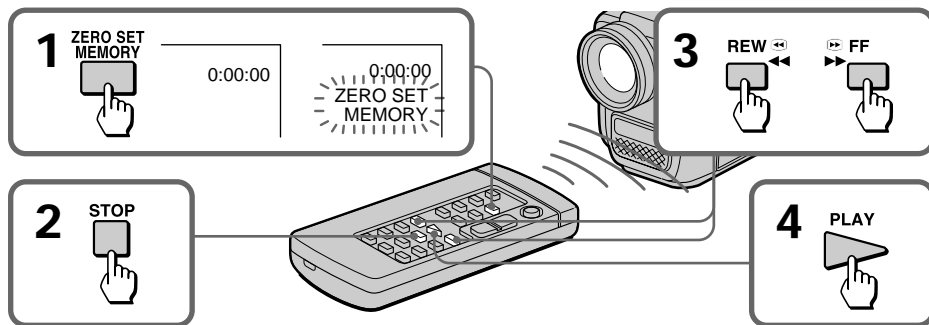

Note on the tape counter

There may be a discrepancy of several seconds from the time code.

Notes on ZERO SET MEMORY

- When you press ZERO SET MEMORY, the counter's zero point is memorized. Press ZERO SET MEMORY again before step 3 to cancel the memory.
- ZERO SET MEMORY may not function when there is a blank portion between pictures on a tape.
- ZERO SET MEMORY functions in recording standby mode.

Displaying recording data – data code function

You can display recording data (date/time or various settings when recorded) on the LCD screen or in the viewfinder during playback (Data Code). The Data Code is also displayed on the TV.

Press DATA CODE during playback.

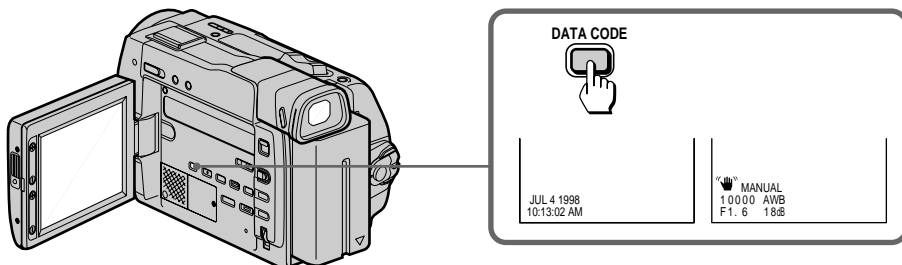

To select the items to be displayed

Set DATA CODE in the menu system, and select the following items:

When DATE/CAM is selected: date → various settings (SteadyShot, PROGRAM AE, shutter speed, white balance, aperture value, gain) → no indicator.

When DATE is selected: date → no indicator.

When you record a picture with adjusting the exposure to the darkest manually

“CLOSE” appears at the position of the iris indicator on the LCD screen or in the viewfinder.

When bars (- - -) appear

- A blank portion of the tape is being played back.
- The tape was recorded by a camcorder without having date and time set.
- The tape is unreadable due to tape damage or noise.

Editing onto another tape

You can create your own video program by editing with any other DV, ^{Mini DV} mini DV, 8 mm, Hi8, Hi8i, Hi8i8, VHS, VHS-C, SVHS, SVHS-C, VHSU, VHSU-C, SVHSU, SVHSU-C, Betamax or Betamax Hi-Fi VCR that has audio/video inputs. You can edit with little deterioration of picture and sound quality when using the DV connecting cable.

Before editing

Connect the camcorder to the VCR using the VMC-2DV DV connecting cable (not supplied) or the supplied A/V connecting cable.

Using the DV connecting cable

Simply connect the VMC-2DV DV connecting cable (not supplied) to DV IN/OUT and to DV IN/OUT of the DV products. With digital-to-digital connection, video and audio signals are transmitted in digital form for high-quality editing.

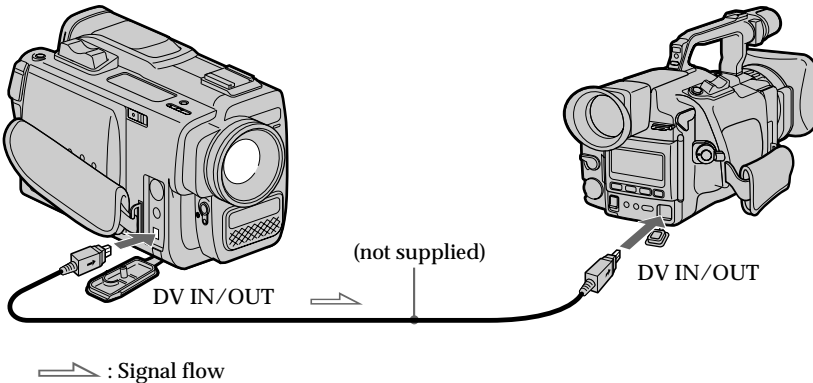

Notes on editing when using the DV connecting cable

- You can connect one VCR only.
- You can record picture, sound and system data at the same time on the DV products by using the DV connecting cable only.
- You cannot edit the titles, display indicator or the contents of cassette memory.
- If you record playback pause picture with the DV IN/OUT jack, the recorded picture becomes rough. And when you playback the picture using the other video equipment, the picture may jitter.
- You can also use the camcorder as a recorder with this connection. In this case “DV IN” indicator appears on the screen.
- When you use the camcorder as a recorder, the color balance may be incorrect on the monitor screen. But this is not recorded on the tape.

Editing onto another tape

Using the A/V connecting cable [a] or S video connecting cable (not supplied) [b]

Set the input selector on the VCR to LINE.

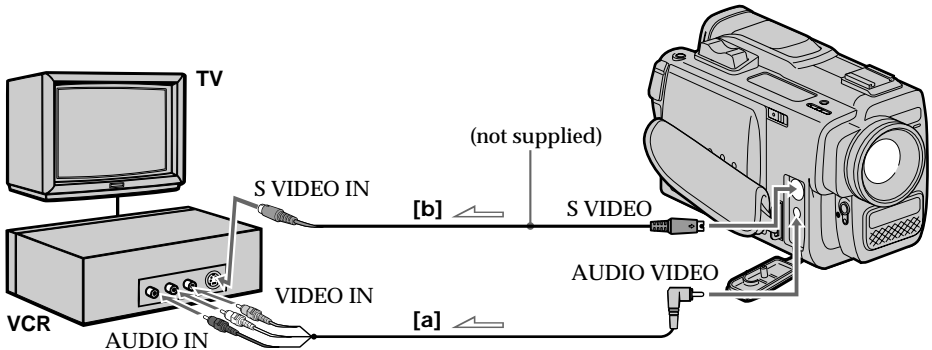

↙ : Signal flow

Notes on editing when using the A/V connecting cable

- Press DATA CODE , SEARCH MODE, or DISPLAY to turn off the display indicators. Otherwise, the indicators will be recorded on the tape.
- If your TV or VCR is a monaural type, connect the yellow plug of the A/V connecting cable for video to the TV or VCR. Connect only the white or red plug for audio to the TV or VCR. If you connect the white plug, the sound is L (left) signal. If you connect the red plug, the sound is R (right) signal.
- You can edit precisely by connecting a LANC cable to this camcorder and other video equipment having fine synchro-editing function, using this camcorder as a player.

Starting editing

- (1) Insert a blank tape (or a tape you want to record over) into the VCR, and insert your recorded tape into the camcorder.
- (2) Play back the recorded tape on the camcorder until you locate the point where you want to start editing, then press **II** to set the camcorder in playback pause mode.
- (3) On the VCR, locate the recording start point and set the VCR in recording pause mode.
- (4) Press **II** on the camcorder and VCR simultaneously to start editing.

To edit more scenes

Repeat steps 2 to 4.

To stop editing

Press **□** on both the camcorder and the VCR.

Recording from a VCR or TV

You can record a tape from another VCR or a TV program from a TV that has audio/video outputs. Connect the camcorder to the VCR or TV.

(1) While pressing the small green button on the POWER switch, set it to VTR and set DISPLAY to LCD in the menu system.

(2) Press REC  and the button on the right together at the point where you want to start recording.

In recording and the recording pause mode, S VIDEO and AUDIO/VIDEO jacks automatically work as input jacks.

If your VCR or TV has an S video jack, connect using the S video cable (not supplied) [a] to obtain a high quality picture.

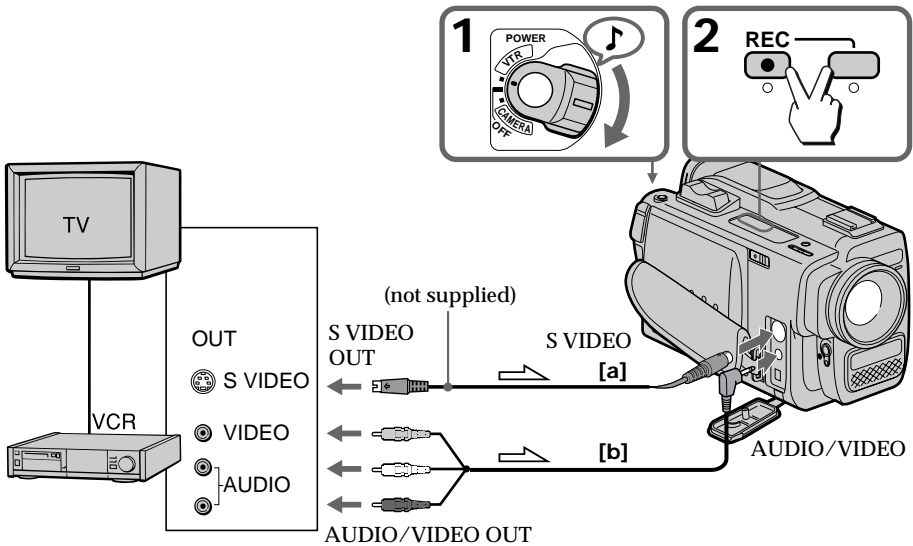

If your TV or VCR is a monaural type, connect the yellow plug of the A/V connecting cable for video to the TV or VCR. Connect only the white or red plug for audio to the TV or VCR. If you connect the white plug, the sound is L (left) signal. If you connect the red plug, the sound is R (right) signal.

If you are going to connect the camcorder using the S video cable (not supplied) [a], you do not need to connect the yellow (video) plug of the A/V connecting cable [b].

Note on using the S video connecting cable

If the S video plug is not provided on your TV or VCR, do not connect the S video cable (not supplied) to the camcorder. Pictures will not appear.

Note on the recording sound

The dual sound cannot be recorded in this camcorder.

To stop recording

Press .

Replacing recording on a tape – insert editing

You can insert a new scene from a VCR onto your originally recorded tape by specifying starting and ending points. After inserting editing, the previous picture and sound will be erased.

Connection is the same as on page 61 or 63. In recording and recording pause mode, DV IN/OUT jack automatically works as input jack.

- (1) While pressing the small green button on the POWER switch, set it to VTR.
- (2) On the VCR, locate the start point to be inserted and set it to playback pause mode.
- (3) On the camcorder, press \triangleright to set it to playback mode, and then locate the point where the insert should end by pressing \blacktriangleleft or \blacktriangleright . Then press \blacksquare to set it to playback pause mode.
- (4) Press ZERO SET MEMORY on the Remote Commander. The ZERO SET MEMORY indicator flashes and the end point of the insert is stored in memory.
- (5) On the camcorder, locate the point where the insert should begin by pressing \blacktriangleleft , then press \bullet REC to set it to recording pause mode.
- (6) Press \blacksquare on the camcorder and the VCR simultaneously to start insert editing. The insert editing stops automatically near the counter's zero point. Press \square to set the camcorder to stop mode.

To change the end point

Press ZERO SET MEMORY on the Remote Commander so that the ZERO SET MEMORY indicator disappears and begin from step 3.

Note on the inserted picture

The picture may be distorted at the end of the inserted portion when it is played back.

Audio dubbing

You can record an audio sound to add to the original sound on a tape by connecting audio equipment or a microphone. If you connect the audio equipment, you can add a sound on your recorded tape by specifying starting and ending points. The original sound will not be erased.

Dubbing with the AUDIO/VIDEO jack

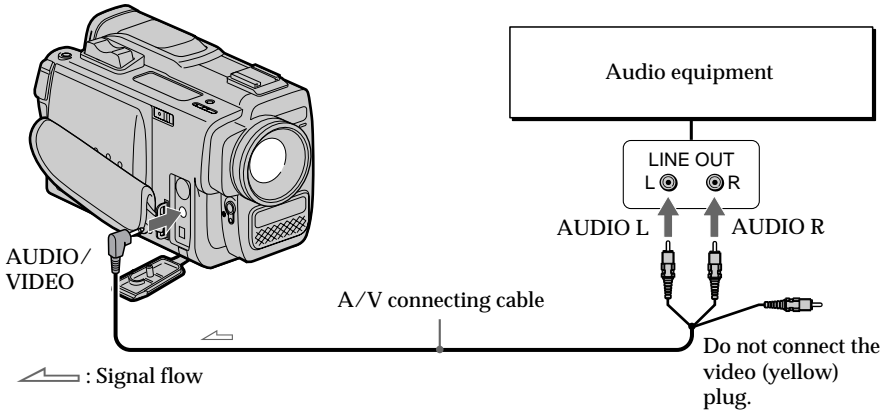

Note

The picture is not output from the AUDIO/VIDEO jack. Check the recorded picture in the viewfinder or on the LCD screen, as well as check the recorded sound by using a speaker or headphones.

Connecting with the MIC jack

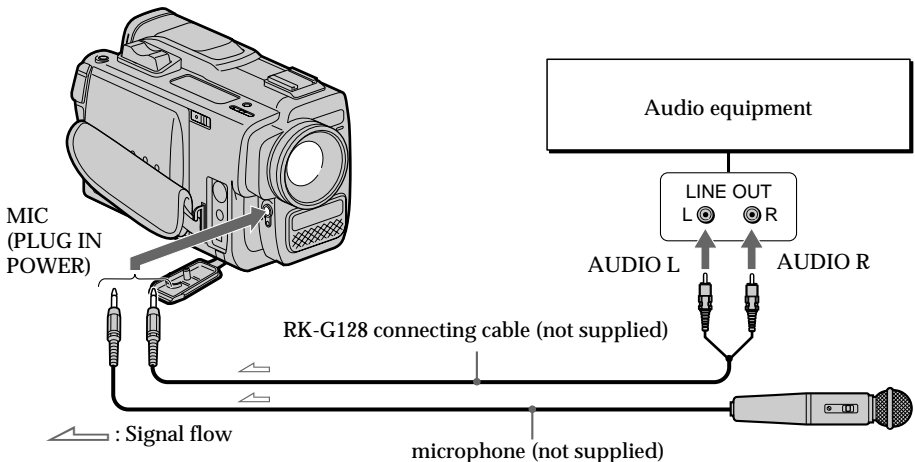

Note

You can check the recorded picture and sound connecting the AUDIO/VIDEO jack to a TV. The recorded sound is not output from a speaker. Check the sound by using TV or headphones.

Audio dubbing

Notes on audio dubbing

- A new sound cannot be recorded on a tape already recorded in the 16-bit mode (32 kHz, 44.1 kHz or 48 kHz).
- When an external microphone is not connected, the recording will be made through the built-in microphone of the camcorder.
- A new sound cannot be recorded on a tape already recorded in the LP mode.
- If you add a new sound on a tape recorded with another camcorder (including DCR-TRV9), the sound quality may become worse.
- When you record a playback pause picture with the DV jack, you cannot add audio to that portion of the tape.
- You cannot add audio with the DV jack.

Adding an audio sound on a recorded tape

- (1) Insert your recorded tape into the camcorder.
- (2) While pressing the small green button on the POWER switch, set it to VTR.
- (3) On the camcorder, locate the point where the recording should begin by pressing ◀◀ or ▶▶. Then press ■ to set it to playback pause mode.
- (4) Press AUDIO DUB on the Remote Commander .
- (5) Press ■ on the Remote Commander and at the same time start playing back the audio you want to record. The new sound will be recorded in stereo 2. The recorded sound in stereo 1 is not heard.
- (6) Press ■ on the Remote Commander at the point where you want to stop recording.

To play back the new recorded sound

Adjust the balance between the original sound (ST1) and the new sound (ST2) by selecting AUDIO MIX in menu system.

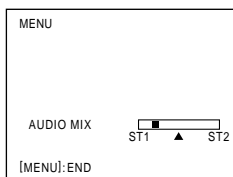

Five minutes after when you disconnect the power source or remove the battery pack, the settings of AUDIO MIX return to the original sound (ST1) only. The factory setting is original sound only.

To end audio more precisely

First, press ZERO SET MEMORY on the Remote Commander at the point where you want to stop recording. Then start recording from step 2, and the recording stops automatically near the counter's zero point.

Usable cassettes and playback modes

Selecting cassette types

You can use the **Mini DV** mini DV cassette only. You cannot use any other **DV** DV, **8** 8 mm, **Hi8** Hi8, **VHS**VHS, **S-VHS**-VHS, **VHS-C**VHSC, **S-VHS-C**VHSC, **B** Betamax or **ED-BE** Betamax cassette.

We recommend mini DV cassette with cassette memory.

There are two types of mini DV cassettes: with cassette memory and without cassette memory. We recommend you to use the tape with cassette memory. The IC memory is mounted on this type of mini DV cassette. This camcorder can read and write data such as dates of recording or titles, etc. to this memory. The functions using the cassette memory require successive signals recorded on the tape. If the tape has a blank portion in the beginning or between the recorded portions, a title may not be displayed properly or the search functions may not work properly. Not to make any blank portion on the tape, operate the followings.

Press END SEARCH to go to the end of the recorded portion before you begin the next recording if you operate the followings:

- you have ejected the cassette while recording.
- you have played back the tape in the VTR mode.
- you have used the Edit Search function.

If there is a blank portion or discontinuous signal on your tape, re-record from the beginning to the end of the tape concerning above.

* The same result may occur when you record using a digital video camera recorder without a cassette memory function on a tape recorded by one with the cassette memory function.

Tapes with cassette memory have **CIII** (Cassette Memory) mark. Sony recommends that you use a tape having **CIII** mark to enjoy this camcorder fully.

When you play back

Copyright signal

When playing back

Using any other video camera recorder, you cannot record on a tape that has recorded a copyright control signals for copyright protection of software which is played back in this camcorder.

When recording

Using this camcorder, you cannot record software that has recorded a copyright control signals for copyright protection of software. "COPY INHIBIT" appears on the LCD screen, in the viewfinder or on the TV screen if you try to record such software.

Audio mode

12-bit mode: The original sound can be recorded in stereo 1, and the new sound in stereo 2 in 32 kHz. The balance between stereo 1 and stereo 2 can be adjusted by selecting AUDIO MIX in the menu system during playback. Both sounds can be played back.

16-bit mode: A new sound cannot be recorded but the original sound can be recorded in high quality. Moreover, it can also play back sound recorded in 32 kHz, 44.1 kHz or 48 kHz. When playing back a tape recorded in the 16-bit mode, 16BIT indicator appears on the LCD screen or in the viewfinder.

Notes on the mini DV cassette

To prevent accidental erasure

Slide out the protect tab on the cassette so that the red portion is visible. [a]

When affixing a label on the mini DV cassette

Be sure to affix a label on only the location as illustrated below so as not to cause malfunction of the camcorder. [b]

After using the mini DV cassette

Rewind the tape to the beginning, put the cassette in its case, and store it in an upright position.

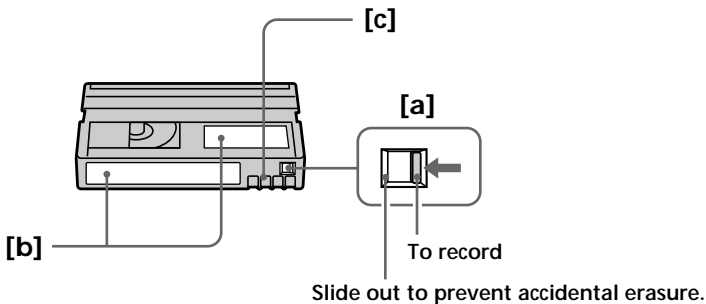

Note on gold-plated connector

If the gold-plated connector of mini DV cassettes is dirty or dusty, you may not operate the function using cassette memory. Clean up the gold-plated connector with cotton-wool swab, about every 10 times ejection of a cassettes. [c]

Charging the vanadium-lithium battery in the camcorder

Your camcorder is supplied with a vanadium-lithium battery installed so as to retain the date and time, etc., regardless of the setting of the POWER switch. The vanadium-lithium battery is always charged as long as you are using the camcorder. The battery, however, will get discharged gradually if you do not use the camcorder. It will be completely discharged in about six months if you do not use the camcorder at all. Even if the vanadium-lithium battery is not charged, it will not affect the camcorder operation. To retain the date and time, etc., charge the battery if the battery is discharged. The following are charging methods:

- Connect the camcorder to house current using the supplied AC power adaptor, and leave the camcorder with the POWER switch turned off for more than 24 hours.
- Or install the fully charged battery pack in the camcorder, and leave the camcorder with the POWER switch turned off for more than 24 hours.

Resetting the date and time

The date and time are set at the factory. Set the time according to the local time in your country. If you do not use the camcorder for about six months, the date and time settings may be released (bars may appear) because the vanadium-lithium battery installed in the camcorder will have been discharged. In this case, first charge the vanadium-lithium battery, then reset the date and time.

- (1) While pressing the small green button on the POWER switch, set it to CAMERA.
- (2) Press MENU to display the menu on the LCD screen or in the viewfinder.
- (3) Select CLOCK SET, then press the CONTROL dial.
- (4) Turn the CONTROL dial to adjust the year, and then press the CONTROL dial.
- (5) Set the month, day, hour and minutes by turning and pressing the CONTROL dial.
- (6) Press MENU to erase the menu display.

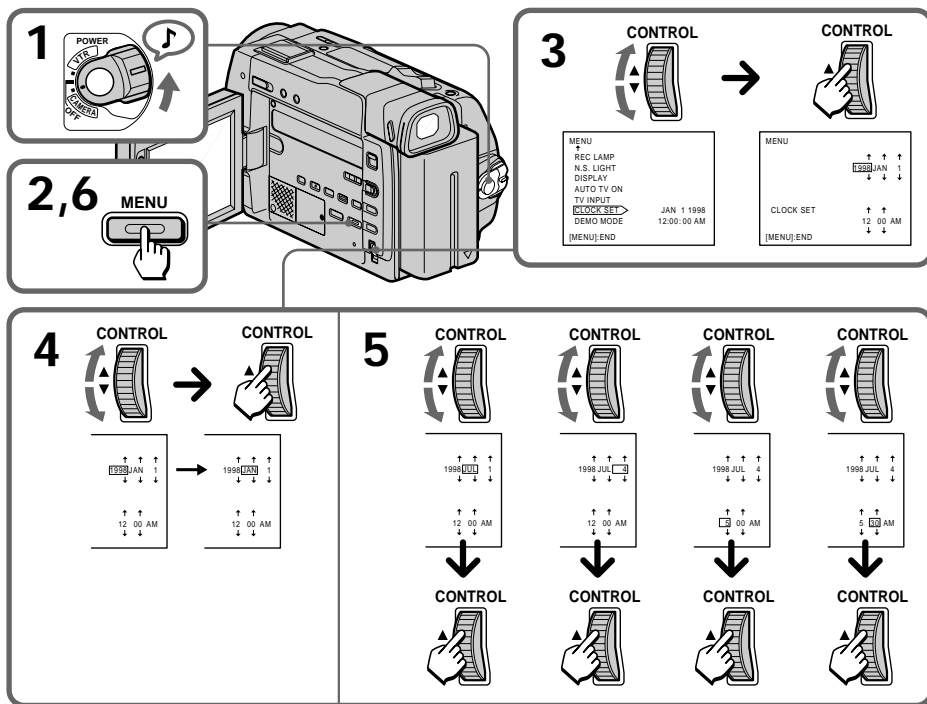

To correct the date and time setting

Repeat steps 2 to 5.

The year indicators changes as follows:

→ 1998 → 1999 → 2001 → 2029 →

Note on the time indicator

The internal clock of this camcorder operates on a 12-hour cycle.

- 12:00 AM stands for midnight.
- 12:00 PM stands for noon.

Tips for using the battery pack

This section shows you how you can get the most out of your battery pack.

Preparing the battery pack

Always carry additional batteries

Have sufficient battery pack power to do 2 to 3 times as much recording as you have planned.

Battery life is shorter in a cold environment

Battery efficiency is decreased, and the battery will be used up more quickly, if you are recording in a cold environment.

To save battery power

Do not leave the camcorder in Standby mode when not recording to save the battery power. A smooth transition between scenes can be made even if recording is stopped and started again. While you are positioning the subject, selecting an angle, or looking at the LCD screen or through the viewfinder, the lens moves automatically and the battery is used. The battery is also used when a tape is inserted or removed.

When to replace the battery pack

While you are using your camcorder, the remaining battery indicator on the LCD screen or in the viewfinder decreases gradually as battery power is used up.

The remaining time in minutes also appears.



When the remaining battery indicator reaches the lowest point, the  indicator appears and starts flashing on the LCD screen or in the viewfinder.

When the  indicator on the LCD screen or in the viewfinder changes from slow flashing to rapid flashing while you are recording, set the POWER switch to OFF on the camcorder and replace the battery pack. Leave the tape in the camcorder to obtain a smooth transition between scenes after the battery pack has been replaced.

Notes on the rechargeable battery pack

Caution

Never leave the battery pack in temperatures above 140°F (60°C), such as in a car parked in the sun or under direct sunlight.

The battery pack heats up

During charging or recording, the battery pack heats up. This is caused by energy that has been generated and a chemical change that has occurred inside the battery pack. This is not cause for concern, and is normal.

Battery pack care

- Remove the battery pack from the camcorder after using it, and keep it in a cool place. When the battery pack is installed to the camcorder, a small amount of current flows to the camcorder even if the POWER switch is set to OFF. This shortens battery life.
- The battery pack is always discharging even when it is not in use after charging. Therefore, you should charge the battery pack right before using the camcorder.

The life of the battery pack

If the battery indicator flashes rapidly just after turning on the camcorder with a fully charged battery pack, the battery pack should be replaced with a new fully charged one.

Charging temperature

You should charge batteries at temperatures from 50°F to 86°F (from 10°C to 30°C). Lower temperatures require a longer charging time.

Notes on the “InfoLITHIUM” Battery Pack

What is the “InfoLITHIUM” battery pack

The “InfoLITHIUM” battery pack is a lithium battery pack which can exchange data with compatible video equipment about its battery consumption.

Sony recommends that you use the “InfoLITHIUM” battery pack with video equipment having the  InfoLITHIUM mark.

When you use this battery pack with video equipment having the  InfoLITHIUM mark, the video equipment will indicate the remaining battery time in minutes.*

* The indication may not be accurate depending on the condition and environment which the equipment is used under.

How the battery consumption is displayed



The power consumption of the camcorder changes depending on its use, such as whether the LCD is used or not, how the autofocusing is working on or not.

While checking the condition of the camcorder, the “InfoLITHIUM” battery pack measures the battery consumption and calculates the remaining battery power. If the condition changes drastically, the remaining battery indication may suddenly decrease or increase by more than 2 minutes.

Even if 5 to 10 minutes is indicated as the battery remaining time on the LCD or viewfinder, the  indicator may also flash under some conditions.

To obtain more accurate remaining battery indication

Set the camcorder to recording standby mode and point towards a stationary object. Do not move the camcorder for 30 seconds or more.

- If the indication seems incorrect, use up the battery and then recharge it fully (Full charge¹⁾). Note that if you have used the battery in a hot or cold environment for long time, or you have repeated charging many times, the battery may not be able to show the correct time even after being fully charged.
- After you have used the “InfoLITHIUM” battery pack with an equipment not having the  InfoLITHIUM mark, make sure that you use up the battery on the equipment having the  InfoLITHIUM mark and then recharge fully.

Why the remaining battery indication does not match the continuous recording time in the operating instruction

The recording time is affected by the environmental temperature and conditions. The recording time becomes very short in a cold environment. The continuous recording time in the operating instruction is measured under the condition of using a fully charged (or normal charged²⁾) battery pack in 77 °F (25 °C). As the environmental temperature and condition are different when you actually use the camcorder, the remaining battery time is not same as the continuous recording time in the operating instruction.

¹⁾ Full charge: Charging for about 1 hour after the charge lamp of the AC power adaptor goes off.

²⁾ Normal charge: Charging just until the charge lamp of the AC power adaptor goes off.

Notes on charging

A brand-new battery pack

A brand-new battery pack is not charged. Before using the battery pack, charge it completely.

Recharge the battery pack whenever you like

You do not have to discharge it before recharging. If you charged the battery pack fully but you did not use it for a long time, it becomes discharged. Then recharge the battery pack before use.

Notes on the terminals

If the terminals (metal parts on the back) are not clean, the battery charge duration will be shortened.

When the terminals are not clean or when the battery pack has not been used for a long time, repeatedly install and remove the battery pack a few times. This improves the contact condition. Also, wipe the +, - and C terminals with a soft cloth or paper.

Be sure to observe the following



- Keep the battery pack away from fire.
- Keep the battery pack dry.
- Do not open nor try to disassemble the battery pack.
- Do not expose the battery pack to any mechanical shock.

Maintenance information and precautions

Moisture condensation

If the camcorder is brought directly from a cold place to a warm place, moisture may condense inside the camcorder, on the surface of the tape, or on the lens. In this condition, the tape may stick to the head drum and be damaged or the camcorder may not operate correctly. To prevent possible damage under these circumstances, the camcorder is furnished with moisture sensors. Take the following precautions.

Inside the camcorder

If there is moisture inside the camcorder, the beep sounds and the  indicator flashes. If this happens, none of the function except cassette ejection will work. Open the cassette compartment, turn off the camcorder, and leave it about 1 hour. When  indicator flashes at the same time, the cassette is inserted in the camcorder. Eject the cassette, turn off the camcorder, and leave also the cassette about 1 hour.

On the lens

If moisture condenses on the lens, no indicator appears, but the picture becomes dim. Turn off the power and do not use the camcorder for about 1 hour.

How to prevent moisture condensation



When bringing the camcorder from a cold place to a warm place, put the camcorder in a plastic bag and allow it to adapt to room conditions over a period of time.

- (1) Be sure to tightly seal the plastic bag containing the camcorder.
- (2) Remove the bag when the air temperature inside it has reached the temperature surrounding it (after about 1 hour).

Video head cleaning

To ensure normal recording and clear pictures, clean the video heads.

The video heads may be dirty when:

- mosaic-pattern noise appears on the playback picture
- playback pictures do not move
- playback pictures are hardly visible
- playback pictures do not appear
- the  indicator and “ CLEANING CASSETTE” message appear one after another or the  indicator flashes on the LCD screen or in the viewfinder

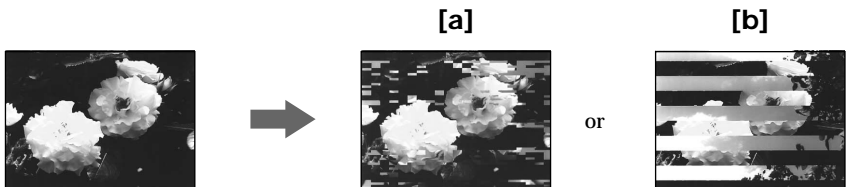

If [a] or [b] happens, clean the video heads with the Sony DVM12CL cleaning cassette (not supplied). Check the picture and if the above problem persists, repeat the cleaning. (Do not repeat cleaning more than 5 times in one session.)

Note

If the DVM12CL cleaning cassette (not supplied) is not available in your area, consult your nearest Sony dealer.

Precautions

Camcorder operation

- Operate the camcorder on 7.2 V (battery pack) or 8.4 V (AC power adaptor).
- Should any solid object or liquid get inside the casing, unplug the camcorder and have it checked by Sony dealer before operating it any further.
- Avoid rough handling or mechanical shock. Be particularly careful of the lens.
- Keep the POWER switch set to OFF when not using the camcorder.
- Do not wrap up the camcorder and operate it since heat may build up internally.
- Keep the camcorder away from strong magnetic fields or mechanical vibration.

On handling tapes

- Do not insert anything in the small holes on the cassette.
- Do not open the tape protect cover or touch the tape.
- Avoid touching or damaging the terminals. To remove dust, clean the terminals with a soft cloth.

Camcorder care

- When the camcorder is not to be used for a long time, disconnect the power source and remove the tape. Periodically turn on the power, operate the camera and player sections and play back a tape for about 3 minutes.
- Clean the lens with a soft brush to remove dust. If there are fingerprints on the lens, remove them with a soft cloth.
- Clean the camcorder body with a dry soft cloth, or a soft cloth lightly moistened with a mild detergent solution. Do not use any type of solvent which may damage the finish.
- Do not let sand get into the camcorder. When you use the camcorder on a sandy beach or in a dusty place, protect it from the sand or dust. Sand or dust may cause the unit to malfunction, and sometimes this malfunction cannot be repaired.

AC power adaptor

Charging

- Use only an “InfoLITHIUM” type battery pack.
- Place the battery pack on a flat surface without vibration during charging.
- The battery pack will get hot during charging. This is normal.

Others

- Unplug the unit from the wall outlet when not in use for a long time. To disconnect the power cord, pull it out by the plug. Never pull the cord itself.
- Do not operate the unit with a damaged cord or if the unit has been dropped or damaged.
- Do not bend the AC power cord forcibly, or put a heavy object on it. This will damage the cord and may cause a fire or an electrical shock.
- Be sure that nothing metallic comes into contact with the metal parts of the connecting plate. If this happens, a short may occur and the unit may be damaged.
- Always keep the metal contacts clean.
- Do not disassemble the unit.
- Do not apply mechanical shock or drop the unit.
- While the unit is in use, particularly during charging, keep it away from AM receivers and video equipment because it will disturb AM reception and video operation.
- The unit becomes warm while in use. This is normal.
- Do not place the unit in locations that are:
Extremely hot or cold, Dusty or dirty, Very humid, Vibrating

Note on dry batteries

To avoid possible damage from battery leakage or corrosion, observe the following.

- Be sure to insert the batteries in the correct direction.
- Dry batteries are not rechargeable.
- Do not use a combination of new and old batteries.
- Do not use different types of batteries.
- The batteries slowly discharge while not in use.
- Do not use a battery that is leaking.

If battery leakage occurred

- Wipe off the liquid in the battery case carefully before replacing the batteries.
- If you touch the liquid, wash it off with water.
- If the liquid get into your eyes, wash your eyes with a lot of water and then consult a doctor.

If any difficulty should arise, unplug the unit and contact your nearest Sony dealer.

Using your camcorder abroad

Each country or area has its own electric and TV color systems. Before using your camcorder abroad, check the following points.

Power sources

You can use your camcorder in any country or area with the supplied AC power adaptor within 110 V to 240 V AC, 50/60 Hz. Use a commercially available AC plug adaptor [a], if necessary, depending on the design of the wall outlet [b].

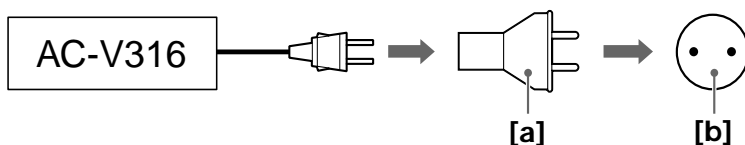

Difference in color systems

This camcorder is a NTSC system-based camcorder. If you want to view the playback picture on a TV, it must be a NTSC system-based TV.

Check the following list.

NTSC system

Bahama Islands, Bolivia, Canada, Central America, Chile, Colombia, Ecuador, Jamaica, Japan, Korea, Mexico, Peru, Surinam, Taiwan, the Philippines, the U.S.A., Venezuela, etc.

PAL system

Australia, Austria, Belgium, Czech Republic, China, Denmark, Finland, Germany, Great Britain, Holland, Hong Kong, Italy, Kuwait, Malaysia, New Zealand, Norway, Portugal, Singapore, Slovak Republic, Spain, Sweden, Switzerland, Thailand, etc.

PAL-M system

Brazil

PAL-N system

Argentina, Paraguay, Uruguay

SECAM system

Bulgaria, France, Guiana, Hungary, Iran, Iraq, Monaco, Poland, Russia, Ukraine, etc.

Trouble check



If you run into any problem using the camcorder, use the following table to troubleshoot the problem. Should the difficulty persist, disconnect the power source and contact your Sony dealer or local authorized Sony service facility.

Camcorder

Power

Symptom	Cause and/or corrective actions
The power is not on.	<ul style="list-style-type: none">• The battery pack is not installed. → Install the battery pack. (p. 7)• The battery is dead. → Use a charged battery pack. (p. 7)• The AC power adaptor is not connected to a wall outlet. → Connect the AC power adaptor to a wall outlet. (p. 23)
The power goes off.	<ul style="list-style-type: none">• While being operated in CAMERA mode, the camcorder has been in Standby mode for more than 5 minutes. → Set the POWER switch to OFF, then to CAMERA. (p. 11)• The battery is dead. → Use a charged battery pack. (p. 7)
The battery pack is quickly discharged.	<ul style="list-style-type: none">• The ambient temperature is too low. (p. 70)• The battery pack has not been charged fully. → Charge the battery pack again. (p. 7)• The battery pack is completely dead, and cannot be recharged. → Use another battery pack. (p. 23)

Operation

Symptom	Cause and/or corrective actions
START/STOP does not operate.	<ul style="list-style-type: none">• The tape is stuck to the drum. → Eject the cassette. (p. 10)• The tape has run out. → Rewind the tape or use a new one. (p. 20)• The POWER switch is set to VTR. → Set it to CAMERA. (p. 11)• The tab on the cassette is out (red). → Use a new tape or slide the tab. (p. 10)
The cassette cannot be removed from the holder.	<ul style="list-style-type: none">• The battery is dead. → Use a charged battery pack or the AC power adaptor. (p. 7, 23)
 and  indicators flash and no function except for cassette ejection works.	<ul style="list-style-type: none">• Moisture condensation has occurred. → Remove the cassette and leave the camcorder for at least 1 hour. (p. 74)
"CLOCK SET" appears when the camcorder is turned on.	<ul style="list-style-type: none">• Reset the date and time. (p. 69)
The End Search function does not activate.	<ul style="list-style-type: none">• You did not make a new recording after reinserting the cassette.• The tape without cassette memory ejected after recording.

Operation

Symptom	Cause and/or corrective actions
The tape does not move when a tape transport button is pressed.	<ul style="list-style-type: none"> • The POWER switch is set to CAMERA or OFF. → Set it to VTR. (p. 20) • The tape has run out. → Rewind the tape or use a new one. (p. 20)
No sound or only a low sound is heard when playing back a tape.	<ul style="list-style-type: none"> • The volume is turned to the minimum. → Open the LCD panel and press VOL +. (p. 20) • AUDIO MIX is set to ST2 side in the menu system. → Adjust AUDIO MIX in the menu system (p. 66).
The new sound added to the recorded tape is not heard.	<ul style="list-style-type: none"> • AUDIO MIX is set to ST1 side in the menu system. → Adjust AUDIO MIX in the menu system (p. 66).
The SteadyShot function does not activate.	<ul style="list-style-type: none"> • STEADYSHOT is set to OFF in the menu system. → Set it to ON. (p. 49)
Recording stops in a few seconds.	<ul style="list-style-type: none"> • The START/STOP MODE switch is set to 5SEC or $\frac{1}{2}$ ANTI GROUND SHOOTING. → Set it to $\frac{1}{2}$. (p. 14)
The autofocus function does not activate.	<ul style="list-style-type: none"> • Focus is set to the manual mode. → Set it to autofocus. (p. 37) • Shooting conditions are not suitable for autofocus. → Set focus to manual mode to focus manually. (p. 37)
The fader function does not work.	<ul style="list-style-type: none"> • The START/STOP MODE switch is set to 5SEC or $\frac{1}{2}$ ANTI GROUND SHOOTING. → Set it to $\frac{1}{2}$. (p. 14) • A title is displayed on the LCD screen or in the viewfinder. → Clear the title. (p. 29)
The title is not displayed.	<ul style="list-style-type: none"> • TITLE DSPL is set to OFF in the menu system. → Set it to ON in the menu system. (p. 24)
The title is not recorded.	<ul style="list-style-type: none"> • The tape has no cassette memory. → Use a tape with cassette memory. (p. 41) • The cassette memory is full. → Erase another title. (p. 43) • The tape is set to prevent accidental erasure. → Slide the protect tab so that red portion is not visible. (p. 42) • Nothing is recorded in that position on the tape. → Superimpose the title to the recorded position. (p. 42)
The cassette label is not recorded.	<ul style="list-style-type: none"> • The tape has no cassette memory. → Use a tape with cassette memory. (p. 46) • The cassette memory is full. → Erase some titles. (p. 43) • The tape is set to prevent accidental erasure. → Slide the protect tab so that red portion is not visible. (p. 48)
Displaying the recorded date, date search function does not work.	<ul style="list-style-type: none"> • The tape has no cassette memory. → Use a tape with cassette memory. (p. 52) • CM SEARCH is set to OFF in the menu system. → Set it to ON. (p. 52)

Operation

Symptom	Cause and/or corrective actions
The title search function does not work.	<ul style="list-style-type: none"> The tape has no cassette memory. <ul style="list-style-type: none"> → Use a tape with cassette memory. (p. 55) CM SEARCH is set to OFF in the menu system. <ul style="list-style-type: none"> → Set it to ON. (p. 55) There is no title in the tape. <ul style="list-style-type: none"> → Superimpose the titles. (p. 41)
C// indicator does not appear when using a tape with cassette memory.	<ul style="list-style-type: none"> The gold-plated connector of the tape is dirty or dusty. <ul style="list-style-type: none"> → Clean the gold-plated connector. (p. 68)
The Date Search, Title Search, or End Search does not work correctly.	<ul style="list-style-type: none"> The tape has a blank portion in the beginning or between the recorded portion. (p. 67)

Picture

Symptom	Cause and/or corrective actions
The image on the viewfinder screen is not clear.	<ul style="list-style-type: none"> The viewfinder lens is not adjusted. <ul style="list-style-type: none"> → Adjust the viewfinder lens. (p. 12)
A vertical band appears when a subject such as lights or a candle flame is shot against a dark background.	<ul style="list-style-type: none"> The contrast between the subject and background is too high. The camcorder is not malfunctioning. <ul style="list-style-type: none"> → Change locations.
The picture is "noisy" or does not appear.	<ul style="list-style-type: none"> The video heads may be dirty. <ul style="list-style-type: none"> → Clean the heads using the Sony DVM12CL (not supplied) cleaning cassette. (p. 74)
⊗ indicator flashes on the LCD screen or in the viewfinder.	<ul style="list-style-type: none"> The video heads may be dirty. <ul style="list-style-type: none"> → Clean the heads using the Sony DVM12CL (not supplied) cleaning cassette. (p. 74)
The picture is too bright or too dark.	<ul style="list-style-type: none"> LCD BRIGHT is not adjusted properly. <ul style="list-style-type: none"> → Press + or - to obtain the brightness you want. (p. 15, 20)
A vertical band appears when shooting a very bright subject.	<ul style="list-style-type: none"> The camcorder is not malfunctioning.
The picture does not appear on the LCD screen or in the viewfinder.	<ul style="list-style-type: none"> Incorporated fluorescent tube is worn out. <ul style="list-style-type: none"> → Please contact your nearest Sony dealer.
The picture does not appear in the viewfinder.	<ul style="list-style-type: none"> The LCD panel is open. <ul style="list-style-type: none"> → Close the LCD panel.
The picture in the viewfinder does not disappear.	<ul style="list-style-type: none"> Sunlight or the incandescent lamp may prevent the viewfinder sensor from working correctly. This is not a malfunction.
An unknown picture is displayed in the viewfinder or on the LCD screen.	<ul style="list-style-type: none"> If 10 minutes elapse after you set the POWER switch to CAMERA without inserting a cassette, the camcorder automatically starts the demonstration or DEMO MODE is set to STBY/ON in the menu system. <ul style="list-style-type: none"> → Insert the cassette and the demonstration stops. You can deactivate the demonstration. (p. 92)
A display such as "C:□□:□□" appears on the LCD screen or in the viewfinder.	<ul style="list-style-type: none"> The self-diagnosis display function has activated. <ul style="list-style-type: none"> → Check the code and diagnosis the problem by referring to the code chart. (p. 83)
The picture is recorded in incorrect/unnatural color.	<ul style="list-style-type: none"> NIGHTSHOT is set to ON. <ul style="list-style-type: none"> → Set it to OFF (p. 30)

Trouble check

Others

Symptom	Cause and/or corrective actions
While editing using the DV connecting cable, recording picture cannot be monitored.	<ul style="list-style-type: none">• Remove the DV connecting cable, and connect it again.
The camcorder becomes warm.	<ul style="list-style-type: none">• If the power of the camcorder is on for a long time, it becomes warm, which is not malfunction.
The supplied Remote Commander does not work.	<ul style="list-style-type: none">• Something is blocking the infrared rays. → Remove the obstacle.• The battery is not inserted with the correct polarity. → Insert the battery with the correct polarity. (p. 89)• The batteries are dead. → Insert new ones. (p. 89)
No function works though the power is on.	<ul style="list-style-type: none">• Disconnect the connection plate on the battery pack or on the AC power adaptor, then reconnect it in about 1 minute. Turn the power on. If the functions still do not work, open the LCD panel and press the RESET button below the MENU button using a sharp-pointed object. (If you press the RESET button, all the settings including the date and time return to the default.) (p. 87)

AC power adaptor

Symptom	Corrective actions
The VTR/CAMERA or CHARGE lamp does not light.	<ul style="list-style-type: none">• Disconnect the power cord. After about 1 minute, reconnect the power cord. (p. 7)
The CHARGE lamp flashes.	<ul style="list-style-type: none">• See the chart on the next page.

Trouble check

When the CHARGE lamp flashes

Check through the following chart.

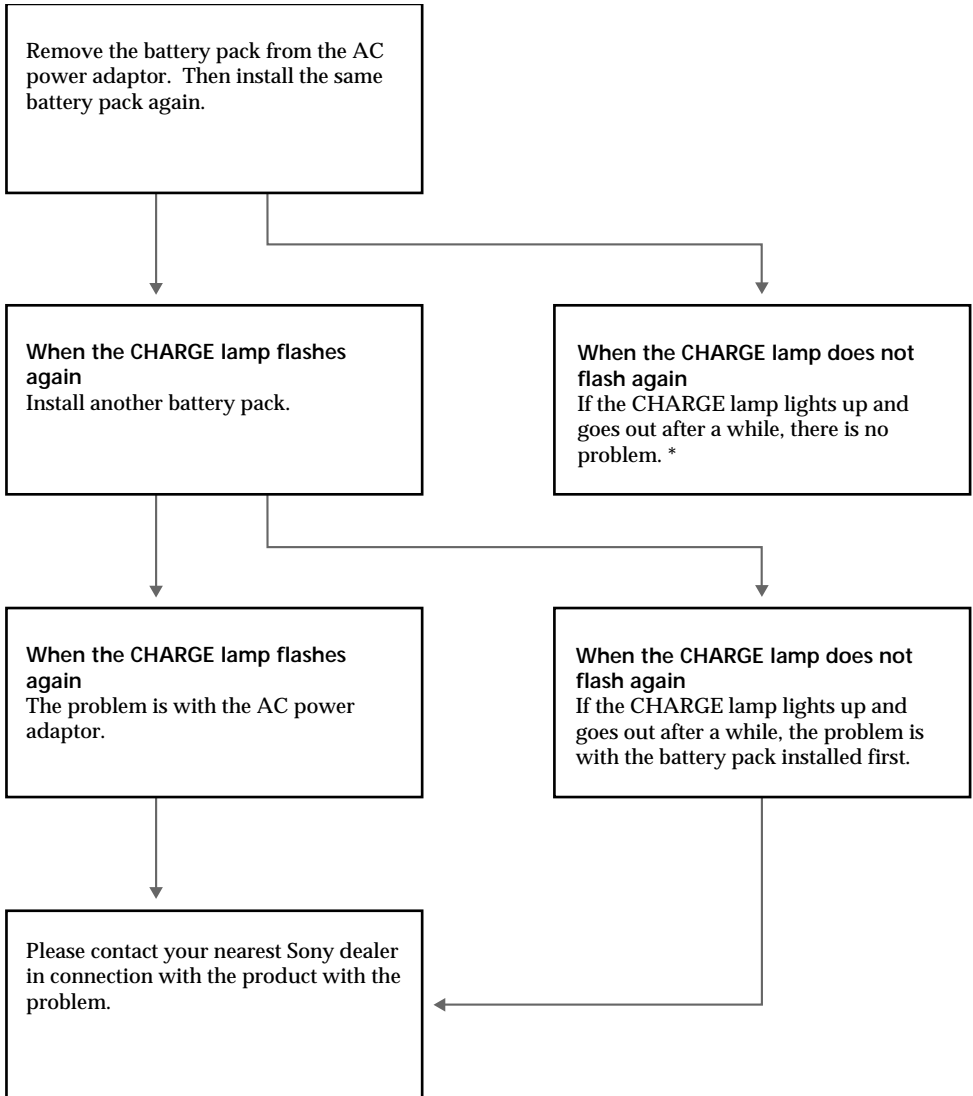

* If you use a battery pack which you have just bought or which has been left unused for a long time, the CHARGE lamp may flash at the first charging. This does not indicate a problem. Repeat again to charge with same battery pack.

Self-diagnosis function

The camcorder has a self-diagnosis display.

This function displays the camcorder's condition with five digits (a combination of a letter and figures) on the LCD screen or in the viewfinder. If this occurs, check the following code chart. The five-digit display informs you of the camcorder's current condition. The last two digits (indicated by □□) will differ depending on the state of the camcorder.

LCD screen/viewfinder

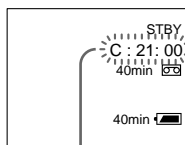

Self-diagnosis display

- C:□□:□□

You can service the camcorder yourself.

- E:□□:□□

Contact your Sony dealer or local authorized Sony facility.

Five-digit display	Cause and/or corrective actions
C:21:□□	<ul style="list-style-type: none"> • Moisture condensation has occurred. <ul style="list-style-type: none"> → Remove the cassette and leave the camcorder for at least 1 hour. (p. 74)
C:22:□□	<ul style="list-style-type: none"> • The video heads are dirty. <ul style="list-style-type: none"> → Clean the heads using the Sony DVM12CL cleaning cassette (not supplied). (p. 74)
C:31:□□	<ul style="list-style-type: none"> • A serviceable situation not malfunctioned above has occurred. <ul style="list-style-type: none"> → Remove the cassette and insert it again, then operate the camcorder. (p. 11) → Disconnect the power cord of the AC power adaptor or remove the battery pack. After reconnecting the power source, operate the camcorder.
C:32:□□	
E:61:□□	<ul style="list-style-type: none"> • A camcorder malfunction which you cannot service has occurred. <ul style="list-style-type: none"> → Contact your Sony dealer or local authorized Sony service facility and inform them of the five digits. (example: E:61:10)
E:62:□□	

If you are unable to resolve the problem, contact your Sony dealer or local authorized Sony service facility.

Specifications

Video camera recorder

System

Video recording system

Two rotary heads, Helical scanning system

Audio recording system

Rotary heads, PCM system

Quantization: 12bits (Fs 32kHz, stereo 1, stereo 2), 16bits (Fs 48kHz, stereo)

Video signal

NTSC color, EIA standards

Usable cassette

Mini DV cassette with logo printed

Tape speed

SP: Approx. 18.81 mm/s

LP: Approx. 12.56 mm/s

Recording/playback time

SP mode: 1 hour (DVM60)

LP mode: 1.5 hours (DVM60)

Fastforward/rewind time

Approx. 2 min. 30 s (DVM60)

Image device

CCD (Charge Coupled Device 1/4")

Viewfinder

Electric viewfinder (color)

Lens

Combined power zoom lens, 180x (Digital), 15x (Optical)

Focal distance

$f = 5/32$ to $2 1/2$ in. (3.4 to 51 mm)

($1 3/4$ to 26 in. (44 to 660 mm) when converted into a 35 mm still camera)

F 1.8 - 2.4

TTL autofocus system inner focus wide macro system

Color temperature

Auto

Minimum illumination

4 lux at F 1.8

0 lux when using NightShot

Illumination range

4 to 100,000 lux

Recommended illumination

More than 100 lux

LCD screen

Picture

3.5 inches measured diagonally

$2 7/8$ to 2 in. (72.4 x 50.4 mm)

On-screen display

TN LCD/TFT active matrix method

Total dot number

184,580 (839 x 220)

Input and output connectors

S video input/output

4-pin mini DIN

Luminance signal: 1 Vp-p, 75 ohms, unbalanced, sync negative

Chrominance signal: 0.286 Vp-p, 75 ohms, unbalanced

Audio/Video input/output

AV MINI JACK, 1 Vp-p, 75 ohms, unbalanced, sync negative 327 mV, (at output impedance more than 47 kilohms)

Output impedance with less than 2.2 kilohms/Stereo minijack (ϕ 3.5mm)

Input impedance more than 47 kilohms

DV input/output

4-pin special connector

Headphones

Stereo minijack (ϕ 3.5 mm)

MIC input

Stereo minijack (ϕ 3.5mm):0.388mV, DC2.5V

Input impedance 6.8 kilohms

LANC jack

Stereo minimini jack (ϕ 2.5 mm)

LASER LINK

Video/audio

IR space transmission system according to EIAJ (Electric Industries Association of Japan) standards

Audio carrier wave

Lch : 4.3MHz

Rch : 4.8MHz

General

Power requirements

7.2 W (battery insertion input)

Average power consumption

4.0 W during camera recording using viewfinder

5.0 W during camera recording using LCD screen

5.4 W during playback using

LASER LINK (when viewfinder is on and LCD is off)

Operating temperature

32°F to 104°F (0°C to 40°C)

Storage temperature

-4°F to 140°F (-20°C to 60°C)

Dimensions

Approx. $3 1/2$ x $4 1/8$ x $6 7/8$ in. (w/h/d) (87 x 104 x 173.2mm)

Mass

Approx. 1 lb 11 oz (780g) excluding the battery pack and the cassette

Approx. 1 lb 15 oz (860g) including the battery pack NP-F330, lithium battery and cassette DVM60

Approx. 1 lb 15 oz (890g) including the battery pack NP-F550, lithium battery and cassette DVM60

Approx. 2 lb 3 oz (1kg) including the battery pack NP-F730, lithium battery and cassette DVM60

Approx. 2 lb 3 oz (1kg) including the battery pack NP-F730H, lithium battery and cassette DVM60

Approx. 2 lb 3 oz (1kg) including the battery pack NP-F750, lithium battery and cassette DVM60

Approx. 2 lb 7 oz (1.1kg) including the battery pack NP-F950, lithium battery and cassette DVM60

Microphone

Electret condenser microphone,

Stereo type

Speaker

Dynamic-speaker

Supplied accessories

See page 6.

AC power adaptor

Power requirements*

110 to 240 V AC, 50/60 Hz

Power consumption

25 W

Output voltage

DC OUT: 8.4 V, 1.9 A in operating mode

Battery charge terminal: 8.4 V, 1.4 A in charge mode

Application

Sony battery pack NP-F330, NP-F530, NP-F550, NP-F730, NP-F730H, NP-F750, NP-F930, NP-F950 lithium ion type

Operating temperature

32°F to 104°F (0°C to 40°C)

Storage temperature

-4°F to 140°F (-20°C to 60°C)

Dimensions (Approx.)

$3 1/4$ x $1 13/16$ x $6 1/2$ in. (w/h/d) (81 x 45 x 163 mm)

Mass (Approx.)

7 oz (190 g)

* Canadian Standard Association (CSA) certifies 120V AC only.

Design and specifications are subject to change without notice.

Identifying the parts

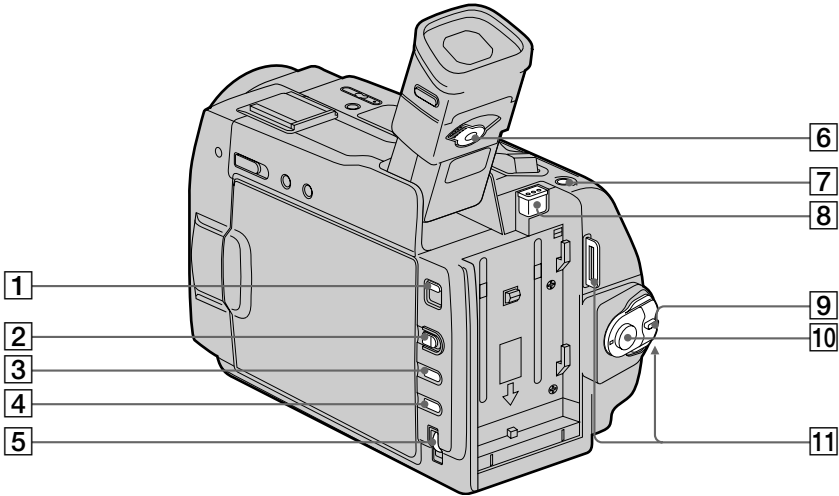

1 FOCUS switch (p. 37)

2 OPEN switch (p. 20)

3 PROGRAM AE button (p. 35)

4 EXPOSURE button (p. 40)

5 CONTROL dial (p. 24)

6 Viewfinder lens adjustment lever (p. 12)

7 • PHOTO button (p. 31)

8 ↓ BATT (battery release) button (p. 9)

9 POWER switch (p. 11, 20)

10 START/STOP button (p. 11)

11 Hooks for shoulder strap (p. 90)

Identifying the parts

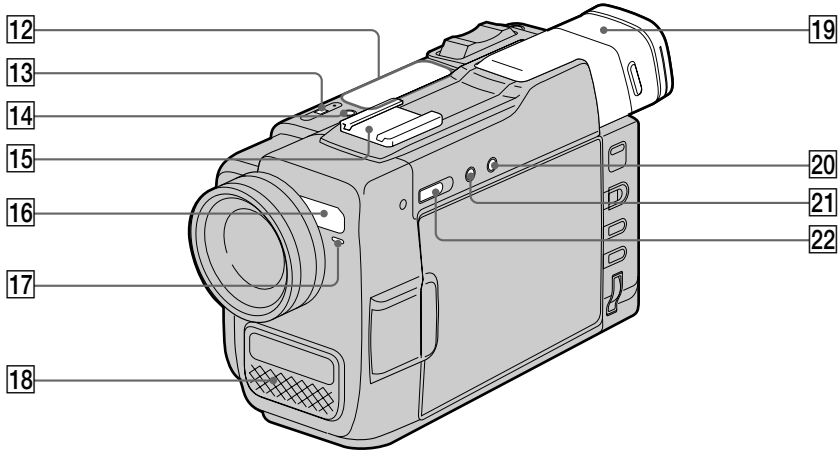

12 Tape transport buttons (p. 20)

- STOP (stop)
- ◀ REW (rewind)
- ▷ PLAY (playback)
- ▶▶ FF (fastforward)
- || PAUSE (pause)
- REC (record)

19 Viewfinder (p. 12)

20 BACK LIGHT button (p. 28)

21 FADER button (p. 29)

22 NIGHTSHOT switch (p. 30)

13 EDITSEARCH button (p. 19)

14 LASER LINK button (p. 51)

15 Intelligent accessory shoe

16 Remote sensor

17 Recording/battery lamp

18 Microphone

Note on the intelligent accessory shoe

Supplies power to optional accessories such as a video light or microphone. The intelligent accessory shoe is linked to the POWER switch, allowing you to turn on and off the power supplied by the shoe. Refer to the operating instruction of the accessory for further information. To connect an accessory, press down and push it to the end, and then tighten the screw. To remove an accessory, loosen the screw, and then press down and pull out the accessory.

Identifying the parts

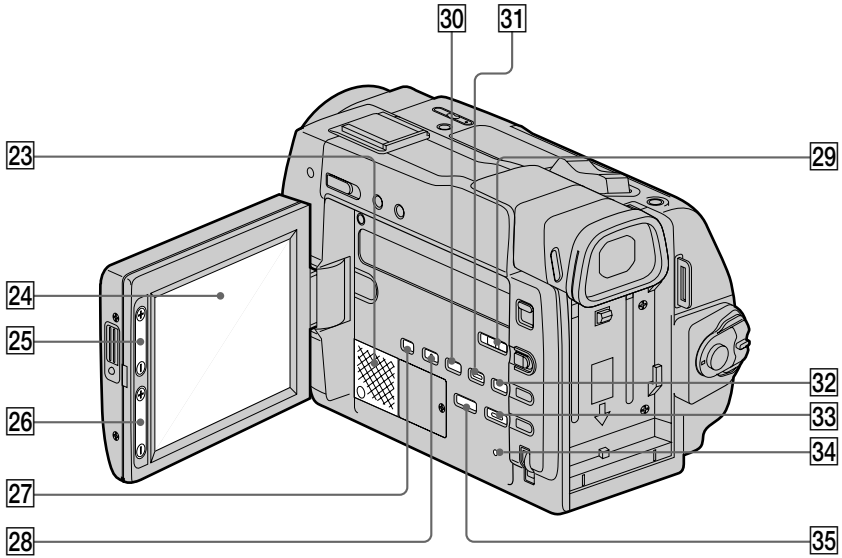

23 Speaker

24 LCD Screen (p. 15, 20)

25 LCD BRIGHT button (p. 15, 20)

26 VOL (volume) button (p. 20)

27 DATA CODE button (p. 60)

28 DISPLAY button (p. 20)

29 START/STOP MODE switch (p. 14)

30 16:9WIDE button (p. 33)

31 END SEARCH button (p. 19)

32 TITLE button (p. 41, 44)

33 MENU button (p. 24)



34 RESET button (p. 81)

35 PICTURE EFFECT button (p. 39)

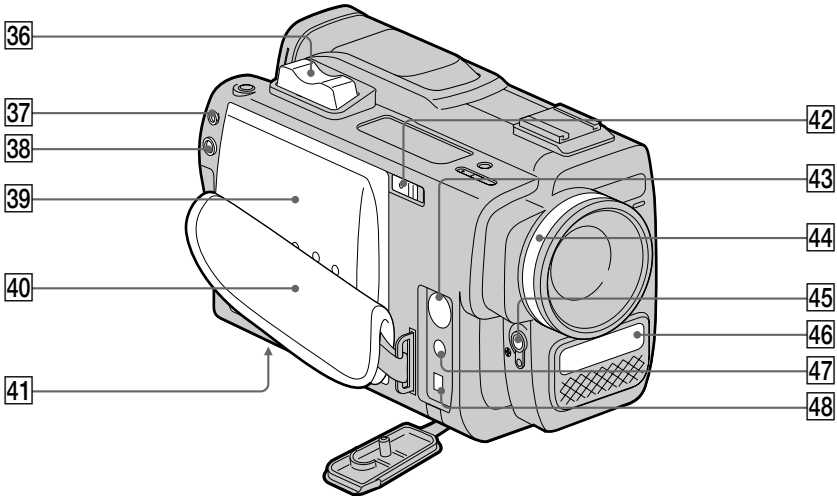
Identifying the parts



36 Power zoom switch (p. 13)

37 LANC  control jack
 stands for Local Application Control Bus System. The  control jack is used for controlling the tape transport of video equipment and peripherals connected to it. This jack has the same function as the jack indicated as CONTROL L or REMOTE.

38  headphones jack (p. 21)

39 Cassette lid (p. 10)

40 Grip strap (p. 17)

41 Tripod receptacle (p. 18)
Make sure that the length of the tripod screw is less than 9/32 inch (6.5 mm). Otherwise, you cannot attach the tripod securely and the screw may damage the camcorder.

42 EJECT switch (p. 10)

43 S VIDEO jack (p. 32, 50, 62)

44 Focus ring (p. 37)

45 MIC jack (PLUG IN POWER) (p. 65)
Connect an external microphone (not supplied). This jack also accepts a “plug-in-power” microphone.

46 Laser Link emitter (p. 51)
/NightShot Light emitter (p. 30)

47 AUDIO/VIDEO jack (p. 50, 62)

48 DV IN/OUT jack (p. 61)



This “i.LINK” mark is a trademark of Sony Corporation and indicates that this product is in agreement with IEEE 1394-1995 specifications and their revisions.

The DV IN/OUT jack is i.LINK compatible.

Identifying the parts

Remote Commander

The buttons that have the same name on the Remote Commander as on the camcorder function identically.

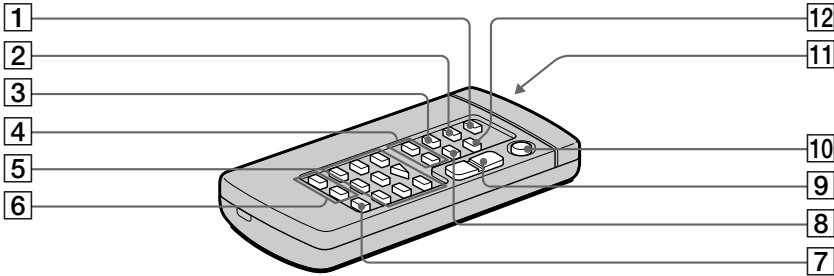

1 PHOTO button (p. 31)

2 DISPLAY button (p. 20)

3 SEARCH MODE button (p. 52, 55, 56)

4 ◀▶/▶▶ buttons (p. 52, 55, 56)

5 Tape transport buttons (p. 20)

6 REC button (p. 64)

7 AUDIO DUB button (p. 66)

8 DATA CODE button (p. 60)

9 Power zoom button (p. 13)

10 START/STOP button (p. 11)

11 Transmitter

Point toward the remote sensor to control the camcorder after turning on the camcorder.

12 ZERO SET MEMORY button (p. 59)

To prepare the Remote Commander

To use the Remote Commander, you must insert two size AA (R6) batteries. Use the supplied size AA (R6) batteries.

(1) Remove the battery cover from the Remote Commander.

(2) Insert both of the size AA (R6) batteries with correct polarity.

(3) Put the battery cover back onto the Remote Commander.

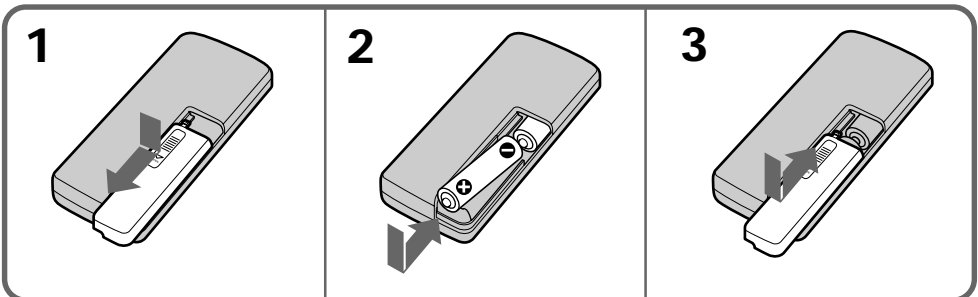

Identifying the Parts

Note on battery life

The batteries for the Remote Commander last about 6 months under normal operation. When the batteries become weak or dead, the Remote Commander does not work.

To avoid damage from possible battery leakage

Remove the batteries when you will not use the Remote Commander for a long time.

Remote control direction

Aim the Remote Commander to the remote sensor.

The operative range of the Remote Commander is about 16.4 feet (5 m) indoors. Depending on the angle, Remote Commander may not activate the camcorder.

Notes on the Remote Commander

- Keep the remote sensor away from strong light sources such as direct sunlight or illumination. Otherwise, the remote control may not be effective.
- Be sure that there is no obstacle between the remote sensor on the camcorder and the Remote Commander.
- This camcorder works in commander mode VTR 2. The commander modes (1,2 and 3) are used to distinguish this camcorder from other Sony VCRs to avoid remote control misoperation. If you use another Sony VCR in commander mode VTR 2, we recommend you change the commander mode or cover the remote sensor of the VCR with black paper.

Attaching the shoulder strap

Attach the supplied shoulder strap to the hooks for the shoulder strap.

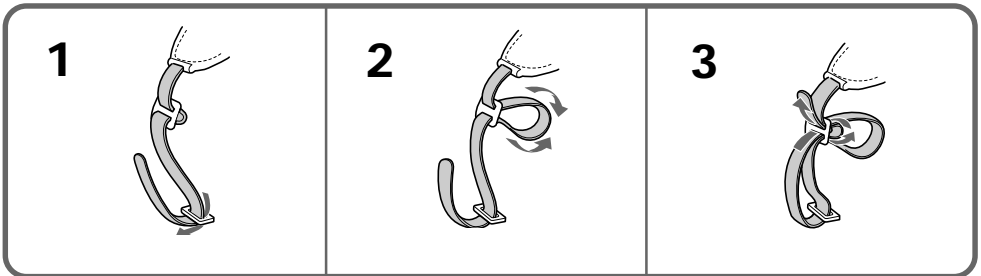

Operation indicators

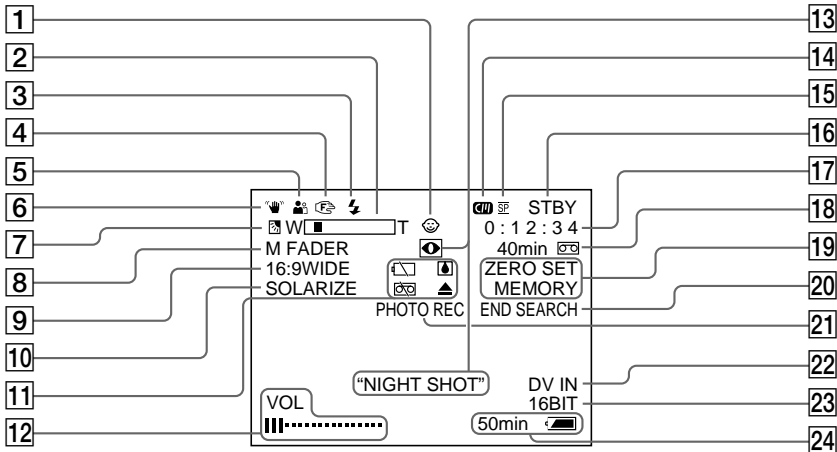

1 Mirror mode indicator (p. 16)

2 Zoom indicator (p. 13) /Exposure indicator (p. 40)

3 Video flash indicator

4 Manual focus/Infinity indicator (p. 37)

5 PROGRAM AE indicator (p. 34)

6 SteadyShot indicator (p. 49)

7 BACK LIGHT indicator (p. 28)

8 FADER indicator (p. 29)

9 16:9WIDE indicator (p. 33)

10 PICTURE EFFECT indicator (p. 38)

11 Warning indicators (p. 93)

12 BRT (bright) indicator (p. 15, 20)
/VOL (volume) indicator (p. 20)

13 NightShot indicators (p. 30)

14 Cassette Memory indicator (p. 4)

15 Recording mode indicator (p. 11)

16 Recording standby mode indicator (p. 11)
/Tape transport mode indicator

17 Time code indicator (p. 12) /Self diagnosis indicator (p. 83)

18 Remaining tape indicator (p. 13)

19 ZERO SET MEMORY indicator (p. 59)
/Photo capture indicator (p. 31)

20 END SEARCH indicator (p. 19)

21 PHOTO REC indicator (p. 31)

22 DV IN indicator (p. 61)

23 Audio mode indicator (p. 67)

24 Remaining battery indicator (p. 70)
/Remaining time in minutes indicator



To watch the demonstration

You can watch a brief demonstration of pictures with special effects. If the demonstration appears when you turn on the camcorder for the first time, exit the demo mode to use your camcorder.

To enter demo mode

- (1) Eject the cassette and set the POWER switch to VTR.
- (2) While holding down \triangleright , set the POWER switch to CAMERA. The demonstration starts. The demonstration stops when you insert the cassette. NIGHTSHOT should be set to ON to start demonstration.

Note that once you enter demo mode, this mode is retained as long as the vanadium rechargeable battery is in place. Therefore, demonstration starts automatically 10 minutes later every time you set the POWER switch to CAMERA, and after you eject the cassette.

To exit demo mode

- (1) Set the POWER switch to VTR.
- (2) While holding down \square , set the POWER switch to CAMERA.





Note on demo mode

When you set NIGHTSHOT to ON in the menu system, NIGHTSHOT indicator appears in the viewfinder or on the LCD screen. At this time, you cannot select DEMO MODE in the menu system.

Warning indicators

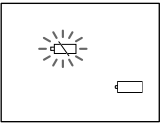
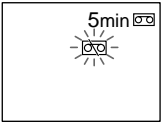
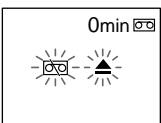
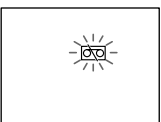
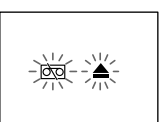
If indicators flash on the LCD screen or in the viewfinder or warning messages appear on the display window, check the following:

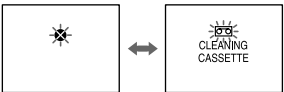
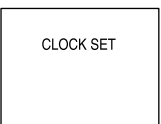
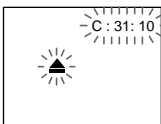
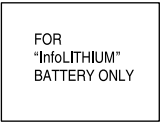
♪: You can hear the beep sound when BEEP is set to ON in the menu system.

<p>1</p> 	<p>2</p> 	<p>3</p> 
<p>4</p> 	<p>5</p> 	<p>6</p> 
<p>7</p> 	<p>8</p> 	<p>9</p> 
<p>10</p> 	<p>11</p> 	

- 1 The battery is weak or dead.
Slow flashing: The battery is weak.
Fast flashing: The battery is dead.
Depending on conditions, the  indicator may flash, even if there are 5 to 10 minutes remaining.
- 2 The tape is near the end.
The flashing is slow.
- 3 The tape has run out.
The flashing becomes rapid.
- 4 No tape has been inserted.
- 5 The tab on the tape is out (red).
- 6 Moisture condensation has occurred. (p. 74)
- 7 The video heads may be contaminated.
(p. 74)
- 8 The clock is not set.
When this message appears though you set the date and time, the vanadium-lithium battery is discharged. Charge the vanadium-lithium battery. (p. 69)
- 9 Some other trouble has occurred.
Use the self-diagnosis function (p. 83). If the display does not disappear contact your Sony dealer or local authorized Sony service facility.
- 10 The battery is not the "InfoLITHIUM" type.
- 11 The tape has no cassette memory. (p. 4)

Index

A, B

Audio mode	67
Battery release	9
BEEP	12

C

Car battery	23
Cassette memory	4
Charging battery pack	7
Charging vanadium-lithium battery	68
Cleaning video heads	74
Clock set	69
Color TV system	4, 77
Connection	50, 61
COPY INHIBIT	67

D, E

Data Code	60
Date search	52
Demo	92
DISPLAY	20
Digital zoom	13
DV connecting cable	61
DV format	50
DV IN/OUT	61
Editing	61
EJECT	10
END SEARCH	19
Exposure	40

F, G, H

Fade-in/fade-out	29
FADER	29
FOCUS	36
Full charge	7

I, J, K, L

InfoLITHIUM	72
LASER LINK	51
LCD BRIGHT	15, 20
LP mode	12
i.LINK	88

M, N

Manual focus	36
Menu system	24
Mirror mode	16
Moisture condensation	74
NIGHTSHOT	30
Normal charge	7

O, P, Q

PHOTO	31
Photo scan	56
Photo search	56
Playback on a TV	50
Playback pause	21
Power sources	23
Power zoom	13
PROGRAM AE	34

R

Remaining battery indicator	70
Remaining tape indicator	13
Remote Commander	89

S

Self-diagnosis function	83
SP mode	12
Standby mode	11
START/STOP MODE switch... ..	14
SteadyShot	49

T, U, V

Time code	12
Title (making)	44
Title (superimposition)	41
Title search	55
Tripod mounting	18
VOL (volume)	20

W, X, Y, Z

Wide TV mode	33
ZERO SET MEMORY	59
Zoom	13

