

SONY®

LCD Digital Colour TV

Operating Instructions

KDL-52W40xx	KDL-32W40xx	KDL-37V47xx
KDL-52W42xx	KDL-32W42xx	KDL-32V45xx
KDL-46W40xx	KDL-40E40xx	KDL-32V47xx
KDL-46W42xx	KDL-32E40xx	KDL-26V45xx
KDL-40W40xx	KDL-26E40xx	KDL-26V47xx
KDL-40W42xx	KDL-37V45xx	



329824312

3-298-243-12(2)

U

BRAVIA

© 2008 Sony Corporation

U

3-298-243-12(2)



 For useful information about Sony products
<http://www.sony-europe.com/myproduct/>

<http://www.sony.net/>

Printed in Spain

NOTICE FOR CUSTOMERS IN THE UNITED KINGDOM

A moulded plug complying with BS1363 is fitted to this equipment for your safety and convenience.

Should the fuse in the plug supplied need to be replaced, a 10 AMP fuse approved by ASTA or BSI to BS 1362 (i.e., marked with  or ) must be used.

When an alternative type of plug is used it should be fitted with a 10 AMP FUSE otherwise the circuit should be protected by a 10 AMP FUSE at the distribution board.

If the plug supplied with this equipment has a detachable fuse cover, be sure to attach the fuse cover after you change the fuse. Never use the plug without the fuse cover. If you should lose the fuse cover, please contact your nearest Sony service station.

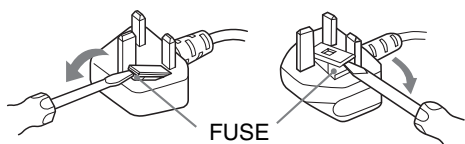

How to replace the fuse

Open the fuse compartment with a blade screwdriver, and replace the fuse.

Please refer to the illustration that actually equipped with the product.

Introduction

Thank you for choosing this Sony product.

Before operating the TV, please read this manual thoroughly and retain it for future reference

Disposal of the TV set



Disposal of Old Electrical & Electronic Equipment (Applicable in the European Union and other European countries with separate collection systems)

This symbol on the product or on its packaging indicates that this product shall not be treated as household waste. Instead it shall be handed over to the applicable collection point for the recycling of electrical and electronic

equipment. By ensuring this product is disposed of correctly, you will help prevent potential negative consequences for the environment and human health, which could otherwise be caused by inappropriate waste handling of this product. The recycling of materials will help to conserve natural resources. For more detailed information about recycling of this product, please contact your local Civic Office, your household waste disposal service or the shop where you purchased the product.



Disposal of waste batteries (applicable in the European Union and other European countries with separate collection systems)

This symbol on the battery or on the packaging indicates that the battery provided with this product shall not be treated as household waste. By ensuring these batteries are disposed of correctly, you will help prevent potentially

negative consequences for the environment and human health which could otherwise be caused by inappropriate waste handling of the battery. The recycling of the materials will help to conserve natural resources. In case of products that for safety, performance

or data integrity reasons require a permanent connection with an incorporated battery, this battery should be replaced by qualified service staff only. To ensure that the battery will be treated properly, hand over the product at end-of-life to the applicable collection point for the recycling of electrical and electronic equipment. For all other batteries, please view the section on how to remove the battery from the product safely. Hand the battery over to the applicable collection point for the recycling of waste batteries. For more detailed information about recycling of this product or battery, please contact your local Civic Office, your household waste disposal service or the shop where you purchased the product.

The manufacturer of this product is Sony Corporation, 1-7-1 Konan Minato-ku Tokyo, 108-0075 Japan. The Authorized Representative for EMC and product safety is Sony Deutschland GmbH, Hedelfinger Strasse 61, 70327 Stuttgart, Germany. For any service or guarantee matters please refer to the addresses given in separate service or guarantee documents.

Notice for Digital TV function

- Any functions related to Digital TV (**DVB**) will only work in countries or areas where DVB-T (MPEG2 and MPEG4 AVC) digital terrestrial signals are broadcast or where you have access to a compatible DVB-C (MPEG2 and MPEG4 AVC) cable service. Please confirm with your local dealer if you can receive a DVB-T signal where you live or ask your cable provider if their DVB-C cable service is suitable for integrated operation with this TV.
- The cable provider may charge an additional fee for such a service and you may be required to agree to their terms and conditions of business.
- Although this TV set follows DVB-T and DVB-C specifications, compatibility with future DVB-T digital terrestrial and DVB-C digital cable broadcasts cannot be guaranteed.
- Some Digital TV functions may not be available in some countries/regions and DVB-C cable may not operate correctly with all providers.
- For more information about DVB-C functionality please see our cable support site:
<http://support.sony-europe.com/TV/DVBC/>

Trademark information

- **DVB** is a registered trademark of the DVB Project
- Manufactured under license from BBE Sound, Inc. Licensed by BBE Sound, Inc. under one or more of the following US patents: 5510752, 5736897. BBE and BBE symbol are registered trademarks of BBE Sound, Inc.
- Manufactured under license from Dolby Laboratories. "Dolby" and the double-D symbol  are trademarks of Dolby Laboratories.
- HDMI, the HDMI logo and High-Definition Multimedia Interface are trademarks or registered trademarks of HDMI Licensing LLC.

BBE VIVA  **DOLBY**
HD3D Sound **DIGITAL • PLUS**

HDMI™  **DOLBY**
HIGH-DEFINITION MULTIMEDIA INTERFACE **VIRTUAL SURROUND**



- The illustrations used in this manual are of the KDL-40W4000 unless otherwise state.
- The "x" that appear on the model name, correspond to numeric digits related to colour variation.

Table of Contents

Start-up Guide

4

Checking the accessories	4
Safety information	9
Precautions	10
Overview of the remote	11
Overview of the TV buttons and indicators	12

Watching TV

Watching TV.....	13
Checking the Guide DVB	15
Using the Digital Favourite list DVB	16

Using Optional Equipment

Connecting optional equipment.....	17
Viewing pictures from connected equipment	18
Using BRAVIA Sync (Control for HDMI)	19

Using MENU Functions

Overview of the TV Home Menu (XMB™)	21
Settings	22
Picture	22
Sound	23
Features	24
Set-up	25
Analogue Set-up	28
Digital Set-up DVB	29
Photo	32
Picture Frame	32
USB Photo Viewer	32

Additional Information

Specifications	33
Troubleshooting	36

DVB : for digital channels only

 Before operating the TV, please read the "Safety information" section of this manual.
Retain this manual for future reference.

Start-up Guide

1: Checking the accessories

Mains lead (1) (only for KDL-52W4xxx, KDL-46W4xxx, KDL-40W4xxx, KDL-40E4xxx)

Remote RM-ED011 (1)

Remote RM-ED011 W (1) (only for KDL-40E4xxx, KDL-32E4xxx, KDL-26E4xxx)

Size AA batteries (R6 type) (2)

Stand (1) (except for KDL-52W4xxx, KDL-26E4xxx)

Screws for stand (4) (only for KDL-46W4xxx, KDL-40W4xxx, KDL-40E4xxx, KDL-37V4xxx)

Screws for stand (3) (only for KDL-32W4xxx, KDL-32E4xxx, KDL-32V4xxx, KDL-26V4xxx)

To insert batteries into the remote

Push and lift the cover to open.

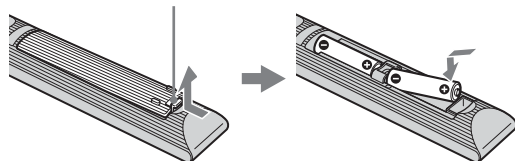

2: Attaching the stand (except for KDL-52W4xxx, KDL-26E4xxx)

- 1 Open the carton box and take out the stand and the screws.

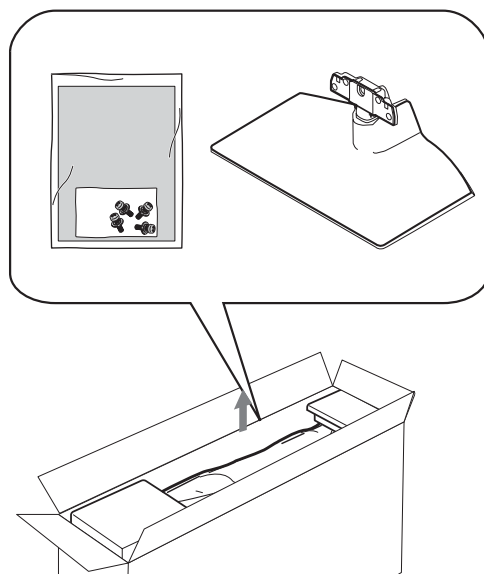

- 2 Place the TV set on the stand. Take care not to interfere with cables.

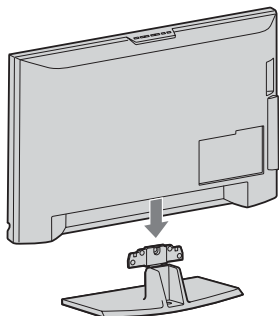

- 3 Fix the stand to the TV using the supplied screws.

KDL-46W4xxx
KDL-40W4xxx
KDL-40E4xxx
KDL-37V4xxx

KDL-32W4xxx
KDL-32E4xxx
KDL-32V4xxx
KDL-26V4xxx

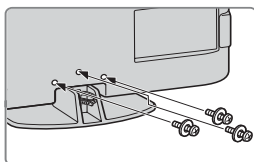
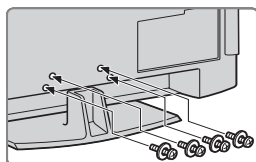

If using an electric screwdriver, set the tightening torque at approximately 1.5 N·m (15 kgf·cm)

3: Connecting an aerial/VCR/ DVD recorder

Connecting an aerial/cable

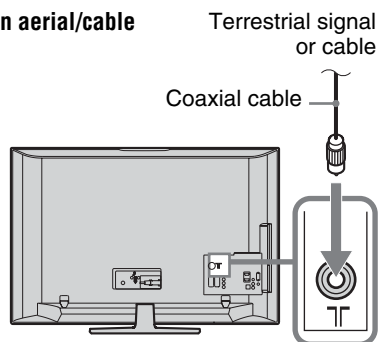

Connecting an aerial/ cable/ VCR/ DVD recorder

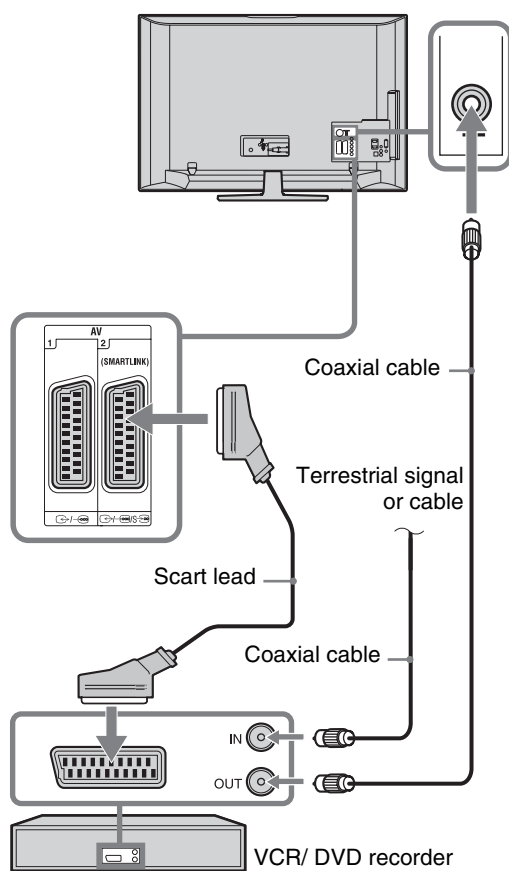

4: Preventing the TV from toppling over

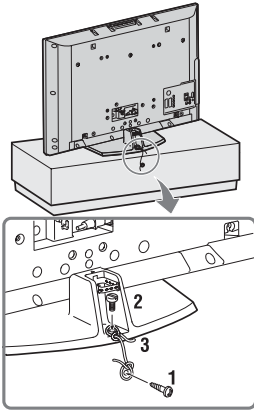

- 1 Install a wood screw (4 mm in diameter, not supplied) in the TV stand.
- 2 Install a machine screw (M6 x 12, not supplied) into the screw hole of the TV.
- 3 Tie the wood screw and the machine screw with a strong cord.

5: Connecting the cables

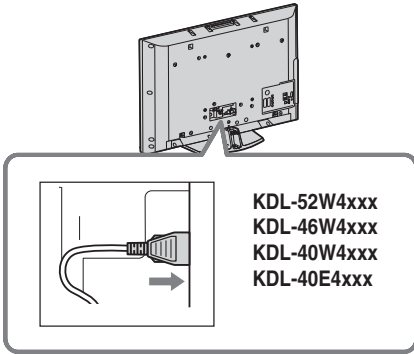

6: Bundling the cables

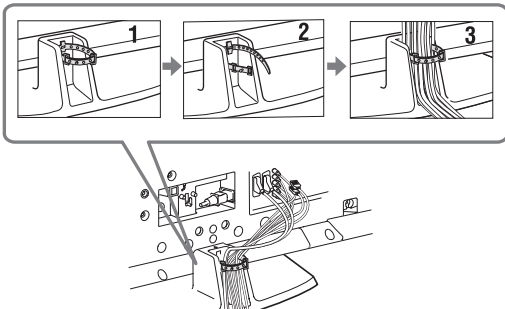

7: Performing the initial set-up

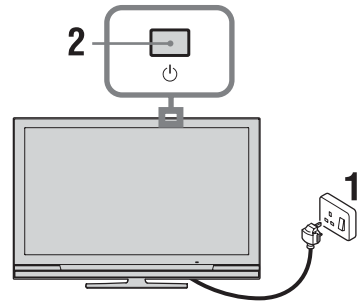

- 1 Connect the TV to your mains socket (220-240V AC, 50Hz).
- 2 Press on the TV. When you switch on the TV for the first time, the Language menu appears on the screen.
- 3 Press to select the language displayed on the menu screens, then press .

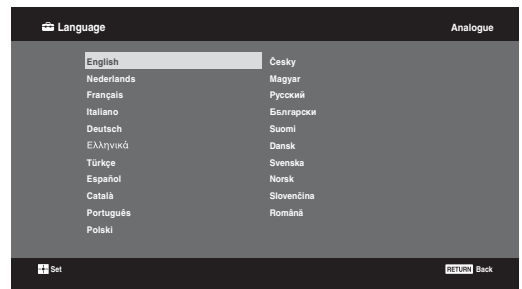

- 4 Press \uparrow/\downarrow to select the country/region in which you will operate the TV, then press \oplus .

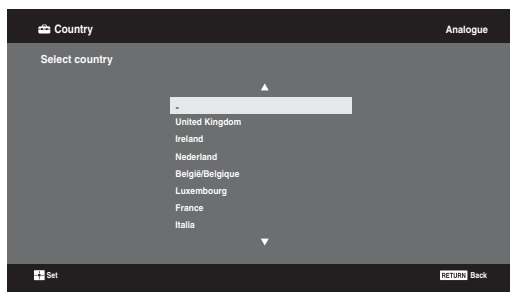

If the country/region in which you want to use the TV does not appear in the list, select “-” instead of a country/region.

- 5 Press \uparrow/\downarrow to select the location type in which you will operate the TV, then press \oplus .



Sony recommends you to select “Home” for power saving.



This option selects the initial picture mode appropriate for the typical lighting condition in these environments.

8: Auto-tuning the TV

- 1 Select OK then press \oplus .

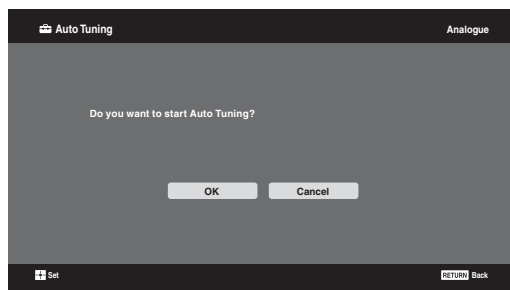

- 2 Press \uparrow/\downarrow to select “Antenna” or “Cable”, then press \oplus .

If you select “Cable”, the screen for selecting the scan type appears. See “To tune the TV for Cable connection” (page 8).

The TV starts searching for all available digital channels, followed by all available analogue channels. This may take some time, so do not press any buttons on the TV or remote while proceeding.

If a message appears for you to confirm the aerial connection

No digital or analogue channels were found. Check all the aerial/cable connection and then press \oplus to start auto-tuning again.

- 3 When the Programme Sorting menu appears on the screen, follow the steps of “Programme Sorting” (page 28).

If you do not change the order in which the analogue channels are stored on the TV, press

\leftarrow **RETURN** to go to step 4.

4

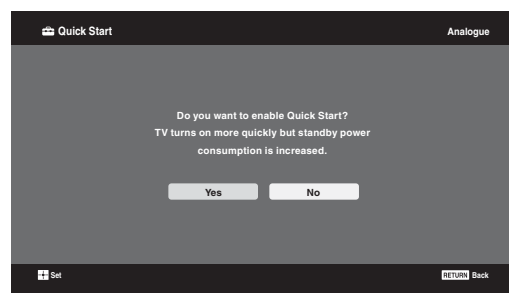

For details, see page 24.

5

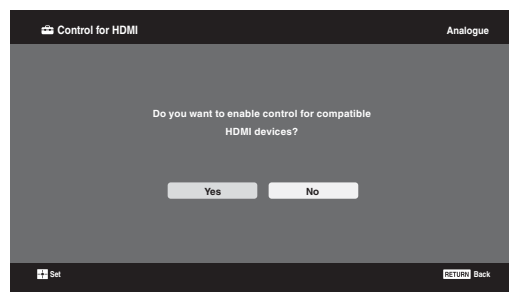

For details, see page 19.

- 6 Press \oplus .

The TV has now tuned in all the available channels.



When a digital broadcast channel cannot be received, or when selecting a region in which there are no digital broadcasts, the time must be set after performing step 3.

To tune the TV for Cable connection

- 1 Press ⊕.
- 2 Press ⬆/⬇ to select "Quick Scan" or "Full Scan", then press ⊕.
"Quick Scan" : channels are tuned according to the cable operator information within the broadcast signal.
Recommended setting for "Frequency", "Network ID" and "Symbol Rate" is "Auto".
This option is recommended for fast tuning when supported by your cable operator.
If the "Quick Scan" does not tune, please use the "Full Scan" method below.
"Full Scan" : All available channels are tuned and stored. This procedure may take some time.
This option is recommended when "Quick Scan" is not supported by your cable provider.
For further information about supported cable providers, refer to support web site:
<http://support.sony-europe.com/TV/DVBC/>

- 3 Press ⬇ to select "Start", then press ⊕.
The TV starts searching for channels. Do not press any buttons on the TV or remote.

 Some cable providers do not support "Quick Scan". If no channels are detected using "Quick Scan", perform "Full Scan".

Detaching the Table-Top Stand from the TV

 Do not remove the Table-Top Stand for any reason other than to wall-mount the TV.

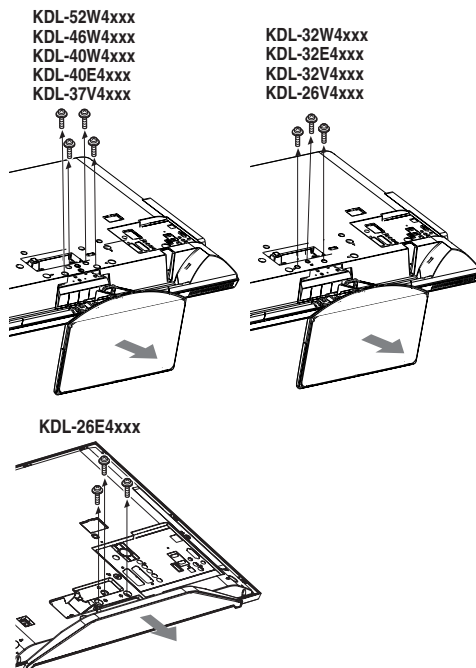

Safety information

Installation/Set-up

Install and use the TV set in accordance with the instructions below in order to avoid any risk of fire, electrical shock or damage and/or injuries.

Installation

- The TV set should be installed near an easily accessible mains socket.
- Place the TV set on a stable, level surface.
- Only qualified service personnel should carry out wall installations.
- For safety reasons, it is strongly recommended that you use Sony accessories, including:
 - **KDL-52W40xx/ KDL-52W42xx/ KDL-46W40xx/ KDL-46W42xx/ KDL-40W40xx/ KDL-40W42xx/ KDL-32W40xx/ KDL-32W42xx/ KDL-40E40xx/ KDL-32E40xx/ KDL-37V45xx/ KDL-37V47xx/ KDL-32V45xx/ KDL-32V47xx:** Wall-Mount Bracket SU-WL500.
 - **KDL-26V45xx/ KDL-26V47xx/ KDL-26E40xx:** Wall-mount Bracket SU-WL100.
 - **KDL-46W40xx/ KDL-46W42xx/ KDL-40W40xx/ KDL-40W42xx/ KDL-32W40xx/ KDL-32W42xx/ KDL-40E40xx/ KDL-32E40xx/ KDL-37V45xx/ KDL-37V47xx/ KDL-32V45xx/ KDL-32V47xx:** TV stand SU-FL300M.

- Be sure to use the screws supplied with the Wall-mount bracket when attaching the mounting hooks to the TV set. The supplied screws are designed so that they are 8 mm to 12 mm in length when measured from the attaching surface of the mounting hook.

The diameter and length of the screws differ depending on the Wall-mount bracket model.

Use of screws other than those supplied may result in internal damage to the TV set or cause it to fall, etc.

8 mm - 12 mm

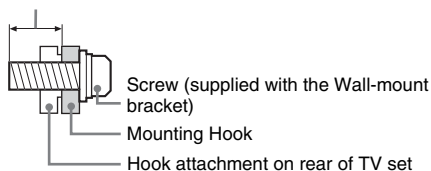

Transporting

- Before transporting the TV set, disconnect all cables.
- Two or three people are needed to transport a large TV set.
- When transporting the TV set by hand, hold it as shown on the right. Do not put stress on the LCD panel.
- When lifting or moving the TV set, hold it firmly from the bottom.
- When transporting the TV set, do not subject it to jolts or excessive vibration.
- When transporting the TV set for repair or when moving, pack it using the original carton and packing material.

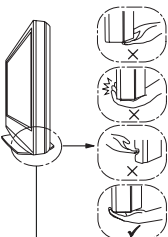
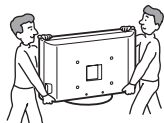

Be sure to hold the bottom of the panel, not the front part. Do not handle with dent area. Do not handle with the transparent bottom part.

Ventilation

- Never cover the ventilation holes or insert anything in the cabinet.
- Leave space around the TV set as shown below.
- It is strongly recommended that you use a Sony wall-mount bracket in order to provide adequate air-circulation.

Installed on the wall

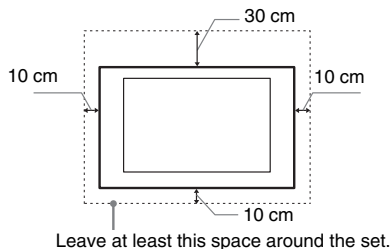

Installed with stand

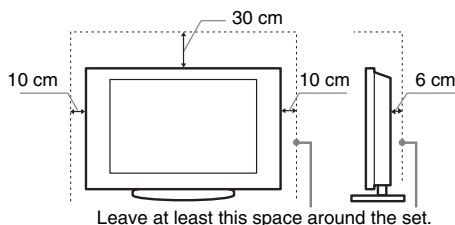

- To ensure proper ventilation and prevent the collection of dirt or dust:
 - Do not lay the TV set flat, install upside down, backwards, or sideways.
 - Do not place the TV set on a shelf, rug, bed or in a closet.
 - Do not cover the TV set with a cloth, such as curtains, or items such as newspapers, etc.
 - Do not install the TV set as shown below.

Air circulation is blocked.

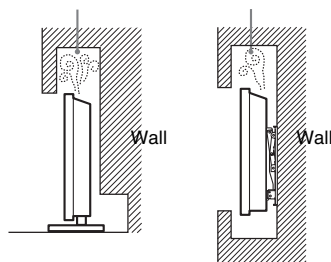

Mains lead

Handle the mains lead and socket as follows in order to avoid any risk of fire, electrical shock or damage and/or injuries:

- Use only mains leads supplied by Sony, not other suppliers.
- Insert the plug fully into the mains socket.
- Operate the TV set on a 220-240 V AC supply only.
- When wiring cables, be sure to unplug the mains lead for your safety and take care not to catch your feet on the cables.
- Disconnect the mains lead from the mains socket before working on or moving the TV set.
- Keep the mains lead away from heat sources.
- Unplug the mains plug and clean it regularly. If the plug is covered with dust and it picks up moisture, its insulation may deteriorate, which could result in a fire.

Continued

Notes

- Do not use the supplied mains lead on any other equipment.
- Do not pinch, bend, or twist the mains lead excessively. The core conductors may be exposed or broken.
- Do not modify the mains lead.
- Do not put anything heavy on the mains lead.
- Do not pull on the mains lead itself when disconnecting the mains lead.
- Do not connect too many appliances to the same mains socket.
- Do not use a poor fitting mains socket.

Prohibited Usage

Do not install/use the TV set in locations, environments or situations such as those listed below, or the TV set may malfunction and cause a fire, electrical shock, damage and/or injuries.

Location:

Outdoors (in direct sunlight), at the seashore, on a ship or other vessel, inside a vehicle, in medical institutions, unstable locations, near water, rain, moisture or smoke.

Environment:

Places that are hot, humid, or excessively dusty; where insects may enter; where it might be exposed to mechanical vibration, near flammable objects (candles, etc). The TV set shall not be exposed to dripping or splashing and no objects filled with liquids, such as vases, shall be placed on the TV.

Situation:

Do not use when your hands are wet, with the cabinet removed, or with attachments not recommended by the manufacturer. Disconnect the TV set from mains socket and aerial during lightning storms.

Broken pieces:

- Do not throw anything at the TV set. The screen glass may break by the impact and cause serious injury.
- If the surface of the TV set cracks, do not touch it until you have unplugged the mains lead. Otherwise electric shock may result.

When not in use

- If you will not be using the TV set for several days, the TV set should be disconnected from the mains for environmental and safety reasons.
- As the TV set is not disconnected from the mains when the TV set is just turned off, pull the plug from the mains to disconnect the TV set completely.
- However, some TV sets may have features that require the TV set to be left in standby to work correctly.

For children

- Do not allow children to climb on the TV set.
- Keep small accessories out of the reach of children, so that they are not mistakenly swallowed.

If the following problems occur...

Turn off the TV set and unplug the mains lead immediately if any of the following problems occur.

Ask your dealer or Sony service centre to have it checked by qualified service personnel.

When:

- Mains lead is damaged.
- Poor fitting of mains socket.
- TV set is damaged by being dropped, hit or having something thrown at it.
- Any liquid or solid object falls through openings in the cabinet.

Precautions

Viewing the TV

- View the TV in moderate light, as viewing the TV in poor light or during long period of time, strains your eyes.
- When using headphones, adjust the volume so as to avoid excessive levels, as hearing damage may result.

LCD Screen

- Although the LCD screen is made with high-precision technology and 99.99% or more of the pixels are effective, black dots may appear or bright points of light (red, blue, or green) may appear constantly on the LCD screen. This is a structural property of the LCD screen and is not a malfunction.
- Do not push or scratch the front filter, or place objects on top of this TV set. The image may be uneven or the LCD screen may be damaged.
- If this TV set is used in a cold place, a smear may occur in the picture or the picture may become dark. This does not indicate a failure. These phenomena disappear as the temperature rises.
- Ghosting may occur when still pictures are displayed continuously. It may disappear after a few moments.
- The screen and cabinet get warm when this TV set is in use. This is not a malfunction.
- The LCD screen contains a small amount of liquid crystal. Some fluorescent tubes used in this TV set also contain mercury. Follow your local ordinances and regulations for disposal.

Handling and cleaning the screen surface/cabinet of the TV set

Be sure to unplug the mains lead connected to the TV set from mains socket before cleaning.

To avoid material degradation or screen coating degradation, observe the following precautions.

- To remove dust from the screen surface/cabinet, wipe gently with a soft cloth. If dust is persistent, wipe with a soft cloth slightly moistened with a diluted mild detergent solution.
- Never use any type of abrasive pad, alkaline/acid cleaner, scouring powder, or volatile solvent, such as alcohol, benzene, thinner or insecticide. Using such materials or maintaining prolonged contact with rubber or vinyl materials may result in damage to the screen surface and cabinet material.
- When adjusting the angle of the TV set, move it slowly so as to prevent the TV set from moving or slipping off from its table stand.

Optional Equipment

Keep optional components or any equipment emitting electromagnetic radiation away from the TV set. Otherwise picture distortion and/or noisy sound may occur.

Batteries

- Observe the correct polarity when inserting batteries.
- Do not use different types of batteries together or mix old and new batteries.
- Dispose of batteries in an environmentally friendly way. Certain regions may regulate the disposal of batteries. Please consult your local authority.
- Handle the remote with care. Do not drop or step on it, or spill liquid of any kind onto it.
- Do not place the remote in a location near a heat source, a place subject to direct sunlight, or a damp room.

Overview of the remote

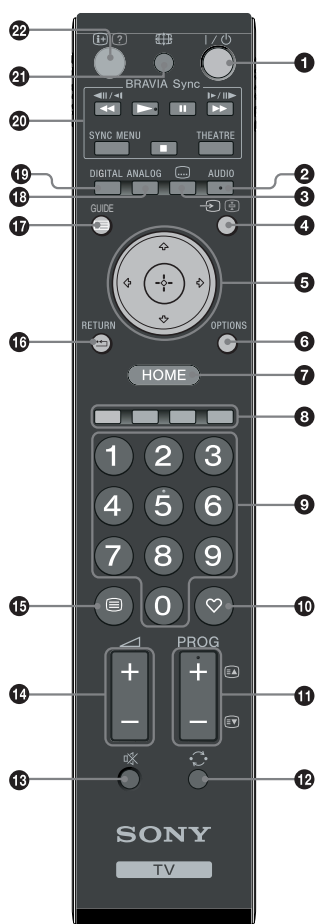

- 1** – **TV standby**
Turns the TV on and off from standby mode.
- 2** **AUDIO**
In analogue mode: Press to change the dual sound mode (page 24).
In digital mode: Press to select the audio language (page 30).
- 3** – **Subtitles**
Press to display the subtitles on current program if TV channels broadcast such information (in digital mode only) (page 30).
- 4** – **Input select / Text hold**
 - In TV mode: Selects the input source from equipment connected to the TV sockets (page 18).
 - In Text mode (page 14): Holds the current page.
- 5** – **Input select / Text hold**
- 6** **OPTIONS (page 14, 19)**
Enables you to access various viewing options and change/make adjustments according to the source and screen format.
- 7** **HOME (page 21)**
Displays the TV Home menu.
- 8** **Coloured buttons (page 14, 15, 16)**
- 9** **Number buttons**
 - In TV mode: Selects channels. For channel numbers 10 and above, enter the second and third digit quickly.
 - In Text mode: Enters the three digit page number to select the page.
- 10** – **Favourite (page 16)**
- 11** **PROG +/-/EA/ET**
 - In TV mode: Selects the next (+) or previous (-) channel.
 - In Text mode (page 14): Selects the next (EA) or previous (ET) page.
- 12** – **Previous channel**
Returns to the previous channel watched (for more than five seconds).
- 13** – **Mute the sound**
- 14** – **Volume**
- 15** – **Text (page 14)**
- 16** – **RETURN**
Returns to the previous screen of any displayed menu.
- 17** – **GUIDE (page 15)**
- 18** **ANALOG – Analogue mode (page 13)**
- 19** **DIGITAL – Digital mode (page 13)**
- 20** **BRAVIA Sync (page 19)**
- 21** – **Screen mode (page 14)**
- 22** – **Info / Text reveal**
 - In digital mode: Displays details of the programme currently being watched.
 - In analogue mode: Each time you press , the information on the screen changes as follows: Displays information such as current channel number and screen format → Time is displayed → Information is hidden.
 - In Text mode (page 14): Reveals hidden information (e.g. answers to a quiz).



The number 5, **PROG +**, **AUDIO** and **▶** buttons have tactile dots. Use the tactile dots as references when operating the TV.

Overview of the TV buttons and indicators

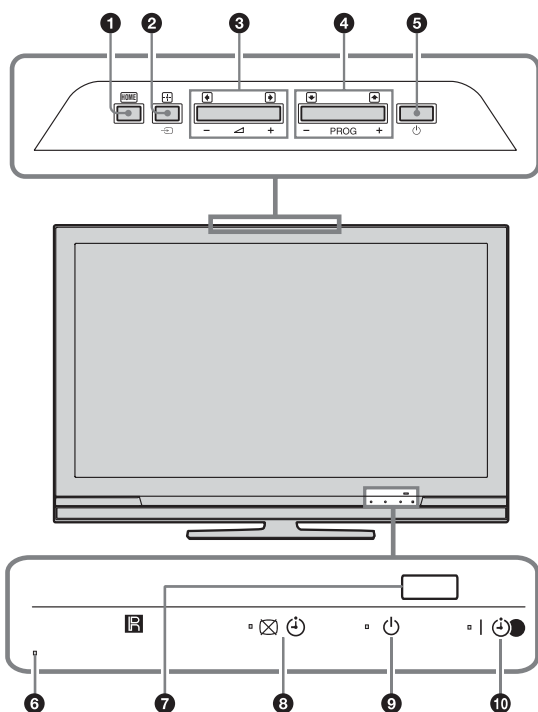

(only for KDL-40E4xxx, KDL-32E4xxx, KDL-26E4xxx)

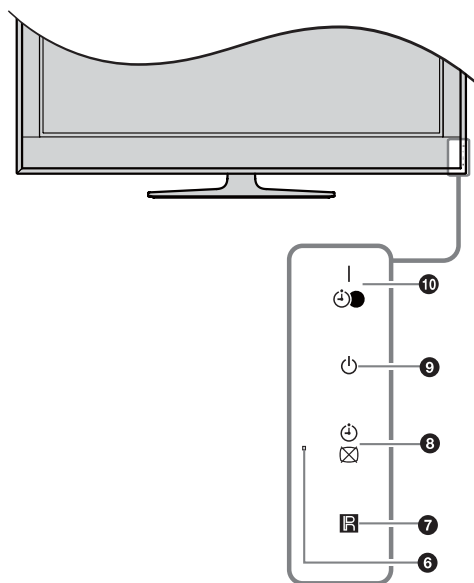

1 (page 21)

2 – Input select / OK

- In TV mode: Selects the input source from equipment connected to the TV sockets (page 18).
- In TV menu: Selects the menu or option, and confirms the setting.

3 +/- / /

- In TV mode: Increases (+) or decreases (-) the volume.
- In TV menu: Moves through the options right () or left ()

4 PROG +/- / /

- In TV mode: Selects the next (+) or previous (-) channel.
- In TV menu: Moves through the options up () or down ()

5 – Power

Turns the TV on or off.



To disconnect the TV completely, pull the plug from the mains.

6 Light Sensor

Do not put anything over the sensor, as its function may be affected.

7 Remote control sensor

- Receives IR signals from the remote.
- Do not put anything over the sensor, as its function may be affected.

8 Picture Off / Timer indicator

- Lights up in green when the picture is switched off (page 24).
- Lights up in orange when the timer is set (page 25).

9 Standby indicator

Lights up in red when the TV is in standby mode.

10 Power / Timer REC programme indicator



- Lights up in green when the TV is turned on.
- Lights up in orange when the timer recording is set (page 15).
- Lights up in red during the timer recording.

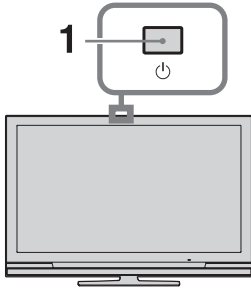

- Make sure that the TV is completely turned off before unplugging the mains lead. Unplugging the mains lead while the TV is turned on may cause the indicator to remain lit or may cause the TV to malfunction.
- Do not put anything over the indicators as their functions may be affected.

Watching TV













- 1** Press  on the TV to switch on the TV.
When the TV is in standby mode (the  (standby) indicator on the TV (front) is red), press  on the remote to switch on the TV.
- 2** Press **DIGITAL** to switch to digital mode or **ANALOG** to switch to analogue mode.
The channels available vary depending on the mode.



- 3** Press the number buttons or **PROG +/-** to select a TV channel.
To select channel numbers 10 and above using the number buttons, enter the second and third digits within two seconds.
To select a digital channel using the Guide, see page 15.

In digital mode

An information banner appears briefly. The following icons may be indicated on the banner.

- : Interactive service is available (MHEG Digital Text)
- : Interactive service (MHEG Digital Text) is currently disabled
- : Radio service
- : Scrambled/Subscription service
- : Multiple audio languages available
- : Subtitles available
- : Subtitles available for the hearing impaired
- : Recommended minimum age for current programme (from 4 to 18 years)
- : Parental Lock
- : Current programme is being recorded

Additional operations

To	Do this
Turn on the TV from Standby mode without sound	Press  . Press  to set the volume level.
Adjust the volume	Press  + (increase)/ - (decrease).

To access Digital Text

Many broadcasters provide a Digital Text service. Digital Text offers graphically rich contents, compared to Analogue Text.

Select a digital channel which provides Digital Text, then press **⊞**.

When a broadcaster provides a dedicated Digital Text channel, select this channel to access Digital Text.

To navigate through Digital Text, follow the instructions on the screen.

To exit Digital Text, press **↩ RETURN**.

To move around, press **⬅/➡/⬆/⬇**.

To select items, press **⊕** and the number buttons.

To access shortcuts, press the coloured buttons.

To access Analogue Text

In analogue mode, press **⊞**. Each time you press **⊞**, the display changes cyclically as follows:

Text → Text and TV picture → No Text (exit the Text service)

To select a page, press the number buttons or

PROG +/-.

To hold a page, press **⊞/⊕**.

To reveal hidden information, press **⊞/?**.



When four coloured items appear at the bottom of the Text page, you can access pages quickly and easily (Fast Text). Press the corresponding coloured button to access the page.

To change the screen format manually to suit the broadcast

Press **⊞** repeatedly to select the desired screen format.

Smart*

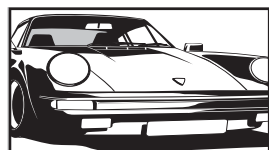

Displays conventional 4:3 broadcasts with an imitation wide screen effect. The 4:3 picture is stretched to fill the screen.

4:3

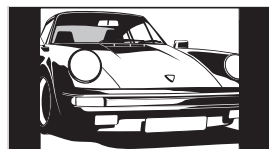

Displays conventional 4:3 broadcasts (e.g. non-wide screen TV) in the correct proportions.

Wide

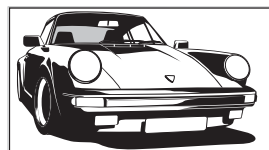

Displays wide screen (16:9) broadcasts in the correct proportions.

Zoom*

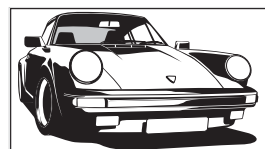

Displays cinemascopic (letter box format) broadcasts in the correct proportions.

14:9*

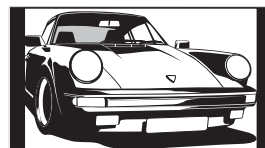

Displays 14:9 broadcasts in the correct proportions. As a result, black border areas are visible on the screen.

* Parts of the top and bottom of the picture may be cut off.



Some characters and/or letters at the top and the bottom of the picture may not be visible in Smart mode. In such a case, you can select "Vertical Size" using the "Screen Settings" (page 26) menu and adjust vertical size to make it visible.



- When "Auto Format" is set to "On", the TV will automatically select the best mode to suit the broadcast (page 26).
- You can adjust the position of the picture when selecting "Smart", "14:9" or "Zoom". Press **⬆/⬇** to move up or down (e.g. to read subtitles).

Using the Options menu

Press **OPTIONS** to display the following options when viewing a TV programme.

Options	Description
Picture Mode	See page 22.
Sound Effect	See page 23.
Speaker	See page 27.
Subtitle Setting (in digital mode only)	See page 30.
Sleep Timer	See page 25.
Power Saving	See page 24.
System Information (in digital mode only)	See page 31.

Checking the Guide DV3*

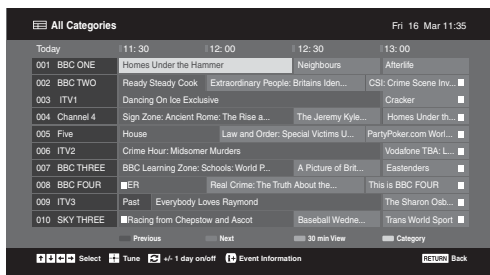

- 1 In digital mode, press **GUIDE**.
- 2 Perform the desired operation as shown in the following table or displayed on the screen.

* This function may not be available in some countries/regions.

To	Do this
Watch a programme	Press to select the programme, then press .
Turn off the Guide	Press GUIDE .
Sort the programme information by category – Category list	<ol style="list-style-type: none"> 1 Press the blue button. 2 Press to select a category, then press .
Set a programme to be recorded – Timer REC	<ol style="list-style-type: none"> 1 Press to select the future programme you want to record, then press . 2 Press to select “Timer REC”. 3 Press to set the TV and your VCR/DVD recorder timers. A symbol appears by that programme’s information. The indicator on the TV front panel lights up in orange. <p></p> <p>To record the programme you are currently watching, press .</p>
Set a programme to be displayed automatically on the screen when it starts – Reminder	<ol style="list-style-type: none"> 1 Press to select the future programme you want to display, then press . 2 Press to select “Reminder”, then press . <p>A symbol appears by that programme’s information. The indicator on the TV front panel lights up in orange.</p> <p></p> <p>If you switch the TV to standby mode, it will automatically turn itself on when the programme is about to start.</p>
Set the time and date of a programme you want to record – Manual timer REC	<ol style="list-style-type: none"> 1 Press to select the future programme you want to record, then press . 2 Press to select “Manual timer REC”, then press . 3 Press to select the date, then press . 4 Set the start and stop time in the same way as in step 3. 5 Press to select the programme, then press . 6 Press to set the TV and your VCR/ DVD recorder timers. A symbol appears by that programme’s information. The indicator on the TV front panel lights up in orange. <p></p> <p>To record the programme you are currently watching, press .</p>

Continued

To	Do this
Cancel a recording/reminder – Timer list	<ol style="list-style-type: none"> 1 Press ⏏/?. 2 Press ⬆/⬇ to select “Timer list”, then press ⊕. 3 Press ⬆/⬇ to select the programme you want to cancel, then press ⊕. 4 Press ⬆/⬇ to select “Cancel Timer”, then press ⊕. A display appears to confirm that you want to cancel the programme. 5 Press ⬅/➡ to select “Yes”, then press ⊕ to confirm.



- You can set the timer record function on the TV to automatically operate the recorder only when the connected recorder is compatible with SmartLink. However, this feature may not operate with certain types of recorder, even though it is stated that the recorder is SmartLink compatible. For details please refer to the instruction manual supplied with your recorder.
- Once a recording has begun, you can switch the TV to standby mode, but do not turn off the TV completely or the recording may be cancelled.
- If an age restriction for programmes has been selected, a message asking for a PIN Code will appear on the screen. For details, see “Parental Lock” (page 30).

Using the Digital Favourite list DV3*

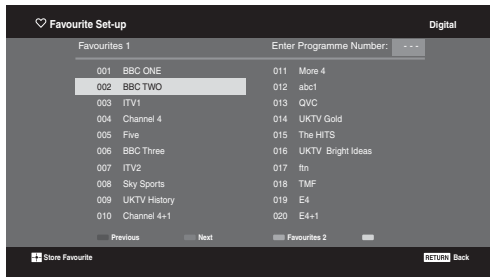

Digital Favourite list

* This function may not be available in some countries/regions.

- 1 In digital mode, press **♥**.
- 2 Perform the desired operation as shown in the following table or displayed on the screen.

To	Do this
Create your Favourite list for the first time	<ol style="list-style-type: none"> 1 Press ⬆/⬇/⬅/➡ to select the channel you want to add, then press ⊕. Channels that are stored in the Favourite list are indicated by a ♥ symbol. 2 Press yellow key to select “Favourites 2” or “Favourites 3”.
Watch a channel	<ol style="list-style-type: none"> 1 Press yellow key to navigate through favourite lists. 2 Press ⬆/⬇ to select the channel, then press ⊕.
Turn off the Favourite list	Press ⏏ RETURN .
Add or remove channels in the currently edited Favourite list	<ol style="list-style-type: none"> 1 Press the blue button. 2 Press the yellow button to choose the list you want to edit. 3 Press ⬆/⬇/⬅/➡ to select the channel you want to add or remove, then press ⊕.
Remove all channels from the current Favourite list	<ol style="list-style-type: none"> 1 Press the blue button. 2 Press the yellow button to select the favourite list you want to edit. 3 Press the blue button. 4 Press ⬅/➡ to select “Yes”, then press ⊕ to confirm.

Connecting optional equipment

You can connect a wide range of optional equipment to your TV. Connecting cables are not supplied.

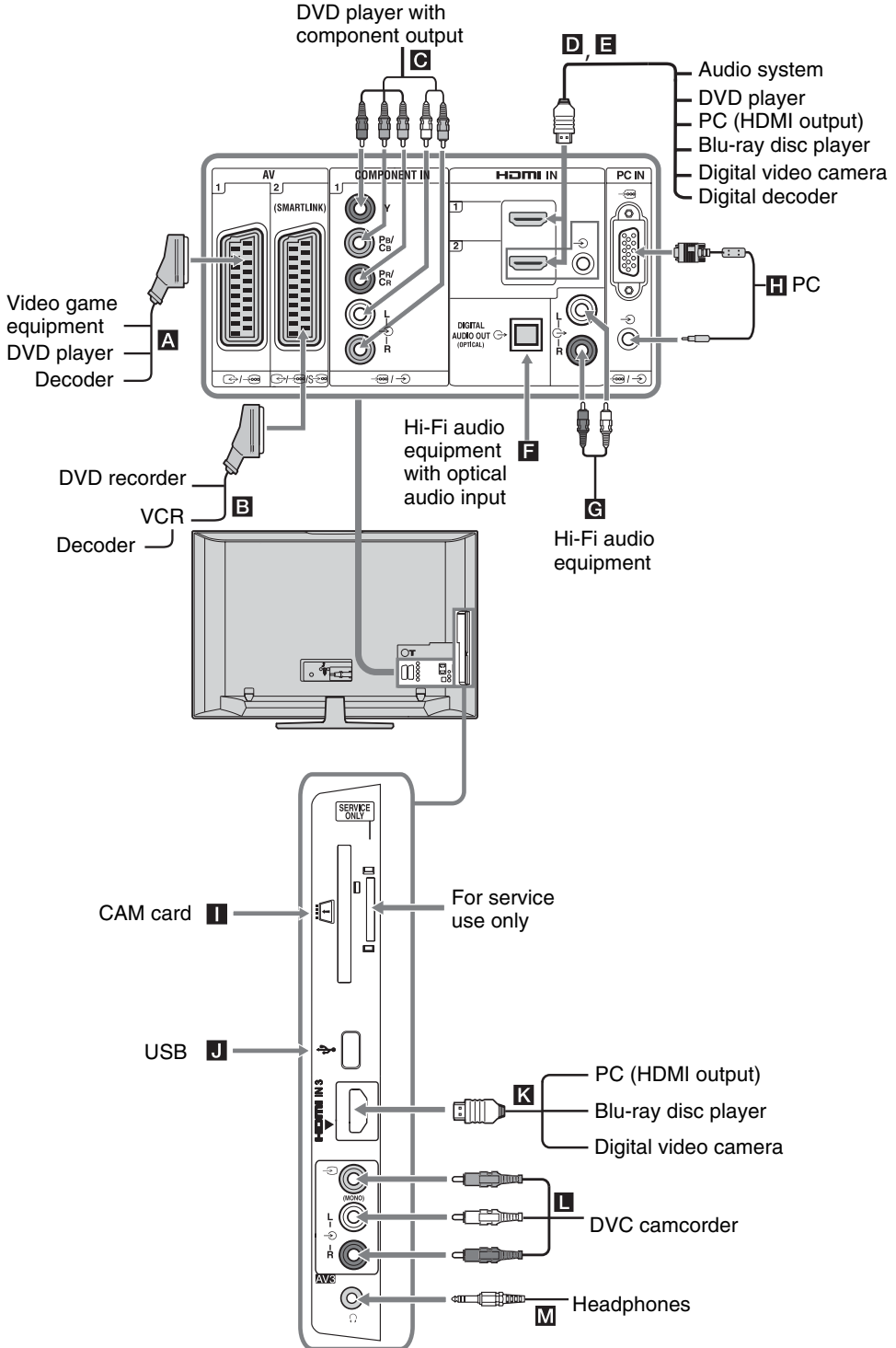

Viewing pictures from connected equipment

Switch on the connected equipment, then perform one of the following operation.

For equipment connected to the scart sockets using a fully-wired 21-pin scart lead

Start playback on the connected equipment. The picture from the connected equipment appears on the screen.

For an auto-tuned VCR/ DVD recorder

In analogue mode, press **PROG +/-**, or the number buttons, to select the video channel.

For other connected equipment

Press / to display a list of connected equipment. Press / to select the desired input source, then press .

The highlighted item is automatically selected if you do not perform any operation for two seconds after pressing .

If you have set an input source to "Skip" in the "AV Preset" menu (page 26), that input source does not appear in the list.



To return to normal TV mode, press **DIGITAL** or **ANALOG**.

Symbol on the screen	Description
AV1	To see the equipment connected to A .
AV2	To see the equipment connected to B . SmartLink is a direct link between the TV and a VCR/DVD recorder.
AV3	To see the equipment connected to L .
HDMI 1*	To see the equipment connected to D .
HDMI 2*	To see the equipment connected to E . If the equipment has a DVI socket, connect the DVI socket to the HDMI IN socket through a DVI-HDMI adaptor interface (not supplied), and connect the equipment's audio out socket to the audio in HDMI IN socket.

Symbol on the screen	Description
HDMI 3*	To see the equipment connected to K .

*

- Be sure to use only an authorized HDMI cable bearing the HDMI logo. We recommend that you use a Sony HDMI cable (high speed type).
- When "Control for HDMI" compatible equipment is connected, communication with the connected equipment is supported. Refer to page 19 to set up this communication.
- When connecting an audio system with HDMI socket, be sure to also connect to the HiFi socket.

Component	To see the equipment connected to C .
-----------	--

PC	To see the equipment connected to H . It is recommended to use a PC cable with ferrites, such as the "Connector, D-sub 15" (ref. 1-793-504-11, available in Sony Service Centre) or equivalent.
----	---

To connect Do this

Headphones **M** Connect to the socket to listen to sound from the TV on headphones.

Conditional Access Module (CAM) **I** Provides access to pay TV services. For details, refer to the instruction manual supplied with your CAM. To use the CAM, remove the "dummy" card from the CAM slot, then turn off the TV and insert your CAM card into the slot. When you are not using the CAM, we recommend that you keep the "dummy" card in the CAM slot.



CAM is not supported in all countries. Please check with your authorized dealer.

Hi-Fi audio equipment **G** Connect to the audio output sockets to listen to the sound from the TV on Hi-Fi audio equipment.

DIGITAL AUDIO OUT (OPTICAL) **F** Use an optical audio cable.

USB **J** Use USB memory to display photos.

Additional operations

To	Do this
Return to normal TV mode	Press DIGITAL or ANALOG .

Using the Options menu

Press **OPTIONS** to display the following options when viewing pictures from connected equipment.

Options	Description
Picture Mode (except PC input mode)	See page 22.
Display Mode (in PC input mode only)	See page 22.
Sound Effect	See page 23.
Speaker	See page 27.
PIP (in PC input mode only)	See page 19.
PAP (except PC input mode)	See page 19.
Auto Adjustment (in PC input mode only)	See page 26.
Horizontal Shift (in PC input mode only)	See page 26.
Sleep Timer (except PC input mode)	See page 25.
Power Saving	See page 24.

To view two pictures simultaneously – PAP (Picture and Picture)

You can view two pictures (external input and TV programme) on the screen simultaneously. Connect an optional equipment (page 17), and make sure that images from the equipment appear on the screen (page 18).



- This function is not available for a PC input source.
- You cannot change the size of the pictures.
- You cannot display analogue TV video in the TV programme picture while displaying AV1, AV2 or AV3 video in the external inputs picture.

1 Press **OPTIONS**.

2 Press \uparrow/\downarrow to select “PAP”, then press \oplus .
The picture from the connected equipment is displayed on the left, and the TV programme is displayed on the right.

3 Press the number buttons or **PROG +/-** to select the TV channel.

To return to single picture mode

Press \oplus or \leftarrow **RETURN**.



The picture framed in green is audible. You can switch the audible picture by pressing \leftrightarrow .

To view two pictures simultaneously – PIP (Picture in Picture)

You can view two pictures (PC input and TV programme) on the screen simultaneously. Connect a PC (page 17), and make sure that images from a PC appear on the screen.

1 Press **OPTIONS** to display the Options menu.

2 Press \uparrow/\downarrow to select “PIP”, then press \oplus .
The picture from the connected PC is displayed with full size and the TV programme is displayed on the right corner.
You can use $\uparrow/\downarrow/\leftarrow/\rightarrow$ to move the TV programme screen position.

3 Press number buttons or **PROG +/-** to select the TV channel.

To return to single picture mode

Press \leftarrow **RETURN**.



You can switch the audible picture by selecting “PC Sound/TV Sound” from the Options menu.

Using BRAVIA Sync (Control for HDMI)

The control for HDMI function enables the TV to communicate with the connected equipment that is compatible with the function, using HDMI CEC (Consumer Electronics Control). For example, by connecting Sony equipment that is compatible with control for HDMI (with HDMI cables), you can control them together.

Be sure to connect the equipment correctly, and make the necessary settings.

Control for HDMI

- Automatically turns the connected equipment off when you turn the TV off.
- Automatically turns the TV on and switches the input to the connected equipment when the equipment starts to play.
- If you turn on a connected audio system while the TV is on, the sound output switches from the TV speaker to the audio system.
- Adjusts the volume (\triangleleft +/-) and mutes the sound (\boxtimes) of a connected audio system.
- You can operate the connected Sony equipment that has the BRAVIA Sync logo by the TV remote by pressing:
 - $\blacktriangleright/\blacksquare/\blacksquare/\blacktriangleleft/\blacktriangleright$ to operate the connected equipment directly.

Continued

- **SYNC MENU** to display the menu of the connected HDMI equipment on the screen.
After displaying the menu, you can operate the menu screen by using $\leftarrow/\rightarrow/\uparrow/\downarrow$ and \odot .
- **OPTIONS** to display “Device Control”, then select options from “Menu”, “Options”, and “Content List” to operate the equipment.
- Refer to the instruction manual of the equipment for available control.

To connect the equipment that is compatible with control for HDMI

Connect the compatible equipment and the TV with a HDMI cable. When connecting an audio system, be sure to also connect the DIGITAL AUDIO OUT (OPTICAL) socket of the TV and the audio system using an optical audio cable. For details, see page 18.

To make the control for HDMI settings

The control for HDMI settings must be set on both the TV side and connected equipment side. See HDMI Set-up on page 27 for the TV side settings. For settings on the connected equipment, refer to the operating instructions for that equipment.

Buttons for using optional equipment

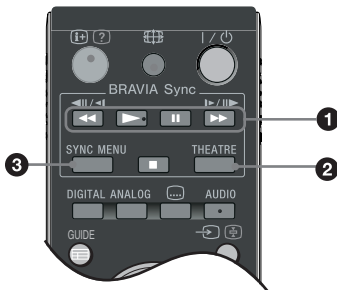

- 1** $\leftarrow/\rightarrow/\uparrow/\downarrow/\blacksquare$: You can operate the BRAVIA Sync-compatible equipment that is connected to the TV.
- 2** **THEATRE**
You can set Theatre Mode on or off. When Theatre Mode is set to on, the optimum audio output (if the TV is connected with an audio system using an HDMI cable) and picture quality for film-based contents are automatically set.

If you turn the TV off, Theatre Mode is also turned off.
- 3** **SYNC MENU**: Displays the menu of connected HDMI equipment. While viewing other input screens or TV programmes, “HDMI Device

Selection” is displayed when the button is pressed.



- Control for HDMI (BRAVIA Sync) is only available with the connected Sony equipment that has the BRAVIA Sync logo or is compatible with control for HDMI.
- Sony BRAVIA Theatre Sync Products and Control for HDMI compatible devices from other manufacturers may not support all functions.

Overview of the TV Home Menu (XMB™)

The XMB™ (XrossMediaBar) is a menu of BRAVIA features and input sources displayed on the TV screen. The XMB™ is an easy way to select programming and adjust settings on your BRAVIA TV. Press the **HOME** button on your remote control to access the XMB™.

1 Press **HOME**.

The TV Home menu appears on the screen.

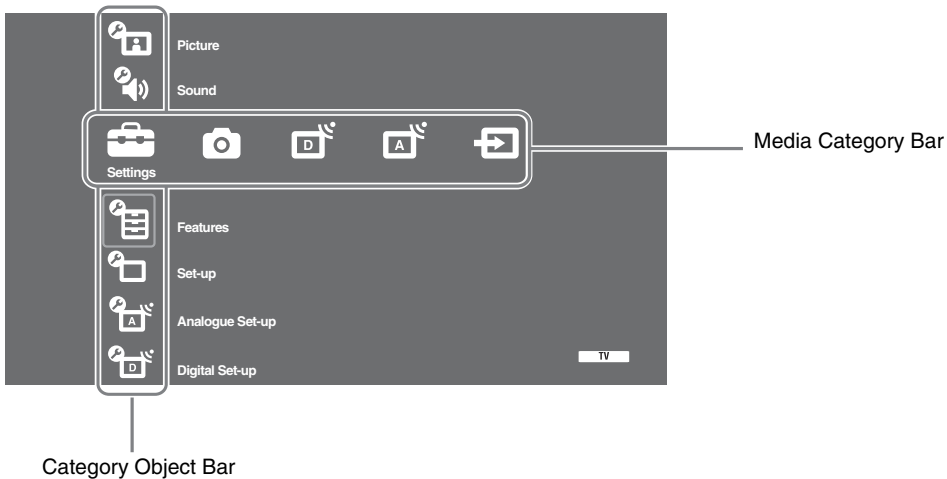

2 Press \leftarrow/\rightarrow to select the category.

Media category icon	Description
Settings	You can make advanced settings and adjustments. For details about settings, see page 22.
Photo	You can select “USB Photo Viewer” or “Picture Frame” (page 32).
Digital	You can select a digital channel, Favourite list (page 16), or Guide (page 15). You can also select a channel using the number buttons or PROG +/- .
Analogue	You can select an analogue channel. You can also select a channel using the number buttons or PROG +/- . To hide the list of analogue channels, set “Programme List Display” to “Off” (page 28).
External Inputs	You can select equipment connected to the TV. To assign a label to an external input, see “AV Preset” (page 26).

3 Press \uparrow/\downarrow to select the item, then press \oplus .

4 Follow the instructions on the screen.



5 Press **HOME** to exit.



- The options you can adjust vary depending on the situation.
- Unavailable options are greyed out or not displayed.

Settings

Picture



Picture Mode	<p>Selects the picture mode except for PC input source. The options for “Picture Mode” may differ depending on the “Video/Photo” setting (page 24).</p> <p>“Vivid”: (“Shop”, see page 7). For enhanced picture contrast and sharpness.</p> <p>“Standard”: (“Home”, see page 7). For standard picture. Recommended for home entertainment.</p> <p>“Cinema”: For viewing film-based content. Most suitable for viewing in a theatre-like environment. This picture setting was developed in collaboration with Sony Pictures Entertainment to faithfully reproduce movies as intended by their creators.</p> <p>“Photo”: Sets the optimum picture quality for photographs.</p>
Display Mode (only in PC mode/ PC Input/ HDMI PC Input)	<p>Selects the display mode for PC input source.</p> <p>“Video”: For video images.</p> <p>“Text”: For text, charts or tables.</p>
Reset	<p>Resets all picture settings except “Picture Mode” and “Display Mode” (only in PC mode) to the factory settings.</p>
Backlight	<p>Adjusts the brightness of the backlight.</p>
Contrast	<p>Increases or decreases picture contrast.</p>
Brightness	<p>Brightens or darkens the picture.</p>
Colour	<p>Increases or decreases colour intensity.</p>
Hue	<p>Increases or decreases the green and red tones.</p> <p></p> <p>“Hue” can only be adjusted for an NTSC colour signal (e.g., U.S.A. video tapes).</p>
Colour Temperature	<p>Adjusts the whiteness of the picture.</p> <p>“Cool”: Gives the white colours a blue tint.</p> <p>“Neutral”: Gives the white colours a neutral tint.</p> <p>“Warm 1/Warm 2”: Gives white colours a red tint. “Warm 2” gives a redder tint than “Warm 1”</p> <p></p> <p>“Warm 1 and Warm 2” are not available when “Picture Mode” is set to “Vivid”.</p>
Sharpness	<p>Sharpens or softens the picture.</p>
Noise Reduction	<p>Reduces the picture noise (snowy picture) in a weak broadcast signal.</p> <p>“Auto”: Automatically reduces the picture noise (in analogue mode only).</p> <p>“High/Medium/Low”: Modifies the effect of the noise reduction.</p> <p>“Off”: Turns off the “Noise Reduction” feature.</p> <p></p> <p>“Auto” is not available for AV1, AV2, AV3, HDMI 1, HDMI 2, HDMI 3, Component, PC and digital mode.</p>

MPEG Noise Reduction	Reduces the picture noise in MPEG-compressed video.
Advanced Settings	<p>Customizes the Picture function in more detail. When you set “Picture Mode” to “Cinema” or “Standard”, you can set/change these settings.</p> <p>“Adv. Contrast Enhancer”: Automatically adjusts “Backlight” and “Contrast” to the most suitable settings judging from the brightness of the screen. This setting is especially effective for dark images scenes. It will increase the contrast distinction of the darker picture scenes.</p> <p>“Live Colour”: Makes colours more vivid.</p> <p>“Colour Space” (except for KDL-32W4xxx, KDL-32E4xxx, KDL-26E4xxx, KDL-37V4xxx, KDL-32V4xxx, KDL-26V4xxx): Changes the colour reproduction gamut. “Wide” reproduces the vivid colour and “Standard” reproduces the standard colour.</p> <p></p> <ul style="list-style-type: none"> • “Live Colour” is not available when “Colour Space” is set to “Standard”. • “Advanced Settings” is not available when “Picture Mode” is set to “Vivid”.

“Noise Reduction”, “MPEG Noise Reduction” and “Advanced Settings” are not available for PC.



Sound

Sound Effect	<p>Selects the sound effect.</p> <p>“Dynamic”: Intensifies clarity and sound presence for better intelligibility and musical realism by using the “BBE High definition Sound System.”</p> <p>“Standard”: Enhances clarity, detail, and sound presence by using “BBE High definition Sound System.”</p> <p>“Clear Voice”: Makes voice sound clearer.</p> <p>“Dolby Virtual”: Uses the TV speakers to simulate the surround effect produced by a multi channel system.</p> <p>“BBE ViVA”: BBE ViVA Sound provides musically accurate natural 3D image with Hi-Fi sound. The clarity of the sound is improved by BBE while the width depth and height of sound image are expanded by BBE’s proprietary 3D sound process. BBE ViVA Sound is compatible with all TV programs including news, music, dramas, movies, sports and electronic games.</p> <p></p> <ul style="list-style-type: none"> • If you set “Auto Volume” to “On”, “Dolby Virtual” changes to “Standard”. • If headphones are connected, “Sound Effect” changes to “Off”.
Reset	Resets all the sound settings to the factory settings.
Treble	Adjusts higher-pitched sounds.
Bass	Adjusts lower-pitched sounds.
Balance	Emphasizes left or right speaker balance.
Auto Volume	<p>Keeps a constant volume level even when volume level gaps occur (e.g., adverts tend to be louder than programmes).</p> <p></p> <p>If you set “Sound Effect” to “Dolby Virtual”, “Auto Volume” changes to “Off”.</p>
Volume Offset	Adjusts the volume level of the current input relative to other inputs.

Continued

Dual Sound

Selects the sound from the speaker for a stereo or bilingual broadcast.

“Stereo/ Mono”: For a stereo broadcast.

“A/ B/ Mono”: For a bilingual broadcast, select “A” for sound channel 1, “B” for sound channel 2, or “Mono” for a mono channel, if available.



If you select other equipment connected to the TV, set “Dual Sound” to “Stereo”, “A” or “B”.



“Sound Effect”, “Treble”, “Bass”, “Balance” and “Auto Volume” are not available when “Speaker” is set to “Audio System”.



Features

Quick Start

The TV turns on faster than usual within two hours after switching to standby mode. However, power consumption in standby mode is higher than usual.

Power Saving

Selects the power saving mode to reduce the power consumption of the TV. When “Picture Off” is selected, the picture is switched off and the  (Picture Off) indicator on the TV front panel lights up in green. The sound remains unchanged.

“Standard Power”: Default settings.

“Reduced Power”: Reduces the power consumption of the TV.

“Picture Off”: Switches off the picture. You can listen to the sound with the picture off.

Light Sensor

“On”: Automatically optimises the picture settings according to the ambient light in the room.

“Off”: Turns off the “Light Sensor” feature.



Be sure not to put anything over the sensor, as its function may be affected. See page 12 for the location of the light sensor.

Logo Illumination (except for KDL-37V4xxx, KDL-32V4xxx, KDL-26V4xxx)

Lights up and turns off the Sony logo on the front of the TV.

Film Mode

Provides an improved picture quality which is optimized for film when playing DVD images taken on film and non progressive (interlaced).

“Auto”: Detects the picture contents (video or film) and optimizes the picture quality. Use this setting for standard use.

“Off”: Turns off the “Film Mode” feature.



- If the image contains irregular signals or too much noise, “Film Mode” will be automatically turned off even if “Auto” is selected.
- “Film Mode” is not available when “Video/ Photo” is set to “Photo” or when photograph is detected if “Video-A” is set.

Video/Photo

Provides suitable image quality by selecting the option depending on the input source (video or photograph data).

“Video-A”: Sets suitable image quality, depending on the input source, video data or photograph data when directly connecting Sony HDMI output-capable equipment that supports “Video-A” mode.

“Video”: Produces suitable image quality for moving pictures.

“Photo”: Produces suitable image quality for still images.



- The setting is fixed to “Video” when Video-A mode is not supported on the connected equipment, even if “Video-A” is selected.
 - Only available for HDMI 1, HDMI 2, HDMI 3 and Component in format 1080i or 1080p.
-



x.v.Colour (except for KDL-32W4xxx, KDL-32E4xxx, KDL-26E4xxx, KDL-37V4xxx, KDL-32V4xxx, KDL-26V4xxx)	<p>Displays moving pictures that is more faithful to the original source by matching the colour space of source.</p> <p></p> <ul style="list-style-type: none"> • The setting is fixed to “Normal” when the input signal is HDMI (RGB), even if “x.v.Colour” is selected. • Only available for HDMI 1, HDMI 2, HDMI 3 and Component in format 720p, 1080i or 1080p.
---	--

Photo Colour Space (except for KDL-32W4xxx, KDL-32E4xxx, KDL-26E4xxx, KDL-37V4xxx, KDL-32V4xxx, KDL-26V4xxx)	<p>Selects the option (sRGB, sYCC, Adobe RGB) to match the output colour space within the output signal from the equipment connected to the HDMI, component input jacks or USB.</p> <p></p> <ul style="list-style-type: none"> • Select “sYCC” when using the equipment that supports “x.v.Colour”. • Only available for HDMI 1, HDMI 2, HDMI 3 and Component in format 1080i or 1080p. • Not available when “Colour Space” is set to “Wide” (page 23).
---	---

Timer Settings	Sets the timer to turn on/off the TV.
-----------------------	---------------------------------------

Sleep Timer

Sets a period of time after which the TV automatically switches itself into standby mode. When the Sleep Timer is activated, the  (Timer) indicator on the TV (front) lights up in orange.



- If you switch off the TV and switch it on again, “Sleep Timer” is reset to “Off”.
- “Sleep timer will end soon. Power will be turned off” appears on the screen one minute before the TV switches to standby mode.

On Timer Settings

“**On Timer**”: Sets the timer to turn on the TV from standby mode.

“**Timer Mode**”: Selects the desired period.

“**Time**”: Sets the time to turn on the TV.

“**Duration**”: Selects the time period after which the TV automatically switches to standby mode again.

Clock Set

Allows you to adjust the clock manually. When the TV is receiving digital channels, the clock cannot be adjusted manually since it is set to the time code of the broadcasted signal.

Set-up

Auto Start-up	<p>Starts the “first time operation menu” to select the language, country/region and location, and tune in all available digital and analogue channels. Usually, you do not need to do this operation because the language and country/region will have been selected and channels already tuned when the TV was first installed (page 6). However, this option allows you to repeat the process (e.g., to retune the TV after moving house, or to search for new channels that have been launched by broadcasters).</p>
----------------------	--

Language	Selects the language in which the menus are displayed.
-----------------	--

Continued

Screen Settings

“Screen Format”: For details about the screen format, see “To change the screen format manually to suit the broadcast” on page 14.

“Auto Format”: Automatically changes the screen format according to the broadcast signal. To keep your setting, select “Off”.

“Display Area”: Adjusts the picture display area in 1080i/p and 720p sources when “Screen Format” is set to “Wide”.

- **“Auto”**: During digital broadcasts, displays pictures in accordance with the settings recommended by the broadcast station.
- **“Full Pixel”**: Displays pictures in their original size.
- **“Normal”**: Displays pictures in their recommended size.

“Horizontal Shift”: Adjusts the horizontal position of the picture.

“Vertical Shift”: Adjusts the vertical position of the picture when “Screen Format” is set to “Smart”, “Zoom” or “14:9”.

“Vertical Size”: Adjusts the vertical size of the picture when “Screen Format” is set to “Smart”.

PC Settings

“Screen Format”: Selects a screen format for displaying input from your PC.

- **“Full 1”**: Enlarges the picture to fill the vertical display area, keeping its original horizontal-to-vertical aspect ratio.
- **“Full 2”**: Enlarges the picture to fill the display area.

“Reset”: Resets the PC screen settings to the factory settings.

“Auto Adjustment”: Automatically adjusts the display position, phase and pitch of the picture when the TV receives an input signal from the connected PC.



“Auto Adjustment” may not work well with certain input signals. In such cases, manually adjust “Phase”, “Pitch” and “Horizontal Shift”.

“Phase”: Adjusts the phase when the screen flickers.



“Pitch”: Adjusts the pitch when the picture has unwanted vertical stripes.



“Horizontal Shift”: Adjusts the horizontal position of the picture.

“Power Management”: Switches the TV to standby mode if no signal is received for 30 seconds in the PC input.



AV Set-up

“AV Preset”: Assigns a name to any equipment connected to the side and rear sockets. The name will be displayed briefly on the screen when the equipment is selected. You can skip an input source that is not connected to any equipment.





1 Press / to select the desired input source, then press .

2 Press / to select the desired option below, then press .

- -, CABLE, SAT, VCR, DVD/BD, GAME, AUDIO SYSTEM, CAM, PC: Uses one of the preset labels to assign a name to connected equipment.
- “Edit:” : Creates your own label.



1 Press / to select the desired letter or number (“_” for a blank space), then press .



If you input a wrong character:

Press / to select the wrong character. Then, press / to select the correct character.







2 Repeat the procedure in step 1 until the name is completed.



3 Select “OK”, then press .

- “Skip”: Skips an input source that is not connected to any equipment when you press / to select the input source.

“AV2 Input”: Sets a signal to be input through the socket labelled  /  /  AV2 on the rear of the TV.

- **“Auto”**: Switches automatically among the signals of RGB input, S video input, Composite video input depending on the input signal.
 - **“RGB”**: Inputs the RGB signal.
 - **“S Video”**: Inputs the S Video signal.
 - **“Composite”**: Inputs the Composite video signal.
-

“AV2 Output”: Sets a signal to be output through the socket labelled  /  /  AV2 on the rear of the TV. If you connect a VCR/ DVD recorder or other recording equipment to the  /  /  AV2 socket, you can then record from the equipment connected to other sockets of the TV.

- **“TV”**: Outputs a broadcast.
- **“Auto”**: Outputs whatever is being viewed on the screen (except signals from the HDMI IN 1, HDMI IN 2, HDMI IN 3,  COMPONENT IN and  PC IN sockets).

“Speaker”: Turns on/off the TV’s internal speakers.

- **“TV Speaker”**: The TV speakers are turned on in order to listen to the TV’s sound through the TV speakers.
- **“Audio System”**: The TV speakers are turned off in order to listen to the TV’s sound only through your external audio equipment connected to the audio output sockets. When connected with “Control for HDMI” compatible equipment, you can turn the connected equipment on interlocked with the TV. This setting must be made after connecting the equipment.

“Audio Out”:

- **“Variable”**: The audio output from your audio system can be controlled by the TV’s remote.
- **“Fixed”**: The audio output of the TV is fixed. Use your audio receiver’s volume control to adjust the volume (and other audio settings) through your audio system.



“Audio Out” is not available for audio system connected to the TV using the HDMI sockets.

HDMI Set-up

This is used to set the “Control for HDMI” compatible equipment connected to the HDMI sockets. Note that the interlock setting must also be made on the connected “Control for HDMI” compatible equipment side.

“Control for HDMI”: This sets whether to interlock the “Control for HDMI” compatible equipment and the TV. When set to “On”, the following menu items can be performed. However, power consumption in standby mode is higher than usual.

“Auto Devices Off”: When this is set to “On”, the “Control for HDMI” compatible equipment turn on and off interlocked with the TV.

“Auto TV On”: When this is set to “On” and if the connected HDMI, control compatible equipment is turned on, the TV automatically turns on, and the displays the HDMI input from the connected equipment.

“Device List Update”: Creates or updates the “HDMI Device List”. Up to 14 “Control for HDMI” compatible equipment can be connected, and up to 4 equipment can be connected to a single socket. Be sure to update the “HDMI Device List” when you change the “Control for HDMI” compatible equipment connections or settings. Select them manually one by one until getting a correct picture for several seconds.

“HDMI Device List”: Displays the connected “Control for HDMI” compatible equipments.

Product Information

Displays your TV’s product information.

All Reset

Resets all settings to the factory settings and then displays the “Auto Start-up” screen.



- Be sure not to turn the TV off during this period (it takes about 30 seconds) or press any buttons.
- All settings, including Digital Favourite list, country/region, language, auto tuned channels, etc. will be reset.



Analogue Set-up

Programme List Display

Select “Off” to hide the list of analogue channels from the XMB™ (Xross Media Bar).

Auto Tuning

Tunes in all the available analogue channels. This option allows you to retune the TV after moving house, or to search for new channels that have been launched by broadcasters.

Programme Sorting

Changes the order in which the analogue channels are stored on the TV.

- 1 Press \uparrow/\downarrow to select the channel you want to move to a new position, then press \oplus .
- 2 Press \uparrow/\downarrow to select the new position for your channel, then press \oplus .

Manual Programme Preset

Before selecting “Label/AFT/Audio Filter/LNA/Skip/Decoder”, press **PROG +/-** to select the programme number with the channel. You cannot select a programme number that is set to “Skip” (page 26).

Programme/System/Channel

Presets programme channels manually.

- 1 Press \uparrow/\downarrow to select “Programme”, then press \oplus .
- 2 Press \uparrow/\downarrow to select the programme number you want to manually tune (if tuning a VCR/ DVD recorder, select channel 00), then press **RETURN**.
- 3 Press \uparrow/\downarrow to select “System”, then press \oplus .
- 4 Press \uparrow/\downarrow to select one of the following TV broadcast systems, then press **RETURN**.

B/G: For western European countries/regions

I: For the United Kingdom

D/K: For eastern European countries/regions

L: For France

- 5 Press \uparrow/\downarrow to select “Channel”, then press \oplus .
- 6 Press \uparrow/\downarrow to select “S” (for cable channels) or “C” (for terrestrial channels), then press \Rightarrow .
- 7 Tune the channels as follows:

If you do not know the channel number (frequency)

Press \uparrow/\downarrow to search for the next available channel. When a channel has been found, the search will stop. To continue searching, press \uparrow/\downarrow .

If you know the channel number (frequency)

Press the number buttons to enter the channel number of the broadcast you want or your VCR/ DVD recorder channel number.

- 8 Press \oplus to jump to “Confirm”, then press \oplus .
- 9 Press \downarrow to select “OK”, then press \oplus .

Repeat the procedure above to preset other channels manually.

Label

Assigns a name of your choice, up to five letters or numbers, to the selected channel. This name will be displayed briefly on the screen when the channel is selected.

To input characters, follow steps 1 to 3 of “Edit:” (page 26).

AFT

Allows you to fine-tune the selected programme number manually if you feel that a slight tuning adjustment will improve the picture quality.

You can adjust the fine tuning over a range of -15 to +15. When “On” is selected, the fine tuning is performed automatically.

Audio Filter

Improves the sound for individual channels in the case of distortion in mono broadcasts. Sometimes a non-standard broadcast signal can cause sound distortion or intermittent sound muting when watching mono programmes. If you do not experience any sound distortion, we recommend that you leave this option set to the factory setting “Off”.



You cannot receive stereo or dual sound when “Low” or “High” is selected.

LNA





Improves the picture quality for individual channels in the case of very weak broadcast signals (noisy picture).

If you cannot see any improvement in the picture quality even if you set to “On”, set this option to “Off” (factory setting).

Skip

Skips unused analogue channels when you press **PROG +/-** to select channels. (You can still select a skipped channel using the number buttons.)

Decoder

Shows and records the scrambled channel selected when using a decoder connected directly to scart connector  /  AV1, or to scart connector  /  /S- AV2 via a VCR/DVD recorder.



Depending on the country/region selected for “Country” (page 7), this option may not be available.

Confirm

Saves changes made to the “Manual Programme Preset” settings.



**Digital Set-up DVB****Digital Tuning****Digital Auto Tuning**

Tunes in the available digital channels.

This option allows you to retune the TV after moving house, or to search for new channels that have been launched by broadcasters). For details, see “Auto-tuning the TV” (page 7).

Programme Sorting



Removes any unwanted digital channels stored on the TV, and changes the order of the digital channels stored on the TV.

1 Press  /  to select the channel you want to remove or move to a new position.





Press the number buttons to enter the known three-digit programme number of the broadcast you want.

2 Remove or change the order of the digital channels as follows:

To remove the digital channel

Press . After a confirmation message appears, press  to select “Yes”, then press .

To change the order of the digital channels

Press , then press  /  to select the new position for the channel and press .

3 Press  **RETURN**.

Continued

Digital Manual Tuning

Tunes the digital channels manually. This feature is available when “Digital Auto Tuning” is set to “Antenna”.

- 1 Press the number button to select the channel number you want to manually tune, then press \uparrow/\downarrow to tune the channel.
- 2 When the available channels are found, press \uparrow/\downarrow to select the channel you want to store, then press \oplus .
- 3 Press \uparrow/\downarrow to select the programme number where you want to store the new channel, then press \oplus .

Repeat the above procedure to manually tune other channels.

Subtitle Set-up

“**Subtitle Setting**”: When “For Hard Of Hearing” is selected, some visual aids may also be displayed with the subtitles (if TV channels broadcast such information).

“**Subtitle Language**”: Selects which language subtitles are displayed in.

Audio Set-up

“**Audio Type**”: Switches to broadcast for the hearing impaired when “For Hard Of Hearing” is selected.

“**Audio Language**”: Selects the language used for a programme. Some digital channels may broadcast several audio languages for a programme.

“**Audio Description**”: Provides audio description (narration) of visual information if TV channels broadcast such information.

“**Mixing Level**”*: Adjusts the TV main audio and Audio Description output levels.

“**Dynamic Range**”: Compensates for differences in the audio level between different channels. Note that this function may have no effect for some channels.

“**Optical Out**”: Selects the audio signal that is output from the DIGITAL AUDIO OUT (OPTICAL) terminal on the rear of the TV. Set to “Auto” when equipment compatible with Dolby Digital is connected, and set to “PCM” when non-compatible equipment is connected.



*This option is only available when “Audio Description” is set to “On”.

Radio Display

The screen wallpaper is displayed when listening to a radio broadcast after 20 seconds without pressing any button.

You can select the screen wallpaper colour, display a random colour or view a slide show (page 32).

To cancel the screen wallpaper display temporarily, press any button.

Parental Lock

Sets an age restriction for programmes. Any programme that exceeds the age restriction can only be watched after a PIN Code is entered correctly.

- 1 Press the number buttons to enter your existing PIN Code.

If you have not previously set a PIN, a PIN Code entry screen appears. Follow the instructions of “PIN Code” below.

- 2 Press \uparrow/\downarrow to select the age restriction or “None” (for unrestricted watching), then press \oplus .

- 3 Press \leftarrow RETURN.
-

PIN Code

To set your PIN for the first time

- 1 Press the number buttons to enter the new PIN Code.

- 2 Press \leftarrow RETURN.

To change your PIN

- 1 Press the number buttons to enter your existing PIN Code.

- 2 Press the number buttons to enter the new PIN Code.

- 3 Press \leftarrow RETURN.



PIN Code 9999 is always accepted.

Technical Set-up

“Auto Service Update”: Enables the TV to detect and store new digital services as they become available.



For the service update to be able to take place the TV set should be left in stand-by mode from time to time.

“Software Download”: Enables the TV to automatically receive software updates free through your existing aerial/cable (when issued). It is recommended that this option be set to “On” at all times. If you do not want your software to be updated, set this option to “Off”.



For the software upgrade to be able to take place the TV set should be left in stand-by mode from time to time.

“System Information”: Displays the current software version and the signal level.



If signal bar is red (no signal) or amber (low signal), check the aerial/cable connection.

“Time Zone”: Allows you to manually select the time zone you are in, if it is not the same as the default time zone setting for your country/region.

“Auto DST”: Sets whether or not to automatically switch between summer time and winter time.

- **“On”:** Automatically switches between summer time and winter time according to the calendar.
- **“Off”:** The time is displayed according to the time difference set by “Time Zone”.

CA Module Set-up

Allows you to access a pay TV service once you obtain a Conditional Access Module (CAM) and a view card. See page 17 for the location of the  (PCMCIA) socket.

Photo

Picture Frame

Displays a fixed photograph on the screen for a selected period of time. After that period, the TV automatically switches itself into standby mode.

Using the Options menu

Press **OPTIONS** to display the following options.

Options	Description
Image selection	Press $\uparrow/\downarrow/\leftarrow/\rightarrow$ to select a photograph, then press \heartsuit to set.
Duration	Selects the desired period.



- If the photograph is selected from a USB device, it must remain connected to the TV.
- If “Sleep Timer” is activated, the TV automatically will switch into standby mode.
- Picture settings can be modified on the “USB Photo Viewer” Options menu.

USB Photo Viewer

You can view photographs (in JPEG format) stored in a Sony digital still camera, camcorder through a USB cable or USB storage media on your TV.

- 1 Connect a supported USB device to the TV.
- 2 Press **HOME**.
- 3 Press \leftarrow/\rightarrow to select “Photo”, then press \uparrow/\downarrow to select “USB Photo Viewer” and press \oplus .
The thumbnail screen appears.
- 4 Press $\uparrow/\downarrow/\leftarrow/\rightarrow$ to select the photograph or folder you want to view, then press \oplus .
- 5 Press \leftarrow **RETURN** to go back to thumbnail screen.

Additional operations

Press \leftarrow/\downarrow to select an option, then press \oplus .

Options	Description
Device Selection	Press \leftarrow/\rightarrow to select a device when multiple devices are connected. Bravia images are predefined device.

Options	Description
Slide Show	Displays the photographs one by one.
Set-up	You can make advanced settings for a slide show, and set the display sequence of the thumbnails.

Using the Options menu

Press **OPTIONS** to display the following options.

Options	Description
Picture Mode	See page 22.
Sleep Timer	See page 25.
Power Saving	See page 24.



Not available on thumbnail screen and “Slide Show” option.



- USB photo viewer supports DCF-compliant JPEG photographs only.
- When you connect a Sony digital still camera, set the camera’s USB connection mode to Auto or “Mass Storage”. For more information about USB connection mode, refer to the instructions supplied with your digital camera.
- USB Photo Viewer supports FAT32 file system only.
- While the TV is accessing the data on the recording media, observe the following:
 - Do not turn off the TV or connected USB device.
 - Do not disconnect the USB cable.
 - Do not remove the recording media.The data on the recording media may be damaged.
- Do not use unsupported USB device. This may cause malfunctions.
- Sony will not be held liable for any damage to, or loss of, data on the recording media due to a malfunction of any connected devices or the TV.
- Check the website below for updated information about compatible USB devices.
<http://support.sony-europe.com/TV/compatibility/>

Specifications

Display Unit

Power Requirements:

220–240 V AC, 50 Hz

Screen Size:

KDL-52xxxxx: 52 inches
 KDL-46xxxxx: 46 inches
 KDL-40xxxxx: 40 inches
 KDL-37xxxxx: 37 inches
 KDL-32xxxxx: 32 inches
 KDL-26xxxxx: 26 inches

Display Resolution:

1,920 dots (horizontal) x 1,080 lines (vertical) (Only for KDL-52W4xxx, KDL-46W4xxx, KDL-40W4xxx, KDL-32W4xxx, KDL-40E4xxx, KDL-32E4xxx)
 1,366 dots (horizontal) x 768 lines (vertical) (Only for KDL-37V4xxx, KDL-32V4xxx, KDL-26V4xxx, KDL-26E4xxx)

Power Consumption*:

KDL-52W4xxx:
 223 W (Home / Standard mode)
 253 W (Shop / Vivid mode)
 KDL-46W4xxx:
 225 W (Home / Standard mode)
 243 W (Shop / Vivid mode)
 KDL-40W4xxx, KDL-40E4xxx:
 176 W (Home / Standard mode)
 201 W (Shop / Vivid mode)
 KDL-37V4xxx:
 138 W (Home / Standard mode)
 155 W (Shop / Vivid mode)
 KDL-32E4xxx, KDL-32W4xxx:
 120 W (Home / Standard mode)
 143 W (Shop / Vivid mode)
 KDL-32V4xxx:
 111 W (Home / Standard mode)
 122 W (Shop / Vivid mode)
 KDL-26V4xxx, KDL-26E4xxx:
 88 W (Home / Standard mode)
 98 W (Shop / Vivid mode)

* For details about "Home mode" or "Shop mode" see page 7.

Standby Power Consumption*:

0.19 W or less
 * Specified standby power is reached after the TV finishes necessary internal processes.
 * When "Control for HDMI" is activated, standby power consumption is 0.6 W.
 * When "Quick Start" is activated, standby power consumption will remain at 16 W for two hours after switching to standby mode.

Dimensions (w x h x d):

KDL-52W4xxx:
 Approx: 126.2 x 87.1 x 34.7 cm (with stand)
 Approx: 126.2 x 82.9 x 11.9 cm (without stand)
 KDL-46W4xxx:
 Approx: 112.0 x 78.2 x 30.7 cm (with stand)
 Approx: 112.0 x 74.2 x 11.5 cm (without stand)
 KDL-40W4xxx:
 Approx: 98.6 x 68.4 x 27.9 cm (with stand)
 Approx: 98.6 x 64.6 x 11.0 cm (without stand)
 KDL-40E4xxx:
 Approx: 100.6 x 69.5 x 28.3 cm (with stand)
 Approx: 100.6 x 64.5 x 11.4 cm (without stand)
 KDL-37V4xxx:
 Approx: 92.0 x 64.9 x 27.9 cm (with stand)
 Approx: 92.0 x 61.0 x 11.0 cm (without stand)

KDL-32W4xxx, KDL-32V4xxx:

Approx: 79.4 x 57.7 x 24.2 cm (with stand)
 Approx: 79.4 x 54.0 x 9.9 cm (without stand)

KDL-32E4xxx:

Approx: 81.4 x 58.7 x 24.1 cm (with stand)
 Approx: 81.4 x 54.0 x 10.4 cm (without stand)

KDL-26V4xxx:

Approx: 65.9 x 50.5 x 24.2 cm (with stand)
 Approx: 65.9 x 46.6 x 9.5 cm (without stand)

KDL-26E4xxx:

Approx: 68.4 x 47.5 x 18.6 cm (with stand)
 Approx: 68.4 x 46.9 x 10.1 cm (without stand)

Mass:

KDL-52W4xxx:

Approx: 38.0 kg (with stand)
 Approx: 32.0 kg (without stand)

KDL-46W4xxx:

Approx: 29.0 kg (with stand)
 Approx: 25.0 kg (without stand)

KDL-40W4xxx:

Approx: 21.5 kg (with stand)
 Approx: 18.5 kg (without stand)

KDL-40E4xxx:

Approx: 22.0 kg (with stand)
 Approx: 19.0 kg (without stand)

KDL-37V4xxx:

Approx: 20.5 kg (with stand)
 Approx: 17.5 kg (without stand)

KDL-32W4xxx, KDL-32V4xxx, KDL-32E4xxx:

Approx: 15.5 kg (with stand)
 Approx: 13.0 kg (without stand)

KDL-26V4xxx, KDL-26E4xxx:

Approx: 12.5 kg (with stand)
 Approx: 10.0 kg (without stand)

Panel System

LCD (Liquid Crystal Display) Panel

TV System

Analogue: Depending on your country/region selection:
 B/G/H, D/K, L, I

Digital: DVB-T/DVB-C

Colour/Video System

Analogue: PAL, SECAM
 NTSC 3.58, 4.43 (only Video In)

Digital: MPEG-2 MP@ML/HL, H.264/MPEG-4 AVC
 HP@L4.0, MP@L3.0

Aerial

75 ohm external terminal for VHF/UHF

Channel Coverage

Analogue: VHF: E2–E12
 UHF: E21–E69
 CATV: S1–S20
 HYPER: S21–S41
 D/K: R1–R12, R21–R69
 L: F2–F10, B–Q, F21–F69
 I: UHF B21–B69

Digital: VHF/UHF

Terminals

 AV1

21-pin Scart connector (CENELEC standard) including audio/video input, RGB input and TV audio/video output.

 AV2 (SMARTLINK)

21-pin Scart connector (CENELEC standard) including audio/video input, RGB input, S Video input, selectable audio/video output, and SMARTLINK interface.

Continued

- AV3 Video input (phono jack)
- AV3 Audio input (phono jacks)
- Audio output (Left/Right) (phono jacks)
- COMPONENT IN
 - Supported formats: 1080/24p, 1080p, 1080i, 720p, 576p, 576i, 480p, 480i
 - Y: 1 Vp-p, 75 ohms, 0.3V negative sync
 - PB/CB: 0.7 Vp-p, 75 ohms
 - PR/CR: 0.7 Vp-p, 75 ohms
 - Audio input (phono jacks)
 - 500 mVrms
- HDMI IN 1, 2, 3
 - Video: 1080/24p, 1080p, 1080i, 720p, 576p, 576i, 480p, 480i
 - Audio: Two channel linear PCM
 - 32, 44.1 and 48 kHz, 16, 20 and 24 bits
 - PC (see table)
 - Analogue audio (minijack):
 - 500 mVrms
 - (HDMI IN 2 only)
- PC IN → PC Input (Dsub 15-pin)
 - G: 0.7 Vp-p, 75 ohms, non Sync on Green
 - B: 0.7 Vp-p, 75 ohms, non Sync on Green
 - R: 0.7 Vp-p, 75 ohms, non Sync on Green
 - HD: 1-5 Vp-p
 - VD: 1-5 Vp-p
 - PC audio input (minijack)
- Headphones jack
- CAM (Conditional Access Module) slot
- USB port
 - Supported formats: JPEG files based on DCF format.
- DIGITAL AUDIO OUT (OPTICAL) digital optical jack. Dolby digital or PCM audio from DVB depending on broadcasting, PCM audio from any other input source.
 - Audio output (phono jacks)

Audio Output

10 W + 10 W (RMS)

Optional Accessories

- **KDL-52W40xx/ KDL-52W42xx/ KDL-46W40xx/ KDL-46W42xx/ KDL-40W40xx/ KDL-40W42xx/ KDL-32W40xx/ KDL-32W42xx/ KDL-40E40xx/ KDL-32E40xx/ KDL-37V45xx/ KDL-37V47xx/ KDL-32V45xx/ KDL-32V47xx:**
Wall-Mount Bracket SU-WL500.
- **KDL-26V45xx/ KDL-26V47xx / KDL-26E40xx:**
Wall-mount Bracket SU-WL100.
- **KDL-46W40xx/ KDL-46W42xx/ KDL-40W40xx/ KDL-40W42xx/KDL-32W40xx/ KDL-32W42xx/ KDL-40E40xx/ KDL-32E40xx/ KDL-37V45xx/ KDL-37V47xx/ KDL-32V45xx/ KDL-32V47xx:**
TV stand SU-FL300M.

Design and specifications are subject to change without notice.

PC Input Signal Reference Chart for PC

Signals	Horizontal (Pixel)	Vertical (Line)	Horizontal frequency (kHz)	Vertical frequency (Hz)	Standard
VGA	640	480	31.5	60	VESA
	640	480	37.5	75	VESA
	720	400	31.5	70	VGA-T
SVGA	800	600	37.9	60	VESA Guidelines
	800	600	46.9	75	VESA
XGA	1024	768	48.4	60	VESA Guidelines
	1024	768	56.5	70	VESA
	1024	768	60.0	75	VESA
WXGA	1280	768	47.4	60	VESA
	1280	768	47.8	60	VESA
	1280	768	60.3	75	
	1360	768	47.7	60	VESA
SXGA	1280	1024	64.0	60	VESA

- This TV's PC input does not support Sync on Green or Composite Sync.
- This TV's PC input does not support interlaced signals.
- This TV's PC input supports signals in the above chart with a 60 Hz vertical frequency. For other signals, you will see the message "No signal".

PC Input Signal Reference Chart for HDMI IN 1, 2, 3

Signals	Horizontal (Pixel)	Vertical (Line)	Horizontal frequency (kHz)	Vertical frequency (Hz)	Standard
VGA	640	480	31.5	60	VESA
SVGA	800	600	37.9	60	VESA Guidelines
XGA	1024	768	48.4	60	VESA Guidelines
WXGA	1280	768	47.4	60	VESA
WXGA	1280	768	47.8	60	VESA
SXGA*	1280	1024	64.0	60	VESA
WXGA**	1360	768	47.7	60	VESA

* Only for KDL-52W4xxx, KDL-46W4xxx, KDL-40W4xxx, KDL-32W4xxx, KDL-40E4xxx, KDL-32E4xxx.



** Only for KDL-37V4xxx, KDL-32V4xxx, KDL-26V4xxx, KDL-26E4xxx.

Troubleshooting

Check whether the  (standby) indicator is flashing in red.

When it is flashing

The self-diagnosis function is activated.



- 1 Count how many  (standby) indicator flashes between each two second break.
For example, the indicator flashes three times, then there is a two second break, followed by another three flashes, etc.
- 2 Press  on the top edge of the TV to turn it off, disconnect the mains lead, and inform your dealer or Sony service centre of how the indicator flashes (number of flashes).

When it is not flashing

- 1 Check the items in the tables below.
- 2 If the problem still persists, have your TV serviced by qualified service personnel.

Picture

No picture (screen is dark) and no sound

- Check the aerial/cable connection.
- Connect the TV to the mains, and press  on the top edge of the TV.
- If the  (standby) indicator lights up in red, press **I**/.

No picture or no menu information from equipment connected to the scart connector

- Press  to display the connected equipment list, then select the desired input.
- Check the connection between the optional equipment and the TV.

Double images or ghosting (only in analogue mode)

- Check the aerial/cable connection.
- Check the aerial location and direction.

Only snow and noise appear on the screen (only in analogue mode)

- Check if the aerial is broken or bent.
- Check if the aerial has reached the end of its serviceable life (three to five years in normal use, one to two years at the seaside).

Picture or sound noise when viewing a TV channel (only in analogue mode)

- Adjust "AFT" (Automatic Fine Tuning) to obtain better picture reception (page 28).

Some tiny black points and/or bright points appear on the screen

- The picture of a display unit is composed of pixels. Tiny black points and/or bright points (pixels) on the screen do not indicate a malfunction.

No colour on programmes

- Select "Reset" (page 22).

No colour or irregular colour when viewing a signal from the COMPONENT IN sockets

- Check the connection of the  COMPONENT IN sockets and check if each socket is firmly seated in their respective sockets.



Picture freezes or contains blocks on the screen

- Check signal level (page 31). If signal bar is red (no signal) or amber (low signal), check the aerial/ cable connection.

- Remove the connected USB device. It can be damaged or not supported by the TV.
Check the website below for updated information about compatible USB devices:
<http://support.sony-europe.com/TV/compatibility/>

Sound

No sound, but good picture

- Press  +/- or  (Mute).
- Check if the "Speaker" is set to "TV Speaker" (page 27).
- When using HDMI input with Super Audio CD or DVD-Audio, DIGITAL AUDIO OUT (OPTICAL) may not output audio signals.

Channels

The desired channel cannot be selected

- Switch between digital and analogue mode and select the desired digital/analogue channel.

Some channels are blank

- Scrambled/Subscription only channel. Subscribe to the pay TV service.
- Channel is used only for data (no picture or sound).
- Contact the broadcaster for transmission details.

Digital channels are not displayed

- Contact a local installer to find out if digital transmissions are provided in your area.
- Upgrade to a higher gain aerial.

General

Distorted picture and/or sound

- Keep the TV away from electrical noise sources such as cars, motorcycles, hair-dryers or optical equipment.
- When installing optional equipment, leave some space between the optional equipment and the TV.
- Check the aerial/cable connection.
- Keep the aerial/cable TV cable away from other connecting cables.

The TV turns off automatically (the TV enters standby mode)

- Check if the "Sleep Timer" is activated, or confirm the "Duration" setting of "On Timer Settings" (page 25).
- If no signal is received and no operation is performed in the TV mode for 10 minutes, the TV automatically switches to standby mode.

The TV turns on automatically

- Check if the "On Timer" is activated (page 25).

Some input sources cannot be selected

- Select "AV Preset" and cancel "Skip" of the input source (page 26).

The remote does not function

- Replace the batteries.

A channel cannot be added to the Favourite list

- Up to 999 channels can be stored in the Favourite list.

HDMI equipment does not appear on "HDMI Device List"

- Check that your equipment is "Control for HDMI" compatible equipment.

Not all channels are tuned

- Check support web site for cable provide information.
<http://support.sony-europe.com/TV/DVBC/>

You cannot select "Off" in "Control for HDMI".

- If any "Control for HDMI" compatible audio equipment is connected to the TV, you cannot select "Off" in this menu. If you want to change the audio output to the TV speaker, select "TV Speaker" in the "Speaker" menu (page 27).