

SONY[®]



Operation Guide
NW-A1000 / A3000

About the Manuals

Included with the player are the Quick Start Guide and this PDF-format Operation Guide. Additionally, after installing CONNECT Player software from the supplied CD-ROM, you can refer to the Help within CONNECT Player.

- The Quick Start Guide explains set up and the basic operations, enabling you to import tracks into a computer, to transfer them to the player, and to play them back.
- This Operation Guide explains advanced features, enabling you to make full use of the player and troubleshoot problems.
- The CONNECT Player Help explains details about using CONNECT Player software (🔍 page 3).

Browsing the Operation Guide

To use the buttons in the Operation Guide

Click the buttons located in the upper right of this manual to jump to “Table of Contents,” “Player HOME Menu Reference,” or “Index.”

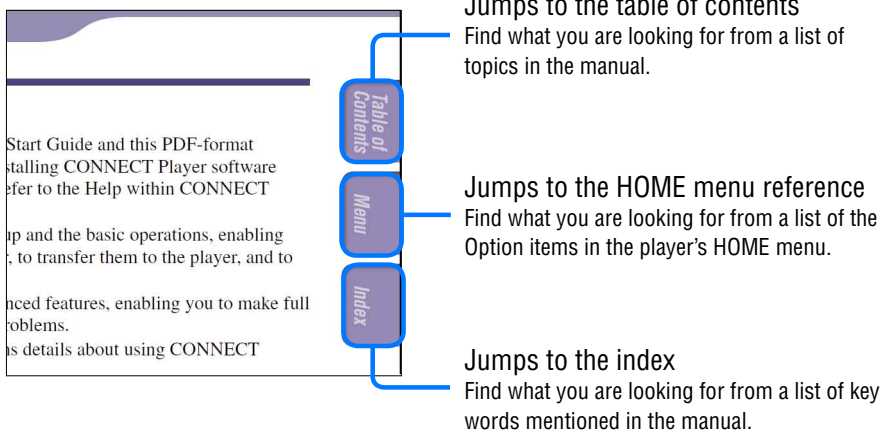

💡 Hints

- You can jump to the indicated page by clicking a page number in the table of contents, in the HOME menu reference, or in the index.
- You can jump to the indicated page by clicking a page reference indicated by (🔍 page 2), etc.
- To search for a reference page by keyword, click the “Edit” menu, select “Search” of the Adobe Reader to display the navigation frame, type the keyword into the Search text box, and click “Search.”
- You can jump to the previous or next page by clicking the ⏪ and ⏩ buttons located at bottom of the screen of the Adobe Reader.

Continued ↓

To change the page layout

The buttons at the bottom of the Adobe Reader screen enable you to select how pages are displayed.

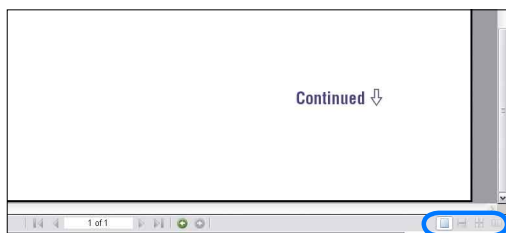

Single Page

Pages are displayed one at a time. When you scroll, the display changes to a previous or succeeding page.

Continuous

Pages are displayed as a continuous roll of pages. When you scroll, the previous and next pages scroll up and down continuously.

Continuous - Facing

Two pages are displayed side by side with each pair part of a continuous roll of pages. When you scroll, the previous and next pairs of pages scroll up and down continuously.

Facing

Two pages are displayed side by side. When you scroll, the display changes to previous or succeeding pairs of pages.

Using CONNECT Player Help

Refer to CONNECT Player Help for details about using CONNECT Player, such as importing tracks to your computer and transferring tracks to the player.

1 Click “Help” – “CONNECT Player Help” while CONNECT Player is running.

Help appears.

Note

- In CONNECT Player Help, the player is referred to as “Device.”

Table of Contents

Supplied Accessories.....	6
Guide to Parts and Controls	7
Using the Player Controls	8

Playing Tracks

Searching for Tracks	10
By track name	10
By album	11
By artist	12
By genre	13
By ☆ Rating	14
By release year	15
From albums recently transferred	16
Searching for Tracks by Initial Letter	17
Playing a Playlist	18
Playing Your Top 100 Tracks	20
Searching for Tracks by Dates Played	21
Playing Tracks in Random Order	22
Playing your 100 favorite tracks in random order	22
Playing tracks released in the same year randomly (Time Machine Shuffle)	23
Playing all tracks in random order	24
Changing the Play Mode	25
Displaying the Now Playing Screen...	27
Displaying the Option Menu.....	28
Searching for Tracks Based on the Currently Playing Track	30
Adding/Editing Tracks to a Bookmark List	31
Deleting a Track From the Player	38
Rating Tracks.....	41

Using the Artist Link Feature

Searching for Artists Belonging to Similar Genres (Artist Link)	42
--	----

Settings

Customizing Sound Quality (6-Band Equalizer)	44
Limiting the Volume from the Headphones.....	47
Turning Off the Player Operation Beep.....	48

Settings (continued)

Connecting to Other Devices	49
Setting the Screen Display Option.....	50
Adjusting the Brightness of the Screen.....	51
Displaying Player Information	52
Selecting the Display Language	53
Resetting to Factory Settings	54
Initializing the Hard Disk	55

Advanced Feature

Charging the Battery Using the AC Power Adaptor	56
Maximizing Battery Life	58
What are Format and Bit Rate?	59
Playing Tracks Without Pauses	60
Playing Audio Files Stored in SonicStage	61
How is Track Information Imported into the Player?	62
Storing Data Other Than Audio Files	63
Updating the Player's Firmware	64

Troubleshooting

Troubleshooting	65
Error Messages	72
Uninstalling CONNECT Player.....	78

Additional Information

Notes on Disposing of the Player	82
Precautions.....	85
On Copyrights.....	89
Specifications.....	90
Optional Accessories.....	92
Index	93

Player HOME Menu Reference

The HOME menu is the screen that appears either when you turn the player on or when you connect it to CONNECT Player.

The HOME menu is the starting point to play audio, search for tracks, and change settings.

To display the player's HOME menu, press and hold BACK from any screens.

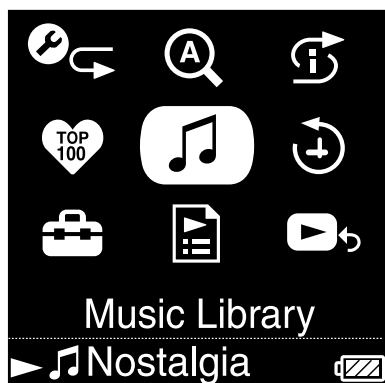

Play Mode

Normal	26
Repeat	26
Shuffle.....	26
Shuffle&Repeat	26
Repeat 1 Song	26

Initial Search

Artist	17
Album	17
Song	17

Intelligent Shuffle

My Favorite Shuffle	22
Time Machine Shuffle	23
Shuffle All.....	24

Favorite 100 20

Music Library

Playlists.....	18
All Songs	10
Album	11
Artist	12
Genre.....	13
☆Rating	14
Release Date	15
Recent Transfers	16

Play History 21

Settings

Play Mode	25
Sound	44
Default Bookmark	31
AVLS (Vol. Limit)	47
Beep	48
Audio Output	49
Display.....	50
Brightness	51
Unit Information	52
Language.....	53
Reset all Settings.....	54
Initialize Disk.....	55

Playlists

B.mark List 1 – 5	19, 31
Playlists.....	19
Favorite 100	19, 20
Trash Bin.....	19, 38

Now Playing 27

Supplied Accessories

The player includes the following items.

The built-in rechargeable battery is pre-installed in the player.

- Headphones (1)

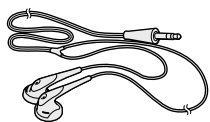

- USB cable (1)

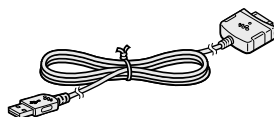

- Headphone extension cord (1)

- AC power cord** (1)

- AC power adaptor** (1)

- CD-ROM* (1)

– CONNECT Player software

– Operation Guide (PDF file)

* Do not attempt to play this CD-ROM in an audio CD player.

- Quick Start Guide (1)

**Depending on your country or region, an AC power adaptor and AC cord may not be supplied with the player.

For customers in the USA

The AC power adaptor supplied with this unit is not intended to be serviced. Should the AC power adaptor cease to function in its intended manner during the warranty period, the adaptor should be returned to your nearest Sony Service Center or Sony Authorized Repair Center for replacement, or if a problem occurs after the warranty period has expired, the adaptor should be discarded.

Notes

- When using this player, follow the precautions below to avoid damaging the player.
 - Do not sit down with the player in your back pocket.



- If you store the player with the headphones/earphones cord wrapped around it, do not subject the player to a strong impact.
- Connect the AC power adaptor to an easily accessible AC outlet. Should you notice an abnormality in the AC power adaptor, disconnect it from the AC outlet immediately.

About the serial number

The serial number provided for this player is required for the customer registration. The number is on a label on the back of the player. Do not remove the label.

Guide to Parts and Controls

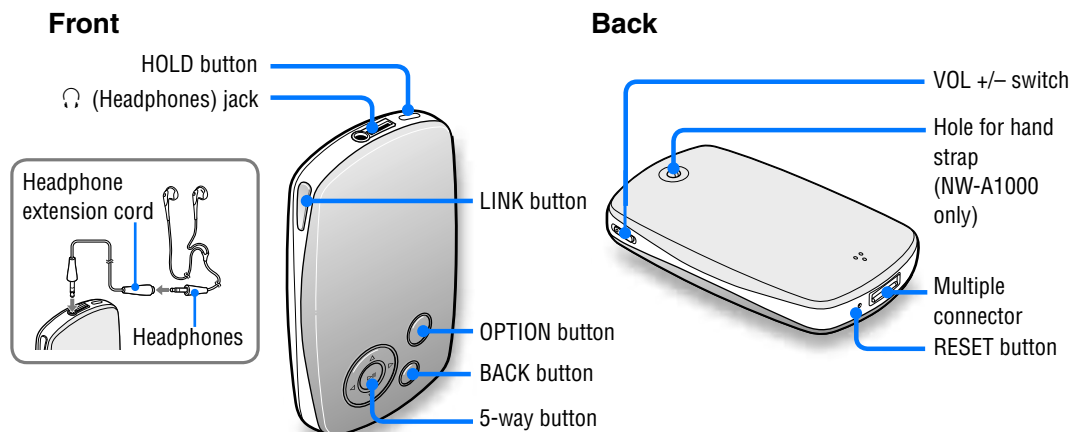

HOLD button

When you press and hold the HOLD button, “HOLD On” appears, the player is disabled, and the controls are locked. When you press and hold the HOLD button while the HOLD feature is on, “HOLD Off” appears, and the controls are unlocked again.

(Headphones) jack

Insert the headphone or the headphones extension cord until you feel a click. If the plug is not securely seated, sound may not be played properly through the headphones. The headphone jack is also used for LINE OUT connections (☞ page 49).

LINK button

Searches for tracks by artists that belong to the similar genre to the artist of the currently playing track (☞ page 42).

5-way button

Starts playback and enables navigation of the player’s on-screen menus (☞ page 9).

BACK button

Press to go up one list screen level (☞ page 8), or to return to the previous screen. Press and hold BACK to display the HOME menu.

OPTION button

Displays the Option menu (☞ page 28).

To turn the player off, press and hold the OPTION button or select “Shut Down” from the Option menu, and then press ▷||

VOL +/- switch

Adjusts the volume when slid up or down.

Multiple connector

Connects the supplied USB cable (☞ page 56).

RESET button

Resets the player (☞ page 65).

Using the Player Controls

Use the 5-way button and the BACK button to navigate through screens, play tracks, and change the player's settings.

The diagram below shows how the screen changes when you press the operation button. For example, a player's screen changes as shown below by selecting "Music Library"—"Album"—"Album"—"Album" from the HOME menu.

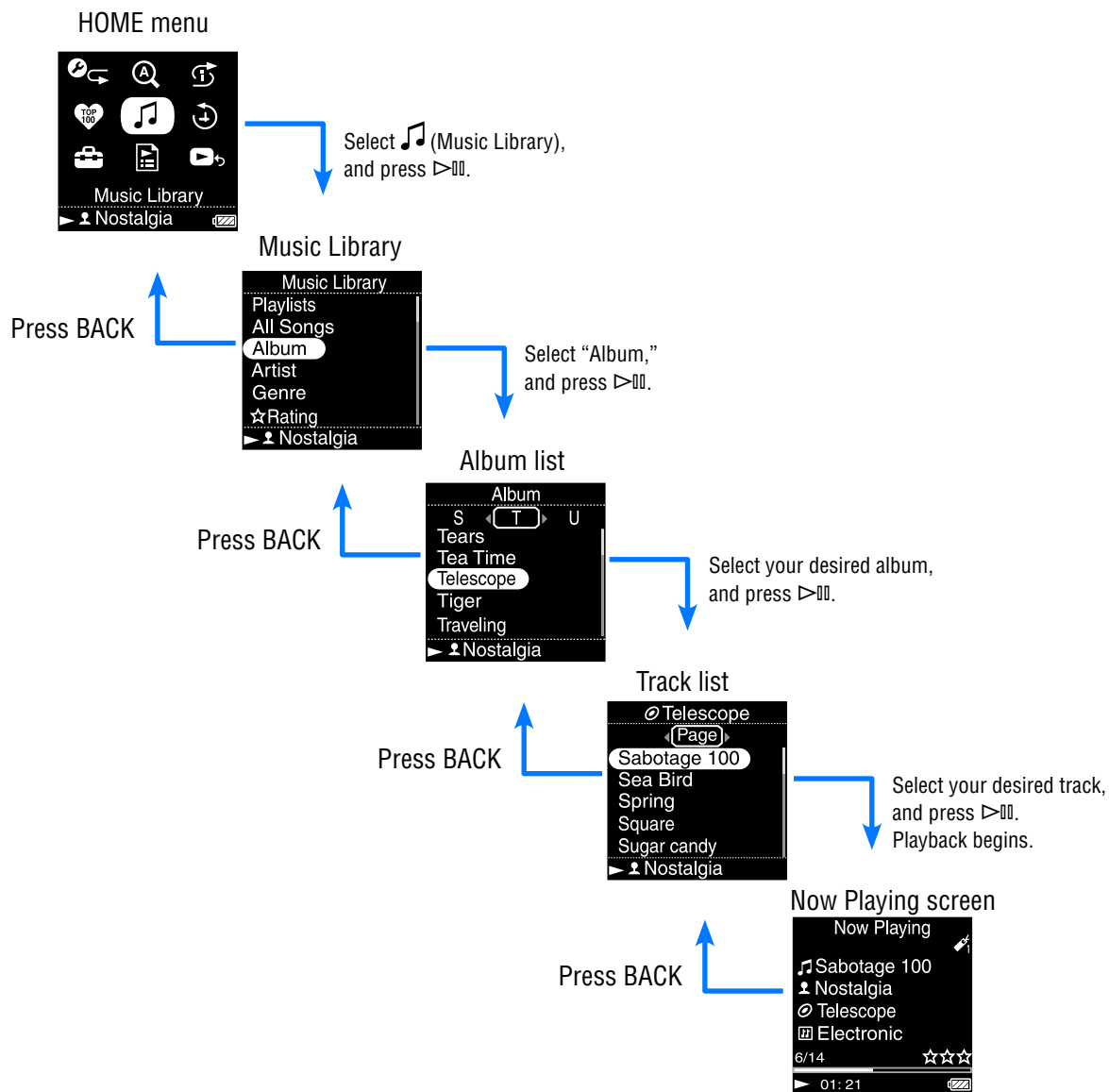

The 5-way button performs different functions depending upon the screen shown on the player's display. List screens enable you to search for and select tracks. The Now Playing screen provides information about the currently playing track.

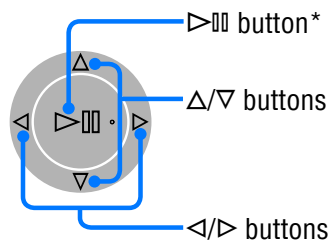

* Use the raised dot on the ▷||| button as a tactile reference when operating the player.

List screen

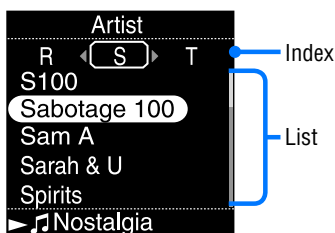

Now Playing screen

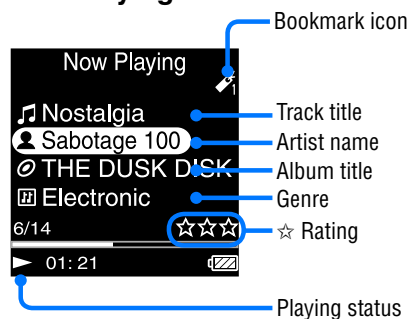

▷||| button

Activates the selected item. Press and hold ▷||| to play all the tracks of the selected item.

Δ/▽ buttons

Moves the cursor up or down. Press and hold to scroll up or down faster.

</> buttons

Changes screens, or, when an index screen is displayed, moves the cursor left or right to display a list of items.

▷||| button

▷ is displayed on the left bottom of the player's display while a track is playing. When you press ▷||| during playback, ||| appears, and the track pauses. Press ▷||| to resume playback. This pause and resume feature is available only on the Now Playing screen.

Δ/▽ buttons

Press Δ/▽ to display the cursor and scroll through the displayed items. When the genre, album title, or other characteristic is selected by the cursor, press ▷||| to display a list of artists or tracks matching the genre of the currently playing track.

</> buttons

Moves playback to the beginning of the current, previous, or next track when pressed once or repeatedly. Press and hold to scan a playing track backwards or forwards quickly.

Searching for Tracks

You can search for tracks by “Genre,” “Artist,” “Album,” “Track,” etc.

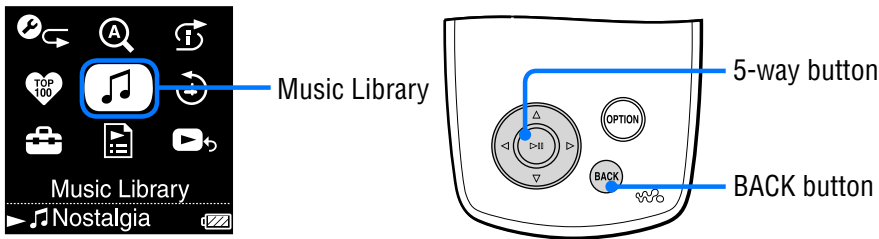

Searching for tracks by track name

The list of tracks is displayed alphabetically by the first letter of the track title.

- 1 **Press and hold BACK.**
The HOME menu appears.
- 2 **Press $\Delta/\nabla/\leftarrow/\rightarrow$ to select ♪ (Music Library), and then press $\triangleright\text{|||}$.**
The list screen appears.
- 3 **Press Δ/∇ to select “All Songs,” and then press $\triangleright\text{|||}$.**
The track list appears.
- 4 **Press $\Delta/\nabla/\leftarrow/\rightarrow$ to select a track, and then press $\triangleright\text{|||}$.**
Playback starts from the selected track and continues through all tracks on the list.

Hint

- You can add a track to the default Bookmark List by pressing $\triangleright\text{|||}$ while selecting the track in the track list ( page 31).

Continued 

Searching for tracks by album

The list of albums is displayed alphabetically by the first letter of the album title.

1 Press and hold BACK.

The HOME menu appears.

2 Press $\Delta/\nabla/\langle/\rangle$ to select  (Music Library), and then press \triangleright .

The list screen appears.

3 Press Δ/∇ to select "Album," and then press \triangleright .

The album list appears.

You can play all tracks of a list item by selecting the item from the list and pressing and holding \triangleright .

4 Press $\Delta/\nabla/\langle/\rangle$ to select an album, and then press \triangleright .

The track list appears.

5 Press $\Delta/\nabla/\langle/\rangle$ to select a track, and then press \triangleright .

Playback starts from the selected track and continues through all tracks on the list.

Continued 

Searching for tracks by artist

The list of artists is displayed alphabetically by the first letter of the artist's name.

1 Press and hold BACK.

The HOME menu appears.

2 Press $\Delta/\nabla/\langle/\rangle$ to select  (Music Library), and then press \triangleright .

The list screen appears.

3 Press Δ/∇ to select "Artist," and then press \triangleright .

The artist list appears.

You can play all tracks of a list item by selecting the item from the list and pressing and holding \triangleright .

(This option is also available at step **4** as you narrow the list.)

4 Press $\Delta/\nabla/\langle/\rangle$ to select an artist, and then press \triangleright .

The album list appears.

5 Press $\Delta/\nabla/\langle/\rangle$ to select an album, and then press \triangleright .

The track list appears.

6 Press $\Delta/\nabla/\langle/\rangle$ to select a track, and then press \triangleright .

Playback starts from the selected track and continues through all tracks on the list.

Hint

- If the artist name starts with "The" or "THE," the introductory "The" or "THE" is ignored in sorting the artist list by name.

Continued 

Searching for tracks by genre

- 1 Press and hold BACK.**
The HOME menu appears.
- 2 Press $\Delta/\nabla/\langle/\rangle$ to select  (Music Library), and then press \triangleright .**
The list screen appears.
- 3 Press Δ/∇ to select “Genre,” and then press \triangleright .**
The list of genres appears.
You can play all tracks of a list item by selecting the item from the list and pressing and holding \triangleright .
(This option is also available at step **5** as you narrow the list.)
- 4 Press $\Delta/\nabla/\langle/\rangle$ to select a genre, and then press \triangleright .**
The artist list appears.
- 5 Press $\Delta/\nabla/\langle/\rangle$ to select an artist, and then press \triangleright .**
The album list appears.
- 6 Press $\Delta/\nabla/\langle/\rangle$ to select an album, and then press \triangleright .**
The track list appears.
- 7 Press $\Delta/\nabla/\langle/\rangle$ to select a track, and then press \triangleright .**
Playback starts from the selected track and continues through all tracks on the list.

Continued 

Searching for tracks by ☆ Rating

You can rate tracks by assigning them from one to five stars (☆) and then later search for tracks by their star rating. For details on assigning star ratings, see  page 41.

1 Press and hold BACK.

The HOME menu appears.

2 Press $\Delta/\nabla/\langle/\rangle$ to select  (Music Library), and then press \triangleright .

The list screen appears.

3 Press Δ/∇ to select “☆ Rating,” and then press \triangleright .

The list of ratings appears.

You can play all tracks of a list item by selecting the item from the list and pressing and holding \triangleright .

4 Press Δ/∇ to select your desired star rating for the track (indicated by 1 to 5 ☆s), and then press \triangleright .

The track list appears.

5 Press $\Delta/\nabla/\langle/\rangle$ to select a track, and then press \triangleright .

Playback starts from the selected track and continues through all tracks on the list.

Hint

- “☆ Rating” includes automatically assigned ratings indicated by hollow stars (☆) and manually assigned ratings indicated by filled stars (★).

Continued 

Searching for tracks by release year

1 Press and hold BACK.

The HOME menu appears.

2 Press $\Delta/\nabla/\langle/\rangle$ to select  (Music Library), and then press \triangleright .

The list screen appears.

3 Press Δ/∇ to select “Release Date,” and then press \triangleright .

The list of release years appears.

You can play all tracks of a list item by selecting the item from the list and pressing and holding \triangleright .

(This option is also available at step **4** as you narrow the list.)

4 Press Δ/∇ to select a year, and then press \triangleright .

The artist list appears.

5 Press $\Delta/\nabla/\langle/\rangle$ to select an artist, and then press \triangleright .

The track list appears.

6 Press $\Delta/\nabla/\langle/\rangle$ to select a track, and then press \triangleright .

Playback starts from the selected track and continues through all tracks on the list.

Continued 

Searching for tracks from albums recently transferred

You can search for tracks from albums transferred during the three most recent connections to CONNECT Player.

1 Press and hold BACK.

The HOME menu appears.

2 Press $\Delta/\nabla/\langle/\rangle$ to select  (Music Library), and then press \triangleright .

The list screen appears.

3 Press Δ/∇ to select “Recent Transfers,” and then press \triangleright .

A selection list appears for the three most recent transfer sessions with CONNECT Player.

You can play all tracks of a list item by selecting the item from the list and pressing and holding \triangleright .

(This option is also available at step **4** as you narrow the list.)

4 Press Δ/∇ to select the time of a transfer session, and then press \triangleright .

The album list from the selected session appears.

5 Press $\Delta/\nabla/\langle/\rangle$ to select an album, and then press \triangleright .

The track list appears.

6 Press $\Delta/\nabla/\langle/\rangle$ to select a track, and then press \triangleright .

Playback starts from the selected track and continues through all tracks on the list.

Searching for Tracks by Initial Letter

You can search for tracks by the initial letter of the artist name, album title, or track title.

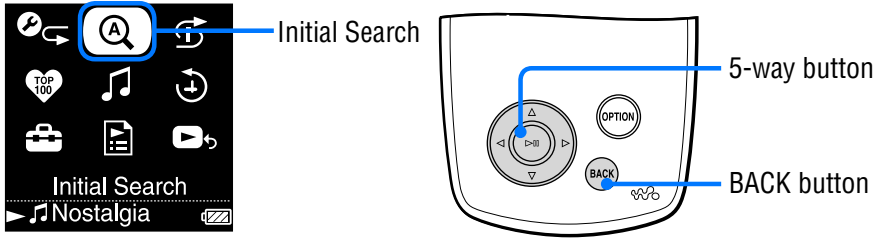

- 1 Press and hold BACK.**
The HOME menu appears.
- 2 Press $\Delta/\nabla/\leftarrow/\rightarrow$ to select A (Initial Search), and then press \triangleright .**
A screen appears that enables you to select a character.
- 3 Press $\Delta/\nabla/\leftarrow/\rightarrow$ to select an initial character, and then press \triangleright .**
A list of categories you can search by appears.
“Song” searches by the track title, “Artist” searches by the artist name, and “Album” searches by the album title.
- 4 Press Δ/∇ to select a category, and then press \triangleright .**
“Searching” appears.
When the search finishes, the results are displayed.
When you select “Artist” or “Album,” you can narrow the search results and select a specific track.
When “Artist” or “Album” is selected and press and hold \triangleright , all tracks on the item are played.

Note

- While “Searching” is displayed, the controls of the player cannot be operated.

Playing a Playlist

You can play lists of tracks (playlists) created either in CONNECT Player or on the player (Bookmark List).

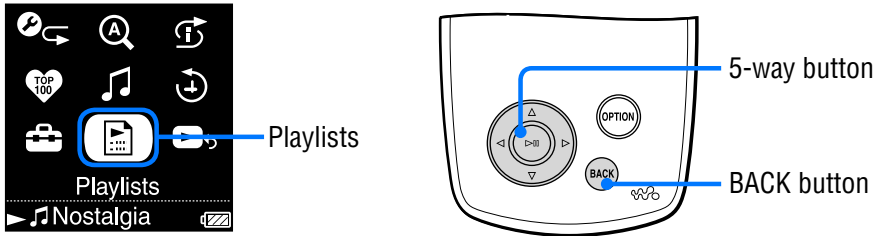

1 Press and hold **BACK**.

The HOME menu appears.

2 Press $\Delta/\nabla/\leftarrow/\rightarrow$ to select **Playlists**, and then press \triangleright .

The screen to select a playlist type appears.

You can play all tracks of a list item by selecting the item from the list and pressing and holding \triangleright .

For details of each of playlist type, see [page 19](#).

3 Press $\Delta/\nabla/\leftarrow/\rightarrow$ to select a playlist, and then press \triangleright .

The track list appears.

4 Press $\Delta/\nabla/\leftarrow/\rightarrow$ to select a track, and then press \triangleright .

Playback of the selected track starts.



Hint

- You can also access playlists by selecting “Playlists” from the “Music Library” screen.

Continued 

Types of playlists

There are five types of playlists, as described below.

Playlist type	Explanation
B.mark List 1 – 5 ¹⁾	A playlist created in the player (called a Bookmark List). The player includes five Bookmark Lists. For details on Bookmark Lists, see  page 31.
Playlists ¹⁾	A playlist created in CONNECT Player. For details on creating a playlist, refer to CONNECT Player Help.
Favorite 100	A playlist created automatically by CONNECT Player that includes the 100 tracks that the player has played the most, displayed in descending order by how many times they have been played. This playlist is updated each time you connect the player to CONNECT Player.
Trash Bin	A playlist that includes tracks to be deleted from the player. Tracks added to the Trash Bin are delete from the player the next time you connect the player to CONNECT Player. For details on adding tracks to the Trash Bin, see  page 38.

1) If you change a Bookmark List's name or a Playlist's name in CONNECT Player, the list appears with the edited name.

Playing Your Top 100 Tracks

The player can select and play the 100 tracks that have been played the most times.

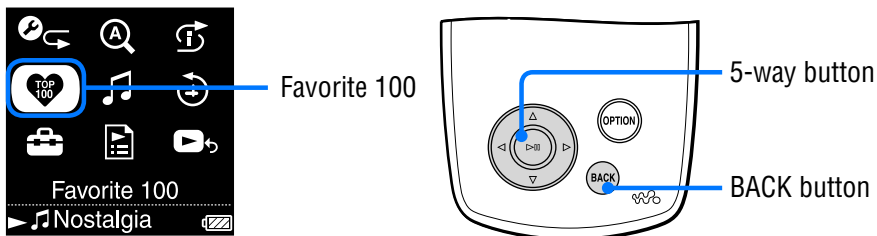

1 Press and hold **BACK**.

The HOME menu appears.

2 Press $\Delta/\nabla/\leftarrow/\rightarrow$ to select **TOP 100** (Favorite 100), and then press \triangleright .

The list of the top 100 tracks appears.

3 Press $\Delta/\nabla/\leftarrow/\rightarrow$ to select a track, and then press \triangleright .

Playback starts from the selected track and continues through all tracks on the list.

Hints

- The track play counts used to select the top 100 are updated each time you connect the player to CONNECT Player.
- If the total number of tracks stored on the player is less than 100, all tracks on the player are played. If fewer than 100 tracks on the player have ever been played, all tracks on the player that have been played at least once are played.

Searching for Tracks by Dates Played

You can search for tracks according to the dates on which the player has played them.

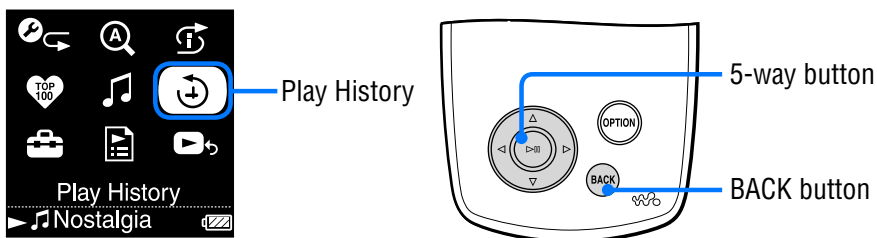

1 Press and hold **BACK**.

The HOME menu appears.

2 Press $\Delta/\nabla/\langle/\rangle$ to select \odot (**Play History**), and then press $\triangleright\|\|$.

A list of dates on which tracks were played appears, starting with the most recent.

3 Press \langle/\rangle to select a year and month, press Δ/∇ to select a date, and then press $\triangleright\|\|$.

A list of tracks played on the selected date appears.

When you select one item on the list and press and hold $\triangleright\|\|$, all tracks on the item are played.

4 Press $\Delta/\nabla/\langle/\rangle$ to select a track, and then press $\triangleright\|\|$.

Playback starts from the selected track and continues through all tracks on the list.

Hint

- The history of when tracks were played for more than 15 seconds is updated and that record is applied to the play history only when you connect the player to CONNECT Player.
- When a track is played for less than 15 seconds, that playback is not applied to the play history.

Playing Tracks in Random Order

The player offers three random play (also known as “shuffle play”) modes: “My Favorite Shuffle,” “Time Machine Shuffle,” and “Shuffle All.” Each shuffle play mode plays a different selection of tracks in random order.

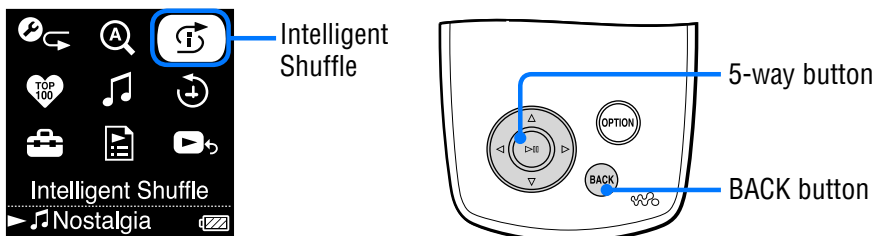

Playing your 100 favorite tracks in random order

The player selects the 100 tracks that have been played the most and plays them in random order.

- 1 Press and hold BACK.**
The HOME menu appears.
- 2 Press $\Delta/\nabla/</>$ to select  (Intelligent Shuffle), and then press \triangleright .**
The screen to select a shuffle type appears.
- 3 Press Δ/∇ to select “My Favorite Shuffle,” and then press \triangleright .**
“Shuffle play 100 favorite songs.” appears, and playback starts.
If you select a shuffle type while a track is playing, the track stops after the message appears, and a randomly selected track starts playing.

Hints

- Shuffle play is automatically cancelled by any of the following operations:
 - Starting playback of a track by selecting it from the Music Library.
 - Using the Artist Link feature.
 - Changing the play mode.
- The track play count information for “My Favorite Shuffle” is updated every time you connect the player to CONNECT Player.
- If fewer than 100 tracks on the player have ever been played, all tracks on the player that have been played at least once are played in random order. If the total number of tracks stored on the player is less than 100, all tracks on the player are played in random order.

Continued 

Note

- To move back through as many as the last 20 tracks played during shuffle play, press ◀ repeatedly. Moving back more than one track to continue playing tracks, or going forward quickly or pressing ▶ resets the shuffle to create a new random track order.

Playing tracks released in the same year randomly (Time Machine Shuffle)

The player selects a year at random and plays tracks released in that year.

1 Press and hold BACK.

The HOME menu appears.

2 Press Δ/∇/◀/▶ to select (Intelligent Shuffle), and then press ▶||.

The screen to select a shuffle type appears.

3 Press Δ/∇ to select “Time Machine Shuffle,” and then press ▶||.

“Shuffle play songs released in 2005.” (for example) appears, and then tracks released in the selected year are played in random order.

If you select a shuffle type while a track is playing, the track stops after the message appears, and a randomly selected track starts playing.

Hint

- Shuffle play is automatically cancelled by any of the following operations:
 - Starting playback of a track by selecting it from the Music Library.
 - Using the Artist Link feature.
 - Changing the play mode.

Notes

- The controls of the player cannot be operated while a year is being selected.
- A shuffle play of all tracks begins if none of the tracks on the player have a release year assigned to them.
- If all the tracks on the player that have a release year assigned have the same release year, or some of tracks have the same release year and the rest of them have no released year assigned, the player automatically plays a random shuffle of the tracks from that year, and “Shuffle play songs released in 2005” (for example) is displayed.
- To move back through as many as the last 20 tracks played during shuffle play, press ◀ repeatedly. Moving back more than one track to continue playing tracks, or going forward quickly or pressing ▶ resets the shuffle to create a new random track order.

Continued ↓

Playing all tracks in random order

All the tracks stored on the player are played in random order.

1 Press and hold BACK.

The HOME menu appears.

2 Press $\Delta/\nabla/\leftarrow/\rightarrow$ to select (Intelligent Shuffle), and then press \triangleright .

The screen to select a shuffle type appears.

3 Press Δ/∇ to select “Shuffle All,” and then press \triangleright .

“Shuffle play all.” appears, and playback starts.

If you select a shuffle type while a track is playing, the track stops after the message appears, and a randomly selected track starts playing.

Hint

- Shuffle play is automatically cancelled by any of the following operations:
 - Starting playback of a track by selecting it from the Music Library.
 - Using the Artist Link feature.
 - Changing the play mode.

Note

- To move back through as many as the last 20 tracks played during shuffle play, press \leftarrow repeatedly. Moving back more than one track to continue playing tracks, or going forward quickly or pressing \triangleright resets the shuffle to create a new random track order.

Changing the Play Mode

The player offers a variety of play modes, including normal play and several shuffle play (random play) and repeat play options.

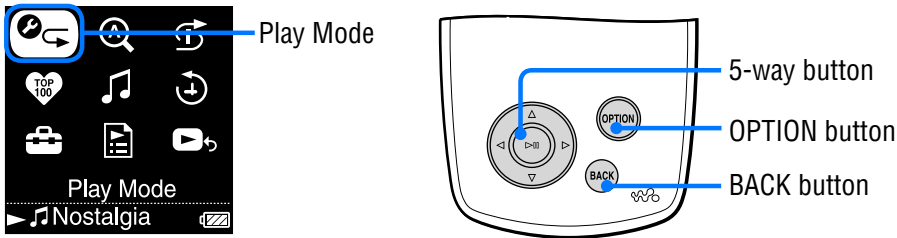

1 Press and hold **BACK**.

The HOME menu appears.

2 Press $\Delta/\nabla/\leftarrow/\rightarrow$ to select $\square\rightarrow$ (Play Mode), and then press $\triangleright\|\|$.

The list of play modes appears.

You can also display the list of play modes when playing a track by pressing **OPTION** and selecting “Play Mode” from the Option menu that appears.



3 Press Δ/∇ to select a play mode (see 🔍 page 26), and then press $\triangleright\|\|$.

If you selected “Play Mode” from the HOME menu, the HOME menu reappears.

If you selected “Play Mode” by pressing **OPTION** while playing a track, the Now Playing screen reappears.

Continued \downarrow

The list of play modes

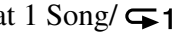
Play mode type/icon	Description
Normal/No icon	All the tracks after the selected track are played once in the track list order, and then playback pauses.
Repeat/ 	After the currently playing track (or the track selected from a track list) finishes, tracks on the currently playing list item (such as an album or artist list) are played repeatedly in track list order.
Shuffle/ SHUF	After the currently playing track (or the track selected from a track list) finishes, tracks on the currently playing list item (such as an album or artist list) are played in random order.
Shuffle&Repeat/  SHUF	After the currently playing track (or the track selected from a track list) finishes, tracks on the currently playing list item (such as an album or artist list) are played repeatedly in random order.
Repeat 1 Song/ 	The currently playing track (or the track selected from a track list) is played repeatedly.

Notes

- When you start playback by selecting “Intelligent Shuffle” on the HOME menu, the play mode automatically switches to “Shuffle” or “Shuffle & Repeat.”
- To move back through as many as the last 20 tracks played during shuffle play, press \triangleleft repeatedly. Moving back more than one track to continue playing tracks, or going forward quickly or pressing \triangleright resets the shuffle to create a new random track order.

Displaying the Now Playing Screen

The Now Playing screen displays information about the currently playing track, such as the artist name and album title.

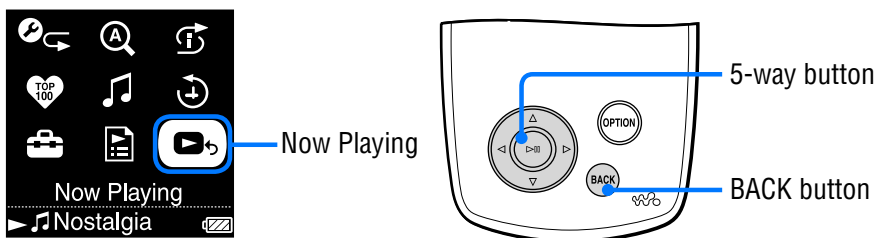

1 Press and hold **BACK**.

The HOME menu appears.

2 Press $\Delta/\nabla/\leftarrow/\rightarrow$ to select **▶↵** (Now Playing), and then press $\triangleright\|\|$.

Detailed information about the currently playing track appears.

Hint

- If you display the Option menu from the Now Playing screen and select “Detailed Information,” you can view detailed information about the track, such as release year, playing time, audio format, and bit rate*.

* If the track has a variable bite rate, “VBR” is shown for the bit rate.

Displaying the Option Menu

From the Option menu, you can modify settings for the currently playing track and access a variety of player features.

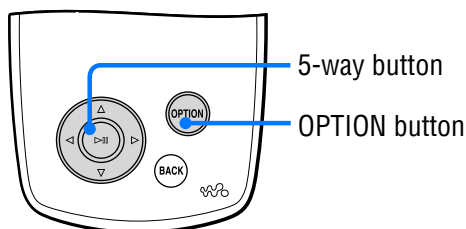

1 Press **OPTION**.

The Option menu appears.

2 Press **Δ/∇** to select an option item, and then press **▷||**.















Depending upon the item selected, either an option setting screen appears or the selected item is activated.

For details on each of the option item, see the table on [📄](#) page 29.

Continued ↓

 **Hint**

- Press **OPTION** to view a list of setting and navigation options for the track, as described in the following table.

Item	Description/reference page
Go to Album	See  page 30.
Go to Artist	See  page 30.
Go to Genre	See  page 30.
Bookmark	See  page 31.
Select Bookmark	See  page 32.
Remove Bookmark	See  page 34.
Clear Bookmark List	See  page 35.
Add to Trash Bin	See  page 38.
Rescue	See  page 39.
Rescue All from Trash Bin	See  page 40.
Play Mode	See  page 25.
☆ Rating	See  page 41.
Detailed Information	See  page 27.
Shut Down	Turns off the player.
Now Playing	Displays the Now Playing screen.
Play	Starts playback.
Re-order Songs	See  page 36.
Change Icon	See  page 37.
HOME menu	Displays the HOME menu.

Notes

- The Option menu cannot be displayed on some of the screens, such as the Settings screen.
- The option items shown on the Option menu vary, depending on the screen from which you display the Option menu.

Searching for Tracks Based on the Currently Playing Track

By displaying the Option menu from the Now Playing screen, you can search for other tracks and albums by the artist of the currently playing track and for tracks by other artists that belong to the same genre as the currently playing artist.

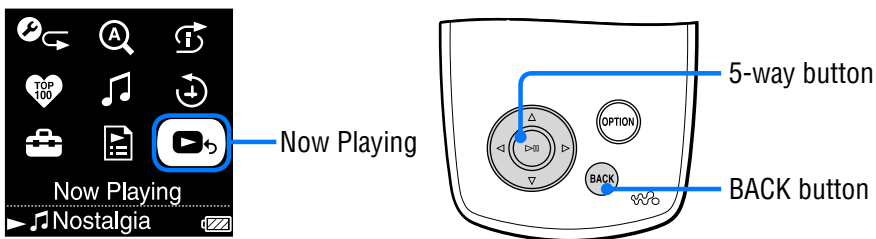

1 Press and hold **BACK**.

The HOME menu appears.

2 Press $\Delta/\nabla/\leftarrow/\rightarrow$ to select **Now Playing**, and then press \triangleright .

Detailed Information about the currently playing track appears.

3 Press **OPTION**.

The Option menu appears.

4 Press Δ/∇ to select an option item, and then press \triangleright .

“Go to Album” displays a track list of the currently playing album.

“Go to Artist” displays a list of albums by the artist of the currently playing track.

“Go to Genre” displays a list of artists who belong to the same genre as the currently playing artist.



5 Press $\Delta/\nabla/\leftarrow/\rightarrow$ to select a track, and then press \triangleright .

Playback starts from the selected track and continues through all succeeding tracks on the list.

Adding/Editing Tracks to a Bookmark List

A Bookmark List is a feature that groups your favorite tracks into a list. The player supports five Bookmark Lists, each of which can contain up to 100 tracks. For details on playing Bookmark Lists, see  page 18.



To add a track to the default Bookmark List

You can add a track to the default Bookmark List by pressing  while the Now Playing screen is displayed. To change which Bookmark List is the default Bookmark List, see  page 33.

1 Display the Now Playing screen of the track you want to add to the Bookmark List, and then press and hold .

“Added to Bookmark List 1.” (the number is that of the current default Bookmark List) appears, and the Bookmark List icon () lights up.

Hints

- Initially, the default Bookmark List is set to “B.mark List 1.”
- You can also add a track to the default Bookmark List by pressing and holding  while the track is selected in a track list.
- If you play a track from a Bookmark List and then press and hold , the track is removed from the Bookmark list.

Notes

- You cannot add a track to the same Bookmark List twice.
- You cannot add a track to a Bookmark List while that list is being played.

Continued 

To add tracks to a selected Bookmark List

You can add a track to a Bookmark List selected from “B.mark List 1” to “B.mark List 5.”

1 Display the Now Playing screen of the track you want to add to the Bookmark List.

2 Press OPTION.

The Option menu appears.

3 Press Δ/∇ to select “Select Bookmark,” and then press \triangleright .

The screen to select a Bookmark List appears.

4 Press Δ/∇ to select the Bookmark List you want to add the track to, and then press \triangleright .

“Added to Bookmark List 1.” (the number is that of the Bookmark List you selected) appears, and the Bookmark List icon () lights up.

Hints

- Repeat steps **1** to **4** to add more tracks to the Bookmark List.
- You can also add a track to a bookmark list by pressing OPTION while selecting the track in a track list and then selecting “Select Bookmark” from the Option menu.
- You can also add a track to the Trash Bin by pressing OPTION while selecting the track in a track list and then selecting “Add to Trash Bin” from the Option menu.
- You can display and edit Bookmark Lists created on the player using CONNECT Player.

Notes

- You cannot add a track to the same Bookmark List twice.
- You cannot add a track to a Bookmark List while that list is being played.

Continued 

To change the default Bookmark List

1 Press and hold BACK.

The HOME menu appears.

2 Press $\Delta/\nabla/\leftarrow/\rightarrow$ to select (Settings), and then press \triangleright .

3 Press Δ/∇ to select “Default Bookmark,” and then press \triangleright .

A list of the Bookmark Lists appears.

4 Press Δ/∇ to select the Bookmark List you want to set as the default Bookmark List, and then press \triangleright .

The selected Bookmark List is set as the default for tracks added using the \triangleright button.

Hint

- Initially, the default Bookmark List is set to “B.mark List 1.”

Continued 

To remove a track from a Bookmark List

1 Press and hold **BACK**.

The HOME menu appears.

2 Press $\Delta/\nabla/\leftarrow/\rightarrow$ to select (Playlists), and then press \triangleright .

The list of playlists appears.

3 Press $\Delta/\nabla/\leftarrow/\rightarrow$ to select the Bookmark List from which you want to remove a track, and then press \triangleright .

The track list appears.

4 Press $\Delta/\nabla/\leftarrow/\rightarrow$ to select the track you want to remove from the Bookmark List, and then press \triangleright .

Playback of the selected track starts.

5 Press **OPTION**.

The Option menu appears.

6 Press Δ/∇ to select “Remove Bookmark,” and then press \triangleright .

“Removed from Bookmark List 1.” (the number is that of the Bookmark List you selected) appears, and the Bookmark List icon () disappears.

Hint

- If you play a track from a Bookmark List and then press and hold \triangleright , the track is removed from the Bookmark list.

Notes

- When you remove a track that is contained on more than one Bookmark List, the track is removed only from the Bookmark List selected in step **3**.
- You can remove a track from a Bookmark List only while the track is being played.

Continued 

To remove all tracks from a Bookmark List

1 Press and hold **BACK**.

The HOME menu appears.

2 Press $\Delta/\nabla/\langle/\rangle$ to select (**Playlists**), and then press \triangleright .

The list of playlists appears.

3 Press $\Delta/\nabla/\langle/\rangle$ to select the **Bookmark List** from which you want to remove all tracks, and then press \triangleright .

The track list appears.

4 Select any track from the list, and press \triangleright .

Playback of the selected Bookmark List starts.

5 Press **OPTION**.

The Option menu appears.

6 Press Δ/∇ to select “**Clear Bookmark List**,” and then press \triangleright .

A confirmation dialog appears.

7 Press \langle/\rangle to select “**Yes**,” and then press \triangleright .

All tracks are removed from the selected Bookmark List.

If you select “No,” the Bookmark List remains unchanged, and the Now Playing screen appears.

Continued 

To rearrange the track order of a Bookmark List

1 Press and hold **BACK**.

The HOME menu appears.

2 Press $\Delta/\nabla/\leftarrow/\rightarrow$ to select (Playlists), and then press \triangleright .

The list of playlists appears.

3 Press $\Delta/\nabla/\leftarrow/\rightarrow$ to select the Bookmark List whose track order you want to rearrange, and then press \triangleright .

The track list appears.

4 Press **OPTION**.

The Option menu appears.

5 Press Δ/∇ to select “Re-order Songs,” and then press \triangleright .

The screen to change the track order appears.

6 Press Δ/∇ to select a track to move, and then press \triangleright .

The arrow (\blacktriangleleft) appears next to the title of the selected track, and the screen to select a destination appears.

7 Press Δ/∇ to select a destination for the track, and then press \triangleright .

The track you selected in step 6 is moved to the location you selected in step 7.

To move additional tracks, repeat steps 6 and 7.

8 Press **BACK**.

The track list reappears.

Note

- You cannot rearrange the track order of a Bookmark List while playing tracks that are on that Bookmark List.

Continued \downarrow

To change a Bookmark List icon

You can select the icons that are shown when a track added to a Bookmark List is played. The icons enable you to tell at glance which Bookmark Lists contain the track.

1 Press and hold **BACK**.

The HOME menu appears.

2 Press $\Delta/\nabla/\leftarrow/\rightarrow$ to select (Playlists), and then press \triangleright .

The list of playlists appears.

3 Press $\Delta/\nabla/\leftarrow/\rightarrow$ to select the Bookmark List whose icon you want to change, and then press \triangleright .

The track list appears.

4 Press **OPTION**.

The Option menu appears.

5 Press Δ/∇ to select “Change Icon,” and then press \triangleright .

The screen to select an icon appears.

6 Press $\Delta/\nabla/\leftarrow/\rightarrow$ to select the icon, and then press \triangleright .

The Bookmark List icon changes to the selected icon.

Hint

- You can also rename a Bookmark List using CONNECT Player. For details, refer to CONNECT Player Help.

Deleting a Track From the Player

By adding tracks to the Trash Bin, you can delete them from the player the next time you connect the player to CONNECT Player. Deleting tracks from the player does not delete them from CONNECT Player.

Up to 100 tracks can be added to the Trash Bin.

1 Press and hold BACK.

The HOME menu appears.

2 Press $\Delta/\nabla/\leftarrow/\rightarrow$ to select  (Now Playing), and then press $\triangleright\equiv$.

The Now Playing screen appears.

3 Press OPTION.

The Option menu appears.

4 Press Δ/∇ to select “Add to Trash Bin,” and then press $\triangleright\equiv$.

The track is added to the Trash Bin, and “Added to Trash Bin.” appears.

The track added to the Trash Bin are indicated by the Trash Bin icon (.

Tracks added to the Trash Bin are deleted from the player the next time you connect the player to CONNECT Player.

 **Hint**

- You can also add a track to the Trash Bin by selecting it from a track list, pressing OPTION to display the Option menu, and selecting “Add to Trash Bin” from the Option menu.

Note

- After a track is added to the Trash Bin and deleted from the player, it will not be transferred to the player automatically the next time you connect the player to CONNECT Player. For details on how to transfer the track to the player again, refer to CONNECT Player Help.

Continued 

To restore a track from the Trash Bin

You can restore tracks from the Trash Bin only while playing the Trash Bin playlist.

1 Press and hold BACK.

The HOME menu appears.

2 Press $\Delta/\nabla/\leftarrow/\rightarrow$ to select  (Playlists), and then press \triangleright .

The list of playlists appears.

3 Press $\Delta/\nabla/\leftarrow/\rightarrow$ to select “Trash Bin,” and then press \triangleright .

The track list appears.

4 Press Δ/∇ to select a track to restore, and then press \triangleright .

Playback of the selected track starts.

5 Press OPTION.

The Option menu appears.

6 Press Δ/∇ to select “Rescue,” and then press \triangleright .

“Rescued from Trash Bin.” appears, and the next track on the list begins playing.

Continued 

To restore all tracks from the Trash Bin

You can restore tracks from the Trash Bin only while playing the Trash Bin playlist.

1 Press and hold BACK.

The HOME menu appears.

2 Press $\Delta/\nabla/\langle/\rangle$ to select  (Playlists), and then press \triangleright .

The list of playlists appears.

3 Press $\Delta/\nabla/\langle/\rangle$ to select “Trash Bin,” and then press \triangleright .

The track list appears.

4 Press \triangleright .

Playback starts.

5 Press OPTION.

The Option menu appears.

6 Press Δ/∇ to select “Rescue All from Trash Bin,” and then press \triangleright .

A confirmation dialog appears.

7 Press \langle/\rangle to select “Yes,” and then press \triangleright .

“All songs rescued.” appears, and the list of playlists reappears.

If you select “No,” no tracks are restored from the Trash Bin, and the Now Playing screen reappears.

Rating Tracks

You can assign ratings of one to five stars (☆) to tracks and then search for tracks by their star ratings (🔍 page 14).

There are two types of ratings: ratings that you manually assign to tracks and ratings automatically assigned by CONNECT Player.

To rate a track manually

- 1 Press OPTION while playing the track you want to rate.**
An Option menu appears.
- 2 Press Δ/∇ to select “☆ Rating,” and then press \triangleright .**
The setup screen appears.
- 3 Press Δ/∇ to move the cursor to the star rating (☆), press $\triangleleft/\triangleright$ to select your desired number of stars, and then press \triangleright .**
The Now Playing screen reappears.

Note

- When you apply ratings to tracks, the ratings are not available for searching until the next time you connect the player to CONNECT Player.

To rate a track automatically based on its rating in CONNECT Player

- 1 Press OPTION while playing the track you want to rate.**
An Option menu appears.
- 2 Press Δ/∇ to select “☆ Rating,” and then press \triangleright .**
The setup screen appears.
- 3 Press Δ/∇ to select “Auto,” and then press \triangleright .**
The track’s rating from CONNECT Player appears, and then the Now Playing screen reappears.

Hints

- Automatic ratings are indicated by hollow stars (☆). Manual ratings are indicated by filled stars (★).
- Automatic ratings are assigned by CONNECT Player based on the history of tracks played and on other operations in the CONNECT Player software.

Searching for Artists Belonging to Similar Genres (Artist Link)

With the currently playing track as a starting point, you can find other artists and tracks in similar musical genres. In the artist list, preview clips of tracks by the artists are played (Preview Play) as you move the cursor up and down the list, enabling you to hear samples of their music as you search.

1 Play a track by the artist you want to use as the starting point for the search (key artist).

2 Press LINK.

The search begins. When the searching finishes, a list of artists appears. If “Cannot find linked artists. Increase search range?” appears, select “Yes” and follow the steps in “To increase search range (Wide Range)” (🔍 page 43).

3 Press Δ/∇ to select an artist, and then press \triangleright .

A list of the tracks by the selected artist appears.

If you leave the name of any artist selected without pressing \triangleright , preview selections of tracks by the artist are played.

If you select “All Related Songs,” preview selections of all tracks of all artists on the artist list are played. Press \triangleright to display the Now Playing screen of the track.

Selecting “Increase search range” repeats the search using less strict relationships to the genre, so more artists can be found.

4 Press $\Delta/\nabla/\langle/\rangle$ to select a track, and then press \triangleright .

Playback of the selected track starts and continues through the succeeding tracks.

Hint

- If you select any artist in the artist list and press and hold \triangleright , all tracks of the selected artist are played.
- The previous screen reappears when you press BACK.
- If you press LINK while an artist name or track title is selected in step 2 or step 3 or while the Now Playing screen is displayed in step 4, an artist list appears. The player begins playing the currently playing track from the beginning and pauses when the track finishes.
- While a key artist is selected, $\langle/\rangle/\triangleright$ do not operate, so you cannot jump to the previous or next tracks or scan backwards or forwards.

Continued 

Notes

- The Artist Link search feature and the criteria used to find other artists may change as a result of updates to the player's firmware.
- Because the Artist Link feature bases its searches on track information, tracks with no track information attached are not found by the Artist Link feature. If none of the tracks stored on the player have track information, the Artist Link feature cannot work. The track information can be retrieved automatically from the Internet.
- While "Artist Link" is displayed, the controls of the player cannot be operated.
- "Cannot find linked artists" is displayed if there are no tracks by other artists in genres similar to the key artist, or the tracks of artists in genres similar to the key artist have not been transferred to the player, or none the tracks stored on the player have track information.
- The Artist Link feature consumes more battery power than most other player operations, such as playing tracks.

To cancel Artist Link

- 1 Press BACK while viewing the artist list.**

To increase the search range (Wide Range)

- 1 Select "Increase search range" at step ③ of "Searching for Artists Belonging to a Particular Genre" (🔍 page 42), and then press ▷⏏.**

The search begins.

When the search is finished, a list of related artists appears.

If you select "All Related Songs," preview selections of all tracks of all artists on the artist list are played.

If you select "Decrease search range," the artist list reappears.

If the player cannot find any artists or tracks related to the original track, "Cannot find linked artists" appears. Select "Back," and then press ▷⏏ to return to the previous screen.

- 2 Press Δ/∇ to select an artist, and then press ▷⏏.**

A list of the tracks by the selected artist appears.

- 3 Press Δ/∇ to select a track, and then press ▷⏏.**

Playback of the selected track starts and continues through the succeeding tracks on the list.

 **Hint**

- If "Cannot find linked artists. Increase search range?" appears in step ② of "Searching for Artists Belonging to a Particular Genre," you can increase the search range by selecting "Yes" and pressing ▷⏏.
- If you press LINK while a key artist is selected in step ②, the player begins a Wide Range search.

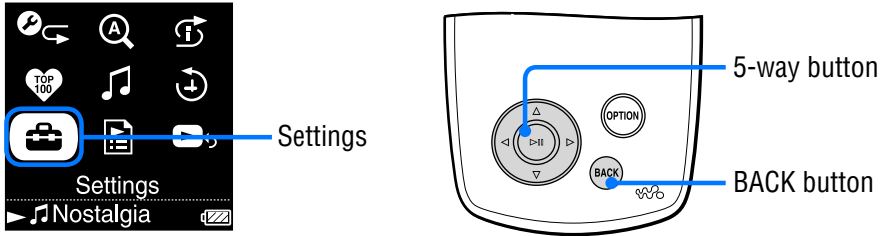

Customizing Sound Quality (6-Band Equalizer)

You can customize the sound quality to match the genre of music.



Customizing sound quality to match the type of music

You can customize the player's sound quality to match the genre of music you want to listen to.

- 1 Press and hold BACK.**
The HOME menu appears.
- 2 Press $\Delta/\nabla/\leftarrow/\rightarrow$ to select  (Settings), and then press \triangleright .**
The list of setup options appears.
- 3 Press Δ/∇ to select "Sound," and then press \triangleright .**
The list of sound quality settings appears.
- 4 Press Δ/∇ to select your desired setting, and then press \triangleright .**
The selected sound setting is applied, and the Settings screen reappears.
For details of each sound setting, see  page 45.

Continued 

List of sound quality settings

The sound settings appear on the screen as the letters in parentheses.

Setting	Description
None	Plays tracks with normal sound quality. (Default setting)
Heavy (H)	Plays tracks in powerful sounds, further emphasizing high and low ranges.
Pop (P)	Plays tracks in sound for vocal, stressing middle range audio.
Jazz (J)	Plays tracks in lively sounds, emphasizing high and low range audio.
Unique (U)	Plays tracks in special sounds, emphasizing high and low range audio more than middle range.
Custom 1 (1)	User-customizable sound settings for which you can adjust each frequency range individually. See  page 46 for details.
Custom 2 (2)	

Notes

- If your chosen sound setting causes the sound to be distorted when you turn up the volume, try turning the volume down.
- If your personal settings saved as “Custom 1” and “Custom 2” seem to produce a different volume level than the other settings, you may have to adjust the volume manually to compensate.
- When the “Audio Output” setting is set to “Line Out” for use with external audio devices, the sound setting cannot be changed.

Continued ↓

Customizing sound quality (Custom)

You can create your own customized sound quality settings and save them as “Custom 1” or “Custom 2” while looking at the player’s screen. For each custom setting, you can individually adjust the sound of six frequency ranges to any of seven sound levels.

1 Press and hold BACK.

The HOME menu appears.

2 Press Δ/∇ / \leftarrow / \rightarrow to select  (Settings), and then press \triangleright .

The list of setup options appears.

3 Press Δ/∇ to select “Sound,” and then press \triangleright .

The list of sound quality settings appears.

4 Press Δ/∇ to select “Custom 1” or “Custom 2,” and then press \triangleright .

The setting screen appears.

5 Press \leftarrow / \rightarrow to select a frequency range, and press Δ/∇ to select sound level for the frequency range.

Each of the six frequency ranges can be set to any of seven sound levels.

6 Press \triangleright .

The Settings screen reappears.

To cancel setup of a custom sound setting

1 Press BACK.

Setup is cancelled, and the previous screen reappears.

Limiting the Volume from the Headphones

You can limit the headphones volume level to protect your hearing and to reduce sound leaking into the environment around you.

- 1 Press and hold BACK.**
The HOME menu appears.

 - 2 Press $\Delta/\nabla/\langle/\rangle$ to select  (Settings), and then press \triangleright .**
The list of setup options appears.

 - 3 Press Δ/∇ to select “AVLS (Vol. Limit),” and then press \triangleright .**

 - 4 Press Δ/∇ to select “On,” and then press \triangleright .**
AVLS* is now on, limiting the headphones volume.
-

* AVLS is an abbreviation of the Automatic Volume Limiter System.

To cancel AVLS (Vol. Limit)

- 1 Select “Off” in step 4.**
The headphone volume level is no longer limited, returning control to the player’s volume settings.

Turning Off the Player Operation Beep

You can set the beep sound on and off.

-
- 1 Press and hold BACK.**
The HOME menu appears.

 - 2 Press $\Delta/\nabla/\leftarrow/\rightarrow$ to select  (Settings), and then press \triangleright .**
The list of setup option appears.

 - 3 Press Δ/∇ to select “Beep,” and then press \triangleright .**

 - 4 Press Δ/∇ to select “Off,” and then press \triangleright .**
The beep is turned off.
-

To keep the sound

- 1 Select “On” in step 4.**
The beep sounds when you operate the player.

Connecting to Other Devices

You can listen to the tracks on your player through a stereo system or record them onto a MiniDisc or a cassette tape by connecting your player to external devices. See the instruction manual that came with the device you want to connect to for information about connecting devices like the player.

- 1 **Turn off all the devices that are to be connected, and then connect the devices as shown below.**

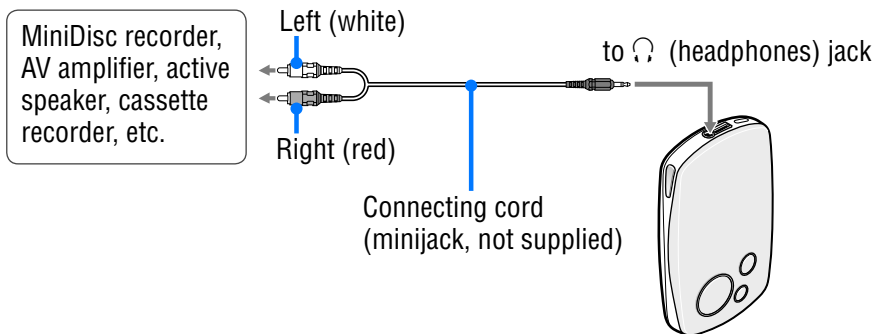

- 2 **Press and hold BACK.**
The HOME menu appears.
- 3 **Press $\Delta/\nabla/\leftarrow/\rightarrow$ to select  (Settings), and then press \triangleright .**
The list of setup options appears.
- 4 **Press Δ/∇ to select “Audio Output,” and then press \triangleright .**
- 5 **Press Δ/∇ to select “Line Out,” and then press \triangleright .**
Sound is output from the device connected to the player.

Notes

- Before beginning playback, turn down the volume of the connected device. Failure to turn down the connected device may cause the sound volume from the device’s speakers to be too loud, distorting the sound and possibly damaging the speakers.
- When the supplied headphone is connected to the player, do not set “Audio Output” to “Line Out.” If it is set to “Line Out,” the volume cannot be adjusted and the sound will be distorted and noisy.
- When “Audio Output” is set to “Line Out,” the player’s volume control is disabled, and the settings in “Sound” ( page 45) are not applied to the player’s audio output.

Setting the Screen Display Option

You can adjust when the display is shown and how long it stays on.

- 1 **Press and hold BACK.**
The HOME menu appears.
- 2 **Press $\Delta/\nabla/\langle/\rangle$ to select  (Settings), and then press \triangleright .**
The list of setup options appears.
- 3 **Press Δ/∇ to select “Display,” and then press \triangleright .**
- 4 **Press Δ/∇ to select your desired setting, and then press \triangleright .**
For details on each of setting, see the table below.

Screen display settings

Setting option	Description
Auto 1	<ul style="list-style-type: none"> • Screen stays on for 30 seconds after the last user operation • Screen stays on while you scroll through a list • An animation replaces the screen display when a normal screen display turns off while playing a track (Default setting)
Auto 2	<ul style="list-style-type: none"> • Screen stays on for 30 seconds after the last user operation • Screen stays on while you scroll through a list • An animation replaces the screen display when a normal screen display turns off while playing a track • Screen stays on when track changes
15 sec	<ul style="list-style-type: none"> • Screen stays on for 15 seconds after the last user operation • Screen stays on while you scroll through a list

Adjusting the Brightness of the Screen

The screen offers five brightness settings.

- 1 Press and hold BACK.**
The HOME menu appears.

- 2 Press $\Delta/\nabla/\langle/\rangle$ to select  (Settings), and then press $\triangleright\|\|$.**
The list of setup items appears.

- 3 Press Δ/∇ to select “Brightness,” and then press $\triangleright\|\|$.**
The brightness adjustment screen appears.

- 4 Press \langle/\rangle to select a level, and then press $\triangleright\|\|$.**

Displaying Player Information

You can view information about your player, including its model name, serial number, version, and the total number of tracks stored on the player.

1 Press and hold BACK.

The HOME menu appears.

2 Press Δ/∇ / \leftarrow / \rightarrow to select  (Settings), and then press \triangleright ||.

The list of setup options appears.

3 Press Δ/∇ to select “Unit Information,” and then press \triangleright ||.

The list of available player information options appears.

You can view the player information by scrolling through the list with Δ/∇ .

Available player information

Option	Description
Model	Displays the model name of the player. (Default setting)
Serial number	Displays the player’s serial number, which is needed to register your player.
Version	Displays version information for the player’s firmware.
Total Songs	Displays the total number of tracks stored on the player.

Selecting the Display Language

You can select from a variety of languages for the display of menus and messages on the player.

- 1 **Press and hold BACK.**
The HOME menu appears.
- 2 **Press $\Delta/\nabla/\leftarrow/\rightarrow$ to select  (Settings), and then press \triangleright .**
The list of setup items appears.
- 3 **Press Δ/∇ to select “Language,” and then press \triangleright .**
- 4 **Press Δ/∇ to select a language, and then press \triangleright .**
For details on each language setting, see the table below.

Display language settings

Setting	Description
日本語	Messages and menus are displayed in Japanese.
English	Messages and menus are displayed in English. (Default setting)
Français	Messages and menus are displayed in French.
Deutsch	Messages and menus are displayed in German.
Italiano	Messages and menus are displayed in Italian.
Español	Messages and menus are displayed in Spanish.
简体中文	Messages and menus are displayed in Simplified Chinese.
繁體中文	Messages and menus are displayed in Traditional Chinese.
한글	Messages and menus are displayed in Korean.

Resetting to Factory Settings

You can restore the player to its original factory settings. Resetting the player does not delete the music tracks you have transferred to the player.

1 Press and hold BACK.

The HOME menu appears.

2 Press $\Delta/\nabla/\langle/\rangle$ to select  (Settings), and then press \triangleright .

The list of setup options appears.

3 Press Δ/∇ to select “Reset all Settings,” and then press \triangleright .

The setting screen appears.

4 Press \langle/\rangle to select “Yes,” and then press \triangleright .

“Restored factory settings.” appears, and the list of setup options reappears.

To cancel restoration of factory settings

1 Select “No” in step 4, and then press \triangleright .

The player’s settings are left unchanged, and the list of setup options reappears.

Note

- Factory settings cannot be restored while tracks are playing.

Initializing the Hard Disk

You can initialize the built-in hard disk of the player. If the hard disk is initialized, all the audio data and the other data stored will be erased. Be sure to verify the data stored in the hard disk prior to initializing.

1 Press and hold BACK.

The HOME menu appears.

2 Press $\Delta/\nabla/$ to select  (Settings), and then press \triangleright .

The list of setup options appears.

3 Press Δ/∇ to select “Initialize Disk,” and then press \triangleright .

The setting screen appears.

4 Press \leftarrow to select “Yes,” and then press \triangleright .

A confirmation dialog appears.

5 Press \leftarrow to select “Yes,” and then press \triangleright .

“Initialize Disk” appears.

When initialization finishes, “Hard disk initialization complete.” appears, and the setting screen reappears.

To cancel hard disk initialization

1 Select “No” in step 4 or 5, and then press \triangleright .

The contents of the hard disk remain unchanged, and the setting screen reappears.

Notes

- Do not initialize the hard disk of the player on the computer.
- The hard disk cannot be initialized while tracks are playing.
- Initializing the hard disk restores all settings to the original factory configuration and erases all audio tracks and other files from the player.

Charging the Battery Using the AC Power Adaptor

You can charge the battery by connecting the player to a computer. When away from your computer, you can charge the battery from a wall outlet using the supplied AC power adaptor** and USB cable.

- 1** Connect the USB cable and AC power cord in the following order from ① to ④.

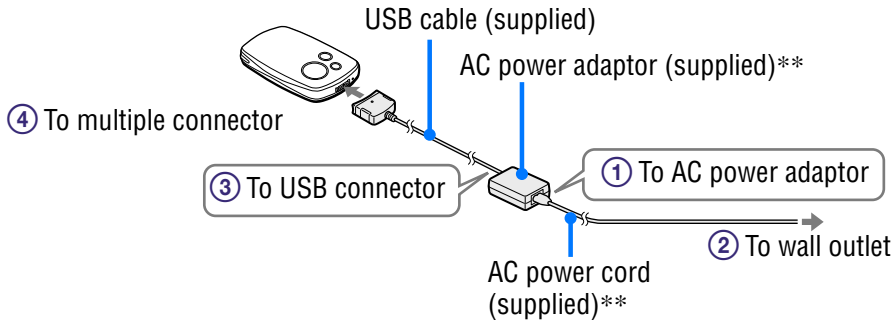

Charging requires the times listed below. When charging finishes,  lights up on the player, and the light on the USB cable turns off.

NW-A1000: The battery charges to about 80% in approximately 1 hour*, a full charge requires approximately 2 hours.*

NW-A3000: The battery charges to about 80% in approximately 2 hour*, a full charge requires approximately 3 hours.*

* These charging times are estimates, based on an empty battery charging at typical room temperature. The actual charging time will differ, depending upon the initial amount of charge in the battery and the condition of the battery. For example, if the battery is already almost fully charged when charging begins, little time is needed to reach a full charge. Charging batteries in a cold environment takes longer than at typical room temperature.

**Depending on your country and region, an AC power adaptor and AC cord may not be supplied with the player. Use the dedicated AC power adaptor (optional).

Continued ↓

To check the remaining power of the battery

The remaining battery power is displayed at the bottom right of the Now Playing screen and setting screens, etc. As the battery runs down, the black portion of the indicator becomes smaller.

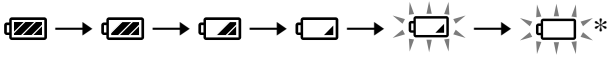

* “LOW BATTERY. Please Charge.” appears on the display, and a warning beep sounds.

Repeated battery charging

The player’s battery uses a technology that is not subject to “memory effect.” Charging a battery that is not completely discharged does not reduce the battery’s capacity.

Notes

- To charge the battery, connect the player to a wall outlet using the supplied AC power adaptor** and USB cable or using the optional charging cradle.
- For best results, charge the battery in an environment of between 5 to 35°C (41 to 95°F).
- The battery indicator on the display is only an estimate. For example, one section of black in the indicator will not always indicate exactly one-fourth of the battery’s charge.
- The accuracy of the battery indicator on the display may vary depending on the operating conditions and environment of the player.
- If you connect the player to the AC power adaptor while a track is playing, playback pauses, an animation is displayed, and the HOME menu appears.
- The battery can be charged from empty approximately 500 times. The actual number of charges possible in the battery’s lifetime varies, depending on the condition of the player and battery.

** Depending on your country and region, an AC power adaptor and AC cord may not be supplied with the player. Use the dedicated AC power adaptor (optional).

Maximizing Battery Life

By following a few simple guidelines, you can extend the playing time available from a battery charge.

Turn off the player manually

Although the player turns off automatically if left in pause mode for a few minutes, you can save some battery power by manually turning off the player when you are finished using it.

To turn off the player, press and hold **OPTION**, or select “Shut Down” from the Option menu of any screen.

Adjust the player display time

A “Display” setting of “15 sec” offers longer battery than the other Display Time options (🔍 page 50).

Adjust the brightness of the screen

Setting “Brightness” to the lower setting reduces battery use while the display is on (🔍 page 51).

Setting the sound quality off

A “Sound” setting of “None” offers longer battery life than the other sound quality options (🔍 page 45).

Do not let your computer sleep when the player is connected

If the computer enters a power saving mode, such as the system suspend, sleep or hibernation while the player is connected via the USB cable, the player’s battery is not charged. Instead, the player continues to draw power from the battery, discharging it.

Note

- Do not leave the player connected for extended periods to a laptop computer that is not connected to AC power, because the player may discharge the computer’s battery.

What are Format and Bit Rate?

What is format?

The format of a track refers to the method used by CONNECT Player to store the track's audio information when tracks are imported to CONNECT Player from the Internet or audio CDs.

Common formats include MP3 and ATRAC, etc.

MP3: MP3 (MPEG-1 Audio Layer3) is a common audio compression technology developed by the MPEG working group of the ISO (International Organization for Standardization).

MP3 can compress audio files to about 1/10 of the size of standard CD audio tracks.

ATRAC: ATRAC (Adaptive Transform Acoustic Coding) is a general term used to refer to ATRAC3 and ATRAC3plus formats. ATRAC is an audio compression technology that satisfies the demand for both high sound quality and high compression rates. ATRAC3 can compress audio files to about 1/10 of the size of standard CD audio tracks. ATRAC3plus, a more advanced version of ATRAC3, can compress audio files to about 1/20 of the size of standard CD audio tracks.

What is bit rate?

Bit rate refers to the amount of data used to store each second of audio. Generally, higher bit rates provide better sound quality, but require more storage space for the same length of audio.

What is the relationship between bit rate, sound quality, and storage size?

Generally, higher bit rates provide better sound quality, but require more storage space for the same length of audio, so you can store fewer tracks on the player.

Lower bit rates enable you to store more tracks, but at a lower sound quality. For details on supported audio formats and bite rate, see  page 90.

Note

- If you import a track from a CD to CONNECT Player at a low bit rate, you cannot improve the track's sound quality by selecting a high bit rate when transferring the track from CONNECT Player to the player.

Playing Tracks Without Pauses

If you import tracks into CONNECT Player in ATRAC format and transfer them to the player, you can play them on the player continuously, without pauses between the tracks.

For example, an album that includes a long recording of a live performance with no pauses between songs can be played continuously without pauses after the tracks are imported to CONNECT player in ATRAC format and then transferred to the player.

Notes

- For tracks to be played without pauses, you must import all the tracks into CONNECT Player as a single album in the same ATRAC format.
- Although the tracks are played without pauses by the player, when ATRAC-format tracks are played in CONNECT Player, pauses are still inserted between tracks.

Playing Audio Files Stored in SonicStage

You can play tracks stored in SonicStage software on the player by first importing them into CONNECT Player.

For details about importing tracks into CONNECT Player, refer to CONNECT Player Help.

Note

- Tracks in SonicStage that have an “.omg” file extension (OpenMG format files) cannot be imported into CONNECT Player. To import these tracks into CONNECT Player, convert them to the “.oma” extension format using the “SonicStage file conversion tool.” For details, refer to CONNECT Player Help.

How is Track Information Imported into the Player?

When you import CD tracks into CONNECT Player, CONNECT Player automatically retrieves information about the tracks (such as album title, artist name, and track name) from a CD database service (CDDDB, the Gracenote CD DataBase) on the Internet at no charge. When tracks are transferred to the player, this track information is transferred along with the tracks. Having this information attached to your tracks makes possible various advanced searching features of the player.

Note

- Track information of some CDs may not be able to be retrieved from the Internet. For tracks that are not in the Internet database, you can manually enter and edit track information in CONNECT Player. For details on editing track information, refer to CONNECT Player Help.

Storing Data Other Than Audio Files

You can store computer data on the hard disk built into the player by transferring it from your computer with Windows Explorer.

The player's hard disk appears in Windows Explorer as a removable storage drive.

Notes

- Do not use CONNECT Player while using Windows Explorer to interact with the player's hard disk.
- Always use CONNECT Player to transfer to the player audio files that you want to play. Audio files transferred with Windows Explorer cannot be played by the player.
- Do not disconnect the USB cable while transferring data between a computer and the player because the data being transferred could be damaged.
- Do not initialize the player's hard disk from the computer. If the player's hard disk must be initialized, follow the initialization procedure on  page 55.
- The size shown in Windows Explorer for the player's hard disk is smaller than the actual size of the disk, because the player uses a value of 1,000,000,000 bytes for 1 GB, while the Windows operating system uses a value of 1,073,741,824 bytes for 1 GB. On the player, the hard disk size is displayed as shown below.
NW-A1000: approx. 5.6 GB (5,980,979,200 Bytes)
NW-A3000: approx. 18.2 GB (19,542,409,216 Bytes)

Updating the Player's Firmware

By updating the player's firmware, you can ensure your player has the latest features. For details about the latest firmware and how to install it, visit the following web sites:

For customers in the USA: <http://www.sony.com/walkmansupport/>

For customers in Canada: <http://www.sony.ca/ElectronicsSupport/>

For customers in Europe: <http://www.sonydigital-link.com/DNA/>

For customers in China: <http://service.sony.com.cn/KB/>

For customers in Taiwan: <http://www.twsupport.css.ap.sony.com/>

For customers in Korea: <http://scs.sony.co.kr/walkman/>

For customers in other countries or areas: <http://www.css.ap.sony.com/>

1 Download the “Digital Player Software Update tool” to your computer from the Web site.

2 Connect the player to your computer, and then start up the “Digital Player Software Update tool.”

3 Follow the on-screen instructions to transfer the firmware update to the player.

When the update finishes by following the on-screen instructions, “The software update was prepared. Execute ‘Safely remove USB device’ and disconnect the USB cable with the device. The software update will start.” appears.

4 Disconnect the player from your computer.

The player starts updating the firmware automatically.

When the update finishes, the player restarts automatically.

Hint

- If there is not enough battery power remaining to apply the firmware update, “Battery too low to update firmware. Please charge.” is displayed. Charge the battery fully, and then transfer the firmware update by starting the “Digital Player Software Update tool.”
-

Troubleshooting

If the player does not function as expected, try the following steps to resolve the issue.

1 Reset the player by pressing the RESET button with a small pin.

The tracks and settings stored on the player are not affected by resetting the player. No information is erased.

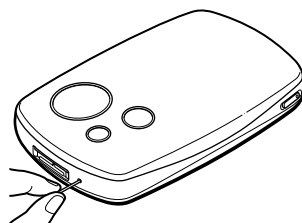

2 Check the symptoms in “Troubleshooting.”

3 Check for information about the issue in CONNECT Player Help.

4 Look for information about the issue on one of the support Web sites (🌐 page 88).

5 If the approaches listed above fail to resolve the issue, consult your nearest Sony dealer.

Power

Symptom	Cause or corrective action
The lamp of the USB cable does not light.	<ul style="list-style-type: none"> → The terminals of the USB adaptor are dirty. Wipe them with a soft, dry cloth. → The player is not connected to the USB cable. Insert the USB cable straight into the port until it is firmly seated. Make sure that the lamp of the USB cable lights up.
The player turned off automatically.	<ul style="list-style-type: none"> → The player turns off if left in pause mode for a few minutes. Press any button other than the HOLD button to turn the player on.
Battery life seems short.	<ul style="list-style-type: none"> → The operating temperature is below 5°C (41°F). This is due to the battery characteristics and not a malfunction. → You have not used the player for a prolonged period. Efficiency of the battery will be improved by repeatedly charging and discharging. → The battery needs to be replaced. Consult your nearest Sony dealer. → The battery has not been given enough time to charge fully. Keep charging the battery until  appears.

Continued ↓

Sound

Symptom	Cause or corrective action
There is no sound. Noise is heard.	<ul style="list-style-type: none"> → The volume level is set to zero. Turn up the volume (🔊 page 7). → The headphone plug is not connected properly. Connect it firmly to the 🎧 (headphones) jack (🔊 page 7). → The headphone plug is dirty. Clean the headphone plug with a soft dry cloth. → No audio data is stored on the hard disk.
The volume does not increase.	→ “AVLS (Vol. Limit)” is set to “On.” Set it to “Off” (🔊 page 47).
There is no sound from the right channel of the headphones.	→ The headphone plug is not connected properly. Connect it firmly to the 🎧 (headphones) jack (🔊 page 7).
The volume cannot be adjusted.	→ “Audio Output” is set to “Line Out.” Adjust the volume using the volume control on the connected device, or set “Audio Output” to “Headphone” (🔊 page 49).
When using the player with a stereo system connected, the sound is distorted or noisy.	→ “Audio Output” is set to “Headphone.” Set it to “Line Out” (🔊 page 49).

Operation/Playback

Symptom	Cause or corrective action
Buttons do not work.	<ul style="list-style-type: none"> → The buttons are locked. Press and hold the HOLD button for a few seconds to unlock it (🔊 page 7). → Press any button other than the HOLD button. → The HOLD message appears when you press any button other than the HOLD button to turn on the player when the player is turned off with HOLD set to on. Press and hold the HOLD button while the message is displayed to disable the HOLD feature and activate the controls. → Moisture has condensed inside the player if the player is brought directly from a cold environment to a warm environment. Set the player aside for a few hours to allow the moisture to evaporate. → The remaining battery power is insufficient to operate the player. Charge the battery (🔊 page 56).

Continued ↓

Operation/Playback (continued)

Symptom	Cause or corrective action
The HOLD feature cannot be activated.	<p>→ The HOLD feature cannot be activated when the player is turned off. Press any button other than the HOLD button to turn on the player, and then press and hold the HOLD button. “HOLD On” appears, and the player turns off with the HOLD function enabled and the controls locked.</p>
Playback stops suddenly.	<p>→ The remaining battery power is insufficient to operate the player. Charge the battery (🔌 page 56).</p> <p>→ If the player encounters an audio track that is incompatible with the player, playback stops (🔊 page 90). Press ▷ to select another track.</p> <p>→ The player has been subjected to vibration for a long period of time. Remove the player from the source of the vibration, and start playback again.</p>
“□” is displayed as part of a title.	<p>→ The title contains characters that the player cannot display. Use the CONNECT Player software to rename the title with appropriate characters.</p>
The screen turns off.	<p>→ Press any button to turn the screen on again. The screen automatically turns off if there is no operation by the user for 15 seconds when “Display” is set to “15 sec” (🔌 page 50). After operations such as scrolling through lists, the screen turns off after the operation is finished.</p>

Continued ↓

Connection with the computer/CONNECT Player

Symptom	Cause or corrective action
The CONNECT Player software cannot be installed.	<ul style="list-style-type: none">→ The computer's operating system software is not compatible with CONNECT Player. Refer to CONNECT Player Readme.→ All Windows applications are not closed. If you start the installation while other programs are running, an error may occur. This is especially true for programs that require significant system resources, such as virus-protection software.→ There is not enough free space on the hard disk of your computer. You need 200 MB or more of free space. Delete any unnecessary files on your computer.→ If you are not logged on as an "Administrator," the installation of CONNECT Player might fail. Make sure that you are logged on using an account with "Administrator" privileges.
The progress bar on the display of your computer is not moving. The access lamp of your computer has not lit for a few minutes.	→ The installation is progressing normally. Please wait. The installation may take 30 minutes or more, depending on your CD drive and system environment.
CONNECT Player does not start up.	→ Your computer's system environment has changed, perhaps due to an update of the Windows operating system.

Continued ↓

Connection with the computer/CONNECT Player (continued)

Symptom	Cause or corrective action
<p>“Connecting” is not displayed when the player is connected to the computer with the USB cable.</p>	<ul style="list-style-type: none"> → The USB cable is not connected properly. Disconnect the USB cable, and then reinsert it straight into the port until it is firmly seated. → A USB hub is being used. Connecting the player via a USB hub may not work and is not supported. Connect the USB cable directly to the computer. → Please wait for the authentication of the CONNECT Player software. → Another application is running on the computer. Disconnect the USB cable, wait a few minutes, and reconnect the cable. If the problem persists, disconnect the USB cable, restart the computer, and then reconnect the USB cable. → The battery is running low. Charge the battery using the AC power adaptor (☞ page 56). → The installation of the CONNECT Player software was not successful. Disconnect the player from your computer, and reinstall the software using the supplied CD-ROM (☞ “Quick Start Guide”). Audio tracks registered with the earlier installation will be available with the new CONNECT Player installation.
<p>The player is not recognized by the computer when it is connected to the computer.</p>	<ul style="list-style-type: none"> → The USB cable is not connected properly. Disconnect the USB cable, and then reconnect it. → A USB hub is being used. Connecting the player via a USB hub may not work and is not supported. Connect the USB cable directly to the computer. → The installation of the CONNECT Player software was not successful. Disconnect the player from your computer, and reinstall the software using the supplied CD-ROM (☞ “Quick Start Guide”). Audio tracks registered with the earlier installation will be available with the new CONNECT Player installation.

Continued ↓

Connection with the computer/CONNECT Player (continued)

Symptom	Cause or corrective action
Audio data cannot be transferred to the player from your computer.	<ul style="list-style-type: none"> → The USB cable is not connected properly. Disconnect the USB cable, and then reconnect it. → There is not enough free space on the player's hard disk. Transfer any unnecessary tracks back to your computer to increase the free space (Ⓞ page 38). → You have already transferred over 65,535 tracks or over 8,192 playlists to the hard disk of the player, or you are trying to transfer a playlist that contains over 999 tracks. → Tracks with a limited playing period or playing count may not be transferred due to restrictions set by copyright holders. For details on the settings of each audio file, contact the distributor.
Only a small number of tracks can be transferred to the player. (Available recording time is short.)	<ul style="list-style-type: none"> → There is not enough free space on the player's hard disk. Transfer any unnecessary tracks back to your computer to increase the free space (Ⓞ page 38). → Data other than audio data is stored in the player's hard disk. Move non-audio data to the computer to increase the free space.
Audio data cannot be transferred back to your computer from the player.	<ul style="list-style-type: none"> → The computer you are trying to transfer tracks to is not the same computer from which the tracks were originally transferred. Tracks can be transferred only to the computer that they originally came from. → The audio data has been deleted from computer you used to transfer to the player. The audio data cannot be transferred back to your computer if the track is deleted from the computer used to transfer to the player.
The player becomes unstable while it is connected to the computer.	<ul style="list-style-type: none"> → A USB hub or USB extension cable is used. Connecting the player via a USB hub or extension cable may not work and is not supported. Connect the supplied USB cable directly to the computer.

Continued ↓

Others

Symptom	Cause or corrective action
There is no beep sound when the player is operated.	→ “Beep” is set to “Off.” Set it to “On” (ⓘ page 48).
The player gets warm.	→ The player may be warm when the battery is being charged and just after charging. The player also may get warm when a large number of tracks are transferred. This behavior is normal and not cause for concern. Set the player aside for a while to allow it to cool down.
Noise comes from the inside of the player, or the player shakes.	→ As the built-in hard disk of the player starts, stops, is read from, and is written to, sound and vibration from these operations may be perceptible. This behavior is normal and not cause for concern.
The screen turns on whenever tracks change.	→ “Display” is set to “Auto 2.” Set it to “Auto 1” or “15 sec” (ⓘ page 50).
The player does not lie in a stable position.	→ The player does not lie in a stable position on a flat surface such as a table. Carry the player in your hand, or hold the player in your hand while your hand rests on the flat surface.
The player has no stop button.	→ With this player, there is no difference between stopping and pausing.
Charging completes very quickly.	→ If the battery is already almost fully charged when charging begins, little time is needed to reach a full charge. When charging finishes,  lights up on the player, and the light on the USB cable turns off.

Error Messages

Follow the instructions below if an error message appears on the display.

Message	Meaning	Corrective action
AVLS (vol. limit) is On. Volume cannot be increased.	The volume exceeds the maximum volume allowed by AVLS.	→ Set “AVLS (Vol. Limit)” to “Off” (🔊 page 47).
Battery too low to update firmware. Please charge.	There is not enough battery remaining to update the firmware.	→ Charge the battery fully, and then update the firmware.
Cannot add more than 100 songs per list.	The number of tracks added to a Bookmark List or the Trash Bin exceeds the 100 track limit.	→ Remove unnecessary tracks from the Bookmark List or the Trash Bin (🔍 page 38).
Cannot add to a Bookmark List currently playing.	You are trying to add a track to a Bookmark List that is currently playing.	→ Start playback of the track from a genre or album list, and then add it to the Bookmark List.
Cannot add when playing from Trash Bin.	You are trying to add a track to the Trash Bin while it is playing.	→ You can add a track to the Trash Bin only when in the stop mode.
Cannot change sound settings when audio output is Line Out.	You tried to change the “Sound” setting while “Audio Output” is set to “Line Out.”	→ Set “Audio Output” to “Headphones” (🔊 page 49).
Cannot change volume when audio output is Line Out.	You tried to change the player volume while “Audio Output” is set to “Line Out.”	→ Set “Audio Output” to “Headphones” (🔊 page 49).
Cannot charge. Charge 5°C – 35°C, 41°F – 95°F.	You are charging the player in an ambient temperature out of the 5 to 35°C (41 to 95°F) range.	→ Charge in an ambient temperature of between 5 and 35°C (41 and 95°F).

Continued ↓

Message	Meaning	Corrective action
Cannot complete while playing. Pause song then try again.	You have tried to select an unselectable item during playback.	→ Pause playback, and try the operation again.
Cannot edit song order in a Bookmark List that is playing.	You are trying to rearrange the order of tracks in a Bookmark List while the Bookmark List is playing.	→ Start playback of a different Bookmark List or of a genre or album, and then edit the track order.
Cannot play. Connect compliant software and update information.	The clock in the player is not working.	→ Connect the player to CONNECT Player (🔌 “Quick Start Guide”).
Cannot play. Incompatible music file.	<ul style="list-style-type: none"> • The track is not permitted to be played back on the player. • The tracks with a limited playing count are playing. 	→ You cannot play back tracks that are not permitted to be played back on the player.
Cannot play. License expired. Connect compliant software and update information.	The playback license that limits when the track can be played has expired.	→ Tracks with a limited playing time can only be played back within the designated playing period.
Cannot play. Music file damaged. Connect compliant software and transfer again.	The track the player is attempting to play is damaged.	→ Transfer audio data to the player again (🔌 “Quick Start Guide”).
Cannot play. Playback possible in [xxx] hours. (xxx is the number of hours.)	You are trying to play a track before its limited playing period has begun.	→ Tracks with a limited playing time can only be played back within the designated playing period.

Continued ↓

Message	Meaning	Corrective action
Can only do when playing from Trash Bin.	You tried to remove a track from the Trash Bin while the track in the Trash Bin is not playing.	→ Stop playing the Trash Bin, and try again to add the track.
Compliant software must be connected to use this function.	The player does not have the information required for the Artist Link feature.	→ Connect the player to CONNECT Player to transfer track information.
Could not save data. Hard disk writable 5°C – 35°C, 41°F – 95°F.	You are attempting to transfer audio data to the player in an ambient temperature out of the 5 to 35°C (41 to 95°F) range.	→ Operate the player in an environment between 5 and 35°C (41 and 95°F).
Hard Disk not properly initialized. Re-Initialize from Settings.	<ul style="list-style-type: none"> • The player's hard disk is not correctly initialized. • The player's hard disk was initialized from within Windows on a connected computer. • The hard disk of the player has not been initialized because it was changed. 	→ Initialize the hard disk of the player again (ⓘ page 55).
HOLD. Keep pressing HOLD button to unlock the controls.	The HOLD function is on, and the controls of the player cannot be operated.	→ Unlock the controls by pressing and holding the HOLD button (ⓘ page 7). HOLD can be released only when the player is turned on.
Insufficient information. Connect compliant software and transfer information.	You have tried to start playback from the HOME menu by selecting "Playlists," "Play History," or "Favorite 100" when there are no tracks in the player.	→ Transfer audio data to the player (ⓘ "Quick Start Guide).

Continued ↓

Message	Meaning	Corrective action
LOW BATTERY. Please Charge.	The player's battery is running low.	→ Charge the battery (☞ page 56).
Mismatch in system files.	There is mismatch in the system files.	→ Reinitialize the player's hard disk (☞ page 55), and transfer audio data to the player again (☞ "Quick Start Guide").
Music file not transferred. Connect compliant software and transfer music files.	There are no playlists on the player.	→ Use CONNECT Player to create a playlist and transfer it to the player.
No Database Found. Please connect compliant software.	When disconnecting from the computer, there are no tracks transferred to the player, or there is lack of information.	→ Connect the player to the computer again, and then disconnect it. → Transfer audio data to the player from CONNECT Player (☞ "Quick Start Guide").
No playable songs included. Try again after adding songs.	There are no tracks in the list item you are trying to play.	→ Transfer audio data to the player from CONNECT Player (☞ "Quick Start Guide").
No songs. Connect compliant software and transfer songs.	You have tried to start playback from the HOME menu by selecting "Intelligent Shuffle," "Initial Search," "Music Library," or "Now Playing" when there are no tracks in the player.	→ Transfer audio data to the player (☞ "Quick Start Guide").
No songs in Trash Bin.	You have tried to play the Track Bin list when there are no tracks in the Trash Bin.	→ You cannot play the Trash Bin list when no tracks are in the Trash Bin.

Continued ↓

Message	Meaning	Corrective action
Please connect compliant software.	<ul style="list-style-type: none"> • Database is damaged. • The player is connected to software other than CONNECT Player. 	→ Connect the player only to CONNECT Player.
Please play a song to use this function.	You pressed the LINK button when no track was playing.	→ A track must be playing when you press the LINK button.
Please try when Bookmark List is playing.	You are trying to remove a track from a Bookmark list while it is stopped or in paused.	→ You can remove a track from a Bookmark List only while that list is playing.
Sorry, there is a system error (No. [xxx]). (Number appears in parenthesis.)	There is a system error.	→ Write down the number, and consult your nearest Sony dealer.
There are no songs in this Bookmark List. Add songs using Options menu.	You have tried to play a Bookmark List to which no tracks have been added.	→ You cannot play a Bookmark List that has no tracks. Add at least one track to the Bookmark List.
This function is currently unusable. Connect compliant software and transfer information to use.	The player does not have the information necessary to use the Initial search feature.	→ Connect the player to CONNECT Player to transfer track information.
This song already added to this Bookmark List.	The track you are trying to add to the Bookmark List has already been added to that list.	→ A track cannot be added to the same Bookmark List twice.
This song is already in the Trash Bin.	The track you are trying to add to a Trash Bin has been already added to the Trash Bin.	→ You cannot add the same track to the Trash Bin twice.

Continued ↓

Message	Meaning	Corrective action
[xxx] hours remaining on license. Please connect to compliant PC software to update. (xxx is the number of hours remaining.)	The license limiting when the track can be played will expire in xx hours.	→ Connect the player to CONNECT Player to update the license.

Uninstalling CONNECT Player

To uninstall the supplied software from your computer, follow the procedures below.

-
- 1 Click “Start” – “Control Panel.”¹⁾
 - 2 Double-click “Add/Remove Programs.”
 - 3 Click “CONNECT Player” in the “Currently Installed Programs” list, and then click “Change and Remove.”²⁾

Follow the displayed instruction and restart your computer.

The uninstallation is completed when the computer has restarted.

¹⁾ “Settings” – “Control Panel” in the case of Windows 2000.

²⁾ “Change/Remove” in the case of Windows 2000.

Note

- When you install CONNECT Player, OpenMG Secure Module is installed at the same time. Do not delete OpenMG Secure Module since it may be used by other software.

Owner's Record

The model and serial numbers are located on the back of the player. Record the serial number in the space provided below. Refer to these numbers whenever you call upon your Sony dealer regarding this product.

Model No. _____

Serial No. _____

WARNING

To reduce the risk of fire or electric shock, do not expose this apparatus to rain or moisture.

Do not install the appliance in a confined space, such as a bookcase or built-in cabinet.

To reduce the risk of fire, do not cover the ventilation of the apparatus with news papers, tablecloths, curtains, etc. And don't place lighted candles on the apparatus.

To reduce the risk of fire or electric shock, do not place objects filled with liquids, such as vases, on the apparatus.

For Customers in the USA

INFORMATION:

This equipment has been tested and found to comply with the limits for a Class B digital device, pursuant to Part 15 of the FCC Rules. These limits are designed to provide reasonable protection against harmful interference in a residential installation. This equipment generates, uses, and can radiate radio frequency energy and, if not installed and used in accordance with the instructions, may cause harmful interference to radio communications.

However, there is no guarantee that interference will not occur in a particular installation. If this equipment does cause harmful interference to radio or television reception, which can be determined by turning the equipment off and on, the user is encouraged to try to correct the interference by one or more of the following measures:

- Reorient or relocate the receiving antenna.
- Increase the separation between the equipment and receiver.
- Connect the equipment into an outlet on a circuit different from that to which the receiver is connected.
- Consult the dealer or an experienced radio/TV technician for help.

You are cautioned that any changes or modifications not expressly approved in this manual could void your authority to operate this equipment.

Continued ↓

If you have any questions about this product:**Visit:**

www.sony.com/walkmansupport

Contact:

Sony Customer Information Service Center at 1-(866)-456-7669

Write:

Sony Customer Information Services Center
12451 Gateway Blvd.,
Fort Myers, FL 33913

Model NW-A1000/A3000**Declaration of Conformity**

Trade Name: SONY
Model No.: NW-A1000/A3000
Responsible Party: Sony Electronics Inc.
Address: 16450 W. Bernardo Dr,
San Diego, CA 92127
USA
Telephone Number: 858-942-2230

This device complies with Part 15 of the FCC Rules. Operation is subject to the following two conditions: (1) This device may not cause harmful interference, and (2) this device must accept any interference received, including interference that may cause undesired operation.

Continued ↓

For Customers in the USA and Canada

RECYCLING LITHIUM-ION BATTERIES

Lithium-ion batteries are recyclable.

You can help preserve our environment by returning your used rechargeable batteries to the collection and recycling location nearest you.



For more information regarding recycling of rechargeable batteries, call toll free 1-800-822-8837, or visit <http://www.rbrc.org/>.

Caution: Do not handle damaged or leaking Lithium-ion batteries.

Disposal of Old Electrical & Electronic Equipment (Applicable in the European Union and other European countries with separate collection systems)



This symbol on the product or on its packaging indicates that this product shall not be treated as household waste. Instead it shall be handed over to the applicable collection point for the recycling of electrical and electronic equipment. By ensuring this product is disposed of correctly, you will help prevent potential negative consequences for the environment and human health, which could otherwise be caused by inappropriate waste handling of this product. The recycling of materials will help to conserve natural resources. For more detailed information about recycling of this product, please contact your local Civic Office, your household waste disposal service or the shop where you purchased the product.

Applicable accessories: Headphones

For Customers in Russia

Для покупателей в России



Этот знак относится только к адаптеру переменного тока.

Портативный плеер со встроенным жёстким диском

Произведено в Малайзии

Изготовитель: Сони Корпорейшн

Адрес: 6-7-35 Киташинагава, Шинагава-ку,
Токио 141-0001, Япония

Notes on Disposing of the Player

This player has a built-in lithium-ion rechargeable battery. When you dispose of the player, be sure to dispose of it properly.

For disposal information for the NW-A1000, see  page 83.

For disposal information for the NW-A3000, see  page 84.

Some countries may regulate disposal of the battery used to power this product. Please consult with your local authority.

Notes

- Never disassemble the player except when disposing of it.
- Be careful when handling internal metallic components of the player. Pay particular attention to component edges.

Continued 

To remove the built-in rechargeable battery of the NW-A1000

- 1** Remove the strap connector from the back of the player.

Remove it from the side of the strap connector using a small pair of tweezers.

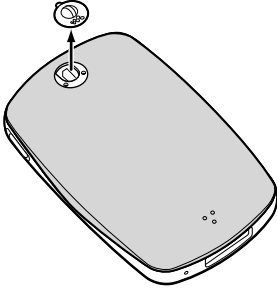

- 2** Slide the back cover of the player down, and then lift up, as shown by the arrow below.

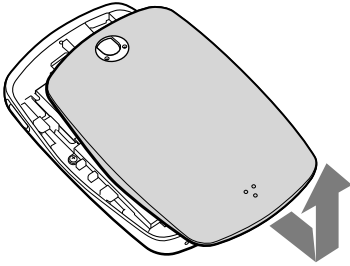

- 3** Remove the two screws at the edges of the player chassis.

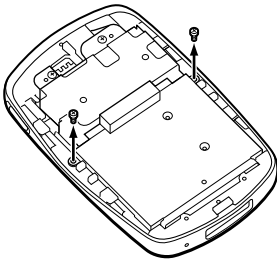

- 4** Remove the cover from the player.

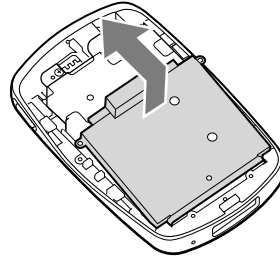

- 5** Remove the two screws at the edge of the battery chassis.

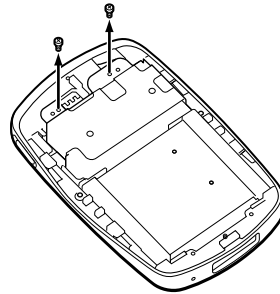

- 6** Pull the cord connecting the battery to the player to separate the battery plug from the connector.

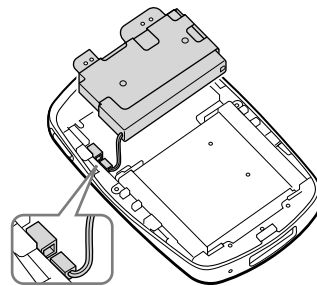

Note

- Leave all metallic parts attached to the battery, and dispose of them along with the battery.

Continued ↓

To remove the built-in rechargeable battery of the NW-A3000

- 1** Remove the screw cover on the back of the player.

Remove it from the side of the screw cover using a small pair of tweezers.

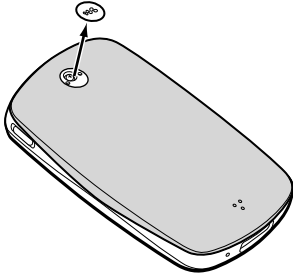

- 2** Remove the two screws behind the cover.

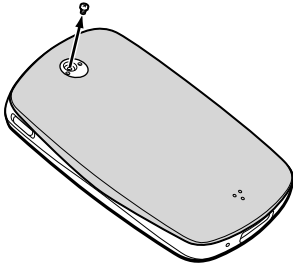

- 3** Slide the back over of the player down, and then lift up, as shown by the arrow below.

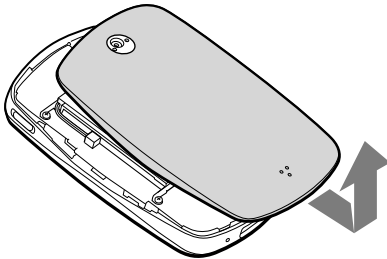

- 4** Remove the four screws at the edges of the player's chassis.

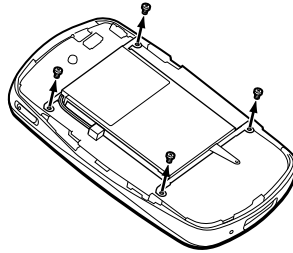

- 5** Remove the battery from the player.

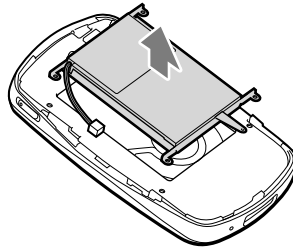

- 6** Pull the cord connecting the battery to the player to separate the battery plug from the connector.

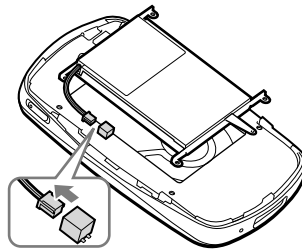

Note

- Leave all metallic parts attached to the battery, and dispose of them along with the battery.

Precautions

On safety

- Do not put any foreign objects in the DC IN jack of the player.
- Be sure not to short-circuit the terminals of the player with other metallic objects.

On installation

- Never use the player where it will be subjected to extremes of light, temperature, moisture or vibration.
- Never wrap the player in anything when it is being used with the AC power adaptor. Heat build-up in the player may cause malfunction or damage.

On heat build-up

Heat may build up in the player while charging if it is used for an extended period of time.

On the headphones

Road safety

Do not use headphones while driving, cycling, or operating any motorized vehicle. It may create a traffic hazard and is illegal in many areas. It can also be potentially dangerous to play at a high volume while walking, especially at pedestrian crossings. You should exercise extreme caution or discontinue use in potentially hazardous situations.

Preventing hearing damage

Avoid using the headphones at a high volume. Hearing experts advise against continuous, loud and extended play. If you experience a ringing in your ears, reduce the volume or discontinue use.

Continued ↓

Caring for others

Keep the volume at a moderate level. This will allow you to hear outside sounds and to be considerate to the people around you.

Warning

If there is lightning when you are using the player, take off the headphones immediately.

On cleaning

- Clean the player's case with a soft cloth, such as cleaning cloth for eyeglasses.
- If the player's case becomes very dirty, clean it with a soft cloth slightly moistened with water or a mild detergent solution.
- Do not use any type of abrasive pad, scouring powder, or solvent, such as alcohol or benzene, as it may mar the finish of the case.
- Be careful not to let water get into the player from the opening near the connector.
- Clean the headphones plug periodically.

If you have any questions or problems concerning the player, consult your nearest Sony dealer.

NOTES

- The recorded music is limited to private use only. Use of the music beyond this limit requires permission of the copyright holders.
- Sony is not responsible for incomplete recording/downloading or damaged data due to problems of the player or computer.

Continued ↓

On software

- Copyright laws prohibit reproducing the software or the manual accompanying it in whole or in part, or renting the software without the permission of the copyright holder.
- In no event will SONY be liable for any financial damage, or loss of profits, including claims made by third parties, arising out of the use of the software supplied with this player.
- In the event a problem occurs with this software as a result of defective manufacturing, SONY will replace it. However, SONY bears no other responsibility.
- The software provided with this player cannot be used with equipment other than that which is so designated.
- Please note that, due to continued efforts to improve quality, the software specifications may be changed without notice.
- Operation of this player with software other than that provided is not covered by the warranty.
- The ability to display the languages on your CONNECT Player will depend on the installed OS on your PC. For better results, please ensure that the installed OS is compatible with the desired language you want to display.
 - We do not guarantee all the languages will be able to be displayed properly on your CONNECT Player.
 - User-created characters and some special characters may not be displayed.
- The explanations in this manual assume that you are familiar with the basic operations of Windows.

For details on the use of your computer and operating system, please refer to the respective manuals.

Continued ↓

On sample audio data

The player is pre-installed with sample audio data so that you can try it out right away. The pre-installed sample audio data is for the purpose of trial listening only, therefore, you cannot transfer it to your computer. To delete this audio data, delete it using CONNECT Player.

Depending on your region, sample audio data may not be pre-installed in the player.

- The recorded music is limited to private use only. Use of the music beyond this limit requires permission of the copyright holders.
- Sony is not responsible for incomplete recording/downloading or damaged data due to problems of the player or computer.
- Depending on the types of the text and characters, the text shown on the player may not be displayed properly on device. This is due to:
 - The capacity of the connected player.
 - The player is not functioning normally.
 - The ID3 TAG information for the track is written in the language or the character that is not supported by the player.

About the customer support Web site

If you have any questions about or issue with this product, visit the following web sites.

For customers in the USA: <http://www.sony.com/walkmansupport/>

For customers in Canada: <http://www.sony.ca/ElectronicsSupport/>

For customers in Europe: <http://www.sonydigital-link.com/DNA/>

For customers in China: <http://service.sony.com.cn/KB/>

For customers in Taiwan: <http://www.twsupport.css.ap.sony.com/>

For customers in Korea: <http://scs.sony.co.kr/walkman/>

For customers in other countries or areas: <http://www.css.ap.sony.com/>

On Copyrights

- CONNECT Player and the CONNECT Player logo are trademarks or registered trademarks of Sony Corporation.
- OpenMG, ATRAC, ATRAC3, ATRAC3plus and their logos are trademarks of Sony Corporation.
- “WALKMAN” is a registered trademark of Sony Corporation to represent Headphone Stereo products.  WALKMAN is a trademark of Sony Corporation.
- Microsoft, Windows, Windows NT and Windows Media are trademarks or registered trademarks of Microsoft Corporation in the United States and/or other countries.
- Adobe and Adobe Reader are trademarks or registered trademarks of Adobe Systems Incorporated in the United States and/or other countries.
- MPEG Layer-3 audio coding technology and patents licensed from Fraunhofer IIS and Thomson.
- CD and music-related data from Gracenote, Inc., copyright © 2000-2004 Gracenote.

Gracenote CDDB® Client Software, copyright 2000-2004 Gracenote. This product and service may practice one or more of the following U.S. Patents: #5,987,525; #6,061,680; #6,154,773, #6,161,132, #6,230,192, #6,230,207, #6,240,459, #6,330,593, and other patents issued or pending. Services supplied and/or device manufactured under license for following Open Globe, Inc. United States Patent 6,304,523. Gracenote and CDDB are registered trademarks of Gracenote.

The Gracenote logo and logotype, and the “Powered by Gracenote” logo are trademarks of Gracenote.

- All other trademarks and registered trademarks are trademarks or registered trademarks of their respective holders. In this manual, TM and ® marks are not specified.

Program ©2005 Sony Corporation

Documentation ©2005 Sony Corporation

Specifications

Audio compression technology

- MPEG-1 Audio Layer-3 (MP3)
- Adaptive Transform Acoustic Coding (ATRAC)

Maximum recordable number of track and time (Approx.)*

	NW-A1000		NW-A3000	
	Tracks	Time	Tracks	Time
48 kbps	4,000	266 hours, 40 minutes	13,000	866 hours, 40 minutes
64 kbps	3,000	200 hours	10,000	666 hours, 40 minutes
96 kbps	2,000	133 hours, 20 minutes	6,700	466 hours, 40 minutes
128 kbps	1,500	100 hours	5,000	333 hours, 20 minutes
132 kbps	1,500	100 hours	4,900	326 hours, 40 minutes
160 kbps	1,200	80 hours	4,000	266 hours, 40 minutes
192 kbps	1,000	66 hours, 40 minutes	3,300	220 hours
256 kbps	750	50 hours	2,500	166 hours, 40 minutes
320 kbps	600	40 hours	2,000	133 hours, 20 minutes

* When transferring four-minute tracks

Supported bit rates

MP3: 32 to 320 kbps (supports variable bite rate (VBR))

ATRAC: 48/64/66 (ATRAC3)*/96/105 (ATRAC3)*/128/132 (ATRAC3)/160/192/256/320 kbps

* You cannot record CDs in ATRAC3 format at 66 or 105 kbps using CONNECT Player.

Sampling frequencies

MP3: 44.1 kHz

ATRAC: 44.1 kHz

S/N Ratio

Headphones: 84 dB or more

LINE OUT: 96 dB or more

Frequency response

20 to 20,000 Hz (single signal measurement during playback)

Output

🔊 (headphones)/LINE OUT*: Stereo minijack/195 mV (10 Ω)

* The jack is used for both headphones and LINE OUT.

Operating temperature

5 to 35°C (41 to 95°F)

Power source

Built-in rechargeable battery DC IN 5 V

AC power adaptor: DC IN 5 V

Continued ↓

Battery life (continuous playback)

In ATRAC format (48 kbps), Display 15 sec

NW-A1000: Approx. 20 hours

NW-A3000: Approx. 35 hours

In ATRAC format (128 kbps), Display 15 sec

NW-A1000: Approx. 17 hours

NW-A3000: Approx. 29 hours

In MP3 format (128 kbps), Display 15 sec

NW-A1000: Approx. 17 hours

NW-A3000: Approx. 29 hours

Dimension (w/h/d)

NW-A1000:

Approx. 55.0 × 88.1 × 18.7 mm (11.5 mm at thinnest point)*

(2 1/4 × 3 1/2 × 3/4 inches) (15/32 inches at thinnest point)*

NW-A3000:

Approx. 65.2 × 104.2 × 21.4 mm (13.5 mm at thinnest point)*

(2 5/8 × 4 1/8 × 27/32 inches) (9/16 inches at thinnest point)*

* Not including projecting parts.

Dimension including projecting part (w/h/d)

NW-A1000:

Approx. 55.0 × 88.1 × 18.7 mm

(2 1/4 × 3 1/2 × 3/4 inches)

NW-A3000:

Approx. 65.2 × 104.2 × 21.4 mm

(2 5/8 × 4 1/8 × 27/32 inches)

Mass

NW-A1000 (The player):

Approx. 109 g (3.9 oz)

NW-A3000 (The player):

Approx. 182 g (6.5 oz)

Design and specifications are subject to change without notice.

US and foreign patents licensed from Dolby Laboratories.

Optional Accessories

The following optional accessories are available for the player:

- Remote control for NW-A1000/A3000
RM-NWS1
- Remote control
RM-MC35ELK*
* The remote control may not be available in all countries and regions.
- Charging cradle
BCR-NWU1
- Leather carrying case
CKM-NWA1000 (for the NW-A1000)
CKM-NWA3000 (for the NW-A3000)
- Soft carrying case
CKS-NWA1000 (for the NW-A1000)
CKS-NWA3000 (for the NW-A3000)

Your dealer may not carry some of the accessories listed above. Please ask the dealer for detailed information about the accessories available in your country or region.

Notes

- Some features of the remote control (RM-MC35ELK) may not be compatible with your player model.
- For detail on other optional accessories, visit one of the following Web sites.
For customers in the USA: <http://www.sony.com/walkmansupport/>
For customers in Canada: <http://www.sony.ca/ElectronicsSupport/>
For customers in Europe: <http://www.sonydigital-link.com/DNA/>
For customers in China: <http://service.sony.com.cn/KB/>
For customers in Taiwan: <http://www.twsupport.css.ap.sony.com/>
For customers in Korea: <http://scs.sony.co.kr/walkman/>
For customers in other countries or areas: <http://www.css.ap.sony.com/>

Index

Symbols

5-way button	7, 8
⏮ 1 (Custom 1)	45
⏮ 2 (Custom 2)	45
⏮ H (Heavy)	45
⏮ J (Jazz)	45
⏮ P (Pop)	45
☆Rating	41
↺ (Repeat)	26
↺ 1 (Repeat 1 song)	26
SHUF (Shuffle)	26
↺SHUF (Shuffle&Repeat)	26
⏮ U (Unique)	45

A

Adobe Reader	3
Artist Link	42
Audio Output	49
AVLS (Vol. Limit)	47

B

B.mark List 1-5	19
BACK button	5, 7, 8
Beep	48
Bit rate	59
Bookmark List	31
Add	31
Change icon	37
Rearrange	36
Remove	34
Remove all	35
Brightness setting	51

C

Charge the battery	56
CONNECT Player	3, 68
Custom	45, 46

D

Delete tracks	38
---------------------	----

F

Favorite 100	19, 20
Firmware	64
Format	59

H

Heavy	45
HOLD button	7
HOME Menu	5

I

Initialize Disk	55
Initial Search	17
Intelligent Shuffle	22

J

Jazz	45
------------	----

L

Language	53
LINK button	7, 42

M

Multiple connector	7, 56
Music Library	10
My Favorite Shuffle	22

N

Normal	26
Now Playing Screen	27

Continued ↓

O

OPTION button.....7, 28

P

Player information52
 Playlist 18, 19
 Playing18
 Playlist types.....19
 Playlists19
 Play History21
 Play Mode25, 26
 Pop45

R

Rate Tracks41
 Recent Transfers.....16
 Release Date.....15
 Remaining battery power57
 RESET button7, 65
 Reset to Factory setting.....54

S

Search for tracks 10
 By album.....11
 By artist.....12
 By dates played.....21
 By genre.....13
 By initial letter17
 By ☆Rating14
 By release year.....15
 By track name10
 From albums recently transferred16
 From playlists18
 Serial number52
 Settings.....44
 AVLS (Vol. Limit)47
 Beep48
 Brightness51
 Display50
 Language53
 Sound Quality44

Shuffle All24
 Shuffle play22
 My Favorite Shuffle22
 Shuffle All.....24
 Time Machine Shuffle23
 Sound quality44

T

Time Machine Shuffle.....23
 Total number of tracks52
 Track Information62
 Trash Bin.....19, 38
 Restore39
 Restore all40
 Turn off the player manually58

U

Uninstall CONNECT Player78
 Unique.....45

V

Version52
 VOL+/- switch7

W

Wide Range.....43
 Windows Explorer63