

SONY®

Digital Still Camera

Operating Instructions

Before operating the unit, please read this manual thoroughly, and retain it for future reference.

Owner's Record

The model and serial numbers are located on the bottom. Record the serial number in the space provided below. Refer to these numbers whenever you call upon your Sony dealer regarding this product.

Model No. DSC-F88

Serial No. _____

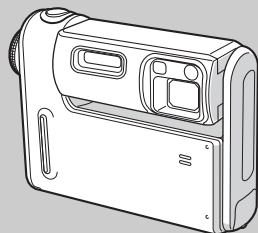

DSC-F88

Cyber-shot



MEMORY STICK™



2-023-044-11(1)

Getting started _____

Shooting still images _____

Viewing still images _____

Deleting still images _____

Before advanced operations _____

Advanced still image shooting _____

Advanced still image viewing _____

Still image editing _____

Still image printing
(PictBridge printer) _____

Enjoying movies _____

Enjoying images on your computer _____

Troubleshooting _____

Additional information _____

Index _____

WARNING

To prevent fire or shock hazard, do not expose the unit to rain or moisture.

For the Customers in the U.S.A.

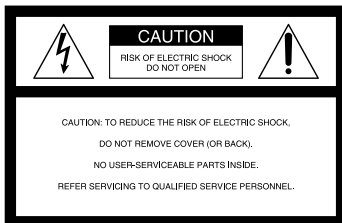

This symbol is intended to alert the user to the presence of uninsulated “dangerous voltage” within the product’s enclosure that may be of sufficient magnitude to constitute a risk of electric shock to persons.



This symbol is intended to alert the user to the presence of important operating and maintenance (servicing) instructions in the literature accompanying the appliance.

If you have any questions about this product, you may call:

Sony Customer Information Services Center
1-800-222-SONY (7669)

The number below is for the FCC related matters only.

Regulatory Information

Declaration of Conformity

Trade Name: SONY
Model No.: DSC-F88
Responsible Party: Sony Electronics Inc.
Address: 16450 W. Bernardo Dr,
San Diego, CA 92127
U.S.A.
Telephone No.: 858-942-2230

This device complies with Part 15 of the FCC Rules. Operation is subject to the following two conditions: (1) This device may not cause harmful interference, and (2) this device must accept any interference received, including interference that may cause undesired operation.

CAUTION

You are cautioned that any changes or modifications not expressly approved in this manual could void your authority to operate this equipment.

Note:

This equipment has been tested and found to comply with the limits for a Class B digital device, pursuant to Part 15 of the FCC Rules. These limits are designed to provide reasonable protection against harmful interference in a residential installation. This equipment generates, uses, and can radiate radio frequency energy and, if not installed and used in accordance with the instructions, may cause harmful interference to radio communications. However, there is no guarantee that interference will not occur in a particular installation. If this equipment does cause harmful interference to radio or television reception, which can be determined by turning the equipment off and on, the user is encouraged to try to correct the interference by one or more of the following measures:

- Reorient or relocate the receiving antenna.
- Increase the separation between the equipment and receiver.
- Connect the equipment into an outlet on a circuit different from that to which the receiver is connected.
- Consult the dealer or an experienced radio/TV technician for help.

The supplied interface cable must be used with the equipment in order to comply with the limits for a digital device pursuant to Subpart B of Part 15 of FCC Rules.

For the Customers in the U.S.A. and Canada

RECYCLING LITHIUM-ION BATTERIES

Lithium-Ion batteries are recyclable.

You can help preserve our environment by returning your used rechargeable batteries to the collection and recycling location nearest you.



For more information regarding recycling of rechargeable batteries, call toll free 1-800-822-8837, or visit <http://www.rbrcc.org/>

Caution: Do not handle damaged or leaking Lithium-Ion batteries.



Notice for the customers in the United Kingdom

A moulded plug complying with BS 1363 is fitted to this equipment for your safety and convenience.

Should the fuse in the plug supplied need to be replaced, a fuse of the same rating as the supplied one and approved by ASTA or BSI to BS 1362, (i.e., marked with  or  mark) must be used.

If the plug supplied with this equipment has a detachable fuse cover, be sure to attach the fuse cover after you change the fuse. Never use the plug without the fuse cover. If you should lose the fuse cover, please contact your nearest Sony service station.

Attention for the Customers in Europe

This product has been tested and found compliant with the limits sets out in the EMC Directive for using connection cables shorter than 3 meters (9.8 feet).

Attention

The electromagnetic field at the specific frequencies may influence the picture and sound of this camera.

Notice

If static electricity or electromagnetism causes data transfer to discontinue midway (fail), restart the application or disconnect and connect the USB multi cable again.

“Memory Stick”



For the Customers in the U.S.A.

THIS DEVICE COMPLIES WITH PART 15 OF THE FCC RULES. OPERATION IS SUBJECT TO THE FOLLOWING TWO CONDITIONS:

- (1) THIS DEVICE MAY NOT CAUSE HARMFUL INTERFERENCE, AND
- (2) THIS DEVICE MUST ACCEPT ANY INTERFERENCE RECEIVED, INCLUDING INTERFERENCE THAT MAY CAUSE UNDESIRE OPERATION.

For the Customers in Canada

THIS CLASS B DIGITAL APPARATUS COMPLIES WITH CANADIAN ICES-003.

Notice

Certain countries and regions may regulate disposal of the battery used to power this product. Please consult with your local authority.

Read this first

Trial recording

Before you record one-time events, you may want to make a trial recording to make sure that the camera is working correctly.

No compensation for contents of the recording

Contents of the recording cannot be compensated for if recording or playback is not possible due to a malfunction of your camera or recording medium, etc.

Back up recommendation

To avoid the potential risk of data loss, always copy (back up) data to a disk.

Notes on image data compatibility

- This camera conforms with the Design rule for Camera File system universal standard established by the JEITA (Japan Electronics and Information Technology Industries Association).
- Playback of images recorded with your camera on other equipment and playback of images recorded or edited with other equipment on your camera are not guaranteed.

Precaution on copyright

Television programs, films, video tapes, and other materials may be copyrighted. Unauthorized recording of such materials may be contrary to the provision of the copyright laws.

Do not shake or strike the camera

In addition to malfunctions and inability to record images, this may render the “Memory Stick” unusable or image data breakdown, damage or loss may occur.

LCD screen, LCD finder (only models with an LCD finder) and lens

- The LCD screen and the LCD finder are manufactured using extremely high-precision technology so over 99.99% of the pixels are operational for effective use. However, there may be some tiny black points and/or bright points (white, red, blue or green in color) that constantly appear on the LCD screen and the LCD finder. These points are normal in the manufacturing process and do not affect the recording in any way.
- Be careful when placing the camera near a window or outdoors. Exposing the LCD screen, the finder or the lens to direct sunlight for long periods may cause malfunctions.
- Do not press the LCD screen hardy. The screen may be uneven and that may cause a malfunction.
- Images may be trailed on the LCD screen in a cold location. This is not a malfunction.

Remove dirt from the surface of the flash

If the dirt changes color or sticks to the surface of the flash due to the heat of the flash, sufficient light may not be emitted.

Do not get the camera wet

When taking pictures outdoors in the rain or under similar conditions, be careful not to get the camera wet. If water gets inside of the camera, it may cause the camera to malfunction, sometimes beyond repair. If moisture condensation occurs, see page 119 and follow the instructions on how to remove it before using the camera.

Do not expose the camera to sand or dust

Using the camera in sandy or dusty locations may cause a malfunction.

Do not aim the camera at the sun or other bright light

This may cause irrecoverable damage to your eyes or the malfunction of your camera.

Note on locations where you can use the camera

Do not use the camera near a location that generates strong radio waves or emits radiation. The camera may not be able to record or play back properly.

Carl Zeiss lens

This camera is equipped with a Carl Zeiss lens which is capable of reproducing sharp images with excellent contrast. The lens for this camera has been produced under a quality assurance system certified by Carl Zeiss in accordance with the quality standards of Carl Zeiss in Germany.

The pictures used in this manual

The photographs used as examples of pictures in this manual are reproduced images, and are not actual images shot using this camera.

Trademarks

- **Cyber-shot** is a trademark of Sony Corporation.
- “Memory Stick,” , “Memory Stick PRO,” **MEMORY STICK PRO**, “Memory Stick Duo,” **MEMORY STICK DUO**, “Memory Stick PRO Duo,” **MEMORY STICK PRO DUO**, “MagicGate,” **MAGICGATE** are trademarks of Sony Corporation.
- “InfoLITHIUM” is a trademark of Sony Corporation.
- Picture Package is a trademark of Sony Corporation.
- Microsoft, Windows, Windows Media, and DirectX are either registered trademarks or trademarks of Microsoft Corporation in the United States and/or other countries.
- Macintosh, Mac OS, QuickTime, iMac, iBook, PowerBook, Power Mac, and eMac are trademarks or registered trademarks of Apple Computer, Inc.
- Macromedia and Flash are trademarks or registered trademarks of Macromedia, Inc. in the United States and/or other countries.
- Intel, MMX, and Pentium are trademarks or registered trademarks of Intel Corporation.
- In addition, system and product names used in this manual are, in general, trademarks or registered trademarks of their respective developers or manufacturers. However, the TM or © marks are not used in all cases in this manual.

Table of contents

Read this first	4
Identifying the parts	8
Mode dial	10

Getting started

Charging the battery pack	11
Using the AC Adaptor	14
Using your camera abroad	14
Turning your camera on/off	15
How to use the control button	16
Setting the date and time	17

Shooting still images

Inserting and removing a “Memory Stick”	19
Setting the still image size	20
Image size and quality	21
Basic still image shooting	
– Using auto mode	23
Checking the last image shot	
– Quick Review	25
Using the zoom feature	25
Shooting close-ups – Macro	27
Using the self-timer	28
Rotating the lens	
– Mirror mode	29
Selecting a flash mode	29
Shooting images with the finder	32

Inserting the date and time on a still image	33
Shooting according to scene conditions	
– Scene Selection	34

Viewing still images

Viewing images on the LCD screen of your camera	38
Viewing images on a TV screen	40

Deleting still images

Deleting images	42
Formatting a “Memory Stick”	44

Before advanced operations

How to setup and operate your camera ..	46
Changing menu settings	46
Changing items in the SET UP screen	47
Deciding the still image quality	47
Creating or selecting a folder	48
Creating a new folder	48
Selecting the recording folder	48

Advanced still image shooting

Choosing an auto focus method	49
Choosing a focus range finder frame	
– AF range finder	49
Choosing a focus operation	
– AF Mode	50
Setting the distance to the subject	
– Focus preset	51
Shooting with manual shutter speed and aperture settings	
– Manual Exposure	52
Adjusting the exposure	
– EV adjustment	55
Displaying a histogram	56
Selecting the metering mode	57
Adjusting color tones	
– White Balance	58
Adjusting the flash level	
– Flash Level	59
Shooting images in succession	60
Shooting in Multi Burst mode	
– Multi Burst	61
Shooting with special effects	
– Picture Effect	62
Using the Cyber-shot Station	62

Advanced still image viewing

Selecting the folder and playing back images – Folder	63
Enlarging a portion of a still image.....	64
Enlarging an image	
– Playback zoom.....	64
Recording an enlarged image	
– Trimming.....	65
Playing back successive images	
– Slide show.....	65
Rotating still images – Rotate	66
Playing back images shot in Multi Burst mode	67
Playing back continuously	67
Playing back frame by frame	67

Still image editing

Protecting images – Protect.....	69
Changing image size – Resize.....	70
Choosing images to print	
– Print (DPOF) mark	71

Still image printing (PictBridge printer)

Connecting to a PictBridge compliant printer.....	73
Printing images.....	74

Printing index-images.....	76
----------------------------	----

Enjoying movies

Shooting movies	80
Viewing movies on the LCD screen.....	81
Deleting movies	82
Cutting movies.....	83

Enjoying images on your computer

Copying images to your computer	
– For Windows users.....	85
Installing the USB driver.....	86
Connecting the camera to your computer.....	87
Copying images.....	88
Viewing the images on your computer.....	90
Image file storage destinations and file names.....	91
Viewing an image previously copied to a computer.....	93
Installing “Picture Package”.....	93
Copying images using “Picture Package”.....	95
Using “Picture Package”	96
Copying images to your computer	
– For Macintosh users	97

Using “ImageMixer VCD2”	98
-------------------------------	----

Troubleshooting

Troubleshooting	100
Warnings and messages	110
Self-diagnosis display	
– If a code starting with an alphabet letter appears	112

Additional information

The number of images that can be saved/shooting time	113
Menu items.....	114
SET UP items	117
Precautions	119
The “Memory Stick”	120
The “InfoLITHIUM” battery pack.....	121
Specifications	122
The LCD screen	124

Index

Index.....	128
------------	-----

Identifying the parts

See the pages in parentheses for details of operation.

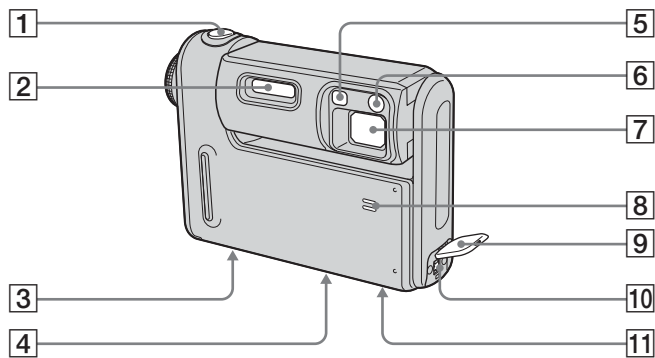

1 Shutter button (24)

2 Flash (29)

3 Multi connector (bottom surface)

4 Tripod receptacle (bottom surface)

5 Finder window

6 Self-timer lamp (28)/
AF illuminator (31, 117)

7 Lens

8 Microphone

9 DC IN jack cover (11, 14)

10 DC IN jack (11, 14)

11 Speaker (bottom surface)

- Use a tripod with a screw length of less than 5.5 mm (7/32 inch). You will be unable to firmly secure the camera to tripods having longer screws, and may damage the camera.

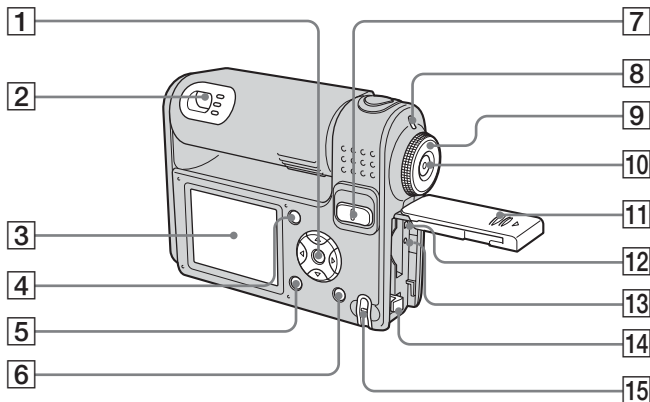

1 Control button

Menu on: ▲/▼/◀/▶/● (16)

Menu off: ⚡/📷/📷/📷 (29/28/25/27)

Mode dial “M”: Shutter speed/
aperture value (52)

2 Finder (32)

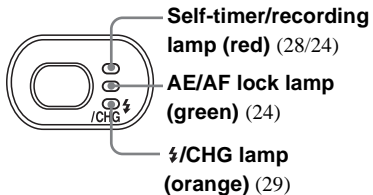

3 LCD screen

For details on the items on the LCD screen,
see pages 124 to 127.

4 📷 (Display/LCD on/off) button
(32)

5 MENU button (46, 114)

6 📷 / 🗑️ (Image Size/Delete)
button (20, 42)

7 For shooting: Zoom (W/T)
buttons (25)

For viewing: 🔍 / 🔍 (Playback
zoom) buttons (64)/📷 (Index)
button (39)

8 POWER lamp (15)

9 Mode dial (10, 114)

10 POWER button (15)

11 Battery/“Memory Stick” cover

12 Access lamp (19)

13 RESET button (100)

14 Battery eject lever (11)

15 Hook for wrist strap

Attaching the wrist strap

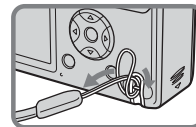

Mode dial

Before using your camera, set the desired mark on the mode dial to .

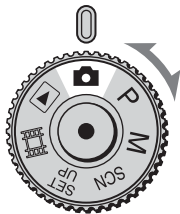

(Auto adjustment mode)

The focus, exposure and white balance are automatically adjusted to allow easy shooting. The image quality is set to [Fine] (page 47).

P (Program auto shooting)

Shooting adjustment is automatically carried out just as in the auto adjustment mode. However, you can intentionally adjust the focus, etc. In addition, you can set the desired functions using the menu (pages 46 and 114).

M (Manual exposure shooting)

You can manually adjust the shutter speed and the aperture value (page 52). In addition, you can set the desired shooting functions using menus (pages 46 and 114).

SCN (Scene Selection)

You can easily shoot an effective photo based on the scene conditions in the scene (page 34). In addition, you can set the desired shooting functions using menus (pages 46 and 114).

SET UP (Set up)

You can change the settings of the camera (pages 17 and 47).

(Movie shooting)

You can shoot movies (page 80).

(Playback/editing)

You can play back or edit still images or movies (pages 38, 63, 69 and 81).

Charging the battery pack

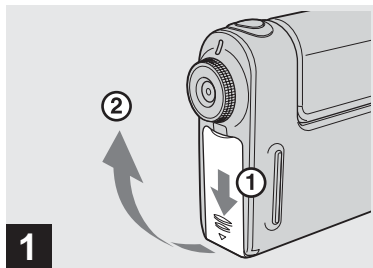

- ➔ **Open the battery/"Memory Stick" cover.**

Slide the cover in the direction of the arrow.

- **Be sure to turn off your camera when charging the battery pack (page 15).**
- Your camera operates with the "InfoLITHIUM" NP-FR1 battery pack (R type) (supplied). You can use only R type battery pack (page 121).

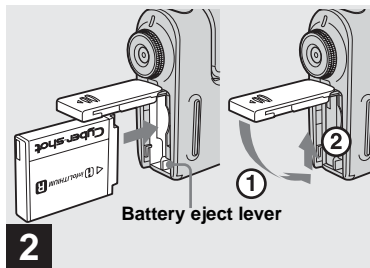

- ➔ **Install the battery pack, then close the battery/"Memory Stick" cover.**

Make sure the battery pack is firmly inserted all the way, then close the cover.

Battery insertion slot

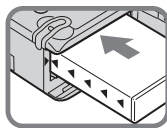

Insert the battery pack so that tip of the ▲ marks on the side of the battery pack face the tip of the ▲ mark on the battery insertion slot.

- The battery pack is easily inserted by pushing the battery eject lever at the front of the battery compartment toward the front of the camera.

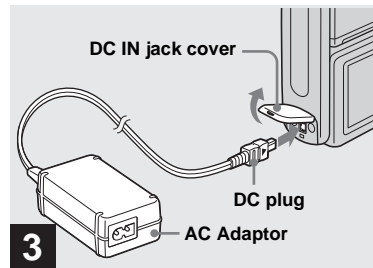

- ➔ **Open the DC IN jack cover and connect the AC Adaptor (supplied) to the DC IN jack of your camera.**

Open the cover in the arrow direction as illustrated above. Connect the DC plug with the ▲ mark facing the LCD screen side.

- Do not short the DC plug of the AC Adaptor with a metallic object, as this may cause malfunction.
- Clean the DC plug of the AC Adaptor with a dry cotton bud. Do not use the dirty plug. Use of the dirty plug may not properly charge the battery pack.

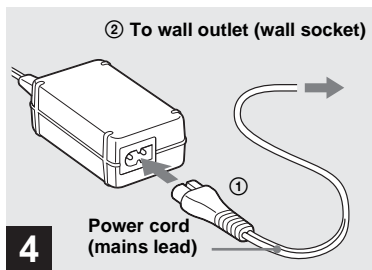

- 4** → Connect the power cord (mains lead) to the AC Adaptor and to a wall outlet (wall socket).

The $\text{⚡}/\text{CHG}$ lamp lights up when charging begins, and goes off when charging is completed.

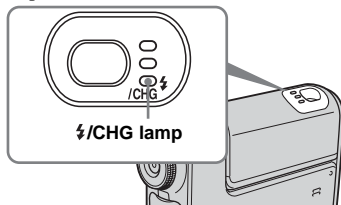

- After charging the battery pack, disconnect the AC Adaptor from the DC IN jack of your camera.

To remove the battery pack

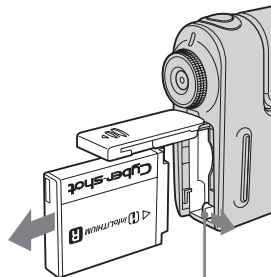

Battery eject lever

Open the battery/“Memory Stick” cover. Slide the battery eject lever in the direction of the arrow, and remove the battery pack.

- Be careful not to drop the battery pack when removing it.

Battery remaining indicator

The battery remaining indicator on the LCD screen shows the remaining shooting or viewing time.

Remaining indicator



Remaining time

- When you switch the LCD screen on/off, it takes about one minute for the correct battery remaining time to appear.
- The displayed time remaining may not be correct under certain circumstances or conditions.

Charging time

Approximate time to charge a completely discharged battery pack using the AC Adaptor at a temperature of 25°C (77°F).

Battery pack	Charging time (min.)
NP-FR1 (supplied)	Approx. 200

- The charging time may become longer under certain circumstances or conditions.

Number of images and battery life that can be recorded/ viewed

The tables show the approximate number of images and the battery life that can be recorded/viewed when you shoot images in normal mode with a fully charged battery pack (supplied) at a temperature of 25°C (77°F). The numbers of images that can be recorded or viewed take into account changing the “Memory Stick” as necessary. Note that the actual numbers may be less than indicated depending on the conditions of use.

- The battery capacity decreases little by little as you use it more and more, and as time passes (page 121).

Shooting still images

Under the average conditions¹⁾

Image size	NP-FR1 (supplied)		
	LCD screen	No. of images	Battery life (min.)
5M	On	Approx. 330	Approx. 165
	Off	Approx. 420	Approx. 210
VGA (E-Mail)	On	Approx. 330	Approx. 165
	Off	Approx. 420	Approx. 210

1) Shooting in the following situations:

-  (P. Quality) is set to [Fine]
- Shooting one time every 30 seconds
- The zoom is switched alternately between the W and T ends
- The flash strobes once every two times
- The power turns on and off once every ten times
- [AF Mode] is set to [Single] in the SET UP settings

The measurement method is based on CIPA standard. (CIPA: Camera & Imaging Products Association)

Viewing still images²⁾

Image size	NP-FR1 (supplied)	
	No. of images	Battery life (min.)
5M	Approx. 8000	Approx. 400
VGA (E-Mail)	Approx. 8000	Approx. 400

2) Viewing single images in order at about three second intervals

Shooting movies³⁾

NP-FR1 (supplied)	
LCD screen On	LCD screen Off
Approx. 180 min.	Approx. 250 min.

3) Shooting movies continuously with the image size [160]

- The number of images and the battery life that can be recorded/viewed are decreased under the following conditions:
 - The surrounding temperature is low
 - The flash is used
 - The camera has been turned on and off many times
 - The zoom is used frequently
 - [LCD Backlight] is set to [Bright] in the SET UP settings
 - [AF Mode] is set to [Monitor]
 - The battery power is low

Using the AC Adaptor

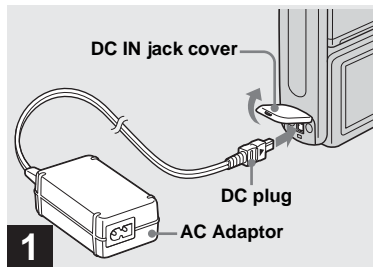

- ➔ **Open the DC IN jack cover, then connect the AC Adaptor (supplied) to the DC IN jack of the camera.**

Open the cover in the arrow direction as illustrated above. Connect the DC plug with the ▲ mark facing the LCD screen side.

- Connect the AC Adaptor to an easily accessible wall outlet (wall socket) close by. If some trouble occurs while using the adaptor, immediately shut off the power by disconnecting the plug from the wall outlet (wall socket).

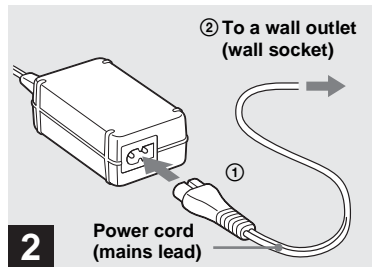

- ➔ **Connect the power cord (mains lead) to the AC Adaptor and to a wall outlet (wall socket).**

- When you have finished using the AC Adaptor, disconnect it from the DC IN jack of the camera and from a wall outlet (wall socket).
- The set is not disconnected from the AC power source (mains) as long as it is connected to the wall outlet (wall socket), even if the unit itself has been turned off.

Using your camera abroad

Power sources

You can use your camera in any country or region with the AC Adaptor (supplied) within 100 V to 240 V AC, 50/60 Hz. Use a commercially available AC plug adaptor [a], if necessary, depending on the design of the wall outlet (wall socket) [b].

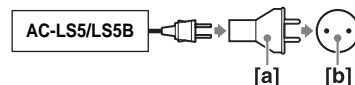

- Do not use an electrical transformer (travel converter), as this may cause a malfunction.

Turning your camera on/off

There are following two ways to turn on the camera.

Press POWER.

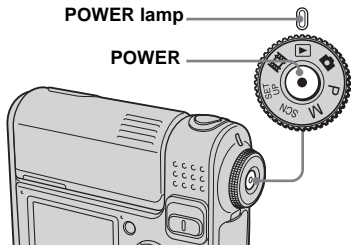

The POWER lamp lights in green and the power is on. When you turn on the camera for the first time, the Clock Set screen appears (page 17).

To turn off the power

Press POWER again, the POWER lamp goes out, and the camera turns off.

Rotate the lens portion.

Rotating the lens portion in the arrow direction turns on the camera. To turn off the power, rotate it back.

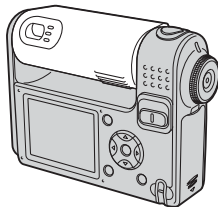
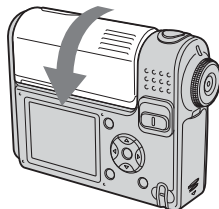

The Auto Power Off function

If no tasks are performed for about three minutes when shooting, viewing images, or setting up the camera while using the battery pack, power is automatically shut off to preserve battery power.

However, in the following circumstances, even if the battery pack is being used to power the camera, the Auto Power Off function will not work.

- Movies are being played back
- A slide show is being shown
- The USB multi cable or the A/V multi cable is connected to the multi connector

How to use the control button

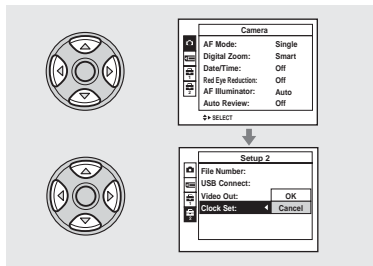

To change the current settings of the camera, bring up the menu or the SET UP screen (pages 46 and 47), and use the control button to make the changes.

When setting up the menu, press ▲/▼/◀/▶ to select the item or the setting and make the setting.

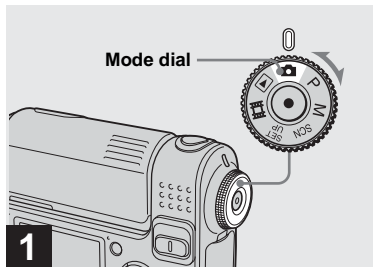

When setting up the SET UP, press ▲/▼/◀/▶ to select the item or the setting and press ● to make the setting.

Setting the date and time



➔ Set the mode dial to .

- To set the time and the date again, set the mode dial to **SET UP**, select **[Clock Set]** in  (**Setup 2**) (pages 47 and 118), then proceed from Step **3**.

- You can carry out this operation even when the mode dial is set to P, M, SCN,  or .

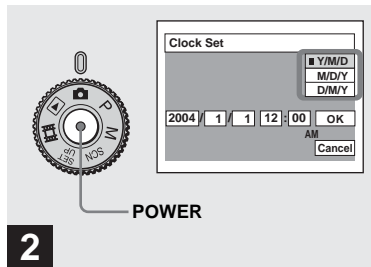

➔ Press **POWER** to turn on the power.

The POWER lamp lights in green and the Clock Set screen appears on the LCD screen.

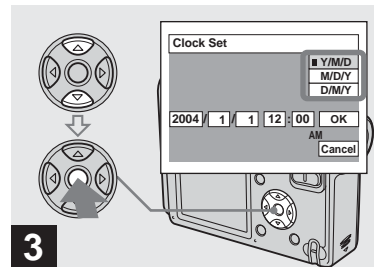

➔ Select the desired date format with **▲/▼** on the control button, then press **●**.

You can select from [Y/M/D] (year/month/day), [M/D/Y], and [D/M/Y].

- If the rechargeable button battery, which provides the power for saving the time data, is ever fully discharged (page 120), the Clock Set screen will appear again. When this happens, reset the date and time by starting from Step **3** above.

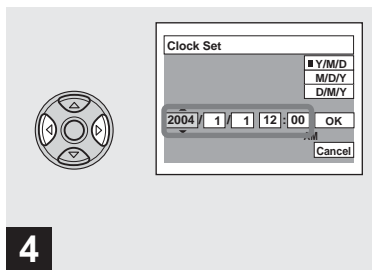

4 → Select the year, month, day, hour, or minute item you want to set with ◀/▶ on the control button.

▲ is shown above and ▼ is shown below the selected item.

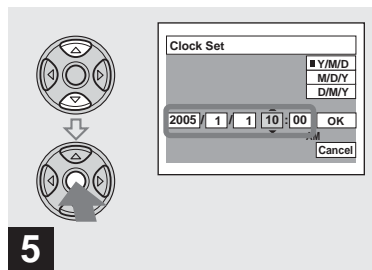

5 → Set the desired numerical value with ▲/▼ on the control button, then press ●.

After setting the current numerical value, set the next item. Repeat Steps **4** and **5** until all of the items have been set.

- If you select [D/M/Y] in Step **3**, set the time on a 24- hour cycle.
- 12:00 AM stands for midnight and 12:00 PM stands for noon.

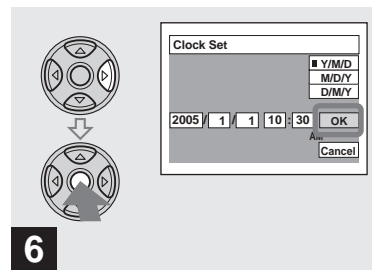

6 → Select [OK] with ▶ on the control button, then press ●.

The date and time are set and the clock will start to keep time.

- To cancel the setting process, select [Cancel], then press ●.

Inserting and removing a "Memory Stick"

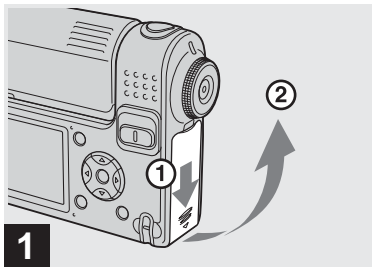

➔ **Open the battery/"Memory Stick" cover.**

Slide the cover in the direction of the arrow.

- For details on "Memory Stick," see page 120.

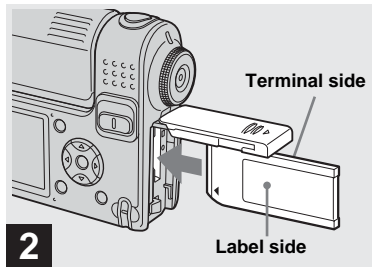

➔ **Insert the "Memory Stick."**

Insert the "Memory Stick" all the way in until it clicks as shown in the illustration.

- Whenever you insert a "Memory Stick," push it as far as it can go. If you do not insert it correctly, a proper recording or playback may not be carried out.

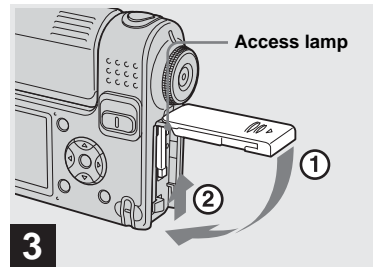

➔ **Close the battery/"Memory Stick" cover.**

To remove the "Memory Stick"

Open the battery/"Memory Stick" cover, then push the "Memory Stick" to pop it out.

- **Whenever the access lamp is lit, the camera is recording or reading out an image. Never open the battery/"Memory Stick" cover or turn off the power at this time. The data may be corrupted.**

Setting the still image size

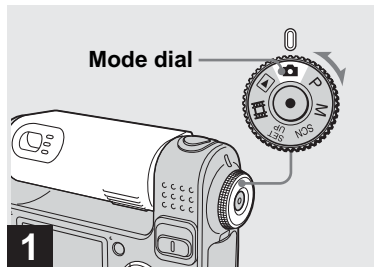

➔ **Set the mode dial to , and rotate the lens portion to turn on your camera.**

- You can carry out this operation even when the mode dial is set to P, M or SCN.

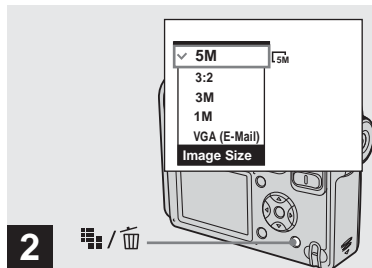

➔ **Press  (Image Size).**

The Image Size setup item appears.

- For more information about the image size, see page 21.

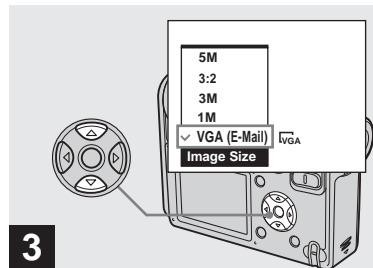

➔ **Select the desired image size with  on the control button.**

The image size is set.

After the setting is completed, press  (Image Size). The Image Size setup item disappears from the LCD screen.

- This setting is maintained even when the power is turned off.

Image size and quality

You can choose image size (number of pixels) and image quality (compression ratio) based on the kind of images you want to shoot. The image size is shown by the number of pixels (dots) (horizontal \times vertical), which compose an image. For example, a 5M (2592 \times 1944) size image indicates that there are 2,592 pixels horizontally 1,944 vertically. The larger the number of pixels, the larger the image size. You can select an image quality level from Fine (high quality) or Standard.

Each has a different compression ratio.

When you select Fine and make the image size larger, you get better quality. However, the amount of data needed to preserve your image is larger and the number of images recordable in the “Memory Stick” is fewer. Choose an image size and quality level appropriate to the kind of images you want to shoot by checking the table below.

¹⁾The default setting is [5M]. This size can give the highest image quality using the camera.

²⁾This option records images in a horizontal to vertical proportion of 3:2 to match the size of the print paper used or postcards.

Short description of the image size

The following illustration shows a brief image using the maximum image size and the minimum one.

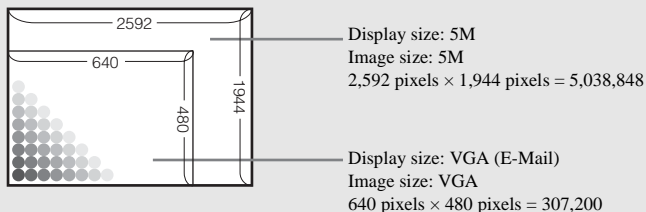

Examples based on the image size and image quality

Image size		Examples
5M ¹⁾ (2592 \times 1944)	Larger ↑ ↓ Smaller	<ul style="list-style-type: none">• For saving important images, printing A4 size or fine A5 size images.• For printing postcard size images.• For shooting a lot of images.• For attaching images to e-mail or creating home pages.
3:2 ²⁾ (2592 \times 1728)		
3M (2048 \times 1536)		
1M (1280 \times 960)		
VGA (E-Mail) (640 \times 480)		

Image quality		Examples
Fine	Low compression (looks better)	<ul style="list-style-type: none"> To shoot or print with better quality. To shoot more images.
Standard	High compression (normal)	

- When the images recorded using other Sony devices are played back, the image size indication may be different from the actual image size.
- When the images are viewed on the LCD screen of the camera, they all look the same size.
- Number of shooting images can differ from these values according to shooting conditions.
- When the remaining number of images recordable is more than 9,999, ">9999" is indicated.
- You can resize the images later (Resize function, see page 70).

The number of images that can be saved in a "Memory Stick"³⁾

The number of images that can be saved in Fine (Standard)⁴⁾ mode are shown below. (Units: number of images)

Capacity	16MB	32MB	64MB	128MB	MSX-256	MSX-512	MSX-1G
Image size							
5M	6 (11)	12 (23)	25 (48)	51 (96)	92 (174)	188 (354)	384 (723)
3:2	6 (11)	12 (23)	25 (48)	51 (96)	92 (174)	188 (354)	384 (723)
3M	10 (18)	20 (37)	41 (74)	82 (149)	148 (264)	302 (537)	617 (1097)
1M	24 (46)	50 (93)	101 (187)	202 (376)	357 (649)	726 (1320)	1482 (2694)
VGA (E-Mail)	97 (243)	196 (491)	394 (985)	790 (1975)	1428 (3571)	2904 (7261)	5928 (14821)

³⁾ When [Mode] (REC Mode) is set to [Normal]

For the number of images that can be saved in other modes, see page 113.

⁴⁾ For more information about the image quality (compression ratio) setup, see page 47.

Basic still image shooting – Using auto mode

Holding the camera correctly

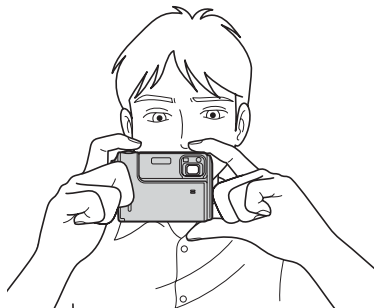

When shooting pictures with the camera, be careful so that your fingers do not block the lens, finder window, flash emitter, speaker, or microphone (page 8).

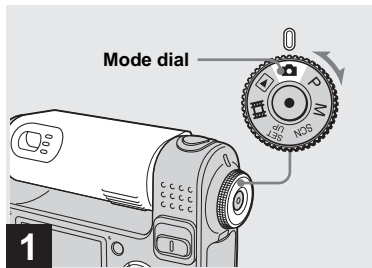

➔ **Set the mode dial to , and rotate the lens portion to turn on your camera.**

- You can create a new folder in the “Memory Stick” and select the folder for storing images (page 48).

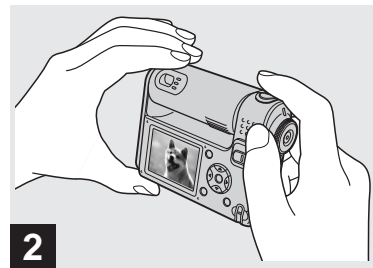

➔ **Hold the camera steadily with both hands and position a subject in the center of the focus frame.**

- The minimum focal distance to a subject is approx. 50 cm (19 3/4 inches). To shoot subjects at distances closer than this, use the macro mode (page 27).
- The frame indicated on the LCD screen shows the focus adjustment range. (AF range finder, see page 49.)

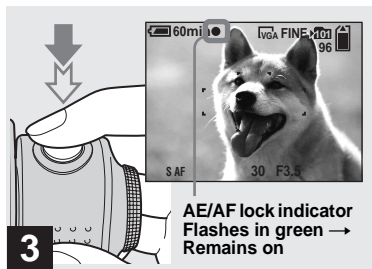

→ **Press and hold the shutter button halfway down.**

When the focus is achieved, the camera beeps. When the AE/AF lock indicator stops flashing and remains on, the camera is ready for shooting.

- If you release your finger from the shutter button, shooting will be canceled.
- When the camera does not beep, the AF adjustment is not complete. You can continue to shoot, but the focus is not set properly.

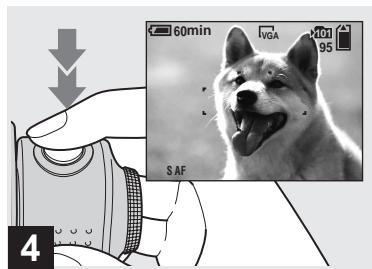

→ **Press the shutter button fully down.**

The shutter clicks, the shooting is completed, and the still image is saved in the “Memory Stick.” When the recording lamp (page 9) goes out, you can shoot the next image.

- When you are shooting with a battery pack, if no tasks are performed for a while with the camera turned on, power is automatically shut off to preserve battery power (page 15).

About Auto Focus

When you try to shoot a subject that is hard to focus on, the AE/AF lock indicator will change to flashing slowly and the AE lock beep does not sound.

The Auto Focus function may be difficult to use with in the following subjects. In such cases, release the shutter button, then try to re-compose the shot and focus again.

- The subject is distant from the camera and dark
- The contrast between the subject and its background is poor
- The subject is seen through glass, such as a window
- A fast-moving subject
- The subject has a reflection, such as that from a mirror, or there is a luminous body and a lustrous subject
- A flashing subject
- A backlit subject

There are two Auto Focus functions: “AF range finder frame” which sets the focus position according to the subject position and size, and “AF mode” which sets when the camera starts and stops focusing on. See page 49 for details.

Checking the last image shot – Quick Review

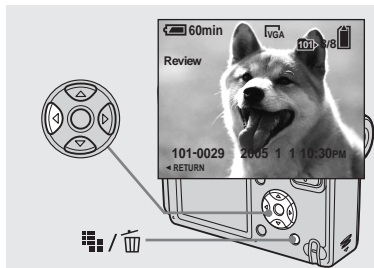

➔ Press ◀ (◀) on the control button.

To return to shooting mode, press the shutter button lightly or press ◀ (◀) on the control button again.

To delete the image displayed on the LCD screen

- 1 Press / (Delete).
 - 2 Select [Delete] with ▲ on the control button, then press ●.
The image is deleted.
- The image may appear rough right after playback starts due to the image processing.

Using the zoom feature

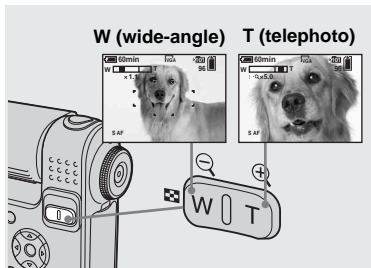

➔ Press the zoom buttons to choose the desired zoom position, and shoot your image.

The minimum focal distance to the subject

Approx. 50 cm (19 3/4 inches) from the lens surface

- You cannot change the zoom scaling while shooting movies (page 80).

Zoom

Your camera is equipped with zoom functions that enlarge the image using optical zoom and two types of digital processing. Digital zoom can be selected from smart zoom or precision digital zoom. When digital zoom is set, the zoom method switches from optical zoom to digital zoom when the zoom scale exceeds 3×.

To use only the optical zoom, set [Digital Zoom] to [Off] in the SET UP settings (page 117). In this case, the digital zoom area does not appear in the zoom scale display bar on the LCD screen, and the maximum zoom is 3×.

The enlargement method and the zoom scale differ according to the image size and the zoom type, so select the zoom to match the shooting purpose.

When you press the zoom button, the zoom scaling indicator appears on the LCD screen as follows.

The W side of this line is optical zoom area, and the T side is digital zoom area

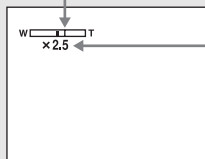

Zoom scaling indicator

- The zoom scaling indicator differs according to the zoom type.
Optical zoom: **X**
Smart zoom: **SQx**
Precision digital zoom: **PQx**
- The AF range finder frame does not appear when using the digital zoom. The **[AF]** or **[L]** indicator flashes, and AF operates with priority on subjects located near the center.

Smart zoom



Optical zoom



Smart zoom

The image is enlarged with almost no distortion. This lets you use smart zoom with the same feeling as optical zoom. To

set smart zoom, set [Digital Zoom] to [Smart] in the SET UP settings (page 117). The default setting is smart zoom. The maximum zoom scale depends on the selected image size as follows.

Image size	Maximum zoom scale
3M	3.8×
1M	6.1×
VGA (E-Mail)	12×

Smart zoom cannot be used when the image size is set to [5M] or [3:2]. The default setting of the image size is [5M].

- When using the smart zoom, the image on the LCD screen may look rough. However, this has no effect on the recorded image.
- You cannot use the smart zoom in the Multi Burst mode.

Precision digital zoom



Optical zoom

Precision digital zoom

All image sizes are enlarged up to a maximum 6×. This function cuts out and enlarges a certain portion of the image, so the image quality deteriorates. To set precision digital zoom, set [Digital Zoom] to [Precision] in the SET UP settings (page 117).

Shooting close-ups – Macro



For close-ups of subjects like flowers or insects, shoot using the macro feature. You can shoot subjects approaching up to 8 cm (3 1/4 inches) when the zoom is set to its W-end. However, the available focus distance depends on the zoom position. We recommend that you set the zoom to its W-end during shooting.

When the zoom is set all the way to the W side:

Approx. 8 cm (3 1/4 inches) from the end of the lens

When the zoom is set all the way to the T side:



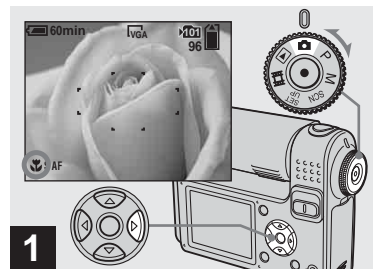

Approx. 25 cm (9 7/8 inches) from the end of the lens

- To shoot at even closer distances than in macro mode, use [Q] (Magnifying glass mode) (page 34).



- ➔ **Set the mode dial to , and press  on the control button.**

The  (macro) indicator appears on the LCD screen.

- If the menu is currently displayed, press MENU first to make the menu disappear.
- You can carry out this operation even when the mode dial is set to P, M, SCN (other than [Q] (Magnifying glass mode),  (Twilight mode),  (Landscape mode),  (Fireworks mode) or  (Candle mode), page 34) or .

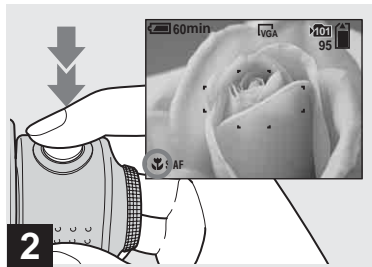



➔ **Center the subject in the frame. Press and hold the shutter button halfway down to focus on, then press the shutter button fully down.**

To return to normal shooting

Press **▶** (👉) on the control button again. The **👇** indicator disappears from the LCD screen.

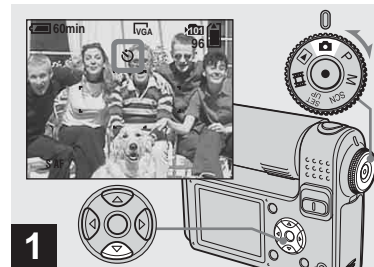
- When shooting in macro mode, use the LCD screen. If you use the finder, the limits of what you see and what you actually shoot may be different. This is due to the parallax effect.
- When shooting in macro mode, the focus range is very narrow and you may not be able to focus on the whole of the subject.
- When shooting in macro mode, the focus adjustment becomes slower to accurately focus on a close subject.



➔ **Set the mode dial to , and press **▼** (👇) on the control button.**

The **👇** (self-timer) indicator appears on the LCD screen.

- If the menu is currently displayed, press MENU first to make the menu disappear.
- You can carry out this operation even when the mode dial is set to P, M, SCN or .

Rotating the lens – Mirror mode

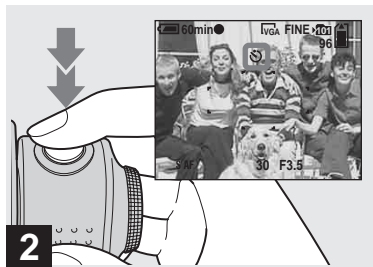

- ➔ **Center the subject in the frame. Press and hold the shutter button halfway down to focus on, then press the shutter button fully down.**

The self-timer lamp (page 8) will flash, and you will hear a beeping sound. The image will be shot after approximately 10 seconds.

To cancel the self-timer during the operation

Press ▼ (🕒) on the control button again. The 🕒 indicator disappears from the LCD screen.

- If you stand in front of the camera and press the shutter button, the focus and the exposure may not be correctly set.

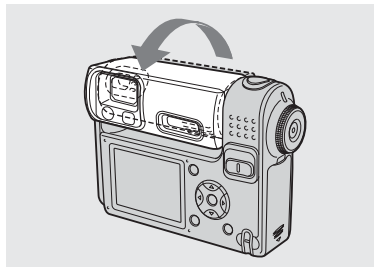

- ➔ **Adjust the lens portion angle.**

When shooting in mirror mode, turn over the lens portion as illustrated above. The image on the LCD screen is a mirror-image. However, the image can be normal when recorded.

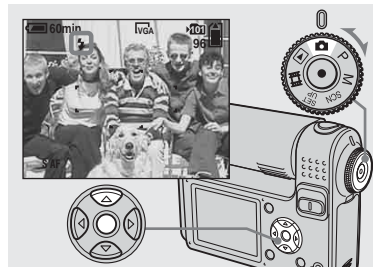



Image on the LCD screen



Recorded image

Selecting a flash mode



- ➔ **Set the mode dial to , and press ▲ (⚡) on the control button repeatedly to select a flash mode.**

The flash mode has the following features.

No indicator (Auto): The camera decides to use the flash based on lighting conditions. The flash will be used when there is not enough light. The default setting is Auto.

⚡ (Forced flash): The flash will be used regardless of the amount of ambient light.

⚡^{SL} (Slow synchro): The flash will be used regardless of the amount of ambient light. In this mode, the shutter speed is slower under dark conditions, so you can

clearly shoot a background that is out of the flash-lit area.

⊗ (No flash): The flash will not be used.

- If the menu is currently displayed, press MENU first to make the menu disappear.
- You can carry out this operation even when the mode dial is set to P, M or SCN (other than ☾ (Twilight mode), ☽ (Twilight portrait mode), 🎆 (Fireworks mode) or 🕯 (Candle mode)).
- The recommended distance using the flash is as follows (when [ISO] is set to [Auto]): Approx. 0.15 m (6 inches) to 2.2 m (7 feet 2 5/8 inches) (W)/Approx. 0.25 m (9 7/8 inches) to 2 m (6 feet 6 3/4 inches) (T)
- The flash fires twice. First pre-emission is to adjust the amount of flash light, and second emission is to shoot the image.
- You can change the brightness of the flash using [±] (Flash Level) in the menu settings (page 115). (When the mode dial is set to 📷, you cannot change the brightness of the flash.)
- Because the shutter speed is slower under dark conditions when 📶 (Slow synchro) or ⊗ (No flash) is selected, it is recommended that you use a tripod.
- While the flash is being charged, the 🔌/CHG lamp flashes. After charging is completed, the lamp goes out.
- This setting is maintained even when the power is turned off.

To reduce “red-eye” when shooting live subjects

The flash pre-strobes before shooting to reduce the red-eye phenomenon. Set [Red Eye Reduction] to [On] in the SET UP settings (page 117). 📷 appears on the LCD screen.





- The amount of red-eye reduction possible varies according to the individual. In addition, the distance to the subject, and whether or not the subject has seen pre-strobe light begin to strobe may also reduce the effectiveness of the red-eye reduction process.
- When [Red Eye Reduction] is set to [On], the flash fires twice or more.

Shooting images with the AF illuminator

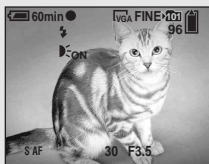
The AF illuminator is fill light to focus more easily on a subject in dark surroundings. The **AF-ILL** appears on the LCD screen and the AF illuminator emits red light when the shutter button is pressed halfway until the focus is locked.



When this function is not needed, set [AF Illuminator] to [Off] in the SET UP settings (page 117).

- The AF range finder frame does not appear. The **AF-ILL** or **AF-ILL** indicator flashes, and AF operates with priority on subjects located near the center.
- The AF illuminator does not operate when SCN is set to  (Twilight mode),  (Landscape mode),  (Fireworks mode) in the menu settings (page 34).
- The AF illuminator emits very bright light. Although there are no problems with safety, directly looking into the AF illuminator emitter at close range is not recommended.
- If AF illuminator light does not reach the subject sufficiently or the subject has no contrast, focus will not be achieved. (A distance up to approximately 3.0 m (9 feet 10 1/8 inches) is recommended.)
- Focus is achieved as long as AF illuminator light reaches the subject, even if the light is slightly off the center of the subject.
- When the focus preset distance is set (page 51), the AF illuminator does not function.

Shooting images with the finder

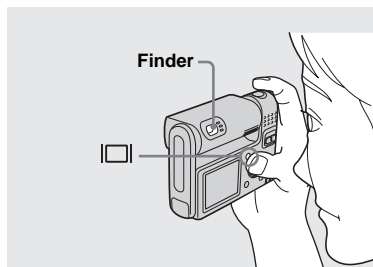

The finder is convenient when you want to save battery power, or when it is difficult to confirm the image using the LCD screen. Each time you press , the display changes in the following order.

Histogram on
(Image information can also be displayed during playback)

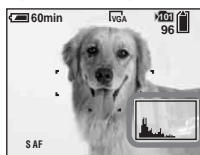



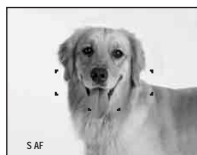

Indicators off

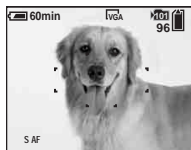

LCD screen off

Indicators on



- The image through the finder does not indicate the actual recordable range. This is due to the parallax effect. To confirm the recordable range, use the LCD screen.
- Just as with the AE/AF lock indicator on the LCD screen, when the AE/AF lock lamp of the finder section stops flashing and remains on, you can start shooting (page 23).
- When the LCD screen is turned off
 - The digital zoom does not function (page 25).
 - AF mode is set to [Single] (page 50).
 - If you press  (Flash mode)/ (Self-timer)/ (Macro) with the LCD screen turned off, the image will be displayed on the screen for approximately two seconds so you can check or change the setting.
- When shooting/viewing movies, the status of the LCD screen changes as follows: Indicators off → LCD screen off → Indicators on
- For details on the items displayed, see page 124.
- For a detailed description of the histogram, see page 56.
- This setting is maintained even when the power is turned off.

Inserting the date and time on a still image

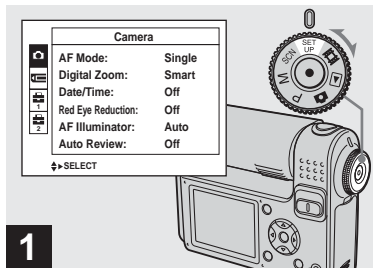

➔ Set the mode dial to SET UP.

The SET UP screen appears.

- The date and time cannot be inserted in Multi Burst mode.
- When images are shot with the date and time inserted, the date and time cannot be removed later.
- When shooting images with the date and time inserted, the actual date and time are not displayed on the LCD screen, and **DATE** is displayed on the LCD screen instead. The actual date and time are indicated in red on the lower-right corner when the image is played back.

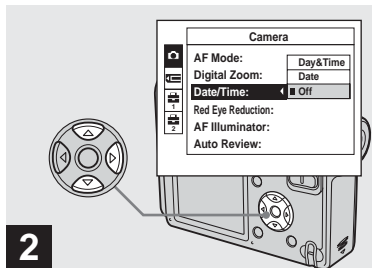

➔ Select (Camera) with ▲ on the control button, then press ▶.



Select [Date/Time] with ▲/▼ on the control button, then press ▶.

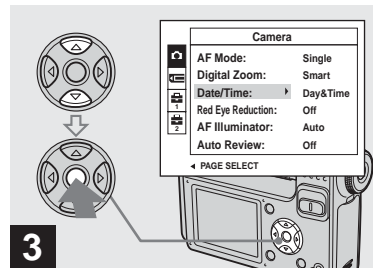

➔ Select the date and time setting with ▲/▼ on the control button, then press ●.

Day&Time: Inserts the date and the time of shooting into the image

Date: Inserts the year, the month and the date of shooting into the image

Off: Does not insert date/time data into the image

After the setting has been completed, set the mode dial to  to shoot your image.

- You can shoot even when the mode dial is set to P, M or SCN.
- When you chose [Date], the date will be inserted in the order set in “Setting the date and time” (page 17).
- This setting is maintained even when the power is turned off.

Shooting according to scene conditions – Scene Selection

Select one of the following modes, then shoot by pressing the shutter button and this will have a positive effect on your photo.

Magnifying glass mode

The subject appears on the LCD screen magnified by up to 2.1×. This lets you see details that would otherwise be difficult to confirm with the naked eye.

Distance to the subject	Magnification scale
1 cm (13/32 inch)	2.1×
2 cm (13/16 inch)	1.4×
5 cm (2 inches)	0.7×
10 cm (4 inches)	0.4×
20 cm (7 7/8 inches)	0.2×



- The focal distance to the subject is from approx. 1 cm to 20 cm (13/32 inch to 7 7/8 inches).
- The optical zoom is locked to the W side and cannot be used.
- When you press the zoom button, the image is enlarged using the digital zoom.

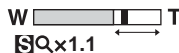

Twilight mode

Under dark lighting conditions, you can shoot a distant night view. Because the shutter speed is slow, it is recommended that you use a tripod.



Twilight portrait mode

Use this mode when shooting people in the foreground at night. This mode allows you to shoot images of people in the foreground with distinct outlines without losing the feeling that you are shooting at night. Because the shutter speed is slow, it is recommended that you use a tripod.



Landscape mode

Focuses on images far away, so is convenient for shooting landscapes at a distance.



Soft snap mode

You can shoot the color of a person's skin beautifully with a bright, warm color tone. This mode also has an effect on soft-focus, so an image such as that of a person or a flower is shot in the proper atmosphere.



Snow mode

When shooting snowy scenes or other places where the whole screen appears white, use this mode to prevent sunken colors and record clear images.



Beach mode

When shooting seaside or lakeside scenes, the blue of the water is clearly recorded.



High-speed shutter mode

Use this mode to shoot moving subjects outdoors or in other bright places.



- The shutter speed becomes faster, so images shot in dark places become darker.

Fireworks mode

You can record fireworks in all their splendor. The focus distance is set to infinity and the shutter speed becomes slower, so using a tripod is recommended.



- You can change the shutter speed by setting an EV adjustment value (page 55).

Candle mode

At a party, a candlelight service, and so on, you can shoot without spoiling the atmosphere effected by the candlelight. Because the shutter speed is slow, it is recommended that you use a tripod.



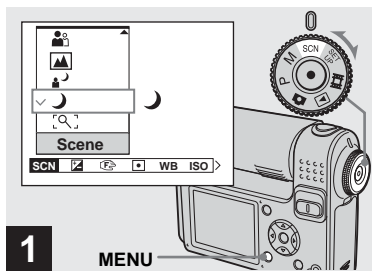

➔ Set the mode dial to SCN, then press MENU.

The menu appears.

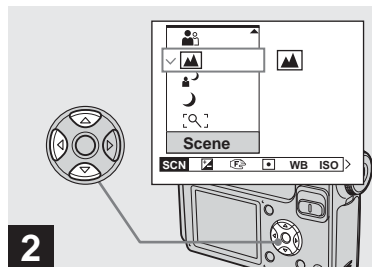

➔ Select SCN (Scene) with ◀ on the control button, then select the desired mode with ▲/▼.

To return to normal mode

Set the mode dial to a different mode.

- The setting is maintained even when the power is turned off.

Shooting with Scene Selection

When shooting with the Scene Selection function, the combination of functions such as the flash mode is predetermined to make the optimum settings to match the scene. See the table below for the function setting of each shooting mode.

Function Shooting mode	Macro	Flash mode	AF range finder frame	Focus preset	White balance	Burst/ Multi Burst
	—		○	—	○	—
	—		○	∞	○	—
	○		○	○	Auto	—
	—		○	∞	○	○
	○	○	○	○	○	○
	○		○	○	○	○
	○		○	○	○	○
	○		○	○	○	○
	—		—	∞		—
	—		Center AF	0.5m/1.0m/ 3.0m/7.0m		—

- indicates that the function can be set to your preference.

NR slow shutter

The NR slow shutter function reduces noise from recorded images, providing clear images. When the shutter speed is set to 1/6 second or slower, the NR slow shutter function automatically works and “NR” is indicated next to the shutter speed indicator.



Press the shutter button fully down.

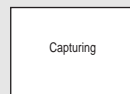

Then the screen turns black.

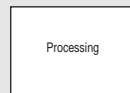

Finally, when “Processing” disappears, the image has been recorded.

- To eliminate the effects of vibration, it is recommended that you use a tripod.
- When a slow shutter speed is set, processing may take some time.

Viewing images on the LCD screen of your camera

Single screen



Index screen



You can view images shot with the camera almost immediately on the LCD screen. You can select the following two methods for viewing images.

Single screen

You can view one image at a time, occupying the entire screen.

Index screen

Nine images are displayed simultaneously in separate panels on the screen.

- For details on the movies, see page 81.
- For a detailed description of the LCD screen indicators, see page 126.

Viewing on the single-image screen

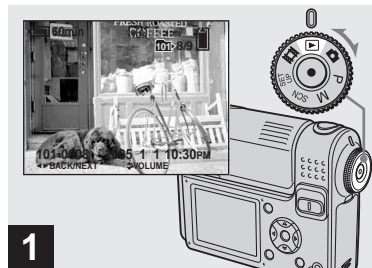

➔ **Set the mode dial to , and turn on the camera.**

The newest image in the selected recording folder (page 63) is displayed.

- The image may appear rough right after playback starts due to the image processing.

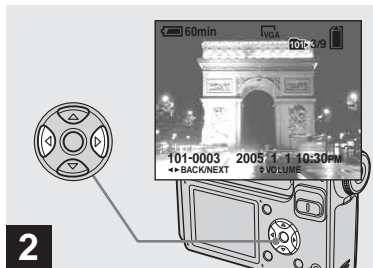

➔ **Select the desired still image with ◀▶ on the control button.**

- ◀ : Displays the previous image.
- ▶ : Displays the next image.

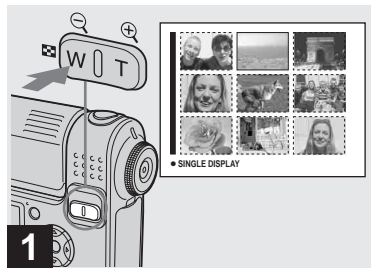

➔ **Press  (index).**

The display switches to the **Index screen**.

To display the next (previous) index screen

Press ▲/▼/◀▶ on the control button to move the yellow frame up/down/ left/right.

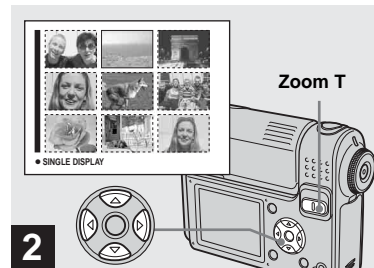

➔ **Press ▲/▼/◀▶ on the control button to select an image.**

The image in the yellow frame is selected.

To return to the single-image screen

Press the zoom T button, or press ● on the control button.

Viewing images on a TV screen

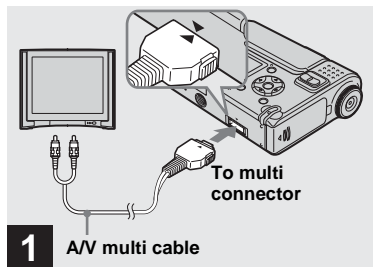

- ➔ **Connect the supplied A/V multi cable to the multi connector of the camera and the audio/video input jacks of the TV.**

Rotate the lens portion back to the original position and place the camera with the LCD screen facing upwards. If your TV has stereo type input jacks, connect the audio plug (black) of the A/V multi cable to the Lch audio input jack.

- Turn off both the camera and the TV before connecting the camera and the TV with the A/V multi cable.

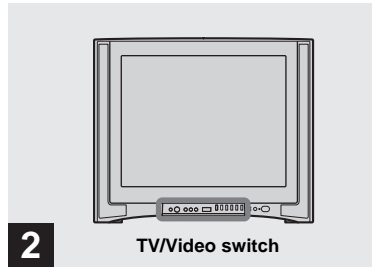

- ➔ **Turn on the TV, and set the TV/Video switch to “Video.”**

- The name and location of this switch may differ depending on your TV. For details, refer to the operating instructions supplied with the TV.

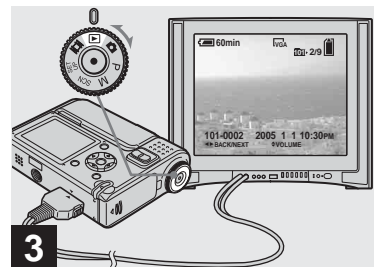

- ➔ **Set the mode dial to , and turn on the camera.**

Press  on the control button to select the desired image.

- When using the camera abroad, it may be necessary to switch the video output signal to match that of your TV system (page 118).

Watching images on a TV screen

If you want to view images on a TV, you need a TV having a video input jack and the A/V multi cable (supplied).

The color system of the TV must match as that of your digital still camera. Check the following list:

NTSC system

Bahama Islands, Bolivia, Canada, Central America, Chile, Colombia, Ecuador, Jamaica, Japan, Korea, Mexico, Peru, Surinam, Taiwan, the Philippines, the U.S.A., Venezuela, etc.

PAL system

Australia, Austria, Belgium, China, Czech Republic, Denmark, Finland, Germany, Holland, Hong Kong, Hungary, Italy, Kuwait, Malaysia, New Zealand, Norway, Poland, Portugal, Singapore, Slovak Republic, Spain, Sweden, Switzerland, Thailand, United Kingdom, etc.

PAL-M system

Brazil

PAL-N system



Argentina, Paraguay, Uruguay

SECAM system

Bulgaria, France, Guiana, Iran, Iraq, Monaco, Russia, Ukraine, etc.

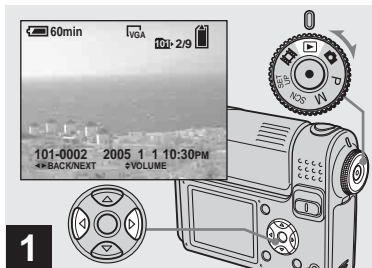
Deleting images



- 1** → Set the mode dial to , and turn on the camera. Select the image you want to delete with / on the control button.

- Note that the images once deleted cannot be recovered.

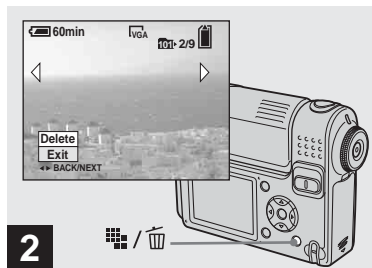

- 2** → Press  /  (delete).

The image has not yet been deleted at this point.



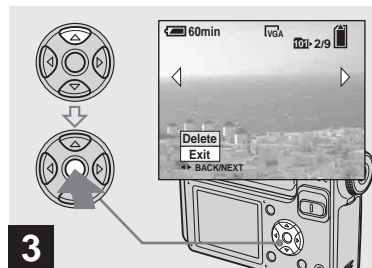

- You cannot delete protected images (page 69).





- 3** → Select [Delete] with  on the control button, then press .

“Access” appears on the LCD screen and the image will be deleted.



To delete other images continuously

Select the image you want to delete with / on the control button. Next, select [Delete] with  on the control button, then press .

To cancel the deletion

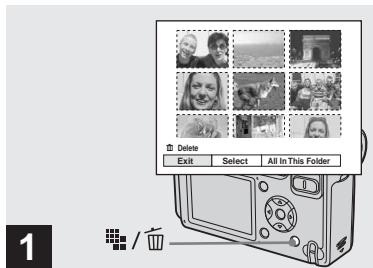

Select [Exit] with  on the control button, then press .





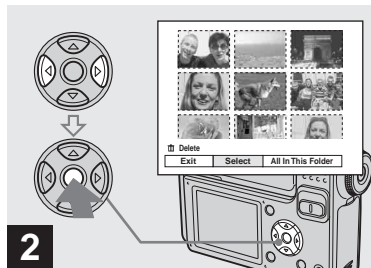



→ While an Index screen (page 39) is displayed, press  /  (delete).

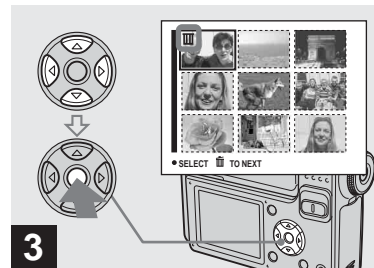

- Note that the images once deleted cannot be recovered.





→ Select [Select] with  /  on the control button, then press .



→ Select the image you want to delete with  /  /  /  on the control button, then press .

The  (delete) mark is indicated on the selected image. The image has not yet been deleted at this point. Put the  mark on all of the images you want to delete.

- To cancel your selection, select images you want to cancel and press  on the control button again. The  mark disappears.

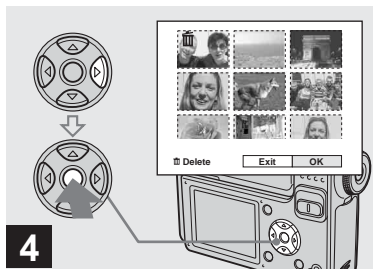

- Press / (delete).
Select [OK] with on the control button, then press .

“Access” appears on the LCD screen and all of the images with marks will be deleted.

To cancel the deletion

Select [Exit] with on the control button, then press .

To delete all the images in the folder
In Step **2**, Select [All In This Folder] with on the control button, then press . Next, select [OK], then press . All of the unprotected images in the folder are deleted. To cancel the deletion, select [Cancel], then press .

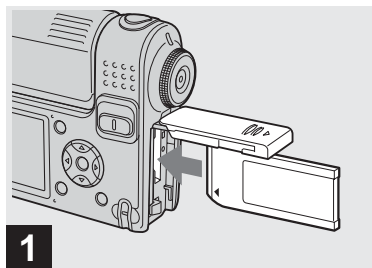

- Insert the “Memory Stick” you want to format into the camera.

- The term “formatting” means preparing a “Memory Stick” to record images; this process is also called “initialization.”
- The supplied “Memory Stick” and those available commercially, are already formatted, and can be used immediately.
- **When you format a “Memory Stick,” be aware that all of the data in the “Memory Stick” will be permanently erased. Protected images are also erased.**

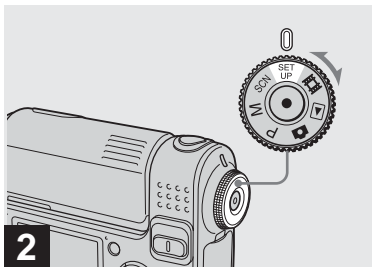

2 → Set the mode dial to SET UP, and turn on the camera.

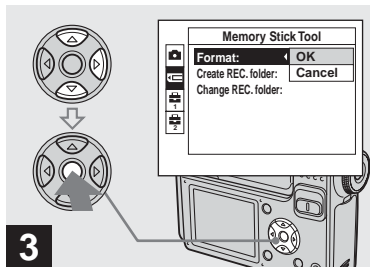

3 → Select (Memory Stick Tool) with ▲/▼ on the control button. Select [Format] with ► on the control button, then press ►. Select [OK] with ▲ on the control button, then press ●.

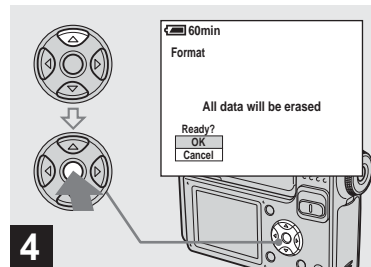

4 → Select [OK] with ▲ on the control button, then press ●.

The “Formatting” message appears on the LCD screen. When this message disappears, the format is complete.

To cancel the formatting

Select [Cancel] with ▼ on the control button, then press ●.

How to setup and operate your camera

This section describes how to operate the menu and the SET UP screen.

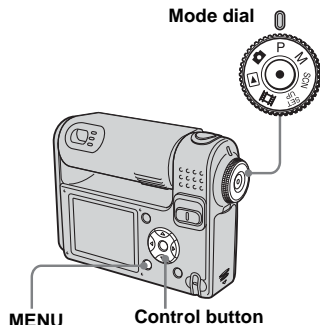

- For details on the mode dial, see page 10.

Changing menu settings

- 1 Set the mode dial to , P, M, SCN, or .**

- 2 Press MENU.**

The menu appears.

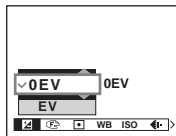

- The displayed items differ depending on the position of the mode dial.

- 3 Select the setting item you want to change with / on the control button.**

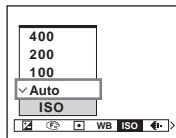

- When the mode dial is set to , press on the control button after you select a setting.

- 4 Select the desired setting with / on the control button.**

The frame of the selected setting is scaled up, and the setting is entered.

When the mark is indicated above the item or the mark is indicated below the item

All of the available items are not displayed. Pressing / on the control button displays the hidden items.

To turn off the menu display

Press MENU.

- You cannot select the dim items.
- For details on the menu items, see page 114.

Changing items in the SET UP screen

1 Set the mode dial to SET UP.

The SET UP screen appears.

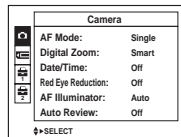

2 Select the setting item you want to change with ▲/▼/◀/▶ on the control button.

The frame of the item you select turns yellow.

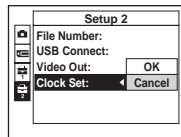

3 Press ● on the control button to enter the setting.

To turn off the SET UP screen display

Set the mode dial to any position other than SET UP.

- For details on the SET UP items, see page 117.

Deciding the still image quality

You can select the still image quality from [Fine] or [Standard].

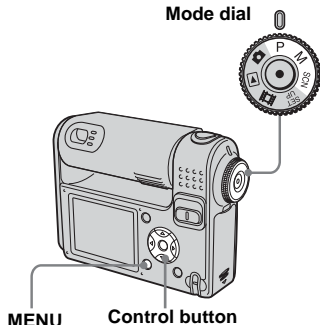

1 Set the mode dial to P, M or SCN.

2 Press MENU.

The menu appears.

3 Select ⏪ (P. Quality) with ◀/▶, then select the desired image quality with ▲/▼.

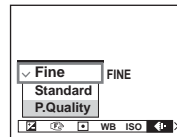

Creating or selecting a folder

Your camera can create multiple folders within a “Memory Stick.” You can select the folder used to store images. When not creating a new folder, “101MSDCF” folder is selected as the recording folder. You can create folders up to “999MSDCF.”

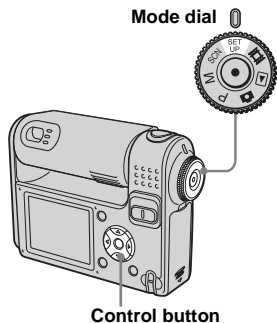

- Up to 4,000 images can be stored in one folder. When the folder capacity is exceeded, a new folder is automatically created.

Creating a new folder

- 1** Set the mode dial to SET UP.
- 2** Select (Memory Stick Tool) with $\blacktriangle/\blacktriangledown$, [Create REC. Folder] with $\blacktriangleright/\blacktriangle/\blacktriangledown$, and [OK] with $\blacktriangleright/\blacktriangle$, then press \bullet .

The creating folder screen appears.



- 3** Select [OK] with \blacktriangle , then press \bullet .

A new folder is created with a number one higher than the largest number in the “Memory Stick,” and the folder becomes the recording folder.

To cancel folder creation

In Step **2** or **3**, select [Cancel].

- Once you create a new folder, you cannot delete the new folder with the camera.
- Images are recorded in the newly created folder until a different folder is created or selected.

Selecting the recording folder

- 1** Set the mode dial to SET UP.
- 2** Select (Memory Stick Tool) with $\blacktriangle/\blacktriangledown$, [Change REC. Folder] with $\blacktriangleright/\blacktriangledown$, and [OK] with $\blacktriangleright/\blacktriangle$, then press \bullet .

The recording folder selection screen appears.

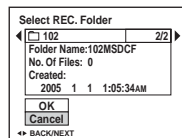

- 3** Select the desired folder with $\blacktriangle/\blacktriangledown$, and [OK] with \blacktriangle , then press \bullet .

To cancel changing the recording folder

In Step **2** or **3**, select [Cancel].

- You cannot select the “100MSDCF” folder as a recording folder (page 91).
- The image is stored in the newly selected folder. You cannot move images to other folders using the camera.

Choosing an auto focus method

You can set the AF range finder frame and the AF mode.

AF range finder frame

The AF range finder frame selects the focus position according to the subject position and size.

AF Mode

The AF mode is set automatically when the camera starts and stops focusing on a subject.

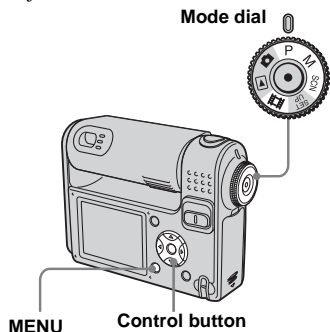

Choosing a focus range finder frame

– AF range finder

Multipoint AF ()

The camera calculates the distance in five areas to the top, the bottom, the left, the right, and in the center of the image, letting you shoot using the auto focus function without worrying about the image composition. This is useful when it is difficult to focus on the subject because it is not in the center of the frame. You can check the position where the focus was adjusted using the green frame.

The default setting is Multipoint AF.

Center AF ()

The AF range finder is only the center of the frame. You can shoot in desired image composition using the AF lock method.

1 Set the mode dial to P, M, SCN or .

2 Press MENU.

The menu appears.

3 Select  (Focus) with , then select [Multi AF] or [Center AF] with .

When you press and hold the shutter button halfway down, and the focus is adjusted, the color of the AF range finder frame changes from white to green.

Multipoint AF



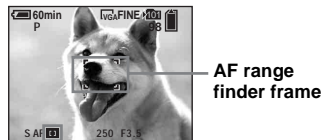

AF range finder frame indicator

Center AF



AF range finder frame indicator

- When you are shooting movies and you choose Multipoint AF, the distance to the center of the LCD screen is estimated as an average, so the AF works even with a certain amount of vibration. The AF range finder frame indicator is . Center AF automatically focuses only on selected frame, so this is convenient when you want to focus only on what you aim at.
- When you use the digital zoom or AF illuminator, priority AF movement is given to subjects in or near the center of the frame. In this case,  or  flashes and the AF range finder frame is not displayed.
- The AF range finder frame selection is limited according to the Scene Selection mode (page 10).

Choosing a focus operation

– AF Mode

Single AF (AF)

This mode is useful for shooting stationary subjects. The focus is not adjusted before you press and hold the shutter button halfway down. After you press and hold the shutter button halfway down and AF lock is complete, the focus is locked. The default setting is Single AF.





Monitoring AF (AF)

This shortens the time needed for focusing. The camera automatically adjusts the focus before you press and hold the shutter button halfway down, letting you compose images with the focus already adjusted. After you press and hold the shutter button halfway down and AF lock is complete, the focus is locked.

- Battery consumption may be higher than in Single AF mode.

1 Set the mode dial to SET UP.

2 Select  (Camera) with , then select [AF Mode] with .

3 Select the desired mode with , , , then press .

- When shooting using the finder with the LCD screen off, the camera operates in Single AF mode.

Shooting techniques

When shooting with the subject at the edge of the frame, or when using Center AF, the camera may focus on the center instead of on the subject at the edge of the frame. In a case like this, use AF lock to focus on the subject, and then recompose the picture and shoot.

Compose the shot so that the subject is centered in the AF range finder frame, and press the shutter button halfway down. When the AE/AF lock indicator stops flashing and remains on, return to the fully composed shot, and press the shutter button fully down.



AF range finder frame

AE/AF lock indicator





- When you are using AF lock, you can capture an image with the correct focus even if the subject is at the edge of the frame.
- You can carry out the AF lock adjustment process before you press the shutter button fully down.

Setting the distance to the subject

– Focus preset

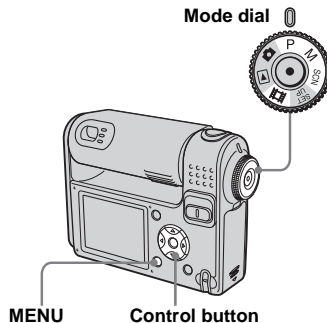
When shooting an image using a previously set distance to the subject, or when shooting a subject through a net or through window glass, it is difficult to get the proper focus in auto focus mode. In these cases, use of the Focus preset is convenient.



1 Set the mode dial to P, M, SCN or .

2 Press MENU.

The menu appears.

- 3** Select **F2** (Focus) with **◀/▶**, then select the distance to the subject with **▲/▼**.

You can select from the following distance settings.
0.5m, 1.0m, 3.0m, 7.0m, ∞ (unlimited distance)

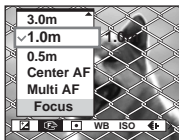

To return to auto focus mode

In Step **3**, select [Multi AF] or [Center AF].

- Focal point information may not show the exact distance. Use it as a guide.
- If you point the lens up or down, the error increases.
- The distance selection is limited according to the Scene Selection mode (page 10).

Shooting with manual shutter speed and aperture settings

– Manual Exposure

You can manually adjust the shutter speed and aperture values.

The difference between the set value and the appropriate exposure determined by the camera is displayed on the LCD screen as the EV value (page 55). 0EV indicates the most suitable value set by the camera.

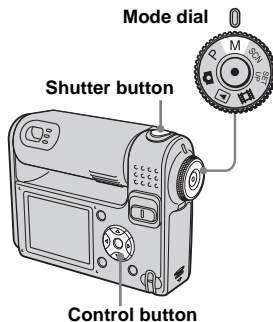

- 1** Set the mode dial to **M**.

- 2** Press **●**.

“Set” indicated on the lower-left corner of the LCD screen changes to “Return” and the camera enters the manual exposure setup mode.

- 3** Select a shutter speed with **▲/▼**.

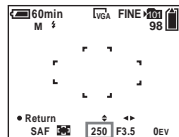

A shutter speed can be selected between 1/500 of a second and 30 seconds.

If you select 1/6 second or slower shutter speeds, the NR slow shutter function (page 37) is automatically activated. In such cases, “NR” is indicated at the next to shutter speed indicator.

4 Select an aperture value with

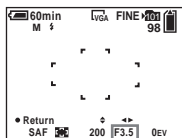

Three different aperture values can be selected, depending on the zoom position.

When the zoom is set all the way to the W side: F3.5/F5.6/F8.0

When the zoom is set all the way to the T side: F4.2/F6.3/F9.0

5 Shoot the image.

To use the Quick review, macro, or self-timer function or change the flash mode



After Step 4, press  to cancel the manual exposure setup mode. “Return” changes to “Set.”

To cancel the manual exposure mode

Set the mode dial to other than M.

- When the shutter speed is set to one second or slower, ["] is indicated after the value, e.g., 1".
- If the proper exposure is not obtained after making the settings, the EV value on the LCD

screen flashes when the shutter button is pressed halfway down. You can shoot in this condition, but we recommend that you adjust the flashing values again.

- The flash mode is automatically set to  (Forced flash) or  (No flash).

Exposure

In addition to the focus and other settings, it is also important to adjust the exposure in order to take beautiful pictures.

Exposure is the amount of light that the CCD of the digital still camera is able to receive. This value changes according to the combination of aperture and shutter speed. When the amount of light is larger, the image becomes brighter (whitish), and when it is smaller, the image becomes darker. The proper amount of light is called “correct exposure.”

The correct exposure can be maintained by setting a faster shutter speed when the aperture value is reduced, or a slower shutter speed when the aperture value is increased from the correct exposure.

Aperture

Aperture is the opening in the diaphragm of the lens part which adjusts the amount of light entering the camera. The aperture setting value is called the “aperture value (F value).”

Open (smaller F value)

- The image tends toward overexposure (brighter).
- The in-focus range narrows.



Close (larger F value)

- The image tends toward underexposure (darker).
- The in-focus range widens.



Adjustment by shutter speed

Shutter speed adjusts the time during which light enters the camera.

Faster

- The image tends toward underexposure (darker).
- Moving objects appear stopped.



Slower

- The image tends toward overexposure (brighter).
- Moving objects appear to flow.



When setting a slower shutter speed, it is recommended that you use a tripod to prevent shaking.

Overexposure

- Open the aperture
- Set a slower shutter speed



Correct exposure



Underexposure

- Close the aperture
- Set a faster shutter speed

Adjusting the exposure

– EV adjustment

You can manually shift the exposure value determined by the camera. Use this mode when you do not get the proper exposure, for instance, the subject and its background have high contrast (light and dark). The value can be set a range from +2.0EV to –2.0EV, in 1/3EV increments.

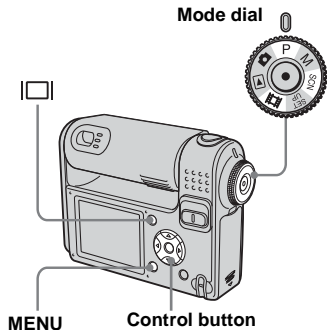
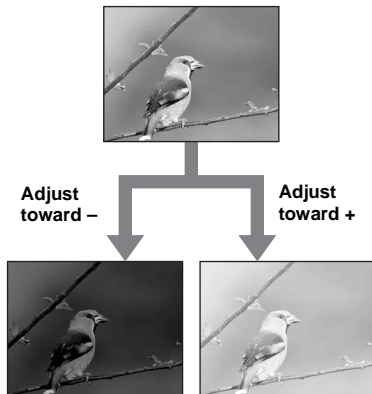

1 Set the mode dial to P, SCN or



2 Press MENU.

The menu appears.

3 Select (EV) with ◀.

The value of the exposure adjustment is displayed.



4 Select the desired exposure adjustment value with ▲/▼.

Make your adjustment while confirming the brightness of the background of the subject on the LCD screen.

To cancel the EV adjustment

In Step 4, return the exposure adjustment value to 0EV.

- When the subject is extremely bright or extremely dark, or when you are using the flash, the adjustment may not work.

Displaying a histogram

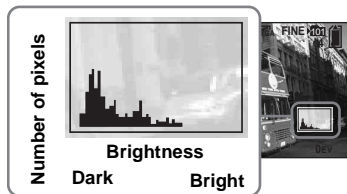

A histogram is a graph showing the brightness of an image. The horizontal axis shows the brightness, and the vertical axis shows the number of pixels. The graph display indicates a dark image when skewed to the left side, and a bright image when skewed to the right side. The histogram is a useful reference for checking the exposure during recording and playback when the LCD screen is hard to be seen.



1 Set the mode dial to P or SCN.

2 Press  to display the histogram.

3 Adjust the exposure based on the histogram.

- The histogram also appears when the mode dial is set to  or M, but the EV adjustment is deactivated.
- The histogram also appears when you press  while playing back a single image (page 38) or during Quick Review (page 25).

- The histogram does not appear in the following cases:
 - When the menu is displayed
 - When using playback zoom
 - When shooting or playing back movies
-  appears and the histogram does not appear in the following cases:
 - When recording in the digital zoom area
 - When the image size is [3:2]
 - When playing back Multi Burst mode images
 - When a still image is rotated
- The histogram before recording represents the histogram of the image displayed on the LCD screen at that time. A difference occurs in the histogram before and after you press the shutter button. When this happens, check the histogram while playing back a single-image or during Quick Review.
In particular a large difference may appear in the following cases:
 - When the flash strobes
 - When the shutter speed is slow or high
- The histogram may not appear for images recorded using other cameras.

Shooting techniques

While shooting images, the camera automatically determines the exposure. When shooting a whitish overall image such as a backlit subject or a snowy scene, the camera judges that the subject is bright and may set a darker exposure for the image. In such cases, adjustment of the exposure in the + plus direction is effective.



Adjust in the + direction



When shooting a darker overall image, the camera judges that the subject is dark and may set a brighter exposure for the image. In such cases, adjustment of the exposure in the – minus direction is effective.



Adjust in the – direction



You can check the exposure referring to the histogram chart. Be careful not to overexpose or underexpose your subject (giving a whitish or darkish image).

You can try to adjust the exposure to suit your taste.

Selecting the metering mode

You can select a metering mode to determine the exposure, depending on what part of the subject is used to measure.

Multi-pattern metering (No indicator)

The image is split up into multiple zones, each of which are evaluated individually. The camera calculates the best-fit exposure based on the subject's position and background brightness. The default setting is multi-pattern metering.

Spot metering (☐)

Spot metering allows you to meter for the subject directly in a small area of the whole image. This lets you adjust the exposure to the subject even when the subject is backlit or there is strong contrast between the subject and the background.

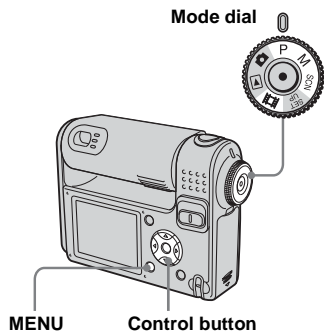

4 When selecting [Spot] in Step **3**, position the spot metering cross hair on one point of the subject you want to shoot.

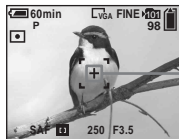



Spot metering cross hair

- When using spot metering, to focus on the same spot as used for metering, we recommend that you set  (Focus) to [Center AF] (page 49).

1 Set the mode dial to P, M, SCN or .

2 Press MENU.

The menu appears.

3 Select  (Metering Mode) with /▶, then select the desired metering mode with ▲/▼.

Adjusting color tones

– White Balance

You can select the following modes according to your shooting situations. The color of the subject that you see will be captured according to the lighting conditions. When you want to fix the conditions under which the image is captured, or when the color of the entire image seems to be a bit unnatural, it is recommended that you adjust the white balance.

Auto (No indicator)

The white balance is adjusted automatically.
The default setting is Auto.

(Daylight)

Used when shooting outdoors, and for shooting at night, under neon lights, for fireworks, sunrise, and twilight gloom.

(Cloudy)

Used when shooting under a cloudy sky.

(Fluorescent)

Used when shooting under fluorescent lights.

(Incandescent)

- Used when shooting, for example, at a party, where the lighting conditions change often.
- Used in a studio, or under video lights.

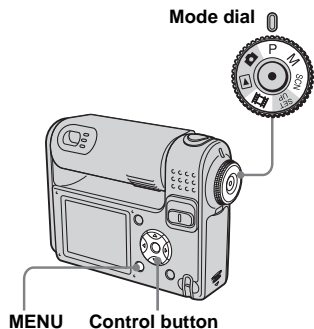

1 Set the mode dial to P, M, SCN or .

2 Press MENU.

The menu appears.

3 Select [WB] (White Bal) with ◀/▶, then select the desired setting with ▲/▼.

To return to automatic settings

In Step **3**, select [Auto].

- Under fluorescent lights that flicker, even if you choose , the white balance may not be properly adjusted.
- When the flash strobes, the manual setting is canceled, and the image is recorded in [Auto] mode.
- The white balance selection is limited according to the Scene Selection mode (page 37).

Adjusting the flash level

– Flash Level

You can adjust the amount of flash light.

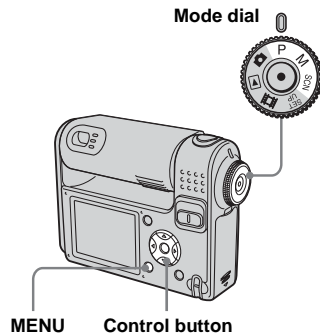

1 Set the mode dial to P, M or SCN.

2 Press MENU.

The menu appears.

- 3** Select [\pm] (Flash Level) with $\blacktriangleleft/\blacktriangleright$, then select the desired setting with $\blacktriangle/\blacktriangledown$.

+: Makes the flash level higher than normal.

Normal: Normal setting.

-: Makes the flash level lower than normal.

Shooting images in succession

Used to shoot images continuously. The maximum number of images you can shoot per one shooting depends on the image size and image quality settings.

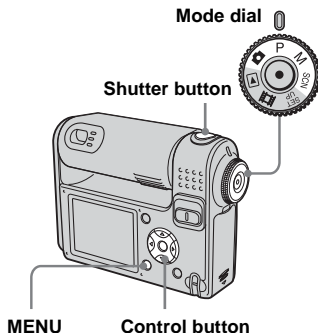

- When the battery level is insufficient or the capacity of the “Memory Stick” is used up, recording stops even if you press and hold the shutter button.

- 1** Set the mode dial to P , M or SCN .

- 2** Press MENU.

The menu appears.

- 3** Select [Mode] (REC Mode) with $\blacktriangleleft/\blacktriangleright$, then select [Burst] with $\blacktriangle/\blacktriangledown$.

- 4** Shoot the image.

You can shoot images until the maximum number of images are shot when you press and hold the shutter button. The recording stops if you release the shutter button in the midst of the shooting.

You can do the next shooting after “Recording” disappears from the LCD screen.

The maximum number of images shot continuously

(Units: images)

	Fine	Standard
5M	9	15
3:2	9	15
3M	13	24
1M	32	59
VGA (E-Mail)	100	100

To return to normal mode

In Step 3, select [Normal].

- The flash is set to (No flash).
- When using the self-timer, pressing the shutter button records up to five images in succession.
- When the mode dial is set to M, you cannot select shutter speeds of 1/6 second or slower.
- You may not be able to shoot images in succession depending on the Scene Selection mode (page 34).

Shooting in Multi Burst mode

– Multi Burst

Pressing the shutter button once records 16 frames in a row. This is convenient for checking your form in sports, for example.

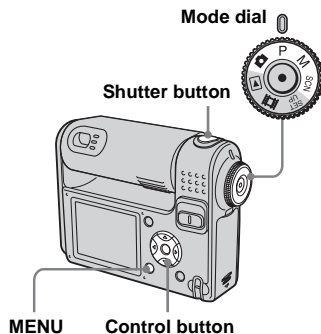

1 Set the mode dial to , P, M or SCN.

2 Press MENU.

The menu appears.

3 Select [Mode] (REC Mode) with , then select [Multi Burst] with .

4 Select (Interval) with , then select the desired between-frame interval with .

You can choose from [1/7.5], [1/15], [1/30].

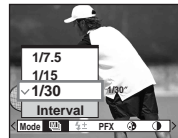

5 Shoot the image.

16 frames in a row will be recorded in a single image (image size: 1M).

- If you rotate the lens portion during shooting, the shot image may be upside down.
- The following functions cannot be used in Multi Burst mode:
 - Smart zoom
 - Shooting with the flash
 - Inserting the date and time
- When the mode dial is set to , frame interval is automatically set to [1/30].
- When the mode dial is set to M, you cannot set the shutter speed to lower than 1/30 second.
- You may not be able to shoot images in Multi Burst mode depending on the Scene Selection mode (page 34).
- When you play back images recorded in Multi Burst mode on the camera, see page 67.
- For the number of images that can be recorded, see page 113.

Shooting with special effects

– Picture Effect

You can add special effects to bring out the contrast in your images.

B&W

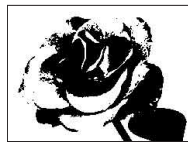





In black and white

Sepia

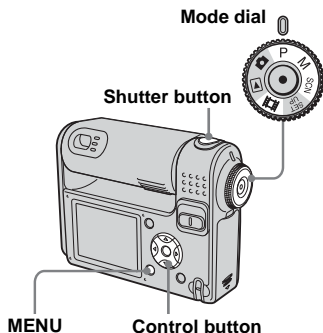

Colored to look like an old photograph



- 1 Set the mode dial to P, M, SCN or .**
- 2 Press MENU.**
The menu appears.
- 3 Select [PFX] (P.Effect) with , then select the desired mode with .**
- 4 Shoot the image.**

To cancel Picture Effect

In Step **3**, select [Off].

Using the Cyber-shot Station

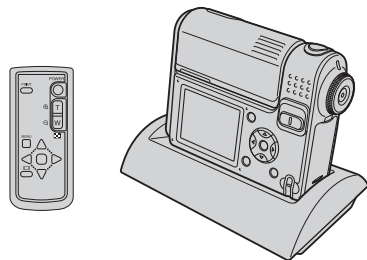

Charging starts automatically when you set the camera in the Cyber-shot Station (not supplied). This lets you easily charge the camera so that it is ready for use at any time. The remote controller supplied with the Cyber-shot Station lets you enjoy image playback on a TV from a remote location. In addition, when a PictBridge compliant printer is connected, images can be printed by simple remote controller operations. For more detailed information, refer to the operating instructions supplied with the Cyber-shot Station.

Selecting the folder and playing back images

– Folder

Select the folder that images you want to play back are stored.

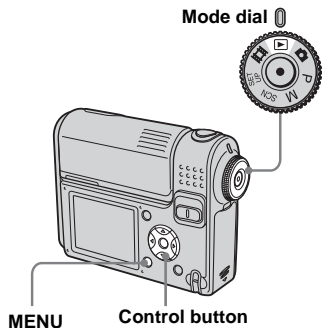

1 Set the mode dial to .

2 Press MENU.

The menu appears.

3 Select  (Folder) with , then press .

4 Select the desired folder with

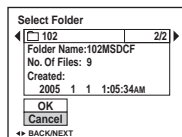

5 Select [OK] with , then press



To cancel the selection

In Step **5**, select [Cancel].

When multiple folders are created in the “Memory Stick”

When the first or last image in the folder is displayed, the following icons are indicated on the LCD screen.



: Moves to the previous folder.



: Moves to the next folder.



: Moves to both the previous and next folders.

On the single screen



On the Index screen



- When no images are stored in the folder, “No file in this folder” appears.

Enlarging a portion of a still image

You can enlarge an image up to five times the size of the original image. You can also record the magnified image as a new file.

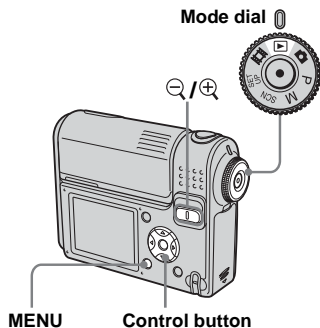

Enlarging an image – Playback zoom

- 1 Set the mode dial to .
- 2 Display the image you want to enlarge with / .
- 3 Press (playback zoom) to enlarge the image.
- 4 Press / / / repeatedly to select the portion of the image you want to enlarge.

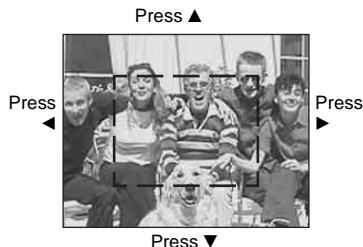

- ▲: To view a portion of the top of the image
- ▼: To view a portion of the bottom of the image
- ◀: To view a portion of the left side of the image
- ▶: To view a portion of the right side of the image

- 5 Adjust the zoom with / (playback zoom).



To cancel enlarged viewing

Press .

- You cannot use Playback zoom with movies or images recorded in Multi Burst mode.
- If you press (playback zoom) when you are viewing images that have not been enlarged, the Index screen will appear (page 38).
- The images displayed in Quick Review (page 25) can be enlarged using the procedures outlined in Steps **3** to **5**.

Recording an enlarged image – *Trimming*

1 Press MENU after playback zoom.

The menu appears.

2 Select [Trimming] with \blacktriangleright , then press \bullet .

3 Select the image size with $\blacktriangle/\blacktriangledown$, then press \bullet .

The image is recorded, and the image on the LCD screen returns to the normal size after recording.

- The trimmed image is recorded as the newest file in the selected recording folder, and the original image is retained.
- The quality of trimmed images may deteriorate.
- You cannot trim to an image size of 3:2.
- You cannot trim images displayed with Quick Review.

Playing back successive images

– Slide show

You can play back recorded images in succession, one after another. This is useful for checking your images, or for giving a presentation.

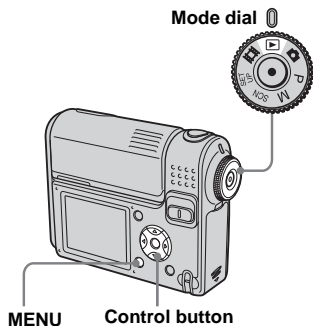

1 Set the mode dial to \blacktriangleright .

2 Press MENU.

The menu appears.

3 Select \blacktriangleright (Slide) with $\blacktriangle/\blacktriangledown$, then press \bullet .

Set the following items with $\blacktriangle/\blacktriangledown/\blacktriangle/\blacktriangledown$.

Interval settings

3 sec/5 sec/10 sec/30 sec/1 min

Image

Folder: Plays back all the images in the selected folder.

All: Plays back all the images in the “Memory Stick.”

Repeat

On: Plays the images back repeatedly.

Off: Plays through the images one time and then stops.

4 Select [Start] with $\blacktriangledown/\blacktriangleright$, then press \bullet .

The slide show begins.

To cancel the slide show setting

In Step 3, select [Cancel].

To stop slide show playback

Press \bullet , select [Exit] with \blacktriangleright , then press \bullet .

To skip to the next/previous image during slide show

Press ► (next) or ◀ (previous).

- The interval setting time is approximate, and may vary according to the playback image size.

Rotating still images

– Rotate

Images shot when holding the camera vertically can be rotated and displayed horizontally.



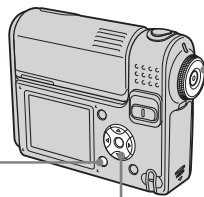

Mode dial



MENU

Control button

- 1** Set the mode dial to , and display the image you want to rotate.
- 2** Press **MENU**.
The menu appears.
- 3** Select  (Rotate) with ◀/▶, then press ●.
- 4** Select  with ▲, and rotate the image with ◀/▶.
- 5** Select [OK] with ▲/▼, then press ●.

To cancel the rotation

In Step **4** or **5**, select [Cancel].

- You cannot rotate protected images, movies, and Multi Burst images.
- You may not be able to rotate images shot with other cameras.
- When viewing images on a computer, the image rotation information may not be reflected depending on the application software.

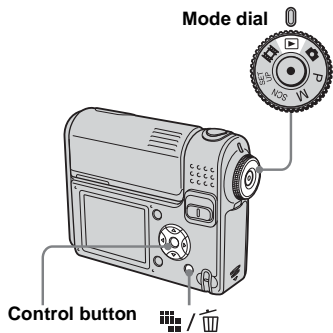

Playing back images shot in Multi Burst mode

You can play back Multi Burst images continuously or play them back frame by frame. This function is used for checking the images.



- When Multi Burst images are played back on a computer or on a camera without the Multi Burst function, the 16 frames you shot will be displayed at the same time as part of one image.
- You cannot divide the Multi Burst image.



Playing back continuously

- 1** Set the mode dial to .
- 2** Select the Multi Burst image with / .





The selected Multi Burst image is played back continuously.



To pause







Press . To resume playback, press  again. The playback starts from the frame displayed on the LCD screen.

Playing back frame by frame

- 1** Set the mode dial to .
- 2** Select the Multi Burst image with / .
- 3** Press  when the desired frame is displayed.

“Step” appears.





- 4** Advance the frame with / .
 - : The next frame is displayed. When you press  and hold it, the frame advances.
 - : The previous frame is displayed. When you press  and hold it, the frame advances in the reverse direction.

To return to normal playback

In Step **4**, press . The playback starts from the frame displayed on the LCD screen.

To delete shot images

When using this mode, you cannot delete only certain frames. When you delete images, all 16 of the frames are deleted at the same time.

- 1 Display the Multi Burst image you want to delete.
- 2 Press  /  (delete).
- 3 Select [Delete], then press .
All of the frames are deleted.

Protecting images

– Protect

To prevent accidental erasure of an important image, you can protect it.

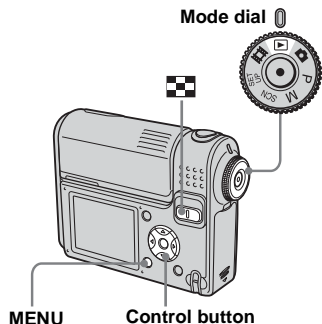

- Note that formatting the “Memory Stick” erases all the data in the “Memory Stick” even if images are protected, and these images cannot be recovered.
- It may take some time to protect the images.

On the single screen

- 1** Set the mode dial to .
- 2** Display the image you want to protect with / .
- 3** Press MENU.
The menu appears.
- 4** Select (Protect) with / , then press .

The image currently being displayed is now protected, and the (Protect) mark is indicated on the screen.

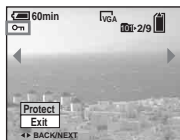

- 5** To protect other images, display the image you want to protect with / , then press .

To cancel the protection

In Step **4** or **5**, press again. The mark disappears.

On the Index screen

- 1** Set the mode dial to , press (index) to switch to the Index screen.
- 2** Press MENU.
The menu appears.
- 3** Select (Protect) with / , then press .
- 4** Select [Select] with / , then press .
- 5** Select the image you want to protect with / / / , then press .

The green (Protect) mark is indicated on the selected image.



- 6** To protect other images, repeat Step **5**.
- 7** Press MENU.

- 8** Select [OK] with **▶**, then press **●**.

The **Ⓚ** mark turns white and the selected image is protected.

To cancel the protection

In Step **4**, select [Cancel], or in Step **8**, select [Exit].

To release protection

In Step **5**, select an image for which you want to release protection with **▲▼/◀▶** and press **●**. The **Ⓚ** mark turns gray and repeat this operation for all the images for which you want to release protection. Then, press MENU, select [OK], and press **●**.

To protect all the images in the folder

In Step **4**, select [All In This Folder], then press **●**. Next, select [On], then press **●**.

To release protection of all the images in the folder

In Step **4**, select [All In This Folder], and press **●**. Then select [Off], and press **●**.

Changing image size

– Resize

You can change the image size of a recorded image, and save it as a new file. You can resize to the following sizes.

5M, 3M, 1M, VGA

The original image is retained even after resizing.

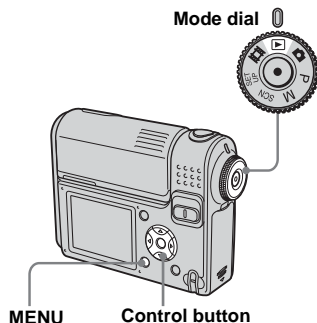

- 1** Set the mode dial to **▶**.
- 2** Display the image you want to resize with **◀▶**.
- 3** Press MENU.
The menu appears.

- 4** Select **◻** (Resize) with **◀▶**, then press **●**.

- 5** Select the new size with **▲▼**, then press **●**.

The resized image is recorded in the recording folder as the newest file.

To cancel the resizing

In Step **5**, select [Cancel].

- Movies or images recorded in Multi Burst mode cannot be resized.
- When images are resized from a smaller to a larger size, the image quality will deteriorate.
- You cannot resize to 3:2-sized image.
- If you try to resize a 3:2-sized image, black bands will appear at the top and bottom of the image.

Choosing images to print

– Print (DPOF) mark

You can designate certain images to be printed.

This function is convenient when you want to print images at a shop or using a printer that conforms with the DPOF (Digital Print Order Format) standard or using PictBridge compliant printers.

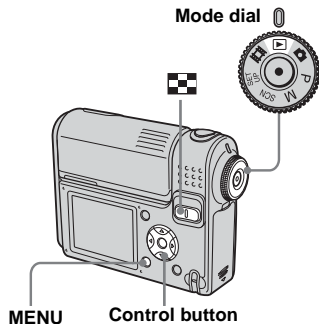

- You cannot mark movies.
- When you mark images shot in Multi Burst mode, all the images are printed on one sheet divided into 16 panels.
- You cannot set the number of print sheets.

On the single screen

- 1** Set the mode dial to .
- 2** Display the image you want to print with .
- 3** Press MENU.
The menu appears.
- 4** Select DPOF (DPOF) with , then press .

The mark is indicated on this image.



- 5** To mark other images, display the image you want to mark with , then press .

To delete the mark

In Step **4** or **5**, press again. The mark disappears.

On the Index screen

- 1** Set the mode dial to and press (index) to switch to the Index screen.
 - 2** Press MENU.
The menu appears.
 - 3** Select DPOF (DPOF) with , then press .
 - 4** Select [Select] with , then press .
 - 5** Select the images you want to mark with , , , then press .
- You cannot mark using the [All In This Folder] option.

The green mark is indicated on the selected image.



- 6** To mark other images, repeat Step **5** for each of them.

7 Press MENU.

8 Select [OK] with ►, then press ●.

The  mark turns white and the setting is completed.

To delete the mark

In Step **5**, select the image you want to delete the  mark with ▲/▼/◀/▶, and press ●.

To delete all the marks from the images in the folder

In Step **4**, select [All In This Folder], then press ●. Next, select [Off], then press ●.

To cancel the marking

In Step **4**, select [Cancel], or in Step **8**, select [Exit].

Connecting to a PictBridge compliant printer

Even if you do not have a computer, you can easily print images shot using your camera by connecting the camera to a PictBridge compliant printer. For preparation, you only need to select the USB connection in the SET UP settings and connect the camera to the printer using a USB multi cable.

Using a PictBridge compliant printer allows you to easily print the Index prints*.

PictBridge

- * An Index print function may not be provided depending on the printer.
- When printing images, we recommend that you use the fully charged battery pack or AC Adaptor to prevent the camera turning off.

Preparing the camera

Set the USB mode on the camera to connect the camera with a printer.

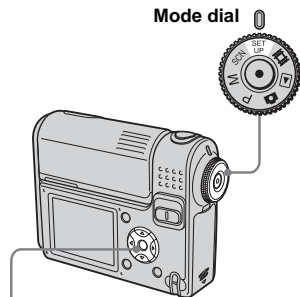

Control button

- 1** Set the mode dial to **SET UP**.
- 2** Select  (Setup 2) with **▼**, then select **[USB Connect]** with **▶/▲/▼**.
- 3** Select **[PictBridge]** with **▶/▲**, then press **●**.

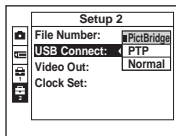



The USB mode is set.

Connecting the camera to the printer

Connect the multi connector on the camera and the USB connector on the printer using a USB multi cable, and turn on the camera and the printer.

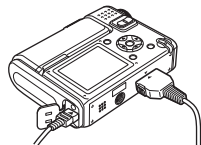
The camera turns to playback mode regardless of the mode dial position and an image in the selected playback folder is displayed on the LCD screen.



After the connection is made, the  mark is indicated on the LCD screen.

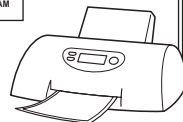
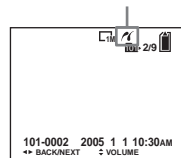

Printer

When [USB Connect] is not set to [PictBridge] in the SET UP settings

You cannot use the PictBridge function, even when you turn on the camera. Disconnect the USB multi cable and set [USB Connect] to [PictBridge] (page 73).

Printing images

You can select an image and print it. Set up the camera following the procedure on page 73, and then connect the printer.

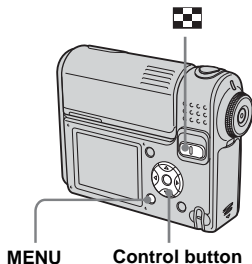



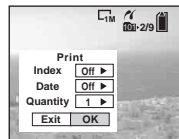

- You cannot print movies.
- If an error message is sent from the connected printer during the connection,  flashes for about five seconds. In such cases, check the printer.

On the single screen

- 1** Display the image you want to print with  .
 - 2** Press MENU.
The menu appears.
 - 3** Select  (Print) with  , then press .
 - 4** Select [This image] with  , then press .
- The Print screen appears.



- Setting items not available for a particular printer are not displayed.
- 5** Select [Quantity] with  , select the number of images with  .
- You can select the number up to 20.

6 Select [OK] with ▼/►, then press ●.

The image is printed.

Do not disconnect the USB multi cable while the  (Not disconnect USB multi cable) mark is indicated on the LCD screen.



To cancel printing

In Step **4**, select [Cancel] or in Step **6**, select [Exit].

To print other images

After Step **6**, select another image, then select [Print] with ▲.

To print all the images indicated with the mark

In Step **4**, select [DPOF image]. All the images indicated with the  mark are printed in the specified number, regardless of the image displayed.

To insert the date and time on images

In Step **5**, select [Date], then select the date format with ◀/▶. You can select from [Day&Time] or [Date]. When you chose [Date], the date will be inserted in the order set in “Setting the date and time” (page 17). However, this function may not be provided depending on the printer.

On the Index screen

1 Press  (index) to switch to the Index screen.

2 Press MENU.

The menu appears.

3 Select  (Print) with ▶, then press ●.

4 Select [Select] with ◀/▶, then press ●.

5 Select the image you want to print with ▲/▼/◀/▶, then press ●.

The ✓ mark is indicated on the selected image.



6 To print other images, repeat Step **5**.

7 Press MENU.

The Print screen appears.

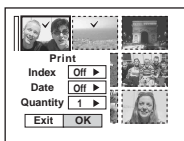

- Setting items not available for a particular printer are not displayed.

8 Select [Quantity] with ▲/▼, select the number of images with ◀/▶.

You can select the number up to 20. All the images selected are printed in the specified number.

9 Select [OK] with ▼/▶, then press ●.

The images are printed. Do not disconnect the USB multi cable while the  mark is indicated on the LCD screen.

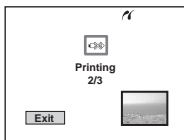

To cancel printing

In Step 4, select [Cancel] or in Step 9, select [Exit].

To print all the images indicated with the mark

In Step 4, select [DPOF image]. All the images indicated with the  mark are printed in the specified number, regardless of the image displayed.

To print all the images in the folder

In Step 4, select [All In This Folder], then press ●.

To insert the date and time on images

In Step 8, select [Date], then select the date format with ◀/▶. You can select from [Day&Time] or [Date]. When you chose [Date], the date will be inserted in the order set in “Setting the date and time” (page 17). However, this function may not be provided depending on the printer.

Printing index-images

You can print some images side-by-side. We refer to this function as an index print*. You can lay single images side-by-side in a specified number and print them (see “On the single screen”), or lay different images side-by-side to make a set by combining multiple different images and print the set in the specified number of copies (see “On the Index screen”). Set up the camera following the procedure on page 73, and connect the printer.

* An index print function may not be provided depending on a printer.

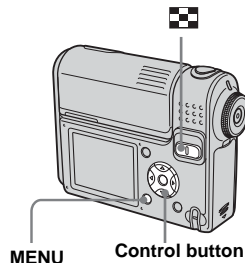





- You cannot print movies.
- If an error message is sent from the connected printer during the connection,  flashes for about five seconds. In such cases, check the printer.



On the single screen

1 Display the image you want to print with / .

2 Press MENU.

The menu appears.



3 Select  (Print) with / , then press .

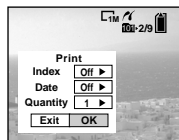

4 Select [This image] with / , then press .

The Print screen appears.





- Setting items not available for a particular printer are not displayed.

5 Select [Index] with , select [On] with / .

6 Select [Quantity] with , select the number of images laid side-by-side with / .

You can select the number up to 20.

You can lay the specified number of images side-by-side.

7 Select [OK] with , then press .

The image is printed.

Do not disconnect the USB multi cable while the  (Not disconnect USB multi cable) mark is indicated on the LCD screen.



To cancel printing

In Step **4**, select [Cancel] or in Step **7**, select [Exit].



To print other images

After Step **7**, select another image, then select [Print] with . Then repeat from Step **4**.

To print all the images indicated with the mark

In Step **4**, select [DPOF image]. All the images indicated with the  mark are printed, regardless of the image displayed.

To insert the date and time on images

In Step **6**, select [Date], then select the date format with /. You can select from [Day&Time] or [Date]. When you chose [Date], the date will be inserted in the order set in “Setting the date and time” (page 17). However, this function may not be provided depending on the printer.

- All the images may not be laid on a sheet depending on the number of images.



On the Index screen





1 Press  (index) to switch to the Index screen.

2 Press MENU.

The menu appears.

3 Select  (Print) with , then press .

4 Select [Select] with /, then press .



5 Select the desired image with //, then press .





The  mark is indicated on the selected image.





6 To print other images, repeat Step **5**.

7 Press MENU.

8 Select [Index] with , then select [On] with .

9 Select [Quantity] with /, select the number of copies you want to print with /.

You can select the number up to 20.

10 Select [OK] with /, then press .

The images are printed.

Do not disconnect the USB multi cable while the  mark is indicated on the LCD screen.

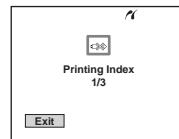

To cancel printing

In Step **4**, select [Cancel] or in Step **10**, select [Exit].

To print all the images indicated with the mark

In Step **4**, select [DPOF image]. All the images indicated with the  mark are printed, regardless of the image displayed.

To print all the images in the folder

In Step **4**, select [All In This Folder], then press **●**.

To insert the date and time on images

In Step **9**, select [Date], then select the date format with **◀/▶**. You can select from [Day&Time] or [Date]. When you chose [Date], the date will be inserted in the order set in “Setting the date and time” (page 17). However, this function may not be provided depending on the printer.

Shooting movies

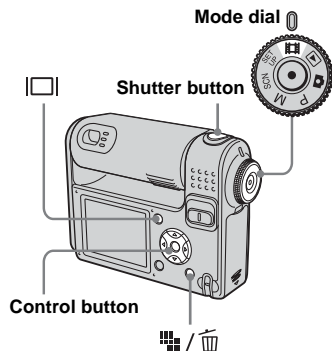

You can shoot movies with audio.



1 Set the mode dial to .

2 Press  / . (Image Size).

The Image Size setup item appears.

3 Select the desired mode with  / .

You can choose from [640 (Standard)] or [160].

4 Press the shutter button fully down.

“REC” appears on the LCD screen and the camera starts recording the image and sound.



• When the capacity of the “Memory Stick” is used up, recording stops.

5 Press the shutter button fully down again to stop recording.

Indicators on the LCD screen while you are shooting movies

These indicators are not recorded.

Each time you press , the status of the LCD screen changes as follows: Indicators off → LCD screen off → Indicators on.

A histogram is not displayed.

See page 125 for a detailed description of the indicated items.

To shoot close-ups (Macro)

Set the mode dial to  and follow the procedure on page 27.

To shoot with a self-timer

Set the mode dial to  and follow the procedure on page 28.

- Be careful not to touch the microphone (page 8) during shooting.
- The following functions cannot be used.
 - Changing the zoom scaling
 - Shooting with the flash
 - Inserting date and time
- See page 113 for the recording time allowed for each image size.

Viewing movies on the LCD screen

You can view movies on the LCD screen of the camera and hear sounds from the speaker of the camera.

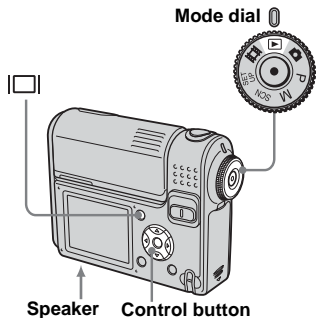

1 Set the mode dial to .

2 Select the desired movie with .

Movies with the image size [640 (Standard)] are displayed on the full screen.

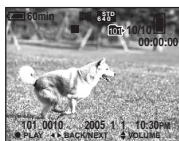

Movies with the image size [160] are displayed a size smaller than still images.

3 Press .

The movie images and sound are played back.
▶ (playback) appears on the LCD screen while a movie is playing back.





Playback bar



To stop playback

Press  again.

To adjust the volume

Adjust the volume with / .

To fast-forward / rewind

Press  (next) or  (previous) while playing back a movie.

To return to normal playback, press .

Indicators on the LCD screen while you are viewing movies

Each time you press , the status of the LCD screen changes as follows: Indicators off → LCD screen off → Indicators on.

A histogram is not displayed.

See page 127 for a detailed description of the indicated items.

- The procedure for viewing movies on a TV is the same as that for viewing still images (page 40).
- A movie recorded using other Sony devices may be displayed a size smaller than still images.

Deleting movies

You can delete unwanted movies.

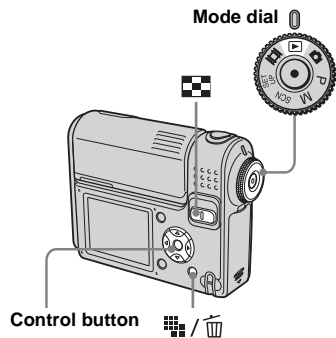

- You cannot delete the protected movies.
- Note that the movies once deleted cannot be recovered.

On the single screen

- 1** Set the mode dial to .
- 2** Select the movie you want to delete with /▶.
- 3** Press / (delete).
The movie has not yet been deleted at this point.
- 4** Select [Delete] with ▲, then press ●.
“Access” appears on the LCD screen and the movie is deleted.
- 5** To delete other movies, display the movie you want to delete with /▶, then repeat Step **4**.

To cancel the deletion

In Step **4** or **5**, select [Exit].

On the Index screen

- 1** Set the mode dial to and press (index) to switch to the Index screen.
- 2** Press / (delete).
- 3** Select [Select] with /▶, then press ●.
- 4** Select the movies you want to delete with ▲/▼/◀/▶, then press ●.
The (delete) mark is indicated on the selected movie.



The movie has not yet been deleted at this point.

- 5** Repeat Step **4** to delete other movies.
- 6** Press / (delete).
- 7** Select [OK] with ▶, then press ●.
“Access” appears on the LCD screen and the movie will be deleted.

To cancel the deletion

In Step **3** or **7**, select [Exit].

To delete all the images in the folder

In Step **3**, select [All In This Folder], then press **●**. Next, select [OK], then press **●**.

To cancel the deletion, select [Cancel] with **◀**, then press **●**.

Cutting movies

You can cut movies, or delete unnecessary portions of movies (page 42). This is the recommended function to use when the “Memory Stick” capacity is insufficient, or when you attach movies to your e-mail messages.

Note that the original movie is deleted after you cut it.

The file numbers assigned when movies are cut

The cut movies are assigned new numbers and recorded as the newest files in the recording folder. The original movie is deleted and its file number is skipped.

<Example> Cutting the movie numbered 101_0002

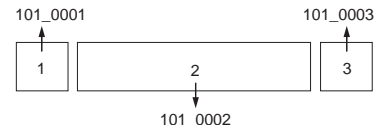

1. Cutting scene A.

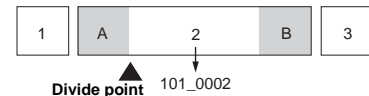

2. Cutting scene B.

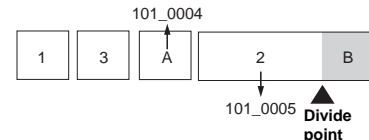



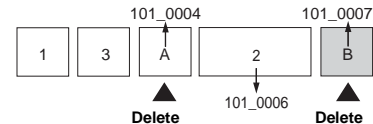



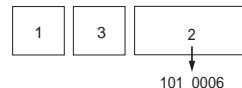

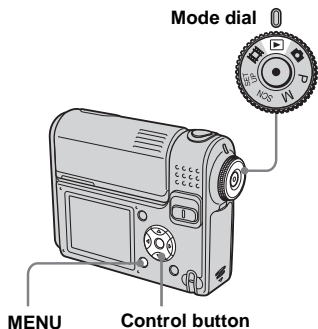
3. Deleting scenes A and B if they are unnecessary.



4. Only the desired scenes remain.











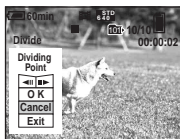

- 1** Set the mode dial to .
 - 2** Select the movie you want to cut with / .
 - 3** Press **MENU**.
The menu appears.
 - 4** Select  (Divide) with , then press . Next, select [OK] with , then press .
- The playback of the movie starts.



5 Decide on a cutting point.

Press  at the desired cutting point.



When you want to adjust the cutting point, select [|] (frame rewind/forward) and adjust the cutting point with / . If you want to change the cutting point, select [Cancel]. The playback of the movie starts again.

- 6** When you have decided on a cutting point, select [OK] with / , and press .

- 7** Select [OK] with , then press .
- The movie is cut.

To cancel cutting

In Step **5** or **7**, select [Exit]. The movie appears on the LCD screen again.

- You cannot cut the following images.
 - Still images
 - Movies not long enough to cut
 - Protected movies
- You cannot restore movies once you cut them.
- The cut movie is recorded in the selected recording folder as the newest file.

Copying images to your computer

– For Windows users

Recommended computer environment

OS: Microsoft Windows 98, Windows 98SE, Windows 2000 Professional, Windows Millennium Edition, Windows XP Home Edition, or Windows XP Professional

The above OS must be installed at the factory. Operation is not assured in an environment upgraded to the operating systems described above or in a multi-boot environment.

CPU: MMX Pentium 200 MHz or faster

USB connector: Provided as standard

Display: 800 × 600 dots or more High Color (16-bit color, 65,000 colors) or more

- This camera is compatible with Hi-Speed USB (USB 2.0 compliant).
- Connecting with a USB interface that is compatible with Hi-Speed USB (USB 2.0-compliant) allows advanced transfer (high-speed transfer).
- If you connect two or more USB equipment to a single computer at the same time, some equipment, including your camera, may not

operate depending on the type of USB equipment.

- Operations are not guaranteed when using a USB hub.
- Operations are not guaranteed for all the recommended computer environments mentioned above.

USB mode

There are two modes for a USB connection when connecting with a computer, [Normal] and [PTP]* modes. The default setting is the [Normal] mode. This section describes the [Normal] mode as an example.

* Compatible only with Windows XP. When connected to a computer, only the data in the folder selected by the camera is copied to the computer. To select the folder, follow the procedure on page 63.

Communication with your computer

When your computer resumes from the suspend or sleep mode, communication between your camera and your computer may not recover at the same time.

When a USB connector is not provided on your computer

When neither a USB connector nor a “Memory Stick” slot is provided, you can

copy images using an additional device. See the Sony Website for details.

<http://www.sony.net/>

Contents of the CD-ROM

■ USB Driver

This driver is needed in order to connect the camera to a computer.

When using Windows XP, you need not install the USB driver.

■ Picture Package

This application is used to transfer images from the camera to a computer easily. It also allows you to utilize the various functions. When you install “Picture Package,” the USB driver will be installed at the same time.

- The required operations may differ depending on your OS.
- **Close down all applications running on the computer before installing the USB driver and application.**
- When using Windows XP or Windows 2000, log on as Administrator.



Installing the USB driver

When using Windows XP, you need not install the USB driver.

Once the USB driver is installed, you need not install the USB driver.

- 1 Turn on your computer, and insert the supplied CD-ROM into the CD-ROM drive.**

Do not connect your camera to your computer at this time.

The install menu screen appears. If it does not appear, double-click  (My Computer) →  (PICTUREPACKAGE) in that order.

- If you are going to use the “Picture Package” application software, click “Picture Package.” The USB driver will be installed when “Picture Package” is installed (page 93).
- When the computer is in use, shut down all application software currently running before you install the USB driver.

- 2 Click [USB Driver] on the title screen.**

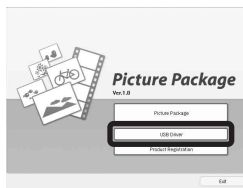

The “InstallShield Wizard” screen appears.

- 3 Click [Next].**



The USB driver installation starts. When the installation is completed, the screen informs you of completion.

- 4 Click [Yes, I want to restart my computer now], then click [Finish].**

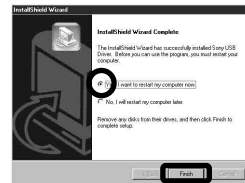

Your computer restarts. Then, you can establish USB connection.

- 5 Remove the CD-ROM.**

Connecting the camera to your computer

- 1** Insert the “Memory Stick” with the images you want to copy into the camera, then close the battery/“Memory Stick” cover.

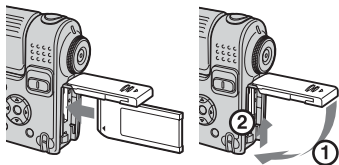

- 2** Open the DC IN jack cover, and connect the AC Adaptor, then plug the adaptor into a wall outlet (wall socket).

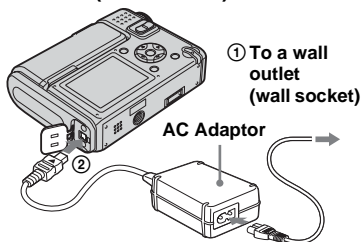

- When you copy images to your computer using the battery pack, copying may fail or the data may be corrupted by battery shutoff. We recommend that you use the AC Adaptor.

- 3** Set the mode dial to  and turn on the camera and your computer.

- You can carry out this operation even when the mode dial is set to SET UP.

- 4** Connect the USB multi cable to the multi connector of the camera.

Rotate the lens portion back to the original position and place the camera with the LCD screen facing upwards.

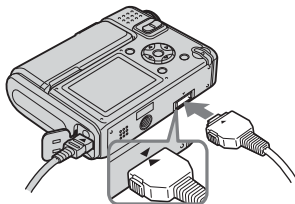

- 5** Connect the USB multi cable to your computer.

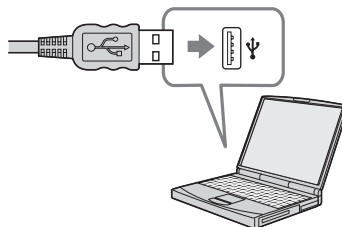

- When using a desktop computer, connect the USB multi cable to the USB connector on the rear panel.
- When using Windows XP, the AutoPlay wizard automatically appears on the desktop. Proceed to page 89.

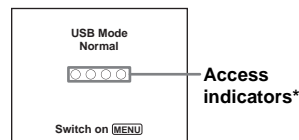

“USB Mode Normal” appears on the LCD screen of the camera. When a USB connection is established for the first time, your computer automatically runs the used program to recognize the camera. Wait for a while.

- During communication, the access indicators turn red. Do not operate the computer until the indicators turn white.
- If “USB Mode Normal” does not appear in Step **5**, press MENU, select [USB Connect], and set it to [Normal].

❑ Disconnecting the USB multi cable, removing the “Memory Stick,” or turning off the camera during a USB connection

For Windows 2000, Me, or XP users

- 1 Double-click  on the tasktray.



Double-click here

- 2 Click  (Sony DSC), then click [Stop].
- 3 Confirm the device on the confirmation window, then click [OK].
- 4 Click [OK].
Step 4 is unnecessary for Windows XP users.
- 5 Disconnect the USB multi cable, remove the “Memory Stick,” or turn off the camera.

For Windows 98 or 98SE users

Confirm that the access indicators (page 87) on the screen are turned white and carry out only Step 5 above.

Copying images

– Windows 98/98SE/2000/Me

- 1 Double-click [My Computer], then double-click [Removable Disk].

The contents of the “Memory Stick” inserted in your camera appear.

- This section describes an example of copying images to the “My Documents” folder.
- When the “Removable Disk” icon is not shown, see page 89.
- When using Windows XP, see page 89.

- 2 Double-click [DCIM], then double-click the folder that the image files you want to copy are stored.

- 3 Right-click the image file to display the menu, then select [Copy] from the menu.

- 4 Double-click the “My Documents” folder and right-click on the “My Documents” window to display the menu, then select [Paste] from the menu.

The image files are copied to the “My Documents” folder.



When an image with the same file name exists in the copy destination folder

The overwrite confirmation message appears. When you overwrite the existing image with the new one, the original file data is deleted.

To change the file name

To copy an image file to the computer without overwriting, change the file name to the desired name before you copy it. However, note that if you change the file name, you may not be able to play back that image with your camera. To play back images with the camera, perform the operation on page 93.

When a removable disk icon is not shown

- 1 Right-click [My Computer] to display the menu, then click [Properties].
The “System Properties” screen appears.
- 2 Display [Device Manager].
 - ① Click [Hardware].
 - ② Click [Device Manager].
 - For Windows 98, 98SE, Me users, Step ① is unnecessary. Click the [Device Manager] tab.
- 3 If [ Sony DSC] is displayed, delete it.
 - ① Right-click [ Sony DSC].
 - ② Click [Uninstall].
The “Confirm Device Removal” screen appears.
 - For Windows 98, 98SE, Me users, click [Remove].
 - ③ Click [OK].
The device is deleted.

Try the USB driver installation again using the CD-ROM (page 86).

– Windows XP

Copying images using the Windows XP AutoPlay wizard

- 1 **Make a USB connection (page 87). Click [Copy pictures to a folder on my computer using Microsoft Scanner and Camera Wizard], then click [OK].**

The “Scanner and Camera Wizard” screen appears.

- 2 **Click [Next].**

The images stored on the “Memory Stick” are displayed.

- 3 **Click the checkbox of images that you do not want to copy to your computer to remove the checkmark, then click [Next].**

The “Picture Name and Destination” screen appears.

- 4 **Select a name and destination for your pictures, then click [Next].**

Image copying starts. When the copying is completed, the “Other Options” screen appears.

- 5 **Select [Nothing. I’m finished working with these pictures], then click [Next].**

The “Completing the Scanner and Camera Wizard” screen appears.

- 6 **Click [Finish].**

The wizard closes.

- To continue copying other images, follow the procedure given under **1** on page 88 to disconnect the USB multi cable and reconnect it. Then, perform the procedure from Step **1** again.

Viewing the images on your computer

1 Click [Start], then click [My Documents].

The “My Documents” folder contents are displayed.

- This section describes the procedure for viewing copied images in the “My Documents” folder.
- When not using Windows XP, double-click [My Documents] on the desktop.

2 Double-click the desired image file.

The image is displayed.

Image file storage destinations and file names

The image files recorded with your camera are grouped as folders in the “Memory Stick.”

Example: when viewing folders on Windows XP

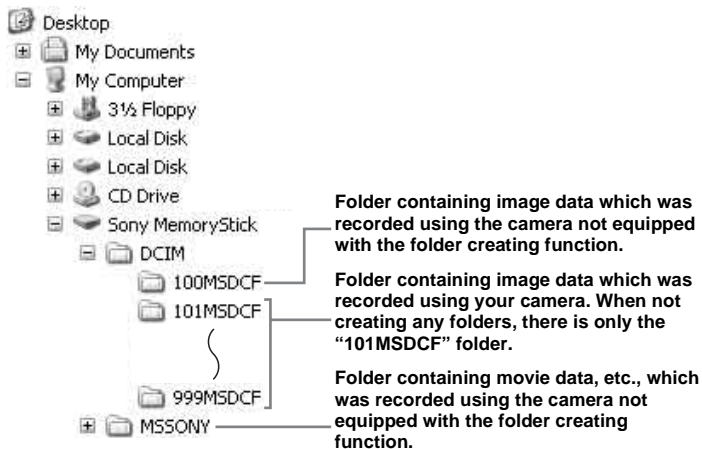

- You cannot record any images to “100MSDCF” or “MSSONY” folders. The images in these folders are available only for viewing.
- For more information about the folder, see pages 48 and 63.

Folder	File name	File meaning
101MSDCF to 999MSDCF	DSC0□□□□.JPG	<ul style="list-style-type: none"> • Still image files shot in <ul style="list-style-type: none"> – Normal mode (page 23) – Burst mode (page 60) – Multi Burst mode (page 61)
	MOV0□□□□.MPG	<ul style="list-style-type: none"> • Movie files (page 80)
	MOV0□□□□.THM	<ul style="list-style-type: none"> • Index image files recorded in movie mode (page 80)

- □□□□ stands for any number within the range from 0001 to 9999.
- The numerical portions of a movie file recorded in movie mode and its corresponding index image file are the same.

Viewing an image previously copied to a computer

This operation is required for viewing image files that have been copied previously to a computer and already deleted from the “Memory Stick” using the camera.

Copy the image files stored on your computer to a “Memory Stick” and view them on the camera.

- Skip Step **1** if you have not changed the file name assigned by this camera.
- You may not be able to view the image depending on the image size.
- Images modified with a computer or images shot using other than this camera may not be able to be played back on the camera.
- If the warning message for overwriting the data appears, enter other numbers in Step **1**.
- If there is no folder to store the image file, create a new folder, then copy the image file. For details on how to create the folder, see page 48.

1 Right-click the image file, then click [Rename]. Change the file name to “DSC0□□□□”.

□□□□ stands for any number within the range from 0001 to 9999.

- A file extension may be indicated depending on the setup of the computer. The extension of a still image is “JPG” and that of a movie is “MPG”. Do not change the extension.

2 Copy the image file to a folder on the “Memory Stick.”

- ① Right-click the image file, then click [Copy].
- ② Select and double-click the [DCIM] folder from [Removable Disk] or [Sony MemoryStick] in [My Computer].
- ③ Right-click the [□□□MSDCF] folder in the [DCIM] folder, then click [Paste].
□□□ stands for any number within the range from 100 to 999.

Installing “Picture Package”

“Picture Package” is only for Windows computers.

You can use the “Picture Package” software on your Windows computer to manage the images shot with your camera. Installing the “Picture Package” software installs the USB driver at the same time.

- When the computer is in use, shut down all application software currently running before you install “Picture Package.”

For computer environment

See page 85 for the basic Windows operating environment.

Other system requirements are as follows.

Software: Macromedia Flash Player 6.0 or later, Windows Media Player 7.0 or later, and DirectX 9.0b or later.

Sound card: 16-bit stereo sound card with speakers

Memory: 64 MB or more (128 MB or more is recommended)

Hard Disk: Disk space required for installation: approximately 200 MB

Display: A video card equipped with 4 MB VRAM (DirectDraw driver compliant)

- When automatically creating slide shows (page 96), a Pentium III 500 MHz or faster CPU is required.



- This software is compatible with the DirectX technology. “DirectX” must be installed before using.
- A separate environment for operating the recording device is required in order to write to CD-Rs.

1 Turn on your computer, and insert the supplied CD-ROM into the CD-ROM drive.

The installation menu screen appears.

- If you have not yet installed the USB driver (page 86), do not connect the camera to the computer before you install the “Picture Package” software (except Windows XP).

2 Click [Picture Package].

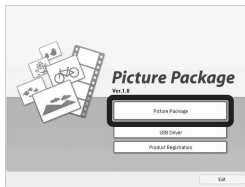

The “Choose Setup Language” screen appears.

3 Select the desired language, then click [Next].

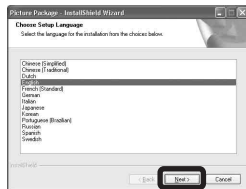

- This section describes the English screen.

4 Click [Next].

The “License Agreement” screen appears.
Read the agreement carefully. If you accept the terms of the agreement, check the “I accept the terms of the license agreement” checkbox, then click [Next].



5 Click [Next].

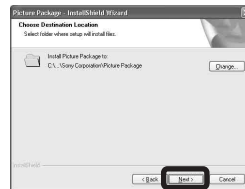

6 Click [Install] on the “Ready to Install the Program” screen.

The installation starts.

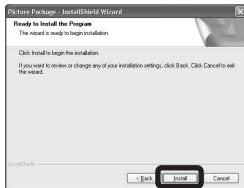

If the “Welcome to setup for DirectX” screen appears after you install the application software, follow the instructions.

7 Confirm if the checkbox of “Yes, I want to restart my computer now” is checked, then click [Finish].

Your computer restarts.



The shortcut icons of [Picture Package Menu] and [Picture Package destination Folder] are displayed.

8 Remove the CD-ROM.

Copying images using “Picture Package”

Connect the camera and your computer with the USB multi cable.

“Picture Package” starts up automatically and the images in the “Memory Stick” are copied to the computer automatically. After the images are copied, “Picture Package Viewer” starts up and the images copied are displayed.



- Normally “Picture Package” and “Date” folders are created inside the “My Documents” folder, and all of the image files recorded with the camera are copied into these folders.
- Windows XP is set so that the OS AutoPlay Wizard activates.
If you deactivate the OS AutoPlay Wizard, cancel the activation using [Settings] on the “Picture Package Menu.”
- If “Picture Package” cannot copy images automatically, start up “Picture Package Menu” and check [Settings] in [Copy automatically].

Using "Picture Package"

Start up the [Picture Package Menu] on the desktop to use the various functions.

- The default screen may differ depending on your computer. You can change the order of the buttons using [Settings] in the lower-right corner of the screen.
- For details on the use of the application software, click  on the upper-right corner of each screen to show the on-line help.

Technical support of "Picture Package" is provided by the Pixela User Support Center. For more information, refer to the enclosed information with the CD-ROM.

Viewing images on a computer

Click [Viewing video and pictures on PC] on the left side of the screen.

Click [Viewing video and pictures on PC] in the lower-right corner of the screen.

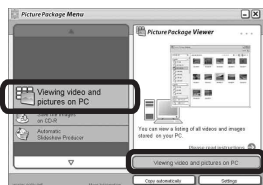

The screen used for viewing images appears.

Saving images on a CD-R

Click [Save the images on CD-R] on the left side of the screen.

Click [Save the images on CD-R] in the lower-right corner of the screen.

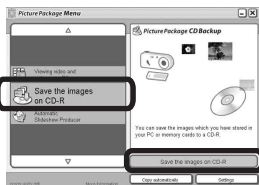

The screen used for saving images on a CD-R appears.

- A CD-R drive is required to save images on a CD-R.
For further information on compatible drives, see the following home page of the Pixela User Support Center.
<http://www.ppackage.com/>

Creating a slide show

Click [Automatic Slideshow Producer] on the left side of the screen.

Click [Automatic Slideshow Producer] in the lower-right corner of the screen.

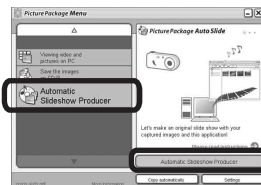

The screen used for creating a slide show appears.

Copying images to your computer

– For Macintosh users

Recommended computer environment

OS: Mac OS 9.1, 9.2, or Mac OS X (v10.0/v10.1/v10.2/v10.3)

The above OS must be installed at the factory.

USB connector: Provided as standard

- If you connect two or more USB equipment to a single computer at the same time, some equipment, including your camera, may not operate depending on the type of USB equipment.
- Operations are not guaranteed when using a USB hub.
- Operations are not guaranteed for all the recommended computer environments mentioned above.

USB mode

There are two modes for a USB connection when connecting with a computer, [Normal] and [PTP]* modes. The default setting is the [Normal] mode. This section describes the [Normal] mode as an example.

* Compatible only with Mac OS X. When connected to a computer, only the data in the folder selected by the camera is copied to the

computer. To select the folder, follow the procedure on page 63.

Communication with your computer

When your computer resumes from the suspend or sleep mode, communication between your camera and your computer may not recover at the same time.

When a USB connector is not provided on your computer

When neither a USB connector nor a “Memory Stick” slot is provided, you can copy images using an additional device. See the Sony Website for details.

<http://www.sony.net/>

1 Connecting your camera to your computer

For details, see page 87.

Disconnecting the USB multi cable, removing the “Memory Stick,” or turning off the camera during a USB connection

Drag and drop the drive icon or the icon of the “Memory Stick” to the “Trash” icon, then remove the USB multi cable, remove the “Memory Stick,” or turn off the camera.

- If you are using Mac OS X v10.0, remove the USB multi cable etc., after you have turned your computer off.

2 Copying images

- 1 Double-click the newly recognized icon on the desktop.

The contents of the “Memory Stick” inserted in your camera appear.

- 2 Double-click “DCIM.”
- 3 Double-click the folder that the images you want to copy are stored.
- 4 Drag and drop the image files to the hard disk icon.

The image files are copied to your hard disk.

For details on the storage location of the images and file names, see page 91.

3 Viewing the images on your computer

- 1 Double-click the hard disk icon.
 - 2 Double-click the desired image file in the folder containing the copied files. The image file opens.
- “Picture Package” cannot be used with Macintosh.

Using “ImageMixer VCD2”

“ImageMixer VCD2” is only for Macintosh computers (Mac OS X (v10.1.5) or later one).

Using “ImageMixer VCD2” on the CD-ROM supplied with your camera, you can create a video CD using the image or movie materials that are stored in your computer. You can create an image file that is compatible with the video CD creation function of Toast by Roxio (not supplied).

- When the computer is in use, shut down all other application software currently running before you install “ImageMixer VCD2.”

Technical support of “ImageMixer VCD2” is provided by the Pixela User Support Center. For more information, refer to the enclosed information with the CD-ROM.

Required computer environment

OS: Mac OS X (v10.1.5 or later)

The above OS must be installed at the factory

CPU: iMac, eMac, iBook, PowerBook, Power Mac G3/G4 series

Memory: 128 MB or more (256 MB or more is recommended)

Hard Disk: Disk space required for installation: approximately 250 MB

Display: 1,024 × 768 dots or more, 32,000 colors or more

- QuickTime 4 or later must be pre-installed (QuickTime 5 is recommended).
- Operations are not guaranteed for all recommended computer environments mentioned above.

1 Installing “ImageMixer VCD2”

- 1 Turn on your computer.
 - The display settings should be $1,024 \times 768$ dots or higher and 32,000 colors or higher.
- 2 Insert the supplied CD-ROM into the CD-ROM drive.
- 3 Double-click the CD-ROM icon.
- 4 Copy the [IMXINST.SIT] file in the [MAC] folder to the hard disk icon.
- 5 Double-click the [IMXINST.SIT] file in the copy-to folder.
- 6 Double-click the [ImageMixer VCD2_Install] extracted file.
- 7 After the user information screen appears, enter the desired name and password.
The installation of the software starts.

2 Creating a video CD

- 1 Open the [ImageMixer] folder in [Application].
- 2 Click [ImageMixer VCD2].
- 3 Click [Video CD].
The video disc mode starts up.
 - You cannot create a DVD Video.
- 4 Select the folder in which the desired images are stored.
 - ① Select the desired folder on the left frame, then click [Add]. The selected folder moves to the right frame.
 - ② Click [Next].

- 5 Set up the menu background, buttons, titles, and so on, then click [Next].
Confirm the set up according to your preferences.
- 6 Confirm the preview of the Video CD file.
 - ① Click the file you want to preview on the left frame.
 - ② Click [▶] to preview the file.
- 7 Click [Next] and enter the disk name and its destination.
The preparation for storing the file on a CD-R is completed.
 - “ImageMixer VCD2” can create only the disk image to store the image file on a CD-R in the video CD format. Toast by Roxio (not supplied) is required to create a video CD.

Troubleshooting

If you have trouble with your camera, try the following solutions.

- 1 First, check the items on pages 100 to 109. **If the LCD screen shows “C:□□:□□,” the self-diagnosis function is working. Please see page 112.**

- 2 Should your camera still not work properly, press the RESET button inside the battery/“Memory Stick” cover using a fine-tipped object, then turn on the camera again. (This will clear the date and time settings, etc.)

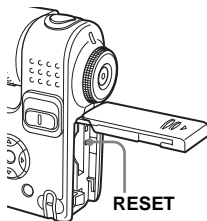















- 3 Should your camera still not work properly, consult your Sony dealer or local authorized Sony service facility.





Battery pack and power





























Symptom	Cause	Solution
You cannot charge the battery pack.	<ul style="list-style-type: none">• The camera is turned on.	<ul style="list-style-type: none">→ Turn the camera off (page 15).
The battery pack cannot be installed.	<ul style="list-style-type: none">• The battery pack is not installed correctly.	<ul style="list-style-type: none">→ Install the battery pack while pushing the battery eject lever toward the front of the camera using the front edge of the battery pack (page 11).→ Install the battery pack correctly (page 11).
The $\frac{1}{2}$/CHG lamp flashes when charging a battery pack.	<ul style="list-style-type: none">• The battery pack is not installed correctly.• The battery pack has malfunctioned.• The battery pack is discharged.	<ul style="list-style-type: none">→ Install the battery pack correctly (page 11).→ Consult your Sony dealer or local authorized Sony service facility.→ Disconnect the AC Adaptor from the DC IN jack of your camera and from the wall outlet (wall socket), and connect it again. Then charge the battery pack (page 11).

Symptom	Cause	Solution
The $\frac{1}{2}$CHG lamp does not light up when charging a battery pack.	<ul style="list-style-type: none"> • The AC Adaptor is disconnected. • The AC Adaptor has malfunctioned. • The battery pack is not installed correctly. • The battery pack is completely charged. • The battery pack is discharged. 	<ul style="list-style-type: none"> → Properly connect the AC Adaptor (page 11). → Consult your Sony dealer or local authorized Sony service facility. → Install the battery pack correctly (page 11). — → Disconnect the AC Adaptor from the DC IN jack of your camera and from the wall outlet (wall socket), and connect it again. Then charge the battery pack (page 11).
The battery remaining indicator is incorrect. Or the sufficient battery remaining indicator is displayed but the power soon runs out.	<ul style="list-style-type: none"> • You have used the camera in an extremely cold location. • A deviation has occurred in the remaining battery time. • The battery pack is discharged. • The battery pack is dead (page 121). 	<ul style="list-style-type: none"> → See page 121. → Fully discharge and then charge the battery pack so that the battery remaining indicator functions correctly (page 12). → Install a charged battery pack (page 11). → Replace the battery pack with a new one.
The battery pack runs down too quickly.	<ul style="list-style-type: none"> • You are using in an extremely cold location. • The DC plug is dirty so the battery pack is not charged enough. • The battery pack is dead (page 121). 	<ul style="list-style-type: none"> → See page 121. → Clean the pins of the DC plug with a cotton swab, etc., and charge the battery pack (page 11). → Replace the battery pack with a new one.
The power cannot be turned on.	<ul style="list-style-type: none"> • The battery pack is not installed properly. • The AC Adaptor is disconnected. • The AC Adaptor has malfunctioned. • The battery pack is discharged. • The battery pack is dead (page 121). 	<ul style="list-style-type: none"> → Properly install the battery pack (page 11). → Connect it securely to your camera (page 14). → Consult your Sony dealer or local authorized Sony service facility. → Install a charged battery pack (page 11). → Replace the battery pack with a new one.
The power turns off suddenly.	<ul style="list-style-type: none"> • If you do not operate the camera for about three minutes while the power is on, the camera turns off automatically to prevent wearing down the battery (page 15). • The battery pack is discharged. 	<ul style="list-style-type: none"> → Turn on the camera again or use the AC Adaptor (page 15). → Install a charged battery pack (page 11).



Shooting still images / movies

Symptom	Cause	Solution
The LCD screen is not turned on even when the power is turned on.	<ul style="list-style-type: none"> The power was turned off with the LCD screen turned off the last time you used the camera. 	→ Turn on the LCD screen (page 32).
The subject is not visible on the LCD screen.	<ul style="list-style-type: none"> The mode dial is not set to , P, M, SCN or . 	→ Set it to  , P, M, SCN or  (pages 23 and 80).
The image is out of focus.	<ul style="list-style-type: none"> The subject is too close.  (Magnifying glass mode),  (Twilight mode),  (Landscape mode) or  (Fireworks mode) is selected for the Scene Selection function. You have set the focus preset distance. 	<p>→ Use the macro recording mode and set the lens portion farther away from the subject than the shortest shooting distance (page 27). Or select  (Magnifying glass mode) as the Scene Selection function and shoot the image within the recommended distance (page 34).</p> <p>→ Set it to other modes than  (Magnifying glass mode),  (Twilight mode),  (Landscape mode) or  (Fireworks mode) (page 37).</p> <p>→ Set to the auto focus mode (page 51).</p>
Optical zoom does not function.	<ul style="list-style-type: none"> You cannot change the zoom scaling while shooting a movie.  (Magnifying glass mode) is selected for the Scene Selection function when shooting still images. 	<p>—</p> <p>→ Set it to other modes than  (Magnifying glass mode) (page 34).</p>
Precision digital zoom does not function.	<ul style="list-style-type: none"> [Digital Zoom] is set to [Smart] or [Off] in the SET UP settings. This function cannot be used when you shoot a movie. 	<p>→ Set [Digital Zoom] to [Precision] (pages 25, 47 and 117).</p> <p>—</p>
Smart zoom does not function.	<ul style="list-style-type: none"> [Digital Zoom] is set to [Precision] or [Off] in the SET UP settings. The image size is set to [5M] or [3:2]. You are shooting in Multi Burst mode. This function cannot be used when you shoot a movie. 	<p>→ Set [Digital Zoom] to [Smart] (pages 25, 47 and 117).</p> <p>→ Set image size to other settings except [5M] and [3:2] (pages 20 and 26).</p> <p>→ The smart zoom cannot be used in Multi Burst mode (pages 25 and 61).</p> <p>—</p>

Symptom	Cause	Solution
The image is too dark.	<ul style="list-style-type: none"> You are shooting a subject with a light source behind the subject. The brightness of the LCD screen is too low. 	<ul style="list-style-type: none"> → Select the metering mode (page 57). → Adjust the exposure (pages 54, 55, 114 and 116). → Adjust the brightness of the LCD backlight (pages 47 and 118).
The image is too bright.	<ul style="list-style-type: none"> You are shooting a spot lighted subject in a dark location such as on a stage. The brightness of the LCD screen is too high. 	<ul style="list-style-type: none"> → Adjust the exposure (pages 54, 55, 114 and 116). → Adjust the brightness of the LCD backlight (pages 47 and 118).
The image is monochrome (black and white).	<ul style="list-style-type: none"> [PFX] (P.Effect) is set to [B&W]. 	<ul style="list-style-type: none"> → Set it to the other modes than [B&W] (page 62).
Vertical streaks appear when you are shooting a very bright subject.	<ul style="list-style-type: none"> The smear phenomenon is occurring. 	<ul style="list-style-type: none"> → This is not a malfunction.
When looking at the LCD screen in a dark place, some noise may show up on the LCD screen.	<ul style="list-style-type: none"> The camera temporarily brightens the LCD screen to allow you to check the image being displayed while you are using the camera in a dark place. 	<ul style="list-style-type: none"> → This will have no effect on the image you shoot.
You cannot shoot images.	<ul style="list-style-type: none"> No “Memory Stick” is inserted. The capacity of the “Memory Stick” is full. The write-protect switch on the “Memory Stick” is set to the LOCK position. You cannot shoot while the flash is charging. When you shoot a still image, the mode dial is not set to , P, M or SCN. The mode dial is not set to  when you want to shoot a movie. 	<ul style="list-style-type: none"> → Insert a “Memory Stick” (page 19). → Delete the images saved in the “Memory Stick” (page 42). → Change the “Memory Stick.” → Set it to the recording position (page 120). — → Set the mode dial to , P, M or SCN (page 23). → Set the mode dial to  (page 80).
Recording takes a long time.	<ul style="list-style-type: none"> NR slow shutter function is activated. 	<ul style="list-style-type: none"> → See page 37.

Symptom	Cause	Solution
Cannot shoot images with the flash.	<ul style="list-style-type: none"> The mode dial is set to , SET UP or . The flash is set to  (No flash).  (Twilight mode),  (Fireworks mode) or  (Candle mode) is selected for the Scene Selection function when shooting still images.  (Magnifying glass mode),  (Landscape mode),  (Snow mode),  (Beach mode) or  (high-speed shutter mode) is selected for the Scene Selection function when shooting still images. The camera is in Multi Burst or Burst mode. 	<ul style="list-style-type: none"> → Set the mode dial to , P, M or SCN (pages 23 and 37). → Set the flash to “Auto” (No indicator),  (Forced flash), or  (Slow synchro) (page 29). → Select other modes than  (Twilight mode),  (Fireworks mode) or  (Candle mode) (page 34). → Set the flash to  (Forced flash) (page 29). → Cancel the Multi Burst or Burst mode.
The macro mode does not function.	<ul style="list-style-type: none">  (Magnifying glass mode),  (Twilight mode),  (Landscape mode),  (Fireworks mode) or  (Candle mode) is selected for the Scene Selection function when shooting still images. 	<ul style="list-style-type: none"> → Select other modes than  (Magnifying glass mode),  (Twilight mode),  (Landscape mode),  (Fireworks mode) or  (Candle mode) (page 34).
You cannot shoot images in succession.	<ul style="list-style-type: none"> The capacity of the “Memory Stick” is full. The battery level is low and you can shoot only one image. 	<ul style="list-style-type: none"> → Delete unnecessary images saved in the “Memory Stick” (pages 42 and 82). → Install a charged battery pack (page 11).
The eyes of the subject come out red.	—	→ Set [Red Eye Reduction] to [On] (page 30).
The date and time are recorded incorrectly.	<ul style="list-style-type: none"> The date and time are not set correctly. 	→ Set the correct date and time (page 17).
The aperture value and shutter speed flash when you press and hold the shutter button halfway down.	<ul style="list-style-type: none"> The exposure is incorrect. 	→ Adjust the exposure (page 55).
Unknown horizontal line appears on the finder.	<ul style="list-style-type: none"> This is due to the structure of the finder. 	→ This is not a malfunction.

Viewing images

Symptom	Cause	Solution
The image cannot be played back.	<ul style="list-style-type: none"> The mode dial is not set to . You changed the folder/file name on a computer. You cannot play back the image on the camera if you modify the image on a computer. The camera is in USB mode. 	→ Set the mode dial to  (page 38). → See page 93. — → Cancel USB communication (page 88).
The image is coarse right after being played back.	<ul style="list-style-type: none"> The image momentarily becomes rough for image processing. 	→ This is not a malfunction.
The images cannot be played back on a TV.	<ul style="list-style-type: none"> The [Video Out] setting for the camera in SET UP is incorrect. The connection is not correct. 	→ Set [Video Out] to [NTSC] or [PAL] (pages 47 and 118). → Check the connection (page 40).
The images cannot be played back on a computer.	—	→ See page 106.

Deleting/editing an image

Symptom	Cause	Solution
Your camera cannot delete an image.	<ul style="list-style-type: none"> The image is protected. The write-protect switch on the “Memory Stick” is set to the LOCK position. 	→ Cancel the protection (page 69). → Set it to the recording position (page 120).
You have deleted the image by mistake.	<ul style="list-style-type: none"> Once you have deleted an image, you cannot restore it. 	→ Protecting the image can prevent accidental erasure (page 69). → The write-protect switch on the “Memory Stick” will prevent you from deleting images by mistake (page 120).
The resizing function does not work.	<ul style="list-style-type: none"> You cannot resize movies or Multi Burst images. 	—
You cannot attach a print (DPOF) mark.	<ul style="list-style-type: none"> Print (DPOF) marks cannot be attached to movies. 	—
You cannot cut an image.	<ul style="list-style-type: none"> The movie is not long enough to cut. Protected movies cannot be cut. Still images cannot be cut. 	— → Cancel the protection (page 69). —

Computers

Symptom	Cause	Solution
You do not know whether or not your OS can be used with the camera.	—	→ Check “Recommended computer environment” (pages 85 and 97).
You cannot install the USB driver.	—	→ In Windows 2000, log on as Administrator (authorized Administrators) (page 85).
Your computer does not recognize your camera.	<ul style="list-style-type: none"> • The camera is turned off. • The battery level is too low. • You are not using the supplied USB multi cable. • The USB multi cable is not connected securely. <ul style="list-style-type: none"> • [USB Connect] is not set to [Normal] in the SET UP settings. • The USB connectors on your computer are connected to other equipment besides the keyboard, the mouse. • The camera is not directly connected to your computer. • The USB driver is not installed. • Your computer does not properly recognize the device because you connected the camera and your computer with the USB multi cable before you installed the “USB Driver” from the supplied CD-ROM. 	<ul style="list-style-type: none"> → Turn on the camera (page 15). → Use the AC Adaptor (page 14). → Use the supplied USB multi cable (page 87). → Disconnect the USB multi cable, and securely connect it again. Make sure that “USB Mode” is displayed on the LCD screen (page 87). → Set it to [Normal] (page 118). <ul style="list-style-type: none"> → Disconnect the USB cables except for those connected to the keyboard and the mouse (page 85). <ul style="list-style-type: none"> → Directly connect the camera and your computer without using a USB hub (page 85). → Install the USB driver (page 86). → Delete the erroneously recognized device from your computer (page 89), then install the USB driver (page 86).
You cannot copy images.	<ul style="list-style-type: none"> • The camera is not correctly connected to your computer. • The copy procedure differs depending on your OS. • You shot with a “Memory Stick” that was formatted using a computer. 	<ul style="list-style-type: none"> → Connect the camera and your computer correctly using the supplied USB multi cable (page 87). → Follow the copy procedure for your OS (pages 88, 89 and 97). <ul style="list-style-type: none"> → Use a “Memory Stick” that was formatted using the camera.
After making a USB connection, “Picture Package” does not automatically start.	— —	<ul style="list-style-type: none"> → Run “Picture Package Menu” and check [Settings]. → Make a USB connection when the computer is turned on (page 87).

Symptom	Cause	Solution
The image cannot be played back on a computer.	— —	→ If you are using the “Picture Package” software, see the help on the upper-right corner of each screen. → Consult the computer or software manufacturer.
The image and sound are affected by noise when you play back a movie on a computer.	• You are playing back the movie directly from the “Memory Stick.”	→ Copy the movie to the hard disk of the computer and then play the movie file back from the hard disk (pages 88, 89, 95 and 97).
You cannot print an image.	—	→ Check the printer settings.
Images previously copied from a computer cannot be viewed on the camera.	• Copied to a wrong folder.	→ Copy them to an available folder, such as “101MSDCF” (page 91).

“Memory Stick”

Symptom	Cause	Solution
You cannot insert a “Memory Stick.”	• You are inserting it backwards.	→ Insert it from the right side (page 19).
You cannot record on a “Memory Stick.”	• The write-protect switch on the “Memory Stick” is set to the LOCK position. • The “Memory Stick” is full.	→ Set it to the recording position (page 120). → Delete unnecessary images (pages 42 and 82).
You cannot format a “Memory Stick.”	• The write-protect switch on the “Memory Stick” is set to the LOCK position.	→ Set it to the recording position (page 120).
You have formatted a “Memory Stick” by mistake.	• All the data on the “Memory Stick” are erased by formatting. You cannot restore them.	→ We recommend that you set the “Memory Stick” write-protect switch to the LOCK position to protect accidental erasure (page 120).

PictBridge compliant printer

Symptom	Cause	Solution
The connection cannot be established.	<ul style="list-style-type: none"> • The printer is not PictBridge-compliant. • The printer is not set for the connection with the camera. • [USB Connect] is not set to [PictBridge] in the SET UP settings. • Depending on the circumstances, the connection may not be established. 	<ul style="list-style-type: none"> → Consult with the printer manufacturer. → Check that the printer is turned on and can connect with the camera. → Set it to [PictBridge] (page 118). → Disconnect and connect the USB multi cable again. If an error message is indicated on the printer, refer to the operating instructions supplied with the printer.
You cannot print images.	<ul style="list-style-type: none"> • The camera is not connected to the printer. • The printer is not turned on. • If you select [Exit] during printing, you may not print again depending on your printer. • Movies cannot be printed. • Images modified with a computer or images shot using other than this camera may not be able to be printed. 	<ul style="list-style-type: none"> → Check that the camera and the printer are properly connected using the USB multi cable. → Turn on the printer. For further information, refer to the operating instructions supplied with it. → Disconnect and connect the USB multi cable again. If you cannot print still, disconnect the USB multi cable, turn off and on the printer, then connect the USB multi cable again. — —
Printing is canceled.	<ul style="list-style-type: none"> • You disconnected the USB multi cable before the  (Not disconnect USB multi cable) mark disappears. 	—
You cannot insert the date or print images in the index mode.	<ul style="list-style-type: none"> • The printer does not provide these functions. • The date may not be inserted in the index mode depending on the printer. 	<ul style="list-style-type: none"> → Consult with the printer manufacturer whether the printer provides these function or not. → Consult with the printer manufacturer.
“---- -- --”is printed on the date-inserted part.	<ul style="list-style-type: none"> • The recording date data is not recorded on the image. 	<ul style="list-style-type: none"> → The images that do not have the recording date data cannot be printed with the date inserted. Set [Date] to [Off] and print it.





Others

Symptom	Cause	Solution
The camera does not work, no operations can be performed.	<ul style="list-style-type: none">• You are not using an “InfoLITHIUM” battery pack.• The battery level is low or zero (The  indicator appears.).• The AC Adaptor is not connected securely.	<p>→ Use an “InfoLITHIUM” battery pack (page 121).</p> <p>→ Charge the battery pack (page 11).</p> <p>→ Connect it securely to the DC IN jack of the camera and to a wall outlet (wall socket) (page 14).</p>
The power is on, but the camera does not work.	<ul style="list-style-type: none">• The internal system is not working properly.	<p>→ Disconnect, and then, after one minute, reconnect all power sources and turn on the camera. If this does not work, press the RESET button located inside the battery/“Memory Stick” cover with a pointed object, then turn the power on again. (This will clear the date and time settings, etc.)</p>
You cannot identify the indicator on the LCD screen.	—	<p>→ Check the indicator (pages 124 to 127).</p>
The lens gets fogged.	<ul style="list-style-type: none">• Condensation is occurring.	<p>→ Turn off the camera, leave the camera for about an hour and then try to use it again (page 119).</p>
The camera gets hot if you use it for a long time.	—	<p>→ This is not a malfunction.</p>

Warnings and messages

The following messages appear on the LCD screen.

Message	Meaning/ Corrective Action
No Memory Stick	<ul style="list-style-type: none">• Insert a “Memory Stick” (page 19).
System error	<ul style="list-style-type: none">• Turn the power off and on again (page 15).
Memory Stick error	<ul style="list-style-type: none">• The inserted “Memory Stick” cannot be used with your camera (page 120).• The “Memory Stick” is damaged.• The terminal section of the “Memory Stick” is dirty.• Insert the “Memory Stick” correctly (page 19).
Memory Stick type error	<ul style="list-style-type: none">• The inserted “Memory Stick” cannot be used with your camera (page 120).
Format error	<ul style="list-style-type: none">• The “Memory Stick” format failed. Format the “Memory Stick” again (page 44).
Memory Stick locked	<ul style="list-style-type: none">• The write-protect switch on the “Memory Stick” is set to the LOCK position. Set it to the recording position (page 120).
No memory space	<ul style="list-style-type: none">• The capacity of the “Memory Stick” is insufficient. You cannot record images. Delete unnecessary images or data (pages 42 and 82).
Read only memory	<ul style="list-style-type: none">• You cannot record or delete images on the “Memory Stick” with this camera.
No file in this folder	<ul style="list-style-type: none">• No images have been recorded in this folder.
Folder error	<ul style="list-style-type: none">• A folder with the same first three digits number already exists on the “Memory Stick.” (For example: 123MSDCF and 123ABCDE) Select other folders, or create a new folder.
Cannot create more folders	<ul style="list-style-type: none">• The folder whose first three digits of the name is “999” exists on the “Memory Stick.” You cannot create any more folders.
Cannot record	<ul style="list-style-type: none">• You attempted to select the folder that is available only for viewing with your camera. Select other folders (page 48).
File error	<ul style="list-style-type: none">• An error occurred while playing back the image.
File protect	<ul style="list-style-type: none">• The image is protected against erasure. Release the protection (page 69).
For “InfoLITHIUM” battery only	<ul style="list-style-type: none">• The battery pack is not the “InfoLITHIUM” type.
Image size over	<ul style="list-style-type: none">• You are playing back an image of a size that cannot be played back on your camera.

Message	Meaning/ Corrective Action
Cannot divide	<ul style="list-style-type: none"> The movie is not long enough to be divided. The file is not a movie.
Invalid operation	<ul style="list-style-type: none"> You are playing back a file that was created on equipment other than your camera.
	<ul style="list-style-type: none"> The battery level is low or zero. Charge the battery pack (page 11). Depending on the conditions of use or the type of battery pack, the indicator may flash even though there are still 5 to 10 minutes of remaining battery time left.
	<ul style="list-style-type: none"> Camera shake may occur due to insufficient light. Use the flash, mount the camera on a tripod, or otherwise secure the camera in place.
Rotate the lens portion	<ul style="list-style-type: none"> The lens portion is falling downward. Rotate the lens portion.
Enable printer to connect	<ul style="list-style-type: none"> [USB Connect] is set to [PictBridge], however the camera is connected to a non-PictBridge compliant device. Check the device. Depending on the circumstances, the connection may not be established. Disconnect and connect the USB multi cable again. If an error message is indicated on the printer, refer to the operating instructions supplied with the printer.
Connect to  device	<ul style="list-style-type: none"> You tried to print images before the printer connection was established. Connect to a PictBridge compliant printer.
No printable image	<ul style="list-style-type: none"> You tried to execute [DPOF image] without checking the  mark. You tried to execute [All In This Folder] while selecting the folder that stores only movies. You cannot print movies.
Printer busy	<ul style="list-style-type: none"> Since the printer is busy, it cannot receive print requests. Check the printer.
Paper error	<ul style="list-style-type: none"> A paper error occurred, such as paper-out, paper-jam, etc. Check the printer.
Ink error	<ul style="list-style-type: none"> An ink error occurred. Check the printer.
Printer error	<ul style="list-style-type: none"> The camera received an error from the printer. Check the printer, or check if the image you want to print is corrupted.
	<ul style="list-style-type: none"> The data transmission to the printer may not be completed yet. Do not disconnect the USB multi cable.

Self-diagnosis display

– If a code starting with an alphabet letter appears

Your camera has a self-diagnosis display. This function displays the condition of the camera on the LCD screen using a combination of a letter and four numerical digits. If this occurs, check the following code chart and take the corresponding countermeasure. The last two digits (indicated by □□) will differ depending on the state of the camera.

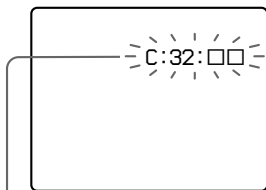

Self-diagnosis display

Code	Cause	Countermeasure
C:32: □□	There is trouble with your camera's hardware.	Turn the power off and on again (page 15).
C:13: □□	The camera cannot read or write data on the "Memory Stick."	Re-insert the "Memory Stick" several times.
	An unformatted "Memory Stick" is inserted.	Format the "Memory Stick" (page 44).
	The inserted "Memory Stick" cannot be used with your camera, or the data is damaged.	Insert a new "Memory Stick" (page 19).
E:61: □□ E:91: □□	A camera malfunction that you cannot reverse has occurred.	Press the RESET button (page 100) located inside the battery/"Memory Stick" cover, then turn on the camera again.

If your camera is not still functioning well after trying the countermeasure a couple of times, the camera may need to be repaired. Contact your Sony dealer or local authorized Sony service facility.

The number of images that can be saved/shooting time

The number of images that can be saved and the shooting time are different, depending on the capacity of the “Memory Stick,” the image size, and the image quality. Refer to the following charts when you choose a “Memory Stick.”

- The number of images is listed in Fine (Standard) order.
- The values for the number of images that can be saved and the shooting time may vary, depending on the shooting conditions.
- For normal shooting times and numbers of images that can be saved, see page 22.
- When the remaining number of images recordable is more than 9,999, “>9999” is indicated.

Multi Burst

(Units: images)

	16MB	32MB	64MB	128MB	MSX-256	MSX-512	MSX-1G
1M	24 (46)	50 (93)	101(187)	202 (376)	357 (649)	726 (1320)	1482 (2694)

Movie

	16MB	32MB	64MB	128MB	MSX-256	MSX-512	MSX-1G
640 (Standard)	0:00:42	0:01:27	0:02:56	0:05:54	0:10:42	0:21:47	0:44:27
160	0:11:12	0:22:42	0:45:39	1:31:33	2:51:21	5:47:05	11:44:22

The numbers indicate the recording time. For example: “1:31:33” indicates “1 hour, 31 minutes, 33 seconds.”

- The image size is as follows:
640 (Standard): 640×480
160: 160×112





Menu items

Menu items that can be changed differ depending on the position of the mode dial or the settings of the camera. Default settings are indicated with ■.

When the mode dial is set to

Item	Setting	Description
Mode (REC Mode)	Multi Burst Burst ■Normal	<ul style="list-style-type: none">– Records a continuous burst of 16 frames within a single still image (page 61).– Records images in succession (page 60).– Records an image using the normal recording mode.

When the mode dial is set to P, M or SCN

Item	Setting	Description
SCN¹⁾		Sets the Scene Selection mode (page 34).
 (EV)²⁾	+2.0EV / +1.7EV / +1.3EV / +1.0EV / +0.7EV / +0.3EV / ■0EV / -0.3EV / -0.7EV / -1.0EV / -1.3EV / -1.7EV / -2.0EV	Adjusts the exposure (page 55).
 (Focus)	∞ / 7.0m / 3.0m / 1.0m / 0.5m / Center AF / ■ Multi AF	Chooses the auto focus method (page 49), or sets the focus preset distance (page 51).
 (Metering Mode)	Spot / ■ Multi	Adjusts the exposure to the subject you are shooting (page 57). Sets the metering region.
WB (White Bal)		Sets the white balance (page 58).

Item	Setting	Description
ISO (ISO)	400 / 200 / 100 / Auto	Selects the ISO sensitivity. When shooting under dark conditions or shooting a fast-moving subject, use a high-number setting. When recording high-quality images, use a low-number setting. • The higher the number you select, the more the noise increases.
(P.Quality)	Fine / Standard	Records images with fine image quality mode. / Records images in the standard image quality mode (page 47).
Mode (REC Mode)	Multi Burst Burst Normal	– Records a continuous burst of 16 frames within a single still image (page 61). – Records images in succession (page 60). – Records an image using the normal recording mode.
(Interval) ³⁾	1/7.5 / 1/15 / 1/30	Selects the Multi Burst between-frame shutter interval (Only when [Mode] (REC Mode) is set to [Multi Burst]) (page 61).
(Flash Level) ⁴⁾	+ / Normal / –	Selects the amount of flash light (page 59).
PFX (P.Effect)	B&W / Sepia / Off	Sets the special effects for the image (page 62).
(Saturation) ⁵⁾	+ / Normal / –	Adjusts the saturation of the image. The indicator appears (except when the setting is Normal.)
(Contrast) ⁵⁾	+ / Normal / –	Adjusts the contrast of the image. The indicator appears (except when the setting is Normal.)
(Sharpness) ⁵⁾	+ / Normal / –	Adjusts the sharpness of the image. The indicator appears (except when the setting is Normal.)

¹⁾This does not appear when mode dial is set to P or M.









²⁾This does not appear when mode dial is set to M.

³⁾This does not appear when (Magnifying glass mode), (Twilight mode), (Twilight portrait mode), (Fireworks mode) or (Candle mode) is selected in SCN.













⁴⁾This does not appear when (Twilight mode), (Fireworks mode) or (Candle mode) is selected in SCN.

⁵⁾This does not appear when mode dial is set to SCN.

When the mode dial is set to

Item	Setting	Description
 (EV)	+2.0EV / +1.7EV / +1.3EV / +1.0EV / +0.7EV / +0.3EV /  0EV / -0.3EV / -0.7EV / -1.0EV / -1.3EV / -1.7EV / -2.0EV	Adjusts the exposure (page 55).
 (Focus)	∞ / 7.0m / 3.0m / 1.0m / 0.5m / Center AF /  Multi AF	Chooses the auto focus method (page 49), or sets the focus preset distance (page 51).
 (Metering Mode)	Spot /  Multi	Adjusts the exposure to the subject you are shooting (page 57). Sets the metering region.
WB (White Bal)		Sets the white balance (page 58).
PFX (P.Effect)	B&W / Sepia /  Off	Sets the special effects for the image (page 62).

When the mode dial is set to

Item	Setting	Description
 (Folder)	OK/Cancel	Selects the folder that contains the images you want to play back (page 63).
 (Protect)	—	Protects/unprotects images against accidental erasure (page 69).
DPOF (DPOF)	—	Selects still images you want to attach/cancel the print (DPOF) mark (page 71).
 (Print)	—	Prints images using a PictBridge compliant printer (page 73).
 (Slide)	Interval Image Repeat Start Cancel	<ul style="list-style-type: none"> – Sets the slide show interval (page 65). (For single-image screen only.) <ul style="list-style-type: none">  3 sec/ 5 sec/ 10 sec/ 30 sec/ 1 min – Selects images from either folder or recording media. <ul style="list-style-type: none">  Folder/All – Repeats the slide show. <ul style="list-style-type: none">  On/Off – Starts the slide show. – Cancels the settings and execution of the slide show.
 (Resize)	5M / 3M / 1M / VGA / Cancel	Changes the recorded image size (page 70). (For single-image screen only.)
 (Rotate)	 (counter-clockwise) /  (clockwise) / OK / Cancel	Rotates the still image (page 66). (For single-image screen only.)
 (Divide)	OK / Cancel	Divides a movie (page 83). (For single-image screen only.)

SET UP items

Set the mode dial to SET UP. The SET UP screen appears.

Default settings are indicated with ■.

(Camera)

Item	Setting	Description
AF Mode	■Single / Monitor	Selects the focus operation mode (page 50).
Digital Zoom	■Smart / Precision / Off	Selects the digital zoom mode (page 25).
Date/Time	Day&Time / Date / ■Off	Selects whether to insert the date and time into the image (page 33). When shooting movies or images recorded in Multi Burst mode, the date and time cannot be inserted in the image. Also, the date and time will not be displayed when shooting. The date and time will be displayed when the image is played back.
Red Eye Reduction	On / ■Off	Reduces the red-eye phenomenon when using a flash (page 30).
AF Illuminator	■Auto / Off	Selects whether to emit an AF fill light in the dark. Helps when it is hard to focus on the subject under dark lighting (page 31).
Auto Review	On / ■Off	When shooting still images, selects whether to display the image just after you shoot a still image. Setting this to [On] displays the recorded images for about two seconds. During this time, you cannot shoot the next image.

(Memory Stick Tool)

Item	Setting	Description
Format	OK / Cancel	Formats the “Memory Stick.” Note that formatting erases all data on a “Memory Stick,” including even protected images (page 44).
Create REC. Folder	OK / Cancel	Creates a folder for recording images (page 48).
Change REC. Folder	OK / Cancel	Changes a folder for recording images (page 48).

(Setup 1)

Item	Setting	Description
LCD Backlight	Bright/ <input checked="" type="checkbox"/> Normal/ Dark	Selects the brightness of the LCD backlight. Selecting [Bright] makes the LCD screen bright and easy to see when using the camera outdoors or in other bright locations, but also uses up the battery charge faster. Displayed only when you are using the camera with the battery pack.
Beep	Shutter <input checked="" type="checkbox"/> On Off	<ul style="list-style-type: none">– Turns on the shutter sound when you press the shutter button.– Turns on the beep/shutter sound when you press the control button/the shutter button.– Turns off the beep/shutter sound.
 Language	—	Displays the menu items, warnings and messages in selected language.

(Setup 2)

Item	Setting	Description
File Number	<input checked="" type="checkbox"/> Series Reset	<ul style="list-style-type: none">– Assigns numbers to files in sequence even if the “Memory Stick” is changed or the recording folder is changed.– Resets the file numbering and starts from 0001 each time the folder is changed. (When the recording folder contains a file, a number one higher than the largest number is assigned.)
USB Connect	PictBridge/PTP/ <input checked="" type="checkbox"/> Normal	Switches the USB mode when connecting with a computer or a PictBridge compliant printer using the USB multi cable.
Video Out	NTSC PAL	<ul style="list-style-type: none">– Sets the video output signal to NTSC mode (e.g., USA, Japan).– Sets the video output signal to PAL mode (e.g., Europe).
Clock Set	OK / Cancel	Sets the date and time (pages 17 and 47).

Precautions

Do not leave the camera in the following places

- In extremely hot place, such as in a car parked in the sun. The camera body may become deformed or this may cause a malfunction.
- Under direct sunlight or near a heater. The camera body may become deformed or this may cause a malfunction.
- On rocking vibration
- Near strong magnetic place
- On sandy or in dusty place
Do not let sand get into the camera. Sand or dust may cause the camera to malfunction and sometimes this malfunction cannot be repaired.

Cleaning

Cleaning the LCD screen

Clean the screen surface with an LCD cleaning kit (not supplied) to remove fingerprints, dust, etc.

Cleaning the lens

Wipe the lens with a soft cloth to remove fingerprints, dust, etc.

Cleaning the DC plug

Clean the DC plug of the AC Adaptor with a dry cotton bud. Do not use the dirty plug. Use of the dirty plug may not properly charge the battery pack.

Cleaning the camera surface

Clean the camera surface with a soft cloth slightly moistened with water, then wipe the surface with a dry cloth. Do not use the following as this may damage the finish or the casing.

- Thinner, benzine, alcohol, disposable cloth, or chemical such as insecticide
- Touch the camera with the above on your hand
- Contact with rubber or vinyl for a long time

Note on operating temperature

The camera is designed for use within a temperature range of 0°C to 40°C (32°F to 104°F). Shooting in extremely cold or hot locations that exceed this range is not recommended.

On moisture condensation

If the camera is brought directly from a cold to a warm location, or is placed in a very damp room, moisture may condense inside or outside the camera. This moisture condensation may cause a malfunction of the camera.

Moisture condensation occurs easily when:

- The camera is brought from a cold location such as a ski slope into a warmly heated room.
- The camera is taken from an air-conditioned room or car interior to the hot outdoors, etc.

To prevent moisture condensation

When bringing the camera from a cold place to a warm place, seal the camera in a plastic bag and leave it in the new location for about an hour. Remove the plastic bag when the camera has adapted to the new temperature.

If moisture condensation occurs

Turn off the camera and wait about an hour for the moisture to evaporate. Note that if you attempt to shoot with moisture remaining inside the lens, you will be unable to record clear images.

The internal rechargeable button battery

This camera has an internal rechargeable button battery for maintaining the date and time and other settings regardless of whether the power is on or off.

This rechargeable button battery is continually charged as long as you are using the camera. However, if you use the camera for only short periods it discharges gradually, and if you do not use the camera at all for about one month it becomes completely discharged. In this case, be sure to charge this rechargeable button battery before using the camera.

Note that even if this rechargeable button battery is not charged, you can still use the camera as long as you do not record the date and time.

How to charge

Connect the camera to a wall outlet (wall socket) using the AC Adaptor, or install a charged battery pack, and leave the camera for 24 hours or more with the power turned off.

- The internal rechargeable button battery is located inside the cover beside the tripod receptacle on the bottom of the camera. Never remove the rechargeable button battery.

The "Memory Stick"

"Memory Stick" is a new compact, portable and versatile IC "Memory Stick" with a data capacity that exceeds the capacity of a floppy disk.

The "Memory Stick" that can be used with this camera is as follows. However, we have no guarantee of proper operation.

"Memory Stick"	Recording/ playback
Memory Stick	Yes
Memory Stick Duo ¹⁾	Yes
Memory Stick Duo (MagicGate/ High-speed data transfer compatible) ¹⁾	Yes ²⁾³⁾
MagicGate Memory Stick	Yes ²⁾
MagicGate Memory Stick Duo ¹⁾	Yes ²⁾
Memory Stick PRO	Yes ²⁾³⁾
Memory Stick PRO Duo ¹⁾	Yes ²⁾³⁾

¹⁾ When using it with this camera, be sure to insert into the Memory Stick Duo Adaptor.

²⁾ "MagicGate Memory Stick" and "Memory Stick PRO" are equipped with the MagicGate copyright protection technology. MagicGate is copyright protection technology that uses encryption technology. However, because your camera does not support the MagicGate standards, data recorded with your camera is not subject to MagicGate copyright protection.

³⁾ Supports high-speed data transmission using the parallel interface.

- The "Memory Stick" formatted with a computer is not guaranteed to operate with this camera.
- The data read/write time differs depending on the combination of the "Memory Stick" and a device.

Notes on use of the "Memory Stick" (supplied)

- You cannot record, edit, or delete images when the write-protect switch is set to LOCK.

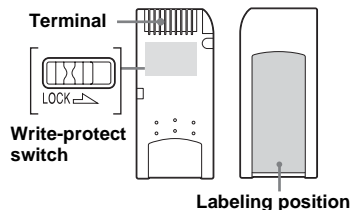

The position or the shape of the write-protect switch may differ depending on the "Memory Stick" you use.

- Do not remove the "Memory Stick" while reading or writing data.
- Data may be damaged in the following cases:
 - Removing the "Memory Stick" or turning off the camera while reading or writing data.
 - Using the "Memory Stick" in a location subject to the effects of static electricity or noise.
- We recommend you back up any important data.
- Do not attach any other material than the supplied label on the labeling position.

- When you attach the supplied label, be sure to attach it to the labeling position. Be careful that the label does not stick out.
- When you carry or store the “Memory Stick,” put it in the case supplied with it.
- Do not touch the terminals of a “Memory Stick” with your hand or a metal object.
- Do not strike, bend or drop a “Memory Stick.”
- Do not disassemble or modify a “Memory Stick.”
- Do not expose the “Memory Stick” to water.
- Avoid using or storing the “Memory Stick” in the following places:
 - In a car parked in the sun, or at a high temperature.
 - Under direct sunlight.
 - In a humid place or near corrosive material.

Notes on use of the “Memory Stick Duo” (not supplied)

- Be sure to insert the “Memory Stick Duo” into the Memory Stick Duo Adaptor when using the “Memory Stick Duo” with the camera. If you insert the “Memory Stick Duo” into the camera without attaching the Memory Stick Duo Adaptor, you may not be able to remove the “Memory Stick Duo.”
- Verify that you are inserting the “Memory Stick Duo” in the proper direction when inserting it into the Memory Stick Duo Adaptor.
- Verify that you are inserting the Memory Stick Duo Adaptor in the proper direction when inserting it into the camera. Inserting it in the wrong direction may cause a malfunction.
- Do not insert a “Memory Stick Duo” that is not inserted into a Memory Stick Duo Adaptor into a “Memory Stick”-compatible unit. This may cause a malfunction of the unit.

- When formatting the “Memory Stick Duo,” insert the “Memory Stick Duo” into the Memory Stick Duo Adaptor.
- When the “Memory Stick Duo” is equipped with the write protect switch, release its lock.

Note on use of the “Memory Stick PRO” (not supplied)

“Memory Stick PRO” with a capacity of up to 1 GB is verified for this camera.

The “InfoLITHIUM” battery pack



What is the “InfoLITHIUM” battery pack?

The “InfoLITHIUM” battery pack is a lithium-ion battery pack that has functions for communicating information related to operating conditions between your camera and the AC Adaptor.

The “InfoLITHIUM” battery pack calculates the power consumption according to the operating conditions of your camera, and displays the remaining battery time in minutes.

Charging the battery pack

We recommend charging the battery pack in an ambient temperature of between 10°C to 30°C (50°F to 86°F). You may not be able to efficiently charge the battery pack outside of this temperature range.

Effective use of the battery pack

- Battery performance decreases in low-temperature surroundings. So, the time that the battery pack can be used is shorter in cold places. We recommend the following to ensure longer battery pack use:
 - Put the battery pack in a pocket close to your body to warm it up, and insert it in your camera immediately before you start shooting.
- Frequently operating the zoom or flash wears out the battery charge faster.
- We recommend having spare battery packs handy for two or three times the expected shooting time, and making trial shots before taking the actual shots.
- Do not expose the battery pack to water. The battery pack is not water-resistant.

Remaining battery time indicator

The power may go off although the battery remaining indicator shows there is enough power to operate. Use the battery pack up and charge the battery pack fully again so that the indication on the battery remaining indicator is correct. Note, however, that the correct battery indication sometimes will not be restored if the camera is used in high temperatures for a long time or left in a fully charged state, or the battery pack is frequently used.

How to store the battery pack

- Even if the battery pack will not be used for a long time, fully charge it and use it up once per year. Remove the battery pack from your camera, then store it in a dry, cool place. This is to maintain the battery pack's functions.
- To use the battery pack up on your camera, leave the POWER button to on in slide show playback mode (page 65) until the power goes off.
- Always carry and store the battery pack in the battery case to prevent the battery terminals from becoming dirty or short circuited.

Battery life

- The battery life is limited. Battery capacity decreases little by little as you use it more and more, and as time passes. When the battery operating time is shortened considerably, a probable cause is that the battery pack has reached the end of its life. Buy a new battery pack.
- The battery life varies according to how it is stored and the operating conditions and environment for each battery pack.

Specifications

■ Camera [System]

Image device	7.66 mm (1/2.4 type) color CCD Primary color filter
Total pixels number of camera	Approx. 5 255 000 pixels
Effective pixels number of camera	Approx. 5 090 000 pixels
Lens	Carl Zeiss Vario-Tessar 3× zoom lens f=6.7 to 20.1 mm (35 mm camera conversion: 38 to 114 mm) F3.5-4.2
Exposure control	Automatic, Manual exposure, Scene selection (10 modes)
White balance	Automatic, Daylight, Cloudy, Fluorescent, Incandescent
File format (DCF compliant)	Still images: Exif Ver. 2.2, JPEG compliant, DPOF compatible Movies: MPEG1 compliant (Monaural)
Recording medium	“Memory Stick”
Flash	Recommended distance (when ISO sensitivity is set to Auto) 0.15 to 2.2 m (6 inches to 7 feet 2 5/8 inches) (W) 0.25 to 2 m (9 7/8 inches to 6 feet 6 3/4 inches) (T)

[Input and Output connectors]

Multi connector

USB communication

Hi-Speed USB (USB 2.0 compliant)

[LCD screen]

LCD panel used

4.6 cm (1.8 type) TFT drive

Total number of dots

134 000 (560×240) dots

[Power, general]

Used battery pack

NP-FR1

Power requirements

3.6 V

Power consumption (during shooting with LCD screen on)

1.4 W

Operating temperature range

0° to +40°C (32° to +104°F)

Storage temperature range

-20° to +60°C (-4° to +140°F)

Dimensions 97.8 × 74.4 × 25.6 mm

(3 7/8 × 3 × 1 1/16 inches)

(W/H/D, protruding portions not included)

Mass Approx. 163 g (5.7 oz) (battery pack

NP-FR1, "Memory Stick," wrist strap, and so on included)

Microphone Electret condenser microphone

Speaker Dynamic speaker

Exif Print Compatible

PRINT Image Matching II

Compatible

PictBridge Compatible

■ AC-LS5/LS5B AC Adaptor

Input rating 100 V to 240 V AC, 50/60 Hz, 11 W,
0.16 A to 0.09 A

Output rating 4.2 V DC, 1.5 A

Operating temperature range

0° to +40°C (32° to +104°F)

Storage temperature range

-20° to +60°C (-4° to +140°F)

Dimensions (excluding projecting parts)

Approx. 48 × 29 × 81 mm

(1 15/16 × 1 3/16 × 3 1/4 inches)
(W/H/D)

Mass Approx. 130 g (5 oz) excluding

power cord (mains lead)

■ NP-FR1 battery pack

Used battery Lithium-ion battery

Maximum voltage

DC 4.2 V

Nominal voltage

DC 3.6 V

Capacity 4.4 Wh (1 220 mAh)

Accessories

- AC-LS5/LS5B AC Adaptor (1)
- Power cord (mains lead) (1)
- NP-FR1 battery pack (1)
- Battery case (1)
- USB multi cable (1)
- A/V multi cable (1)
- Wrist strap (1)
- "Memory Stick" (32MB) (1)
- CD-ROM (USB driver: SPVD-012) (1)
- Operating Instructions (1)

Design and specifications are subject to change without notice.

The LCD screen

For shooting still images

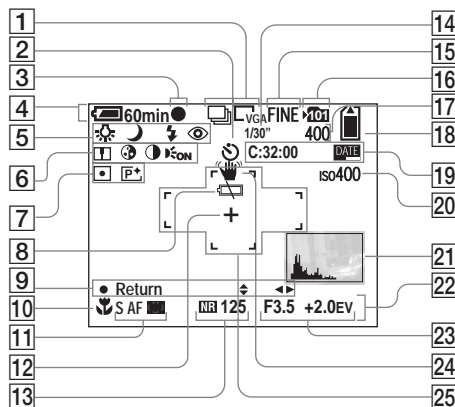

- 1 Recording mode indicator (60, 61)/Image size indicator (20)
- 2 Self-timer indicator (28)
- 3 AE/AF lock indicator (24)
- 4 Battery remaining indicator (12)
- 5 White balance indicator (58)/
Mode dial indicator/
Flash mode (29)/
Red-eye reduction (30)

- 6 Sharpness indicator (115)/
Saturation indicator (115)/
Contrast indicator (115)/
AF illuminator indicator (31)
- 7 Metering mode indicator (57)/
Picture effect indicator (62)
- 8 Low battery warning (111)
- 9 Manual exposure setup mode
indicator (52)

- 10 Macro (27)
- 11 AF mode (50)/
AF range finder frame indicator
(49)/Focus preset value (51)
- 12 Spot metering cross hair (57)
- 13 NR slow shutter indicator (37)/
Shutter speed indicator (52)
- 14 Multi Burst between-frame
interval indicator (61)
- 15 Image quality indicator (47)
- 16 Recording folder indicator (48)
- 17 Remaining number of recordable
images indicator (22)
- 18 Remaining "Memory Stick"
capacity indicator
- 19 Self-diagnosis display (112)/
Date/time indicator (33)
- 20 ISO sensitivity (115)
- 21 Histogram indicator (56)
- 22 Menu/guide menu (46)
- 23 Aperture value indicator (53)/
EV adjustment indicator (55)
- 24 Vibration warning indicator (111)
- 25 AF range finder frame (49)

- Pressing the MENU button switches the menu/
guide menu on/off.

The page numbers in parentheses indicate the location of additional important information.

For shooting movies

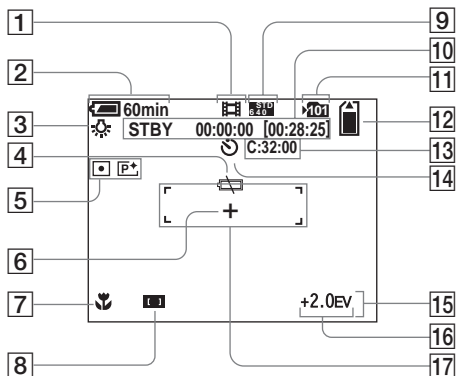

- 1 Recording mode indicator (80)
- 2 Battery remaining indicator (12)
- 3 White balance indicator (58)
- 4 Low battery warning (111)
- 5 Metering mode indicator (57)/
Picture effect indicator (62)
- 6 Spot metering cross hair (57)
- 7 Macro (27)
- 8 AF range finder frame indicator
(49)/Focus preset value (51)
- 9 Image size indicator (80)
- 10 Recording time [Maximum
recordable time] indicator (80)
- 11 Recording folder indicator (48)

- 12 Remaining "Memory Stick"
capacity indicator
- 13 Self-diagnosis display (112)
- 14 Self-timer indicator (28)
- 15 Menu/guide menu (46)
- 16 EV adjustment indicator (55)
- 17 AF range finder frame (49)

- Pressing the MENU button switches the menu/
guide menu on/off.

The page numbers in parentheses indicate the location of additional important information.

For still image playback

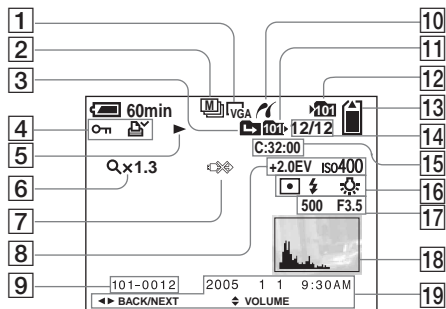

- 17** Shutter speed indicator (52)/
Aperture value indicator (52)
- 18** Histogram indicator (56)
- 19** Recording date/time of the
image (33)/
Menu/guide menu (46)

- Pressing the MENU button switches the menu/
guide menu on/off.

The page numbers in parentheses indicate the location of additional important information.

- | | |
|---|--|
| <ul style="list-style-type: none"> 1 Image size indicator (20) 2 Recording mode indicator
(60–61) 3 Change folder indicator (63) 4 Protect mark indicator (69)/
Print (DPOF) mark indicator (71) 5 Playback indicator (67) 6 Zoom indicator (64)/
Frame by frame playback
indicator (67) 7 Not disconnect USB multi cable
indicator (111) 8 EV adjustment indicator (55)/
ISO sensitivity (115) | <ul style="list-style-type: none"> 9 Folder-file number (91) 10 PictBridge connecting indicator
(73) 11 Playback folder indicator (63) 12 Recording folder indicator (48) 13 Remaining “Memory Stick”
capacity indicator 14 Image number/Number of
images recorded in the playback
folder 15 Self-diagnosis display (112) 16 Metering mode indicator (57)/
Flash indicator/
White balance indicator (58) |
|---|--|

For movie playback

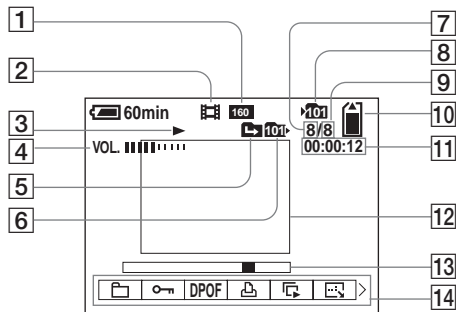

- 1 **Image size indicator** (81)
- 2 **Recording mode indicator** (81)
- 3 **Playback indicator** (81)
- 4 **Volume indicator** (81)
- 5 **Change folder indicator** (63)
- 6 **Playback folder indicator** (63)
- 7 **Image number**
- 8 **Recording folder indicator** (48)
- 9 **Number of images recorded in the playback folder**
- 10 **Remaining "Memory Stick" capacity indicator**
- 11 **Counter** (81)
- 12 **Playback screen** (81)
- 13 **Playback bar** (81)

14 **Menu/guide menu** (46)

- Pressing the MENU button switches the menu/guide menu on/off.

The page numbers in parentheses indicate the location of additional important information.

Index

A

AC Adaptor	11, 14
Access lamp	19
AE/AF lock	24
AF	24
AF illuminator	31
AF Mode	50
AF range finder	49
Aperture value	52
Auto adjustment mode	23
Auto Focus	24, 49
Auto Power Off function	15
Auto Review	117
A/V multi cable	40

B

B&W	62
Battery life	13, 122
Battery remaining indicator	12, 122
Beach	35
Beep/shutter sound	118
Burst	60

C

Candle	35
CD-ROM	86
Center AF	49
Charging battery pack	11, 121
Charging time	12
Cleaning	119

Clock Set	17, 47, 118
Cloudy	58
Contrast	115
Control button	16
Copying images to your computer	88, 95, 97
Cutting movies	83
Cyber-shot Station	62

D

Daylight	58
DC plug	11, 14
Deleting movies	82
Deleting still images	42
Digital zoom	25
Divide	83
DPOF	71

E

EV adjustment	55
---------------------	----

F

File names	91
File storage destinations	91
Finder	32
Fireworks	35
Flash	29
Flash Level	59
Fluorescent	58
Focus preset	51
Folder	48, 63
Format	44

H

High-speed shutter	35
Histogram	56

I

Image quality	47
Image size	20, 21
ImageMixer VCD2	98
Incandescent	59
Index screen	38
“InfoLITHIUM” battery pack	121
Inserting a “Memory Stick”	19
Inserting the date and time	33
Installation	86, 93
ISO	115

J

JPG	92
-----------	----

L

Landscapes	34
LCD backlight	118

M

Macro	27
Magnifying glass	34
Manual exposure	52
Memory Stick	120
Menu	46, 114
Metering mode	57
Mirror mode	29
Mode dial	10
Moisture condensation	119

Monitoring AF	50
MPG	92
Multi Burst	61, 67
Multi-pattern metering	57
Multipoint AF	49

N

NR slow shutter	37
NTSC	118
Number of images that can be saved or shooting time	22, 113
Number of images that can be shot or viewed	13

P

PAL	118
PictBridge	73
Picture Effect	62
Picture Package	93
Playback zoom	64
Power on/off	15
Precautions	119
Precision digital zoom	26
Print (DPOF) mark	71
Program auto shooting	10
Protect	69
PTP	85, 97, 118

Q

Quick Review	25
--------------------	----

R

Red Eye Reduction	30
-------------------------	----

Remaining shooting/viewing time	12, 113
RESET button	100
Resize	70
Rotate	66

S

Saturation	115
Scene Selection	34
Screen display	124, 125, 126, 127
Self-diagnosis display	112
Self-timer	28
Sepia	62
SET UP	47, 117
Sharpness	115
Shooting movies	80
Shooting still images	23
Shutter speed	52
Single AF	50
Single screen	38
Slide show	65
Smart zoom	26
Snow	35
Soft snap	35
Spot metering	57

T

Trimming	65
TV color system	41
Twilight	34
Twilight portrait	34

U

USB	87, 97
USB driver	86

USB mode	85, 97
USB multi cable	40, 73, 87
Using your camera abroad	14

V

Viewing images on TV	40
Viewing movies on the LCD screen	81
Viewing the images on the LCD screen	38
Viewing the images on your computer	90, 97

W

Warnings and messages	110
White balance	58

Z

Zoom	25
------------	----

2023044110



Printed on 100% recycled paper
using VOC (Volatile Organic
Compound)-free vegetable oil
based ink.

<http://www.sony.net/>

Sony Corporation Printed in Japan

Additional information on this product and answers to frequently asked questions can be found at our Customer Support Website.