

CESSNA

MORE PEOPLE BUY AND
FLY CESSNA AIRPLANES
THAN ANY OTHER MAKE

1975

WORLD'S LARGEST PRO-
DUCER OF GENERAL
AVIATION AIRCRAFT
SINCE 1956

MODEL 182 AND SKYLANE

OWNER'S MANUAL

Jim Hudson

PERFORMANCE - SPECIFICATIONS

	Skylane *
GROSS WEIGHT	2950 lbs
SPEED:	
Top Speed at Sea Level	170 mph
Cruise, 75% Power at 6500 ft	165 mph
RANGE:	
Cruise, 75% Power at 6500 ft	710 mi
60 Gallons, No Reserve	4.3 hrs
Cruise, 75% Power at 6500 ft	940 mi
79 Gallons, No Reserve	5.7 hrs
Maximum Range at 10,000 ft	165 mph
60 Gallons, No Reserve	910 mi
79 Gallons, No Reserve	6.7 hrs
Maximum Range at 10,000 ft	135 mph
79 Gallons, No Reserve	1200 mi
79 Gallons, No Reserve	8.9 hrs
79 Gallons, No Reserve	135 mph
79 Gallons, No Reserve	890 fpm
79 Gallons, No Reserve	17,700 ft
RATE OF CLIMB AT SEA LEVEL	
SERVICE CEILING	
TAKE-OFF:	
Ground Run	705 ft
Total Distance Over 50-Foot Obstacle	1350 ft
LANDING:	
Ground Roll	590 ft
Total Distance Over 50-Foot Obstacle	1350 ft
STALL SPEED:	
Flaps Up, Power Off	64 mph
Flaps Down, Power Off	57 mph
EMPTY WEIGHT: (Approximate)	
Model 182	1610 lbs
Skylane	1655 lbs
Skylane II	1720 lbs
USEFUL LOAD:	
Model 182	1340 lbs
Skylane	1295 lbs
Skylane II	1230 lbs
BAGGAGE:	
Forward Area "A" (Station 82 to 108)	120 lbs
Aft Area "B" and Hatchelf (Station 108 to 136)	80 lbs
WING LOADING: Pounds/Sq Foot	16.9
POWER LOADING: Pounds/HP	12.8
FUEL CAPACITY: Total	
Standard Tanks	65 gal.
Optional Long Range Tanks	84 gal. 80 x x
OIL CAPACITY: Total	12 qts
PROPELLER: Constant Speed, Diameter	82 inches
ENGINE: Continental Engine	O-470-S
230 rated BHP at 2600 RPM	

NOTE: Performance data is shown for the Skylane which is 3 to 4 mph faster than a standard-equipped Model 182 (without speed fairings). There is a corresponding difference in range, while all other performance figures are the same for the Model 182 as shown for the Skylane.

* This manual covers operation of the Model 182/Skylane which is certificated as Model 182P under FAA Type Certificate No. 3A13.

** SEE PAGE 1111
AD 75-16-01

CONGRATULATIONS

Welcome to the ranks of Cessna owners! Your Cessna has been designed and constructed to give you the most in performance, economy, and comfort. It is our desire that you will find flying it, either for business or pleasure, a pleasant and profitable experience.

This Owner's Manual has been prepared as a guide to help you get the most pleasure and utility from your Model 182/Skylane. It contains information about your Cessna's equipment, operating procedures, and performance; and suggestions for its servicing and care. We urge you to read it from cover to cover, and to refer to it frequently.

Our interest in your flying pleasure has not ceased with your purchase of a Cessna. World-wide, the Cessna Dealer Organization backed by the Cessna Service Department stands ready to serve you. The following services are offered by most Cessna Dealers:

THE CESSNA WARRANTY -- It is designed to provide you with the most comprehensive coverage possible:

- a. No exclusions
- b. Coverage includes parts and labor
- c. Available at Cessna Dealers world wide
- d. Best in the industry

Specific benefits and provisions of the warranty plus other important benefits for you are contained in your Customer Care Program book supplied with your aircraft. Warranty service is available to you at any authorized Cessna Dealer throughout the world upon presentation of your Customer Care Card which establishes your eligibility under the warranty.

FACTORY TRAINED PERSONNEL to provide you with courteous expert service.

FACTORY APPROVED SERVICE EQUIPMENT to provide you with the most efficient and accurate workmanship possible.

A STOCK OF GENUINE CESSNA SERVICE PARTS on hand when you need them.

THE LATEST AUTHORITATIVE INFORMATION FOR SERVICING CESSNA AIRPLANES, since Cessna Dealers have all of the Service Manuals and Parts Catalogs, kept current by Service Letters and Service News Letters, published by Cessna Aircraft Company.

We urge all Cessna owners to use the Cessna Dealer Organization to the fullest.

A current Cessna Dealer Directory accompanies your new airplane. The Directory is revised frequently, and a current copy can be obtained from your Cessna Dealer. Make your Directory one of your cross-country flight planning aids; a warm welcome awaits you at every Cessna Dealer.

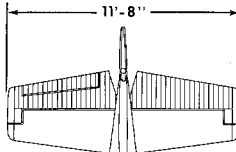
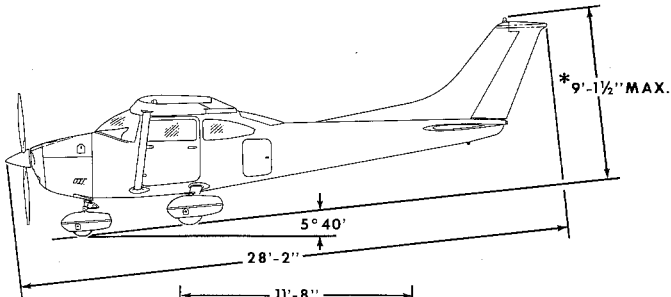

* Maximum height of airplane with nose gear depressed, all tires and nose strut properly inflated, and optional flashing beacon installed.

** Wing span of airplane with optional strobe lights installed.

PRINCIPAL DIMENSIONS

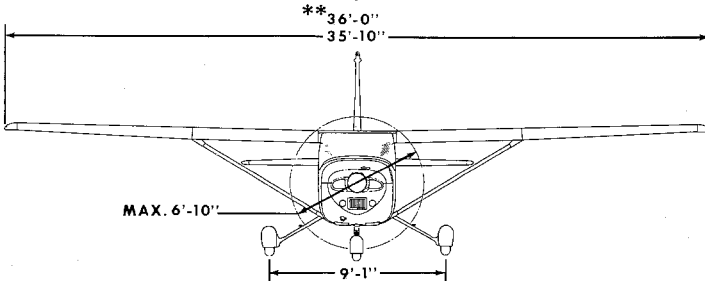
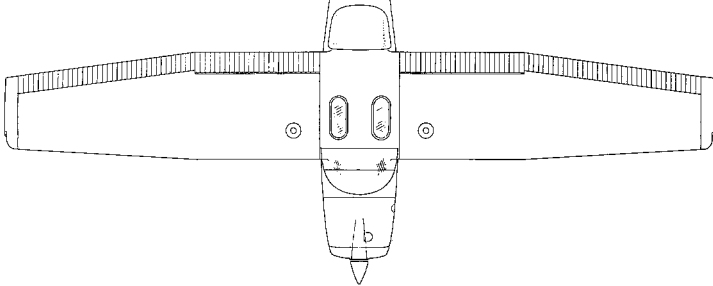

TABLE OF CONTENTS

	Page =
SECTION I - OPERATING CHECKLIST	1-1
SECTION II - DESCRIPTION AND OPERATING DETAILS	2-1
SECTION III - EMERGENCY PROCEDURES	3-1
SECTION IV - OPERATING LIMITATIONS	4-1
SECTION V - CARE OF THE AIRPLANE	5-1
SECTION VI - OPERATIONAL DATA	6-1
SECTION VII - OPTIONAL SYSTEMS	7-1
ALPHABETICAL INDEX	Index-1

This manual describes the operation and performance of the Model 182, the Skylane, and the Skylane II. Equipment described as "Optional" denotes that the subject equipment is optional on the Model 182. Much of this equipment is standard on the Skylane and Skylane II.

REVISED FUEL QUANTITY DATA

MODEL 182 **SKYLANE**

1973 AIRCRAFT (SERIAL 18262251 AND ON)
1974 AIRCRAFT (ALL SERIALS)
1975 AIRCRAFT (ALL SERIALS)

Due to changes in fuel tank manufacturing technique, the fuel systems in the above noted airplanes have been found to contain less than the capacity published in the Owner's Manuals. Data in these manuals indicates total usable capacities of 60 gallons for standard tanks and 79 gallons for long range tanks; the usable capacity per tank is shown to be 31 gallons and 39 gallons respectively.

All fuel capacity references in Owner's Manuals for these airplanes should be marked to reflect the capacities in the chart below.

	TOTAL BOTH TANKS	USABLE BOTH TANKS	TOTAL PER TANK	USABLE PER TANK
CAPACITY (STANDARD TANKS)	61 Gal.	56 Gal.	30.5 Gal.	29 Gal.
CAPACITY (LONG RANGE TANKS)	80 Gal.	75 Gal.	40 Gal.	37 Gal.

When figuring weight and balance data, consideration should be given to the reduction in weight and change in moment/1000 which results from a reduced fuel capacity.

For quick re-computation of cruise performance data, use the information in the Cruise Performance charts provided in the Owner's Manuals by multiplying the ENDR. HOURS and RANGE MILES figures by 0.93 (for standard tank values) or 0.94 (for long range tank values); this will provide conservative endurance and range based on the reduced fuel capacities.

Pages in the Owner's Manuals which are affected by the change in fuel capacity are listed in the chart below.

MANUAL	PAGES AFFECTED													
	Inside Cover	2-1	2-2	2-14	4-6	4-7	5-8	6-4	6-5	6-6	6-7	6-8	7-1	Inside Cover
1973 OWNER'S MANUAL	Inside Cover	2-1	2-2	2-14	4-6	4-7	5-8	6-4	6-5	6-6	6-7	6-8	7-1	Inside Cover
1974 OWNER'S MANUAL	Inside Cover	2-1	2-2	2-3	2-14	4-6	4-7	6-4	6-5	6-6	6-7	6-8	Inside Cover	—
1975 OWNER'S MANUAL	Inside Cover	2-1	2-2	2-3	4-6	4-7	6-4	6-5	6-6	6-7	6-8	Inside Cover	—	—

THIS ADHESIVE BACKED STICKER IS TO BE ATTACHED TO ANY BLANK PAGE IN YOUR MANUAL FOR FUTURE REFERENCE.

REFERENCE SERVICE LETTER SE 75 - 7

Section I

OPERATING CHECKLIST

One of the first steps in obtaining the utmost performance, service, and flying enjoyment from your Cessna is to familiarize yourself with your aircraft's equipment, systems, and controls. This can best be done by reviewing this equipment while sitting in the aircraft. Those items whose function and operation are not obvious are covered in Section II.

Section I lists, in Pilot's Checklist form, the steps necessary to operate your aircraft efficiently and safely. It is not a checklist in its true form as it is considerably longer, but it does cover briefly all of the points that you should know for a typical flight. A more convenient plastic enclosed checklist, stowed in the map compartment, is available for quickly checking that all important procedures have been performed. Since vigilance for other traffic is so important in crowded terminal areas, it is important that preoccupation with checklists be avoided in flight. Procedures should be carefully memorized and performed from memory. Then the checklist should be quickly scanned to ensure that nothing has been missed.

The flight and operational characteristics of your aircraft are normal in all respects. There are no "unconventional" characteristics or operations that need to be mastered. All controls respond in the normal way within the entire range of operation. All airspeeds mentioned in Sections I, II and III are indicated airspeeds. Corresponding calibrated airspeed may be obtained from the Airspeed Correction Table in Section VI.

Refer to inside back cover of this manual for quantities, materials, and specifications of frequently used service items.

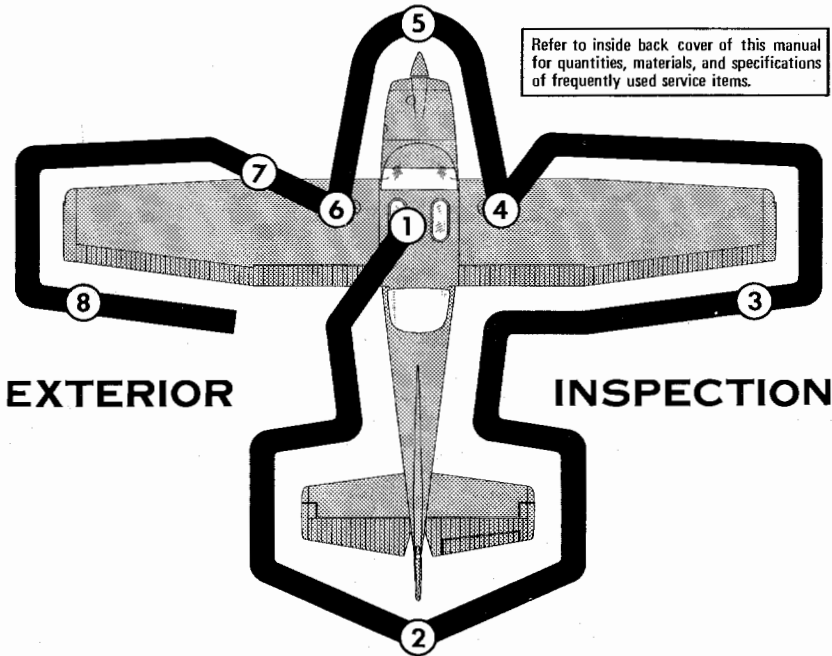

EXTERIOR

INSPECTION

Note

Visually check aircraft for general condition during walk-around inspection. In cold weather, remove even small accumulations of frost, ice or snow from wing, tail and control surfaces. Also, make sure that control surfaces contain no internal accumulations of ice or debris. If a night flight is planned, check operation of all lights, and make sure a flashlight is available.

- ① a. Remove control wheel lock.
- b. Check ignition switch OFF.
- c. Turn on master switch and check fuel quantity indicators; then turn off master switch.
- d. Check fuel selector valve handle on BOTH.
- e. Check baggage door for security. Lock with key if children are to occupy child's seat.

Figure

- ②
 - a. Remove rudder gust lock, if installed.
 - b. Disconnect tail tie-down.
 - c. Check control surfaces for freedom of movement and security.
- ③
 - a. Check aileron for freedom of movement and security.
- ④
 - a. Disconnect wing tie-down.
 - b. Check main wheel tire for proper inflation.
 - c. Before first flight of day and after each refueling, use sampler cup and drain small quantity of fuel from fuel tank sump quick-drain valve to check for water, sediment, and proper fuel grade.
 - d. Visually check fuel quantity; then check fuel filler cap secure and vent unobstructed.
- ⑤
 - a. Inspect flight instrument static source opening on side of fuselage for stoppage (both sides).
 - b. Check propeller and spinner for nicks and security, and propeller for oil leaks.
 - c. Check carburetor air filter for restrictions by dust or other foreign matter.
 - d. Check nose wheel strut and tire for proper inflation.
 - e. Disconnect tie-down rope.
 - f. Check oil level. Do not operate with less than nine quarts. Fill to twelve quarts for extended flight.
 - g. Before first flight of the day and after each refueling, pull out strainer drain knob for about four seconds to clear fuel strainer of possible water and sediment. Check strainer drain closed. If water is observed, the fuel system may contain additional water, and further draining of the system at the strainer, fuel tank sumps, and fuel selector valve drain plug will be necessary.
- ⑥
 - a. Check main wheel tire for proper inflation.
 - b. Before first flight of day and after each refueling, use sampler cup and drain small quantity of fuel from fuel tank sump quick-drain valve to check for water, sediment, and proper fuel grade.
 - c. Visually check fuel quantity; then check fuel filler cap secure and vent unobstructed.
- ⑦
 - a. Remove pitot tube cover, if installed, and check pitot tube opening for stoppage.
 - b. Check fuel tank vent opening for stoppage.
 - c. Disconnect wing tie-down.
- ⑧
 - a. Check aileron for freedom of movement and security.

BEFORE STARTING ENGINE.

- (1) Exterior Preflight -- COMPLETE.
- (2) Seats, Belts, Shoulder Harnesses -- ADJUST and LOCK.
- (3) Brakes -- TEST and SET.
- (4) Cowl Flaps -- OPEN (move lever out of locking hole to reposition).
- (5) Fuel Selector Valve -- BOTH.
- (6) Radios, Autopilot, Electrical Equipment -- OFF.

STARTING ENGINE.

- (1) Mixture -- RICH.
- (2) Carburetor Heat -- COLD.
- (3) Propeller -- HIGH RPM.
- (4) Throttle -- OPEN 1/2 INCH.
- (5) Prime -- AS REQUIRED.
- (6) Master Switch -- ON.
- (7) Propeller Area -- CLEAR.
- (8) Ignition Switch -- START (release when engine starts).

NOTE

If engine has been overprimed, start with throttle open 1/4 to 1/2 full open. Reduce throttle to idle when engine fires.

- (9) Oil Pressure -- CHECK.

NOTE

After starting, check for oil pressure indication within 30 seconds in normal temperatures and 60 seconds in cold temperatures. If no indication appears, shut off engine and investigate.

BEFORE TAKE-OFF.

- (1) Parking Brake -- SET.
- (2) Flight Controls -- FREE and CORRECT.
- (3) Elevator and Rudder Trim -- TAKE-OFF.
- (4) Fuel Selector Valve -- BOTH.
- (5) Cowl Flaps -- OPEN.

- (6) Throttle -- 1700 RPM.
 - a. Magnetos -- CHECK (RPM drop should not exceed 150 RPM on either magneto or 50 RPM differential between magnetos.)
 - b. Propeller -- CYCLE from high to low RPM; return to high RPM (full in).
 - c. Carburetor Heat -- CHECK for RPM drop.
 - d. Engine Instruments -- CHECK.
 - e. Suction -- CHECK (4.6 - 5.4 Inches Hg.).
 - f. Ammeter -- CHECK.
- (7) Flight Instruments and Radios -- CHECK and SET.
- (8) Cabin Doors and Window -- CLOSED and LOCKED.
- (9) Throttle Friction Lock -- ADJUST.
- (10) Wing Flaps -- 0° - 20°.

TAKE-OFF.

NORMAL TAKE-OFF.

- (1) Wing Flaps -- 0°-20°.
- (2) Carburetor Heat -- COLD.
- (3) Power -- FULL THROTTLE and 2600 RPM.
- (4) Elevator Control -- LIFT NOSE WHEEL (at 60 MPH).
- (5) Climb Speed -- 90 MPH.

MAXIMUM PERFORMANCE TAKE-OFF.

- (1) Wing Flaps -- 20°.
- (2) Carburetor Heat -- COLD.
- (3) Brakes -- APPLY.
- (4) Power -- FULL THROTTLE and 2600 RPM.
- (5) Brakes -- RELEASE.
- (6) Elevator Control -- MAINTAIN SLIGHTLY TAIL LOW ATTITUDE.
- (7) Climb Speed -- 60 MPH (until all obstacles are cleared).
- (8) Wing Flaps -- UP (after reaching 80 MPH).

ENROUTE CLIMB.

NORMAL CLIMB.

- (1) Airspeed -- 100-110 MPH.
- (2) Power -- 23 INCHES Hg. and 2450 RPM.

- (3) Fuel Selector Valve -- BOTH.
- (4) Mixture -- LEAN (as required for power, temperature and smoothness).
- (5) Cowl Flaps -- OPEN (as required).

MAXIMUM PERFORMANCE CLIMB.

- (1) Airspeed -- 89 MPH at sea level to 85 MPH at 10,000 feet.
- (2) Power -- FULL THROTTLE and 2600 RPM.
- (3) Fuel Selector Valve -- BOTH
- (4) Mixture -- FULL RICH (unless engine is rough).
- (5) Cowl Flaps -- FULL OPEN.

CRUISE.

- (1) Power -- 15-23 INCHES Hg. , 2200-2450 RPM (no more than 75%).
- (2) Mixture -- LEAN.
- (3) Cowl Flaps -- CLOSED.

LET-DOWN.

- (1) Power -- AS DESIRED.
- (2) Carburetor Heat -- AS REQUIRED (to prevent carburetor icing).
- (3) Mixture -- ENRICHEN (as required).
- (4) Cowl Flaps -- CLOSED.
- (5) Wing Flaps -- AS DESIRED (0°-10° below 160 MPH, 10°-40° below 110 MPH).

BEFORE LANDING.

- (1) Fuel Selector Valve -- BOTH.
- (2) Mixture -- RICH.
- (3) Propeller -- HIGH RPM.
- (4) Cowl Flaps -- CLOSED.
- (5) Carburetor Heat -- ON (before closing throttle).
- (6) Airspeed -- 80-90 MPH (flaps UP).

- (7) Wing Flaps -- 0°-40° (below 110 MPH).
- (8) Airspeed -- 70-80 MPH (flaps DOWN).
- (9) Elevator and Rudder Trim -- ADJUST.

BALKED LANDING.

- (1) Power -- FULL THROTTLE and 2600 RPM.
- (2) Carburetor Heat -- COLD.
- (3) Wing Flaps -- RETRACT to 20°.
- (4) Airspeed -- 80 MPH.
- (5) Wing Flaps -- RETRACT slowly.
- (6) Cowl Flaps -- OPEN.

NORMAL LANDING.

- (1) Touchdown -- MAIN WHEELS FIRST.
- (2) Landing Roll -- LOWER NOSE WHEEL GENTLY.
- (3) Braking -- MINIMUM REQUIRED.

AFTER LANDING.

- (1) Wing Flaps -- UP.
- (2) Carburetor Heat -- COLD.
- (3) Cowl Flaps -- OPEN.

SECURING AIRCRAFT.

- (1) Parking Brake -- SET.
- (2) Radios and Electrical Equipment -- OFF.
- (3) Throttle -- IDLE.
- (4) Mixture -- IDLE CUT-OFF (pulled full out).
- (5) Ignition Switch -- OFF.
- (6) Master Switch -- OFF.
- (7) Control Lock -- INSTALLED.

INSTRUMENT PANEL

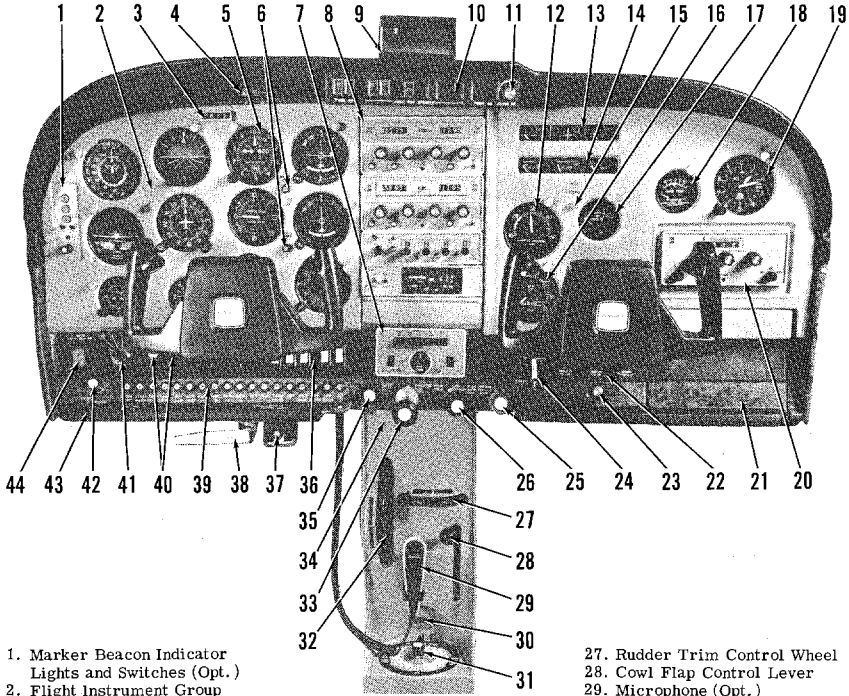

- | | |
|--|---|
| <ol style="list-style-type: none"> 1. Marker Beacon Indicator Lights and Switches (Opt.) 2. Flight Instrument Group 3. Aircraft Registration Number 4. Map Light and Switch 5. Encoding Altimeter (Opt.) 6. Localizer Reversed Indicator Lights (Opt.) 7. Autopilot Control Unit (Opt.) 8. Radios and Transponder (Opt.) 9. Rear View Mirror (Opt.) 10. Radio Selector Switches (Opt.) 11. Radio Selector Switch Light Dimming Rheostat (Opt.) 12. Manifold Pressure Gage 13. Fuel Quantity Indicators and Ammeter 14. Cylinder Head Temperature, Oil Temperature, and Oil Pressure Gages 15. Over-Voltage Warning Light 16. Tachometer 17. Economy Mixture Indicator(Opt.) 18. Carburetor Air Temperature Gage (Opt.) 19. Secondary Altimeter 20. Radio (Opt.) 21. Map Compartment 22. Cabin Heat, Cabin Air and Defroster Control Knobs 23. Cigar Lighter 24. Wing Flap Switch and Position Indicator 25. Mixture Control Knob 26. Propeller Control Knob 27. Rudder Trim Control Wheel 28. Cowl Flap Control Lever 29. Microphone (Opt.) 30. Fuel Selector Light 31. Fuel Selector Valve Handle 32. Elevator Trim Control Wheel 33. Throttle (With Friction Lock) 34. Control Pedestal Light 35. Carburetor Heat Control Knob 36. Electrical Switches 37. Static Pressure Alternate Source Valve (Opt.) 38. Parking Brake Handle 39. Circuit Breakers 40. Instrument and Radio Dial Light Rheostats 41. Ignition Switch 42. Engine Primer 43. Engine Jack 44. Master Switch | <ol style="list-style-type: none"> 35. Carburetor Heat Control Knob 36. Electrical Switches 37. Static Pressure Alternate Source Valve (Opt.) 38. Parking Brake Handle 39. Circuit Breakers 40. Instrument and Radio Dial Light Rheostats 41. Ignition Switch 42. Engine Primer 43. Engine Jack 44. Master Switch |
|--|---|

Figure 2-1.

Section II

DESCRIPTION AND OPERATING DETAILS

The following paragraphs describe the systems and equipment whose function and operation is not obvious when sitting in the aircraft. This section also covers in somewhat greater detail some of the items listed in Checklist form in Section I that require further explanation.

FUEL SYSTEM.

Fuel is supplied to the engine from two tanks, one in each wing. With the fuel selector valve on **BOTH**, the total usable fuel for all flight conditions is 60 gallons for the standard tanks.

Fuel from each wing tank flows by gravity to a selector valve. Depending upon the setting of the selector valve, fuel from the left, right, or both tanks flows through a fuel strainer and carburetor to the engine induction system.

The fuel selector valve should be in the **BOTH** position for take-off, climb, landing, and maneuvers that involve prolonged slips or skids. Operation from either **LEFT** or **RIGHT** tank is reserved for cruising flight.

NOTE

When the fuel selector valve handle is in the **BOTH** position in cruising flight, unequal fuel flow from each tank may occur if the wings are not maintained exactly level. Resulting wing heaviness can be alleviated gradually by turning the selector valve handle to the tank in the "heavy" wing.

NOTE

It is not practical to measure the time required to consume all of the fuel in one tank, and, after switching to

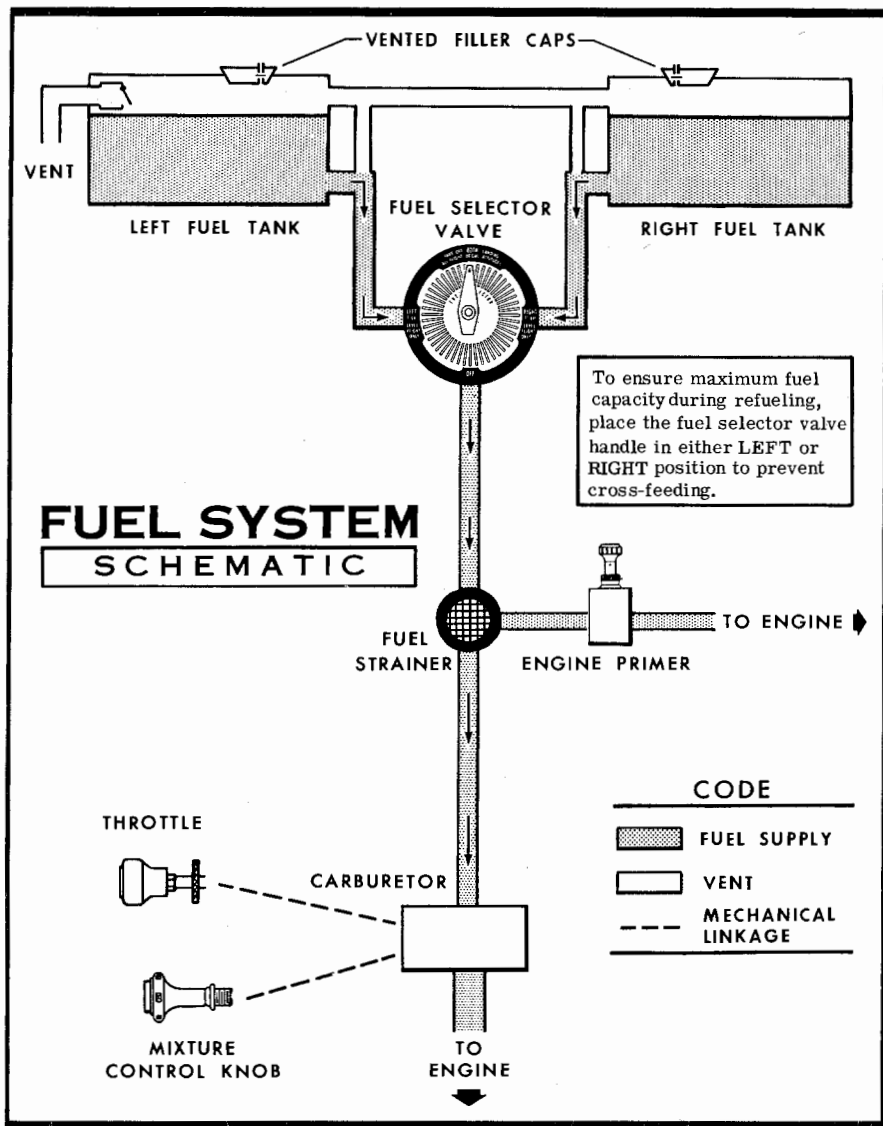

Figure 2-2.

the opposite tank, expect an equal duration from the remaining fuel. The airspace in both fuel tanks is interconnected by a vent line (see figure 2-2) and, therefore, some sloshing of fuel between tanks can be expected when the tanks are nearly full and the wings are not level.

For fuel system servicing information, refer to Servicing Requirements on the inside back cover.

FUEL TANK SUMP QUICK-DRAIN VALVES.

Each fuel tank sump is equipped with a fuel quick-drain valve to facilitate draining and/or examination of fuel for contamination and grade. The valve extends through the lower surface of the wing just outboard of the cabin door. A sampler cup stored in the aircraft is used to examine the fuel. Insert the probe in the sampler cup into the center of the quick-drain valve and push. Fuel will drain from the tank sump into the sampler cup until pressure on the valve is released.

LONG RANGE FUEL TANKS.

Special wings with long range fuel tanks are available to replace the standard wings and fuel tanks for greater endurance and range. When these tanks are installed, the total usable fuel for all flight conditions is 79 gallons.

ELECTRICAL SYSTEM.

Electrical energy is supplied by a 14-volt, direct-current system powered by an engine-driven alternator (see figure 2-3). The 12-volt battery is located aft of the rear baggage compartment wall. Power is supplied to all electrical circuits through a split bus bar, one side containing electronic system circuits and the other side having general electrical system circuits. Both sides of the bus are on at all times except when either an external power source is connected or the starter switch is turned on; then a power contactor is automatically activated to open the circuit to the electronics bus. Isolating the electronic circuits in this manner prevents harmful transient voltages from damaging the transistors in the electronics equipment.

MASTER SWITCH

The master switch is a split-rocker type switch labeled MASTER,

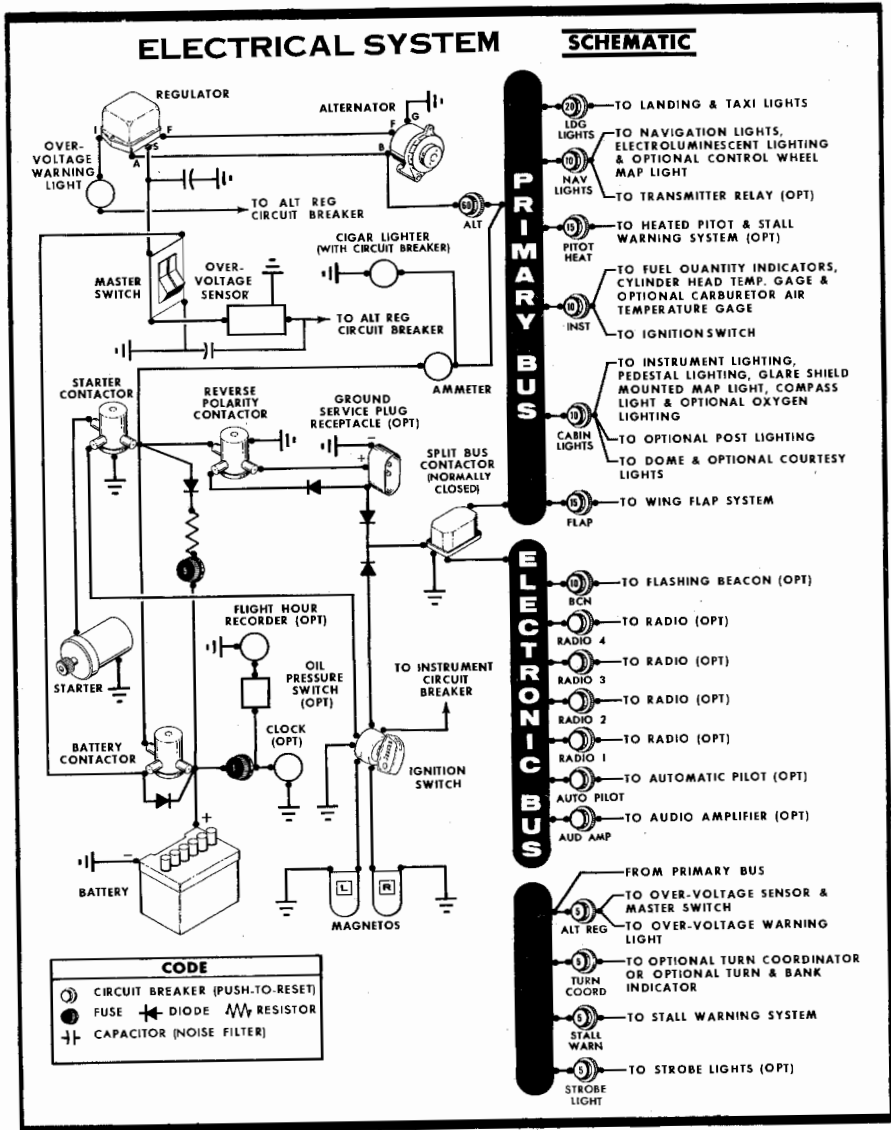

Figure 2-3.

and is ON in the up position and off in the down position. The right half of the switch, labeled BAT, controls all electrical power to the aircraft. The left half, labeled ALT, controls the alternator.

Normally, both sides of the master switch should be used simultaneously; however, the BAT side of the switch could be turned ON separately to check equipment while on the ground. The ALT side of the switch, when placed in the off position, removes the alternator from the electrical system. With this switch in the off position, the entire electrical load is placed on the battery. Continued operation with the alternator switch off will reduce battery power low enough to open the battery contactor, remove power from the alternator field, and prevent alternator restart.

AMMETER.

The ammeter indicates the flow of current, in amperes, from the alternator to the battery or from the battery to the aircraft electrical system. When the engine is operating and the master switch is ON, the ammeter indicates the charging rate applied to the battery. In the event the alternator is not functioning or the electrical load exceeds the output of the alternator, the ammeter indicates the discharge rate of the battery.

OVER-VOLTAGE SENSOR AND WARNING LIGHT.

The aircraft is equipped with an automatic over-voltage protection system consisting of an over-voltage sensor behind the instrument panel and a red warning light, labeled HIGH VOLTAGE, below the engine instrument cluster.

In the event an over-voltage condition occurs, the over-voltage sensor automatically removes alternator field current and shuts down the alternator. The red warning light will then turn on, indicating to the pilot that the alternator is not operating and the aircraft battery is supplying all electrical power.

The over-voltage sensor may be reset by turning the master switch off and back on again. If the warning light does not illuminate, normal alternator charging has resumed; however, if the light does illuminate again, a malfunction has occurred, and the flight should be terminated as soon as practical.

The over-voltage warning light may be tested by momentarily turning off the ALT portion of the master switch and leaving the BAT portion turned on.

CIRCUIT BREAKERS AND FUSES.

Most of the electrical circuits in the aircraft are protected by "push-to-reset" circuit breakers mounted on the instrument panel. Exceptions to this are the battery contactor closing (external power) circuit, and the optional clock and flight hour recorder circuits which have fuses mounted near the battery. Also, the cigar lighter is protected by a manually-reset type circuit breaker mounted directly on the back of the lighter behind the instrument panel.

When more than one radio is installed, the radio transmitter relay (which is a part of the radio installation) is protected by the navigation lights circuit breaker labeled NAV LIGHTS. It is important to remember that any malfunction in the navigation lights system which causes the circuit breaker to open will de-activate both the navigation lights and the transmitter relay. In this event, the navigation light switch should be turned off to isolate the circuit; then reset the circuit breaker to re-activate the transmitter relay and permit its usage. Do not turn on the navigation light switch until the malfunction has been corrected.

LIGHTING EQUIPMENT.

EXTERIOR LIGHTING.

Conventional navigation lights are located in the wing tips and tail stinger. Two landing lights are installed in the cowl nose cap. When taxi lighting is selected, the left cowl light illuminates separately. Depressing the adjacent landing light switch causes both lights to illuminate and serve as landing lights. Optional lighting includes a flashing beacon which mounts on the top of the vertical fin, two strobe lights (one in each wing tip), and two courtesy lights (one under each wing just outboard of the cabin door). All exterior lights except the courtesy lights are controlled by rocker-type switches located on the left switch and control panel. The courtesy lights are operated by a switch, labeled UTILITY LIGHTS, on the aft side of the left rear door post.

The flashing beacon should not be used when flying through clouds or overcast; the flashing light reflected from water droplets or particles in the atmosphere, particularly at night, can produce vertigo and loss of orientation.

The two high intensity strobe lights will enhance anti-collision protection. However, the lights should be turned off when taxiing in the

vicinity of other aircraft, or during night flight through clouds, fog or haze.

INTERIOR LIGHTING.

Instrument and control panel lighting is provided by electroluminescent lighting, flood lighting, optional post lighting and integral lighting. Two concentric rheostat control knobs labeled LWR PANEL, ENG-RADIO, and a rheostat control knob labeled INSTRUMENTS control the intensity of instrument and control panel lighting. A rocker-type selector switch labeled POST-FLOOD is used to select either standard flood lighting or optional post lighting. These controls are located on the left switch and control panel.

Switches and controls on the lower part of the instrument panel are lighted by electroluminescent panels which do not require light bulbs for illumination. To operate this lighting, turn on the NAV light switch and adjust light intensity with the inner control knob labeled LWR PANEL.

Instrument panel flood lighting consists of four lights located in the glare shield above the instrument panel and two lights in the overhead console. To use flood lighting, place the POST-FLOOD selector switch in the FLOOD position and adjust light intensity with the INSTRUMENTS control knob.

The instrument panel may be equipped with optional post lights which are mounted at the edge of each instrument or control and provide direct lighting. The lights are operated by placing the POST-FLOOD selector switch in the POST position and adjusting intensity with the INSTRUMENTS control knob. Switching to post lights will automatically turn off flood lighting.

The magnetic compass, engine instrument cluster, radios and radio selector switches have integral lighting and operate independently of post or flood lighting. Compass light intensity is controlled by the INSTRUMENTS control knob. Integral lighting in the engine instrument cluster and radios is controlled by the ENG-RADIO control knob. For information concerning radio selector switch lighting, refer to Section VII.

The control pedestal has two integral lights and the optional overhead oxygen console is equipped with post lights. This lighting is controlled by the ENG-RADIO control knob.

Map lighting may be provided by three different sources: standard overhead console map lights, a standard glare shield mounted map light,

and an optional control wheel map light. The console map lights operate in conjunction with instrument panel flood lighting and consist of two additional openings just aft of the overhead flood light openings. These openings have sliding covers controlled by small round knobs. To use the map lights, slide the covers open by moving the two knobs toward each other. Close the covers when the map lights are no longer required. A map light, mounted in the lower surface of the glare shield, is used for illuminating approach plates or other charts when using a control wheel mounted approach plate clip. The map light switch, labeled MAP LIGHT, is located adjacent to the light. To use the light, turn on the MAP LIGHT switch and adjust intensity with the INSTRUMENTS control knob. The optional map light mounted on the bottom of the pilot's control wheel illuminates the lower portion of the cabin in front of the pilot, and is used when checking maps and other flight data during night operation. To operate the light, turn on the NAV light switch and adjust map light intensity with the rheostat control knob on the back of the control wheel pad on the right side.

A dome light is mounted in the ceiling of the rear cabin area as an aid to loading of passengers during night operations. A slide switch adjacent to the light turns the light on and off.

CABIN HEATING, VENTILATING AND DEFROSTING SYSTEM.

The temperature and volume of airflow into the cabin can be regulated to any degree desired by manipulation of the push-pull CABIN HEAT and CABIN AIR knobs. Both control knobs are the double-button type with friction locks to permit intermediate settings.

NOTE

For improved partial heating on mild days, pull out the CABIN AIR knob slightly when the CABIN HEAT knob is out. This action increases the airflow through the system, increasing efficiency, and blends cool outside air with the exhaust manifold heated air, thus eliminating the possibility of overheating the system ducting.

The rotary type DEFROST knob regulates the airflow for windshield defrosting.

Front cabin heat and ventilating air is supplied by outlet holes spaced across a cabin manifold just forward of the pilot's and copilot's feet. Rear cabin heat and air are supplied by two ducts from the manifold, one extending down each side of the cabin to an outlet at the front door post at floor level. Windshield defrost air is also supplied by a duct leading from the cabin manifold.

Separate adjustable ventilators supply additional air; one near each upper corner of the windshield supplies air for the pilot and copilot, and two optional ventilators in the rear cabin ceiling supply air to the rear seat passengers.

SHOULDER HARNESES.

Shoulder harnesses are provided as standard equipment for the pilot and front seat passenger, and as optional equipment for the rear seat passengers.

Each front seat harness is attached to a rear door post just above window line and is stowed behind a stowage sheath mounted above the cabin door. To stow each front seat harness, fold the free end and place it behind the sheath. The optional rear seat shoulder harnesses are attached near the lower corners of the aft side windows. Each harness is stowed behind a stowage sheath located above the aft side window.

To use the front and rear seat shoulder harnesses, fasten and adjust the seat belt first. Remove the harness from the stowed position, and lengthen as required by pulling on the end of the harness and the narrow release strap. Snap the harness metal stud firmly into the retaining slot adjacent to the seat belt buckle. Then adjust to length by pulling down on the free end of the harness. A properly adjusted harness will permit the occupant to lean forward enough to sit completely erect but is tight enough to prevent excessive forward movement and contact with objects during sudden deceleration. Also, the pilot will want the freedom to reach all controls easily.

Releasing and removing the shoulder harness is accomplished by pulling upward on the narrow release strap and removing the harness stud from the slot in the seat belt buckle. In an emergency, the shoulder harness may be removed by releasing the seat belt first, and then pulling the harness over the head by pulling up on the release strap.

INTEGRATED SEAT BELT/SHOULDER HARNESSSES WITH INERTIA REELS.

Optional integrated seat belt/shoulder harnesses with inertia reels are available for the pilot and front seat passenger. The seat belt/shoulder harnesses extend from inertia reels in the cabin ceiling to attach points inboard of the two front seats. A separate seat belt half and buckle is located outboard of the seats. The inertia reels are located in the aft overhead console, and are labeled PILOT and COPILOT. Inertia reels allow complete freedom of body movement. However, in the event of a sudden deceleration, they will lock up automatically to protect the occupants.

To use the seat belt/shoulder harness, adjust the metal buckle half on the harness up far enough to allow it to be drawn across the lap of the occupant and be fastened into the outboard seat belt buckle. Adjust seat belt tension by pulling up on the shoulder harness. To remove the seat belt/shoulder harness, release the seat belt buckle and allow the inertia reel to draw the harness to the inboard side of the seat.

STARTING ENGINE.

Ordinarily the engine starts easily with one or two strokes of the primer in warm temperatures to six strokes in cold weather with the throttle open approximately $1/2$ inch. In extremely cold temperatures it may be necessary to continue priming while cranking. Weak intermittent firing followed by puffs of black smoke from the exhaust stack indicate overpriming or flooding. Excess fuel can be cleared from the combustion chambers by the following procedure: Set the mixture control full lean and the throttle full open; then crank the engine through several revolutions with the starter. Repeat the starting procedure without any additional priming.

If the engine is underprimed (most likely in cold weather with a cold engine) it will not fire at all. Additional priming will be necessary for the next starting attempt. As soon as the cylinders begin to fire, open the throttle slightly to keep it running.

If prolonged cranking is necessary, allow the starter motor to cool at frequent intervals, since excessive heat may damage the armature.

After starting, if the oil gage does not begin to show pressure within 30 seconds in the summertime and about twice that long in very cold weather, stop engine and investigate. Lack of oil pressure can cause serious engine damage. After starting, avoid the use of carburetor heat unless icing conditions prevail.

TAXIING DIAGRAM

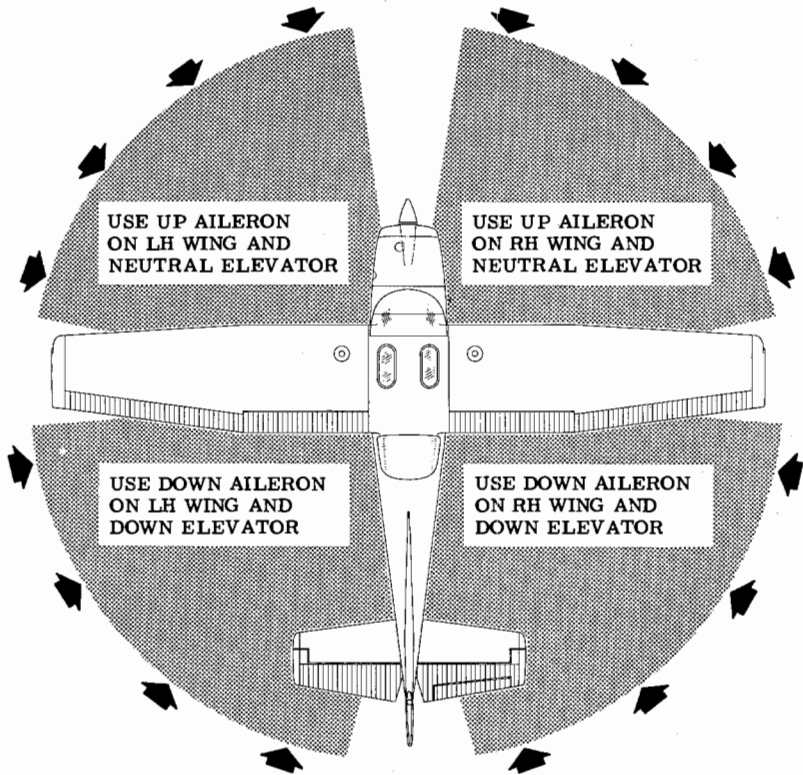

CODE

WIND DIRECTION



NOTE

Strong quartering tail winds require caution. Avoid sudden bursts of the throttle and sharp braking when the airplane is in this attitude. Use the steerable nose wheel and rudder to maintain direction.

Figure 2-4.

TAXIING.

The carburetor heat knob should be pushed full in during all ground operations unless heat is absolutely necessary for smooth engine operation. When the knob is pulled out to the heat position, air entering the engine is not filtered.

Taxiing over loose gravel or cinders should be done at low engine speed to avoid abrasion and stone damage to the propeller tips. Refer to figure 2-4 for additional taxiing instructions.

BEFORE TAKE-OFF.

WARM-UP.

Since the engine is closely cowled for efficient in-flight cooling, precautions should be taken to avoid overheating on the ground. Full throttle checks on the ground are not recommended unless the pilot has good reason to suspect that the engine is not turning up properly.

MAGNETO CHECK.

The magneto check should be made at 1700 RPM as follows. Move ignition switch first to R position, and note RPM. Next move switch back to BOTH to clear the other set of plugs. Then move switch to L position, note RPM and return the switch to the BOTH position. RPM drop should not exceed 150 RPM on either magneto or show greater than 50 RPM differential between magnetos. If there is a doubt concerning operation of the ignition system, RPM checks at higher engine speed will usually confirm whether a deficiency exists.

An absence of RPM drop may be an indication of faulty grounding of one side of the ignition system or should be cause for suspicion that the magneto timing is set in advance of the setting specified.

ALTERNATOR CHECK.

Prior to flights where verification of proper alternator and voltage regulator operation is essential (such as night or instrument flights), a positive verification can be made by loading the electrical system momentarily (3 to 5 seconds) with the landing light during the engine runup (1700 RPM). The ammeter will remain within a needle width of zero if the alternator and voltage regulator are operating properly.

TAKE-OFF.

It is important to check full-throttle engine operation early in the take-off run. Any signs of rough engine operation or sluggish engine acceleration is good cause for discontinuing the take-off.

Full throttle runups over loose gravel are especially harmful to propeller tips. When take-offs must be made over a gravel surface, it is very important that the throttle be advanced slowly. This allows the aircraft to start rolling before high RPM is developed, and the gravel will be blown back of the propeller rather than pulled into it.

After full throttle is applied, adjust the throttle friction lock clockwise to prevent the throttle from creeping back from a maximum power position. Similar friction lock adjustments should be made as required in other flight conditions to maintain a fixed throttle setting.

Normal take-offs are accomplished with wing flaps 0° to 20° , cowl flaps open, full throttle, and 2600 RPM. Reduce power to 23 inches of manifold pressure and 2450 RPM as soon as practical to minimize engine wear.

Using 20° wing flaps reduces the ground run and total distance over the obstacle by approximately 20 per cent. Soft field take-offs are performed with 20° flaps by lifting the aircraft off the ground as soon as practical in a slightly tail-low attitude. However, the aircraft should be leveled off immediately to accelerate to a safe climb speed.

If 20° wing flaps are used for take-off, they should be left down until all obstacles are cleared. To clear an obstacle with wing flaps 20 degrees, an obstacle clearance speed of 60 MPH should be used. If no obstructions are ahead, a best "flaps up" rate-of-climb speed of 89 MPH would be most efficient. These speeds vary slightly with altitude, but they are close enough for average field elevations. Flap deflections greater than 20° are not recommended at any time for take-off.

Take-offs into strong crosswinds normally are performed with the minimum flap setting necessary for the field length, to minimize the drift angle immediately after take-off. The aircraft is accelerated to a speed slightly higher than normal, then pulled off abruptly to prevent possible settling back to the runway while drifting. When clear of the ground, make a coordinated turn into the wind to correct for drift.

ENROUTE CLIMB.

A cruising climb at 23 inches of manifold pressure, 2450 RPM (approximately 75% power) and 100 to 120 MPH is recommended to save time and fuel for the overall trip. In addition, this type of climb provides better engine cooling, less engine wear, and more passenger comfort due to lower noise level. A cruise power mixture may be used unless engine temperatures tend to become excessive.

If it is necessary to climb rapidly to clear mountains or reach favorable winds at high altitudes, the best rate-of-climb speed should be used with maximum power. This speed is 89 MPH at sea level, decreasing 2 MPH for each 5000 feet above sea level. The mixture should be full rich unless the engine is rough due to excessive richness.

If an obstruction ahead requires a steep climb angle, the aircraft should be flown at an obstacle clearance speed of approximately 70 MPH with flaps up and maximum power.

CRUISE.

Normal cruising is performed between 55% and 75% power. The corresponding power settings and fuel consumption for various altitudes can be determined by using your Cessna Power Computer or the Operational Data in Section VI.

NOTE

Cruising should be done at 65% to 75% power until a total of 50 hours has accumulated or oil consumption has stabilized. This is to ensure proper seating of the rings and is applicable to new engines, and engines in service following cylinder replacement or top overhaul of one or more cylinders.

The Cruise Performance table on the following page illustrates the true airspeed and miles per gallon during cruise for various altitudes and percent powers. This table should be used as a guide, along with the available winds aloft information, to determine the most favorable altitude and power setting for a given trip. The selection of cruise altitude on the basis of the most favorable wind conditions and the use of low power settings are significant factors that should be considered on every trip to reduce fuel consumption.

CRUISE PERFORMANCE						
SKYLANE						
	75% POWER		65% POWER		55% POWER	
ALTITUDE	TAS	MPG	TAS	MPG	TAS	MPG
Sea Level	155	11.2	148	12.1	138	13.5
3500 Feet	161	11.6	152	12.5	142	13.9
6500 Feet	165	11.9	156	12.8	145	14.2
Standard Conditions					Zero Wind	

For reduced noise levels, it is desirable to select the lowest RPM in the green arc range for a given percent power that will provide smooth engine operation. The cowl flaps should be opened, if necessary, to maintain the cylinder head temperature at approximately two-thirds of the normal operating range (green arc).

Cruise performance data in this manual and on the power computer is based on an extended range mixture setting. This mixture setting results in approximately 10% greater range at any particular power setting with a negligible loss in airspeed when compared to a best power mixture setting. An extended range mixture should be established as follows:

- (1) Pull mixture control out slowly until engine becomes rough.
- (2) Push the mixture control in slightly to obtain smooth engine operation; then further enrichen an equal amount.

A best power mixture is approximated by advancement of the mixture control twice as far from the threshold of roughness as described by Step 2.

For best fuel economy at 55% power or less, the engine may be operated at the leanest mixture that results in smooth engine operation. This can result in approximately 10 percent greater range than shown in the cruise tables of this manual accompanied by approximately 7 MPH decrease in speed.

Any change in altitude, power or carburetor heat will require a change in the lean mixture setting and a recheck of the EGT setting (if installed).

Carburetor ice, as evidenced by an unexplained drop in manifold pressure, can be removed by application of full carburetor heat. Upon regaining the original manifold pressure indication (with heat off), use the minimum amount of heat (by trial and error) to prevent ice from forming. Since heated air causes a richer mixture, readjust the mixture setting when carburetor heat is used continuously in cruising flight.

The use of full carburetor heat is recommended during flight in very heavy rain to avoid the possibility of engine stoppage due to excessive water ingestion. The mixture setting should be readjusted for smoothest operation.

LEANING WITH A CESSNA ECONOMY MIXTURE INDICATOR (EGT).

Exhaust gas temperature (EGT) as shown on the optional Cessna Economy Mixture Indicator may be used as an aid for mixture leaning in cruising flight at 75% power or less. To adjust the mixture, using this indicator, lean to establish the peak EGT as a reference point and then enrichen the mixture by a desired increment based on the table below.

Continuous operation at peak EGT is authorized only at 55% power or less. This best economy mixture setting results in approximately 10% greater range than shown in the cruise tables of this manual accompanied by approximately 7 MPH decrease in speed.

MIXTURE DESCRIPTION	EXHAUST GAS TEMPERATURE	RANGE INCREASE FROM BEST POWER
BEST POWER	Peak EGT Minus 125 °F (Enrichen)	0%
EXTENDED RANGE (Owner's Manual and Computer Performance)	Peak EGT Minus 75 °F (Enrichen)	10%
BEST ECONOMY (55% Power or Less)	Peak EGT	20%

NOTE

Operation on the lean side of peak EGT is not approved.

When leaning the mixture under some conditions, engine roughness may occur before peak EGT is reached. In this case, use the EGT corresponding to the onset of roughness as the reference point instead of peak EGT.

STALLS.

The stall characteristics are conventional and aural warning is provided by a stall warning horn which sounds between 5 and 10 MPH above the stall in all configurations.

Power-off stall speeds at maximum gross weight and aft c.g. position are presented in figure 6-2 as calibrated airspeeds since indicated airspeeds are unreliable near the stall.

LANDING.

NORMAL LANDING.

Landings should be made on the main wheels first to reduce the landing speed and the subsequent need for braking in the landing roll. The nose wheel is lowered gently to the runway after the speed has diminished to avoid unnecessary nose gear load. This procedure is especially important in rough field landings.

SHORT FIELD LANDING.

For short field landings, make a power-off approach at 69 MPH with 40° flaps and land on the main wheels first. Immediately after touchdown, lower the nose gear to the ground and apply heavy braking as required. For maximum brake effectiveness after all three wheels are on the ground, retract the flaps, hold full nose up elevator and apply maximum possible brake pressure without sliding the tires.

CROSSWIND LANDING.

When landing in a strong crosswind, use the minimum flap setting required for the field length. Although the crab or combination method of

drift correction may be used, the wing-low method gives the best control. After touchdown, hold a straight course with the steerable nose wheel and occasional braking if necessary.

BALKED LANDING.

In a balked landing (go-around) climb, the wing flap setting should be reduced to 20° immediately after full power is applied. After all obstacles are cleared and a safe altitude and airspeed are obtained, the wing flaps should be retracted.

COLD WEATHER OPERATION.

STARTING.

Prior to starting on a cold morning, it is advisable to pull the propeller through several times by hand to "break loose" or "limber" the oil, thus conserving battery energy.

NOTE

When pulling the propeller through by hand, treat it as if the ignition switch is turned on. A loose or broken ground wire on either magneto could cause the engine to fire.

In extremely cold (0°F and lower) weather, the use of an external preheater (for both the engine and battery) and an external power source is recommended whenever possible to obtain positive starting and to reduce wear and abuse to the engine and the electrical system. Pre-heat will thaw the oil trapped in the oil cooler, which probably will be congealed prior to starting in extremely cold temperatures. When using an external power source, the position of the master switch is important. Refer to Section VII, paragraph Ground Service Plug Receptacle, for operating details.

Cold weather starting procedures are as follows:

With Preheat:

- (1) With ignition switch OFF, mixture full rich, and throttle open 1/2", prime the engine four to eight strokes as the propeller is being turned over by hand.

NOTE

Use heavy strokes of the primer for best atomization of fuel. After priming, push the primer all the way in and turn to the locked position to avoid the possibility of the engine drawing fuel through the primer.

- (2) Propeller -- CLEAR.
- (3) Turn master switch ON.
- (4) Turn ignition switch to START.
- (5) Pull carburetor heat on after engine has started, and leave on until the engine is running smoothly.

Without Preheat:

- (1) Prime the engine six to eight strokes while the propeller is being turned by hand with mixture full rich and throttle open 1/2". Leave the primer charged and ready for stroke.
- (2) Propeller -- CLEAR.
- (3) Turn master switch ON.
- (4) Turn ignition switch to START.
- (5) Pump throttle rapidly to full open twice. Return to 1/2" open position.
- (6) Release ignition switch to BOTH when engine starts.
- (7) Continue to prime the engine until it is running smoothly, or alternately, pump the throttle rapidly over the first 1/4 of total travel.
- (8) Oil pressure -- CHECK.
- (9) Pull carburetor heat on after engine has started. Leave on until the engine is running smoothly.
- (10) Primer -- LOCK.

NOTE

If the engine does not start during the first few attempts, or if engine firing diminishes in strength, it is probable that the spark plugs have been frosted over. Preheat must be used before another start is attempted.

IMPORTANT

Excessive priming and pumping throttle may cause raw fuel to accumulate in the intake air duct, creating a fire hazard in the event of a backfire. If this

occurs, maintain a cranking action to suck flames into the engine. An outside attendant with a fire extinguisher is advised for cold starts without pre-heat.

OPERATION.

During cold weather operations, no indication will be apparent on the oil temperature gage prior to take-off if outside air temperatures are very cold. After a suitable warm-up period (2 to 5 minutes at 1000 RPM), accelerate the engine several times to higher engine RPM. If the engine accelerates smoothly and the oil pressure remains normal and steady, the aircraft is ready for take-off.

Rough engine operation in cold weather can be caused by a combination of an inherently leaner mixture due to the dense air and poor vaporization and distribution of the fuel-air mixture to the cylinders. The effects of these conditions are especially noticeable during operation on one magneto in ground checks where only one spark plug fires in each cylinder.

For optimum operation of the engine in cold weather, the appropriate use of carburetor heat is recommended. The following procedures are indicated as a guideline:

- (1) Use carburetor heat during engine warm-up and ground check. Full carburetor heat may be required for temperatures below 10°F, whereas partial heat could be used in temperatures between 10°F and 40°F.
- (2) Use the minimum carburetor heat required for smooth operation in take-off, climb, and cruise.

NOTE

When operating in sub-zero temperatures, care should be exercised when using partial carburetor heat to avoid icing. Partial heat may raise the carburetor air temperature to the 32° to 70°F range where icing is critical under certain atmospheric conditions.

- (3) If the aircraft is equipped with a carburetor air temperature gage, it can be used as a reference in maintaining carburetor air temperature at or slightly above the top of the yellow arc by application of carburetor heat.

(4) Select relatively high manifold pressure and RPM settings for optimum mixture distribution, and avoid excessive manual leaning in cruising flight.

(5) Avoid sudden throttle movements during ground and flight operation.

Refer to Section VII for discussion of additional cold weather equipment.

HOT WEATHER OPERATION.

The general warm temperature starting information on page 2-10 is appropriate. Avoid prolonged engine operation on the ground.

NOISE ABATEMENT.

Increased emphasis on improving the quality of our environment requires renewed effort on the part of all pilots to minimize the effect of aircraft noise on the public.

We, as pilots, can demonstrate our concern for environmental improvement, by application of the following suggested procedures, and thereby tend to build public support for aviation:

(1) Pilots operating aircraft under VFR over outdoor assemblies of persons, recreational and park areas, and other noise-sensitive areas should make every effort to fly not less than 2,000 feet above the surface, weather permitting, even though flight at a lower level may be consistent with the provisions of government regulations.

(2) During departure from or approach to an airport, climb after take-off and descent for landing should be made so as to avoid prolonged flight at low altitude near noise-sensitive areas.

NOTE

The above recommended procedures do not apply where they would conflict with Air Traffic Control clearances or instructions, or where, in the pilot's judgment, an altitude of less than 2,000 feet is necessary for him to adequately exercise his duty to see and avoid other aircraft.

Section III

EMERGENCY PROCEDURES

Emergencies caused by aircraft or engine malfunctions are extremely rare if proper pre-flight inspections and maintenance are practiced. Enroute weather emergencies can be minimized or eliminated by careful flight planning and good judgement when unexpected weather is encountered. However, should an emergency arise the basic guidelines described in this section should be considered and applied as necessary to correct the problem.

ENGINE FAILURE.

ENGINE FAILURE AFTER TAKE-OFF.

Prompt lowering of the nose to maintain airspeed and establish a glide attitude is the first response to an engine failure after take-off. In most cases, the landing should be planned straight ahead with only small changes in direction to avoid obstructions. Altitude and airspeed are seldom sufficient to execute a 180° gliding turn necessary to return to the runway. The following procedures assume that adequate time exists to secure the fuel and ignition systems prior to touchdown.

- (1) Airspeed -- 80 MPH.
- (2) Mixture -- IDLE CUT-OFF.
- (3) Fuel Selector Valve -- OFF.
- (4) Ignition Switch -- OFF.
- (5) Wing Flaps -- AS REQUIRED (40° recommended).
- (6) Master Switch -- OFF.

ENGINE FAILURE DURING FLIGHT.

While gliding toward a suitable landing area, an effort should be made to identify the cause of the failure. If time permits, and an engine restart is feasible, proceed as follows:

- (1) Airspeed -- 80 MPH.
- (2) Carburetor Heat -- ON.

- (3) Fuel Selector Valve -- BOTH.
- (4) Mixture -- RICH.
- (5) Ignition Switch -- BOTH (or START if propeller is not windmilling).
- (6) Primer -- IN and LOCKED.

If the engine cannot be restarted, a forced landing without power must be executed. A recommended procedure for this is given in the following paragraph.

FORCED LANDINGS.

EMERGENCY LANDING WITHOUT ENGINE POWER.

If all attempts to restart the engine fail and a forced landing is imminent, select a suitable field and prepare for the landing as follows:

- (1) Airspeed -- 80 MPH (flaps UP).
75 MPH (flaps DOWN).
- (2) Mixture -- IDLE CUT-OFF.
- (3) Fuel Selector Valve -- OFF.
- (4) Ignition Switch -- OFF.
- (5) Wing Flaps -- AS REQUIRED (40° recommended).
- (6) Master Switch -- OFF.
- (7) Doors -- UNLATCH PRIOR TO TOUCHDOWN.
- (8) Touchdown -- SLIGHTLY TAIL LOW.
- (9) Brakes -- APPLY HEAVILY.

PRECAUTIONARY LANDING WITH ENGINE POWER.

Before attempting an "off airport" landing, one should drag the landing area at a safe but low altitude to inspect the terrain for obstructions and surface conditions, proceeding as follows:

- (1) Drag over selected field with flaps 20° and 75 MPH airspeed, noting the preferred area for touchdown for the next landing approach. Then retract flaps upon reaching a safe altitude and airspeed.
- (2) Radio, Electrical Switches -- OFF.
- (3) Wing Flaps -- 40° (on final approach).
- (4) Airspeed -- 75 MPH.
- (5) Master Switch -- OFF.
- (6) Doors -- UNLATCH PRIOR TO TOUCHDOWN.
- (7) Touchdown -- SLIGHTLY TAIL LOW.

- (8) Ignition Switch -- OFF.
- (9) Brakes -- APPLY HEAVILY.

DITCHING.

Prepare for ditching by securing or jettisoning heavy objects located in the baggage area, and collect folded coats or cushions for protection of occupant's face at touchdown. Transmit Mayday message on 121.5 MHz giving location and intentions.

- (1) Plan approach into wind if winds are high and seas are heavy. With heavy swells and light wind, land parallel to swells.
- (2) Approach with flaps 40° and sufficient power for a 300 ft/min rate of descent at 70 MPH.
- (3) Unlatch the cabin doors.
- (4) Maintain a continuous descent until touchdown in level attitude. Avoid a landing flare because of difficulty in judging aircraft height over a water surface.
- (5) Place folded coat or cushion in front of face at time of touchdown.
- (6) Evacuate aircraft through cabin doors. If necessary, open window to flood cabin compartment for equalizing pressure so that door can be opened.
- (7) Inflate life vests and raft (if available) after evacuation of cabin. The aircraft cannot be depended on for flotation for more than a few minutes.

FIRES.

ENGINE FIRE DURING START ON GROUND.

Improper starting procedures during a difficult cold weather start can cause a backfire which could ignite fuel that has accumulated in the intake duct. In this event, proceed as follows:

- (1) Continue cranking in an attempt to get a start which would suck the flames and accumulated fuel through the carburetor and into the engine.
- (2) If the start is successful, run the engine at 1700 RPM for a few minutes before shutting it down to inspect the damage.
- (3) If engine start is unsuccessful, continue cranking for two or three minutes with throttle full open while ground attendants obtain fire extinguishers.

- (4) When ready to extinguish fire, discontinue cranking and turn off master switch, ignition switch, and fuel selector valve.
- (5) Smother flames with fire extinguisher, seat cushion, wool blanket, or loose dirt. If practical, try to remove carburetor air filter if it is ablaze.
- (6) Make a thorough inspection of fire damage, and repair or replace damaged components before conducting another flight.

ENGINE FIRE IN FLIGHT.

Although engine fires are extremely rare in flight, the following steps should be taken if one is encountered:

- (1) Mixture -- IDLE CUT-OFF.
- (2) Fuel Selector Valve -- OFF.
- (3) Master Switch -- OFF.
- (4) Cabin Heat and Air -- OFF (except wing vents).
- (5) Airspeed -- 100 MPH. If fire is not extinguished, increase glide speed to find an airspeed which will provide an incombustible mixture.

Execute a forced landing as outlined in preceding paragraphs.

ELECTRICAL FIRE IN FLIGHT.

The initial indication of an electrical fire is usually the odor of burning insulation. The following procedure should then be used:

- (1) Master Switch -- OFF.
- (2) All Other Switches (except Ignition Switch) -- OFF.
- (3) Vents/Cabin Air/Heat -- CLOSED.
- (4) Fire Extinguisher -- ACTIVATE (if available).

If fire appears out and electrical power is necessary for continuance of flight:

- (5) Master Switch -- ON.
- (6) Circuit Breakers -- CHECK for faulty circuit; do not reset.
- (7) Radio/Electrical Switches -- ON one at a time, with delay after each until short circuit is localized.
- (8) Vents/Cabin Air/Heat -- OPEN when it is ascertained that fire is completely extinguished.

DISORIENTATION IN CLOUDS.

In the event of a vacuum system failure during flight in marginal weather, the directional gyro and gyro horizon will be disabled, and the pilot will have to rely on the turn coordinator or the turn and bank indicator if he inadvertently flies into clouds. The following instructions assume that only the electrically-powered turn coordinator or the turn and bank indicator is operative, and that the pilot is not completely proficient in partial panel instrument flying.

EXECUTING A 180° TURN IN CLOUDS.

Upon entering the clouds, an immediate plan should be made to turn back as follows:

- (1) Note the time of the minute hand and observe the position of the sweep second hand on the clock.
- (2) When the sweep second hand indicates the nearest half-minute, initiate a standard rate left turn, holding the turn coordinator symbolic aircraft wing opposite the lower left index mark for 60 seconds. Then roll back to level flight by leveling the miniature aircraft.
- (3) Check accuracy of the turn by observing the compass heading which should be the reciprocal of the original heading.
- (4) If necessary, adjust heading primarily with skidding motions rather than rolling motions so that the compass will read more accurately.
- (5) Maintain altitude and airspeed by cautious application of elevator control. Avoid overcontrolling by keeping the hands off the control wheel and steering only with rudder.

EMERGENCY LET-DOWNS THROUGH CLOUDS.

If possible, obtain radio clearance for an emergency descent through clouds. To guard against a spiral dive, choose an easterly or westerly heading to minimize compass card swings due to changing bank angles. In addition, keep hands off the control wheel and steer a straight course with rudder control by monitoring the turn coordinator. Occasionally check the compass heading and make minor corrections to hold an approximate course. Before descending into the clouds, set up a stabilized let-down condition as follows:

- (1) Apply full rich mixture.
- (2) Use full carburetor heat.

- (3) Reduce power to set up a 500 to 800 ft./min. rate of descent.
- (4) Adjust the elevator trim tab for a stabilized descent at 90 MPH.
- (5) Keep hands off the control wheel.
- (6) Monitor turn coordinator and make corrections by rudder alone.
- (7) Adjust rudder trim to relieve unbalanced rudder force, if present.
- (8) Check trend of compass card movement and make cautious corrections with rudder to stop the turn.
- (9) Upon breaking out of clouds, resume normal cruising flight.

RECOVERY FROM A SPIRAL DIVE.

If a spiral is encountered, proceed as follows:

- (1) Close the throttle.
- (2) Stop the turn by using coordinated aileron and rudder control to align the symbolic airplane in the turn coordinator with the horizon reference line.
- (3) Cautiously apply control wheel back pressure to slowly reduce the indicated airspeed to 90 MPH.
- (4) Adjust the elevator trim control to maintain a 90 MPH glide.
- (5) Keep hands off the control wheel, using rudder control to hold a straight heading. Adjust rudder trim to relieve unbalanced rudder force, if present.
- (6) Apply carburetor heat.
- (7) Clear engine occasionally, but avoid using enough power to disturb the trimmed glide.
- (8) Upon breaking out of clouds, apply normal cruising power and resume flight.

SPINS.

Intentional spins are prohibited in this aircraft. Should an inadvertent spin occur, the following recovery technique should be used.

- (1) Retard throttle to idle position.
- (2) Apply full rudder opposite to the direction of rotation.
- (3) After one-fourth turn, move the control wheel forward of neutral in a brisk motion.
- (4) As rotation stops, neutralize rudder, and make a smooth recovery from the resulting dive.

FLIGHT IN ICING CONDITIONS.

Although flying in known icing conditions is prohibited, an unexpected

icing encounter should be handled as follows:

- (1) Turn pitot heat switch ON (if installed).
- (2) Turn back or change altitude to obtain an outside air temperature that is less conducive to icing.
- (3) Pull cabin heat control full out and rotate defroster control clockwise to obtain maximum defroster airflow.
- (4) Increase engine speed to minimize ice build-up on propeller blades.
- (5) Watch for signs of carburetor air filter ice and apply carburetor heat as required. An unexplained loss in manifold pressure could be caused by carburetor ice or air intake filter ice. Lean the mixture if carburetor heat is used continuously.
- (6) Plan a landing at the nearest airport. With an extremely rapid ice build-up, select a suitable "off airport" landing site.
- (7) With an ice accumulation of 1/4 inch or more on the wing leading edges, be prepared for significantly higher stall speed.
- (8) Leave wing flaps retracted. With a severe ice build-up on the horizontal tail, the change in wing wake airflow direction caused by wing flap extension could result in a loss of elevator effectiveness.
- (9) Perform a landing approach using a forward slip, if necessary, for improved visibility.
- (10) Approach at 90 to 100 MPH, depending upon the amount of ice accumulation.
- (11) Perform a landing in level attitude.

ROUGH ENGINE OPERATION OR LOSS OF POWER.

CARBURETOR ICING.

An unexplained drop in manifold pressure and eventual engine roughness may result from the formation of carburetor ice. To clear the ice, apply full throttle and pull the carburetor heat knob full out until the engine runs smoothly; then remove carburetor heat and readjust the throttle. If conditions require the continued use of carburetor heat in cruise flight, use the minimum amount of heat necessary to prevent ice from forming and lean the mixture slightly for smoothest engine operation.

SPARK PLUG FOULING.

A slight engine roughness in flight may be caused by one or more spark plugs becoming fouled by carbon or lead deposits. This may be verified by turning the ignition switch momentarily from BOTH to either

L or R position. An obvious power loss in single ignition operation is evidence of spark plug or magneto trouble. Assuming that spark plugs are the more likely cause, lean the mixture to the normal lean setting for cruising flight. If the problem does not clear up in several minutes, determine if a richer mixture setting will produce smoother operation. If not, proceed to the nearest airport for repairs using the BOTH position of the ignition switch unless extreme roughness dictates the use of a single ignition position.

MAGNETO MALFUNCTION.

A sudden engine roughness or misfiring is usually evidence of magneto problems. Switching from BOTH to either L or R ignition switch position will identify which magneto is malfunctioning. Select different power settings and enrichen the mixture to determine if continued operation on BOTH magnetos is practicable. If not, switch to the good magneto and proceed to the nearest airport for repairs.

LOW OIL PRESSURE.

If low oil pressure is accompanied by normal oil temperature, there is a possibility the oil pressure gage or relief valve is malfunctioning. A leak in the line to the gage is not necessarily cause for an immediate precautionary landing because an orifice in this line will prevent a sudden loss of oil from the engine sump. However, a landing at the nearest airport would be advisable to inspect the source of trouble.

If a total loss of oil pressure is accompanied by a rise in oil temperature, there is reason to suspect an engine failure is imminent. Reduce engine power immediately and select a suitable forced landing field. Leave the engine running at low power during the approach, using only the minimum power required to reach the desired touchdown spot.

ELECTRICAL POWER SUPPLY SYSTEM MALFUNCTIONS.

Malfunctions in the electrical power supply system can be detected by periodic monitoring of the ammeter and over-voltage warning light; however, the cause of these malfunctions is usually difficult to determine. A broken alternator drive belt or wiring is the most likely cause of alternator failures, although other factors could cause the problem. A damaged or improperly adjusted voltage regulator can also cause malfunctions. Problems of this nature constitute an electrical emergency and should be dealt with immediately. Electrical power malfunctions usually fall into

two categories: excessive rate of charge and insufficient rate of charge. The paragraphs below describe the recommended remedy for each situation.

EXCESSIVE RATE OF CHARGE.

After engine starting and heavy electrical usage at low engine speeds (such as extended taxiing) the battery condition will be low enough to accept above normal charging during the initial part of a flight. However, after thirty minutes of cruising flight, the ammeter should be indicating less than two needle widths of charging current. If the charging rate were to remain above this value on a long flight, the battery would overheat and evaporate the electrolyte at an excessive rate. Electronic components in the electrical system could be adversely affected by higher than normal voltage if a faulty voltage regulator setting is causing the overcharging. To preclude these possibilities, an over-voltage sensor will automatically shut down the alternator and the over-voltage warning light will illuminate if the charge voltage reaches approximately 16 volts. Assuming that the malfunction was only momentary, an attempt should be made to reactivate the alternator system. To do this, turn both sides of the master switch off and then on again. If the problem no longer exists, normal alternator charging will resume and the warning light will go off. If the light comes on again, a malfunction is confirmed. In this event, the flight should be terminated and/or the current drain on the battery minimized because the battery can supply the electrical system for only a limited period of time. If the emergency occurs at night, power must be conserved for later use of the landing light and flaps during landing.

INSUFFICIENT RATE OF CHARGE.

If the ammeter indicates a continuous discharge rate in flight, the alternator is not supplying power to the system and should be shut down since the alternator field circuit may be placing an unnecessary load on the system. All non-essential equipment should be turned OFF and the flight terminated as soon as practical.

EMERGENCY LOCATOR TRANSMITTER (ELT).

The ELT consists of a self-contained dual-frequency radio transmitter and battery power supply, and is activated by an impact of 5g or more as may be experienced in a crash landing. The ELT emits an omnidirectional signal on the international distress frequencies of 121.5 and 243.0 MHz. General aviation and commercial aircraft, the FAA, and CAP

monitor 121.5 MHz, and 243.0 MHz is monitored by the military. Following a crash landing, the ELT will provide line-of-sight transmission up to 100 miles at 10,000 feet. The duration of ELT transmissions is affected by ambient temperature. At temperatures of +70° to +130°F, continuous transmission for 115 hours can be expected; a temperature of -40°F will shorten the duration to 70 hours.

The ELT is readily identified as a bright orange unit mounted behind the rear baggage compartment wall on the left side of the fuselage. To

ELT CONTROL PANEL

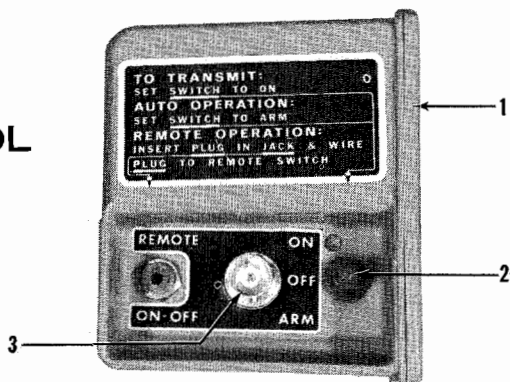

1. COVER - Removable for access to battery.
2. FUNCTION SELECTOR SWITCH (3-position toggle switch):
 - ON - Activates transmitter instantly. Used for test purposes and if "g" switch is inoperative.
 - OFF - Deactivates transmitter. Used during shipping, storage and following rescue.
 - ARM - Activates transmitter only when "g" switch receives 5g or more impact.
3. ANTENNA RECEPTACLE - Connection to antenna mounted on top of the tailcone.

Figure 3-1.

gain access to the unit, pull the rear wall loose from the adhesive fasteners which secure it in position. The ELT is operated by a control panel at the forward facing end of the unit (see figure 3-1).

ELT OPERATION.

- (1) **NORMAL OPERATION:** As long as the function selector switch remains in the ARM position, the ELT automatically activates following an impact of 5g or more over a short time period.
- (2) **ELT FAILURE:** If "g" switch actuation is questioned following a minor crash landing, gain access to the ELT and place the function selector switch in the ON position.
- (3) **PRIOR TO SIGHTING RESCUE AIRCRAFT:** Conserve aircraft battery. Do not activate radio transceiver.
- (4) **AFTER SIGHTING RESCUE AIRCRAFT:** Place ELT function selector switch in the OFF position, preventing radio interference. Attempt contact with rescue aircraft with the radio transceiver set to a frequency of 121.5 MHz. If no contact is established, return the function selector switch to ON immediately.
- (5) **FOLLOWING RESCUE:** Place ELT function selector switch in the OFF position, terminating emergency transmissions.
- (6) **INADVERTENT ACTIVATION:** Following a lightning strike or an exceptionally hard landing, the ELT may activate although no emergency exists. Select 121.5 MHz on your radio transceiver. If the ELT can be heard transmitting, place the function selector switch in the OFF position; then immediately return the switch to ARM.

Section IV

OPERATING LIMITATIONS

OPERATIONS AUTHORIZED.

Your Cessna exceeds the requirements for airworthiness as set forth by the United States Government, and is certificated under FAA Type Certificate No. 3A13 as Cessna Model No. 182P.

The aircraft may be equipped for day, night, VFR, or IFR operation. Your Cessna Dealer will be happy to assist you in selecting equipment best suited to your needs.

Your aircraft must be operated in accordance with all FAA-approved markings and placards in the aircraft. If there is any information in this section which contradicts the FAA-approved markings and placards, it is to be disregarded.

MANEUVERS—NORMAL CATEGORY.

The aircraft is certificated in the normal category. The normal category is applicable to aircraft intended for non-aerobatic operations. These include any maneuvers incidental to normal flying, stalls (except whip stalls) and turns in which the angle of bank is not more than 60°. In connection with the foregoing, the following gross weight and flight load factors apply:

Gross Weight	2950 lbs
Flight Load Factor:	
*Flaps Up	+3.8 -1.52
*Flaps Down	+2.0

*The design load factors are 150% of the above, and in all cases, the structure meets or exceeds design loads.

AIRSPPEED LIMITATIONS (CAS).

The following is a list of the certificated calibrated airspeed (CAS) limitations for the aircraft.

Never Exceed Speed (glide or dive, smooth air)	198 MPH
Maximum Structural Cruising Speed	160 MPH
Maximum Speed, Flaps Extended	
Flaps 10°	160 MPH
Flaps 10° - 40°	110 MPH
*Maneuvering Speed	126 MPH

*The maximum speed at which you may use abrupt control travel.

AIRSPPEED INDICATOR MARKINGS.

The following is a list of the certificated calibrated airspeed markings (CAS) for the aircraft.

Never Exceed (glide or dive, smooth air)	198 MPH (red line)
Caution Range	160-198 MPH (yellow arc)
Normal Operating Range	68-160 MPH (green arc)
Flap Operating Range	63-110 MPH (white arc)

ENGINE OPERATION LIMITATIONS.

Power and Speed 230 BHP at 2600 RPM

ENGINE INSTRUMENT MARKINGS.

OIL TEMPERATURE GAGE.

Normal Operating Range	Green Arc
Do Not Exceed	240° F (red line)

OIL PRESSURE GAGE.

Idling Pressure 10 psi (red line)
Normal Operating Range 30-60 psi (green arc)
Maximum Pressure 100 psi (red line)

FUEL QUANTITY INDICATORS.

Empty E (red line)
(2.5 gallons unusable each tank in normal flight maneuvers
with fuel selector valve on BOTH.)

CYLINDER HEAD TEMPERATURE GAGE.

Normal Operating Range 200-460° F (green arc)
Do Not Exceed 460° F (red line)

TACHOMETER.

Normal Operating Range 2200-2450 RPM (green arc)
Do Not Exceed (Engine rated speed) 2600 RPM (red line)

MANIFOLD PRESSURE GAGE.

Normal Operating Range 15-23 in. Hg (green arc)

CARBURETOR AIR TEMPERATURE GAGE (OPT).

Icing Range -15° to 5°C (yellow arc)

SUCTION GAGE (GYRO SYSTEM).

Normal Operating Range 4.6-5.4 in. Hg (green arc)

WEIGHT AND BALANCE.

The following information will enable you to operate your Cessna within the prescribed weight and center of gravity limitations. To figure weight and balance, use the Sample Loading Problem, Loading Graph, and Center of Gravity Moment Envelope as follows:

Take the licensed empty weight and moment from appropriate weight and balance records carried in your airplane, and write them down in the column titled **YOUR AIRPLANE** on the Sample Loading Problem.

NOTE

The licensed empty weight and moment are recorded on the Weight and Balance and Installed Equipment Data sheet, or

on revised weight and balance records, and are included in the aircraft file. In addition to the licensed empty weight and moment noted on these records, the c. g. arm (fuselage station) is also shown, but need not be used on the Sample Loading Problem. The moment which is shown must be divided by 1000 and this value used as the moment/1000 on the loading problem.

Use the Loading Graph to determine the moment/1000 for each additional item to be carried; then list these on the loading problem.

NOTE

Loading Graph information for the pilot, passengers, baggage/cargo and hatshelf is based on seats positioned for average occupants and baggage/cargo or hatshelf items loaded in the center of these areas as shown on the Loading Arrangements diagram. For loadings which may differ from these, the Sample Loading Problem lists fuselage stations for these items to indicate their forward and aft c. g. range limitation (seat travel and baggage/cargo or hatshelf area limitation). Additional moment calculations, based on the actual weight and c. g. arm (fuselage station) of the item being loaded, must be made if the position of the load is different from that shown on the Loading Graph.

Total the weights and moments/1000 and plot these values on the Center of Gravity Moment Envelope to determine whether the point falls within the envelope, and if the loading is acceptable.

BAGGAGE AND CARGO TIE-DOWN

A nylon baggage net having six tie-down straps is provided as standard equipment to secure baggage in the area aft of the rear seat and on the hatshelf. Six eyebolts serve as attaching points for the net. Two eyebolts for the forward tie-down straps are mounted on the cabin floor near each sidewall just forward of the baggage door approximately at station 92; two center eyebolts mount on the floor slightly inboard of each sidewall just aft of the baggage door approximately at station 109; the two aft eyebolts secure at the top of the rear baggage wall at station 124. If an optional child's seat is installed, only the center and aft eyebolts will be needed for securing the net in the area remaining behind the seat. A placard on the baggage door defines the weight limitations in the baggage areas.

An optional cargo tie-down kit consisting of nine tie-down attachments is available if it is desired to remove the rear seat (and child's seat, if installed) and utilize the rear cabin area to haul cargo. Two tie-down attachments clamp to the aft end of the two outboard front seat rails and are locked in place by a bolt which must be tightened to a minimum of fifty inch pounds. Seven tie-down attachments bolt to standard attach points in the cabin floor, including three rear seat mounting points. The seven attach points are located as follows: two are located slightly inboard and just aft of the rear door posts approximately at station 69; two utilize the aft outboard mounting points of the rear seat; one utilizes the rearmost mounting point of the aft center attach point for the rear seat approximately at station 84 (a second mounting point is located just forward of this point but is not used); and two are located just forward of the center baggage net tie-down eyebolts approximately at station 108. The maximum allowable cabin floor loading of the rear cabin area is 200 pounds/square foot; however, when items with small or sharp support areas are carried, the installation of a 1/4" plywood floor is recommended to protect the aircraft structure. The maximum rated load weight capacity for each of the seven tie-downs is 140 pounds and for the two seat rail tie-downs is 100 pounds. Rope, strap, or cable used for tie-down should be rated at a minimum of ten times the load weight capacity of the tie-down fittings used. Weight and balance calculations for cargo in the area of the rear seat, baggage and hatshelf area can be figured on the Loading Graph using the lines labeled 2nd Row Passengers or Cargo and/or Baggage or Passengers on Child's Seat.

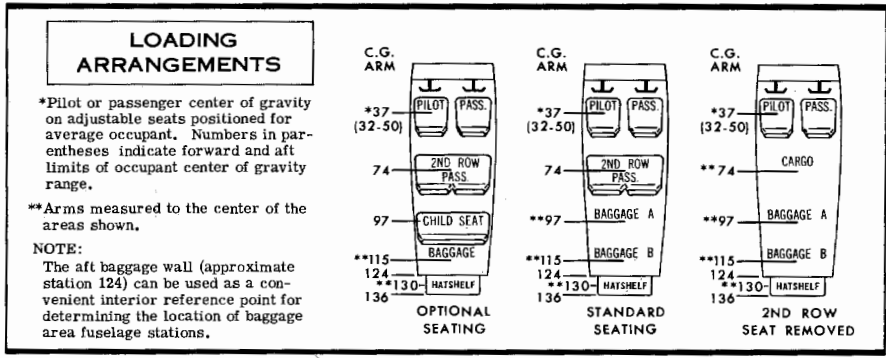

SAMPLE LOADING PROBLEM	SAMPLE AIRPLANE		YOUR AIRPLANE	
	Weight (lbs.)	Moment (lb.-ins. /1000)	Weight (lbs.)	Moment (lb.-ins. /1000)
1. Licensed Empty Weight (Use the data pertaining to your airplane as it is presently equipped. Includes unusable fuel.)	1726	62.4		
2. Oil (12 Qts. - The weight of full oil may be used for all calculations. 12 Qts = 22 Lbs. at -0.3 Moment/1000)	22	-0.3	22	-0.3
3. Usable Fuel (At 6 Lbs./Gal.)				
Standard Tanks (60 Gal. Maximum)	360	17.3		
Long Range Tanks (79 Gal. Maximum)				
4. Pilot and Front Passenger (Sta. 32 to 50)	340	12.6		
5. Second Row Passengers	340	25.2		
Cargo Replacing Second Row Seats (Station 65 to 82)				
6. Baggage (Area "A") or Passenger on Child's Seat (Station 82 to 108) 120 Lbs. Maximum	120	11.6		
7. Baggage - Aft (Area "B") and Hatshelf (Station 108 to 136) 80 Lbs. Maximum	42	4.8		
8. TOTAL WEIGHT AND MOMENT	2950	133.6		
9. Locate this point (2950 at 133.6) on the Center of Gravity Moment Envelope, and since this point falls within the envelope, the loading is acceptable.				

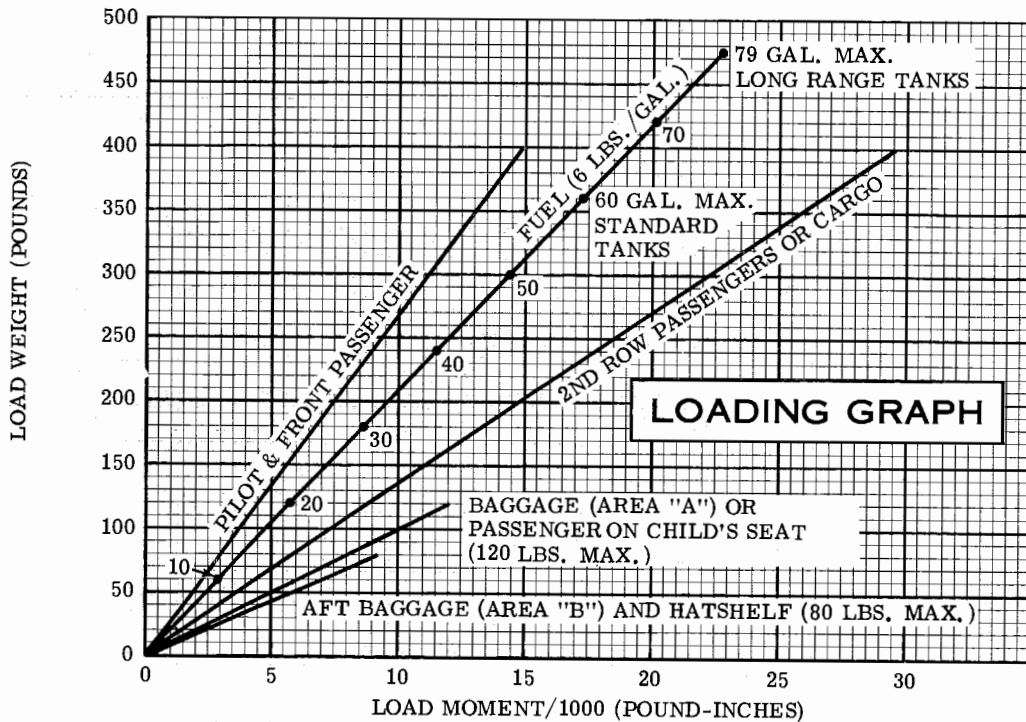

- NOTES: (1) Line representing adjustable seats shows pilot and front seat passenger center of gravity on adjustable seats positioned for an average occupant. Refer to the Loading Arrangements diagram for forward and aft limits of occupant c.g. range.
- (2) Engine Oil: 12 Quarts = 22 Lbs. at -0.3 Moment/1000.
- (3) Hatshef Maximum Load 25 Lbs.

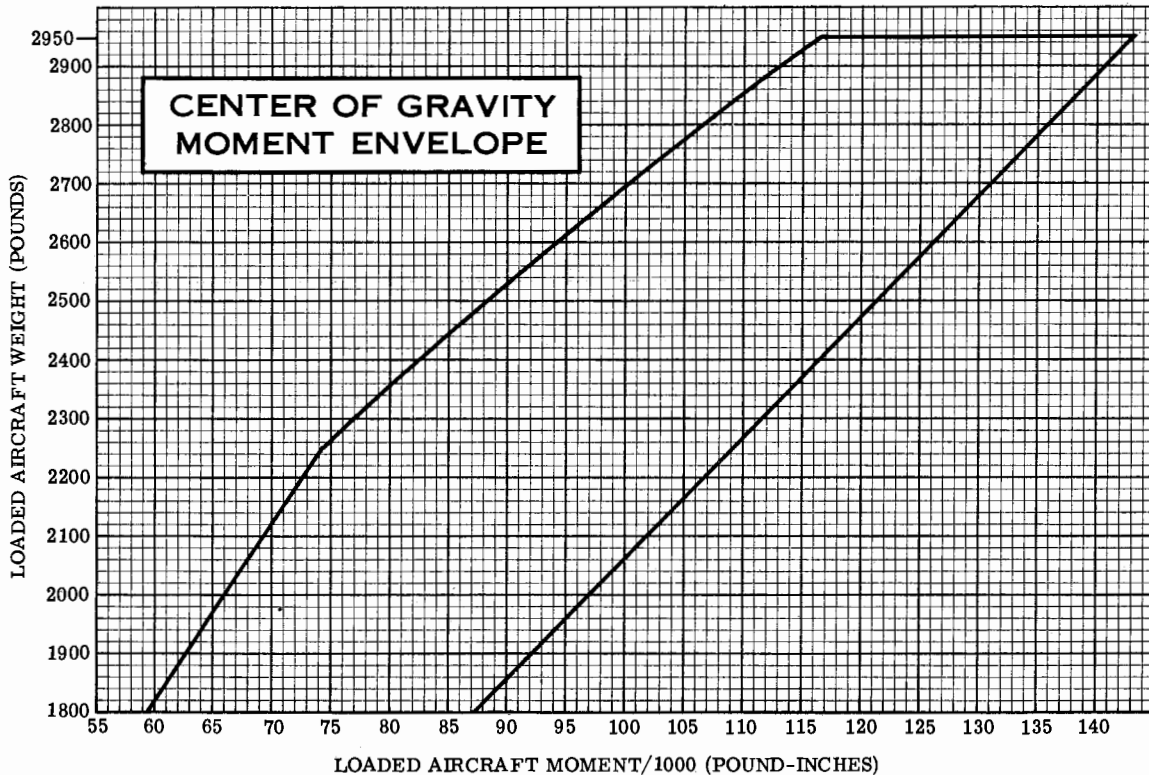

Section V

CARE OF THE AIRPLANE

If your aircraft is to retain that new-plane performance and dependability, certain inspection and maintenance requirements must be followed. It is wise to follow a planned schedule of lubrication and preventive maintenance based on climatic and flying conditions encountered in your locality.

Keep in touch with your Cessna Dealer, and take advantage of his knowledge and experience. He knows your airplane and how to maintain it. He will remind you when lubrications and oil changes are necessary, and about other seasonal and periodic services.

GROUND HANDLING.

The aircraft is most easily and safely maneuvered by hand with the tow-bar attached to the nose wheel. When towing with a vehicle, do not exceed the nose gear turning angle of 29° either side of center, or damage to the gear will result. If the aircraft is towed or pushed over a rough surface during hangaring, watch that the normal cushioning action of the nose strut does not cause excessive vertical movement of the tail and the resulting contact with low hangar doors or structure. A flat nose tire or deflated strut will also increase tail height.

MOORING YOUR AIRPLANE.

Proper tie-down procedure is your best precaution against damage to your parked aircraft by gusty or strong winds. To tie down your aircraft securely, proceed as follows:

- (1) Set the parking brake and install the control wheel lock.
- (2) Install a surface control lock over the fin and rudder.
- (3) Tie sufficiently strong ropes or chains (700 pounds tensile strength) to the wing and tail-down fittings, and secure each rope to a ramp tie-down.
- (4) Tie a sufficiently strong rope to the nose gear torque link and secure it to a ramp tie-down.
- (5) Install a pitot tube cover.

WINDSHIELD-WINDOWS.

The plastic windshield and windows should be cleaned with an aircraft windshield cleaner. Apply the cleaner sparingly with soft cloths, and rub with moderate pressure until all dirt, oil scum and bug stains are removed. Allow the cleaner to dry, then wipe it off with soft flannel cloths.

If a windshield cleaner is not available, the plastic can be cleaned with soft cloths moistened with Stoddard solvent to remove oil and grease.

NOTE

Never use gasoline, benzine, alcohol, acetone, carbon tetrachloride, fire extinguisher or anti-ice fluid, lacquer thinner or glass cleaner to clean the plastic. These materials will attack the plastic and may cause it to craze.

Follow by carefully washing with a mild detergent and plenty of water. Rinse thoroughly, then dry with a clean moist chamois. Do not rub the plastic with a dry cloth since this builds up an electrostatic charge which attracts dust. Waxing with a good commercial wax will finish the cleaning job. A thin, even coat of wax, polished out by hand with clean soft flannel cloths, will fill in minor scratches and help prevent further scratching.

Do not use a canvas cover on the windshield unless freezing rain or sleet is anticipated since the cover may scratch the plastic surface.

ALUMINUM SURFACES.

The clad aluminum surfaces of your Cessna may be washed with clear water to remove dirt; oil and grease may be removed with gasoline, naphtha, carbon tetrachloride or other non-alkaline solvents. Dulled aluminum surfaces may be cleaned effectively with an aircraft aluminum polish.

After cleaning, and periodically thereafter, waxing with a good automotive wax will preserve the bright appearance and retard corrosion. Regular waxing is especially recommended for airplanes operated in salt water areas as a protection against corrosion.

PAINTED SURFACES.

The painted exterior surfaces of your new Cessna have a durable, long lasting finish and, under normal conditions, require no polishing or buffing. Approximately 15 days are required for the paint to cure completely; in most cases, the curing period will have been completed prior to delivery of the aircraft. In the event that polishing or buffing is required within the curing period, it is recommended that the work be done by someone experienced in handling uncured paint. Any Cessna Dealer can accomplish this work.

Generally, the painted surfaces can be kept bright by washing with water and mild soap, followed by a rinse with water and drying with cloths or a chamois. Harsh or abrasive soaps or detergents which cause corrosion or scratches should never be used. Remove stubborn oil and grease with a cloth moistened with Stoddard solvent.

Waxing is unnecessary to keep the painted surfaces bright. However, if desired, the aircraft may be waxed with a good automotive wax. A heavier coating of wax on the leading edges of the wings and tail and on the engine nose cap and propeller spinner will help reduce the abrasion encountered in these areas.

When the aircraft is parked outside in cold climates and it is necessary to remove ice before flight, care should be taken to protect the painted surfaces during ice removal with chemical liquids. A 50-50 solution of isopropyl alcohol and water will satisfactorily remove ice accumulations without damaging the paint. A solution with more than 50% alcohol is harmful and should be avoided. While applying the de-icing solution, keep it away from the windshield and cabin windows since the alcohol will attack the plastic and may cause it to craze.

PROPELLER CARE.

Preflight inspection of propeller blades for nicks, and wiping them occasionally with an oily cloth to clean off grass and bug stains will assure long, trouble-free service. Small nicks on the propeller, particularly near the tips and on the leading edges, should be dressed out as soon as possible since these nicks produce stress concentrations, and if ignored, may result in cracks. Never use an alkaline cleaner on the blades; remove grease and dirt with carbon tetrachloride or Stoddard solvent.

INTERIOR CARE.

To remove dust and loose dirt from the upholstery and carpet, clean the interior regularly with a vacuum cleaner.

Blot up any spilled liquid promptly with cleansing tissue or rags. Don't pat the spot; press the blotting material firmly and hold it for several seconds. Continue blotting until no more liquid is taken up. Scrape off sticky materials with a dull knife, then spot-clean the area.

Oily spots may be cleaned with household spot removers, used sparingly. Before using any solvent, read the instructions on the container and test it on an obscure place on the fabric to be cleaned. Never saturate the fabric with a volatile solvent; it may damage the padding and backing materials.

Soiled upholstery and carpet may be cleaned with a foam-type detergent, used according to the manufacturer's instructions. Keep the foam as dry as possible and remove it with a vacuum cleaner, to minimize wetting the fabric.

If your aircraft is equipped with leather seating, cleaning of the seats is accomplished using a soft cloth or sponge dipped in mild soap suds. The soap suds, used sparingly, will remove traces of dirt and grease. The soap should be removed with a clean damp cloth.

The plastic trim, headliner, instrument panel and control knobs need only be wiped off with a damp cloth. Oil and grease on the control wheel and control knobs can be removed with a cloth moistened with Stoddard solvent. Volatile solvents, such as mentioned in paragraphs on care of the windshield, must never be used since they soften and craze the plastic.

MAA PLATE/FINISH AND TRIM PLATE.

Information concerning the Type Certificate Number (TC), Production Certificate Number (PC), Model Number and Serial Number of your particular aircraft can be found on the MAA (Manufacturers Aircraft Association) plate located on the left forward doorpost.

A Finish and Trim Plate contains a code describing the interior color scheme and exterior paint combination of the aircraft. The code may be used in conjunction with an applicable Parts Catalog if finish and trim in-

formation is needed. This plate is located adjacent to the MAA plate on the left forward doorpost.

AIRCRAFT FILE.

There are miscellaneous data, information and licenses that are a part of the aircraft file. The following is a checklist for that file. In addition, a periodic check should be made of the latest Federal Aviation Regulations to ensure that all data requirements are met.

A. To be displayed in the aircraft at all times:

- (1) Aircraft Airworthiness Certificate (FAA Form 8100-2).
- (2) Aircraft Registration Certificate (FAA Form 8050-3).
- (3) Aircraft Radio Station License, if transmitter installed (FCC Form 556).

B. To be carried in the aircraft at all times:

- (1) Weight and Balance, and associated papers (latest copy of the Repair and Alteration Form, FAA Form 337, if applicable).
- (2) Aircraft Equipment List.

C. To be made available upon request:

- (1) Aircraft Log Book.
- (2) Engine Log Book.

Most of the items listed are required by the United States Federal Aviation Regulations. Since the Regulations of other nations may require other documents and data, owners of exported aircraft should check with their own aviation officials to determine their individual requirements.

Cessna recommends that these items, plus the Owner's Manual, Power Computer, Pilot's Checklist, Customer Care Program book and Customer Care Card, be carried in the aircraft at all times.

FLYABLE STORAGE.

Aircraft placed in non-operational storage for a maximum of 30 days

or those which receive only intermittent operational use for the first 25 hours are considered in flyable storage status. Every seventh day during these periods, the propeller should be rotated by hand through five revolutions. This action "limbers" the oil and prevents any accumulation of corrosion on engine cylinder walls.

IMPORTANT

For maximum safety, check that the ignition switch is OFF, the throttle is closed, the mixture control is in the idle cut-off position, and the aircraft is secured before rotating the propeller by hand. Do not stand within the arc of the propeller blades while turning the propeller.

After 30 days, the aircraft should be flown for 30 minutes or a ground runup should be made just long enough to produce an oil temperature within the lower green arc range. Excessive ground runup should be avoided.

Engine runup also helps to eliminate excessive accumulations of water in the fuel system and other air spaces in the engine. Keep fuel tanks full to minimize condensation in the tanks. Keep the battery fully charged to prevent the electrolyte from freezing in cold weather. If the aircraft is to be stored temporarily, or indefinitely, refer to the Service Manual for proper storage procedures.

INSPECTION REQUIREMENTS.

As required by Federal Aviation Regulations, all civil aircraft of U.S. registry must undergo a complete inspection (annual) each twelve calendar months. In addition to the required ANNUAL inspection, aircraft operated commercially (for hire) must have a complete inspection every 100 hours of operation.

In lieu of the above requirements, an aircraft may be inspected in accordance with a progressive inspection schedule, which allows the work load to be divided into smaller operations that can be accomplished in shorter time periods.

The CESSNA PROGRESSIVE CARE PROGRAM has been developed to provide a modern progressive inspection schedule that satisfies the complete aircraft inspection requirements of both the 100 HOUR and ANNUAL inspections as applicable to Cessna aircraft.

CESSNA PROGRESSIVE CARE.

The Cessna Progressive Care Program has been designed to help you realize maximum utilization of your aircraft at a minimum cost and downtime. Under this program, your aircraft is inspected and maintained in four operations at 50-hour intervals during a 200-hour period. The operations are recycled each 200 hours and are recorded in a specially provided Aircraft Inspection Log as each operation is conducted.

The Cessna Aircraft Company recommends Progressive Care for aircraft that are being flown 200 hours or more per year, and the 100-hour inspection for all other aircraft. The procedures for the Progressive Care Program and the 100-hour inspection have been carefully worked out by the factory and are followed by the Cessna Dealer Organization. The complete familiarity of Cessna Dealers with Cessna equipment and factory-approved procedures provides the highest level of service possible at lower cost to Cessna owners.

CESSNA CUSTOMER CARE PROGRAM.

Specific benefits and provisions of the CESSNA WARRANTY plus other important benefits for you are contained in your CUSTOMER CARE PROGRAM book supplied with your aircraft. You will want to thoroughly review your Customer Care Program book and keep it in your aircraft at all times.

Coupons attached to the Program book entitle you to an initial inspection and either a Progressive Care Operation No. 1 or the first 100-hour inspection within the first 6 months of ownership at no charge to you. If you take delivery from your Dealer, the initial inspection will have been performed before delivery of the aircraft to you. If you pick up your aircraft at the factory, plan to take it to your Dealer reasonably soon after you take delivery, so the initial inspection may be performed, allowing the Dealer to make any minor adjustments which may be necessary.

You will also want to return to your Dealer either at 50 hours for your first Progressive Care Operation, or at 100 hours for your first 100-hour inspection depending on which program you choose to establish for your aircraft. While these important inspections will be performed for you by any Cessna Dealer, in most cases you will prefer to have the Dealer from whom you purchased the aircraft accomplish this work.

SERVICING REQUIREMENTS.

For quick and ready reference, quantities, materials, and specifications for frequently used service items (such as fuel, oil, etc.) are shown on the inside back cover of this manual.

In addition to the EXTERIOR INSPECTION covered in Section I, COMPLETE servicing, inspection, and test requirements for your aircraft are detailed in the aircraft Service Manual. The Service Manual outlines all items which require attention at 50, 100, and 200 hour intervals plus those items which require servicing, inspection, and/or testing at special intervals.

Since Cessna Dealers conduct all service, inspection, and test procedures in accordance with applicable Service Manuals, it is recommended that you contact your Dealer concerning these requirements and begin scheduling your aircraft for service at the recommended intervals.

Cessna Progressive Care ensures that these requirements are accomplished at the required intervals to comply with the 100-hour or ANNUAL inspection as previously covered.

Depending on various flight operations, your local Government Aviation Agency may require additional service, inspections, or tests. For these regulatory requirements, owners should check with local aviation officials where the aircraft is being operated.

OWNER FOLLOW-UP SYSTEM.

Your Cessna Dealer has an Owner Follow-Up System to notify you when he receives information that applies to your Cessna. In addition, if you wish, you may choose to receive similar notification, in the form of Service Letters, directly from the Cessna Customer Services Department. A subscription form is supplied in your Customer Care Program book for your use, should you choose to request this service. Your Cessna Dealer will be glad to supply you with details concerning these follow-up programs, and stands ready, through his Service Department, to supply you with fast, efficient, low-cost service.

PUBLICATIONS.

Various publications and flight operation aids are furnished in the aircraft when delivered from the factory. These items are listed below.

- CUSTOMER CARE PROGRAM BOOK
- OWNER'S MANUALS FOR YOUR
AIRCRAFT
AVIONICS AND AUTOPILOT
- POWER COMPUTER
- SALES AND SERVICE DEALER DIRECTORY
- DO'S AND DON'TS ENGINE BOOKLET

The following additional publications, plus many other supplies that are applicable to your aircraft, are available from your Cessna Dealer.

- SERVICE MANUALS AND PARTS CATALOGS FOR YOUR
AIRCRAFT
ENGINE AND ACCESSORIES
AVIONICS AND AUTOPILOT

Your Cessna Dealer has a current catalog of all Customer Services Supplies that are available, many of which he keeps on hand. Supplies which are not in stock, he will be happy to order for you.

Section VI

OPERATIONAL DATA

The operational data charts on the following pages are presented for two purposes; first, so that you may know what to expect from your aircraft under various conditions, and second, to enable you to plan your flights in detail and with reasonable accuracy.

The data in the charts has been compiled from actual flight tests with the aircraft and engine in good condition and using average piloting techniques. Note also that the range charts make no allowances for wind, navigational errors, warm-up, take-off, climb, etc. You must estimate these variables for yourself and make allowances accordingly. Speeds shown in the Cruise Performance charts reflect performance of the Sky-lane configuration; these speeds are 3 to 4 MPH faster than the Model 182.

Remember that the charts contained herein are based on standard day conditions. For more precise power, fuel consumption, and endurance information, consult the Power Computer supplied with your aircraft. With the Power Computer you can easily take into account temperature variations from standard at any flight altitude.

AIRSPPEED CORRECTION TABLE

FLAPS UP	IAS	60	80	100	120	140	160	180	---
	CAS	68	83	101	119	139	158	177	---
FLAPS DOWN 20° - 40°	IAS	40	50	60	70	80	90	100	110
	CAS	55	60	66	74	83	92	102	111

Figure 6-1.

STALL SPEEDS - MPH CAS

		ANGLE OF BANK		
	CONDITION	0°	30°	60°
2950 LBS. GROSS WEIGHT	FLAPS UP	64	69	91
	FLAPS 20°	59	63	83
	FLAPS 40°	57	61	81

POWER OFF - AFT CG

Figure 6-2.

TAKE-OFF DATA

TAKE-OFF DISTANCE WITH 20° FLAPS FROM HARD SURFACE RUNWAY

GROSS WEIGHT LBS.	IAS @ 50' MPH	HEAD WIND KNOTS	AT SEA LEVEL & 59°F.		AT 2500 FT. & 50°F.		AT 5000 FT. & 41°F.		AT 7500 FT. & 32°F.	
			GROUND RUN	TOTAL TO CLEAR 50' OBS	GROUND RUN	TOTAL TO CLEAR 50' OBS	GROUND RUN	TOTAL TO CLEAR 50' OBS	GROUND RUN	TOTAL TO CLEAR 50' OBS
2950	60	0	705	1350	845	1625	1015	1990	1240	2585
		10	490	1025	595	1245	725	1550	900	2040
		20	310	740	385	910	480	1150	610	1545
2500	55	0	485	955	575	1120	690	1330	840	1630
		10	325	710	395	840	475	1005	590	1255
		20	195	490	245	590	300	720	360	915
2000	50	0	295	655	350	745	415	855	500	1005
		10	185	460	225	530	275	620	335	740
		20	105	305	130	355	160	425	205	515

- NOTES: 1. Increase distances 10% for each 25°F above standard temperature for particular altitude.
 2. For operation on a dry, grass runway, increase distances (both "ground run" and "total to clear 50 ft. obstacle") by 7% of the "total to clear 50 ft. obstacle" figure.

MAXIMUM RATE-OF-CLIMB DATA

GROSS WEIGHT LBS.	IAS MPH	AT SEA LEVEL & 59°F.			AT 5000 FT. & 41°F.			AT 10,000 FT. & 23°F.			AT 15,000 FT. & 5°F.			AT 20,000 FT. & -12°F.		
		RATE OF CLIMB FT/MIN	GAL. OF FUEL USED	IAS MPH	RATE OF CLIMB FT/MIN	From SL FUEL USED	IAS MPH	RATE OF CLIMB FT/MIN	From SL FUEL USED	IAS MPH	RATE OF CLIMB FT/MIN	From SL FUEL USED	IAS MPH	RATE OF CLIMB FT/MIN	From SL FUEL USED	
2950	89	890	1.5	87	665	3.8	85	445	6.8	83	220	11.5	--	--	--	
2500	87	1210	1.5	85	935	3.2	83	655	5.2	80	380	8.2	78	105	14.9	
2000	84	1710	1.5	82	1350	2.7	79	995	4.1	76	640	5.9	74	280	9.2	

- NOTES: 1. Flaps up, full throttle, 2600 RPM, mixture leaned for smooth operation above 5000 ft.
 2. Fuel used includes warm-up and take-off allowance.
 3. For hot weather, decrease rate of climb 30 ft./min. for each 10°F above standard day temperature for particular altitude.

Figure 6-3.

CRUISE PERFORMANCE

EXTENDED RANGE MIXTURE

Standard Conditions \setminus Zero Wind \setminus Gross Weight- 2950 Pounds

2500 FEET

RPM	MP	% BHP	TAS MPH	GAL/ HOUR	60 GAL(NO RESERVE)		79 GAL(NO RESERVE)	
					ENDR. HOURS	RANGE MILES	ENDR. HOURS	RANGE MILES
2450	23	76	161	14.2	4.2	680	5.6	895
	22	72	157	13.4	4.5	705	5.9	930
	21	68	154	12.7	4.7	730	6.2	960
	20	63	150	12.0	5.0	750	6.6	990
2300	23	71	157	13.1	4.6	720	6.0	945
	22	67	152	12.2	4.9	750	6.5	985
	21	62	148	11.5	5.2	775	6.9	1020
	20	59	144	11.0	5.5	785	7.2	1035
2200	23	67	152	12.1	5.0	755	6.5	995
	22	63	149	11.4	5.3	785	6.9	1030
	21	59	144	10.8	5.6	800	7.3	1055
	20	55	140	10.2	5.9	820	7.7	1080
*2000	20	47	127	8.7	6.9	875	9.1	1155
	19	43	121	8.2	7.3	885	9.6	1165
	18	39	111	7.5	8.0	890	10.5	1170
	17	35	101	7.0	8.6	865	11.3	1140

*Power settings in this block represent maximum range settings.

Figure 6-4 (Sheet 1 of 5).

CRUISE PERFORMANCE

EXTENDED RANGE MIXTURE

Standard Conditions \ Zero Wind \ Gross Weight- 2950 Pounds

5000 FEET

RPM	MP	% BHP	TAS MPH	GAL/HOUR	60 GAL(NO RESERVE)		79 GAL(NO RESERVE)	
					ENDR. HOURS	RANGE MILES	ENDR. HOURS	RANGE MILES
2450	23	78	166	14.5	4.1	685	5.4	905
	22	73	163	13.6	4.4	715	5.8	945
	21	70	159	13.0	4.6	735	6.1	965
	20	65	154	12.2	4.9	760	6.5	1000
2300	23	73	161	13.4	4.5	725	5.9	950
	22	69	158	12.6	4.8	750	6.3	990
	21	64	153	11.9	5.0	775	6.6	1020
	20	60	149	11.2	5.4	800	7.1	1055
2200	23	68	158	12.4	4.8	765	6.4	1005
	22	64	153	11.7	5.1	785	6.8	1035
	21	60	149	11.0	5.5	810	7.2	1070
	20	57	145	10.5	5.7	830	7.5	1090
*2000	20	48	131	9.0	6.7	875	8.8	1155
	19	45	125	8.5	7.1	885	9.3	1165
	18	41	117	7.9	7.6	890	10.0	1170
	17	37	108	7.3	8.2	885	10.8	1165

*Power settings in this block represent maximum range settings.

Figure 6-4 (Sheet 2 of 5).

CRUISE PERFORMANCE

EXTENDED RANGE MIXTURE

Standard Conditions \ Zero Wind \ Gross Weight- 2950 Pounds

7500 FEET

RPM	MP	% BHP	TAS MPH	GAL/HOUR	60 GAL(NO RESERVE)		79 GAL(NO RESERVE)	
					ENDR. HOURS	RANGE MILES	ENDR. HOURS	RANGE MILES
2450	21	71	164	13.1	4.6	750	6.0	990
	20	67	159	12.4	4.8	770	6.4	1015
	19	62	155	11.7	5.1	795	6.8	1045
	18	58	149	11.0	5.5	815	7.2	1070
2300	21	66	158	12.2	4.9	780	6.5	1025
	20	62	154	11.6	5.2	800	6.8	1050
	19	58	149	11.0	5.5	815	7.2	1070
	18	54	144	10.5	5.7	825	7.5	1085
2200	21	62	155	11.4	5.3	815	6.9	1070
	20	58	150	10.7	5.6	840	7.4	1105
	19	54	145	10.2	5.9	850	7.7	1120
	18	51	139	9.7	6.2	860	8.1	1135
*2000	20	50	137	9.2	6.5	890	8.6	1175
	19	47	130	8.7	6.9	900	9.1	1190
	18	43	122	8.1	7.4	900	9.8	1190
	17	39	113	7.6	7.9	890	10.4	1175

*Power settings in this block represent maximum range settings.

Figure 6-4 (Sheet 3 of 5).

CRUISE PERFORMANCE

EXTENDED RANGE MIXTURE

Standard Conditions \searrow Zero Wind \searrow Gross Weight- 2950 Pounds
10,000 FEET

RPM	MP	% BHP	TAS MPH	GAL/HOUR	60 GAL(NO RESERVE)		79 GAL(NO RESERVE)	
					ENDR. HOURS	RANGE MILES	ENDR. HOURS	RANGE MILES
2450	19	63	159	11.9	5.0	800	6.6	1055
	18	60	154	11.2	5.4	830	7.1	1090
	17	55	148	10.6	5.7	835	7.5	1100
	16	51	141	10.0	6.0	850	7.9	1115
2300	19	60	154	11.1	5.4	835	7.1	1100
	18	56	148	10.5	5.7	850	7.5	1115
	17	51	141	9.8	6.1	865	8.1	1140
	16	47	133	9.2	6.5	870	8.6	1145
2200	19	56	149	10.4	5.8	860	7.6	1135
	18	52	143	9.8	6.1	875	8.1	1150
	17	49	136	9.3	6.5	880	8.5	1155
	16	45	128	8.7	6.9	885	9.1	1160
*2000	19	48	135	8.9	6.7	910	8.9	1200
	18	44	127	8.4	7.1	905	9.4	1190

*Power settings in this block represent maximum range settings.

Figure 6-4 (Sheet 4 of 5).

CRUISE PERFORMANCE

EXTENDED RANGE MIXTURE

Standard Conditions \searrow Zero Wind \searrow Gross Weight- 2950 Pounds
15,000 FEET

RPM	MP	% BHP	TAS MPH	GAL/HOUR	60 GAL(NO RESERVE)		79 GAL(NO RESERVE)	
					ENDR. HOURS	RANGE MILES	ENDR. HOURS	RANGE MILES
2450	16	54	150	10.4	5.8	865	7.6	1140
	15	50	141	9.8	6.1	865	8.1	1135
	14	46	132	9.2	6.5	860	8.6	1130
2300	16	50	141	9.6	6.2	885	8.2	1165
	15	47	134	9.1	6.6	880	8.7	1160
	14	42	122	8.5	7.1	850	9.3	1135
2200	16	47	136	9.1	6.6	895	8.7	1180
	15	44	126	8.6	7.0	880	9.2	1160

Figure 6-4 (Sheet 5 of 5).

LANDING DISTANCE TABLE

LANDING DISTANCE WITH 40° FLAPS ON HARD SURFACED RUNWAY

GROSS WEIGHT POUNDS	APPROACH IAS MPH	@ SEA LEVEL & 59° F		@ 2500 FEET & 50° F		@ 5000 FEET & 41° F		@ 7500 FEET & 32° F	
		GROUND ROLL	TOTAL TO CLEAR 50 FT. OBS.	GROUND ROLL	TOTAL TO CLEAR 50 FT. OBS.	GROUND ROLL	TOTAL TO CLEAR 50 FT. OBS.	GROUND ROLL	TOTAL TO CLEAR 50 FT. OBS.
2950	69	590	1350	640	1430	680	1505	740	1595

- NOTES: 1. Distances shown are based on zero wind, power off and heavy braking.
 2. Reduce landing distances 10% for each 5 knots headwind.
 3. For operation on a dry, grass runway, increase distances (both "ground roll" and "total to clear 50 ft. obstacle") by 20% of the "total to clear 50 ft. obstacle" figure.

Figure 6-5.

MAXIMUM GLIDE

- SPEED 80 MPH (IAS) —
- PROPELLER WINDMILLING
- FLAPS UP ● ZERO WIND

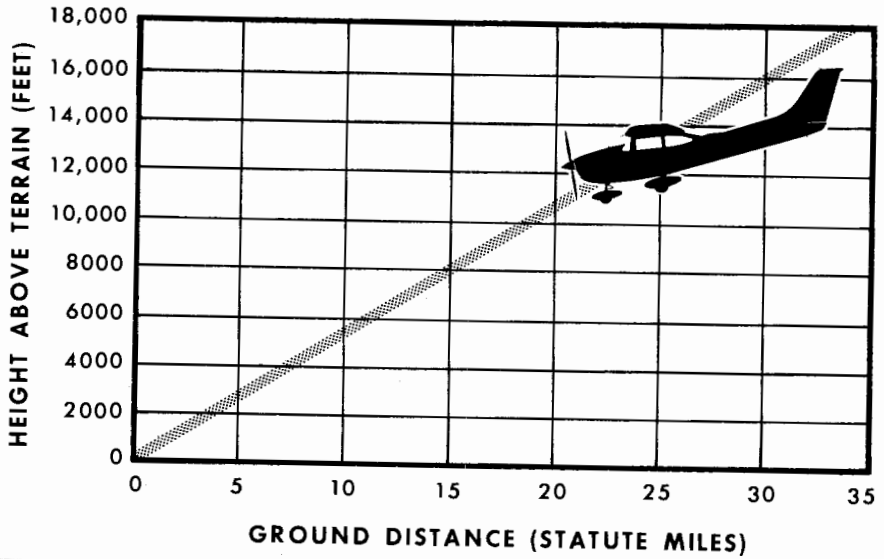

Figure 6-6.

Section VII

OPTIONAL SYSTEMS

This section contains a description, operating procedures, and performance data (when applicable) for some of the optional equipment which may be installed in your Cessna. Owner's Manual Supplements are provided to cover operation of other optional equipment systems when installed in your airplane. Contact your Cessna Dealer for a complete list of available optional equipment.

COLD WEATHER EQUIPMENT

WINTERIZATION KIT AND NON-CONGEALING OIL COOLER.

For continuous operation in temperatures consistently below 20°F, the Cessna winterization kit and non-congealing oil cooler should be installed to improve engine operation. The winterization kit consists of two shields to partially cover the cowl nose cap opening, one shield to cover the carburetor air intake, and insulation for the crankcase breather line. Once installed, the crankcase breather insulation is approved for permanent use in both cold and hot weather. The non-congealing oil cooler replaces the standard oil cooler and provides improved oil flow through the cooler in cold weather.

GROUND SERVICE PLUG RECEPTACLE.

A ground service plug receptacle may be installed to permit use of an external power source for cold weather starting and during lengthy main-

tenance work on the airplane electrical system (with the exception of electronic equipment).

NOTE

Electrical power for the airplane electrical circuits is provided through a split bus bar having all electronic circuits on one side of the bus and other electrical circuits on the other side of the bus. When an external power source is connected, a contactor automatically opens the circuit to the electronic portion of the split bus bar as a protection against damage to the transistors in the electronic equipment by transient voltages from the power source. Therefore, the external power source can not be used as a source of power when checking electronic components.

Just before connecting an external power source (generator type or battery cart), the master switch should be turned ON.

The ground service plug receptacle circuit incorporates a polarity reversal protection. Power from the external power source will flow only if the ground service plug is correctly connected to the airplane. If the plug is accidentally connected backwards, no power will flow to the airplane's electrical system, thereby preventing any damage to electrical equipment.

The battery and external power circuits have been designed to completely eliminate the need to "jumper" across the battery contactor to close it for charging a completely "dead" battery. A special fused circuit in the external power system supplies the needed "jumper" across the contacts so that with a "dead" battery and an external power source applied, turning the master switch ON will close the battery contactor.

STATIC PRESSURE ALTERNATE SOURCE VALVE.

A static pressure alternate source valve is available to provide continued operation of the airspeed indicator, altimeter and vertical speed indicator in the event that the static system ports or lines become obstructed.

If erroneous instrument readings are suspected due to water or ice in the static system ports or lines, the static pressure alternate source valve knob should be pulled on, venting the static system to the cabin.

However, cabin pressures will vary with open cabin ventilators or windows. The most adverse combinations will result in airspeed and altimeter variations of no more than 6 MPH and 50 feet respectively.

In climb and cruising flight, the airspeed and altimeter will read high. However, in the landing approach (when instrument readings are more important) the instruments will generally read low. Therefore, using the normal published approach speeds and altitudes will result in a slightly faster approach speed and higher approach path than normal, giving an extra margin of safety.

STATIC DISCHARGERS

If frequent IFR flights are planned, installation of optional wick-type static dischargers is recommended to improve radio communications during flight through dust or various forms of precipitation (rain, freezing rain, snow or ice crystals). Under these conditions, the build-up and discharge of static electricity from the trailing edges of the wings, rudder, elevators, propeller tips and radio antennas can result in loss of usable radio signals on all communications and navigation radio equipment. (Usually the ADF is first to be affected and VHF communication equipment is the last to be affected).

Installation of static dischargers reduces interference from precipitation static, but it is possible to encounter severe precipitation static conditions which might cause the loss of radio signals, even with static dischargers installed. Whenever possible, avoid known severe precipitation areas to prevent loss of dependable radio signals. If avoidance is impractical, minimize airspeed and anticipate temporary loss of radio signals while in these areas.

RADIO SELECTOR SWITCHES

RADIO SELECTOR SWITCH OPERATION.

Operation of the radio equipment is normal as covered in the respective radio manuals. When more than one radio is installed, an audio switching system is necessary. Audio switching is accomplished by a series of selector switches located at the top-center of the instrument panel. They are rectangular in shape, internally lighted, and the face of each switch is labeled to define the system it controls. The selector switches have one function when depressed and another function when extended. They are designed to lock when pushed in to the depressed position; they can be extended by pressing full in and allowing them to release to the extended position. Certain combinations of switches are interlocked to prevent more than one system from being utilized at the same time. Depressing one interlocked switch automatically disengages the others. All of the selector switches are lighted anytime the master switch is on. When a switch is depressed, its light becomes brighter. The light intensity of a depressed switch can be controlled with a rheostat labeled AUDIO SW, BRT located to the right of the selector switches. The following information describes the various selector switch functions.

TRANSMITTER SELECTOR SWITCH.

When two transmitters are installed, the microphone must be switched

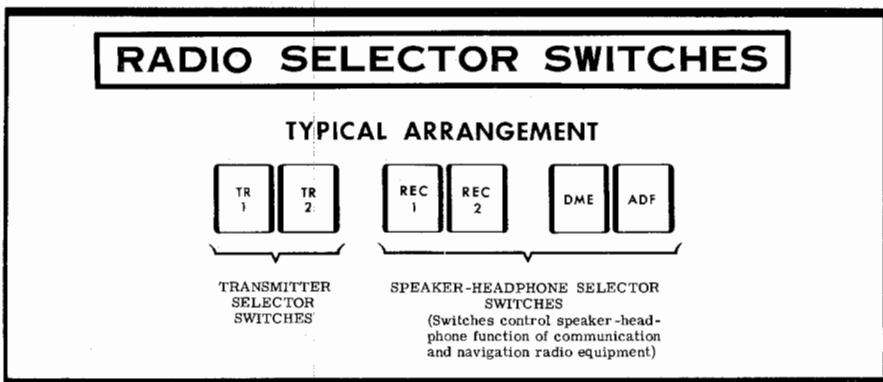

Figure 7-1.

to the transmitter the pilot has selected for use. To accomplish this, interlocking transmitter selector switches labeled TR 1 and TR 2 are provided. TR 1 selects the upper transmitter and TR 2 selects the lower transmitter.

The installation of Cessna radio equipment provides certain audio back-up capabilities and transmitter selector switch functions that the pilot should be familiar with. When the transmitter selector switch labeled TR 1 or TR 2 is depressed, the audio amplifier of the corresponding transceiver is utilized to provide the speaker audio for all radios. If the audio amplifier in the selected transceiver fails, as evidenced by loss of speaker audio for all radios, depress the transmitter selector switch for the transceiver not in use. Since an audio amplifier is not utilized for headphones, a malfunctioning amplifier will not affect headphone operation.

SPEAKER-PHONE SWITCHES.

The speaker-phone switches determine whether the output of the receiver in use is fed to the headphones or through the audio amplifier to the speaker. Depress the switch for the desired receiver to obtain speaker operation, or release it if headphone operation is desired.

MICROPHONE-HEADSET

A microphone-headset combination is offered as optional equipment. Using the microphone-headset and a microphone keying switch on the left side of the pilot's control wheel, the pilot can conduct radio communications without interrupting other control operations to handle a hand-held microphone. Also, passengers need not listen to all communications. The microphone and headset jacks are located near the lower left corner of the instrument panel.

OXYGEN SYSTEM

A four-place oxygen system is available for your airplane. In this system, an oxygen cylinder, located behind the rear baggage compartment wall, supplies the oxygen. Cylinder pressure is reduced to an operating pressure of 70 psi by a pressure regulator attached to the cylinder. A shutoff valve is included as part of the regulator assembly. An oxygen cylinder filler valve is located on the left side of the rear baggage compartment wall. Cylinder pressure is indicated by a pressure gage located in the overhead oxygen console.

Four oxygen outlets are provided; two in the overhead oxygen console and two in the cabin ceiling just above the side windows; one at each of the seating positions. One permanent, microphone-equipped mask is provided for the pilot, and three disposable type masks are provided for the passengers. All masks are the partial-rebreathing type equipped with vinyl plastic hoses and flow indicators.

A remote shutoff valve control, located adjacent to the pilot's oxygen outlet, is used to shut off the supply of oxygen to the system when not in use. The control is mechanically connected to the shutoff valve at the cylinder. With the exception of the shutoff function, the system is completely automatic and requires no manual regulation for change of altitude.

OXYGEN SYSTEM OPERATION.

Prior to flight, check to be sure that there is an adequate oxygen supply for the trip, by noting the oxygen pressure gage reading. Refer to paragraph OXYGEN DURATION CALCULATION, and to the Oxygen Duration Chart (figure 7-2). Also, check that the face masks and hoses are accessible and in good condition.

Supplemental oxygen should be used by all occupants when cruising above 10,000 feet. As described in the Cessna booklet "Man At Altitude," it is often advisable to use oxygen at altitudes lower than 10,000 feet under conditions of night flying, fatigue, or periods of physiological or emotional disturbances. Also, the habitual and excessive use of tobacco or alcohol will usually necessitate the use of oxygen at less than 10,000 feet.

OXYGEN DURATION CHART

(48 CUBIC FEET CAPACITY)

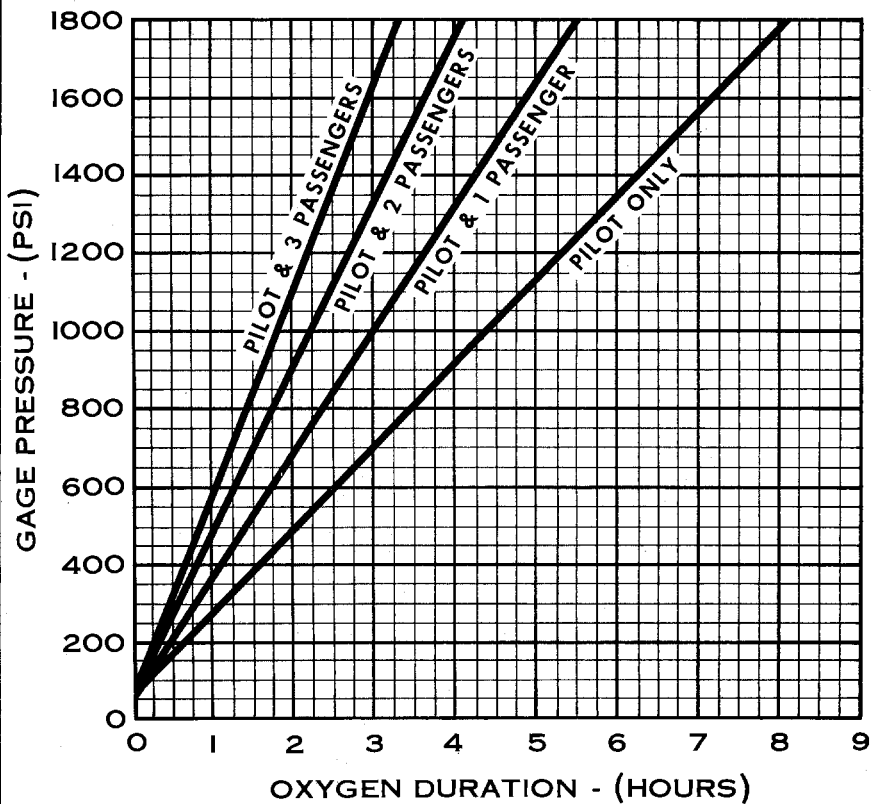

NOTE: This chart is based on a pilot with an orange color-coded oxygen line fitting and passengers with green color-coded line fittings.

Figure 7-2.

NOTE

For safety reasons, no smoking should be allowed in the aircraft while oxygen is being used.

When ready to use the oxygen system, proceed as follows:

- (1) Select mask and hose.

NOTE

The hose provided for the pilot is of a higher flow rate than those for the passengers; it is color-coded with an orange band adjacent to the plug-in fitting. The passenger hoses are color-coded with a green band. If the aircraft owner prefers, he may provide higher flow hoses for all passengers. In any case, it is recommended that the pilot use the larger capacity hose. The pilot's mask is equipped with a microphone to facilitate use of the radio while using oxygen. An adapter cord is furnished with the microphone-equipped mask to mate the mask microphone lead to the auxiliary microphone jack located under the left side of the instrument panel. To connect the oxygen mask microphone, connect the mask lead to the adapter cord and plug the cord into the auxiliary microphone jack. (If an optional microphone-headset combination has been in use, the microphone lead from this equipment is already plugged into the auxiliary microphone jack. It will be necessary to disconnect this lead from the auxiliary microphone jack so that the adapter cord from the oxygen mask microphone can be plugged into the jack.) A switch is incorporated on the left hand control wheel to operate the microphone.

- (2) Attach mask to face and adjust metallic nose strap for snug mask fit.
- (3) Select oxygen outlet located nearest to the seat you are occupying, and plug delivery hose into it. When the oxygen supply is turned on, oxygen will flow continuously at the proper rate of flow for any altitude without any manual adjustments.
- (4) Position oxygen supply control knob ON.
- (5) Check the flow indicator in the face mask hose. Oxygen is flowing if the indicator is being forced toward the mask.
- (6) Unplug the delivery hose from the outlet coupling when discontinuing use of the oxygen system. This automatically stops flow of oxygen.
- (7) Position oxygen supply control knob OFF.

OXYGEN DURATION CALCULATION.

The Oxygen Duration Chart (figure 7-2) should be used in determining the usable duration (in hours) of the oxygen supply in your airplane. The following procedure outlines the method of finding the duration from the chart.

- (1) Note the available oxygen pressure shown on the pressure gage.
- (2) Locate this pressure on the scale on the left side of the chart, then go across the chart horizontally to the right until you intersect the line representing the number of persons making the flight. After intersecting the line, drop down vertically to the bottom of the chart and read the duration in hours given on the scale.
- (3) As an example of the above procedure, 1400 psi of pressure will safely sustain the pilot only for nearly 6 hours and 15 minutes. The same pressure will sustain the pilot and three passengers for approximately 2 hours and 30 minutes.

NOTE

The Oxygen Duration Chart is based on a standard configuration oxygen system having one orange color-coded hose assembly for the pilot and green color-coded hoses for the passengers. If orange color-coded hoses are provided for pilot and passengers, it will be necessary to compute new oxygen duration figures due to the greater consumption of oxygen with these hoses. This is accomplished by computing the total duration available to the pilot only (from PILOT ONLY line on chart), then dividing this duration by the number of persons (pilot and passengers) using oxygen.

OXYGEN SYSTEM SERVICING.

The oxygen cylinder, when fully charged, contains approximately 48 cubic feet of oxygen, under a pressure of 1800 psi at 70° F. Filling pressures will vary, however, due to the ambient temperature in the filling area, and because of the temperature rise resulting from compression of the oxygen. Because of this, merely filling to 1800 psi will not result in a properly filled cylinder. Fill to the pressures indicated in the table on the following page for ambient temperature.

IMPORTANT

Oil, grease, or other lubricants in contact with oxygen create a serious fire hazard, and such contact must be avoided when handling oxygen equipment.

AMBIENT TEMPERATURE °F	FILLING PRESSURE PSIG	AMBIENT TEMPERATURE °F	FILLING PRESSURE PSIG
0	1600	50	1825
10	1650	60	1875
20	1700	70	1925
30	1725	80	1975
40	1775	90	2000

TRUE AIRSPEED INDICATOR

A true airspeed indicator is available to replace the standard airspeed indicator in your airplane. The true airspeed indicator has a calibrated rotatable ring which works in conjunction with the airspeed indicator dial in a manner similar to the operation of a flight computer.

TO OBTAIN TRUE AIRSPEED, rotate ring until pressure altitude is aligned with outside air temperature in degrees Fahrenheit. Then read true airspeed on rotatable ring opposite airspeed needle.

NOTE

Pressure altitude should not be confused with indicated altitude. To obtain pressure altitude, set barometric scale on altimeter to 29.92 and read pressure altitude on altimeter. Be sure to return altimeter barometric scale to original barometric setting after pressure altitude has been obtained.

CESSNA ECONOMY MIXTURE INDICATOR

The Cessna Economy Mixture Indicator is an exhaust gas temperature (EGT) sensing device which visually aids the pilot in adjusting the cruise mixture. Exhaust gas temperature varies with fuel-to-air ratio, power and RPM. However, the difference between the peak EGT and the EGT at the cruise mixture setting is essentially constant and this provides a useful leaning aid. Operating instructions are included in Section II.

CARBURETOR AIR TEMPERATURE GAGE

A carburetor air temperature gage may be installed in the aircraft to help detect carburetor icing conditions. The gage is marked with a yellow arc between -15° and $+5^{\circ}\text{C}$. The yellow arc indicates the carburetor temperature range where carburetor icing can occur; a placard on the gage reads KEEP NEEDLE OUT OF YELLOW ARC DURING POSSIBLE ICING CONDITIONS.

Visible moisture or high humidity can cause carburetor ice formation, especially in idle or low power conditions. Under cruising conditions, the formation of ice is usually slow, providing time to detect the loss of manifold pressure caused by the ice. Carburetor icing during take-off is rare since the full-open throttle condition is less susceptible to ice obstruction.

If the carburetor air temperature gage needle moves into the yellow arc during potential carburetor icing conditions, or there is an unexplained drop in manifold pressure, apply full carburetor heat. Upon regaining the original manifold pressure (with heat off), determine by trial and error the minimum amount of carburetor heat required for ice-free operation.

NOTE

Carburetor heat should not be applied during take-off unless absolutely necessary to obtain smooth engine acceleration (usually in sub-zero temperatures).

OIL QUICK-DRAIN VALVE

An oil quick-drain valve is optionally offered to replace the drain plug in the oil sump drain port. The valve provides a quicker and cleaner method of draining engine oil. To drain the oil with this valve installed, slip a hose over the end of the valve and route the hose to a suitable container, then push upward on the end of the valve until it snaps into the open position. Spring clips will hold the valve open. After draining, use a screwdriver or suitable tool to snap the valve into the extended (closed) position and remove the drain hose.

ALPHABETICAL INDEX

A

After Landing, 1-7
Aircraft,
 file, 5-5
 mooring, 5-1
 securing, 1-7
Airspeed Correction Table, 6-1
Airspeed Indicator, True, 7-10
Airspeed Indicator Markings, 4-2
Airspeed Limitations, 4-2
Alternate Source Valve, Static
 Pressure, 7-2
Aluminum Surfaces, 5-2
Ammeter, 2-5
Authorized Operations, 4-1

B

Baggage and Cargo Tie-Down, 4-4
Balked Landing, 1-6, 2-17
Before Landing, 1-6
Before Starting Engine, 1-4
Before Take-Off, 1-4, 2-12
 alternator check, 2-12
 magneto check, 2-12
 warm-up, 2-12

C

Cabin Heating, Ventilating and
 Defrosting System, 2-8
Capacity,
 fuel, inside back cover
 oil, inside back cover
Carburetor Air Temperature Gage,
 4-3, 7-11

Care,
 interior, 5-4
 propeller, 5-3
Cargo and Baggage Tie-Down, 4-4
Center of Gravity Moment
 Envelope, 4-8
Cessna Customer Care Program,
 5-7
Cessna Progressive Care, 5-7
Circuit Breakers and Fuses, 2-6
Climb,
 enroute, 1-5, 2-14
 maximum rate-of-climb
 data chart, 6-3
 maximum performance, 1-6
 normal, 1-5
Cold Weather Equipment, 7-1
 ground service plug
 receptacle, 7-1
 non-congealing oil cooler, 7-1
 static pressure alternate
 source valve, 7-2
 winterization kit, 7-1
Cold Weather Operation, 2-17
 operation, 2-20
 starting, 2-17
Correction Table, Airspeed, 6-1
Crosswind Landing, 2-17
Cruise, 1-6, 2-14
 leaning with EGT, 2-16
Cruise Performance Chart, 2-15,
 6-4, 6-5, 6-6, 6-7, 6-8
Cylinder Head Temperature Gage,
 4-3

D

Diagram,
 electrical system, 2-4

- exterior inspection, 1-2
- fuel system, 2-2
- instrument panel, 1-8
- loading arrangements, 4-5
- maximum glide, 6-10
- principal dimensions, ii
- radio selector switches, 7-4
- taxiing, 2-11
- Dimensions, Principal, ii
- Disorientation in Clouds, 3-5
 - emergency let-downs through clouds, 3-5
 - executing 180° turn in clouds, 3-5
 - recovery from spiral dive, 3-6
- Ditching, 3-3

E

- Economy Mixture Indicator, 2-16, 7-11
- Electrical Power Supply System
 - Malfunctions, 3-8
 - excessive rate of charge, 3-9
 - insufficient rate of charge, 3-9
- Electrical System, 2-3
 - ammeter, 2-5
 - circuit breakers and fuses, 2-6
 - ground service plug receptacle, 7-1
 - master switch, 2-3
 - over-voltage sensor and warning light, 2-5
 - schematic, 2-4
- Emergency Landing Without Engine Power, 3-2
- Emergency Let-Downs Through Clouds, 3-3
- Emergency Locator Transmitter (ELT), 3-9
 - ELT operation, 3-11
- Empty Weight, inside front cover

Index-2

- Engine,
 - before starting, 1-4
 - instrument markings, 4-2
 - oil, inside back cover
 - operation limitations, 4-2
 - starting, 1-4, 2-10
- Engine Failure,
 - after take-off, 3-1
 - during flight, 3-1
- Enroute Climb, 1-5, 2-14
 - maximum performance, 1-6
 - normal, 1-5
- Equipment, Cold Weather, 7-1
- Excessive Rate of Electrical Charge, 3-9
- Executing 180° Turn in Clouds, 3-5
- Exterior Inspection Diagram, 1-2
- Exterior Lighting, 2-6

F

- File, Aircraft, 5-5
- Fires, 3-3
 - electrical fire in flight, 3-4
 - engine fire during start on ground, 3-3
 - engine fire in flight, 3-4
- Flight in Icing Conditions, 3-6
- Flyable Storage, 5-5
- Forced Landings, 3-2
 - ditching, 3-3
 - emergency landing without engine power, 3-6
 - precautionary landing with engine power, 3-2
- Fuel System, 2-1
 - capacity, inside back cover
 - fuel grade, inside back cover
 - fuel quantity indicators, 4-3
 - long range fuel tanks, 2-3
 - schematic, 2-2
 - tank sump quick-drain valves, 2-3

Fuses and Circuit Breakers, 2-6

G

Graph, Loading, 4-7

Gross Weight, inside front cover

Ground Handling, 5-1

Ground Service Plug Receptacle,
7-1

H

Handling, Ground, 5-1

Harnesses, Shoulder, 2-9, 2-10

Headset-Microphone, 7-5

Heating, Ventilating and Defrosting
System, Cabin, 2-8

Hot Weather Operation, 2-21

I

Indicator, Fuel Quantity, 4-3

Indicator, True Airspeed, 7-10

Inspection Requirements, 5-6

Instrument Markings, Engine,
4-2

Instrument Panel Diagram, 1-8

Insufficient Rate of Electrical
Charge, 3-9

Integrated Seat Belt/Shoulder Har-
nesses With Inertia Reels, 2-10

Interior Care, 5-4

Interior Lighting, 2-7

L

Landing, 2-17

after, 1-7

balked, 1-6, 2-17

before, 1-6

crosswind, 2-17

distance table, 6-9

forced, 3-1

normal, 1-7, 2-17

precautionary with power, 3-2

short field, 2-17

Landing Gear Servicing, inside
back cover

main/nose wheel tire pressure,

inside back cover

nose gear shock strut servicing,

inside back cover

Let-Down, 1-6

Lighting Equipment, 2-6

exterior lighting, 2-6

interior lighting, 2-7

Limitations, Airspeed, 4-2

Limitations, Engine Operation,
4-2

Loading Arrangements Diagram, 4-5

Loading Graph, 4-7

Loading Problem, Sample, 4-6

Long Range Fuel Tanks, 2-3

Low Oil Pressure, 3-8

M

MAA Plate/Finish Trim Plate, 5-4

Magneto Malfunction, 3-8

Maneuvers - Normal Category, 4-1

Manifold Pressure Gage, 4-3

Markings, Airspeed Indicator, 4-2

Markings, Engine Instrument, 4-2

Master Switch, 2-3

Maximum Glide Diagram, 6-10

Maximum Performance Climb, 1-6

Maximum Performance Take-Off,
1-5

Maximum Rate-Of-Climb Data
Chart, 6-3

Microphone-Headset, 7-5

Moment Envelope, Center of
Gravity, 4-8

Mooring Your Airplane, 5-1

N

Noise Abatement, 2-21
Non-Congeaing Oil Cooler, 7-1
Normal Category Maneuvers, 4-1
Normal Climb, 1-5
Normal Landing, 1-7
Normal Take-Off, 1-5
Nose Gear Shock Strut, inside back cover

O

Oil System,
 capacity, inside back cover
 oil cooler, non-congealing, 7-1
 oil/filter change, inside back cover
 oil grade, inside back cover
 pressure gage, 4-3
 quick-drain valve, 7-12
 temperature gage, 4-2
Operation, Cold Weather, 2-17
Operation, Hot Weather, 2-21
Operation Limitations, Engine, 4-2
Operations Authorized, 4-1
Over-Voltage Sensor and Warning Light, 2-5
Owner Follow-Up System, 5-8
 publications, 5-9
Oxygen System, 7-6
 duration calculation, 7-9
 duration chart, 7-7
 operation, 7-6
 servicing, 7-9, inside back cover

P

Painted Surfaces, 5-3

Index-4

Performance - Specifications,
 inside front cover
Precautionary Landing With Engine Power, 3-2
Principal Dimensions Diagram, ii
Progressive Care, Cessna, 5-7
Propeller,
 care, 5-3
Publications, 5-9

Q

Quick-Drain Valve, Oil, 7-12

R

Radio Selector Switches, 7-4
 diagram, 7-4
 operation, 7-4
 speaker-phone switches, 7-5
 transmitter selector switches, 7-4
Recovery From Spiral Dive, 3-6
Rough Engine Operation or Loss of Power, 3-7
 carburetor icing, 3-7
 low oil pressure, 3-8
 magneto malfunction, 3-8
 spark plug fouling, 3-7

S

Sample Loading Problem, 4-6
Securing Aircraft, 1-7
Servicing Requirements, 5-8,
 inside back cover
 engine oil, inside back cover
 fuel, inside back cover
 landing gear, inside back cover
Short Field Landing, 2-17
Shoulder Harnesses, 2-9, 2-10

- Spark Plug Fouling, 3-7
- Speaker-Phone Switches, 7-5
- Spins, 3-6
- Stalls, 2-17
 - speed chart, 6-2
- Starting Engine, 1-4, 2-10
- Static Dischargers, 7-3
- Static Pressure Alternate Source Valve, 7-2
- Storage, Flyable, 5-5
- Suction Gage, 4-3
- Surfaces,
 - aluminum, 5-2
 - painted, 5-3
- System,
 - cabin heating, ventilating and defrosting, 2-8
 - electrical, 2-3
 - fuel, 2-1
 - owner follow-up, 5-8
 - oxygen, 7-6

T

- Table of Contents, iii
- Tachometer, 4-3

- Take-Off, 1-5, 2-13
 - before, 1-4, 2-12
 - data chart, 6-3
 - maximum performance, 1-5
 - normal, 1-5
- Taxiing, 2-12
- Tire Pressure, inside back cover
- Transmitter Selector Switches, 7-4
- True Airspeed Indicator, 7-10

W

- Weight
 - empty, inside front cover
 - gross, inside front cover
- Weight and Balance, 4-3
 - baggage and cargo tie-down, 4-4
 - center of gravity moment envelope, 4-8
 - loading arrangements diagram, 4-5
 - loading graph, 4-7
 - sample loading problem, 4-6
- Windshield - Windows, 5-2
- Winterization Kit, 7-1

SERVICING REQUIREMENTS *

ENGINE OIL:

GRADE -- Aviation Grade SAE 50 Above 40° F.

Aviation Grade SAE 10W30 or SAE 30 Below 40° F.

Multi-viscosity oil with a range of SAE 10W30 is recommended for improved starting in cold weather. Ashless dispersant oil, conforming to Continental Motors Specification MHS-24A, must be used.

NOTE

Your Cessna was delivered from the factory with a corrosion preventive aircraft engine oil. If oil must be added during the first 25 hours, use only aviation grade straight mineral oil conforming to Specification No. MIL-L-6082.

CAPACITY OF ENGINE SUMP -- 12 Quarts.

Do not operate on less than 9 quarts. To minimize loss of oil through breather, fill to 10 quart level for normal flights of less than 3 hours. For extended flight, fill to 12 quarts. These quantities refer to oil dipstick level readings. During oil and oil filter changes, one additional quart is required when the filter element is changed.

OIL AND OIL FILTER CHANGE --

After the first 25 hours of operation, drain engine oil sump and clean the oil pressure screen. If an optional oil filter is installed, change filter element at this time. Refill sump with straight mineral oil and use until a total of 50 hours has accumulated or oil consumption has stabilized; then change to dispersant oil. On aircraft not equipped with an optional oil filter, drain the engine oil sump and clean the oil pressure screen each 50 hours thereafter. On aircraft which have an optional oil filter, the oil change interval may be extended to 100-hour intervals, providing the oil filter element is changed at 50-hour intervals. Change engine oil at least every 6 months even though less than the recommended hours have accumulated. Reduce intervals for prolonged operation in dusty areas, cold climates, or when short flights and long idle periods result in sludging conditions.

SERVICING REQUIREMENTS*

FUEL:

GRADE -- 80/87 Minimum Grade Aviation Fuel

Alternate fuels which are also approved are:

100/130 Low Lead AVGAS (maximum lead content of 2 cc per gallon)

100/130 Aviation Grade Fuel (maximum lead content of 4.6 cc per gallon)

NOTE

When substituting a higher octane fuel, low lead AVGAS 100 should be used whenever possible since it will result in less lead contamination of the engine.

CAPACITY EACH STANDARD TANK -- 32.5 Gallons.

CAPACITY EACH LONG RANGE TANK -- 42.0 Gallons.

NOTE

To ensure maximum fuel capacity during refueling, place the fuel selector valve handle in either LEFT or RIGHT position to prevent cross-feeding.

LANDING GEAR:

NOSE WHEEL TIRE PRESSURE -- 49 PSI on 5.00-5, 6-Ply Rated Tire.

MAIN WHEEL TIRE PRESSURE -- 42 PSI on 6.00-6, 6-Ply Rated Tires.

NOSE GEAR SHOCK STRUT--

Keep filled with MIL-H-5606 hydraulic fluid and inflated with air to 55-60 PSI.

OXYGEN:

AVIATOR'S BREATHING OXYGEN -- Spec. No. MIL-O-27210

MAXIMUM PRESSURE (cylinder temperature stabilized after filling)--

1800 PSI at 70° F. Refer to page 7-10 for filling pressures.

* For complete servicing requirements,
refer to the aircraft Service Manual.

CESSNA



CESSNA AIRCRAFT COMPANY

WICHITA, KANSAS