



# Piper Seminole

## PA-44-180

### 1979 & 1980 Models

**Note:** At the time of issuance, this manual was an exact duplicate of the FAA-Approved Pilot's Operating Handbook, Airplane Flight Manual, or Owner's Manual. Use for training and familiarization purposes only. It will not be kept current and cannot be used as a substitute for the FAA-Approved POH / AFM / Owner's Manual required for operation of the airplane.

# **SEMINOLE INFORMATION MANUAL**

**Seminole**

**PA-44-180**

**HANDBOOK PART NO 761 662**

Published by  
**PUBLICATIONS DEPARTMENT**  
Piper Aircraft Corporation  
Issued: March 23, 1978

**REPORT: VB-860**

## APPLICABILITY

Application of this handbook is limited to the specific Piper PA-44-180 model airplane designated by serial number and registration number on the face of the title page of this handbook.

This handbook cannot be used for operational purposes unless kept in a current status.

## REVISIONS

The information compiled in the Pilot's Operating Handbook will be kept current by revisions distributed to the airplane owners.

Revision material will consist of information necessary to update the text of the present handbook and/or to add information to cover added airplane equipment.

### I. Revisions

Revisions will be distributed whenever necessary as complete page replacements or additions and shall be inserted into the handbook in accordance with the instructions given below:

1. Revision pages will replace only pages with the same page number.
2. Insert all additional pages in proper numerical order within each section.
3. Page numbers followed by a small letter shall be inserted in direct sequence with the same common numbered page.

### II. Identification of Revised Material

Revised text and illustrations shall be indicated by a black vertical line along the outside margin of the page, opposite revised, added or deleted material. A line along the outside margin of the page opposite the page number will indicate that an entire page was added



Black lines will indicate only current revisions with changes and additions to or deletions of existing text and illustrations. Changes in capitalization, spelling, punctuation or the physical location of material on a page will not be identified.

### ORIGINAL PAGES ISSUED

The original pages issued for this handbook prior to revision are given below:

Title, ii through vii, 1-1 through 1-21, 2-1 through 2-10, 3-1 through 3-21, 4-1 through 4-27, 5-1 through 5-33, 6-1 through 6-50, 7-1 through 7-34, 8-1 through 8-17, 9-1 through 9-22, and 10-1 through 10-3.

## PILOT'S OPERATING HANDBOOK LOG OF REVISIONS

Current Revisions to the PA-44-180 Seminole Pilot's Operating Handbook,  
REPORT: VB-860 issued March 23, 1978.

Revision Number and Code	Revised Pages	Description of Revision	FAA Approval Signature and Date
Rev. 1 761 662 (PR781215)	1-3	Revised para. 1.5; relocated info. to pg. 1-4.	
	1-4	Added info. from pg. 1-3; relocated info. to pg. 1-5.	
	1-5	Added info. from pg. 1-4.	
	1-8	Revised para. 1.19.	
	1-18	Revised para. 1.21	
	2-3	Revised para. 2.7.	
	2-4	Revised para. 2.7.	
	2-6	Revised para. 2.23.	
	3-i	Revised para. 3.7.	
	3-2	Revised para. 3.3.	
	3-3	Revised para. 3.3; added Warning from pg. 3-4.	
	3-4	Revised para. 3.3; relocated Warning to pg. 3-3; added info. from pg. 3-5.	
	3-5	Relocated info. to pg. 3-4; added info. from pg. 3-6.	
	3-6	Relocated info. to pg. 3-5; added info. from pg. 3-7.	
3-7	Relocated info. to pg. 3-6; added info. from pg. 3-8.		
3-8	Relocated info. to pg. 3-7; added info. from pg. 3-9.		
3-9	Relocated info. to pg. 3-8; added info. from pg. 3-10		
3-10	Relocated info. to pg. 3-9		
3-11	Revised para. 3.7.		
3-12	Revised para. 3.7; relocated info. to pg. 3-13.		

## PILOT'S OPERATING HANDBOOK LOG OF REVISIONS (cont)

Revision Number and Code	Revised Pages	Description of Revision	FAA Approval Signature and Date
Rev. 1 (cont)	3-13	Added info. from pg. 3-12; revised para. 3.7; added info. from pg. 3-14.	
	3-14	Relocated info. to pg. 3-13; revised para. 3.7; relocated info. to pg. 3-15.	
	3-15	Added info. from pg. 3-14.	
	4-i	Added para. 4.16; revised pg. nos.	
	4-1	Revised para. 4.1; relocated info. to pg. 4-2.	
	4-2	Added info. from pg. 4-1; revised para. 4.3.	
	4-6	Added info. to para. 4.5; relocated info. to pg. 4-7.	
	4-7	Added info. from pg. 4-6; relocated info. to pg. 4-8.	
	4-8	Added info. from pg. 4-7; relocated info. to pg. 4-9.	
	4-9	Added info. from pg. 4-8; relocated info. to pg. 4-10.	
	4-10	Added info. from pg. 4-9; relocated info. to pg. 4-11.	
	4-11	Added info. from pg. 4-10; relocated info. to pg. 4-12.	
	4-12	Added info. from pg. 4-11; relocated info. to pg. 4-12a.	
	4-12a	Added pg. (added info. from pg. 4-12).	
	4-12b	Added pg. (added info. from pg. 4-13).	
	4-13	Relocated info. to pg. 4-12b; added info. from pg. 4-14.	

## PILOT'S OPERATING HANDBOOK LOG OF REVISIONS (cont)

Revision Number and Code	Revised Pages	Description of Revision	FAA Approval Signature and Date
Rev. 1 (cont)	4-14	Relocated info. to pg. 4-13, added info. from pg. 4-15; added para. 4.16.	
	4-15	Relocated info. to pg. 4-14; added info. from pg. 4-16.	
	4-16	Relocated info. to pg. 4-15.	
	4-26	Revised para. 4.51.	
	5-1	Revised para. 5.1; relocated info. to pg. 5-2.	
	5-2	Added info. from pg. 5-1.	
	5-6	Revised para. 5.5.	
	5-7	Revised para. 5.5.	
	5-22	Revised Fig. 5-23.	
	5-26	Revised Fig. 5-31.	
	5-27	Revised Fig. 5-33.	
	5-28	Revised Fig. 5-35.	
	5-31	Revised Fig. 5-41.	
	6-i	Revised para. 6.11.	
	6-15	Revised para. 6.9.	
	6-18	Revised item 1 and removed lines.	
	6-19	Removed lines.	
	6-21	Removed lines.	
	6-22	Revised item 53; removed lines.	
	6-23	Revised item 71; removed lines.	
6-24	Revised item 77; removed lines.		
6-25	Revised item 91; removed lines.		

**PILOT'S OPERATING HANDBOOK LOG OF REVISIONS (cont)**

Revision Number and Code	Revised Pages	Description of Revision	FAA Approval Signature and Date
Rev. 1 (cont)	6-26	Added para. 6.11 (g) from pg. 6-27;	
	6-27	added new item 113. Revised para. 6.11 (h) to 6.11 (g) and relocated to pg. 6-26; revised para. 6.11 (g) to 6.11 (h); renumbered existing items 113 and 115 to 121 and 123; added new items 115 and 117.	
	6-31	Revised item 165.	
	6-33	Revised items 173 and 175.	
	6-34	Added item 176; relocated item 187 to pg. 6-35.	
	6-35	Added item 187 from pg. 6-34.	
	6-37	Added new item 212; relocated item 219 to pg. 6-38.	
	6-38	Added item 219 from pg. 6-37.	
	6-39	Revised item 231.	
	6-45	Revised item 281.	
	6-46	Added new item 282; relocated item 289 to pg. 6-47.	
	6-47	Added item 289 from pg. 6-46.	
	6-48	Deleted item 353; revised items 355 and 361.	
	7-i	Added para. 7.39.	
	7-10	Revised Fig. 7-7.	
	7-14	Revised para. 7.15.	
	7-35	Added pg. (added para. 7.39).	
8-10	Revised para. 8.17.		

*Ward Evans*  
 Ward Evans  
 Dec. 15, 1978

## PILOT'S OPERATING HANDBOOK LOG OF REVISIONS (cont)

Revision Number and Code	Revised Pages	Description of Revision	FAA Approval Signature and Date
Rev. 2 761 662 (PR790413)	6-46	Revised item 283; added item 284; relocated item 287 to pg 6-47.	<i>Ward Evans</i> Ward Evans April 13, 1979
	6-47	Added item 287 from pg. 6-46.	
	7-i	Revised para. 7.37 & 7.39 pg. nos.	
	7-33	Revised para. 7.35.	
	7-34	Revised para. 7.35; relocated para. 7.37 to pg. 7-36.	
	7-35	Added para. 7.35 info.; re-located para. 7.39 to pg. 7-36.	
	7-36	Added pg. (added para. 7.37 from pg. 7-34 & para. 7.39 from pg. 7-35).	
	1-9	Added Demo. X-Wind.	
2-2	Revised para. 2.3.		
2-7, 2-8,	Revised para. 2.27.		
2-9, 2-10			
3-6	Added info.		
3-7	Replaced abbreviations with words.		
3-8	Added word to title.		
3-13	Revised procedure.		
3-18	Revised para. 3.15.		
4-6	Revised Caution.		
4-11	Added info. from pg. 4-12.		
4-12	Relocated info. to pg. 4-11.		
5-2	Added Warning.		
5-3, 5-5,	Revised para. 5.5 (a), (c), (d),		
5-6, 5-7	(e), (f) and (g).		
5-9	Revised List of Figures.		
5-15	Revised Fig. 5-9.		

**PILOT'S OPERATING HANDBOOK LOG OF REVISIONS (cont)**

Revision Number and Code	Revised Pages	Description of Revision	FAA Approval Signature and Date
Rev. 3 (cont)	5-24 thru 5-31	Revised Figs. 5-27 thru 5-41.	
	6-1, 6-2	Revised para. 6.1.	
	6-3	Added Caution. Moved info. to pg. 6-4.	
	6-4	Relocated info. from pg. 6-3. Moved info. to pg. 6-5.	
	6-5	Relocated info. from pg. 6-4.	
	6-18	Revised items 1, 3 and 5.	
	6-24	Revised item 77.	
	6-26	Revised item 113.	
	6-27	Revised items 115 and 121.	
	6-30	Relocated item 159 from pg. 6-31.	
	6-31	Relocated item 159 to pg. 6-30; added item 167 from pg. 6-32.	
	6-32	Added item 170.	
	6-34	Added item 178.	
	6-35	Revised items 191 and 193.	
	6-36	Added item 206; revised item 207; relocated item 209.	
	6-37	Revised, relocated item 209 from pg. 6-36; changed item 213 to 214; added new 213; relocated items 215 and 217 to pg. 6-38.	
	6-38	Changed item 215 to 216, relocated from pg. 6-37; added new 216; relocated item 217 from pg. 6-37; relocated items 221 and 223 to pg. 6-39.	
	6-39	Relocated items 221 and 223 from pg. 6-38; added item 224; relocated items 225 thru 235 to pg. 6-40.	

**PILOT'S OPERATING HANDBOOK LOG OF REVISIONS (cont)**

Revision Number and Code	Revised Pages	Description of Revision	FAA Approval Signature and Date
Rev. 3 (cont)	6-40	Relocated items 225 thru 235 from pg. 6-39; added items 230 and 234; relocated items 237 thru 243 to pg. 6-41.	<p align="center"><i>Ward Evans</i> Ward Evans Sept. 14, 1979</p>
	6-41	Relocated items 237 thru 243 from pg. 6-40; added item 242; relocated items 245 thru 251 to pg. 6-41a.	
	6-41a	New page; relocated items 245 thru 251 from pg. 6-41.	
	6-41b	New page.	
	6-47	Revised item 291.	
	6-48	Revised item 355.	
	7-9	Revised para. 7.9.	
	7-11	Revised Figure 7-9.	
	7-25	Revised para. 7.23.	
	7-26	Revised Figure 7-25.	
	7-28	Revised Figure 7-27.	
	10-2	Revised para. 10.3 (h).	
Rev. 4 761 662 (PR800301)	1-2	Revised Figure 1-1.	
	1-4	Revised para. 1.7, 1.9 and 1.11.	
	2-3	Revised para. 2.7	
	2-4	Revised para. 2.11.	
	2-5	Revised para. 2.13.	
	2-6	Revised para. 2.23.	
	2-10	Added serial number effectivity	
	3-ii	Added para. 3.37.	
	3-21	Added para. 3.37.	
	3-22	New page, contin. para. 3.37.	
	5-23	Revised Figure 5-25.	
	5-24	Revised Figure 5-27.	
	5-32	Revised Figure 5-43.	
	6-9	Moved revised Figure 6-9 to pg. 6-10.	



**PILOT'S OPERATING HANDBOOK LOG OF REVISIONS (cont)**

Revision Number and Code	Revised Pages	Description of Revision	FAA Approval Signature and Date
Rev. 4 (cont)	6-10	Added revised Figure 6-9; moved revised Figure 6-11 to pg. 6-10a.	
	6-10a	New page; added revised Figure 6-11.	
	6-10b	New page.	
	6-12	Revised Figure 6-15.	
	6-15	Revised sample problem.	
	6-28	Added item 125.	
	6-41	Added items 238 & 240; moved items 241, 242 and 243 to pg. 6-41a.	
	6-41a	Relocated items 241, 242, 243; moved items 249 and 251 to pg. 6-41b.	
	6-41b	Relocated items 249 and 251.	
	7-i	Added para. 7.41.	
	7-3	Revised Figure 7-1.	
	7-4	Revised Figure 7-3.	
	7-26	Revised Figure 7-25.	
	7-27	Revised para 7.23	
	7-37	New page; added para. 7.41.	
	8-11	Revised para. 8.19, and para. 8-21.	
	8-11a	New page; cont. revised para. 8.21.	
	8-11b	New page; cont. revised para. 8.21	
	9-i	Added Supplements 4 and 5.	
	9-23	Added pages (Supplement 4).	
	thru		
	9-26		
	9-27	Added pages (Supplement 5).	
	thru		
	9-30		

*Ward Evans*  
Ward Evans  
March 1, 1980

## PILOT'S OPERATING HANDBOOK LOG OF REVISIONS (cont)

Revision Number and Code	Revised Pages	Description of Revision	FAA Approval Signature and Date
Rev. 5 761 662 (PR800926)	Title	Revised title pg.	
	Publ	Revised Warning.	
	2-9	Revised Takeoff and Landing checklists; relocated placard to pg 2-10.	
	2-10	Added placard from pg. 2-9.	
	4-9	Revised Before Takeoff checklist.	
	4-11	Revised Approach and Landing	
	4-18	Revised para. 4 27.	
	4-23	Revised para 4.37	
	5-5	Revised item 5.5 (c).	
	5-7	Revised items 5.5 (e), (f) and (g).	
	5-23	Revised Figure 5-25.	
	6-1	Revised pg nos.	
	6-4	Revised Figure 6-3.	
	6-6	Revised Figure 6-5.	
	6-22	Added items 59 and 61.	
	6-26	Added item 104; relocated item to pg. 6-26a.	
	6-26a	Added pg. (added items from pgs. 6-26 and 6-27).	
6-26b	Added pg		
6-27	Relocated items to pg. 6-26a, added item from pg. 6-28		
6-28	Relocated item to pg 6-27		
6-28a	Added pg.		
6-28b	Added pg. (added items from pg 6-29; added item 138; revised item no )		
6-29	Relocated items to pg. 6-28b; revised item no ; added items 142, 143 and 144		

**PILOT'S OPERATING HANDBOOK LOG OF REVISIONS (cont)**

Revision Number and Code	Revised Pages	Description of Revision	FAA Approval Signature and Date
Rev. 5 (cont)	6-35	Revised item no.	
	6-36	Relocated items to pg. 6-36d; added items 193 and 194.	
	6-36a,	Added pgs. (added items	
	6-36b,	200 thru 212).	
	6-36c	Added pg. (added renumbered	
	6-36d	items from pg. 6-36).	
	6-37,	Renumbered items.	
	6-38,	Renumbered items; added items	
	6-39	229 and 230; relocated items	
	6-40	to pg. 6-41.	
	6-41	Added items from pg. 6-40; re-	
	6-41a	numbered items; relocated item	
	6-41b	Added item from pg. 6-41; re-	
	6-42	numbered items; added	
	6-44	items 243 and 245; relocated	
6-45	items to pg. 6-41b. Added items		
6-48	from pg. 6-41a; renumbered		
6-49	item; relocated item to pg. 6-42.		
6-50	Added item from pg. 6-41b.		
6-48	Added item 277 from pg. 6-45.		
6-49	Relocated item to pg. 6-44; re-		
6-50	numbered item; added item		
6-50	281.		
6-50	Added item 353.		
6-50	Renumbered and relocated		
6-50	item to pg. 6-50; added new		
6-50	item 375.		
6-50	Renumbered items; relocated		
6-50	info. to pg. 6-51; added item		
6-50	from pg. 6-49; added new		
6-50	items 377 and 379.		

**PILOT'S OPERATING HANDBOOK LOG OF REVISIONS (cont)**

Revision Number and Code	Revised Pages	Description of Revision	FAA Approval Signature and Date
Rev 5(cont)	6-51  7-18 7-20 7-26 7-30, 7-31 8-9 9-i 9-31 thru 9-36 9-37 thru 9-40 9-41 thru 9-52 9-53, 9-54 9-55 thru 9-60 9-61 thru 9-66 9-67 thru 9-72 9-73 thru 9-76	Added pg (added info from pg 6-50). Revised Figure 7-17. Revised Figure 7-19. Revised Figure 7-25 Revised para. 7.27  Revised Figure 8-9 Added Supplements 6 thru 13 Added Supplement 6 (Air Conditioning)  Added Supplement 7 (Century 21 Autopilot)  Added Supplement 8 (Century 41 Autopilot)  Added Supplement 9 (Control Wheel Clock) Added Supplement 10 (WeatherScout II Radar)  Added Supplement 11 (RDR-160 Radar)  Added Supplement 12 (RDR-160/IN-2026A Radar)  Added Supplement 13 (Color WeatherScout II Radar)	<p align="right"><i>Ward Evans</i> Ward Evans Sept 26, 1980</p>
Rev 6 761 662 (PR801119)	2-3 2-4  2-5 6-24	Revised para 2 7 Revised para 2 9, moved para 2 11 to pg 2-5 Relocated para 2 11 from pg 2-4 Deleted items 79 and 81	<p align="right"><i>Ward Evans</i> Ward Evans Nov 19, 1980</p>

**PILOT'S OPERATING HANDBOOK LOG OF REVISIONS (cont)**

Revision Number and Codes	Revised Pages	Description of Revision	FAA Approval Signature and Date
Rev. 7 761 662 (PR810105)	2-4	Revised 2.9 (c).	
	3-i, iii	Changed page numbers.	
	3-5	Revised Air Start	
		(Unfeathering Procedure).	
	3-7	Revised Electrical Failures.	
	3-8	Moved info. to pg. 3-10a;	
		cont. Electrical Failure.	
	3-9	Moved info. to pg. 3-10b;	
		cont. Electrical Failure.	
	3-10	Cont. Electrical Failure.	
	3-10a	New page; relocated info.	
		from pg. 3-8.	
	3-10b	New page; relocated info.	
		from pg. 3-9.	
	3-13	Revised engine failure during	
		takeoff (75 KIAS and above).	
	3-15	Revised Air Start	
	(Unfeathering Procedure).		
3-16	Moved para. 3.11 to pg. 3-17;		
	cont. Air Start.		
3-17	Relocated para. 3.11 from		
	pg. 3-16.		
3-19	Revised para. 3.23.		
3-20	Moved para. 3.25 and para.		
	3.27 to pg. 3-22; cont. para.		
	3.23 revision.		
3-21	Moved para. 3.29, 3.31, 3.33		
	and 3.35 to pg. 3-23 and para.		
	3.35 and 3.37 to pg. 3-24;		
	cont. para. 3.23 revision.		
3-22	Relocated para. 3.25 from		
	pg. 3-20; moved part of para.		
	3.37 to pg. 3-24.		
3-23	New page; relocated para.		
	3.29, 3.31 and 3.35 from pg.		
	3-21.		

**PILOT'S OPERATING HANDBOOK LOG OF REVISIONS (cont)**

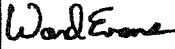
Revision Number and Codes	Revised Pages	Description of Revision	FAA Approval Signature and Date
Rev. 7 (cont)	3-24 6-34 6-35 6-36 7-16 7-17 7-19 7-21 9-77	New page; relocated para. 3.37 from pg. 3-21 and 3-22 Added item 180; moved item 185 to pg. 6-35. Relocated item 185 from pg 6-35; moved items 191 and 192 to pg. 6-36. Relocated items 191 and 192 from pg. 6-36. Revised para. 7.17. Revised Figure 7-15. Cont. para. 7.17 revision. Deleted info. Added info.	 Ward Evans Jan 5, 1981
Rev. 8 761 662 (PR810410)	3-3 3-13 4-i 4-18 4-19 5-23 6-25 6-26 6-34 6-39 thru 6-42 6-49	Revised Warning. Added Warning. Changed pg. no. for para. 4.27. Revised para. 4.27; moved para. 4.29 to pg. 4-19. Relocated para. 4.29 from pg. 4-18. Revised fig. 5-25. Revised items 99 and 101. Revised items 103 and 104. Revised item 178. Added new item 228; moved and renumbered items 228 thru 252; revised new item 244. Revised item 375.	

**PILOT'S OPERATING HANDBOOK LOG OF REVISIONS (cont)**

Revision Number and Codes	Revised Pages	Description of Revision	FAA Approval Signature and Date
Rev. 8 (cont)	6-50 7-17 7-20 9-25 9-41	Revised items 377 and 379. Revised fig. 7-15. Revised fig. 7-19. Revised Sec. 4 (b) (8) a and b. Revised Sec. 2 (c).	<i>Ward Evans</i> Ward Evans April 10, 1981
Rev. 9 761 662 (PR810724)	1-5 2-9 3-2 3-12 4-4 4-5 4-9 4-11 4-12b 4-13 4-14 4-15 4-17 4-18 4-19 4-20 4-23 4-24 4-25	Revised para. 1.13. Revised check list. Revised procedure. Revised procedure. Relocated info. from pg. 4-5. Moved info. to pg. 4-4; revised procedure. Revised procedure. Revised procedure. Revised Caution. Added Note; moved para. 4.15 to pg. 4-14. Relocated para. 4.15; moved info. to pg. 4-15. Relocated info. from pg. 4-14. Relocated info. from pg. 4-18. Moved info. to pg. 4-17; added Note; moved info. to pg. 4-19. Relocated info. from pg. 4-18; moved info. to pg. 4-20. Relocated info. from pg. 4-19. Revised para. 4.37; moved info. to 4-24. Relocated info. from pg. 4-23; moved info. to pg. 4-25. Relocated info. from pg. 4-24; moved para. 4.47 to pg. 4-26.	

**PILOT'S OPERATING HANDBOOK LOG OF REVISIONS (cont)**

Revision Number and Codes	Revised Pages	Description of Revision	FAA Approval Signature and Date
Rev. 9 (cont)	4-26	Relocated para. 4.47 from pg. 4-25; moved info to pg. 4-27.	
	4-27	Relocated info. from pg. 4-26.	
	5-3	Revised para. 5.5 (a) (6).	
	5-7	Revised para. 5.5 (e) (4) (6); (f) (1); (g) (1)	
	5-26	Revised fig. 5-31.	
	5-29	Revised fig. 5-37.	
	5-30	Revised fig. 5-39.	
	6-28b	Added item 136.	
	6-30	Moved item 159 to pg. 6-31	
	6-31	Relocated item 159; added item 164; moved item 165 and 167 to pg. 6-32.	
	6-32	Relocated items 165 and 167 from pg. 6-31; moved item 171 to pg. 6-33.	
	6-33	Relocated item 171 from pg. 6-32; moved item 175 to pg. 6-34.	
	6-34	Relocated item 175 from pg. 6-33; moved items 179 thru 183 to pg. 6-35.	
	6-35	Relocated items 179 thru 183 from pg. 6-34.	
	6-36	Revised item 194.	
	6-38	Renumbered items; moved renumbered items to pg. 6-38a.	
	6-38a	New page; added items 229 and 231; relocated renumbered item from pg. 6-38	
	6-38b	New page; relocated renumbered items from pg. 6-39.	



**PILOT'S OPERATING HANDBOOK LOG OF REVISIONS (cont)**

Revision Number and Codes	Revised Pages	Description of Revision	FAA Approval Signature and Date
Rev. 9 (cont)	6-39	Moved renumbered items to pg. 6-38b; relocated renumbered items from pg. 6-40; added item 247.	<p align="right"><i>Ward Evans</i> Ward Evans July 24, 1981</p>
	6-40	Moved renumbered items to pg. 6-39; relocated renumbered items from pg. 6-41.	
	6-41	Moved renumbered items to pg. 6-40; renumbered items.	
	6-41a	Revised item 273; renumbered items; relocated renumbered item from pg. 6-41b.	
	6-41b	Moved renumbered item to pg. 6-41a; renumbered items.	
	6-42 thru 6-47	Renumbered items.	
	6-51	Added item 389; removed info.	
	7-19	Revised para. 7.17; moved info. to pg. 7-21.	
	7-21	Relocated info. from pg. 7-19.	
Rev. 10 761 662 (PR820122)	1-i	Correct page numbers.	
	2-4	Revised para. 2.9; move info. to pg. 2-5.	
	2-5	Relocated info. from pg. 2-4; moved info. to pg. 2-6.	
	2-6	Relocated info. from pg. 2-5; moved info. to pg. 2-7.	
	2-7	Relocated info. from pg. 2-6; moved info. to pg. 2-8.	
	2-8	Relocated info. from pg. 2-7; moved info. to pg. 2-9.	
	2-9	Relocated info. from pg. 2-8.	
	3-10	Revised procedure.	





## **TABLE OF CONTENTS**

<b>SECTION 1</b>	<b>GENERAL</b>
<b>SECTION 2</b>	<b>LIMITATIONS</b>
<b>SECTION 3</b>	<b>EMERGENCY PROCEDURES</b>
<b>SECTION 4</b>	<b>NORMAL PROCEDURES</b>
<b>SECTION 5</b>	<b>PERFORMANCE</b>
<b>SECTION 6</b>	<b>WEIGHT AND BALANCE</b>
<b>SECTION 7</b>	<b>DESCRIPTION AND OPERATION OF THE AIRPLANE AND ITS SYSTEMS</b>
<b>SECTION 8</b>	<b>AIRPLANE HANDLING, SERVICING AND MAINTENANCE</b>
<b>SECTION 9</b>	<b>SUPPLEMENTS</b>
<b>SECTION 10</b>	<b>SAFETY TIPS</b>

[Faint, illegible text covering the majority of the page]

## TABLE OF CONTENTS

### SECTION 1

#### GENERAL

Paragraph No		Page No
1 1	Introduction .....	1-1
1 3	Engine .....	1-3
1 5	Propeller .....	1-3
1 7	Fuel .....	1-4
1 9	Oil .....	1-4
1 11	Maximum Weights .....	1-4
1.13	Standard Airplane Weights .....	1-5
1.15	Baggage Space .....	1-5
1 17	Specific Loadings .....	1-5
1.19	Symbols, Abbreviations and Terminology .....	1-6



**SECTION I  
GENERAL**

**1.1 INTRODUCTION**

This Pilot's Operating Handbook is designed for maximum utilization as an operating guide for the pilot. It includes the material required to be furnished to the pilot by the Federal Aviation Regulations and additional information provided by the manufacturer and constitutes the FAA Approved Airplane Flight Manual

This handbook is not designed as a substitute for adequate and competent flight instruction, knowledge of current airworthiness directives, applicable federal air regulations or advisory circulars. It is not intended to be a guide for basic flight instruction or a training manual and should not be used for operational purposes unless kept in a current status.

Assurance that the airplane is in an airworthy condition is the responsibility of the owner. The pilot in command is responsible for determining that the airplane is safe for flight. The pilot is also responsible for remaining within the operating limitations as outlined by instrument markings, placards, and this handbook.

Although the arrangement of this handbook is intended to increase its in-flight capabilities, it should not be used solely as an occasional operating reference. The pilot should study the entire handbook to become familiar with the limitations, performance, procedures and operational handling characteristics of the airplane before flight.

The handbook has been divided into numbered (arabic) sections, each provided with a "finger-tip" tab divider for quick reference. The limitations and emergency procedures have been placed ahead of the normal procedures, performance and other sections to provide easier access to information that may be required in flight. The "Emergency Procedures" Section has been furnished with a red tab divider to present an instant reference to the section. Provisions for expansion of the handbook have been made by the deliberate omission of certain paragraph numbers, figure numbers, item numbers and pages noted as being intentionally left blank.



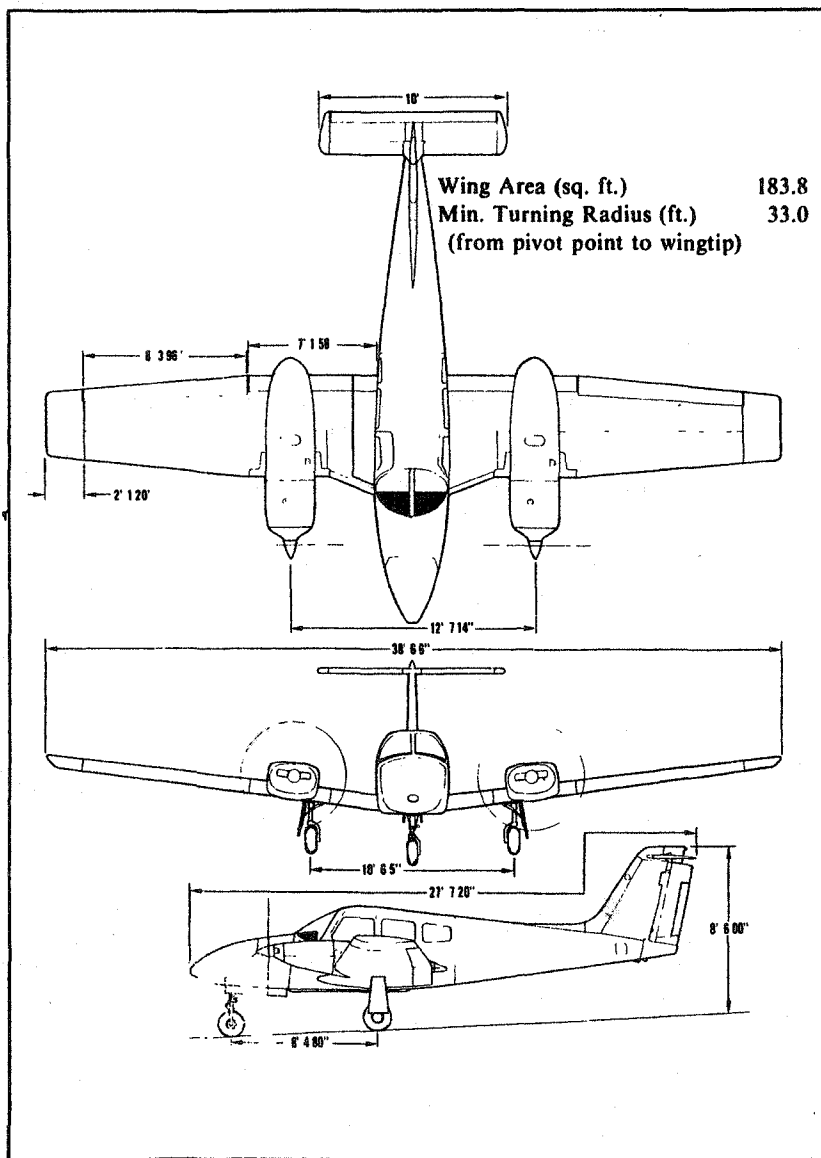

**THREE VIEW  
Figure 1-1**

### 1.3 ENGINE

(a) Number of Engines	2
(b) Engine Manufacturer	Lycoming
(c) Engine Model Number	
Left	O-360-E1A6D
Right	LO-360-E1A6D
(d) Rated Horsepower	180
(e) Rated Speed (rpm)	2700
(f) Bore (in.)	5.125
(g) Stroke (in.)	4.375
(h) Displacement (cu. in.)	361
(i) Compression Ratio	9.00:1
(j) Engine Type	Four Cylinder, Direct Drive, Horizontally Opposed, Air Cooled

### 1.5 PROPELLER

#### STANDARD

(a) Number of Propellers	2
(b) Propeller Manufacturer	Hartzell
(c) Model	
Left	HC-C2Y(K,R)-2CEUF/ FC7666A-2R
Right	HC-C2Y(K,R)-2CLEUF/ FJC7666A-2R
(d) Number of Blades	2
(e) Propeller Diameter (in.)	
(1) Maximum	74
(2) Minimum	72
(f) Propeller Type	Constant Speed, Hydraulically Actuated, Full Feathering

#### OPTIONAL

(a) Number of Propellers	2
(b) Propeller Manufacturer	Hartzell
(c) Model	
Left	HC-C3YR-2EUF/ FC-7663-5R
Right	HC-C3YR-2LEUF/ FJC-7663-5R

**SECTION 1  
GENERAL**

**PIPER AIRCRAFT CORPORATION  
PA-44-180, SEMINOLE**

(d) Number of Blades	3
(e) Propeller Diameter (in.)	
(1) Maximum	73
(2) Minimum	72
(f) Propeller Type	Constant Speed, Hydraulically Actuated, Full Feathering

**1.7 FUEL**

(a) Fuel Capacity (U.S. gal.) (total)	110
(b) Usable Fuel (U.S. gal.) (total)	108
(c) Fuel	
(1) Minimum Grade	100 Green or 100LL Blue Aviation Grade
(2) Alternate Fuel	Refer to latest revision of Lycoming, Service Instruction 1070.

**1.9 OIL**

(a) Oil Capacity (U.S. qts.) (per engine)	6
(b) Oil Specification	Refer to latest issue of Lycoming Service Instruction 1014 and Service Bulletin No. 446.
(c) Oil Viscosity	Refer to Section 8 - paragraph 8.19.

**1.11 MAXIMUM WEIGHTS**

(a) Maximum Takeoff Weight (lbs.)	3800
(b) Maximum Ramp Weight	3816
(c) Maximum Landing Weight (lbs.)	3800
(d) Maximum Weights in Baggage Compartment (lbs.)	200

**1.13 STANDARD AIRPLANE WEIGHTS**

Refer to Figure 6-5 for the Standard Empty Weight and the Useful Load.

**1.15 BAGGAGE SPACE**

(a) Compartment Volume (cu. ft.)	24
(b) Entry Width (in.)	22
(c) Entry Height(in.)	20

**1.17 SPECIFIC LOADINGS**

(a) Wing Loading (lbs. per sq. ft.)	21.1
(b) Power Loading (lbs. per hp)	10.55

### **1.19 SYMBOLS, ABBREVIATIONS AND TERMINOLOGY**

The following definitions are of symbols, abbreviations and terminology used throughout the handbook and those which may be of added operational significance to the pilot.

#### **(a) General Airspeed Terminology and Symbols**

<b>CAS</b>	Calibrated Airspeed means the indicated speed of an aircraft, corrected for position and instrument error. Calibrated airspeed is equal to true airspeed in standard atmosphere at sea level.
<b>KCAS</b>	Calibrated Airspeed expressed in "Knots."
<b>GS</b>	Ground Speed is the speed of an airplane relative to the ground.
<b>IAS</b>	Indicated Airspeed is the speed of an aircraft as shown on the airspeed indicator when corrected for instrument error. IAS values published in this handbook assume zero instrument error.
<b>KIAS</b>	Indicated Airspeed expressed in "Knots."
<b>M</b>	Mach Number is the ratio of true airspeed to the speed of sound.
<b>TAS</b>	True Airspeed is the airspeed of an airplane relative to undisturbed air which is the CAS corrected for altitude, temperature and compressibility.
<b>V<sub>A</sub></b>	Maneuvering Speed is the maximum speed at which application of full available aerodynamic control will not overstress the airplane.
<b>V<sub>FE</sub></b>	Maximum Flap Extended Speed is the highest speed permissible with wing flaps in a prescribed extended position.

VLE	Maximum Landing Gear Extended Speed is the maximum speed at which an aircraft can be safely flown with the landing gear extended.
VLO	Maximum Landing Gear Operating Speed is the maximum speed at which the landing gear can be safely extended or retracted.
VMCA	Air Minimum Control Speed is the minimum flight speed at which the airplane is directionally controllable as determined in accordance with Federal Aviation Regulations. Airplane certification conditions include one engine becoming inoperative and windmilling, not more than a 5° bank towards the operative engine, takeoff power on operative engine, landing gear up, flaps in takeoff position, and most rearward C.G.
VNE/MNE	Never Exceed Speed or Mach Number is the speed limit that may not be exceeded at any time.
VNO	Maximum Structural Cruising Speed is the speed that should not be exceeded except in smooth air and then only with caution.
VS	Stalling Speed or the minimum steady flight speed at which the airplane is controllable
VSO	Stalling Speed or the minimum steady flight speed at which the airplane is controllable in the landing configuration.
VSSE	Intentional One Engine Inoperative Speed is a minimum speed selected by the manufacturer for intentionally rendering one engine inoperative in flight for pilot training.

- VX** Best Angle-of-Climb Speed is the airspeed which delivers the greatest gain of altitude in the shortest possible horizontal distance.
- VY** Best Rate-of-Climb Speed is the airspeed which delivers the greatest gain in altitude in the shortest possible time.

**(b) Meteorological Terminology**

- ISA** International Standard Atmosphere in which the air is a dry perfect gas, the temperature at sea level is 15° Celsius (59° Fahrenheit), the pressure at sea level is 29.92 inches Hg (1013 mb), and the temperature gradient from sea level to the altitude at which the temperature is -56.5°C (-69.7°F) is -0.00198°C (-0.003566°F) per foot and zero above that altitude.
- OAT** Outside Air Temperature is the free air static temperature obtained either from inflight temperature indications or ground meteorological sources, adjusted for instrument error and compressibility effects.
- Indicated Pressure Altitude** The number actually read from an altimeter when the barometric subscale has been set to 29.92 inches of mercury (1013 millibars).
- Pressure Altitude** Altitude measured from standard sea-level pressure (29.92 in. Hg) by a pressure or barometric altimeter. It is the indicated pressure altitude corrected for position and instrument error. In this handbook, altimeter instrument errors are assumed to be zero.
- Station Pressure** Actual atmospheric pressure at field elevation.

- Wind                                  The wind velocities recorded as variables on the charts of this handbook are to be understood as the headwind or tailwind components of the reported winds
- (c) Power Terminology
- Takeoff Power                      Maximum power permissible for takeoff
- Maximum Continuous Power        Maximum power permissible continuously during flight
- Maximum Climb Power              Maximum power permissible during climb.
- Maximum Cruise Power             Maximum power permissible during cruise
- (d) Engine Instruments
- EGT Gauge                          Exhaust Gas Temperature Gauge
- (e) Airplane Performance and Flight Planning Terminology
- Climb Gradient                      The demonstrated ratio of the change in height during a portion of a climb, to the horizontal distance traversed in the same time interval
- Demonstrated Crosswind Velocity (DEMO X-WIND)                      The demonstrated crosswind velocity is the velocity of the crosswind component for which adequate control of the airplane during takeoff and landing was actually demonstrated during certification tests
- Accelerate-Stop Distance            The distance required to accelerate an airplane to a specified speed and, assuming failure of an engine at the instant that speed is attained, to bring the airplane to a stop



**Route Segment**            A part of a route. Each end of that part is identified by (1) a geographical location or (2) a point at which a definite radio fix can be established.

**(f) Weight and Balance Terminology**

**Reference Datum**        An imaginary vertical plane from which all horizontal distances are measured for balance purposes.

**Station**                 A location along the airplane fuselage usually given in terms of distance in inches from the reference datum.

**Arm**                      The horizontal distance from the reference datum to the center of gravity (C.G.) of an item.

**Moment**                 The product of the weight of an item multiplied by its arm. (Moment divided by a constant is used to simplify balance calculations by reducing the number of digits.)

**Center of Gravity (C.G.)**    The point at which an airplane would balance if suspended. Its distance from the reference datum is found by dividing the total moment by the total weight of the airplane.

**C.G. Arm**                 The arm obtained by adding the airplane's individual moments and dividing the sum by the total weight.

**C.G. Limits**             The extreme center of gravity locations within which the airplane must be operated at a given weight.

**Usable Fuel**             Fuel available for flight planning.

**Unusable Fuel**         Fuel remaining after a runout test has been completed in accordance with governmental regulations.

<b>Standard Empty Weight</b>	<b>Weight of a standard airplane including unusable fuel, full operating fluids and full oil.</b>
<b>Basic Empty Weight</b>	<b>Standard empty weight plus optional equipment.</b>
<b>Payload</b>	<b>Weight of occupants, cargo and baggage.</b>
<b>Useful Load</b>	<b>Difference between takeoff weight, or ramp weight if applicable, and basic empty weight.</b>
<b>Maximum Ramp Weight</b>	<b>Maximum weight approved for ground maneuver. (It includes weight of start, taxi and run-up fuel).</b>
<b>Maximum Takeoff Weight</b>	<b>Maximum weight approved for the start of the takeoff run.</b>
<b>Maximum Landing Weight</b>	<b>Maximum weight approved for the landing touchdown.</b>
<b>Maximum Zero Fuel Weight</b>	<b>Maximum weight exclusive of usable fuel.</b>

**THIS PAGE INTENTIONALLY LEFT BLANK**

## TABLE OF CONTENTS

### SECTION 2

### LIMITATIONS

Paragraph No		Page No
2 1	General .....	2-1
2.3	Airspeed Limitations .....	2-1
2 5	Airspeed Indicator Markings .....	2-2
2 7	Power Plant Limitations .....	2-3
2 9	Power Plant Instrument Markings .....	2-4
2 11	Weight Limits .....	2-5
2 13	Center of Gravity Limits .....	2-5
2 15	Maneuver Limits .....	2-5
2 17	Flight Maneuvering Load Factors .....	2-6
2 19	Types of Operation .....	2-6
2 21	Fuel Limitations .....	2-6
2 23	Noise Level .....	2-6
2 25	Gyro Suction Limits .....	2-7
2 27	Placards .....	2-7

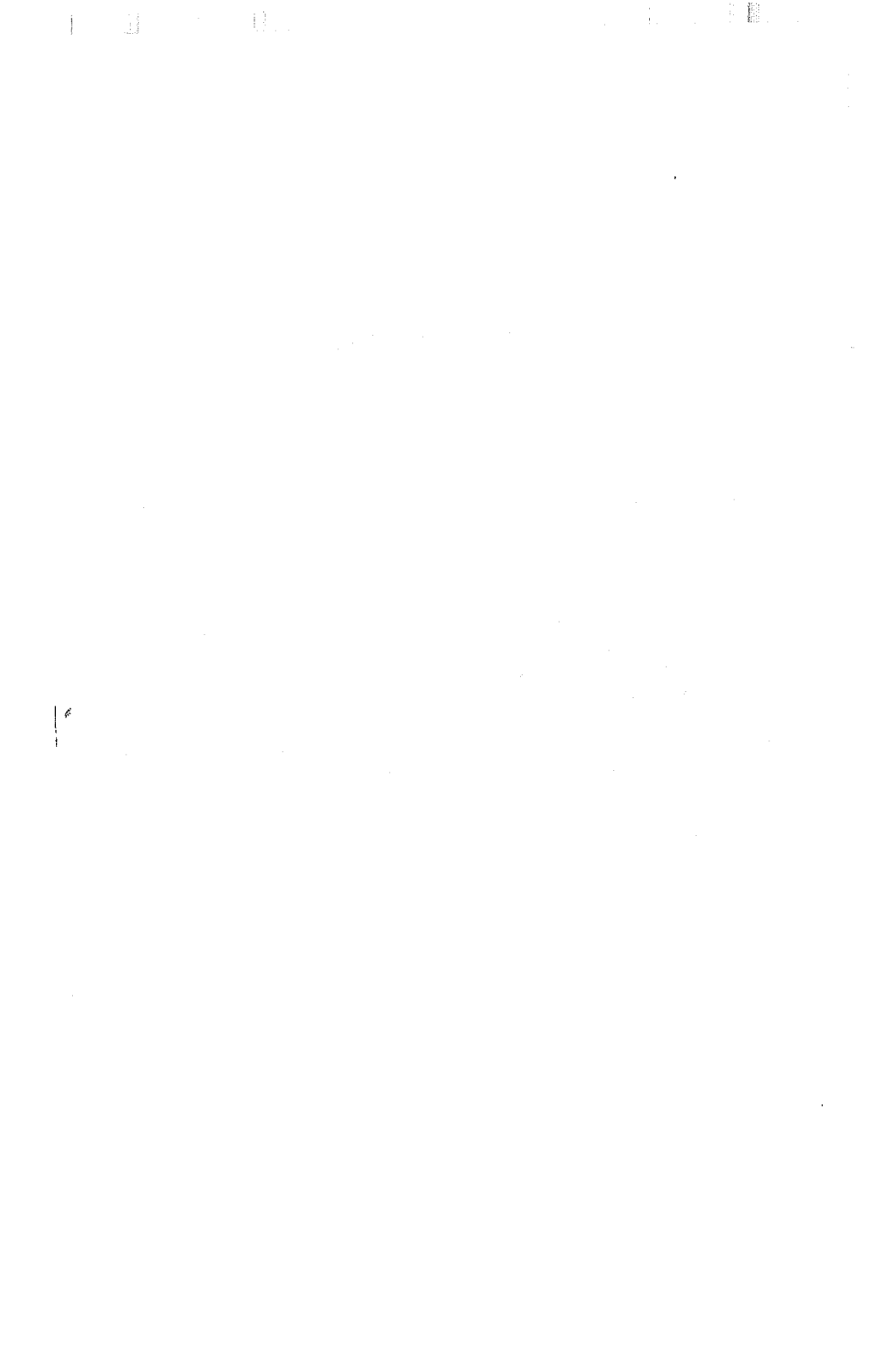

**SECTION 2  
LIMITATIONS**

**2.1 GENERAL**

This section provides the "FAA Approved" operating limitations, instrument markings, color coding and basic placards necessary for the safe operation of the airplane and its systems.

This airplane must be operated as a normal category airplane in compliance with the operating limitations stated in the form of placards and markings and those given in this section and handbook.

Limitations associated with those optional systems and equipment which require handbook supplements can be found in Section 9 (Supplements).

**2.3 AIRSPEED LIMITATIONS**

SPEED	CIAS	KCAS
Design Maneuvering Speed ( $V_A$ ) - Do not make full or abrupt control movements above this speed.		
3800 lbs.	135	133
2700 lbs.	112	112

**CAUTION**

Maneuvering speed decreases at lighter weight as the effects of aerodynamic forces become more pronounced. Linear interpolation may be used for intermediate gross weights. Maneuvering speed should not be exceeded while operating in rough air.

**SECTION 2  
LIMITATIONS****PIPER AIRCRAFT CORPORATION  
PA-44-180, SEMINOLE**

SPEED	KIAS	KCAS
Never Exceed Speed ( $V_{NE}$ ) - Do not exceed this speed in any operation.	202	194
Maximum Structural Cruising Speed ( $V_{NO}$ ) - Do not exceed this speed except in smooth air and then only with caution.	169	165
Maximum Flaps Extended Speed ( $V_{FE}$ ) - Do not exceed this speed with the flaps extended.	111	109
Maximum Gear Extended Speed ( $V_{LE}$ ) - Do not exceed this speed with landing gear extended.	140	138
Maximum Landing Gear Extending Speed ( $V_{LO}$ ) - Do not extend landing gear above this speed.	140	138
Maximum Landing Gear Retracting Speed ( $V_{LO}$ ) - Do not retract landing gear above this speed.	109	109
Air Minimum Control Speed ( $V_{MCA}$ ) - Lowest airspeed at which airplane is controllable with one engine operating and no flaps. Note: This is a stalled condition.	56	63
One Engine Inoperative Best Rate of Climb Speed.	88	90

**2.5 AIRSPEED INDICATOR MARKINGS**

MARKING	IAS
Red Radial Line (Never Exceed)	202 KTS
Red Radial Line (One Engine Inoperative Air Minimum Control Speed)	56 KTS

<b>MARKING</b>	<b>IAS</b>
Blue Radial Line (One Engine Inoperative Best Rate of Climb Speed)	88 KTS
Yellow Arc (Caution Range - Smooth Air Only)	169 KTS to 202 KTS
Green Arc (Normal Operating Range)	57 KTS to 169 KTS
White Arc (Flap Down)	55 KTS to 111 KTS

**2.7 POWER PLANT LIMITATIONS**

(a) Number of Engines	2
(b) Engine Manufacturer	Lycoming
(c) Engine Model No.	
Left	O-360-E1A6D
Right	LO-360-E1A6D
(d) Engine Operating Limits	
(1) Maximum Horsepower	180
(2) Maximum Rotation Speed (RPM)	2700
(3) Maximum Manifold Pressure	Full Throttle
(4) Maximum Cylinder Head Temperature	500°F
(5) Maximum Oil Temperature	245°F
(e) Oil Pressure	
Minimum	15 PSI
Maximum	115 PSI
(f) Fuel Pressure	
Normal Operating Range (green arc)	5 PSI to 8 PSI
Minimum (red line)	.5 PSI
Maximum (red line)	8 PSI
(g) Fuel (minimum grade)	100 or 100LL Aviation Grade
(h) Number of Propellers	2
(i) Propeller Manufacturer	Hartzell
(j) Propeller Hub and Blade Models	
(1) Standard (Two Blade)	
Left	HC-C2Y(K,R)-2CEUF/ FC7666A-2R
Right	HC-C2Y(K,R)-2CLEUF/ FJC7666A-2R



**SECTION 2  
LIMITATIONS**

**PIPER AIRCRAFT CORPORATION  
PA-44-180, SEMINOLE**

- (2) Optional (Three Blade)
  - Left HC-C3YR-2EUF/  
FC-7663-5R
  - Right HC-C3YR-2LEUF/  
FJC-7663-5R
- (k) Propeller Diameter
  - (1) Standard (Two Blade)
    - Maximum 74 IN.
    - Minimum 72 IN.
  - (2) Optional (Three Blade)
    - Maximum 73 IN.
    - Minimum 72 IN.

**2.9 POWER PLANT INSTRUMENT MARKINGS**

- (a) Tachometer
  - Green Arc (Normal Operating Range) 500 to 2700 RPM
  - Red Line (Maximum) 2700 RPM
- (b) Oil Temperature
  - Green Arc (Normal Operating Range) 75° to 245° F
  - Red Line (Maximum) 245° F
- (c) Oil Pressure
  - Green Arc (Normal Operating Range) 60 PSI to 90 PSI
  - Yellow Arc (Caution Range) (Idle) 25 PSI to 60 PSI
  - Yellow Arc (Warm Up, Taxi & T.O.) 90 PSI to 100 PSI
  - Red Line (Minimum) 25 PSI
  - Red Line (Maximum) 100 PSI
  - or
  - Green Arc (Normal Operating Range) 60 PSI to 90 PSI
  - Yellow Arc (Caution Range) (Idle) 15 PSI to 60 PSI
  - Yellow Arc (Warm Up, Taxi & T.O.) 90 PSI to 115 PSI
  - Red Line (Minimum) 15 PSI
  - Red Line (Maximum) 115 PSI
  - or
  - Green Arc (Normal Operating Range) 55 PSI to 90 PSI
  - Yellow Arc (Caution Range) (Idle) 15 PSI to 55 PSI
  - Yellow Arc (Warm Up, Taxi & T.O.) 90 PSI to 115 PSI
  - Red Line (Minimum) 15 PSI
  - Red Line (Maximum) 115 PSI
- (d) Fuel Pressure
  - Green Arc (Normal Operating Range) .5 PSI to 8 PSI
  - Red Line (Minimum) .5 PSI
  - Red Line (Maximum) 8 PSI

(e) Cylinder Head Temperature	
Green Arc (Normal Range)	200° to 435°F
Red Line (Maximum)	500°F

### 2.11 WEIGHT LIMITS

(a) Maximum Takeoff Weight	3800 lbs.
(b) Maximum Ramp Weight	3816 lbs.
(c) Maximum Landing Weight	3800 lbs.
(d) Maximum Weight in Baggage Compartment	200 lbs.

### 2.13 CENTER OF GRAVITY LIMITS

Weight Pounds	Forward Limit Inches Aft of Datum	Rearward Limit Inches Aft of Datum
2800	84.0	93.0
3400	85.0	93.0
3800	89.0	93.0

#### NOTES

Straight line variation between points given.

The datum used is 78.4 inches ahead of the wing leading edge at wing station 106.

It is the responsibility of the airplane owner and the pilot to insure that the airplane is properly loaded. See Section 6 (Weight and Balance) for proper loading instructions.

### 2.15 MANEUVER LIMITS

All intentional acrobatic maneuvers (including spins) are prohibited. Avoid abrupt maneuvers.

**2.17 FLIGHT MANEUVERING LOAD FACTORS**

- (a) Positive Load Factor (Maximum)
  - (1) Flaps Up 3.8 G
  - (2) Flaps Down 2.0 G
- (b) Negative Load Factor (Maximum) No inverted maneuvers approved.

**2.19 TYPES OF OPERATION**

The airplane is approved for the following operations when equipped in accordance with FAR 91 or FAR 135.

- (a) Day V.F.R.
- (b) Night V.F.R.
- (c) Day I.F.R.
- (d) Night I.F.R.
- (e) Non Icing

**2.21 FUEL LIMITATIONS**

- (a) Total Capacity 110 U.S. GAL.
- (b) Unusable Fuel 2 U.S. GAL.  
The unusable fuel for this airplane has been determined as 1.0 gallon in each nacelle in critical flight attitudes.
- (c) Usable Fuel 108 U.S. GAL.  
The usable fuel in this airplane has been determined as 54 gallons in each nacelle or a total of 108 gallons.

**2.23 NOISE LEVEL**

The corrected noise level of this aircraft is 74.7 d B(A) with the two blade propeller and 75.6 d B(A) with the three blade propeller.

No determination has been made by the Federal Aviation Administration that the noise levels of this airplane are or should be acceptable or unacceptable for operation at, into, or out of, any airport.

The above statement notwithstanding, the noise level stated above has been verified by and approved by the Federal Aviation Administration in noise level test flights conducted in accordance with FAR 36, Noise Standards - Aircraft Type and Airworthiness Certification. This aircraft model is in compliance with all FAR 36 noise standards applicable to this type.

## **2.25 GYRO SUCTION LIMITS**

The operating limits for the suction system are 4.5 to 5.2 inches of mercury for all operations as indicated by the gyro suction gauge.

## **2.27 PLACARDS**

In full view of the pilot:

The markings and placards installed in this airplane contain operating limitations which must be complied with when operating this airplane in the normal category. Other operating limitations which must be complied with when operating this airplane in this category are contained in the airplane flight manual. No acrobatic maneuvers, including spins, approved.

This aircraft approved for V.F.R., I.F.R., day and night non-icing flight when equipped in accordance with FAR 91 or FAR 135.

On instrument panel in full view of the pilot:

**DEMONSTRATED CROSSWIND COMPONENT 17 KTS  
OR  
DEMO X-WIND 17 KTS**

In full view of the pilot:

**ONE ENGINE INOPERATIVE  
AIR MINIMUM CONTROL SPEED 56 KIAS**

**SECTION 2  
LIMITATIONS**

**PIPER AIRCRAFT CORPORATION  
PA-44-180, SEMINOLE**

In full view of the pilot:

**WARNING - TURN OFF STROBE LIGHTS  
WHEN IN CLOSE PROXIMITY TO  
GROUND, OR DURING FLIGHT  
THROUGH CLOUD, FOG OR HAZE.**

On instrument panel in full view of the pilot:

**MANEUVERING SPEED  
135 KIAS AT 3800  
LBS. (SEE AFM)  
OR  
VA 135 AT 3800 LBS  
(SEE P.O.H.)**

**GEAR DOWN                    140 KIAS (MAX.)  
GEAR UP                      109 KIAS (MAX.)  
EXTENDED                    140 KIAS (MAX.)**

**OR  
VLO 140 DN, 109 UP  
VLE 140 MAX.**

Near emergency gear release:

**EMERGENCY GEAR EXTENSION  
PULL TO RELEASE. SEE AFM  
BEFORE RE-ENGAGEMENT**

Near gear selector switch:

**GEAR UP                      109 KIAS MAX.  
DOWN                         140 KIAS MAX.**

Adjacent to upper door latch:

**ENGAGE LATCH BEFORE FLIGHT**

On inside of baggage compartment door.

**BAGGAGE MAXIMUM 200 LBS**

On storm window:

**DO NOT OPEN ABOVE 129 KIAS**

In full view of the pilot:

**TAKEOFF CHECK LIST**

Fuel Selectors On	Cowl Flaps Set
Electric Fuel Pumps On	Seat Backs Erect
Alternators On	Flaps Set
Engine Gauges Checked	Trim Set (Stab. & Rudder)
Mixtures Set	Fasten Belts/Harness
Primers Locked	Controls Free - Full Travel
Propellers Set	Doors Latched
Carb Heat Off	Air Conditioner Off

**LANDING CHECK LIST**

Seat Backs Erect	Mixtures Rich
Fasten Belts/Harness	Propellers Set
Fuel Selectors On	Gear Down - 140 KIAS Max.
Cowl Flaps Set	Flaps Set - 111 KIAS Max.
Electric Fuel Pumps On	Air Conditioner Off

**OR**

**LANDING CHECK LIST**

Seat Backs Erect	Electric Fuel Pumps On
Fasten Belts/Harness	Mixtures Rich
Fuel Selectors On	Propellers Set
Cowl Flaps Set	Gear Down (Green Arc)
	Flaps Set - (White Arc)
	Air Conditioner Off

The "AIR CONDITIONER OFF" item in the above takeoff and landing check lists is mandatory for air conditioned aircraft only.

**SECTION 2  
LIMITATIONS**

**PIPER AIRCRAFT CORPORATION  
PA-44-180, SEMINOLE**

---

In full view of the pilot:

**ONE ENGINE INOPERATIVE STALLS  
NOT RECOMMENDED. CAN CAUSE 300  
FT. LOSS OF ALTITUDE AND 30° PITCH  
ANGLE**

In full view of the pilot when the oil cooler winterization kit is installed:

**OIL COOLER WINTERIZATION PLATE  
TO BE REMOVED WHEN AMBIENT  
TEMPERATURE EXCEEDS 50° F.**

On the vertical window post between the first and second left side windows and close to the Emergency Exit release handle:

**EMERGENCY EXIT  
PULL HANDLE FORWARD  
PUSH WINDOW OUT**

Adjacent to fuel tank filler caps (Prior to Serial Number 44-7995002):

**FUEL ONLY — 100/130 AVIATION  
GRADE MIN. — USABLE CAPACITY  
54 GAL.**

**OR**

Adjacent to fuel tank filler caps (Serial Number 44-7995002 and up):

**FUEL 100 OR 100LL AVIATION GRADE**

## TABLE OF CONTENTS

### SECTION 3

#### EMERGENCY PROCEDURES

Paragraph No.		Page No
3.1	General .....	3-1
3.3	Emergency Procedures Checklist .....	3-2
	Airspeeds For Safe Operations .....	3-2
	Engine Inoperative Procedures .....	3-2
	Fire .....	3-5
	Fuel Management During One Engine Inoperative Operation .....	3-6
	Engine Driven Fuel Pump Failure .....	3-6
	Landing Gear Unsafe Warnings .....	3-6
	Manual Extension of Landing Gear .....	3-7
	Gyro Suction Failures .....	3-7
	Electrical Failures .....	3-7
	Electrical Overload (Alternators Over 30 Amps Above Known Electrical Load) .....	3-10
	Spin Recovery (Intentional Spins Prohibited) .....	3-10a
	Open Door (Entry Door Only) .....	3-10b
	Propeller Overspeed .....	3-10b
	Emergency Exit .....	3-10b
3.5	Amplified Emergency Procedures (General) .....	3-11
3.7	Engine Inoperative Procedures .....	3-11
3.9	Fire .....	3-16
3.11	Fuel Management During One Engine Inoperative Operation .....	3-17
3.13	Engine-Driven Fuel Pump Failure .....	3-17
3.15	Landing Gear Unsafe Warnings .....	3-18
3.17	Manual Extension Of The Landing Gear .....	3-18
3.19	Gear-Up Emergency Landing .....	3-18
3.21	Gyro Suction Failures .....	3-19
3.23	Electrical Failures .....	3-19



**TABLE OF CONTENTS (cont)**

**SECTION 3 (cont)**

<b>Paragraph No.</b>		<b>Page No.</b>
3.25	Spins .....	3-22
3.27	Open Door .....	3-22
3.29	Propeller Overspeed.....	3-23
3.31	Combustion Heater Overheat .....	3-23
3.33	Emergency Descent .....	3-23
3.35	Emergency Exit .....	3-23
3.37	Carburetor Icing.....	3-24

**SECTION 3  
EMERGENCY PROCEDURES**

**3.1 GENERAL**

This section provides the recommended procedures for coping with various emergency or critical situations. All of the emergency procedures required by the FAA as well as those necessary for operation of the airplane, as determined by the operating and design features of the airplane, are presented.

Emergency procedures associated with optional systems and equipment which require handbook supplements are provided by Section 9, Supplements.

This section is divided into two basic parts. The first part contains the emergency procedures checklists. These checklists supply an immediate action sequence to be followed during critical situations with little emphasis on the operation of the systems.

The second part of the section provides amplified emergency procedures corresponding to the emergency procedures checklist items. These amplified emergency procedures contain additional information to provide the pilot with a more complete description of the procedures so they may be more easily understood.

Pilots must familiarize themselves with the procedures given in this section and must be prepared to take the appropriate action should an emergency situation arise. The procedures are offered as a course of action for coping with the particular situation or condition described. They are not a substitute for sound judgment and common sense.

Most basic emergency procedures are a normal part of pilot training. The information presented in this section is not intended to replace this training. This information is intended to provide a source of reference for the procedures which are applicable to this airplane. The pilot should review standard emergency procedures periodically to remain proficient in them.

**3.3 EMERGENCY PROCEDURES CHECK LIST**

**AIRSPEDS FOR SAFE OPERATIONS**

One engine inoperative air minimum control .....	56 KIAS
One engine inoperative best rate of climb .....	88 KIAS
One engine inoperative best angle of climb .....	82 KIAS
Maneuvering .....	135 KIAS
Never exceed .....	202 KIAS

**ENGINE INOPERATIVE PROCEDURES**

**DETECTING DEAD ENGINE**

Loss of thrust.

Nose of aircraft will yaw in direction of dead engine (with coordinated controls).

**ENGINE SECURING PROCEDURE (FEATHERING PROCEDURE)**

Minimum control speed .....	56 KIAS
One engine inoperative best rate of climb .....	88 KIAS
Maintain direction and airspeed above 82 KIAS.	
Mixture controls .....	forward
Propeller controls .....	forward
Throttle controls .....	forward
Flaps .....	retract
Gear .....	retract
Identify inoperative engine.	
Throttle of inop. engine .....	retard to verify

To attempt to restore power prior to feathering:

Mixtures .....	as required
Fuel selector .....	ON
Primers .....	locked
Magnetos .....	left or right only
Electric fuel pump .....	check ON
Carburetor heat .....	ON
Prop control of inop. engine .....	feather before RPM drops below 950
Mixture of inop. engine .....	idle cut-off

- Trim ..... as required (3° to 5° of bank toward  
operative engine - ball ½ to ¾ out)
- Electric fuel pump of inop. engine ..... OFF
- Magnetos of inop. engine ..... OFF
- Cowl flaps ..... close on inop. engine,  
as required on operative engine
- Alternator of inop. engine ..... OFF
- Electrical load ..... reduce
- Fuel selector ..... OFF inop. engine,  
consider crossfeed
- Electric fuel pump operative engine ..... OFF

**ENGINE FAILURE DURING TAKEOFF (Below 75 KIAS)**

If engine failure occurs during takeoff and 75 KIAS has not been attained:  
Throttles ..... CLOSE both immediately  
Stop straight ahead.

If inadequate runway remains to stop:

- Throttles ..... CLOSED
  - Brakes ..... apply max. braking
  - Master switch ..... OFF
  - Fuel selectors ..... OFF
- Continue straight ahead, turning to avoid obstacles.

**ENGINE FAILURE DURING TAKEOFF (75 KIAS or above)**

If engine failure occurs during takeoff ground roll or after lift-off with gear still down and 75 KIAS has been attained:

If adequate runway remains CLOSE both throttles immediately, land if airborne and stop straight ahead.

If runway remaining is inadequate for stopping, decide whether to abort or continue. If decision is made to continue, maintain heading and when climb is established retract landing gear, accelerate to 88 KIAS, and feather inoperative engine prop (see Engine Securing Procedure).

**WARNING**

In certain combinations of aircraft weight, configuration, ambient conditions and speed, negative climb performance may result. Refer to One Engine Inoperative Climb Performance chart, Figure 5-25.



**AIR START (UNFEATHERING PROCEDURE)**

Fuel selector inop. engine ..... ON  
Electric fuel pump inop. engine ..... ON  
Prop control .....forward to cruise  
RPM position  
Mixture ..... RICH  
Throttle ..... two full strokes and  
then open 1/4 inch  
Magneto switches ..... ON  
Starter ..... engage until prop windmills  
Throttle ..... reduce power until engine is warm  
If engine does not start, prime as required.  
Alternator ..... ON

**FIRE**

**ENGINE FIRE ON GROUND**

If engine has not started:

Mixture ..... idle cut-off  
Throttle ..... open  
Starter ..... crank engine

If engine has already started and is running, continue operating to try pulling the fire into the engine.

If fire continues, extinguish with best available means.

If external fire extinguishing is to be applied:

Fuel selector valves ..... OFF  
Mixture ..... idle cut-off

**ENGINE FIRE IN FLIGHT**

Affected engine:

Fuel selector ..... OFF  
Throttle ..... close  
Propeller ..... feather  
Mixture ..... idle cut-off  
Cowl flap ..... OPEN

If terrain permits land immediately.

**FUEL MANAGEMENT DURING ONE ENGINE INOPERATIVE OPERATION**

**CRUISING**

When using fuel from tank on the same side as the operating engine:

- Fuel selector operating engine ..... ON
- Fuel selector inop. engine ..... OFF
- Electric fuel pumps ..... OFF  
(except in case of engine driven pump failure, electric fuel pump on operating engine side must be used)

When using fuel from tank on the side opposite the operating engine:

- Fuel selector operating engine ..... CROSSFEED
- Fuel selector inop. engine ..... OFF
- Electric fuel pumps ..... OFF  
(except in case of engine driven pump failure, electric fuel pump on operating engine side must be used)

**NOTE**

Use crossfeed in level cruise flight only.

**LANDING**

- Fuel selector operating engine ..... ON
- Fuel selector inop. engine ..... OFF

**ENGINE DRIVEN FUEL PUMP FAILURE**

- Electric fuel pump ..... ON

**LANDING GEAR UNSAFE WARNINGS**

Red light indicates gear intransit

Recycle gear if indication continues.

Light will illuminate and gear horn sounds when the gear is not down and locked if throttles are at low settings or wing flaps are in second or third notch position.





**SECTION 3  
EMERGENCY PROCEDURES**

**PIPER AIRCRAFT CORPORATION  
PA-44-180, SEMINOLE**

---

If power is not restored

Inop. ALT switch ..... OFF  
Electrical loads ..... Re-establish to  
60 amps max.

If both ammeters show zero

ALT switches ..... Both OFF

Reduce electrical loads to minimum

ALT circuit breakers ..... Check both and reset  
as required  
ALT switches ..... ON one at a time

Determine ALT showing LEAST (but not zero) amps

ALT switches ..... Least load ON  
other OFF  
Electrical loads ..... Re-establish to  
60 amps. max.

**FOR AIRPLANES WITH INTERLOCKED MASTER AND ALT  
SWITCH OPERATION**

If alternator outputs are NOT restored

Alt switches ..... OFF  
Electrical loads ..... Reduce to minimum

Land as soon as practical. The battery is the only remaining source of electrical power. Anticipate complete electrical failure.

**WARNING**

Compass error may exceed 10 degrees with both alternators inoperative.

**NOTE**

If the battery is depleted, the landing gear must be lowered using the emergency gear extension procedure. The gear position lights will be inoperative.

**FOR AIRPLANES WITH SEPARATE BAT AND ALT SWITCH OPERATION**

If alternator outputs are NOT restored

BAT switch ..... OFF  
ALT switches ..... ON one at a time

If one or both alternator outputs are restored

Electrical loads ..... Reduce to minimum

Land as soon as practical. The alternator(s) is the only remaining source of electrical power.

**NOTE**

Due to increased system voltage and radio frequency noise, operation with ALT switch ON and BAT switch OFF should be made only when required by an electrical system failure.

If alternator outputs are NOT restored

ALT switches ..... OFF  
Electrical loads ..... Reduce to minimum

Land as soon as practical. The battery is the only remaining source of electrical power. Anticipate complete electrical system failure.

**WARNING**

Compass error may exceed 10 degrees with both alternators inoperative.

**NOTE**

If the battery is depleted, the landing gear must be lowered using the emergency gear extension procedure. The gear position lights will be inoperative.

**ELECTRICAL OVERLOAD (ALTERNATORS OVER 30 AMPS  
ABOVE KNOWN ELECTRICAL LOAD)**

**FOR AIRPLANES WITH INTERLOCKED MASTER AND ALT  
SWITCH OPERATION**

Electrical load ..... Reduce

If alternator loads are NOT reduced

ALT switches ..... OFF

Land as soon as possible. The battery is the only remaining source of electrical power. Anticipate complete electrical failure.

**FOR AIRPLANES WITH A SEPARATE BAT AND ALT SWITCH  
OPERATION**

ALT switches ..... ON

BAT switch ..... OFF

If alternator loads are reduced, this indicates a malfunction of the battery and/or battery wiring.

Electrical loads ..... Reduce to Min.

Land as soon as practical. The alternator(s) is the only remaining source of electrical power.

**NOTE**

Due to increased system voltage and radio frequency noise, operation with ALT switches ON and BAT switch OFF should be made only when required by an electrical failure.

If alternator loads are NOT reduced

ALT switches ..... OFF

BAT switch ..... As required

Electrical loads ..... Reduce to minimum

Land as soon as practical. The battery is the only remaining source of electrical power. Anticipate complete electrical failure.

***WARNING***

Compass error may exceed 10 degrees with both alternators inoperative.

**NOTE**

If the battery is depleted, the landing gear must be lowered using the emergency gear extension procedure. The gear position lights will be inoperative.

**SPIN RECOVERY (INTENTIONAL SPINS PROHIBITED)**

- Throttles ..... retard to idle
- Rudder ..... full opposite to  
direction of spin
- Control wheel ..... release back pressure
- Control wheel ..... full forward if  
nose does not drop
- Ailerons ..... neutral
- Rudder ..... neutralize when  
rotation stops
- Control wheel .....smooth back pressure  
to recover from dive

**NOTE**

Federal Aviation Administration Regulations do not require spin demonstration of multi-engine airplanes; therefore, spin tests have not been conducted. The recovery technique presented is based on the best available information

**OPEN DOOR (ENTRY DOOR ONLY)**

If both upper and side latches are open, the door will trail slightly open and airspeeds will be reduced slightly.

To close the door in flight.

Slow airplane to 82 KIAS.

Cabin vents ..... close  
Storm window ..... open

If upper latch is open ..... latch

If side latch is open ..... pull on armrest while  
moving latch handle  
to latched position

If both latches are open ..... latch side latch  
then top latch

**PROPELLER OVERSPEED**

Throttle ..... retard

Oil pressure ..... check

Prop control ..... full DECREASE rpm,  
then set if any  
control available

Airspeed ..... reduce

Throttle ..... as required to remain  
below 2700 rpm

**EMERGENCY EXIT**

Remove thermoplastic cover.

Pull handle forward

Push window out

### **3.5 AMPLIFIED EMERGENCY PROCEDURES (GENERAL)**

The following paragraphs are presented to supply additional information for the purpose of providing the pilot with a more complete understanding of the recommended course of action and probable cause of an emergency situation.

### **3.7 ENGINE INOPERATIVE PROCEDURES**

#### **DETECTING A DEAD ENGINE**

A loss of thrust will be noted and with coordinated controls, the nose of the aircraft will yaw in the direction of the dead engine.

#### **ENGINE SECURING PROCEDURE (FEATHERING PROCEDURE)**

Keep in mind that the one engine inoperative air minimum control speed is 56 KIAS and the one engine inoperative best rate of climb speed is 88 KIAS when beginning the feathering procedure.

To feather a propeller, maintain direction and an airspeed above 82 KIAS. Move the mixture and propeller controls forward. The throttle controls should be moved forward to maintain a safe airspeed. Retract the flaps and landing gear and identify the inoperative engine. The airplane will yaw in the direction of the dead engine. Retard the throttle of the inoperative engine to verify loss of power.

#### **NOTE**

If circumstances permit, in the event of an actual engine failure, the pilot may elect to attempt to restore power prior to feathering.

If circumstances permit an attempt to restore power prior to feathering, adjust the mixture control as required, move the fuel selector control to ON, check primers locked and select either L (left) or R (right) magneto. Move the carburetor heat control to ON and the electric fuel pump to the ON position. If power is not immediately restored turn off the electric fuel pump.

The propellers can be feathered only while the engine is rotating above 950 RPM. Loss of centrifugal force due to slowing RPM will actuate a stop pin that keeps the propeller from feathering each time the engine is stopped on the ground. One engine inoperative performance will decrease if the propeller of the inoperative engine is not feathered.

The propeller control of the inoperative engine should be moved to the feather position, and the mixture control of the inoperative engine should be moved to idle cut-off.

Trim the aircraft as required and maintain a 3° to 5° bank toward the operating engine. The ball will be ½ to ¾ out for minimum drag. The electric fuel pumps should be off except in the case of an engine-driven fuel pump failure. Turn OFF the magnetos and close the cowl flaps on the inoperative engine. Cowl flaps should be used as necessary on the operative engine. The alternator of the inoperative engine should be turned OFF and the electrical load reduced to prevent depletion of the battery. Move the fuel selector control for the inoperative engine to the OFF position. If necessary, consider the use of crossfeed (refer to Fuel Management During One Engine Inoperative Operation, paragraph 3.11). Turn OFF the operative engine's electric fuel pump.

**NOTE**

When an engine is feathered, the alternator, gyro air, and oil annunciator warning lights will remain illuminated.

**ENGINE FAILURE DURING TAKEOFF (Below 75 KIAS)**

The one engine inoperative air minimum control speed for this airplane is 56 KIAS under standard conditions.

**NOTE**

This is a stalled condition.

If engine failure occurs during takeoff ground roll and 75 KIAS has not been attained, CLOSE both throttles immediately and stop straight ahead. If inadequate runway remains to stop, close the throttles and apply maximum braking. The master switch and fuel selectors should be turned OFF. Continue path straight ahead turning to avoid obstacles as necessary.

#### **ENGINE FAILURE DURING TAKEOFF (75 KIAS or above)**

If engine failure occurs during takeoff ground roll or after lift-off with the gear still down and 75 KIAS has been attained the course of action to be taken will depend on the runway remaining. If adequate runway remains, CLOSE both throttles immediately, land if airborne and stop straight ahead. If the runway remaining is inadequate for stopping, the pilot must decide whether to abort the takeoff or to continue. The decision must be based on the pilot's judgment considering loading, density altitude, obstructions, the weather, and the pilot's competence. If the decision is made to continue the takeoff, maintain heading and airspeed, RETRACT the landing gear, accelerate to 88 KIAS and FEATHER the inoperative engine (refer to Engine Securing Procedure).

#### ***WARNING***

In certain combinations of aircraft weight, configuration, ambient conditions and speed, negative climb performance may result. Refer to One Engine Inoperative Climb Performance chart, Figure 5-25.

#### **ENGINE FAILURE DURING FLIGHT (Below 56 KIAS)**

Should an engine fail during flight at an airspeed below 56 KIAS, apply rudder towards the operative engine to maintain directional control. The throttles should be retarded to stop the yaw force produced by the inoperative engine. Lower the nose of the aircraft to accelerate above 56 KIAS and increase the power on the operative engine as the airspeed exceeds 56 KIAS.

After an airspeed above 56 KIAS has been established, an engine restart attempt may be made if altitude permits. If the restart has failed, or if altitude does not permit, the engine should be secured, see Engine Securing Procedure.



**THIS PAGE INTENTIONALLY LEFT BLANK**

## **ONE ENGINE INOPERATIVE LANDING**

Complete the Engine Securing Procedure. The landing gear should not be extended and the wing flaps should not be lowered until certain of making the field.

Maintain additional altitude and speed during approach, keeping in mind that landing should be made right the first time and that a go-around should be avoided if at all possible.

A final approach speed of 90 KIAS and the use of 25° rather than full wing flaps will place the airplane in the best configuration for a go-around should this be necessary.

### ***WARNING***

Under some conditions of loading and density altitude a go-around may be impossible, and in any event the sudden application of power during one engine inoperative operation makes control of the airplane more difficult.

## **ONE ENGINE INOPERATIVE GO-AROUND**

### **NOTE**

A one engine inoperative go-around should be avoided if at all possible.

To execute a one engine inoperative go-around, advance the mixture and propeller levers forward. The throttle should be advanced slowly to the full forward position. Retract the flaps and landing gear. Maintain airspeed at the one engine inoperative best rate of climb speed of 88 KIAS. Set the trim and cowl flaps as required.

## **AIR START (UNFEATHERING PROCEDURE)**

Move the fuel selector for the inoperative engine to the ON position and check to make sure the electric fuel pump for that engine is ON. Push the propeller control forward to the cruise RPM position and the mixture should be set RICH. Push in full throttle twice and then open it 1/4 inch.

Turn ON the magneto switches and engage the starter until the propeller windmills. The throttle should be set at reduced power until the engine is warm. If the engine does not start, prime as necessary. The alternator switch should then be turned ON.

### **3.9 FIRE**

#### **ENGINE FIRE ON THE GROUND**

The first attempt to extinguish the fire is to try to draw the fire back into the engine. If the engine has not started, move the mixture control to idle cut-off and open the throttle. Begin to crank the engine with the starter in an attempt to pull the fire into the engine.

If the engine has already started and is running, continue operating to try to pull the fire into the engine.

In either case (above), if the fire continues longer than a few seconds the fire should be extinguished by the best available external means.

If an external fire extinguishing method is to be applied move the fuel selector valves to OFF and the mixture to idle cut-off.

#### **ENGINE FIRE IN FLIGHT**

The possibility of an engine fire in flight is extremely remote. The procedure given below is general and pilot judgment should be the deciding factor for action in such an emergency.

If an engine fire occurs in flight, place the fuel selector of the affected engine in the OFF position and close its throttle. Feather the propeller on the faulty engine. Move the mixture control to idle cut-off. The cowl flap should be open. A landing should be made if terrain permits.

### **3.11 FUEL MANAGEMENT DURING ONE ENGINE INOPERATIVE OPERATION**

A crossfeed is provided to increase range during one engine inoperative operation. Use crossfeed in level flight only.

#### **CRUISING**

When using fuel from the fuel tank on the same side as the operating engine, the fuel selector of the operating engine should be ON and the fuel selector for the inoperative engine should be OFF. The electric fuel pumps should be OFF except in the case of an engine-driven fuel pump failure. If an engine-driven fuel pump has failed, the electric fuel pump on the operating engine side must be ON.

Increased range is available by using fuel from the tank on the opposite side of the operating engine. For this configuration the fuel selector of the operating engine must be on X-FEED (crossfeed) and the fuel selector of the inoperative engine must be OFF. The electric fuel pumps should be OFF. Crossfeed is approved for level cruise flight only.

#### **LANDING**

During the landing sequence, the fuel selector of the operating engine must be ON and the fuel selector of the inoperative engine OFF. The electric fuel pump of the operating engine should be ON.

### **3.13 ENGINE-DRIVEN FUEL PUMP FAILURE**

Loss of fuel pressure and engine power can be an indication of failure of the engine-driven fuel pump. Should these occur and engine-driven fuel pump failure is suspected, turn ON the electric fuel pump.

#### **CAUTION**

If normal engine operation and fuel flow is not immediately re-established, the electric fuel pump should be turned off. The lack of a fuel flow indication while on the electric fuel pump could indicate a leak in the fuel system, or fuel exhaustion

### **3.15 LANDING GEAR UNSAFE WARNINGS**

The red landing gear light will illuminate when the landing gear is in transition between the full up position and the down and locked position. The pilot should recycle the landing gear if continued illumination of the light occurs. Additionally, the light will illuminate when the gear warning horn sounds. The gear warning horn will sound at low throttle settings if the gear is not down and locked, and when wing flaps are in the second or third notch position and the gear is not down and locked.

### **3.17 MANUAL EXTENSION OF THE LANDING GEAR**

Several items should be checked prior to extending the landing gear manually. Check for popped circuit breakers and ensure the master switch is ON. Then check the alternators. If it is daytime, turn OFF the navigation lights.

To execute a manual extension of the landing gear, power should be reduced to maintain airspeed below 100 KIAS. Place the landing gear selector switch in the GEAR DOWN position and pull the emergency gear extension knob. Check for 3 green indicator lights.

#### ***WARNING***

If the emergency gear extension knob has been pulled out to lower the gear due to a gear system malfunction, leave the control in its extended position until the airplane has been put on jacks to check the proper function of the landing gears hydraulic and electrical systems.

### **3.19 GEAR-UP EMERGENCY LANDING**

An approach should be made with power at a normal airspeed with the flaps up. The flaps are left up to reduce wing and flap damage. Close the throttles just before touchdown. Turn OFF the master and ignition switches and move the fuel selector valve controls to OFF. Contact to the surface should be made at a minimum airspeed.

### **3.21 GYRO SUCTION FAILURES**

A malfunction of the instrument suction system will be indicated by a reduction of the suction reading on the gauge. A red button annunciator will show in case of a feathered engine or vacuum pump failure

In the event of a suction system malfunction, (suction lower than 4.5 inches of mercury) increase engine RPM to 2700. Descend to an altitude at which 4.5 inches of mercury suction can be maintained, if possible. The electric turn indicator should be used to monitor the performance of the directional and attitude indicators.

### **3.23 ELECTRICAL FAILURES**

If one ammeter shows zero output, turn its switch OFF, reduce electrical loads to a minimum and check its circuit breaker. Reset if required. Turn ALT switch ON. If the alternator remains inoperative, repeat the above procedure one more time. If the alternator still remains inoperative, turn ALT switch OFF, maintain an electrical load of 60 amps maximum on the operating alternator and exercise judgment regarding continued flight.

If both ammeters show zero output, turn both ALT switches OFF and reduce electrical loads to a minimum. Check both alternator circuit breakers and reset if required. Turn ALT switches ON one at a time while observing the ammeters. The alternator showing the LEAST (but not zero) output, should be turned ON and the other alternator should be left OFF. Electrical loads may be re-established as required to a maximum of 60 amps.

#### **FOR AIRPLANES WITH INTERLOCKED MASTER AND ALT SWITCH OPERATION**

If neither alternator output can be restored, both alternator switches should be left OFF. Reduce electrical load to essential systems and land as soon as practical. The battery is the only remaining source of electrical power.

#### ***WARNING***

Compass error may exceed 10 degrees with both alternators inoperative

**NOTE**

If the battery is depleted, the landing gear must be lowered using the emergency gear extension procedure. The gear position lights will be inoperative.

**FOR AIRPLANES WITH SEPARATE BAT AND ALT SWITCH OPERATION**

If alternator outputs are not restored, turn BAT switch OFF, ALT switches OFF, then ON one at a time. If one or both alternator outputs are restored, leave the BAT switch OFF and land as soon as practical. This condition is an indication of a battery and/or battery wiring malfunction.

**NOTE**

Operation with the ALT switches ON and the BAT switch OFF should be made only when required by an electrical failure, due to increased system voltage and radio frequency noise.

If neither alternator output can be restored, turn both ALT switches OFF and turn the BAT switch ON as required. Maintain a minimum electrical load and land as soon as practical. The battery is the only remaining source of electrical power.

***WARNING***

Compass error may exceed 10 degrees with both alternators inoperative.

**NOTE**

If the battery is depleted, the landing gear must be lowered using the emergency extension procedure. The green position lights will be inoperative.

**ELECTRICAL OVERLOAD (ALTERNATORS OVER 30 AMPS  
ABOVE KNOWN ELECTRICAL LOAD)**

If abnormally high alternator outputs are observed and persist (more than 30 amps above known electrical load for the operating conditions), they may be caused by a low battery, a battery fault or other abnormal electrical load. If the cause is a low battery, the indication should begin to decrease toward normal within 5 minutes. If the overload condition persists proceed as follows:

For airplanes with interlocked MASTER and ALT switches, reduce electrical loads by turning off non-essential electrical equipment. If the loads cannot be reduced, turn the ALT switches OFF, maintain minimum electrical load and land as soon as practical. The battery is the only remaining source of electrical power. Also anticipate complete electrical failure.

**WARNING**

Compass error may exceed 10 degrees with both alternators inoperative.

**NOTE**

If the battery is depleted, the landing gear must be lowered using the emergency extension procedure. The green position lights will be inoperative.

For airplanes with separate BAT and ALT switch operation, turn the BAT switch OFF and the ammeter indication should decrease. Turn the BAT switch ON and continue to monitor the ammeter. Should the alternator outputs not decrease within 5 minutes, turn the BAT switch OFF and land as soon as practical. All electrical loads are being supplied by the alternators.

**NOTE**

Operation with the ALT switches ON and the BAT switch OFF should be made only when required by an electrical failure, due to increased system voltage and radio frequency noise



### **3.25 SPINS**

Intentional spins are prohibited in this airplane. In the event a spin is encountered unintentionally, immediate recovery actions must be taken.

To recover from an unintentional spin, immediately retard the throttles to the idle position. Apply full rudder opposite the direction of the spin rotation. Let up all back pressure on the control wheel. If the nose does not drop, immediately push the control wheel full forward. Keep the ailerons neutral. Maintain the controls in these positions until spin rotation stops, then neutralize the rudder. Recovery from the resultant dive should be with smooth back pressure on the control wheel. No abrupt control movement should be used during recovery from the dive, as the positive limit maneuvering load factor may be exceeded.

#### **NOTE**

Federal Aviation Administration Regulations do not require spin demonstration of multi-engine airplanes; therefore, spin tests have not been conducted. The recovery technique presented is based on the best available information.

### **3.27 OPEN DOOR (ENTRY DOOR ONLY)**

The cabin door is double latched, so the chances of its springing open in flight at both the top and side are remote. However, should you forget the upper latch, or not fully engage the side latch, the door may spring partially open. This will usually happen at takeoff or soon afterward. A partially open door will not affect normal flight characteristics, and a normal landing can be made with the door open.

If both upper and side latches are open, the door will trail slightly open, and airspeed will be reduced slightly.

To close the door in flight, slow the airplane to 82 KIAS, close the cabin vents and open the storm window. If the top latch is open, latch it. If the side latch is open, pull on the armrest while moving the latch handle to the latched position. If both latches are open, close the side latch then the top latch.

### **3.29 PROPELLER OVERSPEED**

Propeller overspeed is usually caused by a malfunction in the propeller governor which allows the propeller blades to rotate to full low pitch.

If propeller overspeed should occur, retard the throttle. The propeller control should be moved to full "DECREASE rpm" and then set if any control is available. Airspeed should be reduced and the throttle should be used to maintain 2700 RPM.

### **3.31 COMBUSTION HEATER OVERHEAT**

In the event of an overheat condition, the fuel, air and ignition to the heater is automatically cut off. Do not attempt to restart the heater until it has been inspected and the cause of the malfunction has been determined and corrected.

### **3.33 EMERGENCY DESCENT**

In the event an emergency descent becomes necessary, CLOSE the throttles and move the propeller controls full FORWARD. Adjust the mixture control as necessary to attain smooth operation. Extend the landing gear at 140 KIAS and maintain this airspeed.

### **3.35 EMERGENCY EXIT**

The pilot's left side window is an emergency exit. This is to be used when emergency egress becomes necessary on the ground only. The emergency exit release handle is located beneath the thermoplastic cover on the vertical post between the 1st and 2nd left side windows. To exit the aircraft, remove the thermoplastic cover, push the release handle forward and then push the window out. The window then will fall free from the fuselage.

### **3.37 CARBURETOR ICING**

Under certain moist atmospheric conditions at temperatures of  $-5^{\circ}\text{C}$  to  $20^{\circ}\text{C}$ , it is possible for ice to form in the induction system, even in summer weather. This is due to the high air velocity through the carburetor venturi and the absorption of heat from this air by vaporization of the fuel.

To avoid this, carburetor preheat is provided to replace the heat lost by vaporization. Carburetor heat should be full on when carburetor ice is encountered. Adjust mixture for maximum smoothness.

**TABLE OF CONTENTS**

**SECTION 4**

**NORMAL PROCEDURES**

Paragraph No.		Page No
4.1	General .....	4-1
4.3	Airspeeds For Safe Operations .....	4-2
4.5	Normal Procedures Checklist .....	4-3
	Preparation .....	4-3
	Preflight Check .....	4-3
	Before Starting Engines .....	4-5
	Starting Engines .....	4-5
	Starting Engines In Cold Weather (Below 10°F) .....	4-6
	Starting Engines When Hot .....	4-6
	Starting Engines When Flooded .....	4-7
	Starting Engines With External Power .....	4-7
	Warm-Up .....	4-7
	Taxiing .....	4-8
	Before Takeoff - Ground Check .....	4-8
	Takeoff .....	4-9
	Takeoff Climb .....	4-10
	Cruise Climb .....	4-10
	Cruising .....	4-10
	Descent .....	4-11
	Approach and Landing .....	4-11
	Go-Around .....	4-11
	After Landing .....	4-11
	Shutdown .....	4-12
	Parking .....	4-12
4.7	Amplified Normal Procedures (General) .. .	4-12a
4.9	Preparation .....	4-12a
4.11	Preflight Check .....	4-12a
4.13	Before Starting Engines .....	4-13
4.15	Starting Engines .....	4-14

## TABLE OF CONTENTS (cont)

### SECTION 4 (cont)

Paragraph No.		Page No.
4.16	Starting Engines In Cold Weather (Below 10° F) .....	4-14
4.17	Starting Engines When Hot .....	4-15
4.19	Starting Engines When Flooded .....	4-15
4.21	Starting Engines With External Power .....	4-15
4.23	Warm-Up .....	4-17
4.25	Taxiing .....	4-17
4.27	Before Takeoff - Ground Check .....	4-17
4.29	Takeoff .....	4-19
4.31	Climb .....	4-20
4.33	Cruising .....	4-21
4.35	Descent .....	4-22
4.37	Approach and Landing .....	4-23
4.39	Go-Around .....	4-25
4.41	After Landing .....	4-25
4.43	Shutdown .....	4-25
4.45	Parking .....	4-25
4.47	Turbulent Air Operation .....	4-26
4.49	V <sub>SSE</sub> - Intentional One Engine Inoperative Speed .....	4-26
4.51	V <sub>MCA</sub> - Air Minimum Control Speed .....	4-26
4.53	Stalls .....	4-27

**SECTION 4  
NORMAL PROCEDURES**

**4.1 GENERAL**

This section describes the recommended procedures for the conduct of normal operations for the Seminole. All of the required (FAA regulations) procedures and those necessary for the safe operation of the airplane as determined by the operating and design features of the airplane are presented.

Normal procedures associated with those optional systems and equipment which require handbook supplements are provided by Section 9 (Supplements).

These procedures are provided to present a source of reference and review and to supply information on procedures which are not the same for all aircraft. Pilots should familiarize themselves with the procedures given in this section in order to become proficient in the normal operations of the airplane.

The first portion of this section consists of a short form check list which supplies an action sequence for normal operations with little emphasis on the operation of the systems.

The remainder of the section is devoted to amplified normal procedures which provide detailed information and explanations of the procedures and how to perform them. This portion of the section is not intended for use as an in-flight reference due to the lengthy explanations. The short form check list should be used for this purpose.

All data given is for both two and three blade propellers unless otherwise noted.

### **4.3 AIRSPEEDS FOR SAFE OPERATIONS**

The following airspeeds are those which are significant to the safe operation of the airplane. These figures are for standard airplanes flown at gross weight under standard conditions at sea level.

Performance for a specific airplane may vary from published figures depending upon the equipment installed; the condition of the engine, airplane and equipment, atmospheric conditions; and piloting technique.

(a) Best Rate of Climb Speed	88 KIAS
(b) Best Angle of Climb Speed	82 KIAS
(c) Turbulent Air Operating Speed (See Subsection 2.3)	135 KIAS
(d) Maximum Flap Speed	111 KIAS
(e) Landing Final Approach Speed (Flaps 40°) Short Field Effort	75 KIAS
(f) Intentional One Engine Inoperative Speed	82 KIAS
(g) Maximum Demonstrated Crosswind Velocity	17 KTS

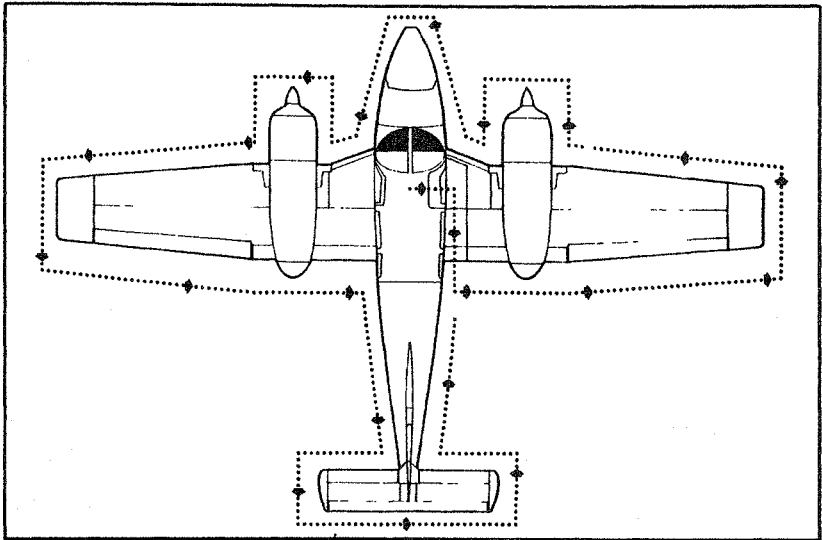

**WALK-AROUND**  
Figure 4-1

**4.5 NORMAL PROCEDURES CHECK LIST**

**PREPARATION**

- Airplane status .....airworthy, papers on board
- Weather ..... suitable
- Baggage ..... weighed, stowed, tied
- Weight and C.G. .... within limits
- Navigation ..... planned
- Charts and navigation equipment ..... on board
- Performance and range ..... computed and safe

**PREFLIGHT CHECK**

**INSIDE CABIN**

- Landing gear control ..... DOWN position
- Avionics ..... OFF



Master switch ..... ON  
Landing gear lights ..... 3 GREEN  
Fuel quantity ..... adequate plus reserve  
Cowl flaps ..... OPEN  
Master switch ..... OFF  
Ignition switches ..... OFF  
Mixture controls ..... idle cut-off  
Trim indicators ..... neutral  
Flaps ..... check operation  
Controls ..... free  
Pitot and static systems ..... drain  
Empty seats ..... fasten belts  
Emergency exit ..... closed and locked

**OUTSIDE CABIN**

Fuel sump drains ..... drain  
Right wing, aileron and flap ..... check, no ice  
Right main gear ..... no leaks  
Strut ..... proper inflation  
Tire ..... check  
Right wing tip ..... check  
Right leading edge ..... check, no ice  
Fuel cap ..... open, check quantity and  
color, secure  
Right engine nacelle ..... check oil  
Right propeller ..... check  
Cowl flaps ..... OPEN and secure  
Fuel drains ..... drain  
Nose section ..... check  
Nose gear ..... no leaks  
Strut ..... proper inflation  
Tire ..... check  
Tow bar ..... removed and stowed  
Landing light ..... check  
Windshield ..... clean  
Left wing, engine nacelle and landing gear ..... check as  
on right side  
Stall warning vanes ..... check  
Pitot/static mast ..... clear, checked  
Dorsal fin air scoop ..... clear  
Empennage ..... check, no ice  
Stabilator ..... free

Antennas ..... check  
Navigation and landing lights ..... check  
Baggage door ..... secure and locked

**BEFORE STARTING ENGINES**

Seats ..... adjusted  
Seat belts and harness ..... fasten/adjust  
check inertia reel  
Parking brake ..... set  
Circuit breakers ..... in  
Radios ..... OFF  
Cowl flaps ..... OPEN  
Carburetor heat ..... OFF  
Alternators ..... ON  
Prop sync ..... MANUAL

**STARTING ENGINES**

Fuel selector ..... ON  
Mixture ..... RICH  
Throttle ..... 1/4 inch open  
Propeller ..... FORWARD  
Master switch ..... ON  
Electric fuel pump ..... ON  
Ignition switches ..... ON  
Propeller ..... clear  
Primer ..... as required  
Starter ..... engage  
Throttle ..... adjust when engine starts  
Oil pressure ..... check  
Repeat for opposite engine.  
Alternators ..... check  
Gyro suction ..... check

**NOTE**

When starting at ambient temperatures +20° F and below, operate first engine started with alternator ON (at max charging rate not to exceed 1500 RPM) for 5 minutes minimum before initiating start on second engine.

**STARTING ENGINES IN COLD WEATHER (BELOW 10°F)**

If available, preheat should be considered. Rotate each propeller through 10 blades manually during preflight inspection.

**CAUTION**

Insure magneto and master switches are OFF and mixture controls are in idle cut-off before turning propeller manually.

Master switch ..... OFF  
External power ..... connected (See Starting Engines With External Power)  
Magnetos ..... OFF  
Electric fuel pump ..... ON  
Mixture ..... full RICH  
Propeller ..... full forward  
Throttle ..... 1/4 inch open  
Primer ..... 5-10 strokes  
Magnetos ..... ON  
Starter ..... engage  
Oil pressure ..... check  
If engine does not start, add prime and repeat above. When engine fires, pump primer as required until engine is running smoothly.  
External power ..... disconnected  
Master switch ..... ON

**STARTING ENGINES WHEN HOT**

Throttle ..... 1/2 inch open  
Master switch ..... ON  
Electric fuel pump ..... ON  
Mixture ..... full RICH  
Starter ..... engage  
Throttle ..... adjust  
Oil pressure ..... check

**STARTING ENGINES WHEN FLOODED**

Mixture ..... idle cut-off  
Throttle ..... open full  
Propeller ..... full forward  
Master switch ..... ON  
Ignition switch ..... ON  
Electric fuel pump ..... OFF  
Starter ..... engage  
Throttle ..... retard  
Mixture ..... advance  
Oil pressure ..... check

**STARTING ENGINES WITH EXTERNAL POWER**

Master switch ..... OFF  
All electrical equipment ..... OFF  
Terminals ..... connect  
External power plug ..... insert in fuselage  
Proceed with normal start.  
Throttles ..... lowest possible RPM

***WARNING***

Shutdown the right engine when it is warmed prior to disconnecting the external power plug.

External power plug ..... disconnect from fuselage  
Master switch ..... ON - check ammeter  
Oil pressure ..... check  
Right engine ..... restart

**WARM-UP**

Throttles ..... 1000 to 1200 RPM

**TAXIING**

Chocks ..... removed  
Taxi area ..... clear  
Throttle ..... apply slowly  
Brakes ..... check  
Steering ..... check  
Instruments ..... check  
Heater and defroster ..... check  
Fuel selector ..... ON, check crossfeed

**BEFORE TAKEOFF - GROUND CHECK**

Parking brake ..... ON  
Mixture controls ..... FORWARD  
Prop controls ..... FORWARD  
Prop sync ..... MANUAL  
Throttle controls ..... 1500 RPM  
Prop controls ..... check feathering,  
500 RPM max. drop  
Throttle controls ..... 2000 RPM  
Prop controls ..... check governor  
Prop controls ..... full FORWARD  
Carburetor heat ..... check  
Magnetos ..... check, max. drop  
175 RPM, max. diff.  
drop 50 RPM  
Alternator output ..... check  
Gyro suction gauge ..... 4.8 to 5.2 in. Hg.  
Throttles ..... 800-1000 RPM  
Fuel selectors ..... ON  
Electric fuel pumps ..... ON  
Alternators ..... ON  
Engine gauges ..... in the green  
Annunciator panel ..... press-to-test  
Altimeter ..... set  
Attitude indicator ..... set  
D.G. .... set  
Clock ..... wound and set  
Mixtures ..... set  
Primers ..... locked  
Propellers ..... set in forward position

Quadrant friction ..... adjusted  
Carburetor heat ..... OFF  
Cowl flaps ..... set  
Wing flaps ..... set  
Trim ..... set  
Seat backs ..... erect  
Seat belts and harness ..... fastened/adjusted  
Empty seats ..... seat belts fastened  
Controls ..... free, full travel  
Doors ..... latched  
Air conditioner ..... OFF  
Pitot heat ..... as required

**TAKEOFF**

*CAUTION*

Fast taxi turns immediately prior to takeoff run should be avoided.

Adjust mixture prior to takeoff from high elevations. Do not over heat. Adjust mixture only enough to obtain smooth engine operation.

**NORMAL TAKEOFF (Flaps up)**

Flaps ..... UP  
Accelerate to 75 KIAS.  
Control wheel ..... ease back to rotate to climb attitude  
After breaking ground, accelerate to best rate of climb speed of 88 KIAS.  
Gear ..... UP

**SHORT FIELD TAKEOFF (Flaps up)**

Flaps ..... UP  
Stabilator trim ..... takeoff range  
Brakes ..... set  
Full power before brake release.  
Accelerate to 70 KIAS.  
Control wheel ..... rotate firmly to attain 75 KIAS through 50 ft.

**SECTION 4  
NORMAL PROCEDURES**

**PIPER AIRCRAFT CORPORATION  
PA-44-180, SEMINOLE**

Accelerate to best angle of climb speed of 82 KIAS for obstacle clearance or best rate of climb speed of 88 KIAS, no obstacle.

Gear ..... UP

**SHORT FIELD TAKEOFF (25° Flaps)**

Flaps ..... 25° (second notch)

Stabilator trim ..... set

Brakes ..... set

Full power before brake release.

Accelerate to 63 KIAS.

Control wheel ..... rotate firmly to attain  
67 KIAS through 50 ft.

Gear ..... UP

**TAKEOFF CLIMB**

Best rate (flaps up) ..... 88 KIAS

Best angle (flaps up) ..... 82 KIAS

En route ..... 105 KIAS

Cowl flaps ..... as required

Electric fuel pump ..... OFF at  
desired altitude

**CRUISE CLIMB**

Mixture ..... full RICH

Power ..... 75%

Climb speed ..... 105 KIAS

Cowl flaps ..... as required

**CRUISING**

Reference performance charts and Avco-Lycoming Operator's Manual.

Power ..... set per power table

Mixture controls ..... adjust

Cowl flaps ..... as required

**DESCENT**

Mixtures ..... adjust with descent  
Throttles ..... set  
Cowl flaps ..... CLOSED

**APPROACH AND LANDING**

Gear warning horn ..... check  
Seat backs ..... erect  
Seat belts and harness ..... fasten/adjust  
Fuel selectors ..... ON  
Cowl flaps ..... as required  
Electric fuel pumps ..... ON  
Mixture controls ..... rich  
Prop sync ..... MANUAL  
Prop controls ..... full FORWARD  
Landing gear ..... DOWN, 140 KIAS max.  
Flaps ..... set, 111 KIAS max.  
Approach speed ..... 75 KIAS or above  
Air conditioner ..... OFF

**GO-AROUND**

Full takeoff power, both engines.  
Establish positive climb.  
Flaps ..... retract  
Gear ..... UP  
Cowl flaps ..... adjust

**AFTER LANDING**

Clear of runway.  
Flaps ..... retract  
Cowl flaps ..... fully OPEN  
Carburetor heat ..... OFF  
Electric fuel pump ..... OFF



**SHUTDOWN**

Radios ..... OFF  
Throttle ..... full aft  
Mixture ..... idle cut-off  
Magnetos ..... OFF  
Master switch ..... OFF

**PARKING**

Parking brake ..... set  
Control wheel ..... secured with belts  
Flaps ..... full up  
Wheel chocks ..... in place  
Tie downs ..... secure

#### **4.7 AMPLIFIED NORMAL PROCEDURES (GENERAL)**

The following paragraphs are provided to supply detailed information and explanations of the normal procedures necessary for the safe operation of the airplane.

#### **4.9 PREPARATION**

The airplane should be given a thorough preflight and walk-around check. The preflight should include a determination of the airplane's operational status, a check that necessary papers and charts are on board and in order, and a computation of weight and C.G. limits, takeoff distance and in-flight performance. Baggage should be weighed, stowed and tied down. Passengers should be briefed on the use of seat belts and shoulder harnesses, oxygen, and ventilation controls, advised when smoking is prohibited, and cautioned against handling or interfering with controls, equipment, door handles, etc. A weather briefing for the intended flight path should be obtained, and any other factors relating to a safe flight should be checked before takeoff.

#### **4.11 PREFLIGHT CHECK**

##### *CAUTION*

The flap position should be noted before boarding the airplane. The flaps must be placed in the "UP" position before they will lock and support weight on the step.

Upon entering the cockpit, check that the landing gear selector is in the DOWN position, turn OFF all avionics equipment (to save power and prevent wear on the units), and turn the master switch ON. Check the landing gear indicator lights to insure that the three green lights have illuminated and the red light has not illuminated. Check the fuel supply. Adequate fuel should be indicated for the flight plus reserve. The cowl flaps should be OPEN to facilitate inspection and ensure cooling after engine start. Return the master switch to OFF to save the battery.

Check that the ignition switches are OFF and move the mixture controls to idle cut-off to prevent an inadvertent start while checking the propellers. Move the trim controls to neutral so that the tabs can be checked for alignment. Extend and retract the flaps to check for proper operation. This check is performed prior to engine start so that you can hear any noise that might indicate binding. The controls should be free and move properly. Drain the pitot and static system lines through the drains located on the side panel next to the pilot's seat. Fasten the seat belts on the empty seats. Before leaving the cockpit, check the emergency exit for security, verifying that the emergency exit latch is locked and all components are in place.

**CAUTION**

If the emergency exit is unlatched in flight it may separate and damage the exterior of the airplane.

The first item to check during the walk-around is the fuel sumps. Drain and check for foreign matter. Check the right wing, aileron and flap hinges and surfaces for damage and ice. Make a close check of the right landing gear for leaks, proper piston exposure under a static load (2.6 inches) and that the tires are properly inflated and not excessively worn. The right wing tip and leading edge should be free from ice and damage.

Open the fuel cap to check the quantity and color of the fuel. Check fuel quantity with the calibrated dipstick provided for that purpose. For an accurate reading, the airplane should be on level ground. The cap vent should be free of obstructions. Secure the fuel cap properly. Check the oil quantity (four-to six quarts). Six quarts are required for maximum range. Secure the inspection door. Check the right propeller for nicks or leaks. The spinner should be secure and undamaged (check closely for cracks). The cowl flaps should be open and secure.

Check the nose section for damage and the nose landing gear for leaks and proper strut inflation. Under a normal static load, 2.7 inches of strut should be exposed. Check the tire for wear and proper inflation. If the tow bar was used, remove and stow. Check the condition of the landing light.

At the front of the airplane, the windshield should be clean, secure and free from cracks or distortion. Moving around to the left wing, check the wing, engine nacelle and landing gear as described for the right side. Don't forget to check the fuel and oil.

If a pitot cover was installed, it should be removed before flight and the holes checked for obstructions. With the heated pitot switch on, check the heated pitot head for proper heating. Check the stall warning vanes for freedom of movement and for damage. A squat switch in the stall warning system does not allow the units to be activated on the ground.

**CAUTION**

Care should be taken when an operational check of the heated pitot head is being performed. The unit becomes very hot. Ground operation should be limited to 3 minutes maximum to avoid damaging the heating elements.

Check the dorsal fin air scoop for obstructions. The empennage should be free of ice and damage and all hinges should be secure. Check the stabilator for freedom of movement. Antennas should be secure and undamaged. After turning on the master switch and light switches in the cockpit, check the navigation and landing lights. Check to make sure the baggage door is secured and locked.

**4.13 BEFORE STARTING ENGINES**

Before starting the engines, adjust the seats and fasten the seat belts and shoulder harnesses.

**NOTES**

If the fixed shoulder harness (non-inertia reel type) is installed, it must be connected to the seat belt and adjusted to allow proper accessibility to all controls, including fuel selectors, flaps, trim, etc. while maintaining adequate restraint for the occupant.

If the inertia reel type shoulder harness is installed, a pull test of its locking restraint feature should be performed.

Set the parking brake and check to make sure all the circuit breakers are in and the radios are OFF. Cowl flaps should be OPEN and carburetor heat OFF. The alternators should now be switched ON. Ensure prop sync is in the MANUAL position.

#### **4.15 STARTING ENGINES**

The first step in starting is to move the fuel selector to the ON position. Advance the mixture control to full RICH, open the throttle 1/4 inch and move the propeller control full FORWARD. Turn the master switch, electric fuel pump and ignition switches ON. After ensuring that the propellers are clear, prime the engine if required and engage the starter. When the engine starts, adjust the throttle and monitor the oil pressure gauge. If no oil pressure is indicated within 30 seconds, shut down the engine and have it checked. In cold weather it may take somewhat longer for an oil pressure indication. Repeat the above procedure for the opposite engine. After the engines have started, check the alternators for sufficient output and the gyro suction gauge for a reading between 4.8 and 5.2 in. Hg.

#### **NOTES**

To prevent starter damage, limit starter cranking to 30-second periods. If the engine does not start within that time, allow a cooling period of several minutes before engaging starter again. Do not engage the starter immediately after releasing it. This practice may damage the starter mechanism.

When starting at ambient temperatures +20°F and below, operate first engine started with alternator ON (at max charging rate not to exceed 1500 RPM) for 5 minutes minimum before initiating start on second engine.

#### **4.16 STARTING ENGINES IN COLD WEATHER (BELOW 10°F)**

If available, preheat should be considered. After checking that the master and magneto switches are OFF, manually rotate each engine through 10 propeller blades during the preflight inspection. Read Section 4.21 before starting with external power.

Turn the master switch OFF and connect the external power. Turn the magneto switches OFF, electric fuel pump ON, move the propeller control full forward and open the throttle 1/4 inch. Next, prime several strokes then turn the magnetos ON and engage the starter. It may be necessary to disengage the starter and prime again if the engine does not start. When the engine fires, pump the primer as required until the engine is running smoothly. Follow the instructions in Section 4.21 for removing the external power.

#### **4.17 STARTING ENGINES WHEN HOT**

If the engines are hot, open the throttle 1/2 inch. Turn ON the master switch and the electric fuel pump. Advance the mixture control to full RICH and engage the starter. When the engine starts, adjust the throttle and monitor the oil pressure gauge.

#### **4.19 STARTING ENGINES WHEN FLOODED**

If an engine is flooded, move the mixture control to idle cut-off and advance the throttle and propeller controls full forward. Turn ON the master switch and ignition switches. The electric fuel pump should be OFF. After ensuring that the propeller is clear, engage the starter. When the engine fires, retard the throttle, advance the mixture slowly and check the oil pressure.

#### **4.21 STARTING ENGINES WITH EXTERNAL POWER**

An optional feature called the Piper External Power (PEP) allows the operator to use an external battery to crank the engines without having to gain access to the airplane's battery.

Turn the master switch OFF and turn all electrical equipment OFF. Connect the RED lead of the PEP kit jumper cable to the POSITIVE (+) terminal of an external 12-volt battery and the BLACK lead to the NEGATIVE (-) terminal. Insert the plug of the jumper cable into the socket located on the fuselage. Note that when the plug is inserted, the electrical system is ON. Proceed with the normal starting technique.

After the engines have started, reduce power on the left engine to the lowest possible RPM to reduce sparking, and shut down the right engine. Disconnect the jumper cable from the aircraft. Turn the master switch ON and check the alternator ammeter for an indication of output. **DO NOT ATTEMPT FLIGHT IF THERE IS NO INDICATION OF ALTERNATOR OUTPUT** Check the oil pressure. Restart the right engine after the external power plug has been removed.

**NOTE**

For all normal operations using the PEP jumper cables, the master switch should be OFF, but it is possible to use the ship's battery in parallel by turning the master switch ON. This will give longer cranking capabilities, but will not increase the amperage.

**CAUTION**

Care should be exercised because if the ship's battery has been depleted, the external power supply can be reduced to the level of the ship's battery. This can be tested by turning the master switch ON momentarily while the starter is engaged. If cranking speed increases, the ship's battery is at a higher level than the external power supply. If the battery has been depleted by excessive cranking, it must be recharged before the second engine is started. All the alternator current will go to the low battery until it receives sufficient charge, and it may not start the other engine immediately.

#### **4.23 WARM-UP**

Warm-up the engines at 1000 to 1200 RPM. Avoid prolonged idling at low RPM, as this practice may result in fouled spark plugs.

Takeoff may be made as soon as the ground check is completed, provided that the throttles may be opened fully without backfiring or skipping and without a reduction in engine oil pressure.

Do not operate the engines at high RPM when running up or taxiing over ground containing loose stones, gravel or any loose material that may cause damage to the propeller blades.

#### **4.25 TAXIING**

Remove chocks from the wheels and check to make sure the taxi area is clear. Always apply the throttles slowly.

Before taxiing, the brakes should be checked by moving forward a few feet, throttling back and applying pressure on the toe pedals. As much as possible, turns during taxiing should be made using rudder pedal motion and differential power (more power on the engine on the outside of the turn, less on the inside engine) rather than brakes.

During the taxi, check the instruments (turn indicator, directional gyro, coordination ball, compass) and the heater and defroster. Check the operation of the fuel management controls by moving each fuel selector to CROSSFEED for a short time, while the other selector is in the ON position. Return the selectors to the ON position.

#### **4.27 BEFORE TAKEOFF - GROUND CHECK**

A thorough check should be made before takeoff, using a check list. Before advancing the throttle to check the magnetos and the propeller action, be sure that the engine oil temperature is 75° F or above.

During engine run-up, head the airplane into the wind if possible and set the parking brake. Ensure prop sync is in the MANUAL position. Advance the mixture and propeller controls forward and the throttle controls to 1500 RPM. Check the feather position of the propellers by bringing the controls fully aft and then full forward. Do not allow more than a 500 RPM drop during the feathering check. Move the throttles



to 2000 RPM and exercise the propeller controls to check the function of the governor. Retard control until a 200 to 300 drop in RPM is indicated. This should be done three times on the first flight of the day. The governor can be checked by retarding the propeller control until a drop of 100 RPM to 200 RPM appears, then advancing the throttle to get a slight increase in manifold pressure. The propeller speed should stay the same when the throttle is advanced, thus indicating proper function of the governor.

Return the propeller controls to full forward and move the carburetor heat controls to ON then OFF. Check the magnetos at 2000 RPM. The normal drop on each magneto is 100 RPM and the maximum drop should not exceed 175 RPM. The maximum differential drop should not exceed 50 RPM. If the RPM drop or engine roughness is excessive, the engines may be leaned to peak RPM for a short period. After approximately 10 seconds, the mixture should be returned to the full rich position and another mag check performed. The alternator output should be approximately equal for both alternators. A 4.8 to 5.2 in. Hg. indication on the gyro suction gauge signifies proper operation of the gyro suction system.

Set the throttles between 800 and 1000 RPM, check that the fuel selectors and alternator switches are ON and that all the engine gauges are within their normal operating ranges (green arc). Press-to-test the annunciator light to make sure they all illuminate. Set the altimeter, attitude indicator and directional gyro. Wind and set the clock. Set the mixtures, check primers locked and advance the propeller controls in the forward position. The friction lock should be adjusted. Check to make sure the carburetor heat is OFF. Adjust the cowl flaps and set the wing flaps and trim (stabilator and rudder) tabs as required. The seat backs should be erect and seat belts and harnesses fastened. Fasten the seat belts on the empty seats.

#### NOTES

If the fixed shoulder harness (non-inertia reel type) is installed, it must be connected to the seat belt and adjusted to allow proper accessibility to all controls, including fuel selectors, flaps, trim, etc., while maintaining adequate restraint for the occupant.

If the inertia reel type shoulder harness is installed, a pull test of its locking restraint feature should be performed.

All controls should be free with full travel, and all doors should be securely latched. Ensure that the electric fuel pumps are ON. Pitot heat should be used as required. Turn OFF the air conditioner to insure maximum power.

#### **4.29 TAKEOFF**

The normally recommended procedure for sea level takeoff is to advance the throttles full forward. During pretakeoff check at a high elevation, lean the mixture to obtain smooth operation. Leave the mixture in this position for takeoff. Do not overheat the engine when operating with mixture leaned. If overheating occurs, enrich the mixture enough that temperature returns to normal.

Takeoff should not be attempted with ice or frost on the wings. Takeoff distances and 50-foot obstacle clearance distances are shown on charts in the Performance Section of this Handbook. The performance shown on charts will be reduced by uphill gradient, tailwind component, or soft, wet, rough or grassy surface, or poor pilot technique.

Avoid fast turns onto the runway followed by immediate takeoff, especially with a low fuel supply. As power is applied at the start of the takeoff roll, look at the engine instruments to see that the engines are operating properly and putting out normal power and at the airspeed indicator to see that it is functioning. Apply throttle smoothly.

The flap setting for normal takeoff is 0°. In certain short field takeoff efforts when the shortest possible ground roll and the greatest clearance distance over a 50 ft. obstacle is desired, a flap setting of 25° is recommended.

When obstacle clearance is no problem, a normal flaps up (0°) takeoff may be used. Accelerate to 75 KIAS and ease back on the wheel enough to let the airplane lift off. After lift-off, accelerate to the best rate of climb speed, 88 KIAS, or higher if desired, retracting the landing gear when a gear-down landing is no longer possible on the runway.

When a short field effort is required but the situation presents a wide margin on obstacle clearance, the safest short field technique to use is with the flaps up (0°). In the event of an engine failure, the airplane is in the best flight configuration to sustain altitude immediately after the gear is raised. Set the stabilator trim indicator in the takeoff range. Set the brakes and bring the engines to full power before release. Accelerate to 70 KIAS and

rotate the airplane firmly so that the airspeed is approximately 75 KIAS when passing through the 50-foot height. The airplane should then be allowed to accelerate to the best angle of climb speed (82 KIAS at sea level) if obstacle clearance is necessary, or best rate of climb speed (88 KIAS) if obstacles are not a problem. The landing gear should be retracted when a gear-down landing is no longer possible on the runway.

When the shortest possible ground roll and the greatest clearance distance over a 50-foot obstacle is desired, use a 25-degree flap setting (second notch). Set the stabilator trim indicator slightly nose up from the take-off range. Set the brakes and bring the engines to full power before release. Accelerate to 63 KIAS and rotate firmly so that when passing through the 50-foot height the airspeed is approximately 67 KIAS. Retract the gear when a gear-down landing is no longer possible on the runway. It should also be noted that when a 25-degree flap setting is used on the takeoff roll, an effort to hold the airplane on the runway too long may result in a "wheelbarrowing" tendency. This should be avoided.

The distances required using these takeoff procedures are given on charts in the Performance Section of this Handbook.

#### **4.31 CLIMB**

On climb-out after takeoff, it is recommended that the best angle of climb speed (82 KIAS) be maintained only if obstacle clearance is a consideration. The best rate of climb speed (88 KIAS) should be maintained with full power on the engines until adequate terrain clearance is obtained. At this point, engine power should be reduced to approximately 75% power for cruise climb. A cruise climb speed of 105 KIAS or higher is also recommended. This combination of reduced power and increased climb speed provides better engine cooling, less engine wear, reduced fuel consumption, lower cabin noise level, and better forward visibility.

When reducing engine power, the throttles should be retarded first, followed by the propeller controls. The mixture controls should remain at full rich during the climb. Cowl flaps should be adjusted to maintain cylinder head and oil temperatures within the normal ranges specified for the engine. Turn the electric fuel pumps off at a safe altitude.

Consistent operational use of cruise climb power settings is strongly recommended since this practice will make a substantial contribution to fuel economy and increased engine life, and will reduce the incidence of premature engine overhauls.

### **4.33 CRUISING**

When leveling off at cruise altitude, the pilot may reduce to a cruise power setting in accordance with the Power Setting Table in this Handbook.

For maximum service life, cylinder head temperature should be maintained below 435°F during high performance cruise operation and below 400°F during economy cruise operation. If cylinder head temperatures become too high during flight, reduce them by enriching the mixture, by opening cowl flaps, by reducing power, or by use of any combination of these methods.

Following level-off for cruise, the cowl flaps should be closed or adjusted as necessary to maintain proper cylinder head temperatures, and the airplane should be trimmed to fly hands off.

The pilot should monitor weather conditions while flying and should be alert to conditions which might lead to icing. If induction system icing is expected, place the carburetor heat control in the "ON" position.

#### ***WARNING***

Flight in icing conditions is prohibited. If icing is encountered, immediate action should be taken to fly out of icing conditions. Icing is hazardous due to greatly reduced performance, loss of forward visibility, possible longitudinal control difficulties due to increased control sensitivity, and impaired power plant and fuel system operation.

The ammeters for the electrical system should be monitored during flight, especially during night or instrument flight, so that corrective measures can be taken in case of malfunction. The procedures for dealing with electrical failures are contained in the Emergency Procedure Section of this Handbook. The sooner a problem is recognized and corrective action taken, the greater is the chance of avoiding total electrical failure. Both alternator switches should be ON for normal operation. The two ammeters continuously indicate the alternator outputs. Certain regulator failures can

cause the alternator output voltage to increase uncontrollably. To prevent damage, overvoltage relays are installed to automatically shut off the alternator(s). The alternator light on the annunciator panel will illuminate to warn of the tripped condition. Alternator outputs will vary with the electrical equipment in use and the state of charge of the battery. Alternator outputs should not exceed 60 amperes.

It is not recommended to takeoff into IFR operation with a single alternator. During flight, electrical loads should be limited to 50 amperes for each alternator. Although the alternators are capable of 60 amperes output, limiting loads to 50 amperes will assure battery charging current.

Since the Seminole has one fuel tank per engine, it is advisable to feed the engines symmetrically during cruise so that approximately the same amount of fuel will be left in each side for the landing. A crossfeed is provided and can be used to even up the fuel, if necessary.

During flight, keep account of time and fuel used in connection with power settings to determine how the fuel flow and fuel quantity gauging systems are operating.

There are no mechanical uplocks in the landing gear system. In the event of a hydraulic system malfunction, the landing gear will free-fall to the gear down position. The true airspeed with gear down is approximately 75% of the gear retracted airspeed for any given power setting. Allowances for the reduction in airspeed and range should be made when planning extended flight between remote airfields or flight over water.

#### **4.35 DESCENT**

When power is reduced for descent, the mixtures should be enriched as altitude decreases. The propellers may be left at cruise setting; however if the propeller speed is reduced, it should be done after the throttles have been retarded. Cowl flaps should normally be closed to keep the engines at the proper operating temperature.

#### **4.37 APPROACH AND LANDING**

Sometime during the approach for a landing, the throttle controls should be retarded to check the gear warning horn. Flying the airplane with the horn inoperative is not advisable. Doing so can lead to a gear up landing as it is easy to forget the landing gear, especially when approaching for a one engine inoperative landing, or when other equipment is inoperative, or when attention is drawn to events outside the cabin. The red landing gear unsafe light will illuminate when the landing gear is in transition between the full up position and the down and locked position. Additionally, the light will illuminate when the gear warning horn sounds. The gear warning horn will sound at low throttle settings if the gear is not down and locked and when landing flaps are selected and the gear is not down and locked.

The light is off when the landing gear is in either the full down and locked or full up positions.

Prior to entering the traffic pattern, the aircraft should be slowed to approximately 100 KIAS, and this speed should be maintained on the downwind leg. The landing check should be made on the downwind leg. The seat backs should be erect, and the seat belts and shoulder harnesses should be fastened.

#### **NOTES**

If the fixed shoulder harness (non-inertia reel type) is installed, it must be connected to the seat belt and adjusted to allow proper accessibility to all controls, including fuel selectors, flaps, trim, etc., while maintaining adequate restraint for the occupant.

If the inertia reel type shoulder harness is installed, a pull test of its locking restraint feature should be performed.

Both fuel selectors should normally be ON, and the cowl flaps should be set as required. The electric fuel pumps should be ON. Set the mixture controls. Select landing gear DOWN and check for three green lights on the panel and look for the nose wheel in the nose wheel mirror. The landing gear should be lowered at speeds below 140 KIAS and the flaps at speeds below 111 KIAS.

Maintain a traffic pattern speed of 100 KIAS and a final approach speed of 90 KIAS. If the aircraft is lightly loaded, the final approach speed may be reduced to 80 KIAS.

When the power is reduced on close final approach, the prop sync should be in the MANUAL position and the propeller controls should be advanced to the full forward position to provide maximum power in the event of a go-around. The air conditioner should also be turned OFF to ensure maximum power.

The landing gear position should be checked on the downwind leg and again on final approach by checking the three green indicator lights on the instrument panel and looking at the external mirror to check that the nose gear is extended. Remember that when the navigation lights are on, the gear position lights are dimmed and are difficult to see in the daytime.

Flap position for landing will depend on runway length and surface wind. Full flaps will reduce stall speed during final approach and will permit contact with the runway at a slower speed. Good pattern management includes a smooth, gradual reduction of power on final approach with the power fully off before the wheels touch the runway. This gives the gear warning horn a chance to blow if the gear is not locked down. If electric trim is available, it can be used to assist a smooth back pressure during flare-out.

Maximum braking after touchdown is achieved by retracting the flaps, applying back pressure to the wheel and applying pressure on the brakes. However, unless extra braking is needed or unless a strong crosswind or gusty air condition exists, it is best to wait until turning off the runway to retract the flaps. This will permit full attention to be given to the landing and landing roll and will also prevent the pilot from accidentally reaching for the gear handle instead of the flap handle.

For a normal landing, approach with full flaps (40°) and partial power until shortly before touchdown. Hold the nose up as long as possible before and after contacting the ground with the main wheels.

Approach with full flaps at 75 KIAS for a short field landing. Immediately after touchdown, raise the flaps, apply back pressure to the wheel and apply brakes.

If a crosswind or high-wind landing is necessary, approach with higher than normal speed and with zero to 25 degrees of flaps. Immediately after touchdown, raise the flaps. During a crosswind approach hold a crab angle into the wind until ready to flare out for the landing. Then lower the wing that is into the wind to eliminate the crab angle without drifting, and use the

rudder to keep the wheels aligned with the runway. Avoid prolonged side slips with a low fuel indication.

The maximum demonstrated crosswind component for landing is 17 KTS.

#### **4.39 GO-AROUND**

If a go-around from a normal approach with the airplane in the landing configuration becomes necessary, apply takeoff power to both engines. Establish a positive climb attitude, retract the flaps and landing gear and adjust the cowl flap for adequate engine cooling.

#### **4.41 AFTER LANDING**

After leaving the runway, retract the flaps and open the cowl flaps. Test the toe brakes, a spongy pedal is often an indication that the brake fluid needs replenishing. The carburetor heat control should be OFF.

#### **4.43 SHUTDOWN**

Turn the electric fuel pumps and all radio and electrical equipment OFF. Move the throttle controls full aft and the mixture controls to idle cut-off. Turn OFF the magneto and master switches.

#### **NOTE**

The flaps must be placed in the "UP" position for the flap step to support weight. Passengers should be cautioned accordingly.

#### **4.45 PARKING**

The airplane can be moved on the ground with the aid of the optional nose wheel tow bar. Set the parking brake. The ailerons and stabilator should be secured by looping the seat belt through the control wheel and pulling it snug. The rudder need not be secured under normal conditions, as its connection to the nose wheel holds it in position. The flaps are locked when in the fully retracted position. Tie-down ropes may be attached to mooring rings under each wing and to the tail skid.



#### **4.47 TURBULENT AIR OPERATION**

In keeping with good operating practice used in all aircraft, it is recommended that when turbulent air is encountered or expected, the airspeed be reduced to maneuvering speed to reduce the structural loads caused by gusts and to allow for inadvertent speed build-ups, which may occur as a result of the turbulence or of distractions caused by the conditions. (See Subsection 2.3)

#### **4.49 VSSE - INTENTIONAL ONE ENGINE INOPERATIVE SPEED**

VSSE is a speed selected by the aircraft manufacturer as a training aid for pilots in the handling of multi-engine aircraft. It is the minimum speed for intentionally rendering one engine inoperative in flight. This minimum speed provides the margin the manufacturer recommends for use when intentionally performing engine inoperative maneuvers during training in the particular airplane.

The intentional one engine inoperative speed, VSSE, for the PA-44-180 is 82 KIAS.

#### **4.51 VMCA - AIR MINIMUM CONTROL SPEED**

VMCA is the minimum flight speed at which a twin-engine airplane is directionally controllable as determined in accordance with Federal Aviation Regulations. Airplane certification conditions include one engine becoming inoperative and windmilling; not more than a 5° bank toward the operative engine; landing gear up; flaps in takeoff position; and most rearward center of gravity.

VMCA for the PA-44-180 has been determined to be 56 KIAS and is a stalled condition.

The VMCA demonstration, which may be required for the FAA flight test for the multi-engine rating, approaches an uncontrolled flight condition with power reduced on one engine. The demonstration and all intentional one engine operations should not be performed at an altitude of less than 4000 feet above the ground. The recommended procedure for VMCA demonstration is to reduce the power to idle on the simulated inoperative engine at or above the intentional one engine inoperative speed, VSSE, and slow down approximately one knot per second until the FAA Required Demonstration Speed, VMCA, or stall warning is obtained.

VSSE is a minimum speed selected by the manufacturer for intentionally rendering one engine inoperative in flight for pilot training

VSSE for the PA-44-180 is 82 KIAS

#### VMCA DEMONSTRATION

- |   |   |
|---|---|
| (a) Landing Gear                            | UP  |
| (b) Flaps                                   | UP  |
| (c) Airspeed                                | at or above 82 KIAS (VSSE)  |
| (d) Propeller Controls                      | HIGH RPM  |
| (e) Throttle (Simulated Inoperative Engine) | IDLE  |
| (f) Throttle (Other Engine)                 | MAX ALLOWABLE   |
| (g) Airspeed                                | Reduce approximately 1 knot per second until either VMCA or STALL WARNING is obtained |

#### CAUTIONS

Use rudder to maintain directional control (heading) and ailerons to maintain 5° bank towards the operative engine (lateral attitude). At the first sign of either VMCA or stall warning (which may be evidenced by inability to maintain heading or lateral attitude, aerodynamic stall buffet, or stall warning horn) immediately initiate recovery; reduce power to idle on the operative engine, and immediately lower the nose to regain VSSE.

One engine inoperative stalls are not recommended

Under no circumstances should an attempt be made to fly at a speed below VMCA with only one engine operating

#### 4.53 STALLS

The loss of altitude during a power off stall with the gear and flaps retracted may be as much as 300 feet.

The stall warning system is inoperative with the master switch OFF.

the word "the" is not a word, it is a sentence, it is a paragraph, it is a chapter, it is a book, it is a world.

the word "the" is not a word, it is a sentence, it is a paragraph, it is a chapter, it is a book, it is a world.

the word "the" is not a word, it is a sentence, it is a paragraph, it is a chapter, it is a book, it is a world.

the word "the" is not a word, it is a sentence, it is a paragraph, it is a chapter, it is a book, it is a world.

the word "the" is not a word, it is a sentence, it is a paragraph, it is a chapter, it is a book, it is a world.

the word "the" is not a word, it is a sentence, it is a paragraph, it is a chapter, it is a book, it is a world.

the word "the" is not a word, it is a sentence, it is a paragraph, it is a chapter, it is a book, it is a world.

the word "the" is not a word, it is a sentence, it is a paragraph, it is a chapter, it is a book, it is a world.

the word "the" is not a word, it is a sentence, it is a paragraph, it is a chapter, it is a book, it is a world.

the word "the" is not a word, it is a sentence, it is a paragraph, it is a chapter, it is a book, it is a world.

the word "the" is not a word, it is a sentence, it is a paragraph, it is a chapter, it is a book, it is a world.

# TABLE OF CONTENTS

## SECTION 5

### PERFORMANCE

Paragraph No.		Page No.
5.1	General .....	5-1
5.3	Introduction - Performance and Flight Planning .....	5-1
5.5	Flight Planning Example .....	5-3
5.7	Performance Graphs .....	5-9
	List of Figures .....	5-9



**SECTION 5  
PERFORMANCE**

**5.1 GENERAL**

All of the required (FAA regulations) and complementary performance information applicable to this aircraft is provided by this section.

Performance information associated with those optional systems and equipment which require handbook supplements is provided by Section 9 (Supplements).

All data given is for both two and three blade propellers unless otherwise noted.

**5.3 INTRODUCTION - PERFORMANCE AND FLIGHT PLANNING**

The performance information presented in this section is based on measured Flight Test Data corrected to I.C.A.O. standard day conditions and analytically expanded for the various parameters of weight, altitude, temperature, etc.

The performance charts are unfactored and do not make any allowance for varying degrees of pilot proficiency or mechanical deterioration of the aircraft. This performance, however, can be duplicated by following the stated procedures in a properly maintained airplane.

Effects of conditions not considered on the charts must be evaluated by the pilot, such as the effect of soft or grass runway surface on takeoff and landing performance, or the effect of winds aloft on cruise and range performance. Endurance can be grossly affected by improper leaning procedures, and inflight fuel flow and quantity checks are recommended.

**REMEMBER!** To get chart performance, follow the chart procedures.

The information provided by paragraph 5.5 (Flight Planning Example) outlines a detailed flight plan using the performance charts in this section. Each chart includes its own example to show how it is used.

***WARNING***

Performance information derived by extrapolation beyond the limits shown on the charts should not be used for flight planning purposes.

## **5.5 FLIGHT PLANNING EXAMPLE**

### **(a) Aircraft Loading**

The first step in planning a flight is to calculate the airplane weight and center of gravity by utilizing the information provided by Section 6 (Weight and Balance) of this handbook.

The basic empty weight for the airplane as delivered from the factory has been centered in Figure 6-5. If any alterations to the airplane have been made affecting weight and balance, reference to the aircraft logbook and Weight and Balance Record (Figure 6-7) should be made to determine the current basic empty weight of the airplane.

Make use of the Weight and Balance Loading Form (Figure 6-11) and the C.G. Range and Weight graph (Figure 6-15) to determine the total weight of the airplane and the center of gravity position.

After proper utilization of the information provided, the following weights have been found for consideration in the flight planning example.

The landing weight cannot be determined until the weight of the fuel to be used has been established [refer to item (g)(1)].

(1) Basic Empty Weight	2583 lbs.
(2) Occupants (2 x 170 lbs.)	340 lbs.
(3) Baggage and Cargo	27 lbs.
(4) Fuel (6 lb./gal. x 80)	480 lbs.
(5) Takeoff Weight (3800 lb. max. allowable)	3430 lbs.
(6) Landing Weight	
(a)(5) minus (g)(1), (3430 lbs. minus 311.4 lbs.)	3119 lbs.

Takeoff and landing weights are below the maximums, and the weight and balance calculations have determined the C.G. position within the approved limits.

### **(b) Takeoff and Landing**

Now that the aircraft loading has been determined, all aspects of the takeoff and landing must be considered.



All of the existing conditions at the departure and destination airport must be acquired, evaluated and maintained throughout the flight.

Apply the departure airport conditions and takeoff weight to the appropriate Takeoff Performance and Accelerate and Stop Distance graphs (Figures 5-5 thru 5-19) to determine the length of runway necessary for the takeoff and/or the barrier distance.

The landing distance calculations are performed in the same manner using the existing conditions at the destination airport and, when established, the landing weight.

The conditions and calculations for the example flight are listed below. The takeoff and landing distances required for the example flight have fallen well below the available runway lengths.

	Departure Airport	Destination Airport
(1) Pressure Altitude	680 ft.	680 ft.
(2) Temperature	8°C	8°C
(3) Wind Component	5 KTS	6 KTS
	(Headwind)	(Headwind)
(4) Runway Length Available	7400 ft.	9000 ft.
(5) Runway Required (Normal Procedure, Std. Brakes)		
Takeoff	1750 ft.*	
Accelerate and Stop	2050 ft.**	
Landing		1200***

**NOTE**

The remainder of the performance charts used in this flight plan example assume a no wind condition. The effect of winds aloft must be considered by the pilot when computing climb, cruise and descent performance.

\*reference Figure 5-11

\*\*reference Figure 5-5

\*\*\*reference Figure 5-45

(c) Climb

The next step in the flight plan is to determine the necessary climb segment components.

The desired cruise pressure altitude and corresponding cruise outside air temperature values are the first variables to be considered in determining the climb components from the Fuel, Time and Distance to Climb graph (Figure 5-27). After the fuel, time and distance for the cruise pressure altitude and outside air temperature values have been established, apply the existing conditions at the departure field to graph (Figure 5-27). Now, subtract the values obtained from the graph for the field of departure conditions from those for the cruise pressure altitude.

The remaining values are the true fuel, time and distance components for the climb segment of the flight plan corrected for field pressure altitude and temperature.

The following values were determined from the above instructions in the flight planning example.

- |  |                  |
|--|------------------|
| (1) Cruise Pressure Altitude                                   | 5500 ft.         |
| (2) Cruise OAT   | -2°C             |
| (3) Time to Climb (4.5 min. minus 1.2 min.)                    | 3.3 min.*        |
| (4) Distance to Climb (7 naut. miles<br>minus 1.4 naut. miles) | 5.6 naut. miles* |
| (5) Fuel to Climb (2.5 gal. minus 1.0 gal.)                    | 1.5 gal.*        |

(d) Descent

The descent data will be determined prior to the cruise data to provide the descent distance for establishing the total cruise distance.

Utilizing the cruise pressure altitude and OAT determine the basic fuel, time and distance for descent (Figure 5-41) These figures must be adjusted for the field pressure altitude and temperature at the destination airport. To find the necessary adjustment values, use the existing pressure altitude and temperature conditions at the destination airport as variables to find the fuel, time and distance

\*reference Figure 5-27

values from the graph (Figure 5-41). Now, subtract the values obtained from the field conditions from the values obtained from the cruise conditions to find the true fuel, time and distance values needed for the flight plan.

The values obtained by proper utilization of the graphs for the descent segment of the example are shown below.

- |  |                 |
|--|-----------------|
| (1) Time to Descend<br>(9 min. minus 2 min.)                       | 7 min.*         |
| (2) Distance to Descend<br>(30 naut. miles minus<br>4 naut. miles) | 26 naut. miles* |
| (3) Fuel to Descend<br>(3 gal. minus 1 gal.)                       | 2 gal.*         |

(e) Cruise

Using the total distance to be traveled during the flight, subtract the previously calculated distance to climb and distance to descend to establish the total cruise distance. Refer to the appropriate Lycoming Operator's Manual and the Power Setting Tables when selecting the cruise power setting. The established pressure altitude and temperature values and the selected cruise power should now be utilized to determine the true airspeed from the Speed Power graph (Figure 5-31).

Calculate the cruise fuel for the cruise power setting from the information provided on Figure 5-31.

The cruise time is found by dividing the cruise distance by the cruise speed and the cruise fuel is found by multiplying the cruise fuel flow by the cruise time.

The cruise calculations established for the cruise segment of the flight planning example are as follows:

- |   |                   |
|---|-------------------|
| (1) Total Distance  | 394 miles         |
| (2) Cruise Distance<br>(e)(1) minus (c)(4) minus (d)(2),<br>(394 naut. miles minus 5.6 naut.<br>miles minus 26 naut. miles) | 362.4 naut. miles |

\*reference Figure 5-41

- |  |                 |
|--|-----------------|
| (3) Cruise Power (Best Power Mixture)                            | 55% rated power |
| (4) Cruise Speed   | 138 KTS TAS*    |
| (5) Cruise Fuel Consumption                                      | 18.6 GPH*       |
| (6) Cruise Time  |                 |
| (e)(2) divided by (e)(4), (362.4 naut. miles divided by 138 KTS) | 2.6 hrs.        |
| (7) Cruise Fuel  |                 |
| (e)(5) multiplied by (e)(6), (18.6 GPH multiplied by 2.6 hrs.)   | 48.4 gal.       |

**(f) Total Flight Time**

The total flight time is determined by adding the time to climb, the time to descend and the cruise time. Remember! The time values taken from the climb and descent graphs are in minutes and must be converted to hours before adding them to the cruise time.

The following flight time is required for the flight planning example.

- |  |           |
|--|-----------|
| (1) Total Flight Time  |           |
| (c)(3) plus (d)(1) plus (e)(6),<br>(0.06 hrs. plus .12 hrs. plus 2.6 hrs.) | 2.78 hrs. |

**(g) Total Fuel Required**

Determine the total fuel required by adding the fuel to climb, the fuel to descend and the cruise fuel. When the total fuel (in gallons) is determined, multiply this value by 6 lb./gal. to determine the total fuel weight used for the flight.

The total fuel calculations for the example flight plan are shown below.

- |  |                         |
|--|-------------------------|
| (1) Total Fuel Required  |                         |
| (c)(5) plus (d)(3) plus (e)(7),<br>(1.5 gal. plus 2.0 gal. plus 48.4 gal.)<br>(51.9 gal. multiplied by 6 lb./gal.) | 51.9 gal.<br>311.4 lbs. |

\*reference Figure 5-31

**THIS PAGE INTENTIONALLY LEFT BLANK**

**5.7 PERFORMANCE GRAPHS**

**LIST OF FIGURES**

<b>Figure No.</b>		<b>Page No.</b>
5-1	Airspeed Calibration .....	5-11
5-3	Stall Speed Vs. Angle of Bank .....	5-12
5-5	Normal Procedure - Accelerate and Stop Distance .....	5-13
5-7	Short Field Accelerate and Stop Distance .....	5-14
5-9	Normal Procedure Takeoff Ground Roll (0° Flaps) .....	5-15
5-11	Normal Procedure Takeoff Distance Over 50 Ft. Barrier (0° Flaps) .....	5-16
5-13	Short Field Effort Takeoff Ground Roll (0° Flaps) .....	5-17
5-15	Short Field Effort Takeoff Distance Over 50 Ft. Barrier (0° Flaps) .....	5-18
5-17	Short Field Effort Takeoff Ground Roll (25° Flaps) .....	5-19
5-19	Short Field Effort Takeoff Distance Over 50 Ft. Barrier (25° Flaps) .....	5-20
5-21	Climb Performance - Both Engines Operating - Gear Down .....	5-21
5-23	Climb Performance - Both Engines Operating - Gear Up .....	5-22
5-25	Climb Performance - One Engine Operating - Gear Up .....	5-23
5-27	Fuel, Time and Distance to Climb .....	5-24
5-29	Power Setting Table .....	5-25
5-31	Speed Power .....	5-26
5-33	Standard Temperature Performance Cruise Range .....	5-27
5-35	Standard Temperature Economy Cruise Range .....	5-28
5-37	Performance Cruise Endurance .....	5-29
5-39	Economy Cruise Endurance .....	5-30
5-41	Fuel, Time and Distance to Descend .....	5-31
5-43	Landing Ground Roll .....	5-32
5-45	Landing Distance Over 50 Ft. Barrier .....	5-33

**THIS PAGE INTENTIONALLY LEFT BLANK**

# PA-44-180

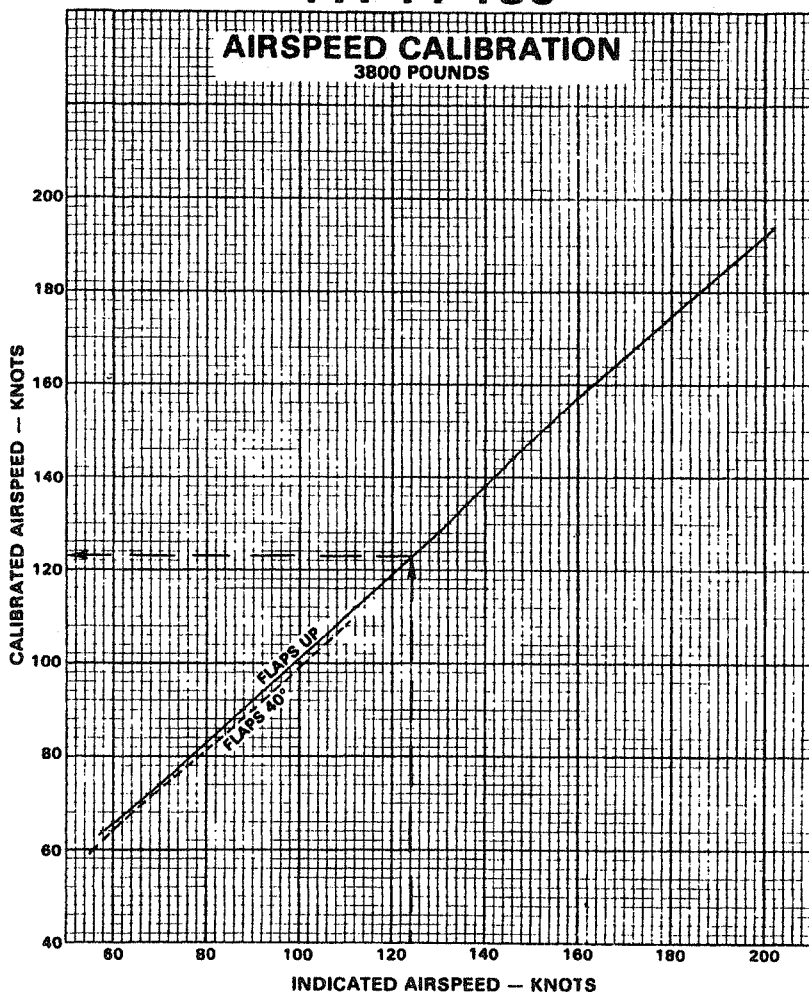

AIRSPEED CALIBRATION  
Figure 5-1



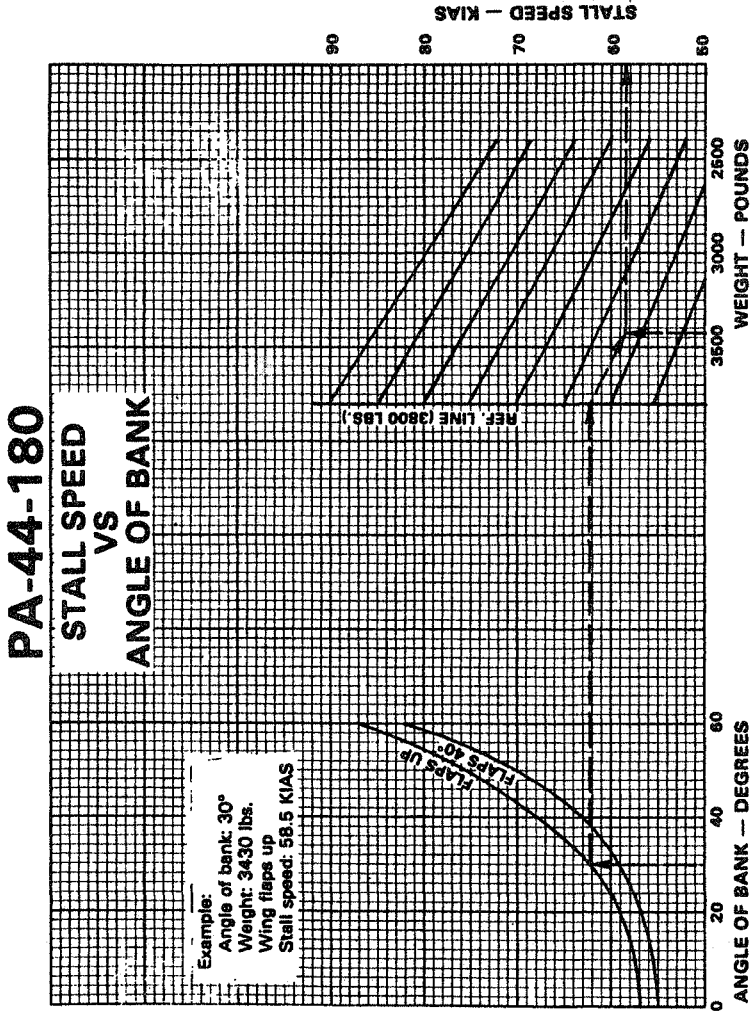

STALL SPEED VS. ANGLE OF BANK

Figure 5-3

# PA-44-180

## NORMAL PROCEDURE — ACCELERATE AND STOP DISTANCE \*STANDARD BRAKES

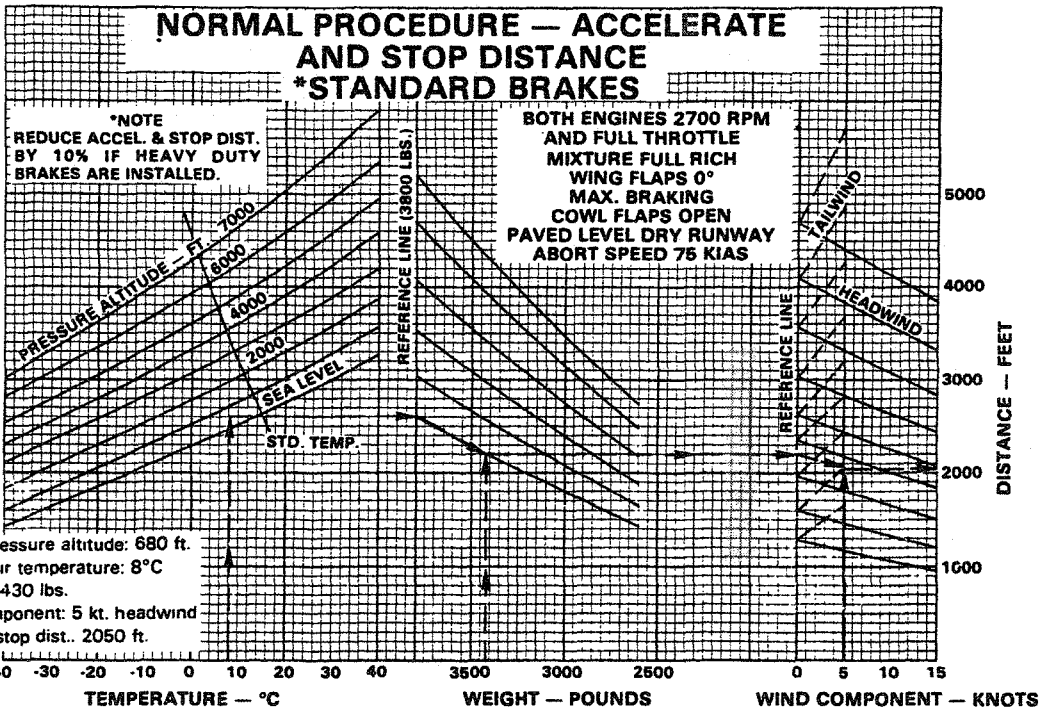

NORMAL PROCEDURE - ACCELERATE AND STOP DISTANCE  
Figure 5-5

# PA-44-180

## SHORT FIELD ACCELERATE AND STOP DISTANCE \*STANDARD BRAKES

BOTH ENGINES 2700 RPM & FULL THROTTLE  
MIXTURE FULL RICH  
WING FLAPS 0° - ABORT SPEED 70 KIAS OR  
WING FLAPS 25° - ABORT SPEED 63 KIAS  
COWL FLAPS OPEN  
PAVED LEVEL DRY RUNWAY  
MAXIMUM BRAKING

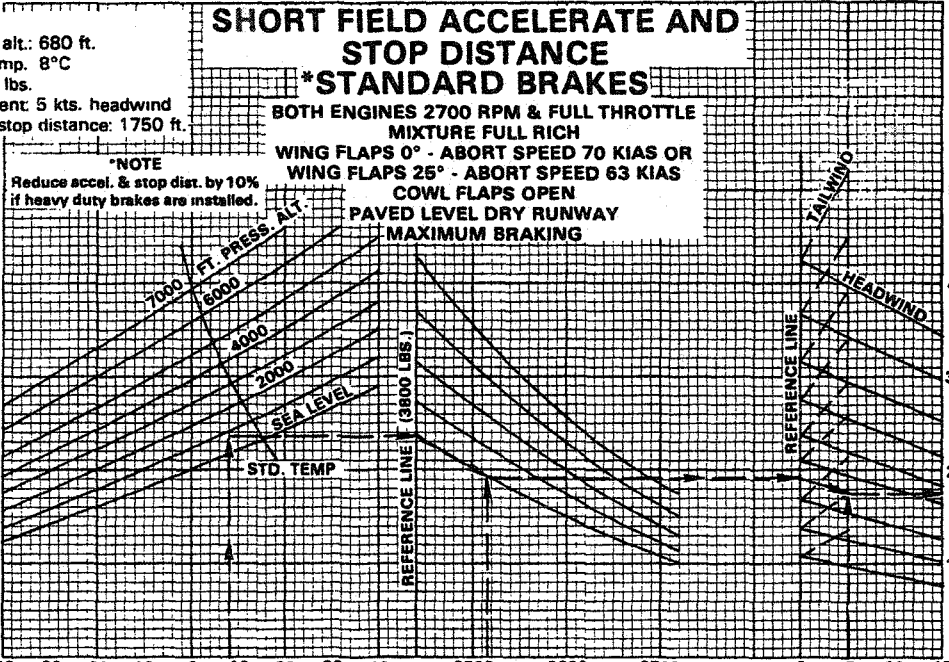

\*NOTE  
Reduce accel. & stop dist. by 10%  
if heavy duty brakes are installed.

Example:  
Airport press. alt.: 680 ft.  
Outside air temp. 8°C  
Weight: 3430 lbs.  
Wind component: 5 kts. headwind  
Accelerate & stop distance: 1750 ft.

SHORT FIELD ACCELERATE AND STOP DISTANCE

Figure 5-7

# PA-44-180

## NORMAL PROCEDURE TAKEOFF GROUND ROLL

WING FLAPS 0°  
2700 RPM & FULL THROTTLE BEFORE BRAKE RELEASE  
PAVED LEVEL DRY RUNWAY  
COWL FLAPS OPEN

Example:  
Airport press. alt.: 680 ft.  
Outside air temp.: 8°C  
Wind component: 6 kt. headwind  
Weight: 3430 lbs.  
Takeoff ground roll: 920 ft.

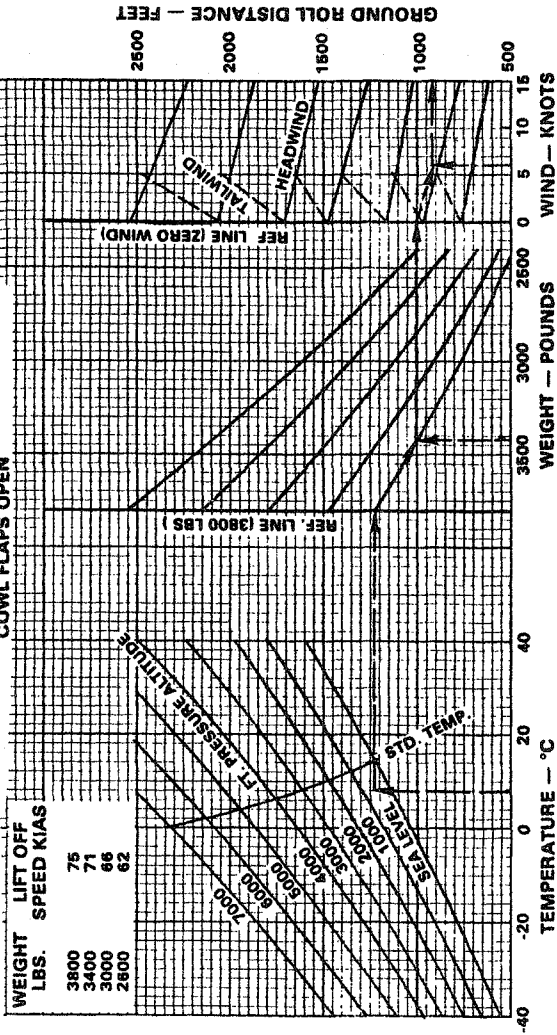

NORMAL PROCEDURE TAKEOFF GROUND ROLL (0° FLAPS)

Figure 5-9

# PA-44-180

## NORMAL PROCEDURE TAKEOFF DISTANCE OVER 50 FT. BARRIER

2700 RPM & FULL THROTTLE BEFORE BRAKE RELEASE

WING FLAPS 0°

PAVED LEVEL DRY RUNWAY

WEIGHT POUNDS	LIFT OFF SPEED KIAS	BARRIER SPEED KIAS
3800	76	88
3400	71	83
3000	66	78
2600	62	73

**CAUTION**  
Best one engine in-  
operative rate of  
climb is less than 50  
FPM if T.O. wt. is in  
the shaded area.

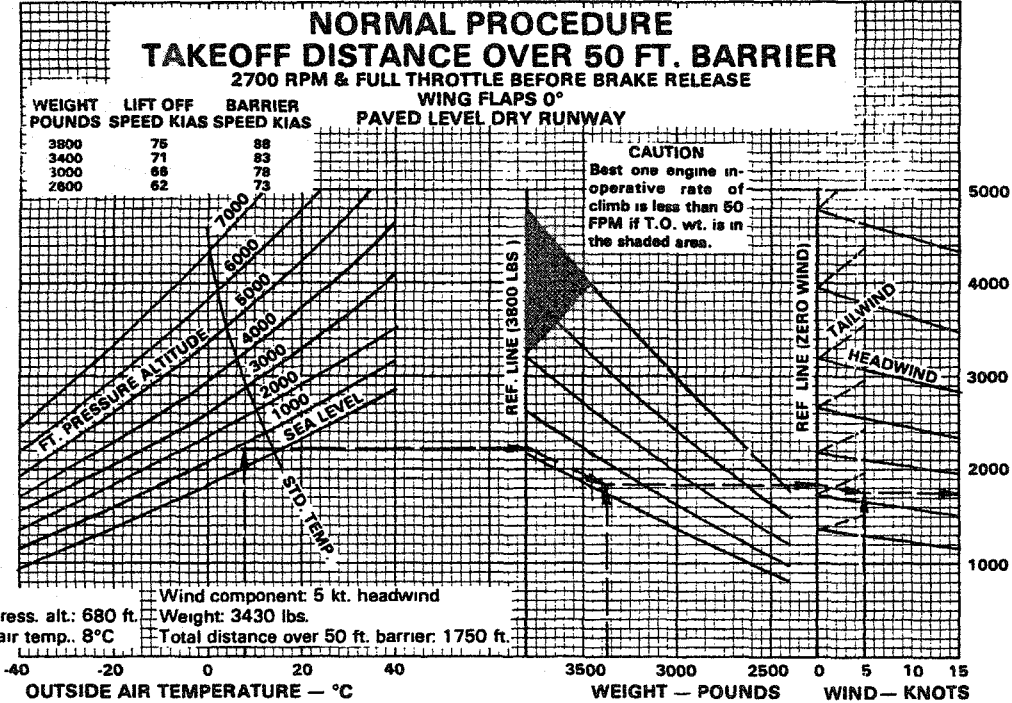

TAKEOFF DISTANCE OVER 50 FT. BARRIER — FEET

NORMAL PROCEDURE TAKEOFF DISTANCE OVER 50 FT.  
BARRIER (0° FLAPS)

Figure 5-11

# PA-44-180

## SHORT FIELD EFFORT TAKEOFF GROUND ROLL

WING FLAPS 0°

2700 RPM & FULL THROTTLE BEFORE BRAKE RELEASE

PAVED LEVEL DRY RUNWAY

COWL FLAPS OPEN

Example:

Airport press. alt.: 680 ft.

Outside air temp.: 8°C

Wind component: 6 kt. headwind

Weight: 3430 lbs.

Total ground roll distance: 800 ft.

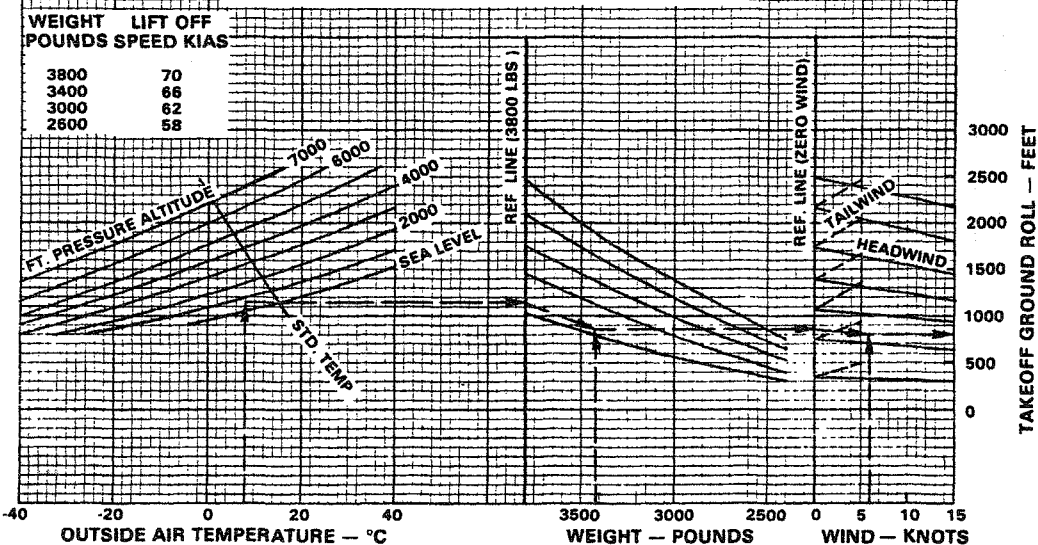

SHORT FIELD EFFORT TAKEOFF GROUND ROLL (0° FLAPS)  
Figure 5-13

ISSUED: MARCH 23, 1978

REPORT: VB-860  
5-17

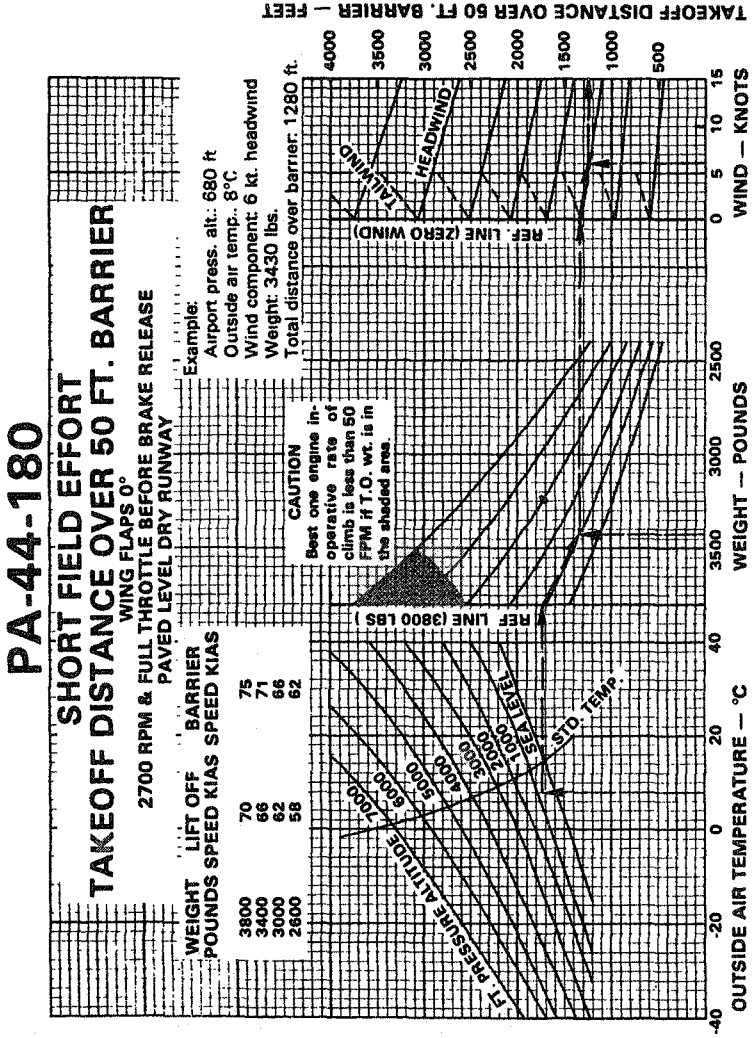

SHORT FIELD EFFORT TAKEOFF DISTANCE OVER 50 FT.  
BARRIER (0° FLAPS)

Figure 5-15

# PA-44-180

## SHORT FIELD EFFORT TAKEOFF GROUND ROLL

2700 RPM & FULL THROTTLE BEFORE BRAKE RELEASE  
WING FLAPS - 25° COWL FLAPS OPEN  
PAVED LEVEL DRY RUNWAY

Example:

Airport press. alt.: 680 ft.

Outside air temp.: 8°C

Wind component: 6 kt. headwind

Weight: 3430 lbs.

Total ground roll: 660 ft.

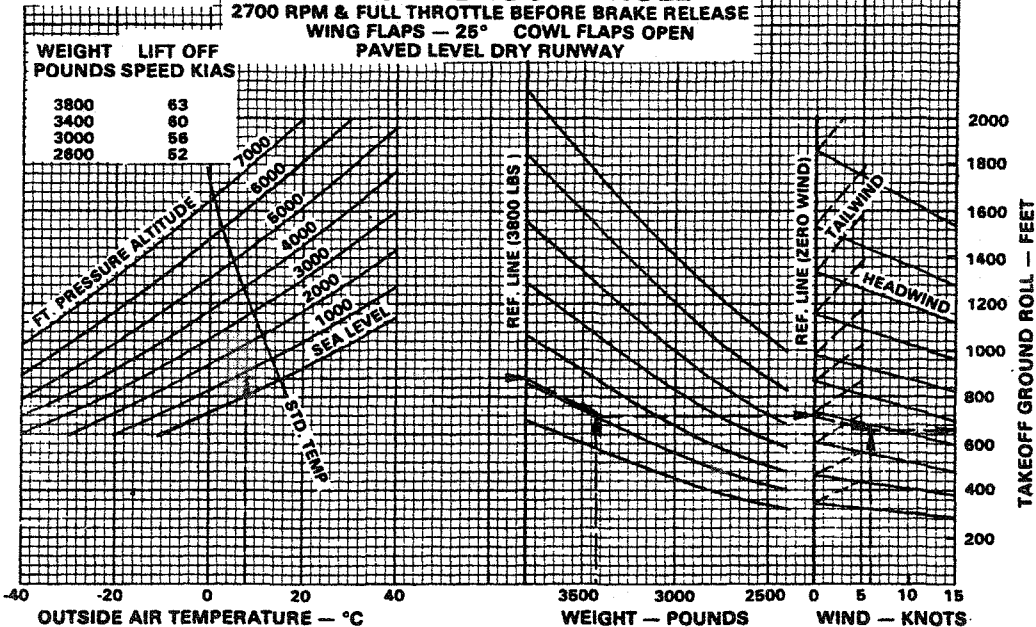

SHORT FIELD EFFORT TAKEOFF GROUND ROLL (25° FLAPS)

Figure 5-17

ISSUED: MARCH 23, 1978

REPORT: VB-860  
5-19



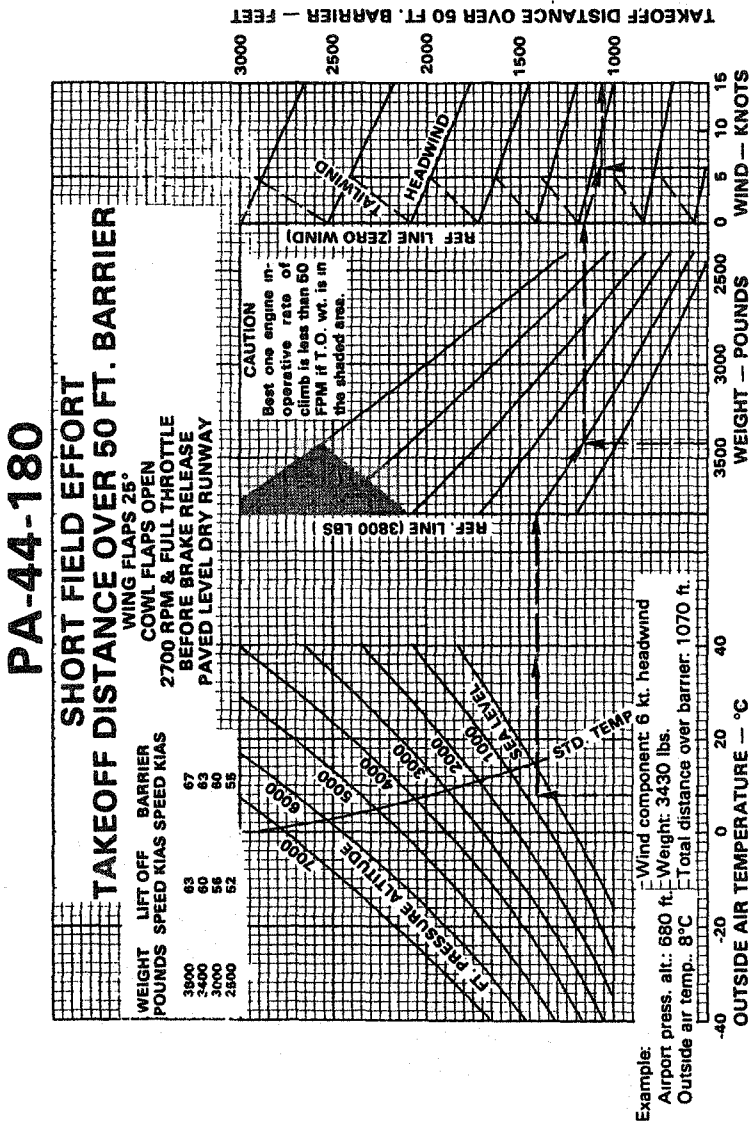

SHORT FIELD EFFORT TAKEOFF DISTANCE OVER 50 FT. BARRIER (25° FLAPS)

Figure 5-19

PA-44-180

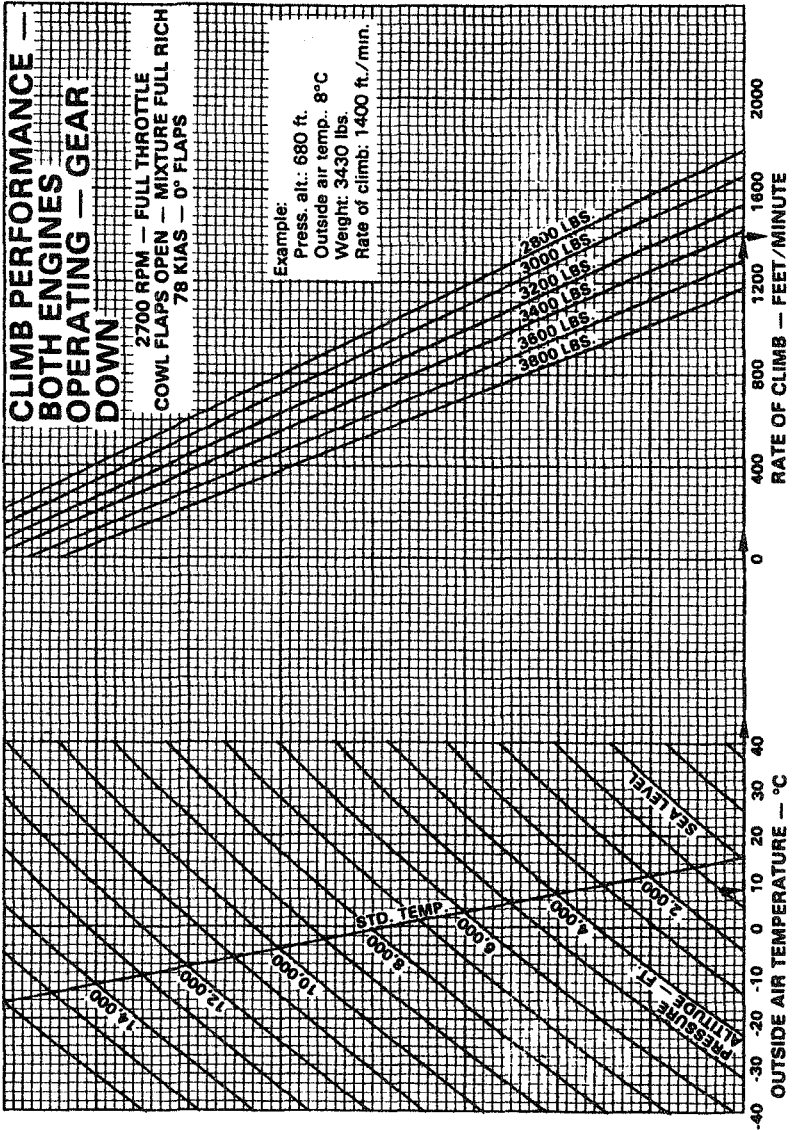

CLIMB PERFORMANCE - BOTH ENGINES OPERATING -  
GEAR DOWN  
Figure 5-21

# PA-44-180

## CLIMB PERFORMANCE — BOTH ENGINES OPERATING — GEAR UP

2700 RPM & FULL THROTTLE  
BOTH ENGINES  
COWL FLAPS OPEN - WING FLAPS 0°  
MIXTURE FULL RICH ABOVE 75%  
POWER & BEST POWER MIXTURE  
BELOW 75% POWER  
88 KIAS

BEST POWER MIXTURE LEANED 25°F  
RICH OF PEAK E.G.T.

Example:  
Press. alt., 680 ft.  
Outside air temp., 8°C  
Weight: 3430 lbs.  
Rate of climb: 1570 ft./min.

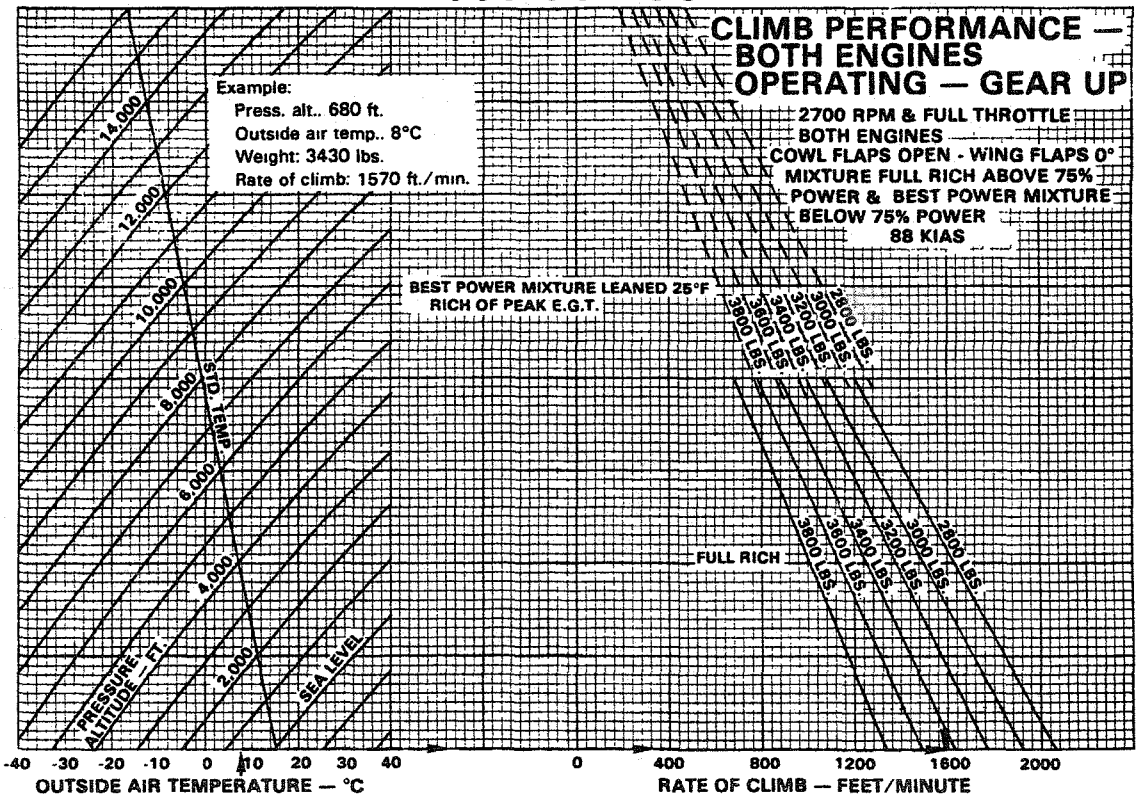

CLIMB PERFORMANCE - BOTH ENGINES OPERATING -  
GEAR UP  
Figure 5-23

# PA-44-180

## CLIMB PERFORMANCE ONE ENGINE OPERATING GEAR UP

2700 RPM — FULL THROTTLE  
COWL FLAP — OPEN  
(OPERATING ENGINE)  
COWL FLAP — CLOSED  
(INOPERATIVE ENGINE)  
MIXTURE — FULL RICH  
ABOVE 75% POWER  
MIXTURE — BEST  
POWER BELOW  
75% POWER  
PROP FEATHERED ON  
INOPERATIVE ENGINE  
88 KIAS — 0° FLAPS  
3° - 5° BANK TOWARD  
OPERATIVE ENGINE

Example:  
Press. alt. 680 ft.  
Outside air temp. 8°C  
Weight: 3430 lbs.  
Rate of climb: 340 ft./min.

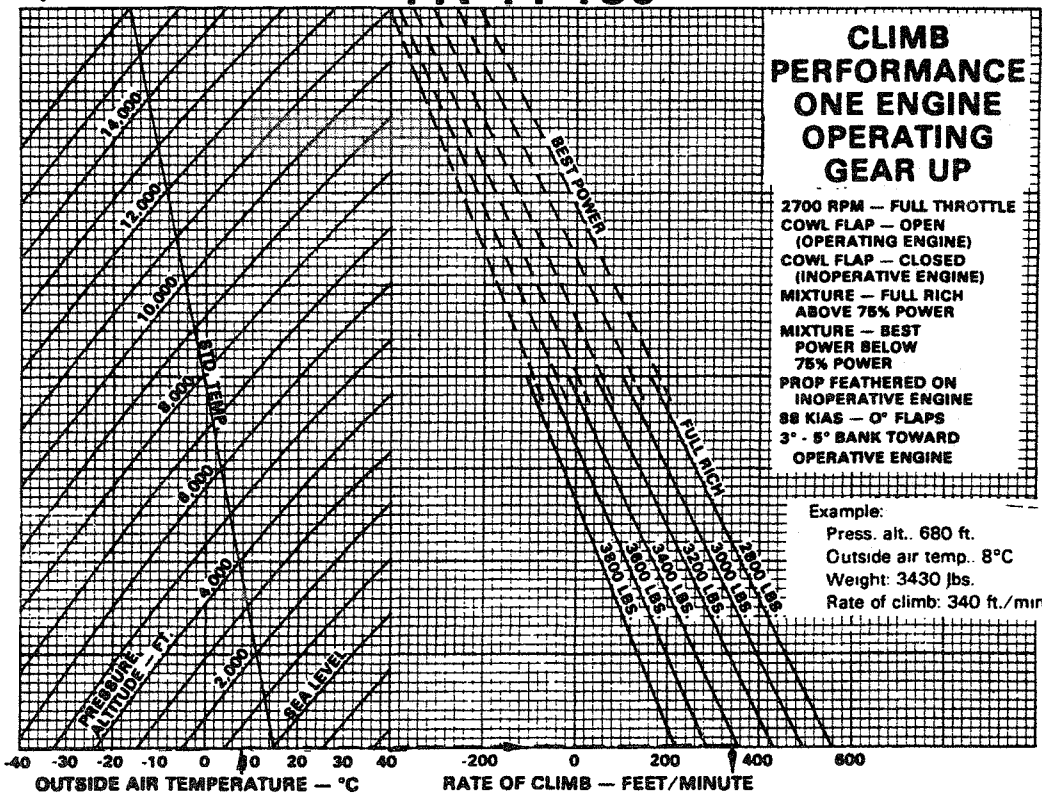

CLIMB PERFORMANCE - ONE ENGINE OPERATING - GEAR UP  
Figure 5-25

ISSUED: MARCH 23, 1978  
REVISED: APRIL 10, 1981

REPORT: VB-860  
5-23

# PA-44-180

## FUEL, TIME AND DISTANCE TO CLIMB

BOTH ENGINES 2700 RPM & FULL THROTTLE WING FLAPS 0° — COWL FLAPS OPEN  
LANDING GEAR RETRACTED CLIMB SPEED 88 KIAS  
NO WIND

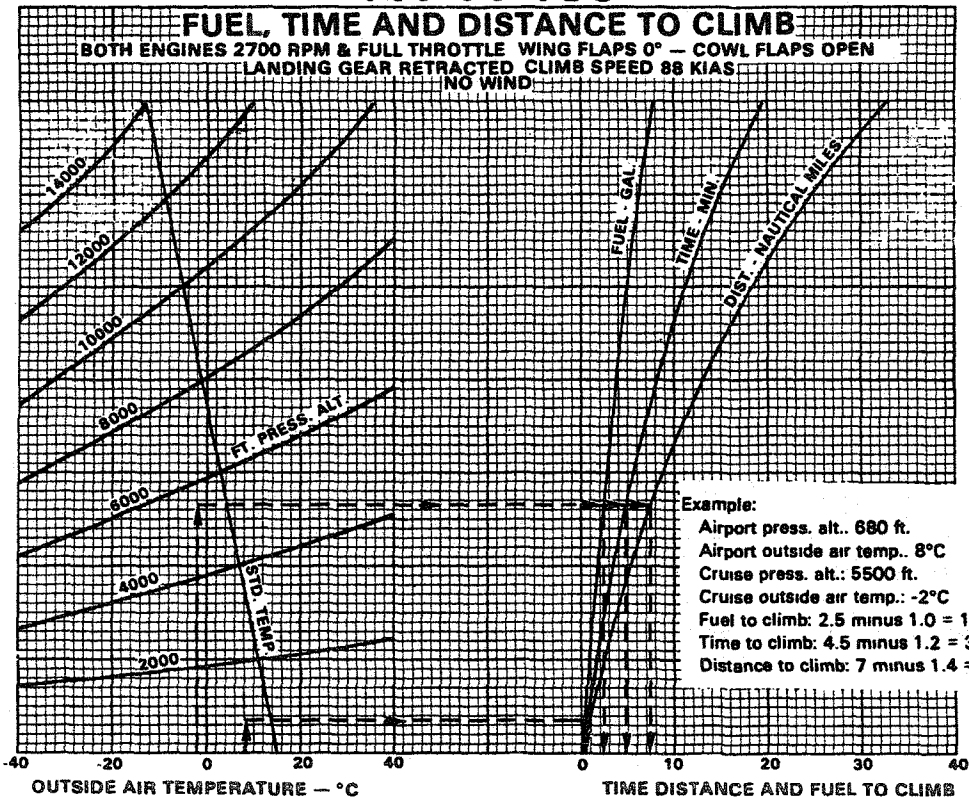

FUEL, TIME AND DISTANCE TO CLIMB

Figure 5-27

FUEL AND POWER CHART - LYCOMING (L) O-360-E SERIES (PER ENGINE)

Press. Alt. Feet	Std. Alt. Temp. °C	99 BHP - 55% Rated Power Approx. Fuel Flow-9.3 Gal/Hr.* RPM AND MAN. PRESS.				117 BHP - 65% Rated Power Approx. Fuel Flow-10.3 Gal/Hr.* RPM AND MAN. PRESS.				135 BHP - 75% Rated Power Approx. Fuel Flow-11.2 Gal/Hr.* RPM AND MAN. PRESS.			Press. Alt. Feet
		2100	2200	2300	2400	2100	2200	2300	2400	2200	2300	2400	
		SL	15	22.2	21.7	21.2	20.7	24.5	24.0	23.4	22.9	26.4	
1000	13	21.9	21.4	21.0	20.4	24.2	23.7	23.1	22.6	26.1	25.5	24.9	1000
2000	11	21.6	21.1	20.7	20.2	23.9	23.4	22.9	22.3	25.8	25.2	24.6	2000
3000	9	21.3	20.8	20.4	19.9	23.6	23.1	22.6	22.1	25.4	24.9	24.4	3000
4000	7	21.0	20.6	20.1	19.7	23.2	22.7	22.3	21.8	FT	24.7	24.1	4000
5000	5	20.8	20.3	19.9	19.4	22.9	22.4	22.0	21.5	—	FT	23.8	5000
6000	3	20.5	20.2	19.6	19.2	22.6	22.1	21.7	21.3	—	—	FT	6000
7000	1	20.2	19.7	19.3	18.9	FT	21.8	21.5	21.0	—	—	—	7000
8000	-1	19.9	19.5	19.1	18.6	—	FT	21.2	20.7	—	—	—	8000
9000	-3	19.6	19.2	18.8	18.4	—	—	FT	20.5	—	—	—	9000
10,000	-5	19.3	18.9	18.5	18.1	—	—	—	FT	—	—	—	10,000
11,000	-7	FT	18.6	18.3	17.9	—	—	—	—	—	—	—	11,000
12,000	-9	—	FT	18.0	17.6	—	—	—	—	—	—	—	12,000
13,000	-11	—	—	FT	17.4	—	—	—	—	—	—	—	13,000
14,000	-13	—	—	—	FT	—	—	—	—	—	—	—	14,000

NOTE: To maintain constant power, add approximately 1% manifold pressure for each 6°C above standard, subtract approximately 1% for each 6°C below standard.

\*Best Power

POWER SETTING TABLE  
Figure 5-29

# PA-44-180

## SPEED POWER

MID CRUISE WEIGHT 3483 LBS.  
COWL FLAPS CLOSED, WING FLAPS UP  
LANDING GEAR RETRACTED

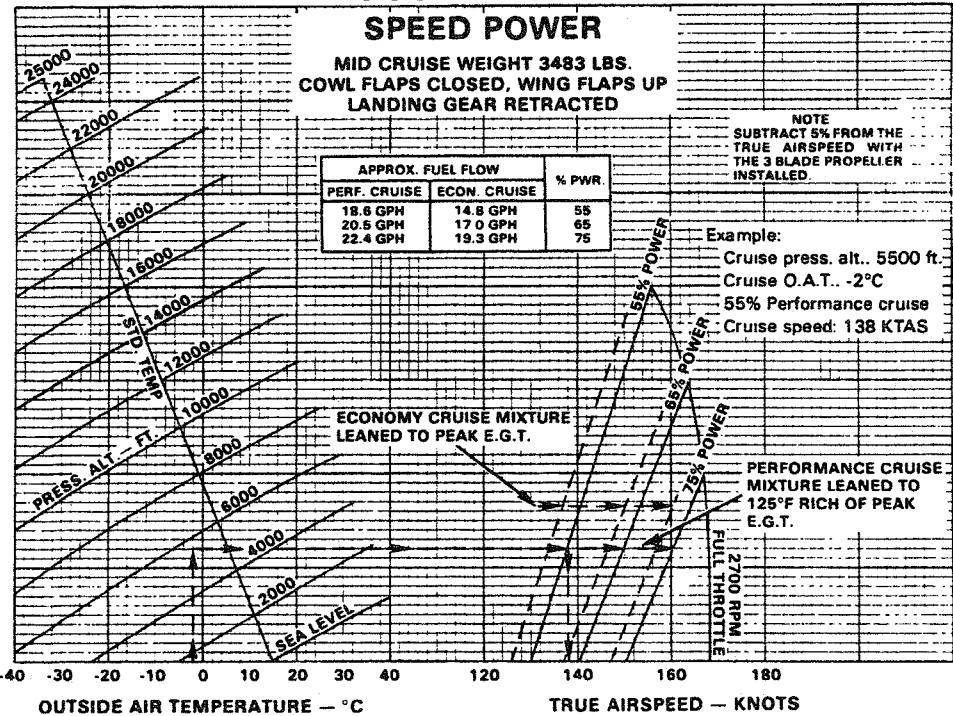

SPEED POWER  
Figure 5-31

# PA-44-180

## STANDARD TEMPERATURE PERFORMANCE CRUISE RANGE

MIXTURE LEANED TO 125° F RICH OF PEAK E.G.T.  
3800 POUNDS - 108 GAL. USABLE FUEL

NO WIND

SUBTRACT 5% FROM THE RANGE  
WITH THE 3 BLADE PROP INSTALLATION.

NOTE:  
ADD ONE NAUTICAL MILE FOR  
EACH DEGREE CENTIGRADE  
ABOVE STANDARD AND SUB-  
TRACT 1.5 NAUTICAL MILES  
FOR EACH DEGREE CENTI-  
GRADE BELOW STANDARD.  
EXAMPLE:  
CRUISE PRESS. ALT. = 5500 ft.  
O.A.T. = -2°C (8° BELOW STD.)  
POWER = 55%  
RANGE W/RESERVE = 702 (1.5x6)  
RANGE W/RESERVE = 693 N.M.  
RANGE W/NO RES. = 785 (1.5x6)  
RANGE W/NO RES. = 776 N.M.

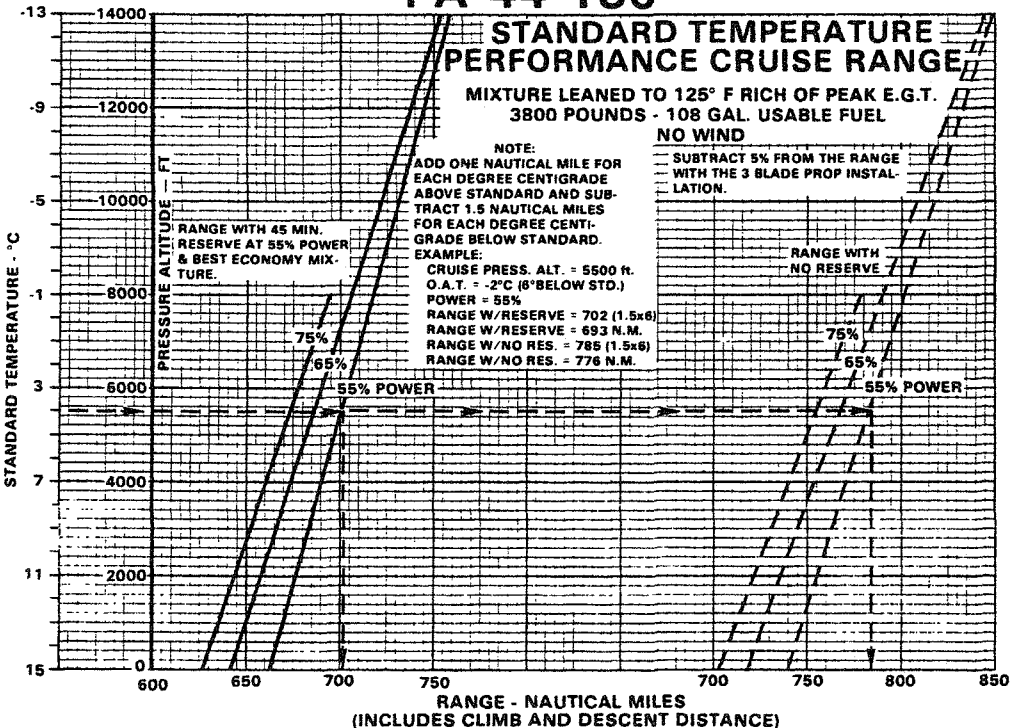

### STANDARD TEMPERATURE PERFORMANCE CRUISE RANGE

Figure 5-33



# PA-44-180

## STANDARD TEMPERATURE ECONOMY CRUISE RANGE

MIXTURE LEANED TO PEAK E.G.T.  
3800 POUNDS - 108 GAL. USABLE FUEL  
NO WIND

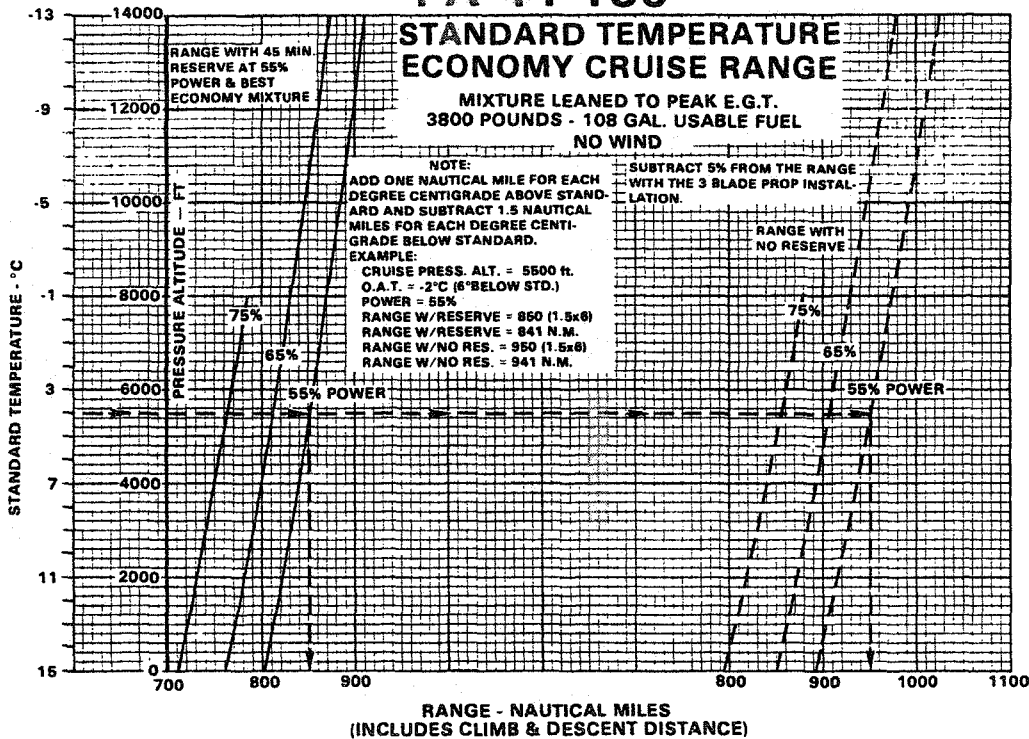

STANDARD TEMPERATURE  
ECONOMY CRUISE RANGE

Figure 5-35

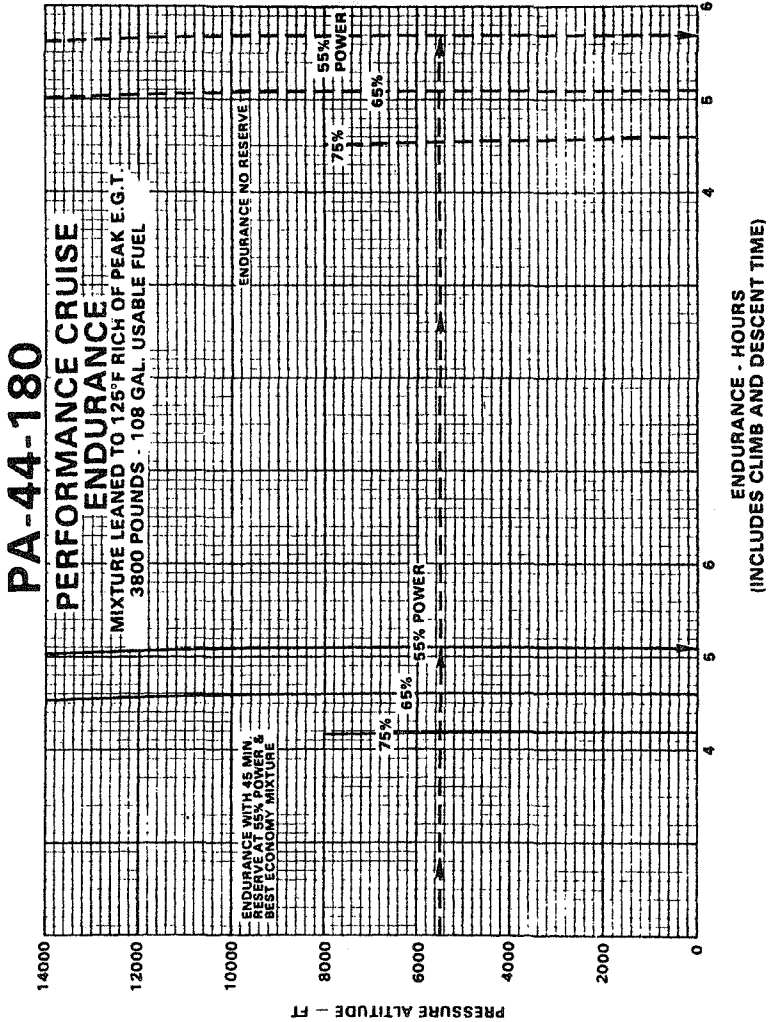

**PERFORMANCE CRUISE ENDURANCE**  
Figure 5-37

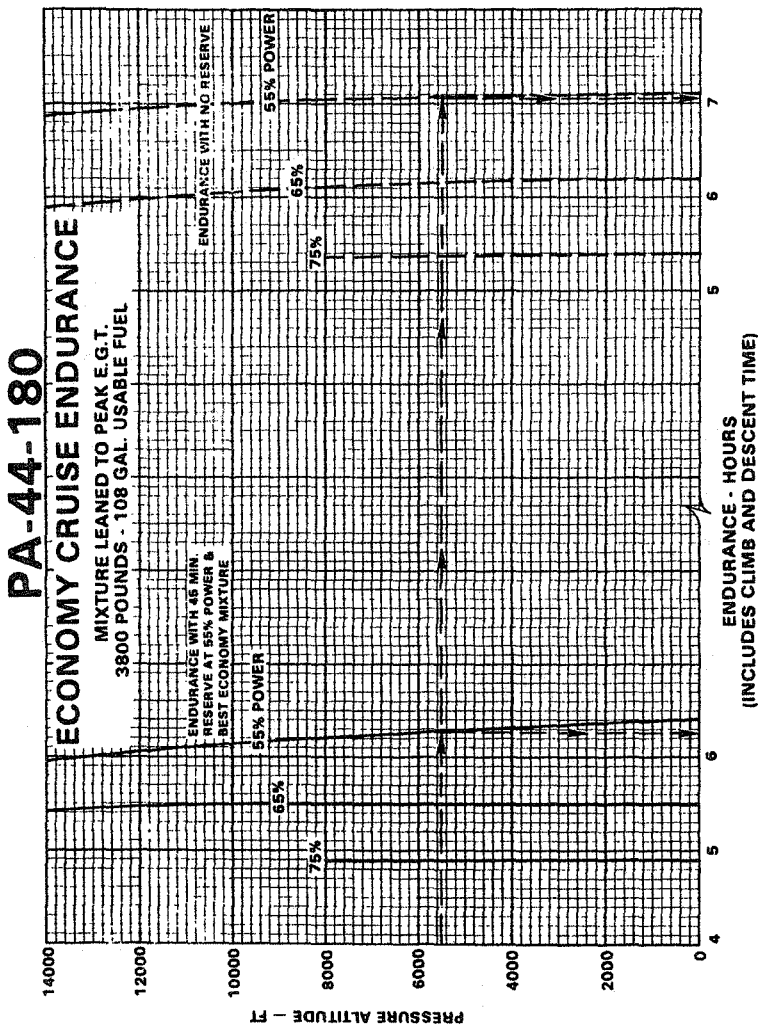

ECONOMY CRUISE ENDURANCE  
Figure 5-39

# PA-44-180

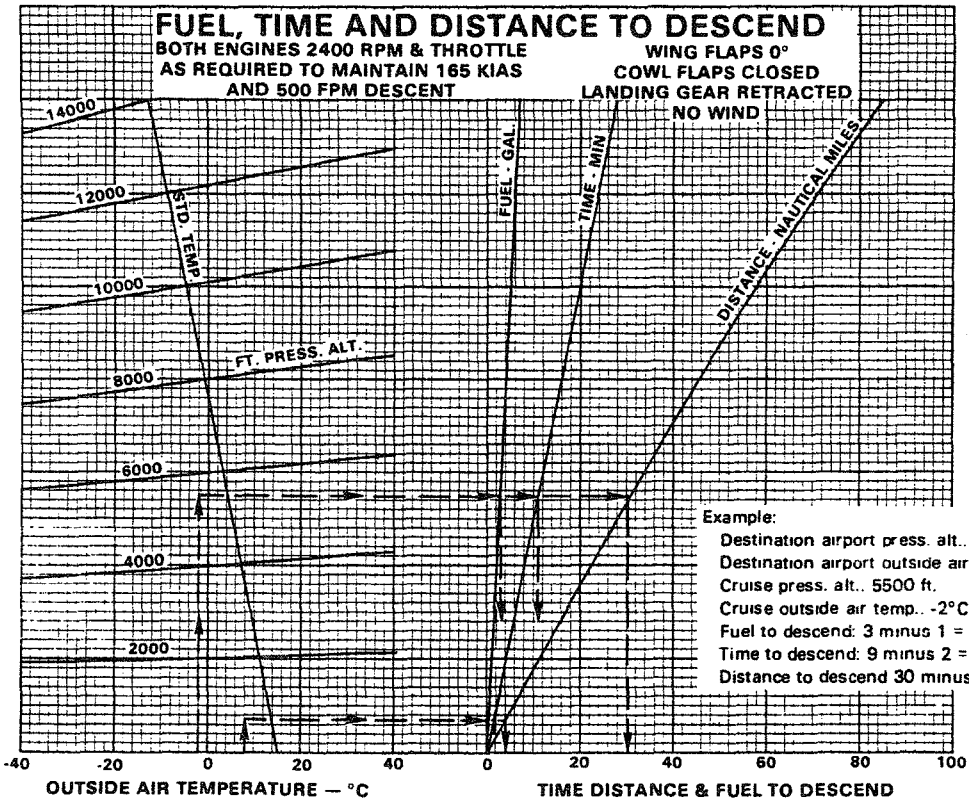

FUEL, TIME AND DISTANCE TO DESCEND

Figure 5-41

ISSUED: MARCH 23, 1978  
 REVISED: SEPTEMBER 14, 1979

REPORT: VB-860  
 5-31

PIPER AIRCRAFT CORPORATION  
 PA-44-180, SEMINOLE

SECTION 5  
 PERFORMANCE

# PA-44-180

## LANDING GROUND ROLL \*STANDARD BRAKES SHORT FIELD EFFORT

WING FLAPS 40° — POWER OFF  
COWL FLAPS OPEN  
PAVED LEVEL DRY RUNWAY  
FULL STALL TOUCHDOWN

Example:

Airport press. alt., 680 ft.  
Outside air temp., 8°C  
Wind component: 5 kts. headwind  
Weight: 3430 lbs.  
Landing ground roll: 480 ft.

\*NOTE  
REDUCE LANDING GROUND ROLL  
BY 35% IF OPTIONAL LANDING  
GEAR HEAVY DUTY GROUP NO. 1  
IS INSTALLED. (SEE EQUIPMENT  
LIST)

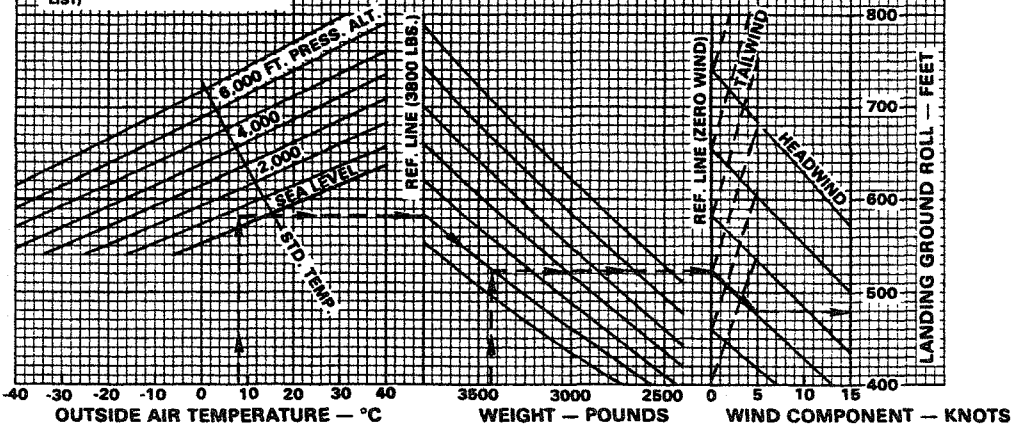

LANDING GROUND ROLL

Figure 5-43

# PA-44-180

## LANDING DISTANCE OVER 50 FT. BARRIER \*STANDARD BRAKES SHORT FIELD EFFORT

WING FLAPS 40° — POWER OFF — COWL FLAPS OPEN  
PAVED LEVEL DRY RUNWAY  
FULL STALL TOUCHDOWN  
APPROACH SPEED AS SCHEDULED

Example:

Airport press. alt. 680 ft.  
Outside air temp. 8°C  
Wind component: 6 kts. headwind  
Weight: 3107 lbs.  
Approach speed: 68 KIAS  
Total landing distance: 1200 ft.

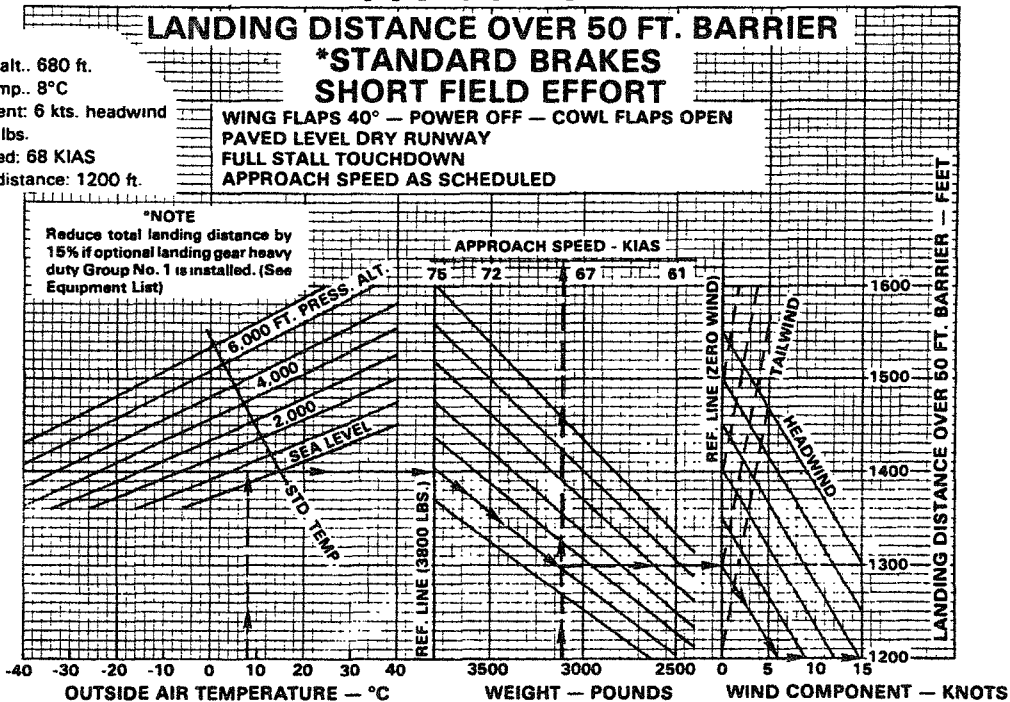

LANDING DISTANCE OVER 50 FT. BARRIER

Figure 5-45

The first part of the document discusses the importance of maintaining accurate records of all transactions. It emphasizes that every entry, no matter how small, should be recorded to ensure the integrity of the financial data. This includes not only sales and purchases but also expenses and income.

The second part of the document provides a detailed breakdown of the company's revenue. It lists the various products sold and the corresponding sales figures for each. This information is crucial for understanding the company's primary sources of income and for identifying areas of growth.

The third part of the document details the company's expenses. It categorizes these into fixed costs, such as rent and salaries, and variable costs, such as materials and shipping. This breakdown helps in understanding the cost structure and in making informed decisions about pricing and cost control.

The fourth part of the document presents a summary of the company's overall financial performance. It includes key metrics such as net profit, gross profit, and operating income. These figures provide a clear picture of the company's profitability and its ability to generate value for its shareholders.

The fifth and final part of the document discusses the company's financial outlook for the future. It outlines the management's strategy for increasing revenue, reducing costs, and improving overall financial performance. This section is essential for investors and other stakeholders to understand the company's long-term potential.

**TABLE OF CONTENTS**

**SECTION 6**

**WEIGHT AND BALANCE**

<b>Paragraph No.</b>		<b>Page No.</b>
6.1	General .....	6-1
6.3	Airplane Weighing Procedure .....	6-2
6.5	Weight and Balance Data and Record .....	6-5
6.7	Weight and Balance Determination for Flight .....	6-9
6.9	Instructions for Using the Weight and Balance Plotter..	6-13





**SECTION 6  
WEIGHT AND BALANCE**

**6.1 GENERAL**

In order to achieve the performance and flying characteristics which are designed into the airplane, it must be flown with the weight and center of gravity (C.G.) position within the approved operating range (envelope). Although the airplane offers flexibility of loading, it cannot be flown with the maximum number of adult passengers, full fuel tanks and maximum baggage. With the flexibility comes responsibility. The pilot must insure that the airplane is loaded within the loading envelope before he makes a takeoff.

Misloading carries consequences for any aircraft. An overloaded airplane will not take off, climb or cruise as well as a properly loaded one. The heavier the airplane is loaded, the less climb performance it will have.

Center of gravity is a determining factor in flight characteristics. If the C.G. is too far forward in any airplane, it may be difficult to rotate for takeoff or landing. If the C.G. is too far aft, the airplane may rotate prematurely on takeoff or tend to pitch up during climb. Longitudinal stability will be reduced. This can lead to inadvertent stalls and even spins; and spin recovery becomes more difficult as the center of gravity moves aft of the approved limit.

A properly loaded airplane, however, will perform as intended. This airplane is designed to provide performance within the flight envelope. Before the airplane is delivered, it is weighed, and a basic empty weight and C.G. location is computed (basic empty weight consists of the standard empty weight of the airplane plus the optional equipment). Using the basic empty weight and C.G. location, the pilot can determine the weight and C.G. position for the loaded airplane by computing the total weight and moment and then determining whether they are within the approved envelope.

The basic empty weight and C.G. location are recorded in the Weight and Balance Data Form (Figure 6-5) and the Weight and Balance Record (Figure 6-7). The current values should always be used. Whenever new equipment is added or any modification work is done, the mechanic responsible for the work is required to compute a new basic empty weight and C.G. position and to write these in the Aircraft Log Book and the Weight and Balance Record. The owner should make sure that it is done.

A weight and balance calculation is necessary in determining how much fuel or baggage can be boarded so as to keep within allowable limits. Check calculations prior to adding fuel to insure against overloading.

The following pages are forms used in weighing an airplane in production and in computing basic empty weight, C.G. position, and useful load. Note that the useful load includes usable fuel, baggage, cargo and passengers. Following this is the method for computing takeoff weight and C.G.

### **6.3 AIRPLANE WEIGHING PROCEDURE**

At the time of delivery, Piper Aircraft Corporation provides each airplane with the basic empty weight and center of gravity location. This data is supplied by Figure 6-5.

The removal or addition of equipment or airplane modifications can affect the basic empty weight and center of gravity. The following is a weighing procedure to determine this basic empty weight and center of gravity location:

**(a) Preparation**

- (1) Be certain that all items checked in the airplane equipment list are installed in the proper location in the airplane.**
- (2) Remove excessive dirt, grease, moisture, and foreign items such as rags and tools, from the airplane before weighing.**
- (3) Defuel airplane. Then open all fuel drains until all remaining fuel is drained. Operate each engine until all undrainable fuel is used and engine stops. Then add the unusable fuel (2.0 gallons total, 1.0 gallons each wing).**

*CAUTION*

Whenever the fuel system is completely drained and fuel is replenished it will be necessary to run the engines for a minimum of 3 minutes at 1000 RPM on each tank to insure no air exists in the fuel supply lines.

- (4) Fill with oil to full capacity.
- (5) Place pilot and copilot seats in fourth (4th) notch, aft of forward position. Put flaps in the fully retracted position and all control surfaces in the neutral position. Tow bar should be in the proper location and entrance and baggage door closed.
- (6) Weigh the airplane inside a closed building to prevent errors in scale readings due to wind.

(b) Leveling

- (1) With airplane on scales, block main gear oleo pistons in the fully extended position.
- (2) Level airplane (refer to Figure 6-3) deflating nose wheel tire, to center bubble on level.

(c) Weighing - Airplane Basic Empty Weight

- (1) With the airplane level and brakes released, record the weight shown on each scale. Deduct the tare, if any, from each reading.

**SECTION 6  
WEIGHT AND BALANCE**

**PIPER AIRCRAFT CORPORATION  
PA-44-180, SEMINOLE**

Scale Position and Symbol	Scale Reading	Tare	Net Weight
Nose Wheel (N)			
Right Main Wheel (R)			
Left Main Wheel (L)			
Basic Empty Weight, as Weighed (T)			

**WEIGHING FORM**

Figure 6-1

(d) Basic Empty Weight Center of Gravity

(1) The following geometry applies to the PA-44-180 airplane when it is level. Refer to Leveling paragraph 6.3 (b).

Top View

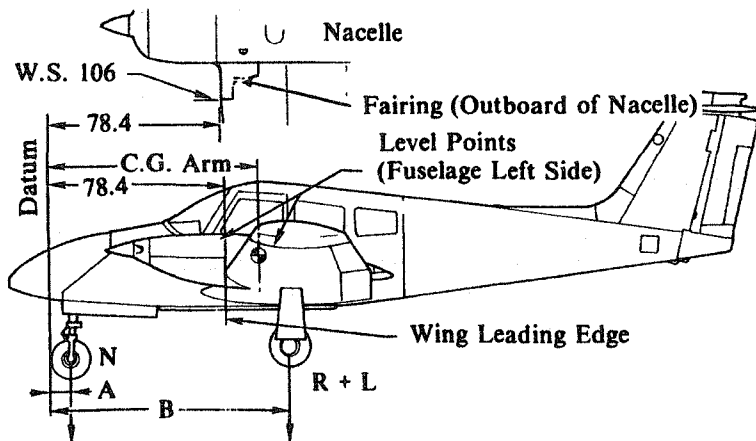

A = 87  
B = 109.7

The datum is 78.4 inches ahead of the wing leading edge at Wing Station 106.

**LEVELING DIAGRAM**

Figure 6-3

- (2) The basic empty weight center of gravity (as weighed including optional equipment, full oil and unusable fuel) can be determined by the following formula:

$$\text{C.G. Arm} = \frac{N (A) + (R + L) (B)}{T} \quad \text{inches}$$

$$\text{Where: } T = N + R + L$$

## **6.5 WEIGHT AND BALANCE DATA AND RECORD**

The Basic Empty Weight, Center of Gravity Location and Useful Load listed in Figure 6-5 are for the airplane as delivered from the factory. These figures apply only to the specific airplane serial number and registration number shown.

The basic empty weight of the airplane as delivered from the factory has been entered in the Weight and Balance Record (Figure 6-7). This form is provided to present the current status of the airplane basic empty weight and a complete history of previous modifications. Any change to the permanently installed equipment or modification which affects weight or moment must be entered in the Weight and Balance Record.

**SECTION 6  
WEIGHT AND BALANCE**

**PIPER AIRCRAFT CORPORATION  
PA-44-180, SEMINOLE**

**MODEL PA-44-180, SEMINOLE**

Airplane Serial Number \_\_\_\_\_

Registration Number \_\_\_\_\_

Date \_\_\_\_\_

**AIRPLANE BASIC EMPTY WEIGHT**

Item	C.G. Arm	
	Weight x (Lbs)	(Inches Aft of Datum) = Moment (In-Lbs)
Standard Empty Weight* <sup>Actual</sup> Computed		
Optional Equipment		
Basic Empty Weight		

\*The standard empty weight includes full oil capacity and 2.0 gallons of unusable fuel.

**AIRPLANE USEFUL LOAD - NORMAL CATEGORY OPERATION**

(Gross Weight) - (Basic Empty Weight) = Useful Load

(3800 lbs.) - (            lbs.) =            lbs.

THIS BASIC EMPTY WEIGHT, C.G. AND USEFUL LOAD ARE FOR THE AIRPLANE AS LICENSED AT THE FACTORY. REFER TO APPROPRIATE AIRCRAFT RECORD WHEN ALTERATIONS HAVE BEEN MADE.

**WEIGHT AND BALANCE DATA FORM**

Figure 6-5

PA-44-180	Serial Number		Registration Number			Page Number						
	Date	Item No.	Description of Article or Modification		Added (+) Removed (-)	Wt. (Lb.)	Arm (In.)	Weight Change	Wt. (Lb.)	Moment / 100	Running Basic Empty Weight	Moment / 100
			As Delivered									

WEIGHT AND BALANCE RECORD

Figure 6-7



**SECTION 6  
WEIGHT AND BALANCE**

**PIPER AIRCRAFT CORPORATION  
PA-44-180, SEMINOLE**

PA-44-180	Serial Number		Registration Number			Page Number	
	Date	Item No.	Description of Article or Modification	Added (+) Removed (-)	Wt. (Lb.)	Arm (In.)	Moment /100
			Weight Change			Running Basic Empty Weight	
			Wt. (Lb.)	Moment /100	Wt. (Lb.)	Moment /100	

**WEIGHT AND BALANCE RECORD (cont)**  
Figure 6-7 (cont)

**6.7 WEIGHT AND BALANCE DETERMINATION FOR FLIGHT**

- (a) Add the weight of all items to be loaded to the basic empty weight.
- (b) Use the Loading Graph (Figure 6-13) to determine the moment of all items to be carried in the airplane.
- (c) Add the moment of all items to be loaded to the basic empty weight moment.
- (d) Divide the total moment by the total weight to determine the C.G location
- (e) By using the figures of item (a) and item (d) (above), locate a point on the C G range and weight graph (Figure 6-15) If the point falls within the C G envelope, the loading meets the weight and balance requirements

**SECTION 6  
WEIGHT AND BALANCE**

**PIPER AIRCRAFT CORPORATION  
PA-44-180, SEMINOLE**

	Weight (Lbs)	Arm Aft Datum (Inches)	Moment (In-Lbs)
Basic Empty Weight			
Pilot and Front Passenger	340.0	80.5	27370
Passengers (Rear Seats)	340.0	118.1	40154
Fuel (108 Gallon Maximum Usable)		95.0	
Baggage (200 Lb. Limit)		142.8	
Ramp Weight (3816 Lbs. Max.)			
Fuel Allowance for Engine Start, Taxi & Runup	-16.0	95.0	-1520
Take-off Weight (3800 Lbs. Max.)			

The center of gravity (C.G.) for the take-off weight of this sample loading problem is at \_\_\_\_\_ inches aft of the datum line. Locate this point ( ) on the C.G. range and weight graph. Since this point falls within the weight - C.G. envelope, this loading meets the weight and balance requirements.

Take-off Weight			
Minus Estimated Fuel Burn-off (climb & cruise) @ 6.0 Lbs/Gal.		95.0	
Landing Weight			

Locate the center of gravity of the landing weight on the C.G. range and weight graph. Since this point falls within the weight - C.G. envelope, the loading may be assumed acceptable for landing.

**IT IS THE RESPONSIBILITY OF THE PILOT AND AIRCRAFT OWNER TO INSURE THAT THE AIRPLANE IS LOADED PROPERLY AT ALL TIMES.**

**SAMPLE LOADING PROBLEM**

Figure 6-9

**PIPER AIRCRAFT CORPORATION  
PA-44-180, SEMINOLE**

**SECTION 6  
WEIGHT AND BALANCE**

	Weight (Lbs)	Arm Aft Datum (Inches)	Moment (In-Lbs)
Basic Empty Weight			
Pilot and Front Passenger		80.5	
Passengers (Rear Seats)		118.1	
Fuel (108 Gallon Maximum Usable)		95.0	
Baggage (200 Lb. Limit)		142.8	
Ramp Weight (3816 Lbs. Max.)			
Fuel Allowance for Engine Start, Taxi & Runup	-16.0	95.0	-1520
Take-off Weight (3800 Lbs. Max.)			

The center of gravity (C.G.) for the take-off weight of this loading problem is at \_\_\_\_\_ inches aft of the datum line. Locate this point ( ) on the C.G. range and weight graph. If this point falls within the weight - C.G. envelope, this loading meets the weight and balance requirements.

Take-off Weight			
Minus Estimated Fuel Burn-off (climb & cruise) @ 6.0 Lbs/Gal.		95.0	
Landing Weight			

Locate the center of gravity of the landing weight on the C.G. range and weight graph. If this point falls within the weight - C.G. envelope, the loading may be assumed acceptable for landing.

**IT IS THE RESPONSIBILITY OF THE PILOT AND AIRCRAFT OWNER TO INSURE THAT THE AIRPLANE IS LOADED PROPERLY AT ALL TIMES.**

**WEIGHT AND BALANCE LOADING FORM**

Figure 6-11

**SECTION 6  
WEIGHT AND BALANCE**

**PIPER AIRCRAFT CORPORATION  
PA-44-180, SEMINOLE**

---

**THIS PAGE INTENTIONALLY LEFT BLANK**

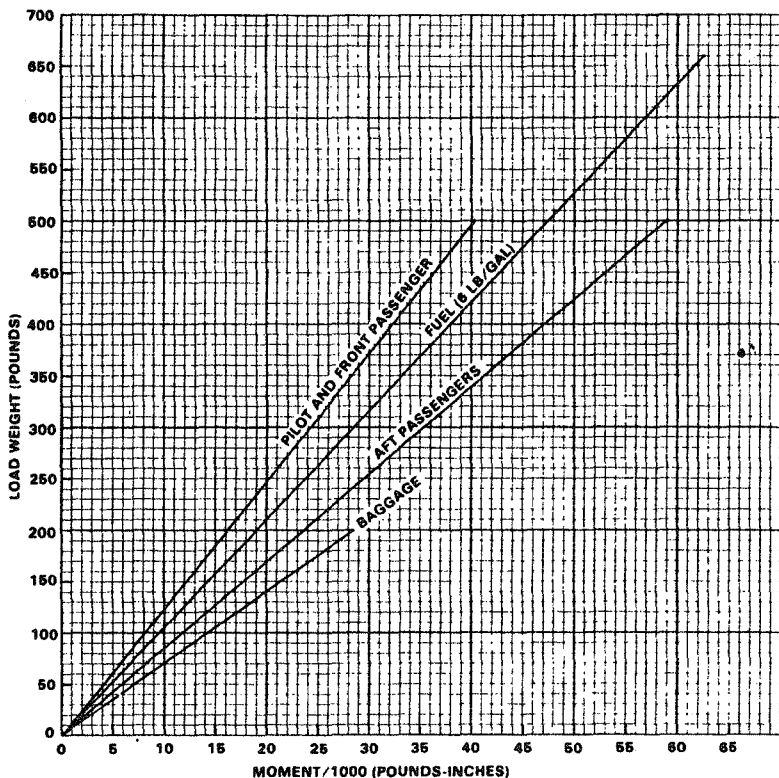

LOADING GRAPH  
Figure 6-13

**SECTION 6  
WEIGHT AND BALANCE**

**PIPER AIRCRAFT CORPORATION  
PA-44-180, SEMINOLE**

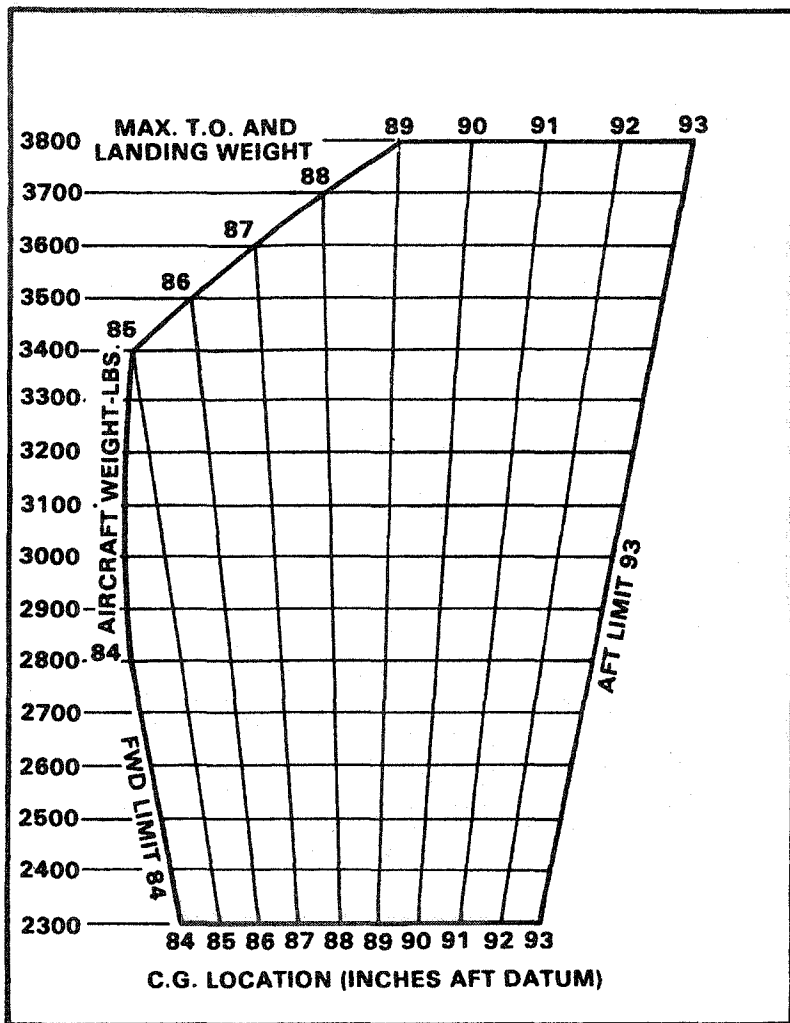

**C.G. RANGE AND WEIGHT**

Figure 6-15

## **6.9 INSTRUCTIONS FOR USING THE WEIGHT AND BALANCE PLOTTER**

This plotter is provided to enable the pilot quickly and conveniently to:

- (a) Determine the total weight and C.G. position.
- (b) Decide how to change his load if his first loading is not within the allowable envelope.

Heat can warp or ruin the plotter if it is left in the sunlight. Replacement plotters may be purchased from Piper dealers and distributors.

When the airplane is delivered, the basic weight and basic C.G. will be recorded on the computer. These should be changed any time the basic weight or C.G. location is changed.

The plotter enables the user to add weights and corresponding moments graphically. The effect of adding or disposing of useful load can easily be seen. The plotter does not cover the situation where cargo is loaded in locations other than on the seats or in the baggage compartments.

Brief instructions are given on the plotter itself. To use it, first plot a point on the grid to locate the basic weight and C.G. location. This can be put on more or less permanently because it will not change until the airplane is modified. Next, position the zero weight end of any one of the loading slots over this point. Using a pencil, draw a line along the slot to the weight which will be carried in that location. Then position the zero weight end of the next slot over the end of this line and draw another line representing the weight which will be located in this second position. When all the loads have been drawn in this manner, the final end of the segmented line locates the total load and the C.G. position of the airplane for takeoff. If this point is not within the allowable envelope it will be necessary to remove fuel, baggage, or passengers and / or to rearrange baggage and passengers to get the final point to fall within the envelope.

Fuel burn-off and gear movement do not significantly affect the center of gravity.



**SAMPLE PROBLEM**

A sample problem will demonstrate the use of the weight and balance plotter.

Assume a basic weight and C.G. location of 2364 pounds at 86.14 inches respectively. We wish to carry a pilot and 3 passengers. Two men weighing 180 and 200 pounds will occupy the front seats, and two children weighing 80 and 100 pounds will ride in the rear. Two suitcases weighing 25 pounds and 20 pounds respectively, will be carried in the rear compartment. We wish to carry 60 gallons of fuel. Will we be within the safe envelope?

- (a) Place a dot on the plotter grid at 2364 pounds and 86.14 inches to represent the basic airplane. (See illustration.)
- (b) Slide the slotted plastic into position so that the dot is under the slot for the forward seats, at zero weight.
- (c) Draw a line up the slot to the 380 pound position ( $180 + 200$ ) and put a dot.
- (d) Continue moving the plastic and plotting points to account for weight in the rear seats ( $80 + 100$ ), baggage compartment (45), and fuel tanks (360).
- (e) As can be seen from the illustration, the final dot shows the total weight to be 3329 pounds with the C.G. at 89.30. This is well within the envelope.
- (f) There will be room for more fuel.

As fuel is burned off, the weight and C.G. will follow down the fuel line and stay within the envelope for landing.

SAMPLE PROBLEM

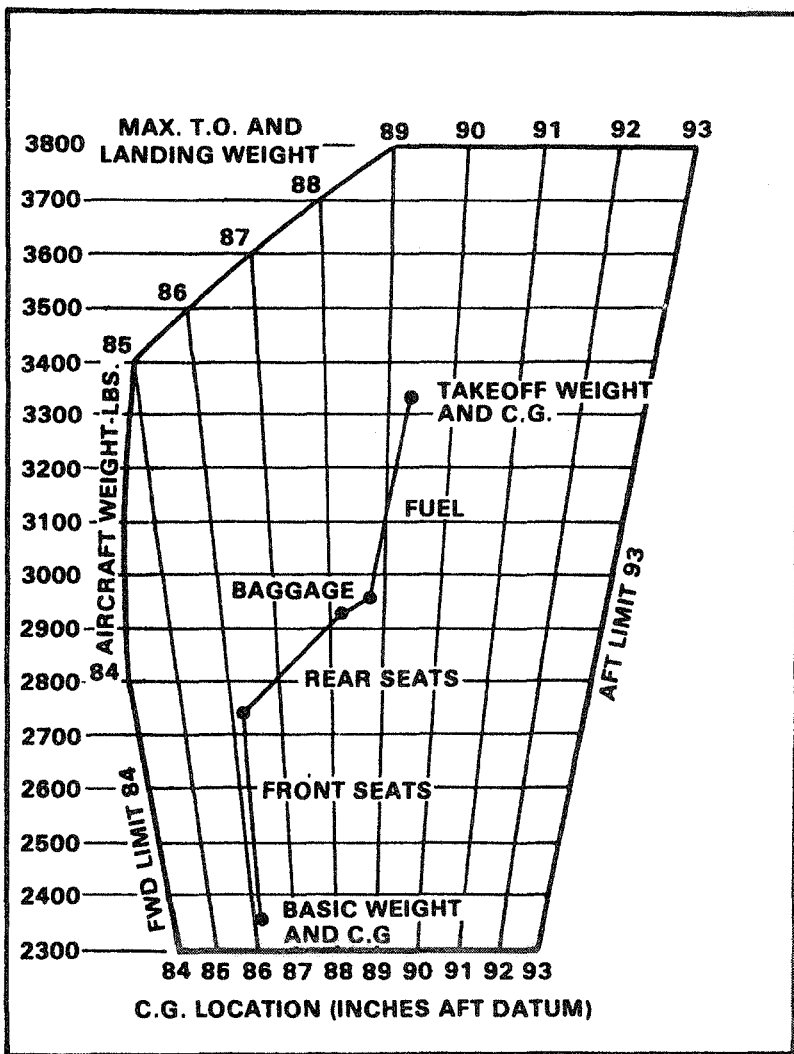

**THIS PAGE INTENTIONALLY LEFT BLANK**

## TABLE OF CONTENTS

### SECTION 7

#### DESCRIPTION AND OPERATION OF THE AIRPLANE AND ITS SYSTEMS

Paragraph No.		Page No.
7.1	The Airplane .....	7-1
7.3	Airframe .....	7-1
7.5	Engines .....	7-2
7.7	Propellers .....	7-5
7.9	Landing Gear .....	7-6
7.11	Brake System .....	7-12
7.13	Flight Control System .....	7-12
7.15	Fuel System .....	7-14
7.17	Electrical System .....	7-16
7.19	Vacuum System .....	7-21
7.21	Pitot Static System .....	7-23
7.23	Instrument Panel .....	7-25
7.25	Heating, Ventilating and Defrosting System .....	7-27
7.27	Cabin Features .....	7-30
7.29	Stall Warning .....	7-32
7.31	Baggage Area .....	7-32
7.33	Finish .....	7-32
7.35	Emergency Locator Transmitter .....	7-33
7.37	Piper External Power .....	7-36
7.39	Propeller Synchrophaser .....	7-36
7.41	Carburetor Ice Detection System .....	7-37



## **SECTION 7**

### **DESCRIPTION AND OPERATION OF THE AIRPLANE AND ITS SYSTEMS**

#### **7.1 THE AIRPLANE**

The Seminole is a twin-engine, all metal, retractable landing gear, airplane. It has seating for up to four occupants and has a two hundred pound capacity luggage compartment.

#### **7.3 AIRFRAME**

With the exception of the steel engine mounts and landing gear, the fiberglass nose cone, cowling nose bowls and tips of wings, and the ABS thermoplastic extremities (tail fin, rudder and stabilator), the basic airframe is of aluminum alloy. Aerobatics are prohibited in this airplane since the structure is not designed for aerobatic loads.

The fuselage is a semi-monocoque structure with a passenger door on the forward right side, a cargo door on the aft right side with an emergency egress door on the forward left side.

The wing is of a semi-tapered design and employs a laminar flow NACA 65 -415 airfoil section. The main spar is located at approximately 40% of the chord. The wings are attached to the fuselage by the insertion of the butt ends of the spar into a spar box carry-through, which is an integral part of the fuselage structure. The bolting of the spar ends into the spar box carry-through structure, which is located under the rear seats, provides in effect a continuous main spar. The wings are also attached fore and aft of the main spar by an auxiliary front spar and a rear spar. The rear spar, in addition to taking torque and drag loads, provides a mount for flaps and ailerons. The four-position wing flaps are mechanically controlled by a handle located between the front seats. When fully retracted, the right flap locks into place to provide a step for cabin entry. Each nacelle contains one fuel tank.

A vertical stabilizer, an all-movable horizontal stabilator, and a rudder make up the empennage. The stabilator, which is mounted on top of the fin, incorporates an anti-servo tab which provides longitudinal stability and trim. This tab moves in the same direction as the stabilator, but with increased travel. Rudder effectiveness is increased by an anti-servo tab on the rudder.

## **7.5 ENGINES**

The aircraft is powered by two Lycoming four-cylinder engines, each rated at 180 horsepower at 2700 RPM at sea level. The engines are air cooled and are equipped with oil coolers with low temperature bypass systems and engine-mounted oil filters. A winterization plate is provided to restrict air during winter operation. (See Winterization in Section 8.) Asymmetric thrust during takeoff and climb is eliminated by the counter-rotation of the engines, the left engine rotating in a clockwise direction when viewed from the cockpit, and the right engine rotating counterclockwise.

The engines are accessible through removable cowls. The upper cowl half is attached with quarter-turn fasteners and is removable. Engine mounts are constructed of steel tubing, and dynafocal engine mounts are provided to reduce vibration.

The induction air box incorporates a manually operated two-way valve which allows the carburetor to receive either induction air which passes through the air filter or heated air which bypasses the filter. Carburetor heat selection provides heated air to the carburetor in the event of carburetor icing, and also allows selection of an alternate source of air in the event the induction air source or the air filter becomes blocked with ice, snow, freezing rain, etc. Carburetor heat selection provides air which is unfiltered; therefore, it should not be used during ground operation when dust or other contaminants might enter the system. The primary (through the filter) induction source should always be used for takeoffs.

Engine controls consist of a throttle, a propeller control and a mixture control lever for each engine. These controls are located on the control quadrant on the lower center of the instrument panel where they are accessible to both the pilot and the copilot (Figure 7-1). The controls utilize teflon-lined control cables to reduce friction and binding.

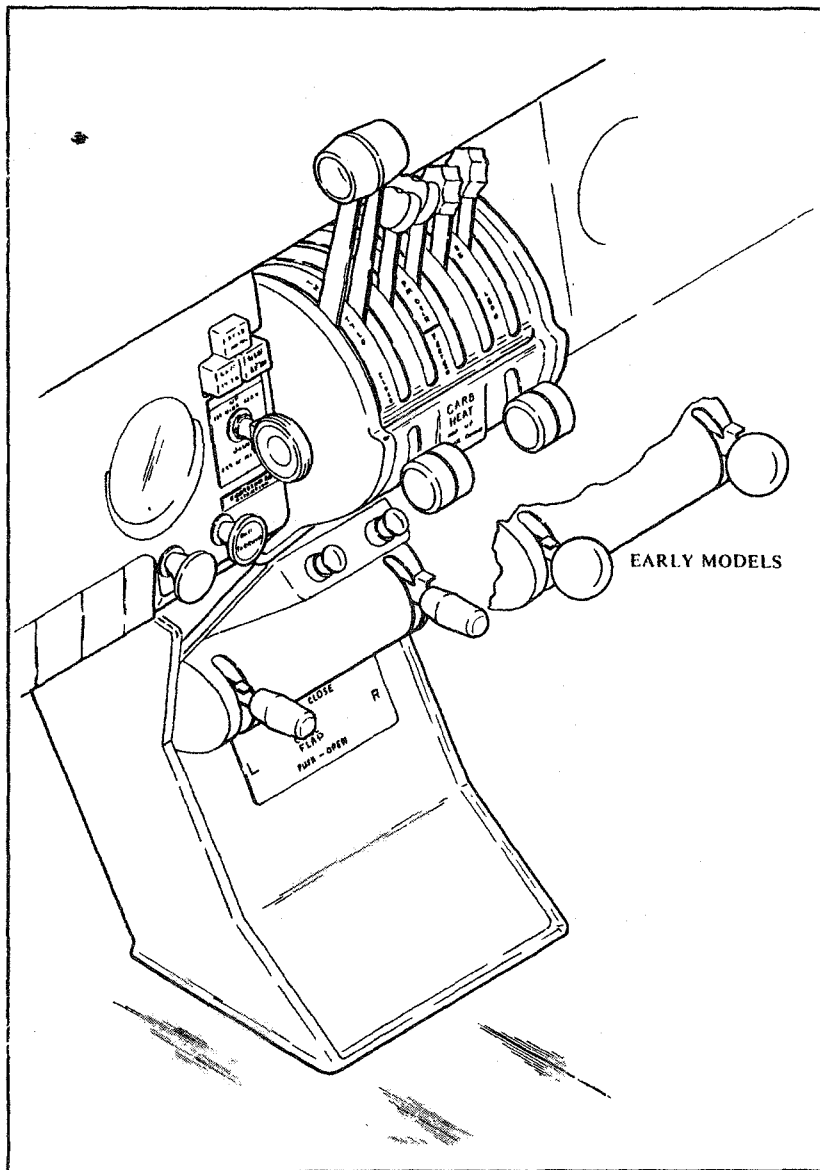

**CONTROL PEDESTAL**  
Figure 7-1



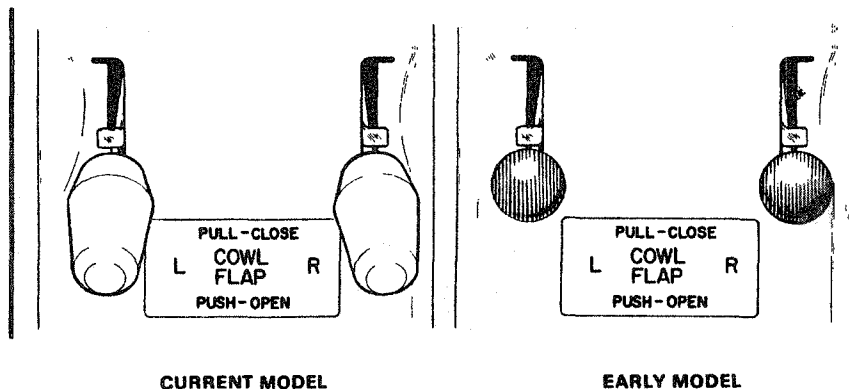

### **COWL FLAP CONTROL**

Figure 7-3

The throttle levers are used to adjust the manifold pressure. They incorporate a gear up warning horn switch which is activated during the last portion of travel of the throttle levers to the low power position. If the landing gear is not locked down, the horn will sound until the gear is down and locked or until the power setting is increased. This is a feature to warn the pilot of an inadvertent gear up landing.

The propeller control levers are used to adjust the propeller speed from high RPM to feather.

The mixture control levers are used to adjust the air to fuel ratio. An engine is shut down by the placing of the mixture control lever in the full lean (idle cut-off) position.

The friction adjustment lever on the right side of the control quadrant may be adjusted to increase or decrease the friction holding the throttle, propeller, and mixture controls or to lock the controls in a selected position.

The carburetor heat controls are located on the control quadrant just below the engine control levers. When a carburetor heat lever is in the up, or off, position the engine is operating on filtered air; when the lever is in the down, or on, position the engine is operating on unfiltered, heated air.

The cowl flap control levers (Figure 7-3), located below the control quadrant, are used to regulate cooling air for the engines. The levers have three positions: full open, full closed, and intermediate. A lock incorporated in each control lever locks the cowl flap in the selected position. To operate the cowl flaps, depress the lock and move the lever toward the desired setting. Release the lock after initial movement and continue movement of the lever. The control will stop and lock into place at the next setting. The lock must be depressed for each selection of a new cowl flap setting.

All throttle operations should be made with a smooth, not too rapid movement to prevent unnecessary engine wear or damage to the engines.

## **7.7 PROPELLERS**

Counter-rotation of the propellers provides balanced thrust during takeoff and climb and eliminates the "critical engine" factor in single-engine flight.

Constant speed, controllable pitch and feathering Hartzell propellers are installed as standard equipment. The propellers mount directly to the engine crankshafts. Pitch is controlled by oil and nitrogen pressure. Oil pressure sends a propeller toward the high RPM or unfeather position; nitrogen pressure and a large spring sends a propeller toward the low RPM or feather position and also prevents propeller overspeeding. Governors, one on each engine, supply engine oil at various pressures through the propeller shafts to maintain constant RPM settings. A governor controls engine speed by varying the pitch of the propeller to match load torque to engine torque in response to changing flight conditions. The recommended nitrogen pressure to be used when charging the unit is listed on placards on the propeller domes and inside the spinners. This pressure varies with ambient temperature at the time of charging. Although dry nitrogen gas is recommended, compressed air may be used provided it contains no moisture. For more detailed instructions, see "Propeller Service" in Section 8 of this Handbook.

Each propeller is controlled by the propeller control levers located in the center of the power control quadrant. Feathering of a propeller is accomplished by moving the control fully aft through the low RPM detent, into the FEATHER position. Feathering takes place in approximately six seconds. Unfeathering is accomplished by moving the propeller control forward and engaging the starter until the propeller is windmilling.

A feathering lock, operated by centrifugal force, prevents feathering during engine shut down by making it impossible to feather any time the engine speed falls below 950 RPM. For this reason, when airborne, and the pilot wishes to feather a propeller to save an engine, he must be sure to move the propeller control into the FEATHER position before the engine speed drops below 950 RPM.

## **7.9 LANDING GEAR**

The aircraft is equipped with hydraulically operated, fully retractable, tricycle landing gear.

Hydraulic pressure for gear operation is furnished by an electrically powered, reversible hydraulic pump (refer to Figures 7-7 and 7-9). The pump is activated by a two-position gear selector switch located to the left of the control quadrant on the instrument panel (Figure 7-5). The gear selector switch, which has a wheel-shaped knob, must be pulled out before it is moved to the UP or DOWN position. When hydraulic pressure is exerted in one direction, the gear is retracted; when it is exerted in the other direction, the gear is extended. Gear extension or retraction normally takes six to seven seconds.

### *CAUTION*

If the landing gear is in transit, and the hydraulic pump is running, it is NOT advisable to move the gear selector switch to the opposite position before the gear has reached its full travel limit, because a sudden reversal may damage the electric pump.

The landing gear is designed to extend even in the event of hydraulic failure. Since the gear is held in the retracted position by hydraulic pressure, should the hydraulic system fail for any reason, gravity will allow the gear to extend. When the landing gear is retracted, the main wheels retract inboard into the wings and the nose wheel retracts aft into the nose section. Springs assist in gear extension and in locking the gear in the down position. After the gears are down and the downlock hooks engage, springs maintain force on each hook to keep it locked until it is released by hydraulic pressure.

To extend and lock the gears in the event of hydraulic failure, it is necessary only to relieve the hydraulic pressure. An emergency gear extension knob, located directly beneath the gear selector switch is provided for this purpose. Pulling this knob releases the hydraulic pressure holding the gear in the up position and allows the gear to fall free. Before pulling the emergency gear extension knob, place the landing gear selector switch in the DOWN position to prevent the pump from trying to raise the gear. If the emergency gear knob has been pulled out to lower the gear by gravity, due to a gear system malfunction, leave the control in its extended position until the airplane has been put on jacks to check the proper function of the landing gear hydraulic and electrical systems. See the Service Manual for proper landing gear system check out procedures. If the airplane is being used for training purposes or a pilot check out mission, and the emergency gear extension knob has been pulled out, it may be pushed in again when desired if there has not been any apparent malfunction of the landing gear system.

When the gear is fully extended or fully retracted and the gear selector is in the corresponding position, electrical limit switches stop the flow of current to the motor of the hydraulic pump. The three green lights directly above the landing gear selector switch illuminate to indicate that each of the three landing gears is down and locked. A convex mirror on the left engine nacelle both serves as a taxiing aid and allows the pilot to visually confirm the condition of the nose gear. If the gear is in neither the full up nor the full down position, a red warning light on the instrument panel illuminates. Should the throttle be placed in a low setting - as for a landing approach - while the gear is retracted, a warning horn sounds to alert the pilot that the gear is retracted. The gear warning horn emits a 90 cycles per minute beeping sound.

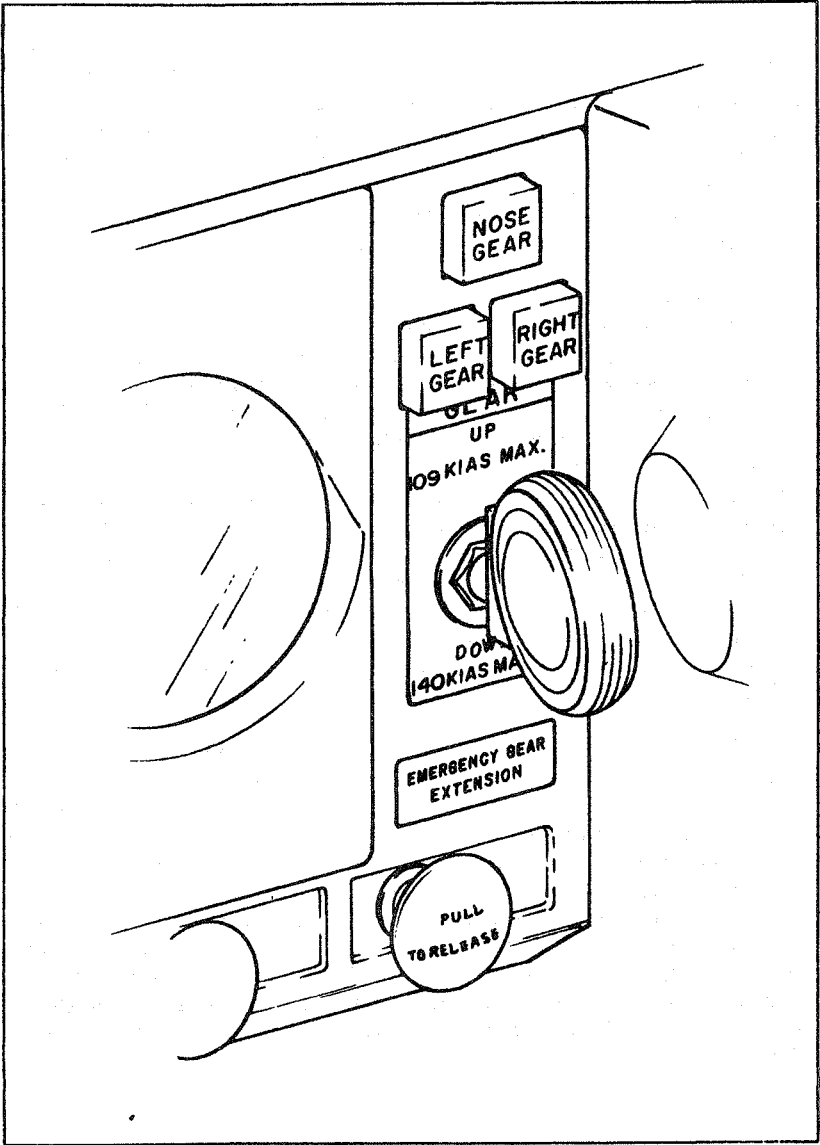

LANDING GEAR SELECTOR  
Figure 7-5

The green gear lights are dimmed automatically when the navigation lights are turned on. For this reason, if the navigation lights are turned on in the daytime, it is difficult to see the landing gear lights. If the green lights are not observed after the landing gear selector switch is placed in the DOWN position, the first thing to check is the position of the navigation lights switch.

If one or two of the three green lights do not illuminate when the gear DOWN position has been selected, any of the following conditions could exist for each light that is out:

- (a) The gear is not locked down.
- (b) A bulb is burned out.
- (c) There is a malfunction in the indicating system.

In order to check the bulbs, the square indicator lights can be pulled out and interchanged.

A micro switch incorporated in the throttle quadrant activates the gear warning horn under the following conditions:

- (a) The gear is not locked down and the manifold pressure has fallen below 14 inches on either one or both engines.
- (b) The gear selector switch is in the UP position when the airplane is on the ground.
- (c) The gear selector switch is in the UP position and wing flaps are extended to the second or third notch position.

To prevent inadvertent gear retraction should the gear selector be placed in the UP position when the airplane is on the ground, a squat switch located on the left main gear will prevent the hydraulic pump from actuating if the master switch is turned on. On takeoff, when the landing gear oleo strut drops to its full extension, the safety switch closes to complete the circuit which allows the hydraulic pump to be activated to raise the landing gear when the gear selector is moved to the UP position. During the preflight check, be sure the landing gear selector is in the DOWN position and that the three green gear indicator lights are illuminated. On takeoff, the gear should be retracted before an airspeed of 109 KIAS is exceeded. The landing gear may be lowered at any speed up to 140 KIAS.

The hydraulic reservoir for landing gear operation is an integral part of the gear hydraulic pump. Access to the combination pump and reservoir is through a panel in the baggage compartment. For filling instructions, see the Service Manual.

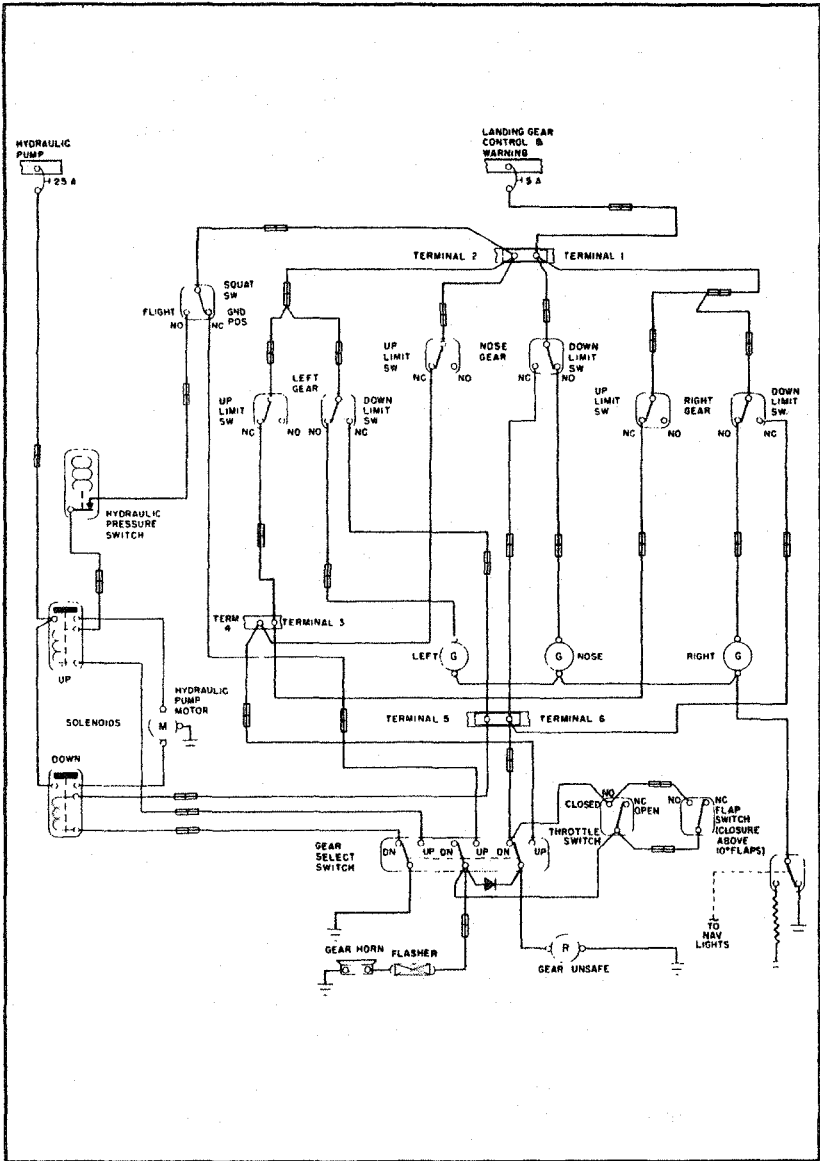

**LANDING GEAR ELECTRICAL SYSTEM SCHEMATIC**

Figure 7-7

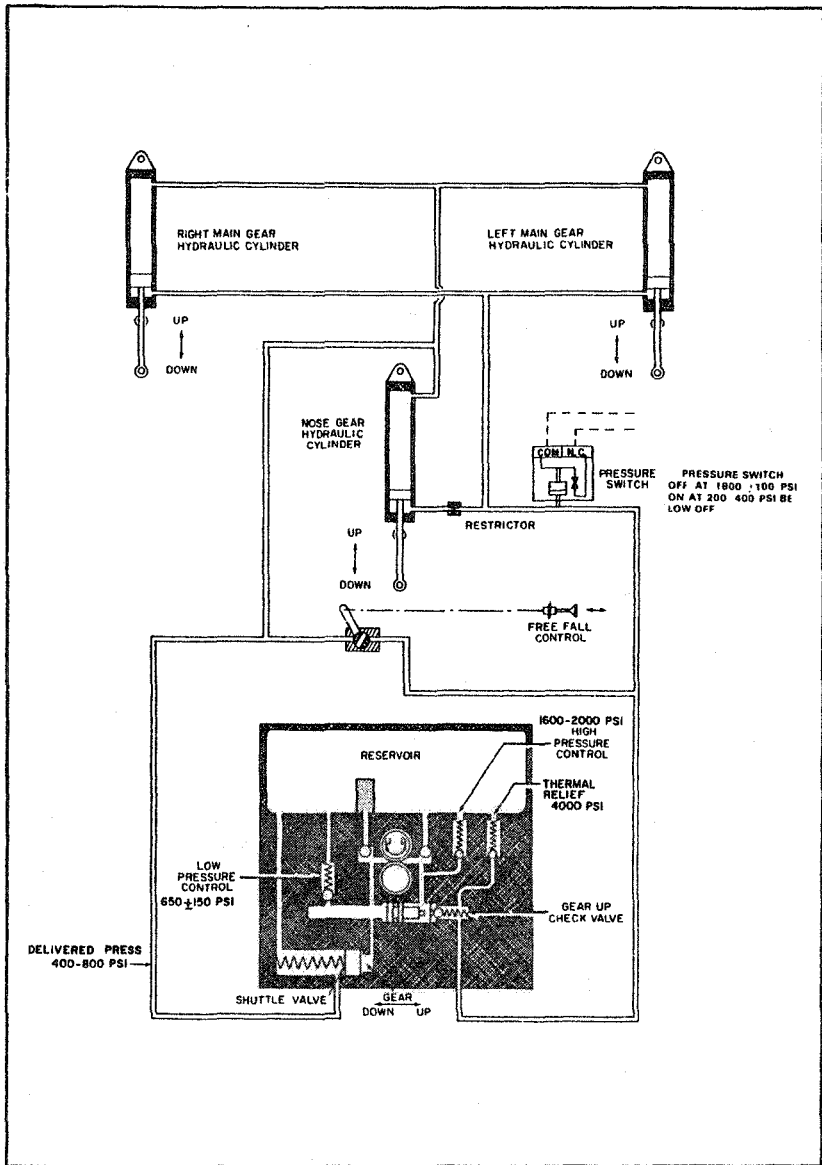

**LANDING GEAR HYDRAULIC SYSTEM SCHEMATIC**  
Figure 7-9



The nose gear is steerable through a 30 degree arc either side of center by use of a combination of full rudder pedal travel and brakes. A gear centering spring, incorporated in the nose gear steering system, prevents shimmy tendencies. A bungee assembly reduces ground steering effort and dampens shocks and bumps during taxiing. When the gear is retracted, the nose wheel centers as it enters the wheel well, and the steering linkage disengages to reduce pedal loads in flight.

The main landing gear carries 6.00 x 6 , 8-ply tires. The nose wheel has a 5.00 x 5, 6-ply tire. For information on servicing the tires, see "Tire Inflation" in Section 8 of this Handbook.

Struts for the landing gear are air-oil assemblies. Strut exposure should be checked during each preflight inspection. If a need for service or adjustment is indicated, refer to the instructions printed on the units. Should more detailed landing gear service information be required, refer to the Service Manual.

### **7.11 BRAKE SYSTEM**

The brake system is designed to meet all normal braking needs. Two single-disc, double puck brake assemblies, one on each main gear, are actuated by toe brake pedals mounted on both the pilot's and copilot's rudder pedals. A brake system hydraulic reservoir, independent of the landing gear hydraulic reservoir, is located in the rear top of the nose compartment. Brake fluid should be maintained at the level marked on the reservoir. For further information see "Brake Service" in Section 8 of this Handbook.

The parking brake is engaged by depressing the toe brake pedals and pulling out the parking brake knob located on the lower instrument panel adjacent to the throttle quadrant. The parking brake is released by depressing the toe brake pedals and pushing in the parking brake knob.

### **7.13 FLIGHT CONTROL SYSTEM**

Dual flight controls are installed as standard equipment. The controls actuate the control surfaces through a cable system. The horizontal tail surface (stabilator) is of the all movable slab type with an anti-servo tab mounted on the trailing edge. This tab, actuated by a control mounted on the console between the front seats, also acts as a longitudinal trim tab (refer to Figure 7-11).

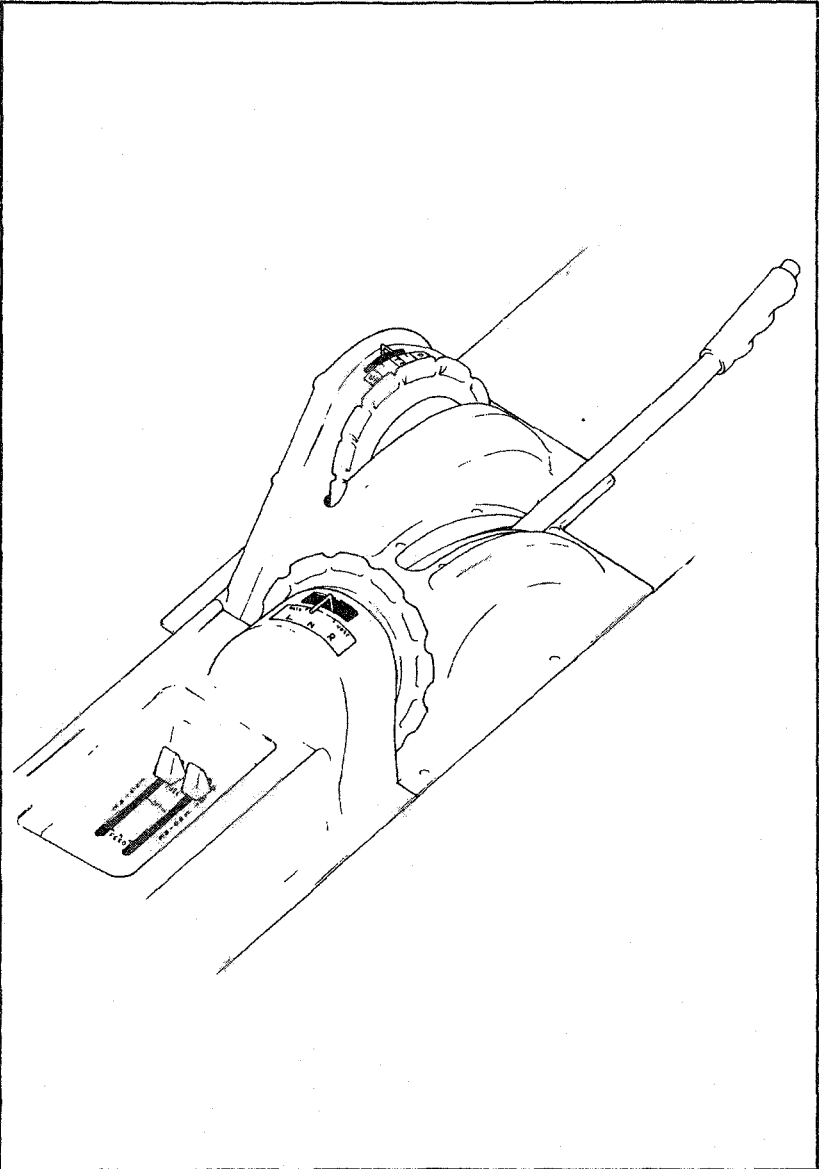

**CONSOLE**  
Figure 7-11

The vertical tail is fitted with a rudder which incorporates a combination rudder trim and anti-servo tab. The rudder trim control is located on the control console between the front seats.

The flaps are manually operated and spring loaded to return to the retracted position. A four-position flap control lever (Figure 7-11) between the front seats adjusts the flaps for reduced landing speeds and glide path control. The flaps have three extended positions - 10, 25 and 40 degrees - as well as the fully retracted position. A button on the end of the lever must be depressed before the control can be moved. A past center lock incorporated in the actuating linkage holds the flap when it is in the retracted position so that it may be used as a step on the right side. Since the flap will not support a step load except in the fully retracted position, the flaps should be retracted when people are entering or leaving the airplane.

### **7.15 FUEL SYSTEM**

Fuel is stored in two 55 gallon fuel tanks, one in each nacelle (Figure 7-13). One gallon of fuel in each nacelle is unusable, giving a total of 108 usable gallons. The minimum fuel grade is 100/130 octane. The fuel tank vents, one installed under each wing, feature an anti-icing design to prevent ice formation from blocking the fuel tank vent lines.

Normally, fuel is supplied to the engines through engine-driven fuel pumps. Auxiliary electric fuel pumps serve as a back-up feature. The electric fuel pumps are controlled by rocker switches on the switch panel to the left of the pilot. The electric fuel pumps should be ON during takeoffs and landings.

Fuel quantities and pressures are indicated on gauges on the instrument panel. There is a separate fuel quantity gauge for each tank. A calibrated fuel dipstick is provided with the airplane. To visually check the quantity of fuel in a tank, insert the dipstick to the bottom of the tank, close off the protruding end with a finger, withdraw the dipstick, and read the fuel level. The most accurate reading will be obtained with the airplane on level ground.

Fuel management controls are located on the console between the front seats (Figure 7-11). There is a control lever for each of the engines, and each is placarded "ON" - "OFF" - "X FEED." During normal operation, the levers are in the ON position, and each engine draws fuel from the tanks on the same side as the engine. When the X FEED position is selected, the engine will draw fuel from the tank on the opposite side in order to extend range and keep fuel weight balanced during single-engine operation. The

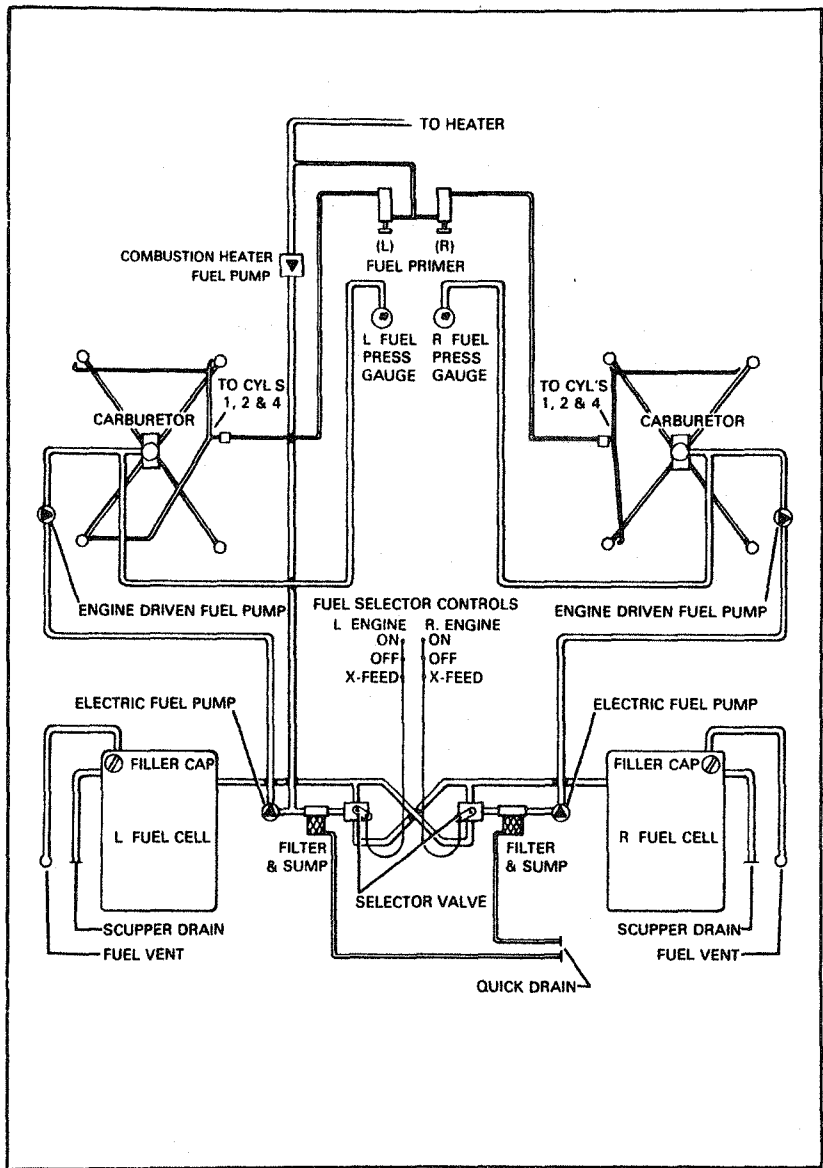

FUEL SYSTEM SCHEMATIC  
Figure 7-13

OFF position shuts off the fuel flow to that engine.

**NOTE**

When one engine is inoperative and the fuel selector for the operating engine is on X FEED the selector for the inoperative engine must be in the OFF position. Do not operate with both selectors on X FEED. Do not take off or land with a selector on X FEED.

Before each flight, fuel must be drained from the low points in the fuel system to ensure that any accumulation of moisture or sediment is removed from the system. A fuel drain is provided for each half of the fuel system. The fuel drains are located on the right side of the fuselage just forward of the entrance step. (Refer to fuel draining procedure in paragraph 8.21, Fuel System.)

**7.17 ELECTRICAL SYSTEM**

The electrical system is capable of supplying sufficient current for complete night IFR equipment. Electrical power is supplied by two 60 ampere alternators (Figure 7-15), one mounted on each engine. A 35 ampere-hour, 12-volt battery provides current for starting, for use of electrical equipment when the engines are not running, and for a source of stored electrical power to back up the alternator output. The battery, which is located in the nose section is normally kept charged by the alternators. If it becomes necessary to charge the battery, it should be removed from the airplane.

Two solid state voltage regulators maintain effective load sharing while regulating electrical system bus voltage to 14-volts. An overvoltage relay in each alternator circuit prevents damage to electrical and avionics equipment by taking an alternator off the line if its output exceeds 17-volts. If this should occur, the alternator light on the annunciator panel will illuminate. Voltage regulators and overvoltage relays are located in the nose section.

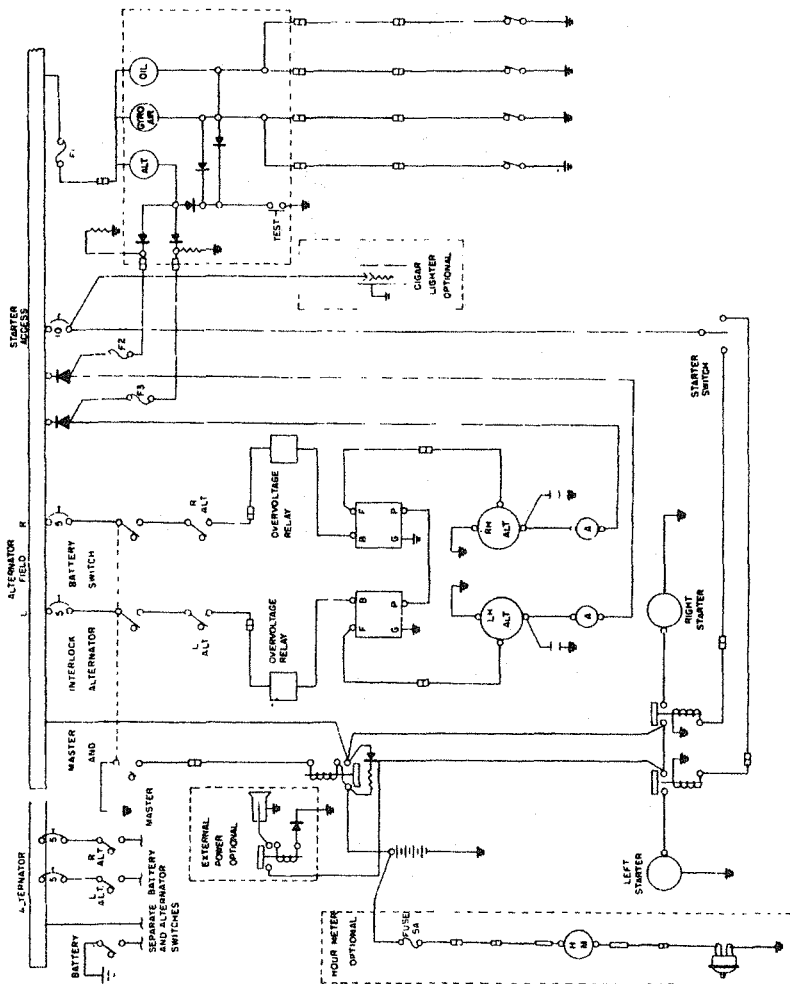

**ALTERNATOR AND STARTER SCHEMATIC**  
 Figure 7-15

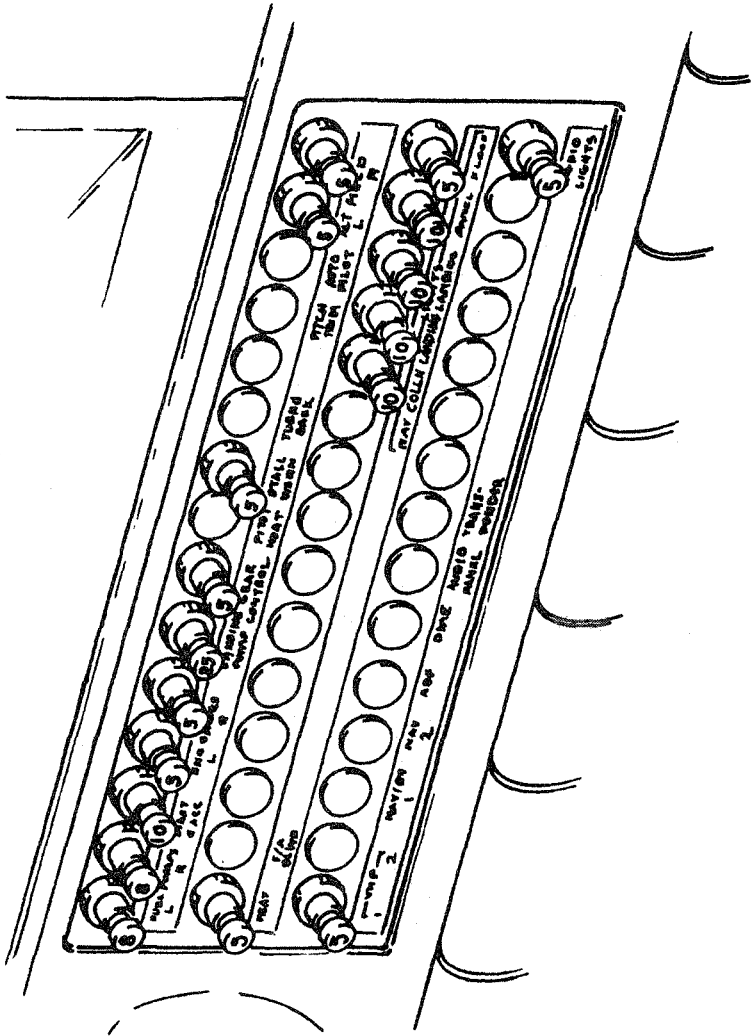

**TYPICAL CIRCUIT BREAKER PANEL**  
Figure 7-17

The electrical system and equipment are protected by circuit breakers located on a circuit breaker panel on the lower right side of the instrument panel (Figure 7-17). The circuit breaker panel is provided with enough blank spaces to accommodate additional circuit breakers if extra electrical equipment is installed. In the event of equipment malfunctions or a sudden surge of current, a circuit breaker can trip automatically. The pilot can reset the breaker by pressing it in (preferably after a few minutes cooling period). The circuit breakers can be pulled out manually.

Most of the electrical switches, including the master switch and switches for magnetos, fuel pumps, starters, alternators, lights and pitot heat, are conveniently located on the switch panel (Figure 7-19) to the left of the pilot.

An optional light, mounted in the overhead panel, provides instrument and cockpit lighting for night flying. The light is controlled by a rheostat switch located adjacent to the light. A map light window in the lens is actuated by an adjacent switch.

#### ***WARNING***

Anti-collision lights should not be operating when flying through cloud, fog or haze, since the reflected light can produce spatial disorientation. Strobe lights should not be used in close proximity to the ground, such as during taxiing, takeoff or landing.

Approximately 2000 RPM or more is required to obtain full alternator output of 60 amperes. It is normal to have zero output at idle RPM. This is due to the reduced drive ratio from the engine. Dual ammeters and the ALT annunciator light provide a means of monitoring the electrical system operation. The two ammeters (load meters) indicate the output of the alternators. Should an ammeter indicate a load much higher than the known consumption of the electrical equipment in use, it should be suspected of a malfunction and turned off. In this event, the remaining alternator's ammeter should show a normal indication after approximately one minute. If both ammeters indicate a load much higher than the known consumption for more than approximately five minutes, an electrical defect other than the alternator system should be suspected because a discharged battery will reduce the alternator load as it approaches the charged conditions. A zero ammeter reading indicates an alternator is not producing current and should be accompanied by illumination of the ALT annunciator light. A single



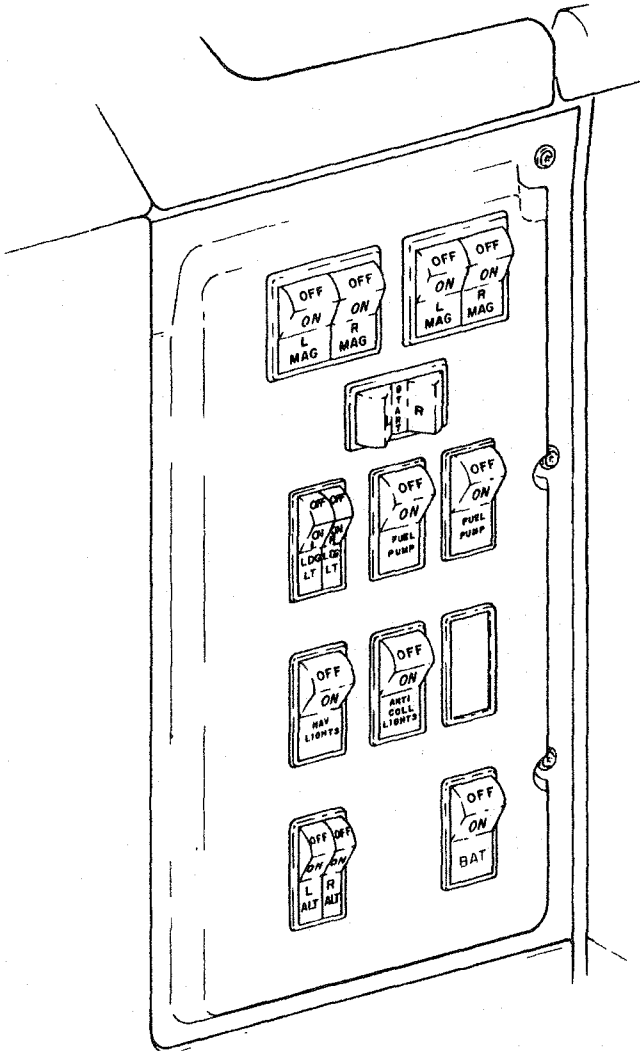

**TYPICAL SWITCH PANEL**  
Figure 7-19

alternator is capable of supporting a continued flight in case of alternator or engine failure in most conditions, however, with deicing equipment and other high loads, care must be exercised to prevent the loads from exceeding the 60 ampere rating and subsequent depletion of the battery. For abnormal and/or emergency operations and procedures, refer to Section 3 - Emergency Procedures.

An optional starting installation known as Piper External Power (PEP) is accessible through a receptacle located on the lower left side of the nose section. An external battery can be connected to the socket, thus allowing the operator to crank the engine without having to gain access to the airplane's battery.

### **CAUTION**

Do not use cigar lighter receptacles as power sources for any devices other than the cigar lighters supplied with the airplane. Any other device plugged into these receptacles may be damaged.

## **7.19 VACUUM SYSTEM**

The vacuum system operates the air-driven gyro instruments. The vacuum system (Figure 7-21) consists of a vacuum pump on each engine, plus plumbing and regulating equipment.

The vacuum pumps are dry-type pumps, which eliminates the need for an air/oil separator and its plumbing. A shear drive protects the engine from damage. If the drive shears, the gyros will become inoperative.

The vacuum gauge, mounted on the right instrument panel to the right of the radios (refer to Figure 7-25), provides valuable information to the pilot about the operation of the vacuum system. A decrease in pressure in a system that has remained constant over an extended period may indicate a dirty filter, dirty screens, possibly a sticking vacuum regulator or leak in system (a low vacuum indicator light is provided in the annunciator panel). Zero pressure would indicate a sheared pump drive, defective pump, possibly a defective gauge or collapsed line. In the event of any gauge variation from the norm, the pilot should have a mechanic check the system to prevent possible damage to the system components or eventual failure of the system.

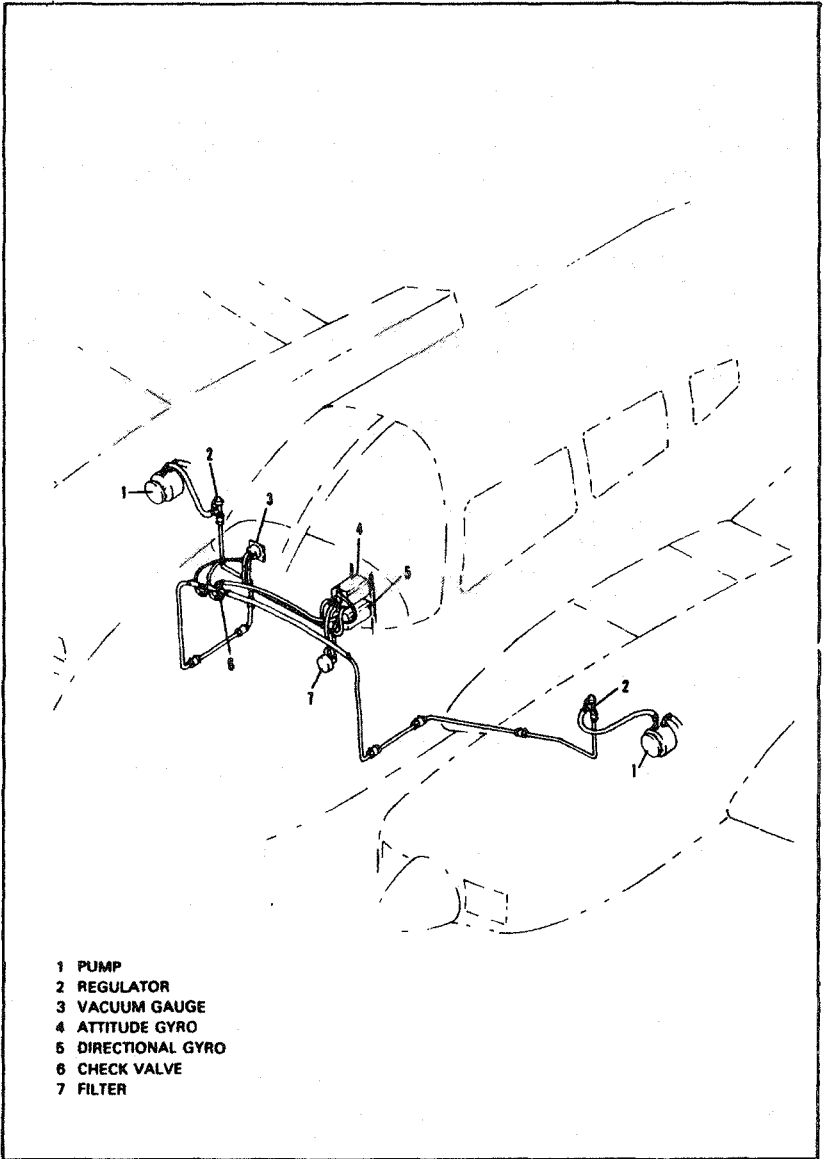

**VACUUM SYSTEM**

Figure 7-21

A vacuum regulator is provided in the system to protect the gyros. The valve is set so the normal vacuum reads 4.8 to 5.2 inches of mercury, a setting which provides sufficient vacuum to operate all the gyros at their rated RPM. Higher settings will damage the gyros and with a low setting the gyros will be unreliable. The regulator is located behind the instrument panel.

## **7.21 PITOT STATIC SYSTEM**

The pitot static system (Figure 7-23) supplies both pitot and static pressure for the airspeed indicator and static pressure for the altimeter and vertical speed indicator (when installed). Pitot and static pressure are picked up by the pitot head on the bottom of the left wing.

The control valve for an alternate static source is located below the left side of the instrument panel. When the valve is set in the alternate position, the altimeter, vertical speed indicator and airspeed indicator will be using cabin air for static pressure. The storm window and cabin vents must be closed and the cabin heater and defroster must be on during alternate static source operation. The altimeter error is less than 50 feet unless otherwise placarded.

To prevent bugs and water from entering the pitot and static pressure holes when the airplane is parked, a cover should be placed over the pitot head. A partially or completely blocked pitot head will give erratic or zero readings on the instruments.

### **NOTE**

During preflight, check to make sure the pitot cover is removed.

An optional heated pitot head installation, which alleviates problems with icing or heavy rain, is available. The switch for pitot heat is located on the switch panel to the pilot's left. The pitot heat system has a separate circuit breaker located in the circuit breaker panel and labeled "Pitot Heat." The operational status of the pitot heat system should be included in the preflight check.

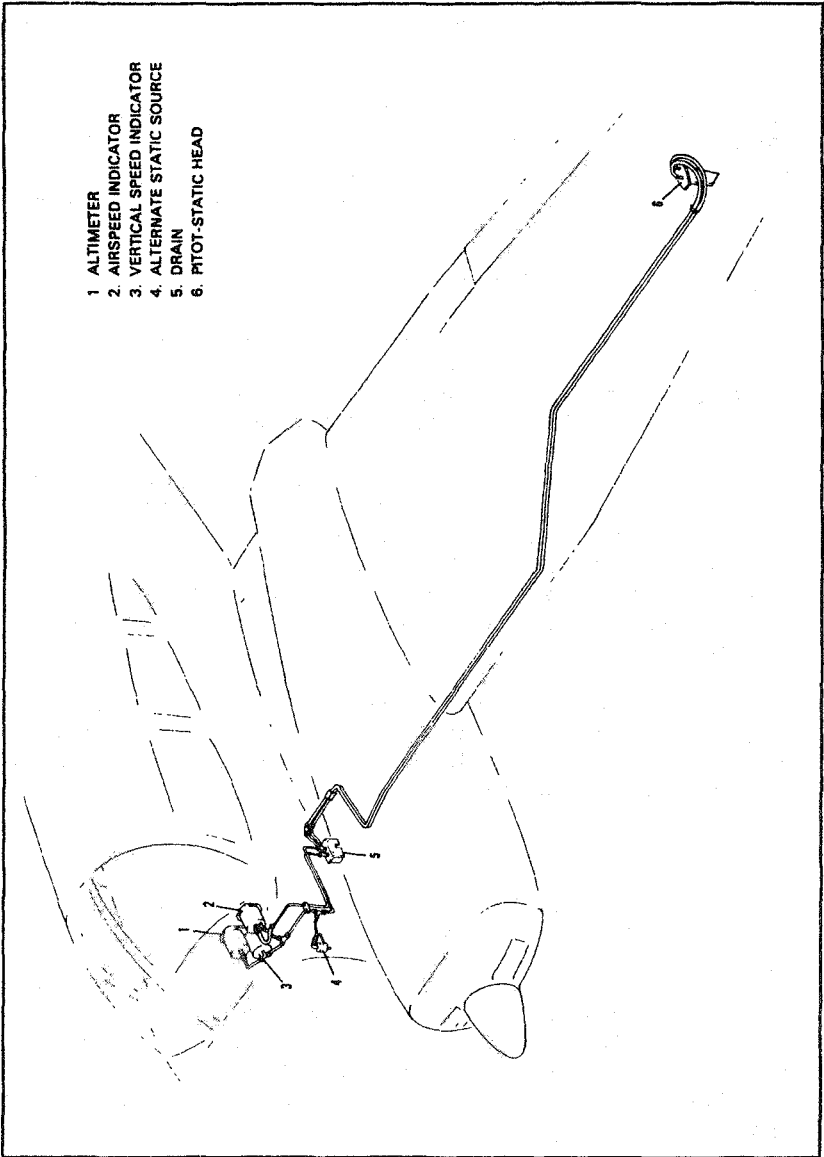

**PITOT STATIC SYSTEM**

Figure 7-23

*CAUTION*

Care should be exercised when checking the operation of the heated pitot head. The unit becomes very hot. Ground operation of pitot heat should be limited to 3 minutes maximum to avoid damaging the heating units.

**7.23 INSTRUMENT PANEL**

Flight instruments are grouped in the upper instrument panel (Figure 7-25); engine and electrical system monitoring instruments, the autopilot, and the circuit breaker panel are in the lower instrument panel. Left and right engine instruments are separated by the left control wheel shaft.

Radios are mounted in the center of the upper instrument panel. An optional radio master switch is located near the top of the instrument panel between the radio stacks. It controls the power to all radios through the aircraft master switch. An emergency bus switch is also provided to insure auxiliary power to the avionics bus in the event of a radio master switch circuit failure. The emergency bus switch is located behind the lower right shin guard left of the circuit breaker panel. The control quadrant - throttles and propeller and mixture controls - is in the center of the lower instrument panel. To the left of the control quadrant is the landing gear selector.

Various warning lights are located with the pilot's flight instruments on the left upper instrument panel. The gear unsafe warning light is to the left of the annunciator panel.

The annunciator panel, with oil pressure, gyro vacuum and alternator lights, and incorporating a press-to-test feature, is located to the upper left of the radios. The illumination of these lights in flight is an indication of a possible system malfunction. The pilot should closely monitor instrument panel gauges to check the condition of a system whose corresponding light on the annunciator panel illuminates. During preflight, the operational status of the annunciator panel should be tested by use of the press-to-test button. When the button is depressed, all annunciator panel lights should illuminate.

**NOTE**

When an engine is feathered, the alternator, gyro air and engine oil pressure annunciator lights will remain illuminated.

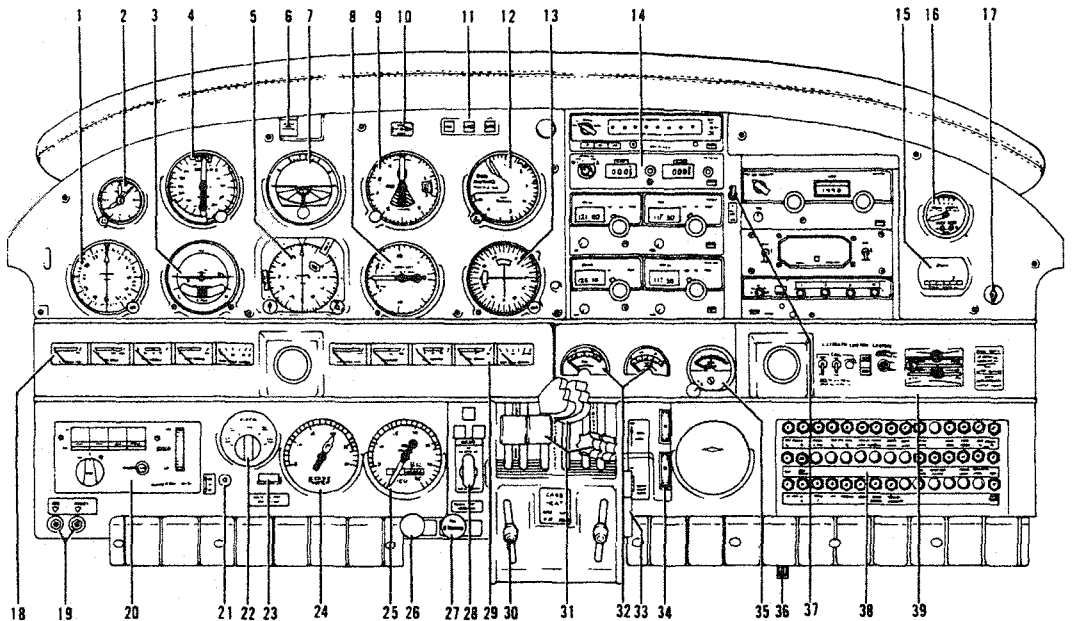

- |                              |                         |                                  |
|------------------------------|-------------------------|----------------------------------|
| 1. ADF                       | 11. ANNUNCIATOR DISPLAY | 21. NAV SELECTOR                 |
| 2. CLOCK                     | 12. RADAR ALTIMETER     | 22. COUPLER                      |
| 3. TURN COORDINATOR          | 13. NAV 2               | 23. ELECTRIC PITCH               |
| 4. AIRSPEED INDICATOR        | 14. AVIONICS            | 24. DUAL MANIFOLD PRESSURE GAUGE |
| 5. DIRECTIONAL GYRO          | 15. HOURMETER           | 25. DUAL TACHOMETER              |
| 6. GEAR UNSAFE WARNING LIGHT | 16. VACUUM GAUGE        | 26. PARKING BRAKE KNOB           |
| 7. ATTITUDE GYRO             | 17. CIGAR LIGHTER       | 27. EMERGENCY GEAR EXTENDER      |
| 8. VERTICAL SPEED INDICATOR  | 18. LEFT ENGINE GAUGES  | 28. LANDING GEAR SELECTOR        |
| 9. ALT.METER                 | 19. MIKE/PHONE JACKS    | 29. RIGHT ENGINE GAUGES          |
| 10. ANNUNCIATOR TEST SWITCH  | 20. AUTOPILOT CONTROLS  | 30. CARBURETOR HEAT CONTROLS     |
|                              |                         | 31. CONTROL LEVERS               |
|                              |                         | 32. AMMETERS                     |
|                              |                         | 33. CONTROL FRICTION LOCK        |
|                              |                         | 34. LIGHT DIMMER SWITCHES        |
|                              |                         | 35. DUAL EGT GAUGE               |
|                              |                         | 36. EMERGENCY BUS SWITCH         |
|                              |                         | 37. RADIO MASTER SWITCH          |
|                              |                         | 38. CIRCUIT BREAKER PANEL        |
|                              |                         | 39. CLIMATE CONTROL PANEL        |

TYPICAL INSTRUMENT PANEL.

Figure 7-25

Instrument panel lighting can be dimmed or brightened by rheostat switches to the right of the control quadrant. Back-lights and a red flood light are optional equipment. When instrument panel lights are turned on, annunciator lights are dimmed. However, they will not show dim when the press-to-test switch is depressed.

## **7.25 HEATING, VENTILATING AND DEFROSTING SYSTEM**

Heated air for cabin heat and windshield defrosting is provided by a Janitrol combustion heater located in the forward fuselage (refer to Figure 7-27). Air from the heater is distributed by a manifold to the ducts along the cabin floor to outlets at each seat and to the defroster outlets.

Operation of the combustion heater is controlled by a three-position switch located on the instrument panel (Figure 7-29) and labeled FAN, OFF and HEATER. Airflow and temperature are regulated by the three levers on the instrument panel. The upper lever regulates air intake and the center lever regulates cabin temperature. Cabin comfort can be maintained as desired through various combinations of lever positions. Passengers have secondary control over heat output by individually adjustable outlets at each seat location. The third lever on the instrument panel controls the windshield defrosters.

For cabin heat, the air intake lever on the instrument panel must be partially or fully open and the three-position switch set to the HEATER position. This simultaneously starts fuel flow and ignites the heater; and, during ground operation, it also activates the ventilation blower which is an integral part of the combustion heater. With instant starting and no need for priming, heat should be felt within a few seconds. When cabin air reaches the temperature selected on the cabin temperature lever, ignition of the heater cycles automatically to maintain the selected temperature. Two safety switches activated by the intake valve and located aft of the heater unit prevent both fan and heater operation when the air intake lever is in the closed position. A micro switch, which actuates when the landing gear is retracted, turns off the ventilation blower so that in flight the cabin air is circulated by ram air pressure only.

When the three-position switch is in the FAN position during ground operation, the ventilation fan blows fresh air through the heater duct work for cabin ventilation and windshield defogging when heat is not desired.



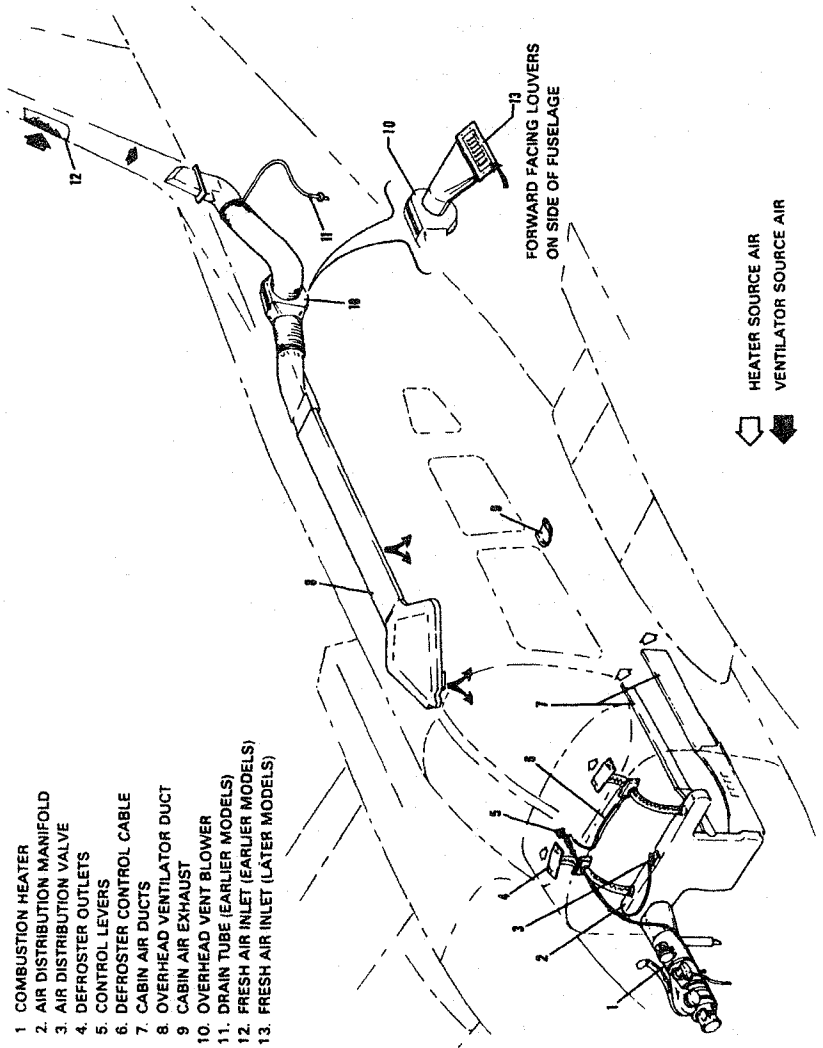

**CABIN HEATING, VENTILATING AND DEFROSTING SYSTEM**

Figure 7-27

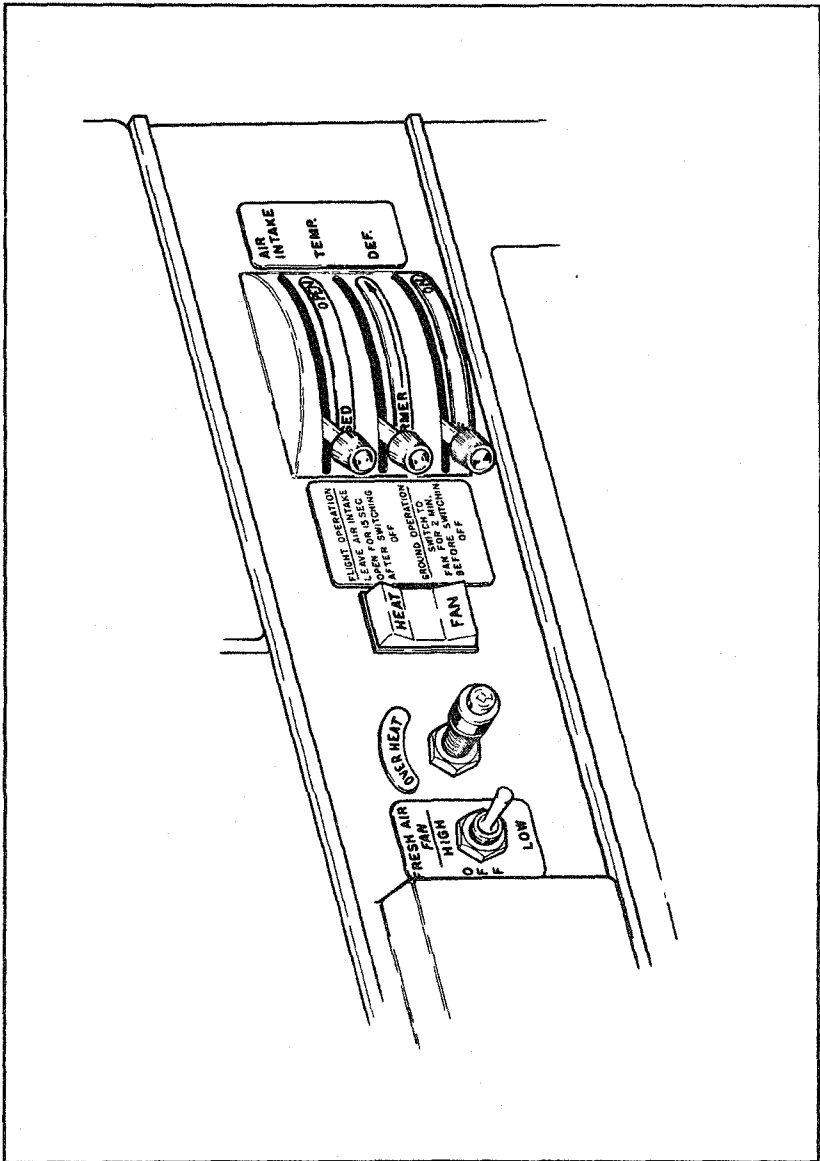

HEATING, VENTILATING & DEFROSTING CONTROL CONSOLE  
Figure 7-29

To introduce fresh, unheated air into the cabin during flight, the air intake should be open and the heater off. Ram air enters the system and can be individually regulated at each floor outlet. Overhead outlets also supply fresh air for cabin ventilation. The occupant of each seat can manually adjust an outlet in the ceiling to regulate the flow of fresh air to that seat area. An optional fresh air blower may be installed in the overhead ventilation system to provide additional fresh air flow during ground operation.

An overheat switch located in the heater unit acts as a safety device to render the heater inoperative if a malfunction should occur. Should the switch deactivate the heater, the OVERHEAT light on the instrument panel will illuminate. The overheat switch is located on the aft inboard end of the heater vent jacket. The red reset button is located on the heater shroud in the nose cone compartment.

To prevent activation of the overheat switch upon normal heater shutdown during ground operation, turn the three-position switch to FAN for two minutes with the air intake lever in the open position before turning the switch to OFF. During flight, leave the air intake lever open for a minimum of fifteen seconds after turning the switch to OFF.

The combustion heater uses fuel from the airplane fuel system. An electric fuel pump draws fuel from the left tank at a rate of approximately one-half gallon per hour. Fuel used for heater operation should be considered when planning for a flight.

## **7.27 CABIN FEATURES**

The front seats are adjustable fore and aft. Each seat reclines and is provided with an armrest. The rear seats are easily removed to provide additional cargo space.

### **NOTE**

To remove the rear seats, depress the plunger behind each front leg and slide seat to rear.

Seat belts are standard on all seats, and the front seats are equipped with adjustable shoulder harnesses. These shoulder harnesses are optionally available for the two rear seats. The shoulder harness is routed over the shoulder adjacent to the window and attached to the seat belt in the general area of the occupant's inboard hip. Adjust this fixed strap so that all controls are accessible while maintaining adequate restraint for the occupant.

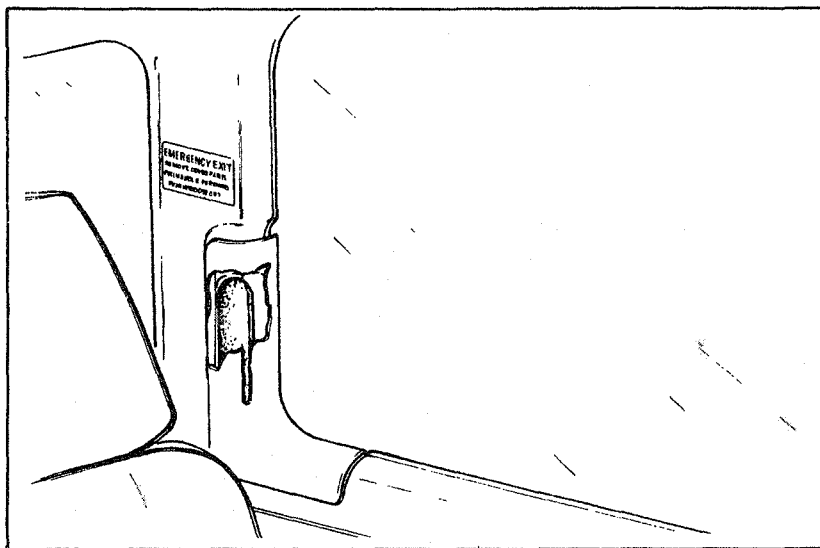

**EMERGENCY EXIT**

Figure 7-31

Shoulder harnesses with inertial reels are available for all four seats. A check of the inertial reel mechanism is made by pulling sharply on the strap. The reel should lock in place and prevent the strap from extending. For normal body movements, the strap will extend or retract as required. Other seat options include headrests and push-button, vertically adjustable pilot and copilot seats. The seat belt should be snugly fastened over each unoccupied seat.

Standard cabin features include a pilot's storm window, ashtrays, map pockets, sun visors, and pockets on the front seat backs. Among the options which may be added to suit individual needs are headrests, a fire extinguisher, and a special cabin sound-proofing package.

The pilot's left side window is an emergency exit. The emergency exit release handle is located beneath the thermoplastic cover on the vertical post between the first and second left side windows (Figure 7-31).

*CAUTION*

The emergency exit is for ground use only. When released, the window will fall free from the fuselage

**7.29 STALL WARNING**

An approaching stall is indicated by a stall warning horn which is activated between five and ten knots above stall speed. Mild airframe buffeting and gentle pitching may also precede the stall. Stall speeds are shown on a graph in the Performance Charts Section. The stall warning indication consists of a continuous sounding horn located behind the instrument panel. The stall warning horn has a different sound from that of the gear warning horn which has a 90 cycles per minute beeping sound. The stall warning horn is activated by two lift detectors on the leading edge of the left wing, outboard of the engine nacelle. The inboard detector activates the horn when the flaps are in the 25 and 40 degree positions, the outboard when the flaps are in other positions. A squat switch in the stall warning system does not allow the units to be activated on the ground.

**7.31 BAGGAGE AREA**

The 24 cubic foot baggage compartment, located aft of the seats, has a weight capacity of 200 pounds. This compartment is loaded and unloaded through a separate 22 x 20 inch baggage door, and it is accessible during flight. Tie-down straps are provided and they should be used at all times. The baggage compartment and passenger doors use the same key.

**NOTE**

It is the pilot's responsibility to be sure when baggage is loaded that the airplane C.G. falls within the allowable C.G. range. (See Weight and Balance Section.)

**7.33 FINISH**

The standard exterior finish is painted with acrylic lacquer. An optional polyurethane finish is also available. To keep the finish attractive, economy size spray cans of touch-up paint are available from Piper Dealers.

### **7.35 EMERGENCY LOCATOR TRANSMITTER\***

The Emergency Locator Transmitter (ELT) meets the requirements of FAR 91.52. It operates on self-contained batteries and is located in the aft fuselage section. It is accessible through a rectangular cover on the right hand side. A number 2 Phillips screwdriver is required to remove the cover.

A battery replacement date is marked on the transmitter. To comply with FAA regulations, the battery must be replaced on or before this date. The battery must also be replaced if the transmitter has been used in an emergency situation or if the accumulated test time exceeds one hour, or if the unit has been inadvertently activated for an undetermined time period.

#### **NOTE**

If for any reason a test transmission is necessary, the test transmission should be conducted only in the first five minutes of any hour and limited to three audio sweeps. If tests must be made at any other time, the tests should be coordinated with the nearest FAA tower or flight service station.

### **NARCO ELT 10 OPERATION**

On the ELT unit itself is a three position switch placarded "ON," "OFF" and "ARM." The ARM position sets the ELT so that it will transmit after impact and will continue to transmit until its battery is drained. The ARM position is selected when the ELT is installed in the airplane and it should remain in that position.

To use the ELT as a portable unit in an emergency, remove the cover and unlatch the unit from its mounting base. The antenna cable is disconnected by a left quarter-turn of the knurled nut and a pull. A sharp tug on the two small wires will break them loose. Deploy the self-contained antenna by pulling the plastic tab marked "PULL FULLY TO EXTEND ANTENNA." Move the switch to ON to activate the transmitter.

\*Optional equipment

In the event the transmitter is activated by an impact, it can only be turned off by moving the switch on the ELT unit to OFF. Normal operation can then be restored by pressing the small clear plastic reset button located on the top of the front face of the ELT and then moving the switch to ARM.

A pilot's remote switch located on the left side panel is provided to allow the transmitter to be turned on from inside the cabin. The pilot's remote switch is placarded "ON" and "ARMED." The switch is normally in the ARMED position. Moving the switch to ON will activate the transmitter. Moving the switch back to the ARMED position will turn off the transmitter only if the impact switch has not been activated.

The ELT should be checked to make certain the unit has not been activated during the ground check. Check by selecting 121.50 MHz on an operating receiver. If there is an oscillating chirping sound, the ELT may have been activated and should be turned off immediately. This requires removal of the access cover and moving the switch to OFF, then press the reset button and return the switch to ARM. Recheck with the receiver to ascertain the transmitter is silent.

#### **CCC CIR 11-2 OPERATION**

On the unit itself is a three position selector switch placarded "OFF," "ARM" and "ON." The ARM position is provided to set the unit to the automatic position so that it will transmit only after impact and will continue to transmit until the battery is drained to depletion or until the switch is manually moved to the OFF position. The ARM position is selected when the transmitter is installed at the factory and the switch should remain in that position whenever the unit is installed in the airplane. The ON position is provided so the unit can be used as a portable transmitter or in the event the automatic feature was not triggered by impact or to periodically test the function of the transmitter.

Select the OFF position when changing the battery, when rearming the unit if it has been activated for any reason, or to discontinue transmission.

#### **NOTE**

If the switch has been placed in the ON position for any reason, the OFF position has to be selected before selecting ARM. If ARM is selected directly from the ON position, the unit will continue to transmit in the ARM position.

A pilot's remote switch, located on the left side panel, is provided to allow the transmitter to be controlled from inside the cabin. The pilot's remote switch is placarded "ON," "AUTO/ARM" and "OFF/RESET." The switch is normally left in the AUTO/ARM position. To turn the transmitter off, move the switch momentarily to the OFF/RESET position. The aircraft master switch must be ON to turn the transmitter OFF. To actuate the transmitter for tests or other reasons, move the switch upward to the ON position and leave it in that position as long as transmission is desired.

The unit is equipped with a portable antenna to allow the locator to be removed from the aircraft in case of an emergency and used as a portable signal transmitter.

The locator should be checked during the ground check to make certain the unit has not been accidentally activated. Check by tuning a radio receiver to 121.50 MHz. If there is an oscillating sound, the locator may have been activated and should be turned off immediately. Reset to the ARM position and check again to insure against outside interference.



### **7.37 PIPER EXTERNAL POWER\***

An optional starting installation known as Piper External Power (PEP) allows the airplane engine to be started from an external battery without the necessity of gaining access to the airplane battery. The cable from the external battery can be attached to a receptacle under the right side of the nose section of the fuselage. Instructions on a placard located on the cover of the receptacle should be followed when starting with external power. For instructions on the use of the PEP, refer to Starting Engines - Section 4

### **7.39 PROPELLER SYNCHROPHASER\***

A propeller synchrophaser installation is available as optional equipment. Its function is to maintain both propellers at the same RPM and at a preselected phase angle. This eliminates the propeller "beat" effect and minimizes vibration. When the synchrophaser is installed, the left engine is established as the master engine, and the right engine is equipped with a slave governor which automatically maintains its RPM with the left engine RPM. When the propeller synchrophaser is installed, a two-position switch is located on the throttle quadrant below the propeller controls. It is labeled "MANUAL" for manual control or standby and "AUTO SYNC" for propeller synchrophaser.

During taxi, takeoff, landing or single engine operations the propeller synchrophaser switch should be in the MANUAL position. During cruise, propellers should be synchronized manually to within approximately 10 RPM and the switch placed in the AUTO SYNC position. Normally, propeller synchrophasing will take place within a few seconds, but occasionally it may take up to a full minute. When the power setting is to be changed, the synchrophaser switch should be set to MANUAL for 30 seconds before the power setting is adjusted; then the synchrophaser switch may be returned to the AUTO SYNC position. If the propeller RPM differential exceeds 50 RPM, the switch should be placed on MANUAL for 30 to 40 seconds; then the propellers can be synchronized again and the synchrophaser switch returned to AUTO SYNC. Pulling the circuit breakers completely deactivates the propeller synchrophaser system. If the master switch is turned OFF or if there is an electrical system failure, the slave engine will return to the controlled, selected RPM plus approximately 25 RPM's "out of synchronization" regardless of the position of the synchrophaser switch.

\*Optional equipment

### **7.41 CARBURETOR ICE DETECTION SYSTEM**

A carburetor ice detection system is available as an option on this airplane.

The system consists of a control box mounted on the instrument panel, a probe sensor mounted in the carburetor and a red warning light to indicate the presence of ice in the carburetor.

If ice is present, apply full carburetor heat. Refer to 3 37, Carburetor Icing, in the emergency procedures.

To adjust the system for critical ice detection, first turn on the airplane's master switch and then turn on the ice detection unit. Turn the sensitivity knob fully counterclockwise causing the carb ice light to come on. Now rotate the sensitivity knob back (clockwise) until the ice light just goes out. This establishes the critical setting.

#### ***WARNING***

This instrument is approved as optional equipment only and Flight Operations should not be predicated on its use.



## TABLE OF CONTENTS

### SECTION 8

#### AIRPLANE HANDLING, SERVICING AND MAINTENANCE

Paragraph No.		Page No.
8.1	General .....	8-1
8.3	Airplane Inspection Periods .....	8-2
8.5	Preventive Maintenance .....	8-3
8.7	Airplane Alterations .....	8-4
8.9	Ground Handling .....	8-5
8.11	Engine Induction Air Filters .....	8-7
8.13	Brake Service .....	8-8
8.15	Landing Gear Service .....	8-8
8.17	Propeller Service .....	8-10
8.19	Oil Requirements .....	8-10
8.21	Fuel System .....	8-11
8.23	Tire Inflation .....	8-13
8.25	Battery Service .....	8-13
8.27	Serial Number Plates .....	8-14
8.29	Lubrication .....	8-14
8.31	Cleaning .....	8-14
8.33	Winterization .....	8-17



## **SECTION 8**

### **AIRPLANE HANDLING, SERVICING, AND MAINTENANCE**

#### **8.1 GENERAL**

This section provides guidelines relating to the handling, servicing, and maintenance of the Seminole. For complete maintenance instructions, refer to the PA-44-180 Maintenance Manual.

Every owner should stay in close contact with an authorized Piper Service Center or Piper's Customer Service Department to obtain the latest information pertaining to their airplane, and to avail himself of Piper Aircraft's support systems.

Piper Aircraft Corporation takes a continuing interest in having the owner get the most efficient use from his airplane and keeping it in the best mechanical condition. Consequently, Piper Aircraft, from time to time, issues service releases including Service Bulletins, Service Letters, Service Spares Letters, and others relating to the aircraft.

Service Bulletins are of special importance and Piper considers compliance mandatory. These are sent directly to the latest FAA-registered owners in the United States (U.S.) and Piper Service Centers worldwide. Depending on the nature of the release, material and labor allowances may apply. This information is provided to all authorized Service Centers.

Service Letters deal with product improvements and servicing techniques pertaining to the airplane. They are sent to Piper Service Centers and, if necessary, to the latest FAA-registered owners in the U.S. Owners should give careful attention to Service Letter information.

Service Spares Letters offer improved parts, kits, and optional equipment which were not available originally and which may be of interest to the owner.

Piper Aircraft Corporation offers a subscription service for the Service Bulletins, Service Letters, and Service Spares Letters. This service is available to interested persons, such as owners, pilots, and mechanics at a nominal fee, and may be obtained through an authorized Piper Service Center or Piper's Customer Services Department.

Maintenance manuals, parts catalogs, and revisions to both, are available from Piper Service Centers or Piper's Customer Services Department.

Any correspondence regarding the airplane should include the airplane model and serial number to ensure proper response.

### **8.3 AIRPLANE INSPECTION PERIODS**

Piper Aircraft Corporation has developed inspection items and required inspection intervals (i.e.: 50, 100, 500, and 1000 hours) for the specific model aircraft. Appropriate forms are contained in the applicable Piper Service/Maintenance Manual, and should be complied with by a properly trained, knowledgeable, and qualified mechanic at a Piper Authorized Service Center or a reputable repair shop. Piper Aircraft Corporation cannot accept responsibility for the continued airworthiness of any aircraft not maintained to these standards, and/or not brought into compliance with applicable Service Bulletins issued by Piper Aircraft Corporation, instructions issued by the engine, propeller, or accessory manufacturers, or Airworthiness Directives issued by the FAA.

A programmed inspection, approved by the Federal Aviation Administration (FAA), is also available to the owner. This involves routine and detailed inspections to allow maximum utilization of the airplane. Maintenance inspection costs are reduced, and the maximum standard of continued airworthiness is maintained. Complete details are available from Piper Aircraft Corporation.

In addition, but in conjunction with the above, the FAA requires periodic inspections on all aircraft to keep the Airworthiness Certificate in effect. The owner is responsible for assuring compliance with these inspection requirements and for maintaining proper documentation in logbooks and/or maintenance records.

A spectographic analysis of the engine oil is available from several sources. This inspection, if performed properly, provides a good check of the internal condition of the engine. To be accurate, induction air filters must be cleaned or changed regularly, and oil samples must be taken and sent in at regular intervals.

### **8.5 PREVENTIVE MAINTENANCE**

The holder of a Pilot Certificate issued under FAR Part 61 may perform certain preventive maintenance described in FAR Part 43. This maintenance may be performed only on an aircraft which the pilot owns or operates and which is not used to carry persons or property for hire. Although such maintenance is allowed by law, each individual should make a self-analysis as to whether he has the ability to perform the work.

All other maintenance required on the airplane should be accomplished by appropriately licensed personnel.

If maintenance is accomplished, an entry must be made in the appropriate logbook. The entry should contain:

- (a) The date the work was accomplished.
- (b) Description of the work.
- (c) Number of hours on the aircraft.
- (d) The certificate number of pilot performing the work.
- (e) Signature of the individual doing the work.



### **8.7 AIRPLANE ALTERATIONS**

If the owner desires to have his aircraft modified, he must obtain FAA approval for the alteration. Major alterations accomplished in accordance with Advisory Circular 43 13-2, when performed by an A & P mechanic, may be approved by the local FAA office. Major alterations to the basic airframe or systems not covered by AC 43.13-2 require a Supplemental Type Certificate.

The owner or pilot is required to ascertain that the following Aircraft Papers are in order and in the aircraft.

- (a) To be displayed in the aircraft at all times:
  - (1) Aircraft Airworthiness Certificate Form FAA-8100-2
  - (2) Aircraft Registration Certificate Form FAA-8050-3.
  - (3) Aircraft Radio Station License if transmitters are installed
  
- (b) To be carried in the aircraft at all times.
  - (1) Pilot's Operating Handbook
  - (2) Weight and Balance data plus a copy of the latest Repair and Alteration Form FAA-337, if applicable.
  - (3) Aircraft equipment list.

Although the aircraft and engine logbooks are not required to be in the aircraft, they should be made available upon request. Logbooks should be complete and up to date. Good records will reduce maintenance cost by giving the mechanic information about what has or has not been accomplished.

## **8.9 GROUND HANDLING**

### **(a) Towing**

The airplane may be moved on the ground by the use of the nose wheel steering bar that is stowed in the baggage compartment or by power equipment that will not damage or excessively strain the nose gear steering assembly.

#### *CAUTIONS*

When towing with power equipment, do not turn the nose gear beyond its steering radius in either direction, as this will result in damage to the nose gear and steering mechanism.

Do not tow the airplane when the controls are secured.

In the event towing lines are necessary, ropes should be attached to both main gear struts as high up on the tubes as possible. Lines should be long enough to clear the nose and/or tail by not less than fifteen feet, and a qualified person should ride in the pilot's seat to maintain control by use of the brakes.

### **(b) Taxiing**

Before attempting to taxi the airplane, ground personnel should be instructed and approved by a qualified person authorized by the owner. Engine starting and shut-down procedures as well as taxi techniques should be covered. When it is ascertained that the propeller back blast and taxi areas are clear, power should be applied to start the taxi roll, and the following checks should be performed:

- (1) Taxi a few feet forward and apply the brakes to determine their effectiveness.
- (2) Taxi with the propeller set in low pitch, high RPM setting.
- (3) While taxiing, make slight turns to ascertain the effectiveness of the steering.
- (4) Observe wing clearance when taxiing near buildings or other stationary objects. If possible, station an observer outside the airplane.
- (5) When taxiing over uneven ground, avoid holes and ruts.

- (6) Do not operate the engine at high RPM when running up or taxiing over ground containing loose stones, gravel, or any loose material that may cause damage to the propeller blades.

**(c) Parking**

When parking the airplane, be sure that it is sufficiently protected from adverse weather conditions and that it presents no danger to other aircraft. When parking the airplane for any length of time or overnight, it is suggested that it be moored securely.

- (1) To park the airplane, head it into the wind if possible.
- (2) Set the parking brake by depressing the toe brakes and pulling out the parking brake control. To release the parking brake, depress the toe brakes and push in the parking brake control, then release the toe brakes.

**CAUTION**

Care should be taken when setting brakes that are overheated or during cold weather when accumulated moisture may freeze a brake.

- (3) Aileron and stabilator controls should be secured with the front seat belt and chocks used to properly block the wheels.

**(d) Mooring**

The airplane should be moored for immovability, security and protection. The following procedures should be used for the proper mooring of the airplane:

- (1) Head the airplane into the wind if possible.
- (2) Retract the flaps.
- (3) Immobilize the ailerons and stabilator by looping the seat belt through the control wheel and pulling it snug.
- (4) Block the wheels.
- (5) Secure tie-down ropes to the wing tie-down rings and to the tail skid at approximately 45 degree angles to the ground. When using rope of non-synthetic material, leave sufficient slack to avoid damage to the airplane should the ropes contract.

**CAUTION**

Use bowline knots, square knots or locked slip knots. Do not use plain slip knots.

**NOTE**

Additional preparations for high winds include using tie-down ropes from the landing gear forks and securing the rudder.

- (6) Install a pitot head cover if available. Be sure to remove the pitot head cover before flight.
- (7) Cabin and baggage doors should be locked when the airplane is unattended.

**8.11 ENGINE INDUCTION AIR FILTERS**

**(a) Removing Induction Air Filter**

- (1) Remove the upper cowling to gain access to the air filter box.
- (2) Turn the three studs and remove the air filter box cover.
- (3) Lift the air filter from the filter box.

**(b) Cleaning Induction Air Filters**

The induction air filters must be cleaned at least once every 50 hours, and more often, even daily, when operating in dusty conditions. Extra filters are inexpensive, and a spare should be kept on hand for use as a rapid replacement.

To clean the filter:

- (1) Tap filter gently to remove dirt particles. Do not use compressed air or cleaning solvents.
- (2) Inspect filter. If paper element is torn or ruptured or gasket is damaged, the filter should be replaced. The usable life of the filter should be restricted to one year or 500 hours, whichever comes first.

(c) Installation of Induction Air Filters

After cleaning, place filter in air box and install cover. Secure cover by turning studs. Replace cowl.

### **8.13 BRAKE SERVICE**

The brake system is filled with MIL-H-5606 (petroleum base) hydraulic brake fluid. This should be checked periodically or at every 50-hour inspection and replenished when necessary. The brake reservoir is located in the forward maintenance area. Remove the four screws and rotate the fiberglass nose cone forward and down. The reservoir is located at the top rear of the compartment. Keep the fluid level at the level marked on the reservoir.

No adjustment of brake clearance is necessary. Refer to the Service Manual for brake lining replacement instructions.

### **8.15 LANDING GEAR SERVICE**

Two jack points are provided for jacking the aircraft for servicing. One is located outboard of each main landing gear. Before jacking, attach a tail support to the tail skid. Approximately 500 pounds of ballast should be placed on the tail support.

#### **CAUTION**

Be sure to apply sufficient support ballast; otherwise the airplane may tip forward, and the nose section could be damaged.

Landing gear oleos should be serviced according to instruction on the units. Under normal static load (empty weight of airplane plus full fuel and oil), main oleo struts should be exposed 2.60 inches and the nose oleo strut should be exposed 2.70 inches. Refer to the Service Manual for complete information on servicing oleo struts.

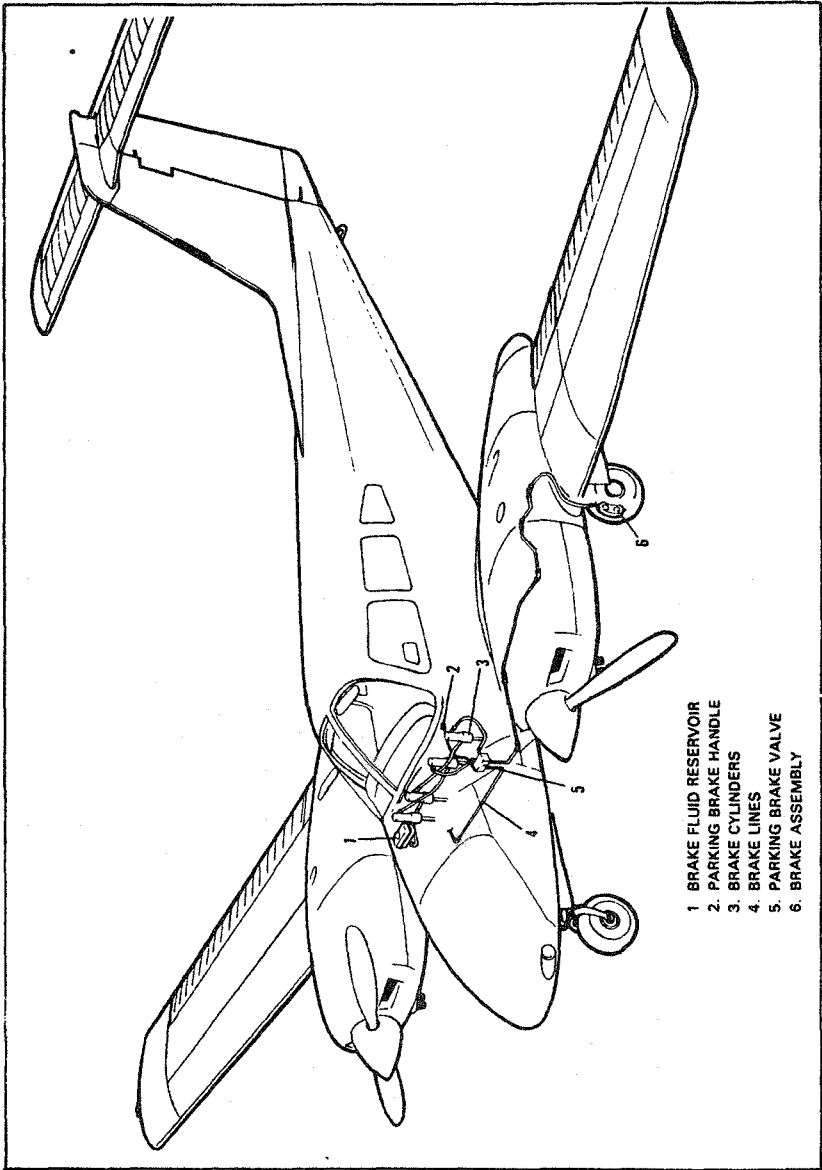

- 1. BRAKE FLUID RESERVOIR
- 2. PARKING BRAKE HANDLE
- 3. BRAKE CYLINDERS
- 4. BRAKE LINES
- 5. PARKING BRAKE VALVE
- 6. BRAKE ASSEMBLY

**BRAKE SYSTEM**  
Figure 8-1

**8.17 PROPELLER SERVICE**

The gas charge in the propeller cylinder should be kept at the pressure specified on the placard located in the spinner cap. The pressure in the cylinder will increase about one-third psi for every degree Fahrenheit increase in temperature. This effect should be considered when checking pressure. The charge maintained must be accurate and free of excessive moisture since moisture may freeze the piston during cold weather. Dry nitrogen gas is recommended.

**CHAMBER PRESSURE REQUIREMENTS WITH  
TEMPERATURE FOR COUNTERWEIGHT TYPE PROPELLERS**

Temp. °F	Pressure (PSI)
<b>FOR PROPELLER HUBS. HC-C2Y(K,R)-2CEUF, HC-C2Y(K,R)-2CLEUF, HC-C3YK-2EUF AND HC-C3YK-2LEUF</b>	
70 to 100	41 +/- 1
40 to 70	38 +/- 1
0 to 40	36 +/- 1
-30 to 0	33 +/- 1

**NOTE.** Do not check pressure or charge with propeller in feather position.

The spinner and backing plate should be cleaned and inspected for cracks frequently. Before each flight the propeller should be inspected for nicks, scratches, or corrosion. If found, they should be repaired as soon as possible by a rated mechanic, since a nick or scratch causes an area of increased stress which can lead to serious cracks or the loss of a propeller tip. The back face of the blades should be painted when necessary with flat black paint to retard glare. To prevent corrosion, all surfaces should be cleaned and waxed periodically.

**8.19 OIL REQUIREMENTS**

The oil capacity of the Lycoming engines is 6 quarts per engine with a minimum safe quantity of 2 quarts per engine. It is necessary that oil be maintained at full for maximum endurance flights. It is recommended that engine oil be drained and renewed every 50 hours, or sooner under

unfavorable conditions. Full flow cartridge type oil filters should be replaced each 50 hours of operation. The interval between oil and oil filter change is not to exceed four (4) months. Lycoming Service Bulletin No. 446 should be complied with each 50 hours, also. The following grades are required for temperatures:

<u>Average Ambient Temperature</u>	<u>MIL-L-6082B SAE Grade</u>	<u>MIL-L-22851 Ashless Dispersant SAE Grades</u>
All Temperatures	--	15W-50 or 20W-50
Above 80° F	60	60
Above 60° F	50	40 or 50
30° F to 90° F	40	40
0° F to 70° F	30	30, 40 or 20W-40
Below 10° F	20	30 or 20W-30

When operating temperatures overlap indicated ranges, use the lighter grade oil.

**NOTE**

Refer to the latest issue of Lycoming Service Instruction 1014 (Lubricating Oil Recommendations) for further information.

**8.21 FUEL SYSTEM**

**(a) Servicing Fuel System**

The fuel screens in the strainers require cleaning at 50 hour or 90 day intervals, whichever occurs first. The fuel gascolator strainers are located in the fuselage under the rear seats. The fuel selector valves and the auxiliary pumps are in the wings adjacent to the nacelles.

**(b) Fuel Requirements**

The minimum aviation grade fuel for the PA-44-180 is 100. Since the use of lower grades can cause serious engine damage in a short period of time, the engine warranty is invalidated by the use of lower octanes.

Whenever 100 or 100LL grade fuel is not available, commercial grade 100/130 should be used. (See Fuel Grade Comparison Chart.) Refer to the latest issued of Lycoming Service Instruction No. 1070 for additional information.



A summary of current grades as well as the previous fuel designations is shown in the following chart:

**FUEL GRADE COMPARISON CHART**

Previous Commercial Fuel Grades (ASTM-D910)			Current Commercial Fuel Grades (ASTM-D910-75)			Current Military Fuel Grades (MIL-G-5572E) Amendment No 3		
Grade	Color	Max TEL ml/U S gal	Grade	Color	Max TEL ml/U S gal	Grade	Color	Max TEL ml/U S gal
80/87	red	0.5	80	red	0.5	80/87	red	0.5
91/98	blue	2.0	*100LL	blue	2.0	none	none	none
100/130	green	3.0	100	green	**3.0	100/130	green	**3.0
115/145	purple	4.6	none	none	none	115/145	purple	4.6

- \* - Grade 100LL fuel in some overseas countries is currently colored green and designated as "100L."
- \*\* - Commercial fuel grade 100 and grade 100/130 (both of which are colored green) having TEL content of up to 4 ml/U S gallon are approved for use in all engines certified for use with grade 100/130 fuel

The operation of the aircraft is approved with an anti-icing additive in the fuel. When an anti-icing additive is used it must meet the specification MIL-1-27686, must be uniformly blended with the fuel while refueling, must not exceed .15% by volume of the refueled quantity, and to ensure its effectiveness should be blended at not less than .10% by volume. One and one half liquid ozs. per ten gallon of fuel would fall within this range. A blender supplied by the additive manufacturer should be used. Except for the information contained in this section, the manufacturer's mixing or blending instructions should be carefully followed.

**CAUTION**

Assure that the additive is directed into the flowing fuel stream. The additive flow should start after and stop before the fuel flow. Do not permit the concentrated additive to come in contact with the aircraft painted surfaces or the interior surfaces of the fuel tanks

*CAUTIONS*

Some fuels have anti-icing additives pre-blended in the fuel at the refinery, so no further blending should be performed.

Fuel additive can not be used as a substitute for preflight draining of the fuel system.

(c) Filling Fuel Tanks

Observe all safety precautions required when handling gasoline. Fill the fuel tanks through the fillers located inside the access cover aft of the engine cowling on the outboard side of the nacelles. Each nacelle tank holds a maximum of 55 U.S. gallons. When using less than the standard 110 gallon capacity, fuel should be distributed equally between each side.

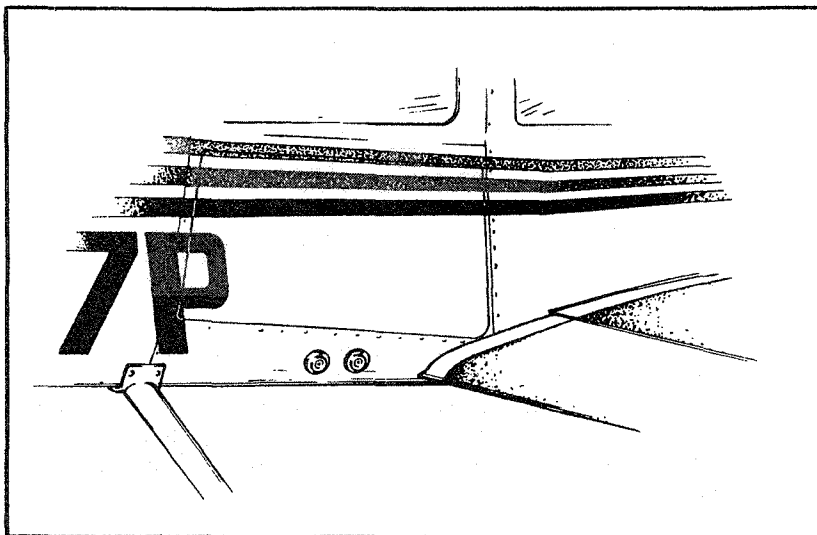

**FUEL DRAINS**  
Figure 8-2

**(d) Draining Fuel Strainers, Sumps and Lines**

The aircraft is equipped with single point drains which should be drained before the first flight of the day and after refueling, to check for fuel contamination. If contamination is found, fuel should be drained until the contamination stops. If contamination persists after draining fuel for a minute, contact a mechanic to check the fuel system.

Each half of the fuel system can be drained from a single point which is located just forward of the entrance step. Fuel selectors should be in the ON position during draining. The fuel drained should be collected in a transparent container and examined for contamination.

**CAUTION**

When draining fuel, be sure that no fire hazard exists before starting the engines.

(e) Draining Fuel System

The fuel may be drained by opening the valves at the right hand side of the fuselage just forward of the entrance step or by siphoning. The remaining fuel in the lines may be drained through the gascolators.

### **8.23 TIRE INFLATION**

For maximum service from the tires, keep them inflated to the proper pressures. The main gear tires should be inflated to 55 psi and the nose gear should be inflated to 50 psi.

Interchange the tires on the main wheels, if necessary, to produce even wear. All wheels and tires are balanced before original installation, and the relationship of the tire, tube, and wheel should be maintained if at all possible. Unbalanced wheels can cause extreme vibration on takeoff. In the installation of new components, it may be necessary to rebalance the wheel with the tire mounted.

When checking the pressure, examine the tires for wear, cuts, bruises and slippage.

### **8.25 BATTERY SERVICE**

Access to the 12-volt 35 ampere hour battery is gained through the fiberglass nose cone. The battery container has a plastic drain tube which is normally closed off. This tube should be opened occasionally to drain off any accumulation of liquid.

The battery fluid level must not be brought above the baffle plates. It should be checked every 30 days to determine that the fluid level is proper and the connections are tight and free of corrosion. **DO NOT** fill the battery above the baffle plates. **DO NOT** fill the battery with acid - use distilled water only. A hydrometer check will determine the percent of charge in the battery.

If the battery is not properly charged, recharge it starting with a rate of 4 amperes and finishing with a rate of 2 amperes. Quick charges are not recommended.

The external power receptacle, if installed, is located on the left side of the nose section. Be sure the master switch is off while inserting or removing a plug at this receptacle.

Refer to the Service Manual for detailed procedures for cleaning and servicing the battery.

### **8.27 SERIAL NUMBER PLATES**

The serial number plate is located on the bottom of the fuselage near the aft end of the tail cone. The serial number should always be used when referring to the airplane on service or warranty matters.

### **8.29 LUBRICATION**

Lubrication at regular intervals is an essential part of the maintenance of an airplane. For lubrication instructions and a chart showing lubrication points, types of lubricants to be used, lubrication methods and recommended frequencies, refer to the Service Manual.

### **8.31 CLEANING**

#### **(a) Cleaning Engine Compartment**

Before cleaning the engine compartment, place a strip of tape on the magneto vents to prevent any solvent from entering these units.

- (1) Place a large pan under the engine to catch waste.
- (2) With the engine cowling removed, spray or brush the engine with solvent or a mixture of solvent and degreaser. In order to remove especially heavy dirt and grease deposits, it may be necessary to brush areas that were sprayed.

#### **CAUTION**

Do not spray solvent into the alternator, vacuum pump, starter, air intakes, or alternate air inlets

- (3) Allow the solvent to remain on the engine from five to ten minutes. Then rinse the engine clean with additional solvent and allow it to dry.

*CAUTION*

Do not operate the engine until excess solvent has evaporated or otherwise been removed.

- (4) Remove the protective tape from the magnetos.
- (5) Lubricate the controls, bearing surfaces, etc., in accordance with the Lubrication Chart in the Service Manual.

(b) Cleaning Landing Gear

Before cleaning the landing gear, place a plastic cover or similar material over the wheel and brake assembly.

- (1) Place a pan under the gear to catch waste.
- (2) Spray or brush the gear area with solvent or a mixture of solvent and degreaser, as desired. Where heavy grease and dirt deposits have collected, it may be necessary to brush areas that were sprayed, in order to clean them.
- (3) Allow the solvent to remain on the gear from five to ten minutes. Then rinse the gear with additional solvent and allow to dry.
- (4) Remove the cover from the wheel and remove the catch pan.
- (5) Lubricate the gear in accordance with the Lubrication Chart in the Service Manual.
- (6) Caution: Do not brush the micro switches.

(c) Cleaning Exterior Surfaces

The airplane should be washed with a mild soap and water. Harsh abrasives or alkaline soaps or detergents could make scratches on painted or plastic surfaces or could cause corrosion of metal. Cover areas where cleaning solution could cause damage. To wash the airplane, use the following procedure:

- (1) Flush away loose dirt with water.
- (2) Apply cleaning solution with a soft cloth, a sponge or a soft bristle brush.
- (3) To remove exhaust stains, allow the solution to remain on the surface longer.

- (4) To remove stubborn oil and grease, use a cloth dampened with naphtha.
- (5) Rinse all surfaces thoroughly.
- (6) Any good automotive wax may be used to preserve painted surfaces. Soft cleaning cloths or a chamois should be used to prevent scratches when cleaning or polishing. A heavier coating of wax on the leading surfaces will reduce the abrasion problems in these areas.

**(d) Cleaning Windshield and Windows**

- (1) Remove dirt, mud and other loose particles from exterior surfaces with clean water.
- (2) Wash with mild soap and warm water or with aircraft plastic cleaner. Use a soft cloth or sponge in a straight back and forth motion. Do not rub harshly.
- (3) Remove oil and grease with a cloth moistened with kerosene.

**CAUTION**

Do not use gasoline, alcohol, benzene, carbon tetrachloride, thinner, acetone, or window cleaning sprays.

- (4) After cleaning plastic surfaces, apply a thin coat of hard polishing wax. Rub lightly with a soft cloth. Do not use a circular motion.
- (5) A severe scratch or mar in plastic can be removed by rubbing out the scratch with jeweler's rouge. Smooth both sides and apply wax.

**(e) Cleaning Headliner, Side Panels and Seats**

- (1) Clean headliner, side panels, and seats with a stiff brush, and vacuum where necessary.
- (2) Soiled upholstery, except leather, may be cleaned with a good upholstery cleaner suitable for the material. Carefully follow the manufacturer's instructions. Avoid soaking or harsh rubbing.

*CAUTION*

Solvent cleaners require adequate ventilation.

- (3) Leather should be cleaned with saddle soap or a mild hand soap and water.

(f) **Cleaning Carpets**

To clean carpets, first remove loose dirt with a whisk broom or vacuum. For soiled spots and stubborn stains use a noninflammable dry cleaning fluid. Floor carpets may be removed and cleaned like any household carpet.

**8.33 WINTERIZATION**

For winter operation a winterization kit is installed on the inlet opening of the oil cooler outboard chamber of the plenum chamber. This kit should be installed whenever the ambient temperature is 50° F or less. When the kit is not being used it can be stowed in the nose cone compartment.





## TABLE OF CONTENTS

### SECTION 9

#### SUPPLEMENTS

Paragraph/Supplement No.		Page No.
9.1	General .....	9-1
1	AutoControl IIIB Autopilot Installation .....	9-3
2	AltiMatic IIIC Autopilot Installation .....	9-9
3	Piper Electric Pitch Trim .....	9-21
4	KNS 80 Navigation System .....	9-23
5	ANS 351 Area Navigation Computer .....	9-27
6	Air Conditioning Installation .....	9-31
7	Century 21 Autopilot Installation .....	9-37
8	Century 41 Autopilot Installation .....	9-41
9	Piper Control Wheel Clock Installation .....	9-53
10	RCA WeatherScout II Weather Radar System .....	9-55
11	RDR-160 Weather Radar System .....	9-61
12	RDR-160/IN-2026A Weather Radar System .....	9-67
13	RCA Color WeatherScout II Weather Radar System ...	9-73
14	Electrical Distribution Bus Modification .....	9-79

1914-1915

1914-1915

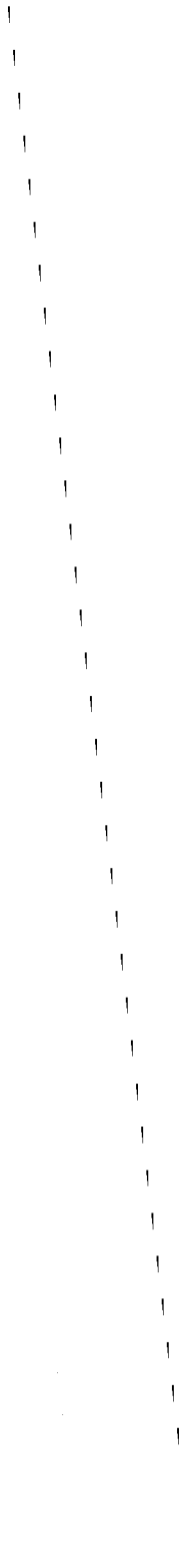

**SECTION 9  
SUPPLEMENTS**

**9.1 GENERAL**

This section provides information in the form of supplements which are necessary for efficient operation of the airplane when it is equipped with one or more of the various optional systems and equipment not approved with the standard airplane.

All of the supplements provided in this section are "FAA Approved" and consecutively numbered as a permanent part of this handbook. The information contained in each supplement applies only when the related equipment is installed in the airplane.

**THIS PAGE INTENTIONALLY LEFT BLANK**

**SUPPLEMENT 1**

**AUTOCONTROL IIIB AUTOPILOT INSTALLATION**

**SECTION 1 - GENERAL**

This supplement supplies information necessary for the operation of the airplane when the optional Piper AutoControl IIIB Autopilot is installed. The information contained within this supplement is to be used in conjunction with the complete handbook.

This supplement has been "FAA Approved" as a permanent part of this handbook based on EDO-AIRE Mitchell STC SA3276SW-D and must remain in this handbook at all times when the optional Piper AutoControl IIIB Autopilot is installed.

**SECTION 2 - LIMITATIONS**

- (a) Autopilot operation prohibited above 185 KIAS. (Autopilot Vmo)
- (b) Autopilot must be "OFF" for takeoff and landing.

**SECTION 3 - EMERGENCY PROCEDURES**

- (a) In an emergency the AutoControl IIIB can be disconnected by pushing the AP ON-OFF switch "OFF."
- (b) The autopilot can be overpowered at either control wheel.
- (c) An autopilot runaway, with a 3 second delay in the initiation of recovery while operating in climb, cruise or descending flight, could result in a 58° bank and 190 foot altitude loss. Maximum altitude loss measured at 185 KIAS in descent.
- (d) An autopilot runaway, with a 1 second delay in the initiation of recovery during an approach operation, single or multi-engine, coupled or uncoupled, could result in a 12° bank and 20 foot altitude loss.

- (e) Emergency operation with optional NSD 360A (HSI) - Slaved and/or Non-Slaved:

**NSD 360A**

- (1) Appearance of HDG Flag:
  - a. Check air supply gauge (vac or pressure) for adequate air supply (4 in. Hg. min.).
  - b. Check compass circuit breaker.
  - c. Observe display for proper operation.
- (2) To disable heading card - pull circuit breaker and use magnetic compass for directional data.

**NOTE**

If heading card is not operational, autopilot should not be used.

- (3) With card disabled, VOR/Localizer and Glide Slope displays are still functional; use card set to rotate card to aircraft heading for correct picture.
- (4) Slaving Failure - (i.e. failure to self-correct for gyro drift):
  - a. Check gyro slaving switch is set to No. 1 position.
  - b. Check for HDG Flag.
  - c. Check compass circuit breaker.
  - d. Reset heading card while observing slaving meter.

**NOTE**

Dead slaving meter needle or needle displaced fully one direction indicates a slaving system failure.

- e. Select slaving amplifier No. 2 (gyro slaving switch is set to No. 2 position).
- f. Reset heading card while checking slaving meter.
- g. Switch to free gyro mode and periodically set card as unslaved gyro.

**NOTE**

In the localizer mode the "TO-FROM" arrows may remain out of view, depending upon the design of the NAV converter used in the installation.

**SECTION 4 - NORMAL PROCEDURES**

**PREFLIGHT**

**(a) AUTOPILOT**

- (1) Place radio coupler in HDG mode (if installed) and place the AP "ON-OFF" switch to the "ON" position to engage roll section. Rotate roll command knob left and right and observe that control wheel describes a corresponding left and right turn, then center knob.
- (2) Set proper D.G. heading on D.G. and turn HDG bug to aircraft heading. Engage HDG mode rocker switch and rotate HDG bug right and left. Aircraft control wheel should turn same direction as bug. Grasp control wheel and manually override servo, both directions.

**(b) RADIO COUPLER - (OPTIONAL)**

- (1) Tune and identify VOR or VOT station. Position radio coupler to OMNI mode. Place autopilot and HDG switches to the ON position. Set HDG bug to aircraft heading and rotate OBS to cause OMNI indicator needle to swing left and right slowly. Observe that control wheel rotates in direction of needle movement.
- (2) Disengage AP "ON-OFF" switch. Reset radio coupler control to HDG.

**IN-FLIGHT**

- (a) Trim airplane (ball centered).
- (b) Check air pressure or vacuum to ascertain that the directional gyro and attitude gyro are receiving sufficient air.



(c) Roll Section

- (1) To engage, center ROLL COMMAND knob, push AP "ON-OFF" switch to "ON" position. To turn, rotate ROLL COMMAND knob in desired direction. (Maximum angle of bank should not exceed 30°.)
- (2) For heading mode, set directional gyro with magnetic compass. Push directional gyro HDG knob in, rotate bug to aircraft heading. Push console heading rocker (HDG) switch to "ON" position. To select a new aircraft heading, push D.G. heading knob "IN" and rotate, in desired direction of turn, to the desired heading.

(d) Radio Coupling VOR-ILS with H.S.I. (Horizontal Situation Indicator) Type Instrument Display. (Optional)

(1) VOR Navigation

- a. Tune and identify VOR station. Select desired course by rotating CRS knob of H.S.I.
- b. Select OMNI mode on radio coupler.
- c. Select HDG mode on autopilot console to engage coupler. Aircraft will turn to a 45° intercept angle to intercept the selected VOR course. Intercept angle magnitude depends on radio needle off course magnitude, 100% needle deflection will result in 45° intercept with the intercept angle diminishing as the needle offset diminishes.
- d. NAV mode - NAV mode provides reduced VOR sensitivity for tracking weak, or noisy VOR signals. NAV mode should be selected after the aircraft is established on course.

(2) ILS-LOC Front Course

- a. Set inbound, front, localizer course with H.S.I. course knob.
- b. Select LOC-Normal on radio coupler to intercept and track inbound on the localizer. Select LOC-REV to intercept and track the localizer course outbound to the procedure turn area.
- c. Select HDG mode on autopilot console to engage coupler.

- (3) ILS - Back Course
  - a. Set inbound, front localizer course with H.S.I. course knob.
  - b. Select LOC-REV on radio coupler to intercept and track inbound on the back localizer course. Select LOC-NORM to intercept and track outbound on the back course to the procedure turn area.
  - c. Select HDG mode on autopilot console to engage coupler.
  
- (e) Radio Coupling - VOR/ILS with standard directional gyro. (Optional)

Radio coupler operation in conjunction with a standard directional gyro and VOR/LOC display differs from operation with an integrated display (H.S.I.) only in one respect. The HDG bug is used as the radio course datum and therefore must be set to match the desired VOR course as selected on the OBS.

  - (1) For VOR intercepts and tracking:

Select the desired VOR course and set the HDG bug to the same heading. Select OMNI mode on the coupler and HDG mode on the autopilot console.
  - (2) For ILS Front Course intercepts and tracking:

Tune the localizer frequency and place the HDG bug on the inbound, front course heading. Select LOC-NORM mode on the coupler and HDG mode on the autopilot console.
  - (3) For LOC Back Course intercepts and tracking:

Tune the localizer frequency and place the HDG bug on the inbound course heading to the airport. Select LOC-REV mode with coupler and HDG mode on the autopilot console.

## **SECTION 5 - PERFORMANCE**

No changes to the basic performance provided by Section 5 of the Pilot's Operating Handbook are necessary for this supplement.

**THIS PAGE INTENTIONALLY LEFT BLANK**

**SUPPLEMENT 2**

**ALTIMATIC IIIC AUTOPILOT INSTALLATION**

**SECTION 1 - GENERAL**

This supplement supplies information necessary for the operation of the airplane when the optional AltiMatic IIIC Autopilot is installed. The information contained within this supplement is to be used in conjunction with the complete handbook.

This supplement has been "FAA Approved" as a permanent part of this handbook based on EDO-AIRE Mitchell STC SA3277SW-D and must remain in this handbook at all times when the optional AltiMatic IIIC Autopilot is installed.

**SECTION 2 - LIMITATIONS**

- (a) Autopilot operation prohibited above 185 KIAS. (Autopilot Vmo)
- (b) Autopilot must be "OFF" during takeoff and landing.
- (c) Required placard P/N 13A660 "Conduct Trim Check prior to flight (see AFM)" to be installed in clear view of pilot.
- (d) During autopilot operation, the pilot must be in his seat with the safety belt fastened.

**SECTION 3 - EMERGENCY PROCEDURES**

This aircraft is equipped with a Master Disconnect/Interrupt Switch on the pilot's control wheel. When the switch button is depressed it will disconnect the autopilot. When depressed and held it will interrupt all Electric Elevator Trim Operations. Trim operations will be restored when the switch is released. If an autopilot or trim emergency is encountered, do not attempt to determine which system is at fault. Immediately depress and hold the Master Disconnect/Interrupt button. Turn off autopilot and trim master switch and retrim aircraft, then release the interrupt switch.

**NOTE**

During examination of this supplement, the pilot is advised to locate and identify the autopilot controls, the trim master switch and circuit breaker for both systems.

- (a) In the event of an autopilot malfunction the autopilot can be:
- (1) Overpowered at either control wheel.

**CAUTION**

Do not overpower autopilot pitch axis for periods longer than 3 seconds because the autotrim system will operate in a direction to oppose the pilot and will, thereby, cause an increase in the pitch overpower forces.

- (2) Disconnected by depressing the Master Disconnect/Interrupt Switch.
- (3) Disconnected by depressing the Trim Switch "AP OFF" bar.
- (4) Disconnected by pushing the roll rocker switch "OFF."

- (b) In the event of a trim malfunction:
- (1) Depress and hold the Master Trim Interrupt Switch.
  - (2) Trim Master Switch - "OFF." Retrim aircraft as necessary using manual trim system.
  - (3) Release Master Interrupt Switch - be alert for possible trim action.
  - (4) Trim Circuit Breaker - Pull. Do not operate trim until problem is corrected.
  - (5) If the trim system operates only in one direction, pull the circuit breaker and do not operate the trim system until corrective action is taken. Monitor autopilot operation closely when operating without trim follow-up.
- (c) If a trim runaway occurs with the autopilot operating, the above procedure will disconnect the autopilot which will immediately result in higher control wheel forces. Be prepared to manually retrim, as necessary to eliminate undesirable forces.
- (d) Altitude Loss During Malfunction:
- (1) An autopilot malfunction during climb, cruise or descent with a 3 second delay in recovery initiation could result in as much as 58° of bank and 300' of altitude loss. Maximum altitude loss measured in a descent at V<sub>mo</sub>.
  - (2) An autopilot malfunction during an approach with a 1 second delay in recovery initiation could result in as much as 12° of bank and 60' altitude loss. Maximum altitude loss measured in approach configuration gear down and operating either coupled or uncoupled, single or multi-engine.
- (e) Emergency Operation With Optional NSD 360A (HSI) - Slaved and/or Non-Slaved:

**NSD 360A**

- (1) Appearance of HDG Flag:
- a. Check air supply gauge (vac or pressure) for adequate air supply (4 in. Hg. min.).
  - b. Check compass circuit breaker.
  - c. Observe display for proper operation.

- (2) To disable heading card - pull circuit breaker and use magnetic compass for directional data.

**NOTE**

If heading card is not operational, autopilot should not be used.

- (3) With card disabled, VOR/Localizer and Glide Slope displays are still functional; use card set to rotate card to aircraft heading for correct picture.
- (4) Slaving Failure - (i.e. failure to self-correct for gyro drift):
- Check gyro slaving switch is set to No. 1 position.
  - Check for HDG Flag.
  - Check compass circuit breaker.
  - Reset heading card while observing slaving meter.

**NOTE**

Dead slaving meter needle or a needle displaced fully one direction indicates a slaving system failure.

- Select slaving amplifier No. 2 (gyro slaving switch is set to No. 2 position).
- Reset heading card while checking slaving meter.
- Switch to free gyro and periodically set card as unslaved gyro.

**NOTE**

In the localizer mode the "TO-FROM" arrows may remain out of view, depending upon the design of the NAV converter used in the installation.

- (f) Single Engine Operations:
- (1) Engine failure during an autopilot approach operation: Disengage autopilot; conduct remainder of approach manually.
  - (2) Engine failure during go-around: Disengage autopilot, retrim aircraft, perform normal aircraft engine out procedures; then re-engage autopilot.
  - (3) Engine failure during normal climb, cruise, descent: Retrim aircraft, perform normal aircraft engine out procedures.
  - (4) Maintain aircraft yaw trim throughout all single engine operations.

## **SECTION 4 - NORMAL PROCEDURES**

### **PREFLIGHT INSPECTION - AUTOPILOT**

- (a) Roll Section
- (1) Place Radio Coupler in "Heading" mode and place roll rocker switch "ON" to engage roll section. Rotate roll command knob left and right and observe that control wheel describes a corresponding left and right turn, then center knob.
  - (2) Set proper D.G. Heading on D.G. and turn Heading Bug to aircraft heading. Engage "Heading" mode rocker switch and rotate heading bug right and left. Aircraft control wheel should turn same direction as bug. Grasp control wheel and manually override servo, both directions.
  - (3) Disengage autopilot by depressing trim switch. Check aileron operation is free and autopilot is disconnected from controls.
- (b) Pitch Section
- (1) Engage "Roll" rocker switch.
  - (2) Center pitch command disc and engage "Pitch" rocker switch.
  - (3) Rotate pitch command disc full UP and full DOWN and check that control wheel moves same direction. Check to see that servo can be overridden by hand at control wheel.

#### **NOTE**

Autopilot might not be able to raise elevators,  
on ground, without assistance from pilot.



- (4) Hold control wheel and disengage autopilot by pressing Master Autopilot Disconnect/Trim Interrupt Switch button. Check Roll and Pitch controls to assure autopilot has disconnected.

## **TRIM SYSTEM**

### **General**

This aircraft is equipped with a Command Trim System designed to withstand any type of single malfunction, either mechanical or electrical, without uncontrolled operation resulting. The preflight check procedure is designed to uncover hidden failures that might otherwise go undetected. Proper operation of the electric trim system is predicated on conducting the following preflight check before each flight. If the trim system fails any portion of the procedure, pull the trim circuit breaker out until trim system is repaired. Substitution of any trim system component for another model is not authorized. For emergency interrupt information, refer to Section 3 of this Supplement.

### **Command Electric Trim Switch**

The Command Electric Trim Switch on the left hand portion of the pilot's control wheel has two functions:

- (1) When the top bar (AP OFF) is pressed, it disconnects the Autopilot.
  - (2) When the top bar is pressed AND the rocker is moved forward, nose down trim will occur, when moved aft, nose up trim will occur.
- (a) Preflight: Command Trim - Before Each Flight
- (1) Check trim circuit breaker - IN.
  - (2) Trim Master Switch - ON.
  - (3) AP OFF - Check normal trim operation - UP. Grasp trim wheel and check override capability. Check nose down operation. Re-check override.
  - (4) With trim operating - depress interrupt switch - trim should stop - release interrupt switch - trim should operate.
  - (5) Activate center bar only. Push rocker fore and aft only. Trim should not operate with either separate action.

- (b) Autotrim - Before Each Flight
  - (1) AP ON - (Roll and Pitch Sections) Check automatic operation by activating autopilot pitch command UP then DN. Observe trim operation follows pitch command direction.

**NOTE**

In autopilot mode, there will be approximately a 3 second delay between operation of pitch command and operation of trim.

- (2) Press center bar (AP OFF) - release - check autopilot disengagement.
- (3) Rotate trim wheel to check manual trim operation. Reset to takeoff position prior to takeoff.

**AUTOPILOT IN-FLIGHT PROCEDURE**

- (a) Trim airplane (ball centered).
- (b) Check air pressure or vacuum to ascertain that the directional gyro and attitude gyro are receiving sufficient air.
- (c) Roll Section
  - (1) To engage - Center ROLL COMMAND knob, push ROLL rocker to "ON" position. To turn, rotate console ROLL knob in desired direction.
  - (2) For heading mode, set directional gyro with magnetic compass. Push directional gyro HDG knob in, rotate to select desired heading. Push console heading rocker (HDG) to "ON" position. (Maximum angle to bank will be 20° with heading lock engaged.)
- (d) Pitch Section (Roll section must be engaged prior to pitch section engagement).
  - (1) Center pitch trim indicator with the pitch command disc.
  - (2) Engage pitch rocker switch. To change attitude, rotate pitch command disc in the desired direction.

(e) **Altitude Hold**

Upon reaching desired or cruising altitude, engage altitude hold mode rocker switch. As long as Altitude Hold mode rocker is engaged, aircraft will maintain selected altitude. For maximum passenger comfort, rate of climb or descent should be reduced to approximately 500 FPM prior to altitude hold engagement. For accurate Altitude Holding below 90 KIAS lower flaps one or two notches.

**NOTE**

Prior to disengaging Altitude Hold mode, rotate Pitch Command Disc to center.

(f) **Radio Coupling VOR-ILS with H.S.I. type instrument display. (Optional)**

(1) **VOR Navigation**

- a. Tune and identify VOR Station. Select desired course by rotating CRS knob of H.S.I.
- b. Select OMNI mode on Radio Coupler.
- c. Select HDG mode on autopilot console to engage coupler. Aircraft will turn to a 45° intercept angle to intercept the selected VOR course. Intercept angle magnitude depends on radio needle off - course magnitude, 100% needle deflection will result in 45° intercept angle, diminishing as the needle off-set diminishes.
- d. NAV mode - NAV mode provides reduced VOR sensitivity for tracking weak, or noisy, VOR signals. NAV mode should be selected after the aircraft is established on course.

(2) **ILS-LOC Front Course**

- a. Set inbound, front, localizer course with H.S.I. course knob.
- b. Select LOC-Normal on Radio Coupler to intercept and track inbound on the localizer. Select LOC-REV to intercept and track the localizer course outbound to procedure turn area.
- c. Select HDG mode on autopilot console to engage coupler.

- (3) **ILS - Back Course**
  - a. Set inbound, front, localizer course with H.S.I. course knob.
  - b. Select LOC-REV, on radio coupler to intercept and track inbound on the back localizer course. Select LOC-NORM to intercept and track outbound on the back course to the procedure turn area.
  - c. Engage HDG mode on autopilot console to engage coupler.
  
- (g) **Radio Coupling - VOR/ILS with standard directional gyro. (Optional)**

Radio Coupler operation in conjunction with a standard directional gyro and VOR/LOC display differs from operation with an integrated display (H.S.I.) only in one respect. The HDG bug is used as the radio course datum and therefore must be set to match the desired VOR/ILS course as selected on the O.B.S.

  - (1) **For VOR Intercepts and Tracking:**

Select the desired VOR Course and set the HDG bug to the same heading. Select OMNI mode on the coupler and engage HDG mode on the autopilot console.
  - (2) **For ILS Front Course Intercepts and Tracking:**

Tune the localizer frequency and place the HDG bug on the inbound, front course heading. Select LOC-NORM mode on the coupler and engage HDG mode on the autopilot console.
  - (3) **For LOC Back Course Intercepts and Tracking:**

Tune the localizer frequency and place the HDG bug on the inbound course heading to the airport. Select LOC-REV mode on the coupler and engage HDG mode on the autopilot console.
  
- (h) **Coupled Approach Operations**
  - (1) **VOR or LOC**
    - a. After arrival at the VOR Station, track outbound to the procedure turn area as described in Section 4 (f) or (g) as appropriate. Slow to 110 KIAS and lower one notch of flaps.
    - b. Use HDG mode and Pitch or Altitude Hold modes as appropriate during procedure turn.

- c. At the F.A.F. inbound, return to pitch mode for control of descent and lower landing gear.
  - d. At the M.D.A. select altitude hold mode and add power for level flight. Monitor altimeter to assure accurate altitude control is being provided by the autopilot.
  - e. Go Around - For missed approach select desired pitch attitude with pitch command disc and disengage altitude hold mode. This will initiate the pitch up attitude change. Immediately add takeoff power and monitor Altimeter and rate of climb for positive climb indication. After climb is established, retract flaps and gear. Adjust attitude as necessary for desired airspeed and select HDG mode for turn from the VOR final approach course.
- (2) ILS - Front Course Approach With Glide Slope Capture. (Optional)
- a. Track inbound to LOM as described in Section 4 (f) or (g) above and in Altitude Hold mode.
  - b. Inbound to LOM slow to 100 to 110 KIAS and lower flaps one notch.
  - c. Automatic Glide Slope capture will occur at Glide Slope intercept if the following conditions are met:
    - 1. Coupler in LOC-Normal mode.
    - 2. Altitude Hold mode engaged (Altitude Rocker on Console).
    - 3. Under Glide Slope for more than 20 seconds.
    - 4. Localizer radio frequency selected on NAV Receiver.
  - d. At Glide Slope Intercept immediately lower landing gear and reduce power to maintain approximately 90-100 KIAS on final approach. Glide Slope capture is indicated by lighting of the green Glide Slope engage Annunciator Lamp and by a slight pitch down of the aircraft.
  - e. Monitor localizer and Glide Slope raw data throughout approach. Adjust power as necessary to maintain correct final approach airspeed. All power changes should be of small magnitude and smoothly applied for best tracking performance. Do not change aircraft configuration during approach while autopilot is engaged.

- f. Conduct missed approach maneuver as described in (h)(1) e. above.

**NOTE**

Glide Slope Coupler will not automatically decouple from Glide Slope. Decoupling may be accomplished by any of the following means:

1. Disengage Altitude Mode.
2. Switch Radio Coupler to HDG Mode.
3. Disengage Autopilot.

**SECTION 5 - PERFORMANCE**

No changes to the basic performance provided by Section 5 of the Pilot's Operating Handbook are necessary for this supplement.

**THIS PAGE INTENTIONALLY LEFT BLANK**

### **SUPPLEMENT 3**

#### **PIPER ELECTRIC PITCH TRIM**

##### **SECTION 1 - GENERAL**

This supplement supplies information necessary for the operation of the airplane when the optional Piper Electric Pitch Trim is installed. The information contained within this supplement is to be used "as described" in conjunction with the complete handbook.

This supplement has been "FAA Approved" as a permanent part of this handbook and must remain in this handbook at all times when the optional Piper Electric Pitch Trim is installed.

##### **SECTION 2 - LIMITATIONS**

No changes of the basic limitations provided by Section 2 of this Pilot's Operating Handbook are necessary for this supplement.

##### **SECTION 3 - EMERGENCY PROCEDURES**

- (a) In case of malfunction, **ACTIVATE** disconnect switch located on the instrument panel below the left control wheel to **OFF** position.
- (b) In case of malfunction, overpower the electric trim at either control wheel.
- (c) Maximum altitude change with a 4 second delay in recovery initiation is 600 feet and occurs in the cruise configuration. Maximum altitude change in the approach configuration with a 2 second recovery delay is 250 feet.



**SECTION 4 - NORMAL PROCEDURES**

The electric trim system may be turned ON or OFF by a switch located on the instrument panel below the left control wheel. The pitch trim may be changed when the electric trim system is turned on either by moving the manual pitch trim control wheel or by operating the trim control switch on the pilot's control yoke. To prevent excessive speed increase in the event of an electric trim run-away malfunction, the system incorporates an automatic disconnect feature which renders the system inoperative above approximately 169 KIAS. The disconnected condition does not affect the manual trim system.

**SECTION 5 - PERFORMANCE**

No changes to the basic performance provided by Section 5 of this Pilot's Operating Handbook are necessary for this supplement.

**SUPPLEMENT 4**

**KNS 80 NAVIGATION SYSTEM**

**SECTION 1 - GENERAL**

This supplement supplies information necessary for the operation of the airplane when the optional KNS 80 Navigation System is installed. The information contained within this supplement is to be used in conjunction with the complete handbook.

This supplement has been "FAA Approved" as a permanent part of this handbook and must remain in this handbook at all times when the optional KNS 80 Navigation System is installed.

**SECTION 2 - LIMITATIONS**

No changes to the basic limitations provided by Section 2 of this Pilot's Operating Handbook are necessary for this supplement.

**SECTION 3 - EMERGENCY PROCEDURES**

No changes to basic Emergency Procedures provided by Section 3 of this Pilot's Operating Handbook are necessary for this supplement.

**SECTION 4 - NORMAL PROCEDURES**

**(a) KNS 80 OPERATION**

The KNS 80 can be operated in any one of 3 basic modes: (a) VOR, (b) RNAV, or (c) ILS. To change from one mode to another, the appropriate pushbutton switch is pressed, except that the ILS mode is entered automatically whenever an ILS frequency is channeled in the USE waypoint. The display will annunciate the mode by lighting a message above the pushbutton. In addition to the standard VOR and RNAV enroute (RNV ENR) modes, the KNS 80 has a constant course width or parallel VOR mode (VOR PAR) and an RNAV approach mode (RNV APR). To place the unit in either of these secondary modes the VOR pushbutton or the RNAV pushbutton, as the case may be, is pushed a second time. Repetitive pushing of the VOR button will cause the system to alternate between the VOR and VOR PAR modes, while repetitive pushing of the RNAV button causes the system to alternate between RNV ENR and RNV APR modes.

**(b) CONTROLS**

**(1) VOR BUTTON**

Momentary pushbutton.

When pushed while system is in either RNV mode causes system to go to VOR mode. Otherwise the button causes system to toggle between VOR and VOR PAR modes.

**(2) RNAV BUTTON**

Momentary pushbutton.

When pushed while system is in either VOR mode causes system to go to RNV ENR mode. Otherwise the button causes system to toggle between RNV ENR and RNV APR modes.

**(3) HOLD BUTTON**

Two position pushbutton.

When in depressed position, inhibits DME from channeling to a new station when the VOR frequency is changed. Pushing the button again releases the button and channels the DME to the station paired with the VOR station.

**(4) USE BUTTON**

Momentary pushbutton.

Causes active waypoint to take on same value as displayed waypoint and data display to go to FRQ mode.

- (5) **DSP BUTTON**  
Momentary pushbutton.  
Causes displayed waypoint to increment by 1 and data display to go to frequency mode.
- (6) **DATA BUTTON**  
Momentary pushbutton.  
Causes waypoint data display to change from FRQ to RAD to DST and back to FRQ.
- (7) **OFF/PULL ID CONTROL**
- a. Rotate counterclockwise to switch off power to the KNS 80.
  - b. Rotate clockwise to increase audio level.
  - c. Pull switch out to hear VOR Ident.
- (8) **DATA INPUT CONTROL**  
Dual concentric knobs. Center knob has "in" and "out" positions.
- a. **Frequency Data**  
Outer knob varies 1 MHz digit.  
A carryover occurs from the units to tens position.  
Rollover occurs from 117 to 108, or vice versa.  
Center knob varies frequency in .05 MHz steps regardless of whether the switch is in its "in" or "out" position.
  - b. **Radial Data**  
Outer knob varies 10 degree digit.  
A carryover occurs from tens to hundreds position.  
A rollover to zero occurs at 360 degrees.  
Center knob "in" position varies 1 degree digit.  
Center knob "out" position varies 0.1 degree digit.
  - c. **Distance Data**  
Outer knob varies 10 NM digit.  
A carryover occurs from the tens to hundreds place.  
A rollover to zero occurs at 200 NM.  
Center knob "in" position varies 1 NM digit.  
Center knob "out" position varies 0.1 NM digit.
- (9) **COURSE SELECT KNOB**  
Located in CDI unit.  
Selects desired course through the VOR ground station or waypoint.

**SECTION 5 - PERFORMANCE**

No changes to the basic performance provided by Section 5 of this Pilot's Operating Handbook are necessary for this supplement.

**SUPPLEMENT 5**

**ANS 351 AREA NAVIGATION COMPUTER**

**SECTION 1 - GENERAL**

This supplement supplies information necessary for the operation of the airplane when the optional ANS 351 Area Navigation Computer is installed. The information contained within this supplement is to be used in conjunction with the complete handbook.

This supplement has been "FAA Approved" as a permanent part of this handbook and must remain in this handbook at all times when the optional ANS 351 Area Navigation Computer is installed.

**SECTION 2 - LIMITATIONS**

No changes to the basic limitations provided by Section 2 of this Pilot's Operating Handbook are necessary for this supplement.

**SECTION 3 - EMERGENCY PROCEDURES**

No changes to basic Emergency Procedures provided by Section 3 of this Pilot's Operating Handbook are necessary for this supplement.

SECTION 4 - NORMAL PROCEDURES

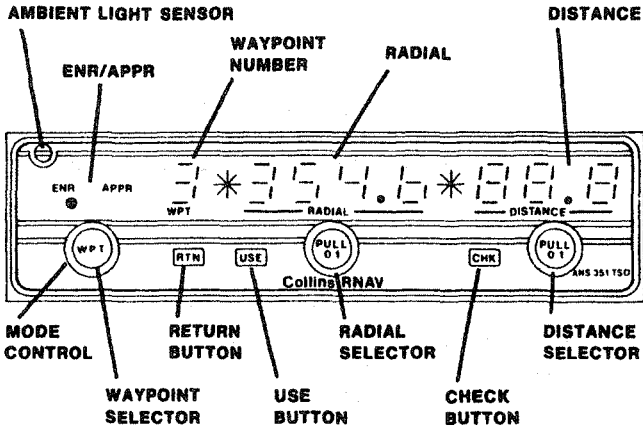

ANS 351 AREA NAVIGATION COMPUTER,  
CONTROLS AND INDICATORS

(a) CONTROLS

CONTROL OR INDICATOR	FUNCTION
Mode Control	Selects ENR (enroute) or APPR (approach) modes of operation. In the enroute mode, CDI deviation is 1 mile/dot, 5 miles full scale. In approach, CDI deflection is 1/4 mile/dot, 1-1/4 miles full scale.
Waypoint Selector	Sequences display waypoints from 1 through 8. Winking waypoint number indicates inactive waypoints; steadily-on-waypoint number indicates active waypoint.
Return Button	Depressing RTN (return) button returns the display to the active waypoint when an inactive waypoint is currently being displayed.

---

<b>CONTROL OR INDICATOR</b>	<b>FUNCTION</b>
Use Button	Depressing the USE button converts the waypoint being displayed into the active waypoint.
Radial Selector	Two concentric knobs set radial information into the display. Knobs control information as follows: Large knob: Changes display in 10-degree increments.  Small knob pushed in: Changes display 1-degree increments.  Small knob pulled out: Changes display in 0.1-degree increments.
Distance Selector	Two concentric knobs set distance information in nautical miles into the display. Knobs control information as follows: Large knob: Changes display in 10-mile increments.  Small knob pushed in: Changes display 1-mile increments.  Small knob pulled out: Changes display in 0.1-mile divisions from 00.0 through 100 miles. Beyond 100 nmi, changes display in 1-mile increments.
Check Button	Depressing CHK (check) button causes DME and bearing indicators to display raw distance and bearing information. RNAV computation, CDI deviation, to/from display, and autopilot tracking of RNAV path remain unaffected. The check button is spring-loaded to prevent permanent actuation.
Ambient Light Sensor	Automatically adjusts display lighting intensity as a function of cockpit ambient light.

---



**(b) AREA NAVIGATION WAYPOINT PROGRAMMING**

**(1) Presentation Of Waypoint On Ground**

Waypoints are entered after engine start, since the waypoint information will probably be lost during the low-voltage condition occurring during engine cranking. Waypoint data should always be written in flight planning form to facilitate checking later in flight. When power is first applied to the ANS 351 and the system is in the RNAV mode, waypoint number 1 will be active, (waypoint number not blinking) and waypoint bearing and distance preset to zero will appear.

- a. Waypoint number 1 coordinates are set into the ANS 351 using concentric knobs under bearing and distance display fields.
- b. The waypoint selection knob is then rotated to select waypoint number 2. Note that the waypoint number is blinking, indicating that the waypoint is at this point inactive. Waypoint number 2 bearing and distance definitions are then set into the ANS 351.
- c. Set up the rest of the desired waypoints as described above.
- d. Press the RTN (return) pushbutton to display the active waypoint.

**(2) Changing Waypoints In Flight**

To change a waypoint in flight, rotate the waypoint selector until the desired waypoint number and coordinates are displayed on the ANS 351.

- a. Verify that the waypoint definition is correct by comparing the display with the flight plan.
- b. Uncouple the autopilot if tracking RNAV deviation.
- c. Select the desired reference facility frequency on the associated NAV receiver.
- d. Depress the USE pushbutton and note that the waypoint identification number stops winking.
- e. Select the desired course on OBS.
- f. Recouple the autopilot after deviation and distance-to-waypoint indications have stabilized.

**SECTION 5 - PERFORMANCE**

No changes to the basic performance provided by Section 5 of this Pilot's Operating Handbook are necessary for this supplement.

**SUPPLEMENT 6**

**AIR CONDITIONING INSTALLATION**

**SECTION 1 - GENERAL**

This supplement supplies information necessary for the efficient operation of the airplane when the optional air conditioning system is installed. The information contained within this supplement is to be used "as described" in conjunction with the complete handbook.

This supplement has been "FAA Approved" as a permanent part of this handbook and must remain in this handbook at all times when the optional air conditioning system is installed.

The air conditioning system is a recirculating air system. The major components include an evaporator, a condenser, a compressor, a blower, switches and temperature controls.

The evaporator is located behind the rear baggage compartment. Air from the baggage area is drawn through the evaporator by the blower and is distributed through an overhead duct to individual outlets located adjacent to each occupant.

The condenser is mounted aft of the evaporator on the bottom tailcone skin. A continuously operating cooling fan ducts outside air through the condenser and dumps it overboard, on the ground or in flight, when the air conditioning is turned on.

The compressor is mounted on the front side of the left engine. It has an electric clutch which automatically engages or disengages the compressor to its belt drive system.

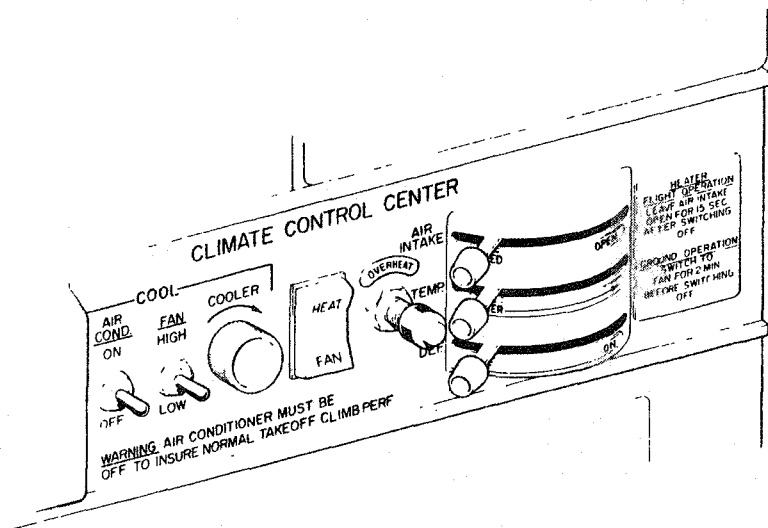

**CLIMATE CONTROL CENTER**

Figure 1-1

The switches and temperature control are located on the lower right side of the instrument panel. The temperature control regulates the temperature of the cabin. Turning the control clockwise increases cooling; counterclockwise decreases cooling.

The fan-speed switch and the air conditioner ON - OFF switch are inboard of the temperature control. The fan can be operated independently of the air conditioning. However, the fan must be on for air conditioner operation. Turning either switch off will disengage the compressor clutch and switch off the condenser cooling fan. Cooling air should be felt within two minutes after the air conditioner is turned on.

**NOTE**

If the system is not operating within 2 minutes, turn the system OFF until the fault is corrected.

The fan switch allows operation of the fan with the air conditioner turned OFF to aid in cabin air circulation. "LOW" or "HIGH" can be selected to direct a flow of air through the air conditioner outlets in the overhead duct. These outlets can be adjusted or turned off individually.

Two circuit breakers on the circuit breaker panel protect the air conditioning electrical system.

## **SECTION 2 - LIMITATIONS**

- (a) To insure maximum climb performance the air conditioner must be turned "OFF" manually prior to takeoff to disengage the compressor and turn off the condenser cooling fan. Also the air conditioner must be turned "OFF" manually before the landing approach in preparation for a possible go-around.
- (b) Placards

In full view of the pilot, in the area of the air conditioner controls when the air conditioner is installed:

**"WARNING: AIR CONDITIONER MUST BE OFF TO INSURE NORMAL TAKEOFF CLIMB PERFORMANCE."**

## **SECTION 3 - EMERGENCY PROCEDURES**

The air conditioner must be off during all one-engine inoperative operations.

No other changes to the basic Emergency Procedures provided by Section 3 of this Pilot's Operating Handbook are necessary for this supplement.

## **SECTION 4 - NORMAL PROCEDURES**

Prior to takeoff, the air conditioner should be checked for proper operation as follows:

- (a) Check aircraft master switch "ON."
- (b) Turn the air conditioner control switch to "ON" and the fan switch to one of the operating positions. A slight decrease in left-engine RPM, and an ammeter increase of about 15 amps each, indicates proper equipment operation. Cool air should be felt from the overhead outlets within 2 minutes.
- (c) Turn the air conditioner control switch to "OFF." Left-engine RPM should increase and the ammeter indication should drop.
- (d) If the system does not respond as specified above, a malfunction is indicated and further investigation should be conducted prior to flight.

The above operational check may be performed during flight if an in-flight failure is suspected.

## **SECTION 5 - PERFORMANCE**

Installation of the air conditioner does not effect the basic cruise performance information presented in Section 5 of this handbook. The climb performance in Section 5 is not effected when the air conditioner is in the off position.

### **NOTE**

To insure maximum climb performance the air conditioner must be turned off manually before takeoff to disengage the compressor. Also the air conditioner must be turned off manually before the landing approach in preparation for a possible go-around. The air conditioner must be off for all one-engine-inoperative operations.

Additionally, the air conditioning system is designed so that the compressor will declutch when the throttle is advanced to the full throttle position to provide maximum performance should the air conditioner be in the on position inadvertently.

**THIS PAGE INTENTIONALLY LEFT BLANK**

**SUPPLEMENT 7**

**CENTURY 21 AUTOPILOT INSTALLATION**

**SECTION 1 - GENERAL**

This supplement supplies information necessary for the operation of the airplane when the optional Century 21 Autopilot is installed in accordance with STC SA3376SW-D. The information contained within this supplement is to be used in conjunction with the complete handbook.

This supplement has been "FAA Approved" as a permanent part of this handbook and must remain in this handbook at all times when the optional Century 21 Autopilot is installed.

**SECTION 2 - LIMITATIONS**

- (a) Maximum airspeed for autopilot operation is 185 KIAS.
- (b) Autopilot OFF during takeoff and landing.

**SECTION 3 - EMERGENCY PROCEDURES**

**(a) AUTOPILOT**

In the event of an autopilot malfunction, or anytime the autopilot is not performing as commanded, do not attempt to identify the problem. Regain control of the aircraft by overpowering and immediately disconnecting the autopilot by depressing the AP ON-OFF switch on the programmer OFF.

Do not operate until the system failure has been identified and corrected.



**(1) Altitude Loss During Malfunction:**

- a. An autopilot malfunction during climb, cruise or descent with a 3 second delay in recovery initiation could result in as much as 59° of bank and 350' altitude loss. Maximum altitude loss was recorded at 185 KIAS during descent.
- b. An autopilot malfunction during an approach with a 1 second delay in recovery initiation could result in as much as 18° bank and 40' altitude loss. Maximum altitude loss measured in approach configuration, and operating either coupled or uncoupled, single or multi-engine.

**(b) COMPASS SYSTEM**

**(1) Emergency Operation With Optional NSD 360A (HSI) Slaved and/or Non-Slaved:**

**NSD 360A**

- a. Appearance of HDG Flag:
  1. Check air supply gauge (vac or pressure) for adequate air supply (4 in. Hg. min.).
  2. Check compass circuit breaker.
  3. Observe display for proper operation.
- b. To disable heading card - pull circuit breaker and use magnetic compass for directional data.

**NOTE**

If heading card is not operational, autopilot should not be used.

- c. With card disabled VOR/Localizer and Glide Slope displays are still functional; use card set to rotate card to aircraft heading for correct picture.
- d. Slaving Failure - (i.e. failure to self correct for gyro drift):
  1. Check gyro slaving switch is set to No. 1 position (if equipped with Slave No. 1 - No. 2 switch) or "Slaved" position when equipped with Slaved and Free Gyro Mode Switch.
  2. Check for HDG Flag.
  3. Check compass circuit breaker.
  4. Reset heading card while observing slaving meter.

**NOTE**

Dead slaving meter needle or a needle displaced fully one direction indicates a slaving system failure.

5. Select slaving amplifier No. 2, if equipped.
6. Reset heading card while checking slaving meter. If proper slaving indication is not obtained, switch to free gyro mode and periodically set card as an unslaved gyro.

**NOTE**

In the localizer mode, the "TO-FROM" arrows may remain out of view, depending upon the design of the NAV converter used in the installation.

**SECTION 4 - NORMAL PROCEDURES**

Refer to Edo-Aire Mitchell Century 21 Autopilot Operator's Manual, P/N 68S805, dated 1-79 for Autopilot Description and Normal Operating Procedures.

**(a) PREFLIGHT PROCEDURES**

**NOTE**

During system functional check the system must be provided adequate D.C. voltage (12.0 VDC min.) and instrument air (4.2 in. Hg. min.). It is recommended that one engine (minimum) be operated to provide the necessary power and that the aircraft be positioned in a level attitude, during the functional check.

**(b) AUTOPILOT WITH STANDARD D.G.**

- (1) Engage autopilot.
- (2) Control wheel movement should correspond to HDG command input.
- (3) Grasp control wheel and override roll servo actuator to assure override capability.
- (4) With HDG bug centered select NAV or APPR mode and note control wheel movement toward VOR needle offset.
- (5) Select REV mode and note control wheel movement opposite VOR needle offset.
- (6) Disengage autopilot.
- (7) Check aileron controls through full travel to assure complete autopilot disengagement.

**(c) AUTOPILOT WITH COMPASS SYSTEM (NSD 360A)**

(For other compass systems, refer to appropriate manufacturer's instructions)

- (1) Check slaving switch in slave or slave 1 or 2 position, as appropriate. (Slaving systems with R.M.I. output provide only slave and free gyro positions.)
- (2) Rotate card to center slaving meter - check HDG displayed with magnetic compass HDG.
- (3) Perform standard VOR receiver check.
- (4) Perform Steps (1) - (7) in Section 4 item (b) except in Steps (4) and (5) substitute course arrow for HDG bug when checking control wheel movement in relation to L/R needle. HDG bug is inoperative with NAV, APPR, or REV mode selected.

**(d) IN-FLIGHT PROCEDURE**

- (1) Trim aircraft for existing flight condition (all axes).
- (2) Rotate heading bug to desired heading. Engage autopilot.
- (3) During maneuvering flight - control aircraft through use of the HDG bug. (HDG mode)
- (4) For navigation operations select modes as required by the operation being conducted and in accordance with the mode description provided in the Century 21 Operator's Manual.

**SECTION 5 - PERFORMANCE**

No changes to the basic performance provided by Section 5 of this Pilot's Operating Handbook are necessary for this supplement.

**SUPPLEMENT 8**

**CENTURY 41 AUTOPILOT INSTALLATION**

**SECTION 1 - GENERAL**

This supplement supplies information necessary for the operation of the airplane when the optional Century 41 Autopilot Model AK873 or Century 41 Flight Director Autopilot Mode AK873FD is installed in accordance with STC SA3375SW-D. The information contained within this supplement is to be used in conjunction with the complete handbook.

This supplement has been "FAA Approved" as a permanent part of this handbook and must remain in this handbook at all times when the optional Century 41 Autopilot or the Century 41 Flight Director Autopilot is installed.

**SECTION 2 - LIMITATIONS**

- (a) Autopilot use prohibited above 185 KIAS.
- (b) Autopilot OFF during takeoff and landing.
- (c) Required Placard, P/N 13A990 stating "Conduct trim check prior to first flight of day - (See A.F.M.)" to be installed in clear view of pilot.
- (d) Autopilot coupled Go-Around maneuvers prohibited [See Section 4 item (i)(3)].
- (e) Category I operations only.

**SECTION 3 - EMERGENCY PROCEDURES**

**(a) AUTOPILOT**

In the event of an autopilot malfunction, or anytime the autopilot is not performing as commanded, do not attempt to identify the problem system. Regain control by overpowering and immediately disconnecting the autopilot. This will disable both the autotrim system and the autopilot system. If the malfunction was in the autotrim system there may be residual control wheel force after the system is OFF. Be prepared for any residual trim force and retrim, as necessary, using the aircraft's primary trim control system.

**NOTE**

Do not overpower autopilot in pitch for more than approximately 3 seconds as the autotrim system will cause an increase in pitch overpower forces.

- (1) Autopilot may be disconnected by:
  - a. Depressing "AP OFF" bar on pilot's trim switch.
  - b. Depressing the AP ON-OFF switch on the programmer.
  - c. Depressing master disconnect switch on pilot's control wheel.
- (2) Autotrim may be disconnected by:
  - a. Depressing the autopilot ON-OFF switch - OFF.
  - b. Placing the autotrim master switch - OFF.
  - c. Depressing master disconnect switch on pilot's control wheel.

After failed system has been identified, pull system circuit breaker and do not operate until the system has been corrected.
- (3) Single Engine Operations:
  - a. Engine failure during an autopilot approach operation: Disengage autopilot, conduct remainder of approach manually.
  - b. Engine failure during normal climb, cruise, descent: Retrim aircraft, perform normal aircraft engine out procedures.

- c. Maintain aircraft yaw trim throughout all single engine operations.

**NOTE**

Single engine operations below Single Engine Best Rate of Climb Airspeed may require manual rudder application to maintain directional trim depending upon aircraft configuration and power applied.

- (4) Altitude Loss During Malfunction:
  - a. An autopilot malfunction during climb or cruise with a 3 second delay in recovery initiation could result in as much as 59° bank and 700' altitude loss. Maximum altitude loss measured at 185 KIAS during descent.
  - b. An autopilot malfunction during an approach with a 1 second delay in recovery initiation could result in as much as 20° bank and 80' altitude loss. Maximum altitude loss measured in approach configuration, gear down, and operating either coupled or uncoupled, single or multi-engine.

**(b) COMPASS SYSTEM**

- (1) Emergency Operation With Optional NSD 360A (HSI) Slaved and/or Non-Slaved:

**NSD 360A**

- a. Appearance of HDG Flag:
  - 1. Check air supply gauge (vac or pressure) for adequate air supply (4 in. Hg. min.).
  - 2. Check compass circuit breaker.
  - 3. Observe display for proper operation.
- b. To disable heading card - pull circuit breaker and use magnetic compass for directional data.

**NOTE**

If heading card is not operational, autopilot should not be used.

- c. With card disabled VOR/Localizer and Glide Slope displays are still functional; use card set to rotate card to aircraft heading for correct picture.
- d. Slaving Failure - (i.e. failure to self correct for gyro drift):
  1. Check gyro slaving switch is set to No. 1 position (if equipped with Slave No. 1 - No. 2 switch) or "Slaved" position when equipped with Slaved and Free Gyro Mode Switch.
  2. Check for HDG Flag.
  3. Check compass circuit breaker.
  4. Reset heading card while observing slaving meter.

**NOTE**

Dead slaving meter needle or a needle displaced fully one direction indicates a slaving system failure.

5. Select slaving amplifier No. 2, if equipped. If not equipped, proceed with No. 7.
6. Reset heading card while checking slaving meter. If proper slaving indication is not obtained,
7. Switch to free gyro mode and periodically set card as an unslaved gyro.

**NOTE**

In the localizer mode, the "TO-FROM" arrows may remain out of view, depending upon the design of the NAV converter used in the installation.

**SECTION 4 - NORMAL PROCEDURES**

**(a) NORMAL OPERATING PROCEDURES**

**NOTE**

This autopilot is equipped with an A/P "OFF" warning horn that will sound for approximately 4 seconds anytime the autopilot is disengaged. This will be accompanied by an "A/P" message flash on the autopilot remote annunciator for approximately 5 seconds.

The horn may be silenced before the 4 second time limit is up by:

- (1) Pressing "T" bar atop command trim switch.
- (2) Or by re-engaging the autopilot.

**NOTE**

If this autopilot is equipped with a Flight Director steering horizon the F/D must be switched on before the autopilot may be engaged. Any autopilot mode may be preselected and will be retained upon autopilot engagement.

**CAUTION**

Flight Director Autopilot versions only are equipped with a remote go-around switch. When G/A mode is selected the AUTOPILOT WILL DISCONNECT and warning horn will sound. Pilot may use Flight Director steering for missed approach guidance and after aircraft is stabilized in a proper climb with gear and flaps up autopilot may be re-engaged and will retain G/A mode. Autopilot only versions (no Flight Director) do not have a G/A switch.



*CAUTIONS*

To avoid inadvertent or false glideslope captures while operating on the localizer use NAV mode instead of APR mode.

Refer to Edo-Aire Mitchell Century 41 Operator's Manual, P/N 68S803, dated 1-79 for additional System Description and Normal Operating Procedures.

(b) PREFLIGHT PROCEDURES

NOTE

During system functional check, the system must be provided adequate D.C. voltage (12.0 VDC min.) and instrument air (4.2 in. Hg. min.). It is recommended that one engine be operated (minimum) to provide the necessary power and that the aircraft be positioned in a level attitude, during the functional check.

- (1) AUTOPILOT (F/D Switch ON if F/D Equipped)
- a. Engage autopilot by pushing programmer OFF - ON switch ON.
  - b. Rotate D.G. HDG bug left then right and verify that control wheel movement corresponds to HDG command input.
  - c. Press pitch modifier button first up then down and note that pitch control follows pitch command input. Autotrim should follow pitch command input after approximately three second delay.
  - d. Grasp control wheel and override roll and pitch servo actuators to assure override capability.
  - e. Hold control yoke and disengage autopilot by activating the control wheel trim switch.
  - f. Check controls through full travel in roll and pitch to assure complete autopilot disengagement.
  - g. Retrim aircraft for takeoff.

**(c) TRIM SYSTEM**

The autopilot is provided with an electric elevator trim system having two modes of operation. When the autopilot is engaged and the trim master switch is ON, automatic electric trim (autotrim) is provided. When the autopilot is disengaged, command electric elevator trim is available by use of the control wheel switch provided or by use of the primary trim control wheel. The electric elevator trim system has been designed to withstand any type of single failure, either mechanical or electrical, without uncontrolled operation resulting. The automated system self test circuit provided, in conjunction with a functional check, described below, will uncover internal failures that otherwise could remain undetected and thus compromise the fail-safe properties of the system. Proper operation of the system is, therefore, predicated on conducting the following preflight check before first flight of each day. If the trim system fails any portion of this test, turn the autotrim master switch OFF and pull the autotrim circuit breaker, until the system is corrected.

The command electric trim switch on the left portion of the pilot's control wheel has two functions:

- (1) When the top bar (AP OFF) is pressed, it disconnects the autopilot.
- (2) When the top bar is pressed and the rocker is moved forward, nose down trim will occur; when moved aft, nose up trim will occur.

**Command Trim - Before the First Flight of Each Day**

- (1) Trim master switch - ON.
- (2) Verify normal trim UP and DOWN operation with control wheel switch.
- (3) Press - center bar only - then release center bar.
- (4) Push rocker fore and aft - only. Trim should not operate with either separate action.

Any failure of the preceding operations indicates that a failure exists in the system and the Command Trim shall not be operated until the failure has been identified and corrected.

**Autotrim - Before the First Flight of Each Day**

- (1) Check trim master switch ON, autopilot OFF.
- (2) Press and hold TEST pushbutton on Mode Annunciator. Verify the following sequence. (Each sequence will last approximately two seconds.):
  - a. All annunciators light with FAIL and AP flashing.
  - b. Autotrim flashes, goes steady, then flashes.
  - c. All lights go steady.
  - d. After three to five seconds, AUTOTRIM and FAIL flash continually.
- (3) With TEST button on the Mode Annunciator still depressed, verify Trim will not operate in either direction with the Control Wheel Switch.
- (4) Release TEST pushbutton. All lights except HDG and ATT shall extinguish.

Any deviation from the above sequence indicates that a failure exists in either the primary system or in the monitor circuits. The autopilot and trim system shall not be operated until the failure has been identified and corrected.

**CAUTION**

Recheck trim position prior to initiating takeoff.

**(d) FLIGHT DIRECTOR**

- (1) Check circuit breaker - IN.
- (2) Flight director switch on steering horizon - ON. (Adjacent to instrument on single cue horizon.)
- (3) Pitch modifier DN - UP - check pitch steering indicator moves appropriately.
- (4) HDG bug RT - LT - check roll steering indicator moves appropriately.

**(e) COMPASS SYSTEM (NSD 360A)**

For other compass systems, refer to appropriate manufacturer's instructions.

- (1) Check slaving switch in slave or slave 1 or 2 position, as appropriate. (Slaving systems with R.M.I. output provide only slave and free gyro positions.)
- (2) Rotate card to center slaving meter - check HDG displayed with magnetic compass HDG.
- (3) Perform standard VOR receiver check.
- (4) NAV - APPR - Engage NAV or APPR mode switch and observe steering bar indicates turn toward the VOR needle.

**NOTE**

If the Omni Bearing Selector is more than 45° from the aircraft heading, the flight director steering bar will only indicate a turn toward the omni bearing.

**(f) IN-FLIGHT PROCEDURE - FLIGHT DIRECTOR**

- (1) Century 41 circuit breaker - IN. Flight director switch - ON.
- (2) Adjust HDG bug to aircraft heading and select desired pitch attitude by activation of the CWS (Pitch Synch) switch or the modifier switch.
- (3) Maneuver aircraft manually to satisfy the commands presented. Select other modes as desired; refer to Century 41 Operator's Manual for mode description.

**(g) IN-FLIGHT PROCEDURE - AUTOPILOT/FLIGHT DIRECTOR AUTOPILOT**

- (1) Flight director switch - ON, if F/D equipped. Rotate heading bug to desired heading.
- (2) Trim aircraft for existing flight condition (all axes). Engage autopilot.
- (3) During maneuvering flight - control aircraft through use of the HDG bug and the pitch modifier. (HDG-ATT modes) (For use of pitch synch switch see Operator's Manual.)
- (4) For navigation operations select modes as required by the operation being conducted and in accordance with the mode description provided in Operator's Manual. For specific instructions relating to coupled instrument approach operations, refer to Special Operations and Information Section 4, item (i).

**(h) IN-FLIGHT PROCEDURE - COMMAND/AUTOTRIM SYSTEM**

- (1) Trim master switch - ON.
- (2) When the autopilot is engaged, pitch trim is accomplished and maintained automatically.
- (3) With the autopilot OFF, command trim is obtained by pressing and rocking the combination TRIM-AP disconnect bar on the pilot's control wheel trim switch.

**(i) SPECIAL OPERATIONS AND INFORMATION**

- (1) Altitude Hold Operation:  
For best results, reduce rate of climb or descent to 1000 FPM before engaging altitude hold mode.
- (2) Instrument Approach Operations:  
Initial and/or intermediate approach segments should be conducted between 95-110 KIAS with the flaps extended as desired. Upon intercepting the glide path or when passing the final approach fix (FAF) immediately lower the landing gear and reduce the power for approximately 80-95 KIAS on the final approach segment. Adjust power as necessary during remainder of approach to maintain correct airspeed. Monitor course guidance information (raw data) throughout the approach. All power changes should be of small magnitude and smoothly applied for best tracking performance. Do not change aircraft configuration during approach while autopilot is engaged. For approaches without glide path coupling, adjust pitch attitude in conjunction with power to maintain desired airspeed and descent rate.

**NOTE**

Flight director or autopilot will not decouple from the GS or localizer in the event of radio failure, however, warnings will flash in the mode appropriate to the failure. Monitor course guidance raw data during the approach to assure signal quality.

- (3) Instrument Approach Go-Around Maneuver (Flight Director Version Only):
  - a. Select GA mode at the remote GA switch. Autopilot will disconnect and warning horn will sound.
  - b. Add takeoff power, or power as desired.
  - c. Check the correct attitude and that a positive rate of climb is indicated, then raise gear and flaps.
  - d. Pilot may hand fly aircraft with reference to flight director steering information.
  - e. After aircraft is established in climb, gear and flaps up, autopilot may be re-engaged by pushing "ON" button on console if flight director steering is switched on.
  - f. Set desired HDG and select HDG mode for lateral maneuvering.

**SECTION 5**

No changes to the basic performance provided by Section 5 of this Pilot's Operating Handbook are necessary for this supplement.

**THIS PAGE INTENTIONALLY LEFT BLANK**

## **SUPPLEMENT 9**

### **PIPER CONTROL WHEEL CLOCK INSTALLATION**

#### **SECTION 1 - GENERAL**

This supplement supplies information necessary for the operation of the airplane when the optional Piper Control Wheel Clock is installed. The information contained within this supplement is to be used in conjunction with the complete handbook.

This supplement has been "FAA Approved" as a permanent part of this handbook and must remain in this handbook at all times when the optional Piper Control Wheel Clock is installed.

#### **SECTION 2 - LIMITATIONS**

No changes to the basic limitations provided by Section 2 of this Pilot's Operating Handbook are necessary for this supplement.

#### **SECTION 3 - EMERGENCY PROCEDURES**

No changes to the basic Emergency Procedures provided by Section 3 of this Pilot's Operating Handbook are necessary for this supplement.

#### **SECTION 4 - NORMAL PROCEDURES**

##### **(a) SETTING**

While in the CLOCK mode, the time and the date can be set by the operation of the RST button.



**(b) DATE SETTING**

Pressing the RST button once will cause the date to appear with the month flashing. Pressing the ST-SP button will advance the month at one per second, or at one per push, until the right month appears.

Pressing the RST button once again will cause the date to flash, and it can be set in a similar manner.

**(c) TIME SETTING**

The RST button must now be pressed two times to cause the hours digits to flash. The correct hour can be set in as described above.

Pressing the RST button once again will now cause the minutes digits to flash. The minutes should be set to the next minute to come up at the zero seconds time mark. The RST button is pressed once more to hold the time displayed. At the time mark, the ST-SP button is pressed momentarily to begin the time counting at the exact second.

If the minutes are not advanced when they are flashing in the set mode, pressing the RST button will return the clock to the normal timekeeping mode without altering the minutes timing. This feature is useful when changing time zones, when only the hours are to be changed.

**(d) AUTOMATIC DATE ADVANCE**

The calendar function will automatically advance the date correctly according to the four year perpetual calendar. One day must be added manually on Feb. 29 on leap year. The date advances correctly at midnight each day.

**(e) DISPLAY TEST**

Pressing both the RST and ST-SP buttons at the same time will result in a display test function.

**SECTION 5 - PERFORMANCE**

No changes to the basic performance provided by Section 5 of this Pilot's Operating Handbook are necessary for this supplement.

**SUPPLEMENT 10**

**RCA WEATHERSCOUT II WEATHER RADAR SYSTEM**

**SECTION 1 - GENERAL**

This supplement supplies information necessary for the operation of the airplane when the optional RCA WeatherScout II Weather Radar System is installed. The information contained within this supplement is to be used in conjunction with the complete handbook.

This supplement has been "FAA Approved" as a permanent part of this handbook and must remain in this handbook at all times when the optional RCA WeatherScout II Weather Radar System is installed.

**SECTION 2 - LIMITATIONS**

No changes to the basic limitations provided by Section 2 of this Pilot's Operating Handbook are necessary for this supplement.

**SECTION 3 - EMERGENCY PROCEDURES**

No changes to the basic Emergency Procedures by Section 3 of this Pilot's Operating Handbook are necessary for this supplement.

**SECTION 4 - NORMAL PROCEDURES**

**(a) SYSTEM CONTROLS**

All controls used to operate the radar system are located on the front panel. These controls and the display features are indexed and identified in Figure 4-1 and described in Table 4-3.

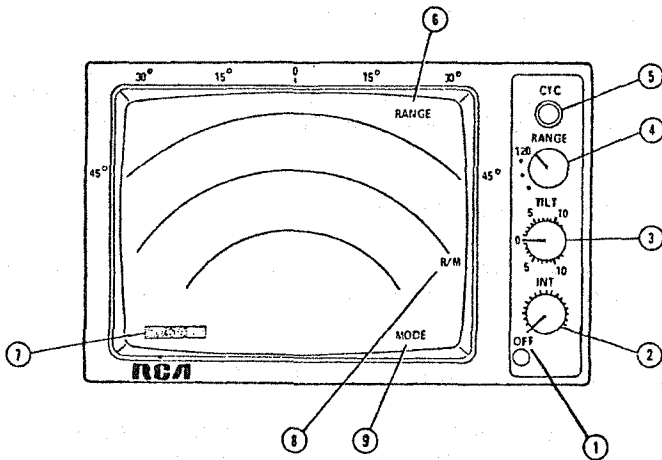

**INDICATOR CONTROLS AND DISPLAY FEATURES**  
Figure 4-1

- |  |  |
|--|--|
| (1) OFF  | On/Off function: full CCW rotation of INTensity control places system in OFF condition.  |
| (2) INT  | Rotary control used to regulate brightness (INTensity) of display.   |
| (3) TILT                                       | Rotary control used to adjust antenna elevation position. Control indexes increments of tilt from 0 to 12 degrees up or down.  |
| (4) RANGE<br>12/30/60/90<br>or<br>12/30/60/120 | Rotary switch used to select one of four ranges.   |
| (5) CYC  | Pushbutton switch used to select cyclical contour mode. Data is presented alternately as normal for 0.5 seconds, then contoured for 0.5 seconds. Pressing switch a second time restores normal or WX mode. |
| (6) Range Field                                | Maximum selected range is displayed. Maximum range is always displayed when indicator is in on-condition.  |
| (7) Test Field                                 | Test block displays three illumination levels.   |
| (8) Range Mark Identifier                      | Individual label displayed for each range mark.  |
| (9) Mode Field                                 | Operating mode is displayed as WX or CYC.  |

When system is first turned on, WAIT is displayed until system times out (30-40 seconds).

---

**INDICATOR CONTROLS AND DISPLAY FEATURES**

Table 4-3

**(b) PRELIMINARY CONTROL SETTINGS**

Place the Indicator controls in the following positions before applying power from the aircraft electrical system:

INTensity control . . . . . Fully counterclockwise, in OFF  
TILT control . . . . . Fully upward  
RANGE switch . . . . . 12 nautical miles

**(c) OPERATIONAL CONTROL SETTINGS**

- (1) Rotate INTensity control clockwise to bring system into ON condition.
- (2) Note that WAIT is displayed during warm-up period of 30-40 seconds.
- (3) When WX is displayed, rotate INTensity control clockwise until display brightness is at desired level.
- (4) Set RANGE switch to desired range.
- (5) Adjust TILT control for desired forward scan area.

**(d) PRECAUTIONS**

If the radar is to be operated while the aircraft is on the ground:

- (1) Direct nose of aircraft such that antenna scan sector is free of large metallic objects (hangars, other aircraft) for a distance of 100 yards (90 meters), and tilt antenna fully upward.

***WARNING***

Do not operate the radar during refueling operations or in the vicinity of trucks or containers accommodating flammables or explosives; do not allow personnel within 15 feet of area being scanned by antenna when system is transmitting.

- (2) Flash bulbs can be exploded by radar energy.
- (3) Since storm patterns are never stationary, the display is constantly changing, and continued observation is always advisable where areas of turbulence prevail.

**SECTION 5 - PERFORMANCE**

No changes to the basic performance provided by Section 5 of the Pilot's Operating Handbook are necessary for this supplement.

**THIS PAGE INTENTIONALLY LEFT BLANK**

**SUPPLEMENT 11**

**RDR-160 WEATHER RADAR SYSTEM**

**SECTION 1 - GENERAL**

This supplement supplies information necessary for the operation of the airplane when the optional RDR-160 Weather Radar System is installed. The information contained within this supplement is to be used in conjunction with the complete handbook.

This supplement has been "FAA Approved" as a permanent part of this handbook and must remain in this handbook at all times when the optional RDR-160 Weather Radar System is installed.

**SECTION 2 - LIMITATIONS**

No changes to the basic limitations provided by Section 2 of this Pilot's Operating Handbook are necessary for this supplement.

**SECTION 3 - EMERGENCY PROCEDURES**

No changes to basic Emergency Procedures by Section 3 of this Pilot's Operating Handbook are necessary for this supplement.

**SECTION 4 - NORMAL PROCEDURES**

**(a) SYSTEM CONTROLS**

Table 4-3 lists and describes the system controls, all of which are mounted on the panel of the radar indicator. Figure 4-1 illustrates the location of these controls. Table 4-5 lists the alphanumeric read-outs of range - range marks and mode selection as a function of switch position.



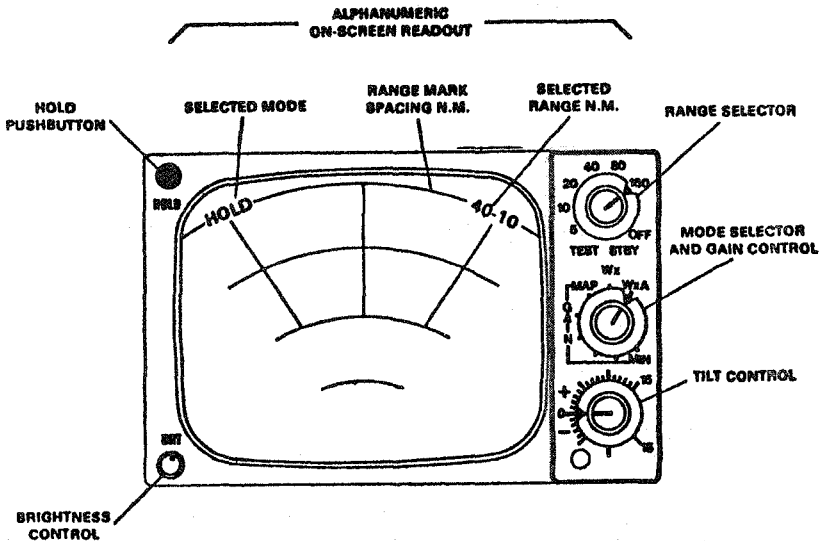

**LOCATION OF CONTROLS**  
Figure 4-1

CONTROL/ FUNCTION	OPERATIONAL USE
OFF/STBY/TEST	1. Controls primary power to radar system.
Range Selector	2. Places system in "standby" condition during warmup period and when system is not in use.  3. Places system in "test" mode to determine operability of system. No transmission in "test" mode.  4. Selects operating range. Enables transmitter.

**CONTROL FUNCTIONS AND OPERATION**  
Table 4-3

<b>CONTROL/ FUNCTION</b>	<b>OPERATIONAL USE</b>
<b>Wx/GAIN/Wx A</b>  <b>Gain Control and Mode Selector</b>	<ol style="list-style-type: none"><li>1. In Wx position, weather image gain is at pre-adjusted level. Contour operation is automatic and constant.</li><li>2. In GAIN position, 6 levels from MAP (maximum gain) to MIN may be selected for ground mapping operations. Contour operation is disabled.</li><li>3. In Wx A position, the radar indicator display alternately cycles between the Wx position and the GAIN MAP position. This will verify if a contour storm cell area is a storm cell and not a lake or some other terrain feature.</li></ol>
<b>HOLD</b> <b>Pushbutton</b>  <b>Video Hold/ Scan</b>	When the HOLD pushbutton initially depressed, weather or ground mapping image last presented is retained (frozen) on indicator display in order to evaluate the significance of storm cell movement. Depressing for a second time reveals direction and distance of target movement during hold period. During HOLD mode, the antenna continues to scan and the display will continue to be presented as long as power is supplied to the system. The word HOLD will be flashing.
<b>TILT</b>  <b>Antenna Tilt Control</b>	Electrically adjusts the antenna to move the radar beam to 15 degrees up or down from horizontal ("0" position).
<b>BRT</b>  <b>Brightness Control</b>	Control CRT picture intensity.

**CONTROL FUNCTIONS AND OPERATION (cont)**

Table 4-3 (cont)

**RADAR-160 WEATHER RADAR SYSTEM**

Range Switch Position	Range-Range Mark Readout
**TEST	40-10
5	5-1
10	10-2
20	20-4
40	40-10
80	80-20
160	160-40

Wx-MAP-Wx A Switch Position	Mode Readout*
Wx	Wx
MAP	MAP
WxA	WxA

\*When the HOLD pushbutton is initially depressed, the MODE READOUT displays flashing HOLD.

\*\*The MODE READOUT displays TEST.

**ALPHANUMERIC READOUT**

Table 4-5

**(b) GENERAL OPERATING PRECAUTIONS**

***WARNING***

Do not operate the radar during refueling operations or in the vicinity of trucks or containers accommodating flammables or explosives; do not allow personnel within 15 feet of area being scanned by antenna when system is transmitting.

- (1) Flash bulbs can be exploded by radar energy.
- (2) Since storm patterns are never stationary, the display is constantly changing, and continued observation is always advisable where areas of turbulence prevail.

**NOTE**

See RDR-160 pilot manual for detailed operating information and analysis of targets.

**SECTION 5 - PERFORMANCE**

No changes to the basic performance provided by Section 5 of the Pilot's Operating Handbook are necessary for this supplement.

**THIS PAGE INTENTIONALLY LEFT BLANK**

**SUPPLEMENT 12**

**RDR-160/IN-2026A WEATHER RADAR SYSTEM**

**SECTION 1 - GENERAL**

This supplement supplies information necessary for the operation of the airplane when the optional RDR-160/IN-2026A Weather Radar System is installed. The information contained within this supplement is to be used in conjunction with the complete handbook.

This supplement has been "FAA Approved" as a permanent part of this handbook and must remain in this handbook at all times when the optional RDR-160/IN-2026A Weather Radar System is installed.

**SECTION 2 - LIMITATIONS**

No changes to the basic limitations provided by Section 2 of this Pilot's Operating Handbook are necessary for this supplement.

**SECTION 3 - EMERGENCY PROCEDURES**

No changes to the basic Emergency Procedures by Section 3 of this Pilot's Operating Handbook are necessary for this supplement.

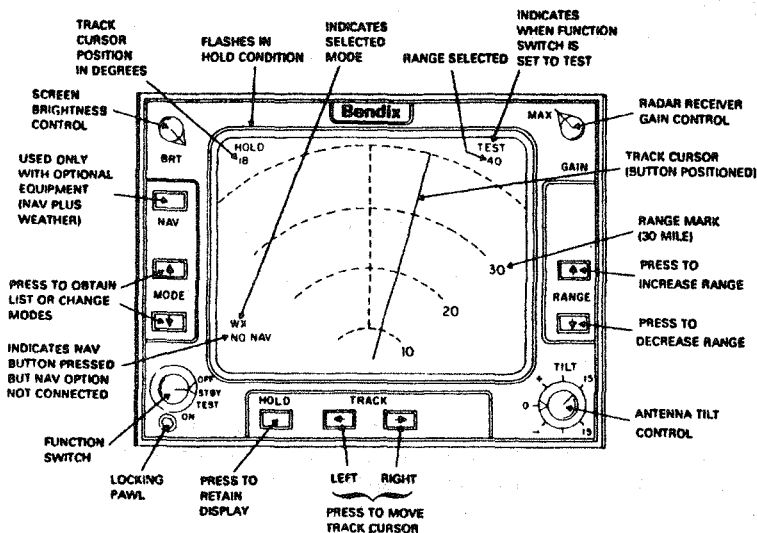

**IN-2026A CONTROLS AND DISPLAYS**

Figure 4-1

(a) **EQUIPMENT OPERATION AND CONTROLS**

(1) **RDR-160/IN-2026A CONTROLS AND DISPLAYS**

Controls and displays for the RDR-160/IN-2026A Weather Radar System are listed in table 4-3, with a functional description. Location of the controls and displays is shown in figure 4-1. All operating controls and displays are located on the indicator.

---

<b>CONTROL/ DISPLAY</b>	<b>FUNCTION</b>
<b>Function selector</b>	<ol style="list-style-type: none"><li>1. OFF position removes primary power from the system.</li><li>2. STBY position places system in the standby condition during warm-up period and when the system is not in use. No display.</li><li>3. TEST position selects test function to determine operability of the system. A test pattern is displayed. NO transmission exists in the TEST condition.</li><li>4. ON position selects the condition for normal operation. Radar transmission exists in the ON position.</li></ol>
<b>[ ↓ ] RANGE button</b>	Clears the display and places the indicator in the next lower range each time the button is pressed (eg: 40 to 20), until minimum range is reached.
<b>TILT control</b>	Electrically adjusts the antenna to move the radar beam up to +15 degrees above the horizontal, or to a maximum of -15 degrees below the horizontal position. The horizontal position is indicated as zero degrees on the control.
<b>TRACK [ → ] button</b>	When pressed, a yellow track cursor line appears and moves to the right (in one degree steps) while the button is held depressed. The track cursor stops when the button is released, and remains for about 10 to 15 seconds, then disappears unless the button is pressed again. The differential heading will be indicated in yellow numerals in the upper left corner of the display, and disappears simultaneously with the track cursor.

---

**CONTROL/DISPLAY FUNCTIONS**

Table 4-3



<b>CONTROL/ DISPLAY</b>	<b>FUNCTION</b>
TRACK [ ← ] button	When pressed, the yellow track cursor appears and moves to the left while held depressed. Operation is as explained above.
GAIN control	Varies the radar receiver gain when in the MAP mode. Gain and the STC are preset in TEST function and in the WX and WXA modes.
BRT control	Adjusts brightness of the display for varying cockpit light conditions.
[ ↑ ] MODE button	<p>Pressing momentarily produces an "information list" on the display. Pressing again, while information display is still present, advances the indicator display to the next higher mode shown on the list. The list disappears after a few seconds and the mode does not change if the button is not pressed again. The following standard modes are available in the order shown.</p> <p style="padding-left: 40px;">NAV FLT LOG - Functions available with optional IU-2023A.  MAP - Ground mapping  WXA - Weather mapping with alert.  The red area flashes.  WX - Weather mapping</p> <p>NOTE: When the top mode is reached, the button will not change the mode.</p>
[ ↓ ] MODE button	<p>Moves the indicator display to the next lower mode each time the button is pressed while the list is present. The sequence is as listed above.</p> <p>NOTE: When the bottom mode (WX) is reached, this button will not change the mode.</p>

**CONTROL/DISPLAY FUNCTIONS (cont)**

Table 4-3 (cont)

---

<b>CONTROL/ DISPLAY</b>	<b>FUNCTION</b>
NAV button (push-on/push-off)	Operational only when optional IU-2023A Remote Computer Unit is connected. When actuated, provides NAV information superimposed over the MODE selected (WX, WXA, or MAP). If interface is not connected, the words NO NAV will be displayed in the lower left corner.
[ ↑ ] RANGE button	Clears the display and advances the indicator to the next higher range each time the button is pressed (eg: 20 to 40, 40 to 80, etc.), until 160 mile range is reached. The range selected is displayed in the upper right corner (on the last range mark), and the distance to each of the other range marks circles is displayed along the right edge of the circles (arcs).
HOLD pushbutton (push-on/push-off)	Retains the display (NAV and weather) when button is actuated (push-on). The word HOLD flashes in the upper left corner of the display. The weather or ground mapping image last presented is retained (frozen) on indicator display in order to evaluate the significance of storm cell movement. Switching back to normal operation (pressing HOLD pushbutton a second time) reveals direction and distance of target movement during HOLD period. In HOLD, the antenna continues to scan and a non-updated display will continue to be presented as long as power is supplied to the system. A change in range selection with indicator in HOLD results in a blank screen.

---

**CONTROL/DISPLAY FUNCTIONS (cont)**

Table 4-3 (cont)

**(b) OPERATING PRECAUTIONS**

***WARNING***

Do not operate the radar during refueling operations or in the vicinity of trucks or containers accommodating flammables or explosives. Do not allow personnel within 15 feet of area being scanned by antenna when system is transmitting.

- (1) Flash bulbs can be exploded by radar energy.
- (2) Since storm patterns are never stationary, the display is constantly changing. Continued observation is always advisable in stormy areas.

**SECTION 5 - PERFORMANCE**

No changes to the basic performance provided by Section 5 of the Pilot's Operating Handbook are necessary for this supplement.

**SUPPLEMENT 13**

**RCA COLOR WEATHERSCOUT II WEATHER RADAR SYSTEM**

**SECTION 1 - GENERAL**

This supplement supplies information necessary for the operation of the airplane when the optional RCA Color WeatherScout II Weather Radar System is installed. The information contained within this supplement is to be used in conjunction with the complete handbook.

This supplement has been "FAA Approved" as a permanent part of this handbook and must remain in this handbook at all times when the optional RCA Color WeatherScout II Weather Radar System is installed.

**SECTION 2 - LIMITATIONS**

No changes to the basic limitations provided by Section 2 of this Pilot's Operating Handbook are necessary for this supplement.

**SECTION 3 - EMERGENCY PROCEDURES**

No changes to the basic Emergency Procedures by Section 3 of this Pilot's Operating Handbook are necessary for this supplement.

**SECTION 4 - NORMAL PROCEDURES**

**(a) SYSTEM CONTROLS**

All controls used to operate the radar system are located on the indicator front panel. These controls and the display features are indexed and identified in Figure 4-1 and described in Table 4-3.

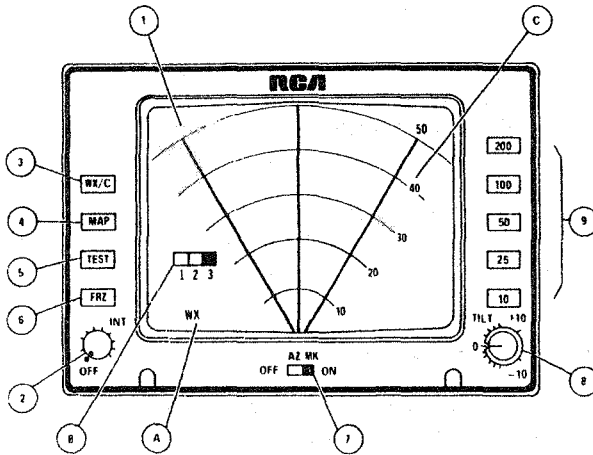

**INDICATOR CONTROLS AND DISPLAY FEATURES**

Figure 4-1

**(b) OPERATION**

**Preliminary Control Settings**

Place the Indicator controls in the following positions before applying power from the aircraft electrical system:

- INTensity control..... Fully counterclockwise, in OFF
- TILT control..... Fully upward
- RANGE switch..... 10 nautical miles

- (1) **Display Area** See item A, B, and C for explanation of alphanumeric display.
- (A) **Mode Field** Selected mode is displayed as WX, CYC, MAP, or TEST. STBY is displayed if R-T is warming up and no mode is selected after turn-on. WAIT is displayed if a mode is selected prior to end of warm up or when Indicator and Antenna are synchronizing.
- (B) **Auxiliary Field** FRZ is displayed as a blinking word if radar is in freeze mode (to remind pilot that radar display is not being updated for incoming target returns).
- 1 2 3 and color bar legend is displayed in WX/C, TEST and MAP modes. In weather mode color bar is green, yellow, and red. In map mode, color bar is cyan, yellow, and magenta.
- (C) **Range Mark Identifiers** Five labeled range marks are displayed on each range. Label of furthest mark is same as range selected. Range and azimuth marks are displayed in cyan for WX/C and TEST, green for MAP.
- (2) **INT/OFF** Rotary control used to regulate brightness (intensity) of display.
- On/Off function: Full CCW rotation of intensity control places system in OFF condition. CW rotation from OFF setting turns system on. STBY is displayed until WX/C, MAP, or TEST is selected.

---

**INDICATOR CONTROLS AND DISPLAY FEATURES**

Table 4-3

**NOTE:** WeatherScout systems using RTA-1001 (wing-mounted), employs a time-delay circuit that inhibits transmitter and antenna operation for 4.5 minutes from the time the aircraft engine is turned on.

If WX/C or MAP is selected initially or prior to the end of the warm-up period, WAIT will be displayed until RT warms up (approximately 30 seconds).

If TEST is selected immediately, WAIT will be displayed until Antenna is synchronized (less than 4 seconds) and then test pattern will appear.

**(3) WX/C**

Alternate-action pushbutton switch used to select weather mode or cyclic contour mode.

If selected at turn-on, system will come up in weather mode; second depression of switch will select cyclic contour mode.

If selected when system is already operating in another mode, system will return to weather mode; second switch depression will select cyclic contour mode.

In cyclic contour mode, 3-level (red) display will flash on and off at 1/2-second intervals.

**(4) MAP**

Pushbutton switch used to select ground mapping mode.

---

**INDICATOR CONTROLS AND DISPLAY FEATURES (cont)**

Table 4-3 (cont)

- 
- |                                    |  |
|------------------------------------|--|
| (5) TEST                           | Pushbutton switch used to select test mode. Special test pattern is displayed. In test, transmitter does not transmit and range is automatically 100 nm.   |
| (6) FRZ                            | Pushbutton switch used to select freeze mode. Radar display is not updated with incoming target return data. As a warning to the pilot, FRZ level will flash on and off at 1/2-second intervals. |
| (7) AZ MK                          | Slide switch used to display three-azimuth markers at 30-degree intervals.   |
| (8) TILT                           | Rotary control that enables pilot to select angles of antenna beam tilt with relation to airframe. Rotating control CW tilts beam upward; CCW rotation tilts beam downward.                      |
| (9) 10/25/50/100/<br>200 (DI-1005) | Push button switches used to select desired range. Five range marks are displayed for each range.  |
- 

**INDICATOR CONTROLS AND DISPLAY FEATURES (cont)**

Table 4-3 (cont)

**SECTION 5 - PERFORMANCE**

No changes to the basic performance provided by Section 5 of the Pilot's Operating Handbook are necessary for this supplement.



**THIS PAGE INTENTIONALLY LEFT BLANK**

**PILOT'S OPERATING HANDBOOK  
AND  
FAA APPROVED AIRPLANE FLIGHT MANUAL  
  
SUPPLEMENT NO. 14  
FOR  
ELECTRICAL DISTRIBUTION BUS MODIFICATION**

This supplement must be attached to the Pilot's Operating Handbook and FAA Approved Airplane Flight Manual when the Electrical Distribution Bus Modification is installed in accordance with Piper Kit No. 764 937V.

The information contained herein supplements or supersedes the information in the basic Pilot's Operating Handbook and FAA Approved Airplane Flight Manual only in those areas listed herein. For limitations, procedures and performance information not contained in this supplement, consult basic Pilot's Operating Handbook and FAA Approved Airplane Flight Manual.

FAA APPROVED \_\_\_\_\_

*Ward Evans*

WARD EVANS  
D.O.A. NO. SO-1  
PIPER AIRCRAFT CORPORATION  
VERO BEACH, FLORIDA

DATE OF APPROVAL \_\_\_\_\_

**SECTION 1 - GENERAL**

This supplement supplies information necessary for the operation of the airplane when the Electrical Distribution Bus Modification is installed in accordance with "FAA Approved" Piper data.

**SECTION 2 - LIMITATIONS**

No change

**SECTION 3 - EMERGENCY PROCEDURES**

**ELECTRICAL POWER LOSS**

ALT annunciator light illuminated.

Ammeters..... check to determine inop ALT

If one ammeter shows zero.

Inop. ALT switch ..... OFF

Reduce electrical loads to minimum

ALT circuit breaker (5A) & (60A)..... check and reset  
as required

Inop ALT switch ..... ON

If power is not restored

Inop ALT switch ..... OFF

Electrical loads ..... re-establish to 60 amps max.

If both ammeters show zero

ALT switches..... both OFF

Reduce electrical loads to minimum

ALT circuit breakers (5A) & (60A)..... check both and reset  
as required

ALT switches..... ON one at a time

If either or both ALTS are restored

leave its associated switch ON

Turn inop ALT switch OFF

Electrical loads ..... re-establish to 60 amps max.

If alternator outputs NOT restored:

ALT switches ..... OFF

Electrical loads ..... reduce to minimum

Land as soon as possible. The battery is the only remaining source of electrical power.

If both alternators cannot be restored and the battery circuit breaker is tripped, a main bus failure is indicated. Turn the emergency avionics switch to ON. Reduce avionics loads to minimum. Land as soon as practical.

***WARNING***

Compass error may exceed 10 degrees with both alternators inoperative.

**NOTE**

If the battery is depleted, the landing gear must be lowered using the emergency gear extension procedure. The gear position light will be inoperative.

**SECTION 4 - NORMAL PROCEDURES**

No change.

**SECTION 5 - PERFORMANCE**

No change.

**SECTION 6 - WEIGHT AND BALANCE**

No change.

**SECTION 7 - DESCRIPTION**

Modification of the electrical distribution system per Piper Kit 764 937V provides for additional isolation of main power distribution wires and electrical busses.

Three 60 amp circuit breakers were added for the output lines of the battery, right alternator and left alternator respectively. A 30 amp breaker was added to power the separate avionics bus. These four new breakers are located just below the existing circuit breaker panel on the right instrument panel and are placarded for their function. The existing emergency avionics master switch is also relocated to this panel for better pilot access. An 80 amp current limiter has also been added at the junction of the battery feed line and the starter contactor.

No change in normal operation of the aircraft electrical system is required by the addition of this supplement. Emergency procedures are covered in Section 3.

**TABLE OF CONTENTS**

**SECTION 10**

**SAFETY TIPS**

<b>Paragraph No.</b>		<b>Page No.</b>
10.1	General .....	10-1
10.3	Safety Tips .....	10-1

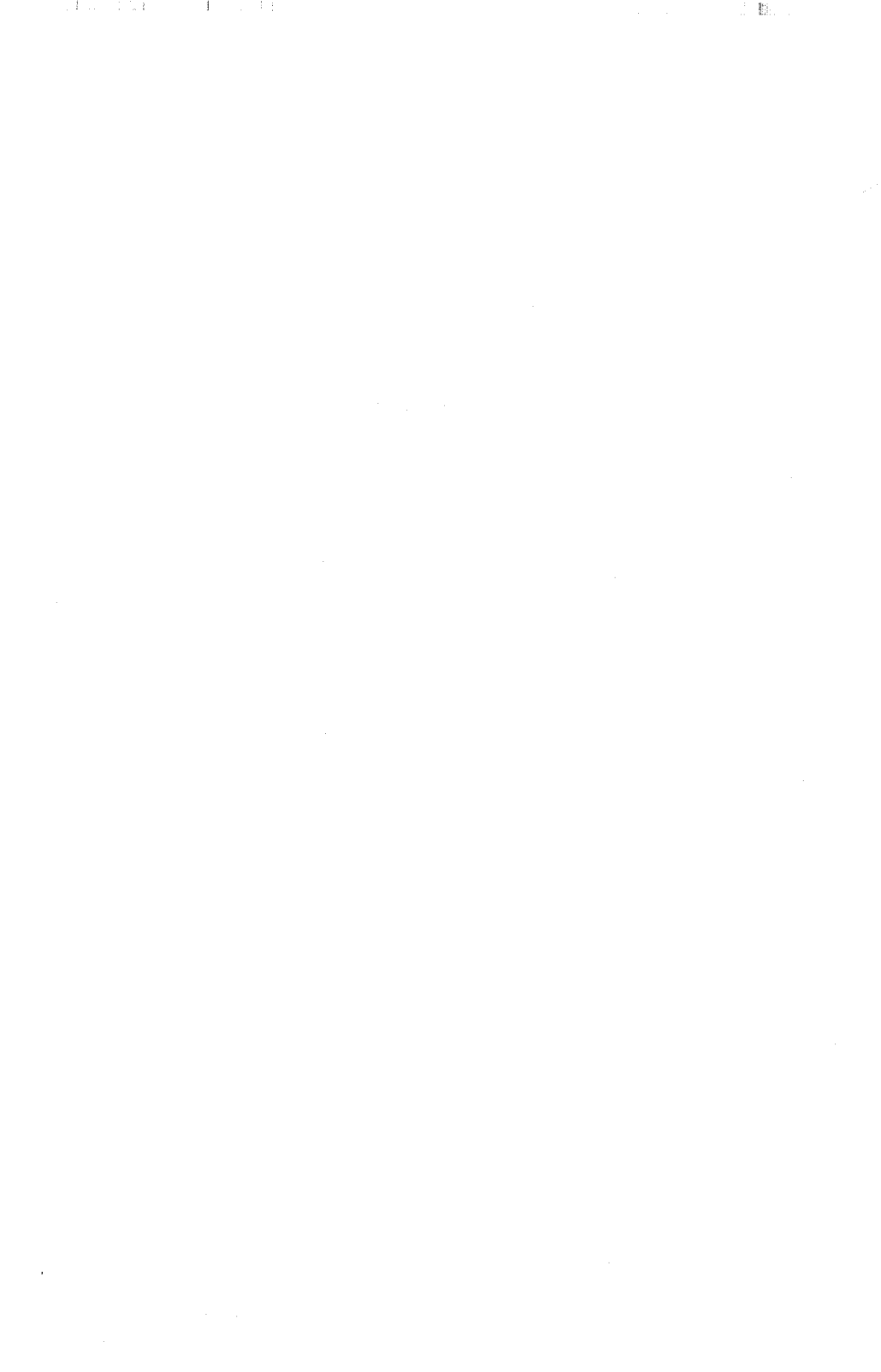

**SECTION 10  
SAFETY TIPS**

**10.1 GENERAL**

This section provides safety tips of particular value in the operation of the Piper Seminole.

**10.3 SAFETY TIPS**

- (a) Learn to trim for takeoff so that only a very light back pressure on the wheel is required to lift the airplane off the ground.
- (b) On takeoff, do not retract the gear prematurely. The airplane may settle and make contact with the ground because of lack of flying speed, atmospheric conditions, or rolling terrain.
- (c) Flaps may be lowered at airspeeds up to 111 KIAS. To reduce flap operating loads, it is desirable to have the airplane at a slower speed before extending the flaps. The flap step will not support weight if the flaps are in any extended position. The flaps must be placed in the "UP" position before they will lock and support weight on the step.
- (d) Before attempting to reset any circuit breaker, allow a two to five minute cooling off period.
- (e) Always determine position of landing gear by checking the gear position lights.
- (f) The shape of the nacelle fuel tanks is such that in certain maneuvers and with low fuel levels, the fuel may move away from the tank outlet. If the outlet is uncovered, the fuel flow will be interrupted and a temporary loss of power may result. Pilots can prevent inadvertent uncovering of the outlet by avoiding maneuvers which could result in uncovering the outlet.



Extreme running turning takeoffs should be avoided.

Prolonged slips and skids which result in excess of 2000 feet of altitude loss, or other radical or extreme maneuvers which could cause uncovering of the fuel outlet must be avoided as fuel flow interruption may occur when the tank being used is not full.

- (g) The rudder pedals are suspended from a torque tube which extends across the fuselage. The pilot should become familiar with the proper positioning of his feet on the rudder pedals so as to avoid interference with the torque tube when moving the rudder pedals or operating the toe brakes.
- (h) Anti-collision lights should not be operating when flying through clouds, fog, or haze, since reflected light can produce spacial disorientation. Strobe lights should not be used in close proximity to the ground such as during taxiing, takeoff or landing.
- (i) In an effort to avoid accidents, pilots should obtain and study the safety related information made available in FAA publications such as regulations, advisory circulars, Aviation News, AIM and safety aids.
- (j) Pilots who fly above 10,000 feet should be aware of the need for special physiological training. Appropriate training is available at approximately twenty-three Air Force Bases throughout the United States for a small fee. The training is free at the NASA Center in Houston and at the FAA Aeronautical Center in Oklahoma.

Forms to be completed (Physiological Training Application and Agreement) for application for the training course may be obtained by writing to the following address:

Chief of Physiological Training, AAC-143  
FAA Aeronautical Center  
P. O. Box 25082  
Oklahoma City, Oklahoma 73125

It is recommended that all pilots who plan to fly above 10,000 feet take this training before flying this high and then take refresher training every two or three years.

- (k) Sluggish RPM control and propeller overspeed with poor RPM recovery after rapid throttle application are indications that nitrogen pressure in the propeller dome is low.
- (l) Experience has shown that the training advantage gained by pulling a mixture control or turning off the fuel to simulate engine failure at low altitude is not worth the risk assumed, therefore it is recommended that instead of using either of these procedures to simulate loss of power at low altitude, the throttle be retarded slowly to idle position. Fast reduction of power may be harmful to the engine. A power setting of 2000 RPM and 11.5 in. Hg MAP is recommended for simulated one engine operation.
- (m) Before starting either engine, check that all radio switches, light switches and the pitot heat switch are in the OFF position so as not to create an overloaded condition when the starter is engaged.
- (n) The airplane should not be flown in severe turbulence as damage to the airframe structure could result.
- (o) The best speed for takeoff is about 75 KIAS under normal conditions. Trying to pull the airplane off the ground at too low an airspeed decreases the controllability of the airplane in the event of an engine failure.

