



Cessna.

MORE PEOPLE BUY AND
FLY CESSNA AIRPLANES
THAN ANY OTHER MAKE

1975

WORLD'S LARGEST PRO-
DUCER OF GENERAL
AVIATION AIRCRAFT
SINCE 1956

AERO
CLUB

Cardinal **RG**

IRONY 08



OWNER'S
MANUAL

PERFORMANCE - SPECIFICATIONS

*Cardinal RG ==

GROSS WEIGHT	2800 lbs
SPEED, BEST POWER MIXTURE:	
Top Speed at Sea Level	180 mph
Cruise, 75% Power at 7000 ft	171 mph
RANGE, EXTENDED RANGE MIXTURE:	
Cruise, 75% Power at 7000 ft	945 mi
60 Gallons, No Reserve	5.6 hrs
Maximum Range at 10,000 ft	1210 mi
60 Gallons, No Reserve	8.7 hrs
Maximum Range at 10,000 ft	139 mph
RATE OF CLIMB AT SEA LEVEL	925 fpm
SERVICE CEILING	17,100 ft
TAKE-OFF:	
Ground Run	890 ft
Total Distance Over 50-Foot Obstacle	1585 ft
LANDING:	
Ground Roll	730 ft
Total Distance Over 50-Foot Obstacle	1350 ft
STALL SPEED:	
Flaps Up, Power Off	66 mph
Flaps Down, Power Off	57 mph
EMPTY WEIGHT: (Approximate)	
Cardinal RG	1680 lbs
Cardinal RG II	1750 lbs
USEFUL LOAD:	
Cardinal RG	1120 lbs
Cardinal RG II	1050 lbs
BAGGAGE	120 lbs
WING LOADING: Pounds/Sq Foot	16.1
POWER LOADING: Pounds/HP	14.0
FUEL CAPACITY: Total	61 gal.
OIL CAPACITY	9 qts
PROPELLER: Constant Speed, Diameter	78 inches
ENGINE:	
Lycoming Fuel Injection Engine	IO-360-A1B6D
200 rated HP at 2700 RPM	

* This manual covers operation of the Cardinal RG which is certificated as Model 177RG under FAA Type Certificate No. A20CE. The manual also covers operation of the Reims/Cessna Cardinal RG which is certificated as Model F177RG under French Type Certification.

COPYRIGHT © 1993

D1039-13-CPS-350-6/93

Cessna Aircraft Company
Wichita, Kansas USA

CONGRATULATIONS

Welcome to the ranks of Cessna owners! Your Cessna has been designed and constructed to give you the most in performance, economy, and comfort. It is our desire that you will find flying it, either for business or pleasure, a pleasant and profitable experience.

This Owner's Manual has been prepared as a guide to help you get the most pleasure and utility from your Cardinal RG. It contains information about your Cessna's equipment, operating procedures, and performance; and suggestions for its servicing and care. We urge you to read it from cover to cover, and to refer to it frequently.

Our interest in your flying pleasure has not ceased with your purchase of a Cessna. World-wide, the Cessna Dealer Organization backed by the Cessna Service Department stands ready to serve you. The following services are offered by most Cessna Dealers:

THE CESSNA WARRANTY -- It is designed to provide you with the most comprehensive coverage possible:

- a. No exclusions
- b. Coverage includes parts and labor
- c. Available at Cessna Dealers world wide
- d. Best in the industry

Specific benefits and provisions of the warranty plus other important benefits for you are contained in your Customer Care Program book supplied with your aircraft. Warranty service is available to you at any authorized Cessna Dealer throughout the world upon presentation of your Customer Care Card which establishes your eligibility under the warranty.

FACTORY TRAINED PERSONNEL to provide you with courteous expert service.

FACTORY APPROVED SERVICE EQUIPMENT to provide you with the most efficient and accurate workmanship possible.

A STOCK OF GENUINE CESSNA SERVICE PARTS on hand when you need them.

THE LATEST AUTHORITATIVE INFORMATION FOR SERVICING CESSNA AIRPLANES, since Cessna Dealers have all of the Service Manuals and Parts Catalogs, kept current by Service Letters and Service News Letters, published by Cessna Aircraft Company.

We urge all Cessna owners to use the Cessna Dealer Organization to the fullest.

A current Cessna Dealer Directory accompanies your new airplane. The Directory is revised frequently, and a current copy can be obtained from your Cessna Dealer. Make your Directory one of your cross-country flight planning aids; a warm welcome awaits you at every Cessna Dealer.

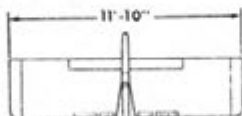
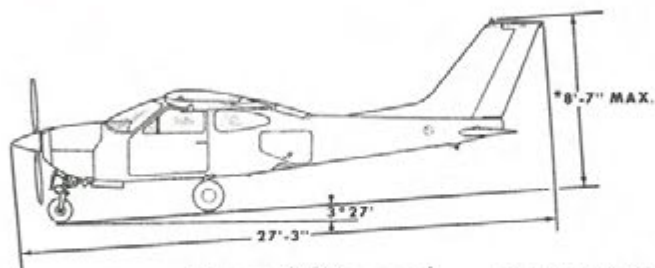

*Maximum height of aircraft with nose gear depressed and all tires and nose strut properly inflated.

**Wing span of aircraft with optional strobe lights installed.

PRINCIPAL DIMENSIONS

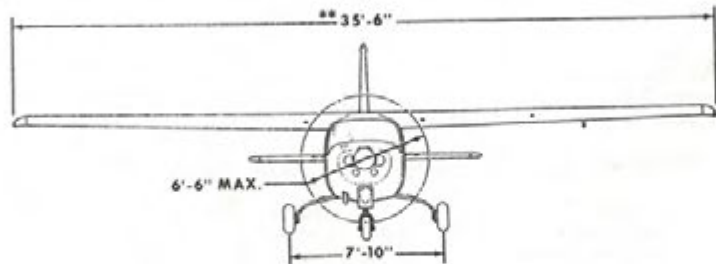
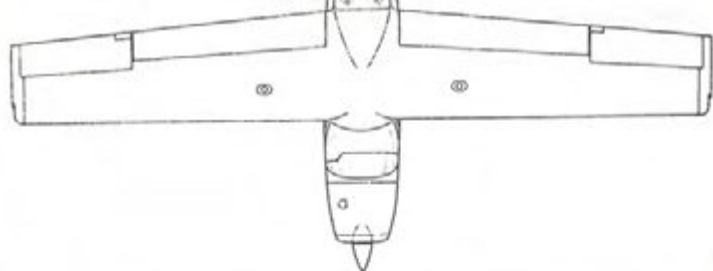

TABLE OF CONTENTS

	Page =
SECTION I - OPERATING CHECKLIST	1-1
SECTION II - DESCRIPTION AND OPERATING DETAILS	2-1
SECTION III - EMERGENCY PROCEDURES	3-1
SECTION IV - OPERATING LIMITATIONS	4-1
SECTION V - CARE OF THE AIRPLANE	5-1
SECTION VI - OPERATIONAL DATA	6-1
SECTION VII - OPTIONAL SYSTEMS	7-1
ALPHABETICAL INDEX	Index-1

This manual describes the operation and performance of the Cardinal RG and Cardinal RG II. Equipment described as "Optional" denotes that the subject equipment is optional on the Cardinal RG. Much of this equipment is standard on the Cardinal RG II.



Section I

OPERATING CHECKLIST

One of the first steps in obtaining the utmost performance, service, and flying enjoyment from your Cessna is to familiarize yourself with your aircraft's equipment, systems, and controls. This can best be done by reviewing this equipment while sitting in the aircraft. Those items whose function and operation are not obvious are covered in Section II.

Section I lists, in Pilot's Checklist form, the steps necessary to operate your aircraft efficiently and safely. It is not a checklist in its true form as it is considerably longer, but it does cover briefly all of the points that you should know for a typical flight. A more convenient plastic enclosed checklist, stowed in the map compartment, is available for quickly checking that all important procedures have been performed. Since vigilance for other traffic is so important in crowded terminal areas, it is important that preoccupation with checklists be avoided in flight. Procedures should be carefully memorized and performed from memory. Then the checklist should be quickly scanned to ensure that nothing has been missed.

The flight and operational characteristics of your aircraft are normal in all respects. There are no "unconventional" characteristics or operations that need to be mastered. All controls respond in the normal way within the entire range of operation. All airspeeds mentioned in Sections I, II and III are indicated airspeeds. Corresponding calibrated airspeed may be obtained from the Airspeed Correction Table in Section VI.

Refer to inside back cover of this manual for quantities, materials, and specifications of frequently used service items.

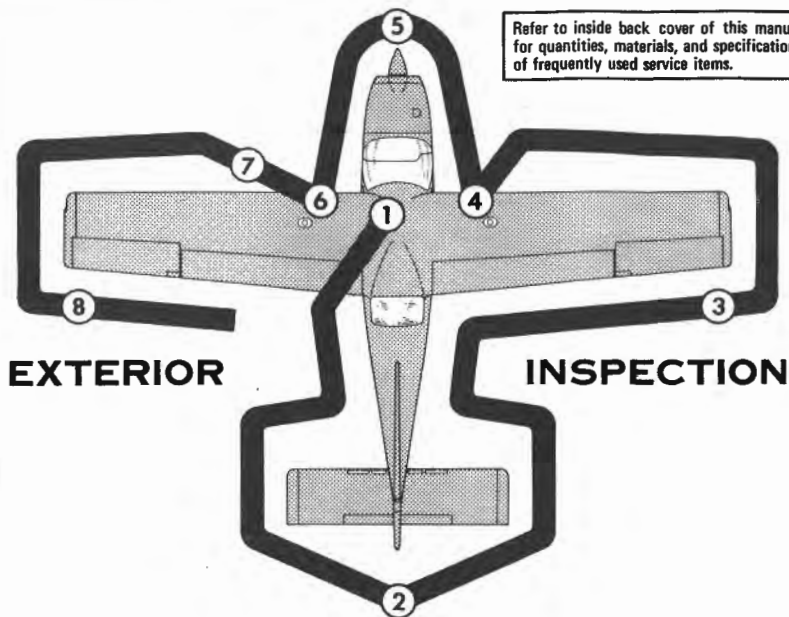

EXTERIOR

INSPECTION

Note

Visually check aircraft for general condition during walk-around inspection. In cold weather, remove even small accumulations of frost, ice or snow from wing, tail and control surfaces. Also, make sure that control surfaces contain no internal accumulations of ice or debris. If a night flight is planned, check operation of all lights, and make sure a flashlight is available.

①

- a. Check landing gear lever in DWN position.
- b. Remove control wheel lock.
- c. Check ignition switch OFF.
- d. Turn master switch ON; check fuel quantity indicators and landing gear DWN position indicator light (green) on; then turn master switch OFF.
- e. Check fuel selector valve handle in the BOTH position.

Figure

- f. Before first flight of the day and after each refueling, pull forward on fuel reservoir drain lever (under pilot's seat) for about four seconds to clear fuel system of possible water and sediment. After draining, make sure that reservoir drains are closed. If water is observed in this check the system may contain additional water. Check the fuel tank sump quick-drain valves for presence of water, and remove the fuel vent line drain plugs (in wing roots just outboard of cabin doors) and the fuel selector valve drain plug to check for the presence of water.
 - g. Check baggage door for security.
- ②
- a. Remove rudder gust lock, if installed.
 - b. Disconnect tail tie-down.
 - c. Check control surfaces for freedom of movement and security.
- ③
- a. Check aileron for freedom of movement and security.
 - b. Check fuel tank vent opening (at wing tip trailing edge) for stoppage.
- ④
- a. Disconnect wing tie-down.
 - b. Check main wheel tire for proper inflation.
 - c. Before first flight of day and after each refueling, use sampler cup and drain small quantity of fuel from fuel tank sump quick-drain valve to check for water, sediment, and proper fuel grade.
 - d. Visually check fuel quantity for desired level; then check fuel filler cap secure and vent unobstructed.
- ⑤
- a. Check engine oil level. Do not operate with less than six quarts. Fill to eight quarts for extended flight.
 - b. Check propeller and spinner for nicks and security, and propeller for oil leaks.
 - c. Check induction air filter for restrictions by dust or other foreign matter.
 - d. Check landing and taxi lights for condition and cleanliness.
 - e. Check nose wheel strut and tire for proper inflation; nose wheel doors for security.
 - f. Disconnect tie-down rope.
 - g. Inspect flight instrument static source openings on side of fuselage for stoppage (both sides).
- ⑥
- a. Check main wheel tire for proper inflation.
 - b. Before first flight of the day and after each refueling, use sampler cup and drain small quantity of fuel from fuel tank sump quick-drain valve to check for water, sediment, and proper fuel grade.
 - c. Visually check fuel quantity for desired level; then check fuel filler cap secure and vent unobstructed.
- ⑦
- a. Remove pitot tube cover, if installed, and check pitot tube opening for stoppage.
 - b. Disconnect wing tie-down.
- ⑧
- a. Check fuel tank vent opening (at wing tip trailing edge) for stoppage.
 - b. Check aileron for freedom of movement and security.

BEFORE STARTING ENGINE.

- (1) Exterior Preflight -- COMPLETE.
- (2) Seats, Belts, Shoulder Harnesses -- ADJUST and LOCK.
- (3) Fuel Selector Valve Handle -- BOTH.
- (4) Radios, Autopilot, Electrical Equipment -- OFF.
- (5) Brakes -- TEST and SET.
- (6) Cowl Flaps -- OPEN (move lever out of locking hole to reposition).
- (7) Landing Gear Lever -- DOWN.
- (8) Circuit Breakers -- CHECK IN.

STARTING ENGINE.

- (1) Mixture -- IDLE CUT-OFF.
- (2) Propeller -- HIGH RPM.
- (3) Throttle -- OPEN 1/4 INCH.
- (4) Master Switch -- ON.
- (5) Auxiliary Fuel Pump -- ON.
- (6) Mixture -- ADVANCE to 6 GAL/HR; then RETARD to IDLE CUT-OFF.

NOTE

If engine is warm, omit priming procedure above.

- (7) Propeller Area -- CLEAR.
- (8) Ignition Switch -- START (release when engine starts).
- (9) Mixture -- RICH (ADVANCE smoothly when engine fires).

NOTE

If engine floods, turn off auxiliary fuel pump, place mixture in idle cut-off, open throttle 1/2, and crank engine. When engine fires, advance mixture to full rich and retard throttle promptly.

- (10) Oil Pressure -- CHECK.
- (11) Auxiliary Fuel Pump -- OFF.

BEFORE TAKE-OFF.

- (1) Parking Brake -- SET.
- (2) Cabin Doors -- CLOSED and LOCKED.
- (3) Flight Controls -- FREE and CORRECT.

- (4) Stabilator and Rudder Trim -- TAKE-OFF.
- (5) Fuel Selector Valve Handle -- BOTH.
- (6) Throttle -- 1800 RPM.
 - a. Magnetos -- CHECK (RPM drop should not exceed 150 RPM on either magneto or 50 RPM differential between magnetos).
 - b. Propeller -- CYCLE from high to low RPM; return to high RPM.
 - c. Engine Instruments and Ammeter -- CHECK.
 - d. Suction Gage -- CHECK.
- (7) Flight Instruments and Radios -- SET.
- (8) Navigation Lights, Flashing Beacon, and Optional Strobe Lights -- ON (as required).
- (9) Throttle Friction Lock -- ADJUST.
- (10) Flaps -- 0° to 10°.

TAKE-OFF.

NORMAL TAKE-OFF.

- (1) Wing Flaps -- 0° to 10° (10° preferred).
- (2) Power -- MAXIMUM (full throttle and 2700 RPM). ↓
- (3) Mixture -- RICH (lean for field elevation per fuel flow placard above 3000 feet).
- (4) Aircraft Attitude -- LIFT NOSE WHEEL at 65 MPH.
- (5) Climb Speed -- 75 to 85 MPH.
- (6) Brakes -- APPLY momentarily when airborne.
- (7) Landing Gear -- RETRACT in climb out.
- (8) Wing Flaps -- RETRACT (if extended).

see STC
SA477CH

MAXIMUM PERFORMANCE TAKE-OFF.

- (1) Wing Flaps -- 10°.
- (2) Brakes -- APPLY.
- (3) Power -- MAXIMUM (full throttle and 2700 RPM). ↓
- (4) Mixture -- RICH (lean for field elevation per fuel flow placard above 3000 feet).
- (5) Brakes -- RELEASE.
- (6) Aircraft Attitude -- LIFT NOSE WHEEL at 60 MPH.
- (7) Climb Speed -- 70 MPH until all obstacles are cleared.
- (8) Brakes -- APPLY momentarily when airborne.
- (9) Landing Gear -- RETRACT after obstacles are cleared.
- (10) Wing Flaps -- RETRACT after reaching 80 MPH.

see STC
SA477CH

NOTE

Do not reduce power until landing gear and wing flaps have been retracted.

ENROUTE CLIMB.

NORMAL CLIMB.

- (1) Airspeed -- 100 to 120 MPH.
- (2) Power -- 25 INCHES Hg. and 2500 RPM.
- (3) Mixture -- LEANED to 13 GAL/HR.
- (4) Cowl Flaps -- OPEN as required.

MAXIMUM PERFORMANCE CLIMB.

- (1) Airspeed -- 95 MPH at sea level to 91 MPH at 10,000 feet.
- (2) Power -- MAXIMUM (full throttle and 2700 RPM).
- (3) Mixture -- LEAN per fuel flow placard.
- (4) Cowl Flaps -- FULL OPEN.

see STC
SA477CH

CRUISE.

- (1) Power -- 15 to 25 INCHES Hg., 2100 to 2500 RPM (no more than 75%).
- (2) Mixture -- LEAN per Cessna Power Computer or Operational Data, Section VI.
- (3) Cowl Flaps -- CLOSED.

LET-DOWN.

- (1) Power -- AS DESIRED.

NOTE

Avoid continuous operation between 1400 and 1750 RPM with less than 10 inches Hg.

- (2) Mixture -- ADJUST for smooth operation.
- (3) Cowl Flaps -- CLOSED.
- (4) Wing Flaps -- AS DESIRED (0° to 10° below 150 MPH, 10° to 30° below 110 MPH).
- (5) Landing Gear -- AS DESIRED (do not extend above 140 MPH).

BEFORE LANDING.

- (1) Seats, Belts, Harnesses -- ADJUST and LOCK.
- (2) Fuel Selector Valve Handle -- BOTH.
- (3) Landing Gear -- EXTEND below 140 MPH.
- (4) Mixture -- RICH.
- (5) Propeller -- HIGH RPM.
- (6) Airspeed -- 80 to 90 MPH (flaps UP).
- (7) Wing Flaps -- AS DESIRED (0° to 10° below 150 MPH, 10° to 30° below 110 MPH).
- (8) Airspeed -- 70 to 80 MPH (flaps DOWN).
- (9) Stabilator and Rudder Trim -- ADJUST.

BALKED LANDING.

- (1) Power -- MAXIMUM (full throttle and 2700 RPM).
- (2) Wing Flaps -- RETRACT to 20° .
- (3) Airspeed -- 75 MPH.
- (4) Wing Flaps -- RETRACT slowly.
- (5) Cowl Flaps -- OPEN.

NORMAL LANDING.

- (1) Touchdown -- MAIN WHEELS FIRST.
- (2) Landing Roll -- LOWER NOSE WHEEL GENTLY.
- (3) Braking -- MINIMUM REQUIRED.

AFTER LANDING.

- (1) Wing Flaps -- UP.
- (2) Cowl Flaps -- OPEN.

SECURING AIRCRAFT.

- (1) Parking Brake -- SET.
- (2) Radios, Electrical Equipment -- OFF.
- (3) Mixture -- IDLE CUT-OFF (pulled full out).
- (4) Ignition and Master Switches -- OFF.
- (5) Control Lock -- INSTALL.
- (6) Fuel Selector Valve Handle -- LEFT or RIGHT.

INSTRUMENT PANEL

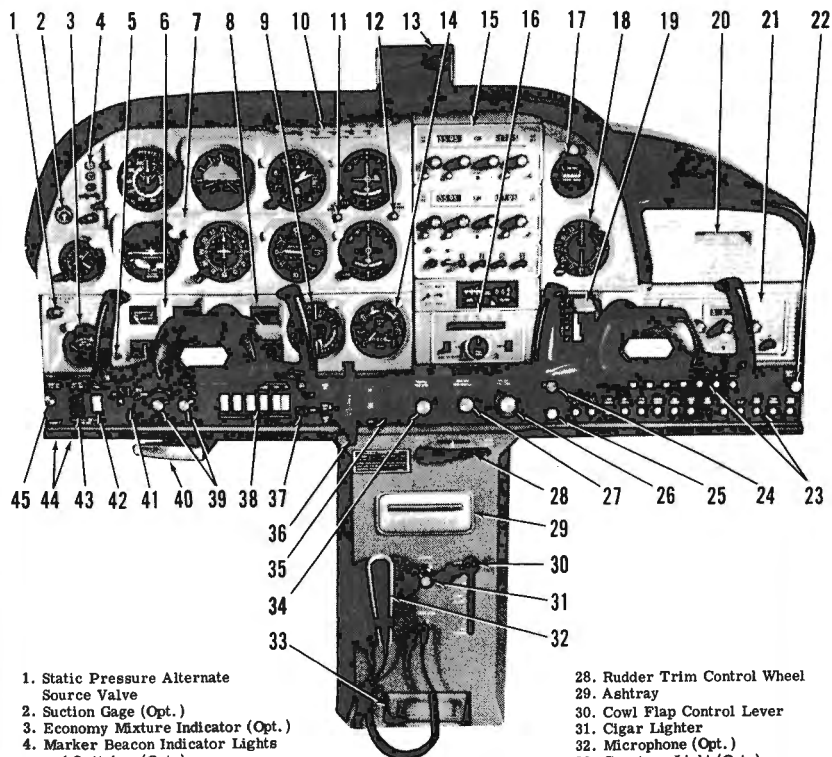

- | | |
|---|--|
| <ol style="list-style-type: none"> 1. Static Pressure Alternate Source Valve 2. Suction Gage (Opt.) 3. Economy Mixture Indicator (Opt.) 4. Marker Beacon Indicator Lights and Switches (Opt.) 5. Over-Voltage Warning Light 6. Cylinder Head Temperature, Left Fuel Quantity Indicator, Ammeter, and Oil Pressure Gage 7. Flight Instrument Group 8. Right Fuel Quantity Indicator and Oil Temperature Gage 9. Manifold Pressure/Fuel Flow Indicator 10. Radio Selector Switches (Opt.) 11. No. 1 LOC Reversed Indicator Light (Opt.) 12. No. 2 LOC Reversed Indicator Light (Opt.) 13. Rear View Mirror (Opt.) 14. Tachometer 15. Radios (Opt.) 16. Autopilot Control Unit (Opt.) 17. Flight Hour Recorder (Opt.) 18. ADF Bearing Indicator (Opt.) 19. Wing Flap Switch and Indicator 20. Map Compartment 21. ADF Radio (Opt.) 22. Right Cabin Air Control Knob 23. Circuit Breakers 24. Defroster Control Knob 25. Cabin Heat Control Knob 26. Mixture Control Knob 27. Propeller Control Knob | <ol style="list-style-type: none"> 28. Rudder Trim Control Wheel 29. Ashtray 30. Cowl Flap Control Lever 31. Cigar Lighter 32. Microphone (Opt.) 33. Courtesy Light (Opt.) 34. Throttle 35. Landing Gear Lever 36. Stabilator Trim Control Wheel 37. Landing Gear Position Indicator Lights 38. Electrical Switches 39. Instrument and Radio Dial Light Rheostats 40. Parking Brake Handle 41. Ignition Switch 42. Auxiliary Fuel Pump Switch 43. Master Switch 44. Phone and Auxiliary Mike Jacks 45. Left Cabin Air Control Knob |
|---|--|

Figure 2-1.

Section II

DESCRIPTION AND OPERATING DETAILS

The following paragraphs describe the systems and equipment whose function and operation is not obvious when sitting in the aircraft. This section also covers in somewhat greater detail some of the items listed in Checklist form in Section I that require further explanation.

FUEL SYSTEM.

Fuel is supplied to the engine from two integral fuel tanks, one in each wing. With the fuel selector valve handle in the BOTH position, the total usable fuel for all flight conditions is 60 gallons with the tanks completely filled.

NOTE

With heavy cabin loadings, it may be necessary to reduce the fuel load to keep the aircraft within the approved weight limits (refer to Section IV for weight and balance control procedures). To facilitate fueling to reduced fuel loads, a 22 gallon marker is provided inside each tank filler neck in the form of a series of small holes.

Fuel from each wing fuel tank flows through a reservoir tank to the fuel selector valve, through a bypass in the electric auxiliary fuel pump to the fuel strainer, and then to the engine-driven fuel pump. From here fuel is distributed to the engine cylinders via a control unit and injector manifold.

The auxiliary fuel pump is used primarily for priming the engine before starting. Priming is accomplished through the regular injection system.

If the auxiliary fuel pump switch is accidentally placed in the ON position (with master switch turned on and mixture rich) with the engine

FUEL SYSTEM SCHEMATIC

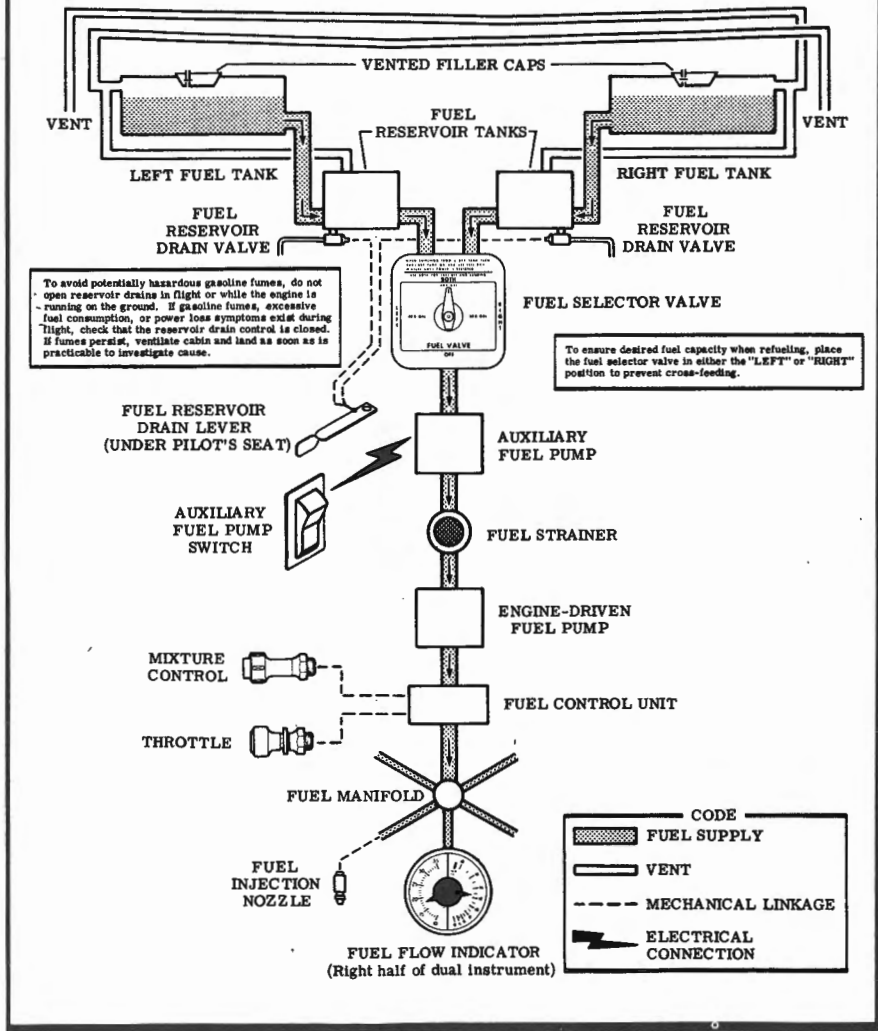

Figure 2-2.

stopped, the intake manifolds will be flooded.

The auxiliary fuel pump is also used for vapor suppression in hot weather. Normally, momentary use will be sufficient for vapor suppression; however, continuous operation is permissible if required. Turning on the auxiliary fuel pump with a normally operating engine pump will result in only a very minor enrichment of the mixture.

It is not necessary to have the auxiliary fuel pump operating during normal take-off and landing, since gravity and the engine-driven pump will supply adequate fuel flow to the fuel injector unit.

In the event of failure of the engine-driven pump, use of the auxiliary fuel pump will provide sufficient fuel to maintain flight at maximum continuous power.

The fuel selector valve handle should be in the BOTH position for take-off, landing, and power-on maneuvers that involve prolonged slips or skids. During prolonged climb or cruise with the fuel selector in BOTH position, unequal fuel flow from each tank may occur if the aircraft is out of trim directionally (slip indicator ball not centered) or if the fuel tank caps are not sealing properly. The resulting heaviness can be alleviated gradually by turning the selector valve to the tank in the heavy wing.

To ensure a prompt engine restart after running a fuel tank dry, switch the fuel selector to the opposite tank at the first indication of fuel flow fluctuation or power loss. Then turn on the auxiliary fuel pump and advance the mixture control to full rich. After power and steady fuel flow are restored, turn off the auxiliary fuel pump and lean the mixture, if desirable. Prior to landing, the fuel selector should be returned to the BOTH position.

NOTE

With low fuel (1/16th tank or less) a prolonged powered steep descent (1000 feet or more) should be avoided with more than 10° flaps to prevent the possibility of fuel starvation resulting from uncovering the fuel tank outlets. If starvation should occur, leveling the nose and turning on the auxiliary fuel pump should restore engine power within 30 seconds.

For fuel system servicing information, refer to Servicing Requirements on the inside back cover.

FUEL TANK SUMP QUICK-DRAIN VALVES.

Each fuel tank sump is equipped with a fuel quick-drain valve to facilitate draining and/or examination of fuel for contamination and grade. The valve extends through the lower surface of the wing just outboard of the cabin door. A sampler cup stored in the aircraft is used to examine the fuel. Insert the probe in the sampler cup into the center of the quick-drain valve and push. Fuel will drain from the tank sump into the sampler cup until pressure on the valve is released.

ELECTRICAL SYSTEM.

Electrical energy is supplied by a 14-volt, direct-current system powered by an engine-driven alternator (see figure 2-3). The 12-volt battery is located aft of the rear cabin wall. Power is supplied to all electrical circuits through a split bus bar, one side containing electronic system circuits and the other side having general electrical system circuits. Both sides of the bus are on at all times except when either an external power source is connected or the starter switch is turned on; then a power contactor is automatically activated to open the circuit to the electronic bus. Isolating the electronic circuits in this manner prevents harmful transient voltages from damaging the transistors in the electronic equipment.

MASTER SWITCH.

The master switch is a split-rocker type switch labeled MASTER, and is ON in the up position and OFF in the down position. The right half of the switch, labeled BAT, controls all electrical power to the airplane. The left half, labeled ALT, controls the alternator.

Normally, both sides of the master switch should be used simultaneously; however, the BAT side of the switch could be turned ON separately to check equipment while on the ground. The ALT side of the switch, when placed in the OFF position, removes the alternator from the electrical system. With this switch in the OFF position, the entire electrical load is placed on the battery. Continued operation with the alternator switch OFF will reduce battery power low enough to open the battery contactor, remove power from the alternator field, and prevent alternator restart.

ELECTRICAL SYSTEM

SCHMATIC

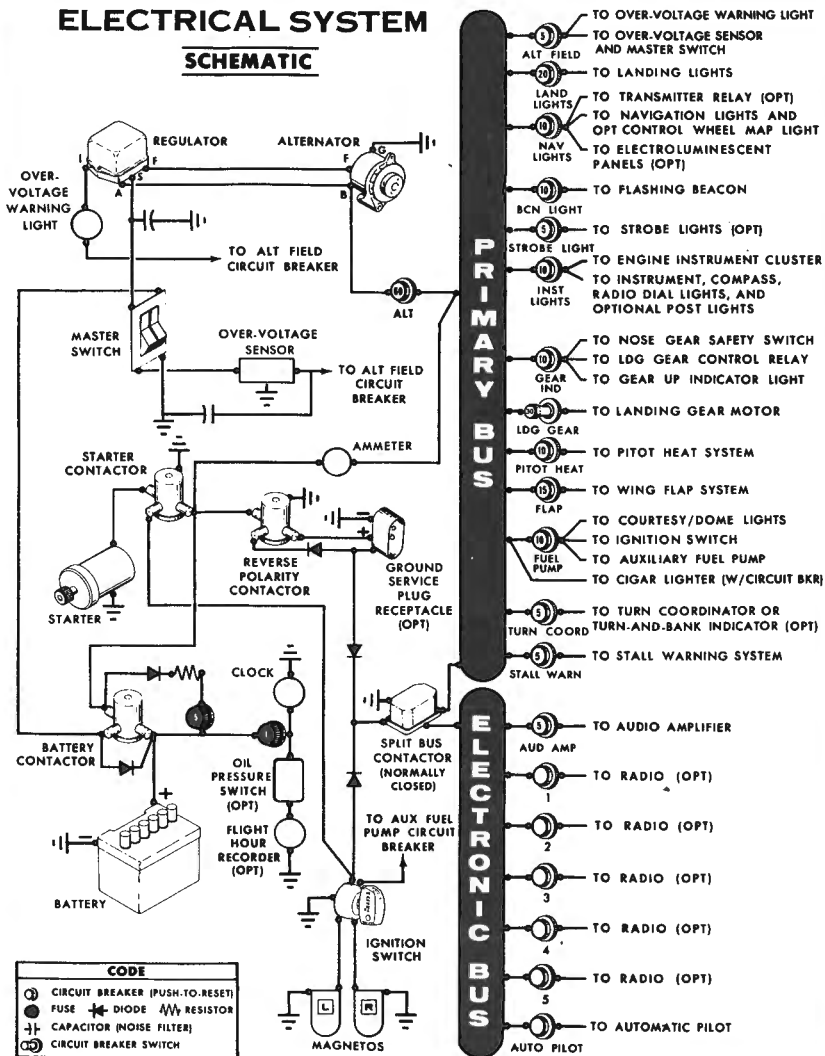

Figure 2-3.

AMMETER.

The ammeter indicates the flow of current, in amperes, from the alternator to the battery or from the battery to the aircraft electrical system. When the engine is operating and the master switch is ON, the ammeter indicates the charging rate applied to the battery. In the event the alternator is not functioning or the electrical load exceeds the output of the alternator, the ammeter indicates the battery discharge rate.

OVER-VOLTAGE SENSOR AND WARNING LIGHT.

The aircraft is equipped with an automatic over-voltage protection system consisting of an over-voltage sensor behind the instrument panel and a red warning light, labeled HIGH VOLTAGE, near the ammeter.

In the event an over-voltage condition occurs, the over-voltage sensor automatically removes alternator field current and shuts down the alternator. The red warning light will then turn on, indicating to the pilot that the alternator is not operating and the aircraft battery is supplying all electrical power.

The over-voltage sensor may be reset by turning the master switch off and back on again. If the warning light does not illuminate, normal alternator charging has resumed; however, if the light does illuminate again, a malfunction has occurred, and the flight should be terminated as soon as practical.

The warning light may be tested by momentarily turning off the ALT portion of the master switch and leaving the BAT portion turned on.

CIRCUIT BREAKERS AND FUSES.

Most of the electrical circuits in the aircraft are protected by "push-to-reset" circuit breakers mounted on the right side of the instrument panel. Exceptions to this are the battery contactor closing (external power) circuit, clock and optional flight hour recorder circuits which have fuses mounted near the battery. The landing gear circuit is protected by a push-pull type circuit breaker on the right side of the instrument panel, and the cigar lighter has a manually reset type circuit breaker mounted on the back of the lighter socket.

When more than one radio is installed, the radio transmitter relay (which is a part of the radio installation) is protected by the navigation lights circuit breaker labeled NAV LIGHTS. It is important to remember

that any malfunction in the navigation lights system which causes the circuit breaker to open will de-activate both the navigation lights and the transmitter relay. In this event, the navigation light switch should be turned off to isolate the circuit; then reset the circuit breaker to reactivate the transmitter relay and permit its usage. Do not turn on the navigation lights switch until the malfunction has been corrected.

LIGHTING EQUIPMENT.

EXTERIOR LIGHTING.

Conventional navigation lights are located on the wing tips and top of the rudder. Landing and taxi lights are installed in the nose cap, and a flashing beacon is mounted on top of the vertical fin. Optional lighting includes a strobe light on each wing tip and two courtesy lights, one under each wing, just outboard of the cabin door. The courtesy lights are operated by a switch located on the left rear door post. All exterior lights, except the courtesy lights, are controlled by rocker type switches on the left switch and control panel. The switches are ON in the up position and OFF in the down position.

The flashing beacon should not be used when flying through clouds or overcast; the flashing light reflected from water droplets or particles in the atmosphere, particularly at night, can produce vertigo and loss of orientation.

The two high intensity strobe lights will enhance anti-collision protection. However, the lights should be turned off when taxiing in the vicinity of other aircraft, or during night flight through clouds, fog or haze.

INTERIOR LIGHTING.

Instrument and control panel lighting is provided by flood lighting, integral lighting, and optional post and electroluminescent lighting. Two rheostat control knobs on the left switch and control panel, labeled PANEL LIGHTS and ENG-RADIO LIGHTS, control the intensity of the instrument and control panel lighting. A slide-type switch on the left side of the overhead console, labeled PANEL LTS, is used to select either standard flood

lighting in the FLOOD position, optional post lighting in the POST position, or a combination of post and flood lighting in the BOTH position.

Switches and controls on the lower part of the instrument panel may be lighted by optional electroluminescent panels which do not require light bulbs for illumination. To operate this lighting, turn on the NAV LIGHTS switch and adjust light intensity with the control knob labeled PANEL LIGHTS. Electroluminescent lighting is not affected by the selection of post or flood lighting.

Instrument and control panel flood lighting consists of four red flood lights on the underside of the anti-glare shield, and a single red flood light in the forward part of the overhead console. To use flood lighting, place the PANEL LTS selector switch in the FLOOD position and adjust light intensity with the PANEL LIGHTS rheostat control knob.

The instrument panel may be equipped with optional post lights which are mounted at the edge of each instrument or control and provide direct lighting. The lights are operated by placing the PANEL LTS selector switch in the POST position and adjusting light intensity with the PANEL LIGHTS rheostat control knob. By placing the PANEL LTS selector switch in the BOTH position, the post lights can be used in combination with the standard flood lighting.

The engine instrument cluster, radio equipment, and magnetic compass have integral lighting and operate independently of post or flood lighting. The light intensity of these items is controlled by the ENG-RADIO LIGHTS rheostat control knob.

A cabin dome light is located in the aft part of the overhead console, and is operated by a switch adjacent to the light. To turn the light on, move the switch to the right.

The instrument panel control pedestal may be equipped with an optional courtesy light, mounted at its base, which illuminates the forward cabin floor area. This light is controlled by the courtesy light switch on the left rear door post.

An optional map light may be mounted on the bottom of the pilot's control wheel. The light illuminates the lower portion of the cabin just forward of the pilot and is helpful when checking maps and other flight data during night operations. To operate the light, first turn on the NAV LIGHTS switch; then adjust the map light's intensity with the knurled disk type rheostat control located at the bottom of the control wheel.

LANDING GEAR SYSTEM.

The retractable tricycle landing gear is extended and retracted by hydraulic actuators powered by an electrically-driven hydraulic power pack. The power pack assembly is located aft of the rear baggage compartment wall. Mechanically-actuated wheel well doors are provided for the nose gear. They are open when the nose gear is down and closed when it is retracted.

An over-center mechanical linkage provides a positive mechanical up and down lock for the nose wheel. The main gear utilizes hydraulic sequence valve downlocks and hydraulic pressure for positive uplock. Main gear uplock pressure is maintained automatically by the power pack assembly. If pressure drops below that necessary to retain uplock pressure on the main gear, the power pack will automatically compensate.

Two position-indicator lights, mounted to the left of the stabilator trim control wheel, indicate that the gear is either up or down and locked. Both the gear UP (amber) and gear DWN (green) lights are the press-to-test type, incorporating dimming shutters for night operation. As an additional reminder that the gear is retracted, a warning horn sounds intermittently whenever the throttle is retarded below approximately 12 inches manifold pressure (master switch on) with the gear up or not down and locked.

LANDING GEAR LEVER.

The gear lever, mounted to the left of the engine controls, has two positions (up for gear up, and down for gear down) which give a mechanical indication of landing gear position. From either position, the lever must be pulled out slightly to clear a detent before it can be repositioned; operation of the landing gear system will not begin until the lever has been repositioned. After the lever has been repositioned, hydraulic pressure is directed within the system to actuate the gear to the selected position. The gear lever will remain in whichever position has been selected.

During a normal cycle, the gear locks up or down and the position indicator light comes on indicating completion of the cycle. Landing gear extension can be detected by illumination of the gear DWN indicator light (green), absence of a gear warning horn with the throttle retarded below approximately 12 inches manifold pressure, and visual inspection of the main gear position. Indication of gear retraction is provided by illumination of the gear UP (amber) light. Should a gear indicator light fail to

illuminate, the light should be checked for a burned-out bulb by pressing to test. A burned-out bulb can be replaced in flight with the bulb from the remaining indicator light.

A safety switch, actuated by the nose gear, electrically prevents inadvertent retraction whenever the nose gear strut is compressed by the weight of the aircraft. Also, a switch type circuit breaker is provided as a maintenance safety feature. With the switch pulled out, landing gear operation is prevented. After maintenance is completed, and prior to flight, the switch should be placed in the on position (pushed in).

EMERGENCY HAND PUMP.

The landing gear emergency hand pump is located on the floor between the front seats and is used to manually extend the gear in the event of hydraulic pump failure. When not in use, the pump handle is retracted and stowed beneath a hinged cover marked with a placard outlining emergency operation procedures. Refer to Section III for emergency operation of the hand pump.

CABIN HEATING, VENTILATING AND DEFROSTING SYSTEM.

The temperature and volume of airflow into the cabin can be regulated to any degree desired by adjustment of a single CABIN HEAT knob and two CABIN AIR knobs. When partial cabin heat is desired, blending warm and cold air will result in improved ventilation and heat distribution throughout the cabin.

Front cabin heat and ventilating air from the main heat and ventilating system is routed through two manifolds located forward of the rudder pedals to directionally-adjustable, on-off ventilators on the front cabin sidewalls. Rear cabin heat and air is supplied by ducts from both front cabin ventilators, one extending down each side of the cabin to the forward doorpost, then along the lower edge of the cabin door to an outlet near the aft edge of the door. Airflow from each outlet may be directed through either of two louvered openings by rotating a knob on top of the outlet. For maximum rear cabin heating, close both front cabin ventilators.

Windshield defrost air is supplied from the left cabin manifold; therefore, the temperature of the defrosting air is the same as heated cabin air. A push-pull control knob labeled DEFROSTER regulates the volume of air to the windshield. Pull the knob out as necessary for defrosting.

Four separately adjustable overhead ventilators supply individual air; two are mounted in a console above the pilot and co-pilot, and two optional individual ventilators may be mounted in the rear cabin ceiling.

Additional ground and flight ventilation is available through an openable vent window in each cabin door. These windows can be opened at speeds up to 120 MPH by rotating the crank located below the window.

SHOULDER HARNESSES.

Shoulder harnesses are provided as standard equipment for the pilot and front seat passenger, and as optional for the rear seat passengers. Seat belts are standard equipment for all passengers.

Each front seat harness is attached to a rear door post just above window line and is stowed behind a stowage sheath mounted above the cabin door. When stowing the harness, fold it and place it behind the sheath. The optional rear seat shoulder harnesses are attached adjacent to the lower corners of the rear window. Each rear seat harness is stowed behind a stowage sheath located above the aft side window.

To use the front and rear seat shoulder harnesses, fasten and adjust the seat belt first. Remove the harness from the stowed position, and lengthen as required by pulling on the end of the harness and the narrow release strap. Snap the harness metal stud firmly into the retaining slot adjacent to the seat belt buckle. Then adjust to length by pulling down on the free end of the harness. A properly adjusted harness will permit the occupant to lean forward enough to sit completely erect but is tight enough to prevent excessive forward movement and contact with objects during sudden deceleration. Also, the pilot will want the freedom to reach all controls easily.

Releasing and removing the shoulder harness is accomplished by pulling upward on the narrow release strap, and removing the harness stud from the slot in the seat belt buckle. In an emergency, the shoulder harness may be removed by releasing the seat belt first, and pulling the harness over the head by pulling up on the release strap.

INTEGRATED SEAT BELT/SHOULDER HARNESSSES WITH INERTIA REELS.

Optional integrated seat belt/shoulder harnesses with inertia reels are available for the pilot and front seat passenger. The seat belt/shoulder harnesses extend from inertia reels located in the cabin ceiling to attach points inboard of the two front seats. A separate seat belt half and buckle is located outboard of the seats. Inertia reels allow complete freedom of body movement. However, in the event of a sudden deceleration, they will lock up automatically to protect the occupants.

NOTE

The inertia reels are located for maximum shoulder harness comfort and safe retention of the seat occupants. This location requires that the shoulder harnesses cross near the top so that the right hand inertia reel serves the pilot and the left hand reel serves the front passenger. When fastening the harness, check to ensure the proper harness is being used.

To use the seat belt/shoulder harness, adjust the metal buckle half on the harness up far enough to allow it to be drawn across the lap of the occupant and be fastened into the outboard seat belt buckle. Adjust seat belt tension by pulling up on the shoulder harness. To remove the seat belt/shoulder harness, release the seat belt buckle and allow the inertia reel to draw the harness to the inboard side of the seat.

STARTING ENGINE.

In cold weather, the engine compartment temperature drops off rapidly following engine shutdown and the injector nozzle lines remain nearly full of fuel. Cold weather starting procedures are therefore relatively simple with highly predictable results. However, in extremely hot weather, engine compartment temperatures increase rapidly following engine shutdown, and fuel in the lines will vaporize and escape into the intake manifold.

Hot weather starting procedures depend considerably on how soon

the next engine start is attempted. Within the first 20 to 30 minutes after shutdown, the fuel manifold is adequately primed and the empty injector nozzle lines will fill before the engine dies. However, after approximately 30 minutes, the vaporized fuel in the manifold will have nearly dissipated and some slight "priming" could be required to refill the nozzle lines and keep the engine running after the initial start. Starting a hot engine is facilitated by advancing the mixture control promptly to 1/3 open when the engine fires, and then smoothly to full rich as power develops.

Should the engine tend to die after starting, turn on auxiliary fuel pump temporarily and adjust throttle as necessary to keep the engine running.

Weak intermittent firing followed by puffs of black smoke from the exhaust stack indicate over-priming or flooding. In this event, turn off the auxiliary fuel pump, open the throttle from 1/2 to full open and continue cranking with the mixture full lean. When the engine fires, smoothly advance the mixture control to full rich and retard the throttle to desired idle speed.

If the engine is underprimed (most likely in cold weather with a cold engine) it will not fire at all, and additional priming will be necessary.

After starting, if the oil pressure gage does not begin to show pressure within 30 seconds in the summertime and about twice that long in very cold weather, stop the engine and investigate. Lack of oil pressure can cause serious engine damage.

NOTE

Additional details concerning cold weather starting and operation may be found under COLD WEATHER OPERATION paragraphs in this section.

TAXIING.

When taxiing it is important that speed and use of brakes be held to a minimum and that all controls be utilized (see taxiing diagram, figure 2-4) to maintain directional control and balance. Taxiing over loose

TAXIING DIAGRAM

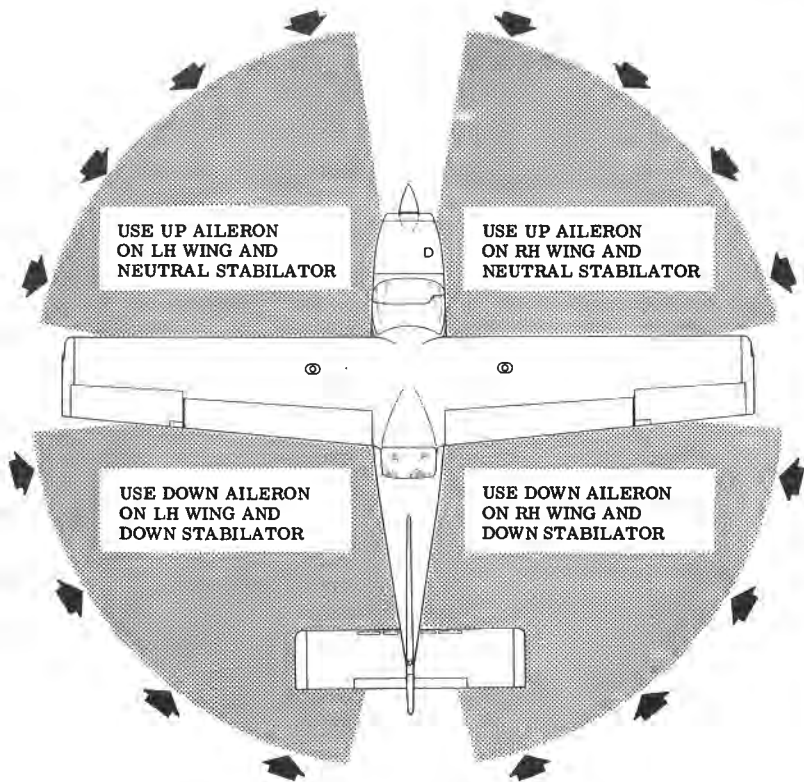

CODE

WIND DIRECTION



NOTE

Strong quartering tail winds require caution. Avoid sudden bursts of the throttle and sharp braking when the airplane is in this attitude. Use the steerable nose wheel and rudder to maintain direction.

Figure 2-4.

gravel or cinders should be done at low engine speed to avoid abrasion and stone damage to the propeller tips.

BEFORE TAKE-OFF.

WARM-UP.

Since the engine is closely cowled for efficient in-flight engine cooling, precautions should be taken to avoid overheating during prolonged engine operation on the ground. Also, long periods of idling at low RPM may cause fouled spark plugs. If the engine accelerates smoothly, the airplane is ready for take-off.

MAGNETO CHECK.

The magneto check should be made at 1800 RPM as follows: Move the ignition switch first to R position, and note RPM. Next move switch back to BOTH to clear the other set of plugs. Then move switch to L position, note RPM and return the switch to the BOTH position. The RPM drop should not exceed 150 RPM on either magneto or show greater than 50 RPM differential between magnetos. A smooth drop off past normal is usually a sign of a too lean or too rich mixture. If there is a doubt concerning operation of the ignition system, RPM checks at a leaner mixture setting or at higher engine speeds will usually confirm whether a deficiency exists.

An absence of RPM drop may be an indication of faulty grounding of one side of the ignition system or should be cause for suspicion that the magneto timing is set in advance of the setting specified.

ALTERNATOR CHECK.

Prior to flights where verification of proper alternator and voltage regulator operation is essential (such as night or instrument flights), a positive verification can be made by loading the electrical system momentarily (3 to 5 seconds) with the landing light or by operating the wing flaps during the engine runup (1800 RPM). The ammeter will remain within a needle width of zero if the alternator and voltage regulator are operating properly.

TAKE-OFF.

POWER CHECK.

It is important to check full-throttle engine operation early in the take-off run. Any signs of rough engine operation or sluggish engine acceleration are good cause for discontinuing the take-off.

The auxiliary fuel pump is normally off during take-offs. However, if there is evidence of fuel vapor, as indicated by fluctuation of the fuel flow indicator needle, or rough engine operation, the pump should be turned on. It is not necessary to readjust the mixture control when operating with the auxiliary fuel pump turned on because the mixture is only slightly enriched.

Full-throttle runups over loose gravel are especially harmful to propeller tips. When take-offs must be made over a gravel surface, it is very important that the throttle be advanced slowly. This allows the airplane to start rolling before high RPM is developed, and the gravel will be blown back of the propeller rather than pulled into it. When unavoidable small dents appear in the propeller blades, they should be corrected immediately as described in Section V under propeller care.

Prior to take-off from short fields above 3000 feet elevation, the mixture should be leaned in accordance with the maximum power fuel flow placard located on the instrument panel control pedestal.

After full throttle is applied, adjust the throttle friction lock clockwise to prevent the throttle from creeping back from a maximum power position. Similar friction lock adjustments should be made as required in other flight conditions to maintain a fixed throttle setting.

WING FLAP SETTINGS.

Take-offs are accomplished with the wing flaps set in the 0° to 10° position. The preferred flap setting for normal take-off is 10° . This flap setting (in comparison to flaps up) produces an approximately 15% shorter ground run and total take-off distance over an obstacle. In addition, it provides easier lift-off and increased visibility over the nose in the initial climb-out.

Flap settings of greater than 10° are not recommended at any time for take-off.

LANDING GEAR RETRACTION.

Since the landing gear swings downward approximately one foot as it starts the retraction cycle, retraction should be avoided until well clear of the runway and after a positive climb is established. This is especially important when attempting a short field take-off, where a premature lift-off might result in the airplane settling back onto the ground. On long runways the landing gear retraction can be delayed until reaching the point over the runway where a wheels-down forced landing on that runway would be impractical.

Before retracting the landing gear, the brakes should be applied momentarily to stop wheel rotation. Centrifugal force caused by the rapidly spinning wheel expands the diameter of the tire. If there is an accumulation of mud or ice in the wheel wells, the rotating wheel may rub as it is retracted into the wheel well.

PERFORMANCE CHARTS.

Consult the Take-Off Data chart in Section VI for take-off distances with 10° flaps under various gross weight, altitude, headwind, temperature, and runway surface conditions.

CROSSWIND TAKE-OFFS.

Take-offs into strong crosswinds normally are performed with the minimum flap setting necessary for the field length to minimize the drift angle immediately after take-off. The airplane is accelerated to a speed slightly higher than normal, and then pulled off abruptly to prevent possible settling back to the runway while drifting. When clear of the ground, make a coordinated turn into the wind to correct for drift.

ENROUTE CLIMB.

See STCSA477CH

Normal climbs are performed at 100 to 120 MPH with landing gear and flaps retracted and reduced power (down to 25 inches of manifold pressure and 2500 RPM) for increased passenger comfort due to lower noise level. The mixture may be left full rich as long as the engine is smooth. For optimum power with 25 inches manifold pressure and 2500 RPM, set the mixture to 13 GPH. With full throttle and 2500 RPM, set the mixture to 2 GPH less than shown in the maximum power mixture placard. Maximum rate of climb is achieved with full throttle and 2700 RPM at speeds ranging

from 95 MPH at sea level to 91 MPH at 10,000 feet. The mixture should be leaned for altitude in accordance with the maximum power fuel flow placard.

If an enroute obstacle dictates the use of a steep climb angle, an obstacle clearance speed of 80 MPH should be used with landing gear and flaps retracted and full throttle at all altitudes.

CRUISE.

Normal cruising is performed between 55% and 75% power. The corresponding power settings and fuel consumption for various altitudes can be determined by using your Cessna Power Computer or the Operational Data in Section VI.

NOTE

Cruising should be done at 65% to 75% power until a total of 50 hours has accumulated or oil consumption has stabilized. This is to ensure proper seating of the rings and is applicable to new engines, and engines in service following cylinder replacement or top overhaul of one or more cylinders.

The Cruise Performance table shown below illustrates the true airspeed and miles per gallon during cruise for various altitudes and percent

CRUISE PERFORMANCE						
	75% POWER		65% POWER		55% POWER	
ALTITUDE	TAS	MPG	TAS	MPG	TAS	MPG
Sea Level	160	14.8	150	16.0	140	17.3
3500 Feet	165	15.3	155	16.5	145	17.9
7000 Feet	170	15.7	160	17.0	149	18.4
Standard Conditions					Zero Wind	

powers. This table should be used as a guide, along with the available winds aloft information, to determine the most favorable altitude and power setting for a given trip. The selection of cruise altitude on the basis of the most favorable wind conditions and the use of low power settings are significant factors that should be considered on every trip to reduce fuel consumption.

For reduced noise levels, it is desirable to select the lowest RPM in the green arc range for a given percent power that will provide smooth engine operation. The cowl flaps should be opened, if necessary, to maintain the cylinder head temperature at approximately three-fourths of the normal operating range (green arc).

Cruise performance data in this manual and on the power computer is based on an extended range mixture setting which is approximately one-half gallon per hour less than the best power mixture setting. This extended range mixture setting results in a one MPH speed loss and an average increase of 10% in range when compared to a best power mixture setting.

For best fuel economy at 75% power or less, the engine may be operated at one-half gallon per hour leaner than shown in this manual and on the power computer. This will result in approximately 4% greater range than shown in the cruise tables of this manual accompanied by approximately 2 MPH decrease in speed.

The fuel injection system used on this engine is considered to be non-icing. In the event the main intake filter becomes blocked, an alternate intake valve opens automatically, supplying unfiltered air from the lower engine compartment and resulting in a 5% power loss at full throttle.

LEANING WITH A CESSNA ECONOMY MIXTURE INDICATOR (EGT).

Exhaust gas temperature (EGT) as shown on the optional Cessna Economy Mixture Indicator may be used as an aid for mixture leaning in cruising flight at 75% power or less. To adjust the mixture, using this indicator, lean to establish the peak EGT as a reference point and then enrichen the mixture by a desired increment based on the table on the following page.

As noted in this table, operation at peak EGT provides best fuel economy. This results in approximately 4% greater range than shown

MIXTURE DESCRIPTION	EXHAUST GAS TEMPERATURE	RANGE INCREASE FROM BEST POWER
BEST POWER	Peak EGT Minus 100° F (Enrichen)	0%
EXTENDED RANGE (Owner's Manual and Computer Performance)	Peak EGT Minus 25° F (Enrichen)	10%
BEST ECONOMY	Peak EGT	14%

in the cruise tables of this manual accompanied by approximately 2 MPH decrease in speed.

When leaning the mixture, under some conditions, engine roughness may occur before peak EGT is reached. In this case, use the EGT corresponding to the onset of roughness as the reference point instead of peak EGT. Any change in altitude or power will require a recheck of the EGT indication.

STALLS.

The stall characteristics are conventional and aural warning is provided by a stall warning horn which sounds between 5 and 10 MPH above the stall in all configurations.

Power-off stall speeds at maximum gross weight and aft c. g. position are presented on page 6-2 as calibrated airspeeds since indicated airspeeds are unreliable near the stall.

BEFORE LANDING.

The landing gear is normally extended before entering the traffic pattern. This practice will allow more time to confirm that the landing gear is down and locked. As a further precaution, the landing gear may be left extended in go-around procedures or traffic patterns for touch-and-go landings.

Landing gear extension can be detected by illumination of the gear DWN indicator light (green), absence of a gear warning horn with the throttle retarded below approximately 12 inches of manifold pressure, and visual inspection of the main gear position.

LANDING.

Normal landing approaches can be made with power on or power off at speeds of 80 to 90 MPH with flaps up and 70 to 80 MPH with flaps down. Surface winds and air turbulence are usually the primary factors in determining the most comfortable approach speeds. Slips are permitted with any desired flap setting. Actual touchdown should be made with power off and on the main wheels first. The nose wheel should be lowered smoothly to the runway as speed is diminished.

Full down stabilator (control wheel positioned full forward) should not be used during the ground roll. This reduces the weight on the main wheels which causes poor braking and increases the possibility of sliding the tires.

SHORT FIELD LANDINGS.

For a maximum performance short field landing in smooth air conditions, make an approach at 70 MPH with full flaps using enough power to control the glide path. (Slightly higher approach speeds should be used under turbulent air conditions.) After all approach obstacles are cleared, progressively reduce power and maintain 70 MPH by lowering the nose of the airplane. Touchdown should be made with power-off and on the main wheels first. Immediately after touchdown, lower the nose wheel and apply heavy braking as required. For maximum brake effectiveness, retract the flaps, hold the control wheel full back, and apply maximum brake pressure without sliding the tires.

CROSSWIND LANDINGS.

When landing in a strong crosswind, use the minimum flap setting required for the field length. Although the crab or combination method of drift correction may be used, the wing-low method gives the best control. After touchdown, hold a straight course with the steerable nose wheel and occasional braking if necessary.

The maximum allowable crosswind velocity is dependent upon pilot

capability rather than airplane limitations. With average pilot technique, direct crosswinds of 15 knots can be handled with safety.

BALKED LANDING.

In a bailed landing (go-around) climb, apply full throttle and 2700 RPM smoothly, and reduce wing flaps promptly to 20°. Upon reaching an airspeed of approximately 75 MPH, flaps should be slowly retracted to the full up position.

If obstacles are immediately ahead during the go-around, the landing gear should be left down and the wing flaps should be left at 20° until obstacles are cleared. At field elevations above 3000 feet, the mixture should be leaned for maximum power.

COLD WEATHER OPERATION.

STARTING.

Prior to starting on a cold morning, it is advisable to pull the propeller through several times by hand to "break loose" or "limber" the oil, thus conserving battery energy.

NOTE

When pulling the propeller through by hand, treat it as if the ignition switch is turned on. A loose or broken ground wire on either magneto could cause the engine to fire.

In extremely cold (0°F and lower) weather, the use of an external pre-heater and an external power source are recommended whenever possible to obtain positive starting and to reduce wear and abuse to the engine and the electrical system. Pre-heat will thaw the oil trapped in the oil cooler, which probably will be congealed prior to starting in extremely cold temperatures. When using an external power source, the position of the master switch is important. Refer to Section VII, paragraph Ground Service Plug Receptacle, for operating details.

Cold weather starting procedures are the same as the normal starting procedures in Section I. Use caution to prevent inadvertent forward movement of the airplane during starting when parked on snow or ice.

NOTE

If the engine does not start during the first few attempts, or if engine firing diminishes in strength, it is probable that the spark plugs have been frosted over. Preheat must be used before another start is attempted.

During cold weather operations, no indication will be apparent on the oil temperature gage prior to take-off if outside air temperatures are very cold. After a suitable warm-up period (2 to 5 minutes at 1000 RPM), accelerate the engine several times to higher engine RPM. If the engine accelerates smoothly and the oil pressure remains normal and steady, the airplane is ready for take-off.

STATIC PRESSURE ALTERNATE SOURCE VALVE.

A static pressure alternate source valve is installed in the left side of the instrument panel for use when the external static source is malfunctioning. This valve supplies static pressure from inside the rear fuselage instead of the external static ports. An external condensate drain, located in the alternate source line under the pilot's floorboard, is provided for periodic draining of any moisture accumulation.

If erroneous instrument readings are suspected due to water or ice in the pressure lines going to the standard external static pressure source, the alternate static source valve should be pulled on.

Pressures within the rear fuselage will vary with open cabin ventilators and vent windows. With the windows closed, the most adverse vent configuration results in minor airspeed and altimeter variations of less than 5 MPH and 50 feet, respectively. However, opening the vent windows may result in large errors (depending on the sealing effectiveness of the baggage curtain) which increase with increasing airspeed. For example, at the placarded maximum window open speed of 120 MPH, the airspeed indicator and altimeter may read low by as much as 12 MPH and 90 feet, respectively. To avoid the possibility of large errors, the windows should not be open when using the alternate static source.

HOT WEATHER OPERATION.

The general warm temperature starting information on page 2-12 is appropriate. Avoid prolonged engine operation on the ground.

NOISE ABATEMENT.

Increased emphasis on improving the quality of our environment requires renewed effort on the part of all pilots to minimize the effect of aircraft noise on the public.

We, as pilots, can demonstrate our concern for environmental improvement, by application of the following suggested procedures, and thereby tend to build public support for aviation:

- (1) Pilots operating aircraft under VFR over outdoor assemblies of persons, recreational and park areas, and other noise-sensitive areas should make every effort to fly not less than 2,000 feet above the surface, weather permitting, even though flight at a lower level may be consistent with the provisions of government regulations.
- (2) During departure from or approach to an airport, climb after take-off and descent for landing should be made so as to avoid prolonged flight at low altitude near noise-sensitive areas.

NOTE

The above recommended procedures do not apply where they would conflict with Air Traffic Control clearances or instructions, or where, in the pilot's judgment, an altitude of less than 2,000 feet is necessary for him to adequately exercise his duty to see and avoid other aircraft.

Section III

EMERGENCY PROCEDURES

Emergencies caused by aircraft or engine malfunctions are extremely rare if proper pre-flight inspections and maintenance are practiced. Enroute weather emergencies can be minimized or eliminated by careful flight planning and good judgement when unexpected weather is encountered. However, should an emergency arise the basic guidelines described in this section should be considered and applied as necessary to correct the problem.

ENGINE FAILURE.

ENGINE FAILURE AFTER TAKE-OFF.

Prompt lowering of the nose to maintain airspeed and establish a glide attitude is the first response to an engine failure after take-off. In most cases, the landing should be planned straight ahead with only small changes in direction to avoid obstructions. Altitude and airspeed are seldom sufficient to execute a 180° gliding turn necessary to return to the runway. The following procedures assume that adequate time exists to secure the fuel and ignition systems prior to touchdown.

- (1) Airspeed -- 80 MPH (flaps UP).
75 MPH (flaps DOWN).
- (2) Mixture -- IDLE CUT-OFF.
- (3) Fuel Selector Valve -- OFF.
- (4) Ignition Switch -- OFF.
- (5) Wing Flaps -- AS REQUIRED (30° recommended).
- (6) Master Switch -- OFF.

ENGINE FAILURE DURING FLIGHT.

While gliding toward a suitable landing area, an effort should be made

to identify the cause of the failure. If time permits, and an engine restart is feasible, proceed as follows:

- (1) Airspeed -- 85 MPH.
- (2) Fuel Selector Valve -- BOTH.
- (3) Mixture -- RICH.
- (4) Auxiliary Fuel Pump -- ON.
- (5) Ignition Switch -- BOTH (or START if propeller is not windmilling).

If the engine cannot be restarted, a forced landing without power must be executed. A recommended procedure for this is given in the following paragraph.

FORCED LANDINGS.

EMERGENCY LANDING WITHOUT ENGINE POWER.

If all attempts to restart the engine fail and a forced landing is imminent, select a suitable field and prepare for the landing as follows:

- (1) Airspeed -- 85 MPH (flaps UP).
75 MPH (flaps DOWN).
- (2) Mixture -- IDLE CUT-OFF.
- (3) Fuel Selector Valve -- OFF.
- (4) Ignition Switch -- OFF.
- (5) Landing Gear -- DOWN (UP if terrain is rough or soft).
- (6) Wing Flaps -- AS REQUIRED (30° recommended).
- (7) Master Switch -- OFF.
- (8) Doors -- UNLATCH PRIOR TO TOUCHDOWN.
- (9) Touchdown -- SLIGHTLY TAIL LOW.
- (10) Brakes -- APPLY HEAVILY.

PRECAUTIONARY LANDING WITH ENGINE POWER.

Before attempting an "off airport" landing, one should drag the landing area at a safe but low altitude to inspect the terrain for obstructions and surface conditions, proceeding as follows:

- (1) Drag over selected field with flaps 20° and 75 MPH airspeed,

noting the preferred area for touchdown for the next landing approach. Then retract flaps upon reaching a safe altitude and airspeed.

- (2) Radio, Electrical Switches -- OFF.
- (3) Landing Gear -- DOWN (UP if terrain is rough or soft).
- (4) Wing Flaps -- 30° (on final approach).
- (5) Airspeed -- 75 MPH.
- (6) Master Switch -- OFF.
- (7) Doors -- UNLATCH PRIOR TO TOUCHDOWN.
- (8) Touchdown -- SLIGHTLY TAIL LOW.
- (9) Ignition Switch -- OFF.
- (10) Brakes -- APPLY HEAVILY.

DITCHING.

Prepare for ditching by securing or jettisoning heavy objects located in the baggage area, and collect folded coats or cushions for protection of occupant's face at touchdown. Transmit Mayday message on 121.5 MHz giving location and intentions.

- (1) Plan approach into wind if winds are high and seas are heavy. With heavy swells and light wind, land parallel to swells.
- (2) Approach with landing gear retracted, flaps 30°, and sufficient power for a 300 ft./min. rate of descent at 70 MPH.
- (3) Unlatch the cabin doors.
- (4) Maintain a continuous descent until touchdown in level attitude. Avoid a landing flare because of difficulty in judging aircraft height over a water surface.
- (5) Place folded coat or cushion in front of face at time of touchdown.
- (6) Evacuate aircraft through cabin doors. If necessary, open vent window to flood cabin compartment for equalizing pressure so that door can be opened.
- (7) Inflate life vests and raft (if available) after evacuation of cabin. The aircraft cannot be depended on for flotation for more than a few minutes.

FIRES.

ENGINE FIRE IN FLIGHT.

Although engine fires are extremely rare in flight, the following steps should be taken if one is encountered:

- (1) Mixture -- IDLE CUT-OFF.

- (2) Fuel Selector Valve -- OFF.
- (3) Master Switch -- OFF.
- (4) Cabin Heat and Air -- OFF (except overhead vents).
- (5) Airspeed -- 100 to 120 MPH. If fire is not extinguished, increase glide speed to find an airspeed which will provide an incombustible mixture.

Execute a forced landing as outlined in preceding paragraphs.

ELECTRICAL FIRE IN FLIGHT.

The initial indication of an electrical fire is usually the odor of burning insulation. The following procedure should then be used:

- (1) Master Switch -- OFF.
- (2) All other switches (except ignition switch) -- OFF.
- (3) Vents/Cabin Air/Heat -- CLOSED.
- (4) Fire Extinguisher -- ACTIVATE (if available).

If fire appears out and electrical power is necessary for continuance of flight:

- (5) Master Switch -- ON.
- (6) Circuit Breakers -- CHECK for faulty circuit, do not reset.
- (7) Radio/Electrical Switches -- ON one at a time, with delay after each until short circuit is localized.
- (8) Vents/Cabin Air/Heat -- OPEN when it is ascertained that fire is completely extinguished.

DISORIENTATION IN CLOUDS.

In the event of a vacuum system failure during flight in marginal weather, the directional gyro and gyro horizon will be disabled, and the pilot will have to rely on the turn coordinator or the turn and bank indicator if he inadvertently flies into clouds. The following instructions assume that only the electrically-powered turn coordinator or the turn and bank indicator is operative, and that the pilot is not completely proficient in partial panel instrument flying.

EXECUTING A 180° TURN IN CLOUDS.

Upon entering the clouds, an immediate plan should be made to turn back as follows:

- (1) Note the time of the minute hand and observe the position of the sweep second hand on the clock.
- (2) When the sweep second hand indicates the nearest half-minute, initiate a standard rate left turn, holding the turn coordinator symbolic aircraft wing opposite the lower left index mark for 60 seconds. Then roll back to level flight by leveling the miniature aircraft.
- (3) Check accuracy of the turn by observing the compass heading which should be the reciprocal of the original heading.
- (4) If necessary, adjust heading primarily with skidding motions rather than rolling motions so that the compass will read more accurately.
- (5) Maintain altitude and airspeed by cautious application of stabilator control. Avoid overcontrolling by keeping the hands off the control wheel and steering only with rudder.

EMERGENCY LET-DOWNS THROUGH CLOUDS.

If possible, obtain radio clearance for an emergency descent through clouds. To guard against a spiral dive, choose an easterly or westerly heading to minimize compass card swings due to changing bank angles. In addition, keep hands off the control wheel and steer a straight course with rudder control by monitoring the turn coordinator. Occasionally check the compass heading and make minor corrections to hold an approximate course. Before descending into the clouds, set up a stabilized let-down condition as follows:

- (1) Extend landing gear.
- (2) Reduce power to set up a 500 to 800 ft./min. rate of descent.
- (3) Apply full rich mixture.
- (4) Adjust the stabilator and rudder trim control wheels for a stabilized descent at 90 MPH.
- (5) Keep hands off the control wheel.
- (6) Monitor turn coordinator and make corrections by rudder alone.
- (7) Adjust rudder trim to relieve unbalanced rudder force, if present.
- (8) Check trend of compass card movement and make cautious corrections with rudder to stop the turn.
- (9) Upon breaking out of clouds resume normal cruising flight.

RECOVERY FROM A SPIRAL DIVE.

If a spiral is encountered, proceed as follows:

- (1) Close the throttle.
- (2) Stop the turn by using coordinated aileron and rudder control to align the symbolic aircraft in the turn coordinator with the horizon reference line.
- (3) Cautiously apply stabilator back pressure to slowly reduce the indicated airspeed to 90 MPH.
- (4) Adjust the stabilator trim control to maintain a 90 MPH glide.
- (5) Keep hands off the control wheel, using rudder control to hold a straight heading. Use rudder trim to relieve unbalanced rudder force, if present.
- (6) Clear engine occasionally, but avoid using enough power to disturb the trimmed glide.
- (7) Upon breaking out of clouds, resume normal cruising flight.

SPINS.

Intentional spins are prohibited in this airplane. Should an inadvertent spin occur, the following recovery technique may be used.

- (1) Retard throttle to idle position.
- (2) Apply full rudder opposite to the direction of rotation.
- (3) After one-fourth turn, move the control wheel forward of neutral in a brisk motion.
- (4) As rotation stops, neutralize rudder, and make a smooth recovery from the resulting dive.

FLIGHT IN ICING CONDITIONS.

Although flying in known icing conditions is prohibited, an unexpected icing encounter should be handled as follows:

- (1) Turn pitot heat switch ON (if installed).
- (2) Turn back or change altitude to obtain an outside air temperature that is less conducive to icing.
- (3) Pull left cabin air, heater and defroster control knobs full out to obtain windshield defroster airflow.

- (4) Increase RPM to minimize ice build-up on propeller blades.
- (5) Plan a landing at the nearest airport. With an extremely rapid ice build-up, select a suitable "off airport" landing site.
- (6) With an ice accumulation of one-quarter inch or more on the wing leading edges, be prepared for significantly higher stall speed.
- (7) Extend wing flaps 10° with ice accumulations of one inch or less. With heavier ice accumulations, approach with flaps retracted to ensure adequate stabilator effectiveness in the approach and landing.
- (8) Perform a landing approach using a forward slip, if necessary, for improved visibility.
- (9) Approach at 85 to 95 MPH, depending upon the amount of ice accumulation.
- (10) Perform a landing in level attitude.

ROUGH ENGINE OPERATION OR LOSS OF POWER.

SPARK PLUG FOULING.

A slight engine roughness in flight may be caused by one or more spark plugs becoming fouled by carbon or lead deposits. This may be verified by turning the ignition switch momentarily from BOTH to either L or R position. An obvious power loss in single ignition operation is evidence of spark plug or magneto trouble. Assuming that spark plugs are the more likely cause, lean the mixture to the normal lean setting for cruising flight. If the problem does not clear up in several minutes, determine if a richer mixture setting will produce smoother operation. If not, proceed to the nearest airport for repairs using the BOTH position of the ignition switch unless extreme roughness dictates the use of a single ignition position.

MAGNETO MALFUNCTION.

A sudden engine roughness or misfiring is usually evidence of magneto problems. Switching from BOTH to either L or R ignition switch position will identify which magneto is malfunctioning. Select different power settings and enrichen the mixture to determine if continued operation on BOTH magnetos is practicable. If not, switch to the good magneto and proceed to the nearest airport for repairs.

LOW OIL PRESSURE.

If low oil pressure is accompanied by normal oil temperature, there

is a possibility that the oil pressure gage or relief valve is malfunctioning, or a leak has developed in the oil line from the engine to the oil pressure gage transducer on the firewall. A leak in this line is not necessarily cause for an immediate precautionary landing because an orifice in the line will prevent a sudden loss of oil from the engine sump. Low electrical system voltage will also cause low oil pressure gage readings. This can be verified by checking the condition of the electrical system and the indications of the other gages in the engine instrument cluster. As electrical system voltage to the instrument cluster drops, all gage readings will drop proportionally. In the event of a suspected mechanical or electrical malfunction, land as soon as practical to properly identify and correct the problem.

If a total loss of oil pressure is accompanied by a rise in oil temperature, there is good reason to suspect an engine failure is imminent. Reduce engine power immediately and select a suitable forced landing field. Leave the engine running at low power during the approach, using only the minimum power required to reach the desired touchdown spot.

LANDING GEAR MALFUNCTION PROCEDURES.

In the event of possible landing gear retraction or extension malfunctions, there are several general checks that should be made prior to initiating the steps outlined in the following paragraphs.

In analyzing a landing gear malfunction, first check that the master switch is ON and the LDG GEAR and GEAR IND circuit breakers are in; reset if necessary. Also, check both landing gear position indicator lights for operation by "pressing-to-test" the light units and rotating them at the same time to check for open dimming shutters. A burned-out bulb can be replaced in flight by using the bulb from the remaining gear position indicator light.

RETRACTION MALFUNCTIONS.

If the landing gear fails to retract normally, or an intermittent gear UP indicator light is present, check the gear UP indicator light for proper operation and attempt to recycle the landing gear. Place the landing gear lever in the DWN position. Reposition the gear lever in the UP position for another retraction attempt. If the gear UP indicator light still fails to illuminate, an immediate landing is not necessary. The flight may continue to an airport having maintenance facilities if, after the gear has been

apparently retracted, cruise speed appears normal with no abnormal buffeting, and the landing gear motor is not running. However, if the gear motor does not shut off after retraction, or the gear UP light continues to operate intermittently, the landing gear should be extended until maintenance can be obtained.

NOTE

Test for landing gear motor operation as follows: At a safe altitude, cycle landing gear at 75 MPH with low power and listen for the motor to shut off following the normal sound of gear retraction (approximately 12 seconds). Intermittent gear motor operation may also be detected by momentary fluctuations of the ammeter needle.

EXTENSION MALFUNCTIONS.

Normal landing gear extension time is approximately 14 seconds. If the landing gear will not extend normally, perform the general checks of circuit breakers and master switch and repeat the normal extension procedures at a reduced airspeed of 80 MPH. If efforts to extend and lock the gear through the normal landing gear system fail, the gear can be manually extended (as long as hydraulic system fluid has not been completely lost) by use of the emergency hand pump. The hand pump is located under a hinged cover between the front seats.

MANUAL LANDING GEAR EXTENSION.

The following procedures are necessary for manual landing gear extension:

- (1) Pull out 30 amp LDG GEAR circuit breaker.
- (2) Place landing gear lever in DWN position.
- (3) Lift cover and extend pump handle.
- (4) Pump approximately 40 pressure strokes.
- (5) Stop when resistance becomes heavy.
- (6) Verify gear is down by observing green DWN light on.
- (7) With green DWN light on, stow pump handle.

NOTE

If manual gear extension was for practice and normal retraction is desired, push the LDG GEAR circuit breaker in.

LANDING WITHOUT POSITIVE INDICATION OF GEAR LOCKING.

After performing the checks listed under Extension Malfunctions and observation indicates the gear is down and apparently locked, proceed as follows:

- (1) Perform the Before Landing check.
- (2) Make a normal full flap approach.
- (3) Maintain landing gear down pressure with the manual hand pump.
- (4) Land tail-low as smoothly as possible and minimize braking in the landing roll.
- (5) Taxi slowly to a maintenance area.
- (6) Perform a normal engine shut down prior to inspection of the landing gear.

LANDING WITH DEFECTIVE NOSE GEAR.

If the nose gear does not extend, or only partially extends, and observers verify that it is not down, prepare for a wheels down landing as follows:

- (1) Transfer movable load to baggage area, and passenger to rear seat.
- (2) Perform the Before Landing check.
- (3) Select a hard-surfaced or smooth sod runway.

NOTE

If terrain is rough or soft, plan a wheels-up landing as presented under Forced Landing (Precautionary Landing With Power) in lieu of the following steps.

- (4) Maintain gear down pressure with manual hand pump (gear lever DWN).
- (5) Extend flaps to 30°.
- (6) Turn off master switch.
- (7) Unlatch cabin door.
- (8) Land in a slightly tail-low attitude.
- (9) Pull mixture control knob to idle cut-off (full out.)
- (10) Turn ignition switch OFF.
- (11) Turn fuel selector valve handle to OFF.
- (12) Hold the nose off the ground as long as possible.
- (13) Evacuate the aircraft as soon as it stops.

LANDING WITH PARTIALLY EXTENDED MAIN GEAR.

If the main gears are only partially extended, and all efforts to fully extend them (including manual extension) have failed, plan a wheels-up landing as presented under Forced Landing (Precautionary Landing With Engine Power). In preparation for landing, reposition the landing gear lever to UP and push the LDG GEAR circuit breaker in to allow the landing gear to swing into the gear wells at touchdown.

ELECTRICAL POWER SUPPLY SYSTEM MALFUNCTIONS.

Malfunctions in the electrical power supply system can be detected by periodic monitoring of the ammeter and over-voltage warning light; however, the cause of these malfunctions is usually difficult to determine. A broken alternator drive belt or wiring is most likely the cause of alternator failures, although other factors could cause the problem. A damaged or improperly adjusted voltage regulator can also cause malfunctions. Problems of this nature constitute an electrical emergency and should be dealt with immediately. Electrical power malfunctions usually fall into two categories: excessive rate of charge and insufficient rate of charge. The following paragraphs describe the recommended remedy for each situation.

EXCESSIVE RATE OF CHARGE.

After engine starting and heavy electrical usage at low engine speeds (such as extended taxiing) the battery condition will be low enough to accept above normal charging during the initial part of a flight. However, after thirty minutes of cruising flight, the ammeter should be indicating less than two needle widths of charging current. If the charging rate were to remain above this value on a long flight, the battery would overheat and evaporate the electrolyte at an excessive rate. Electronic components in the electrical system could be adversely affected by higher than normal voltage if a faulty voltage regulator setting is causing the overcharging. To preclude these possibilities, an over-voltage sensor will automatically shut down the alternator and the over-voltage warning light will illuminate if the charge voltage reaches approximately 16 volts. Assuming that the malfunction was only momentary, an attempt should be made to reactivate the alternator system. To do this, turn both sides of the master switch off and then on again. If the problem no longer exists, normal alternator charging will resume and the warning light will go off. If the light comes on again, a malfunction is confirmed. In this event, the flight should be

terminated and/or the current drain on the battery minimized because the battery can supply the electrical system for only a limited period of time. If the emergency occurs at night, power must be conserved for later operation of the landing gear and wing flaps and possible use of the landing lights during landing.

INSUFFICIENT RATE OF CHARGE.

If the ammeter indicates a continuous discharge rate in flight, the alternator is not supplying power to the system and should be shut down since the alternator field circuit may be placing an unnecessary load on the system. All non-essential equipment should be turned off and the flight terminated as soon as practical.

*SEE ACK TECHNOLOGIES MODEL E-01
OPERATION MANUAL
EMERGENCY LOCATOR TRANSMITTER (ELT).
IN AIRCRAFT FORMS BINDER*

The ELT consists of a self-contained dual-frequency radio transmitter and battery power supply, and is activated by an impact of 5g or more as may be experienced in a crash landing. The ELT emits an omni-directional signal on the international distress frequencies of 121.5 and 243.0 MHz. General aviation and commercial aircraft, the FAA, and CAP monitor 121.5 MHz, and 243.0 MHz is monitored by the military. Following a crash landing, the ELT will provide line-of-sight transmission up to 100 miles at 10,000 feet. The duration of ELT transmissions is affected by ambient temperature. At temperatures of +70° to +130°F, continuous transmission for 115 hours can be expected; a temperature of -40°F will shorten the duration to 70 hours.

The ELT is readily identified as a bright orange unit mounted behind the baggage compartment wall on the right side of the fuselage. To gain access to the unit, grasp the edge of the baggage wall and pull. The ELT is operated by a control panel at the forward facing end of the unit (see figure 3-1).

ELT OPERATION.

- (1) **NORMAL OPERATION:** As long as the function selector switch remains in the ARM position, the ELT automatically activates following an impact of 5 g or more over a short period of time.
- (2) **ELT FAILURE:** If "g" switch actuation is questioned following a minor crash landing, gain access to the ELT and place the function selector switch in the ON position.

SEE ACK TECHNOLOGIES
OPERATION MANUAL MODEL E-01

IN AIRCRAFT FORMS BINDER

ELT
CONTROL
PANEL

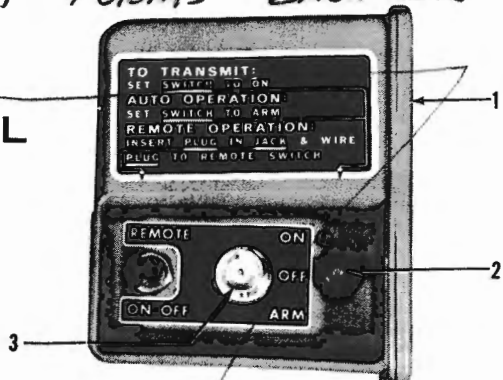

1. COVER - Removable for access to battery.
2. FUNCTION SELECTOR SWITCH (3-position toggle switch):
 - ON - Activates transmitter instantly. Used for test purposes and if "g" switch is inoperative.
 - OFF - Deactivates transmitter. Used during shipping, storage and following rescue.
 - ARM - Activates transmitter only when "g" switch receives 5g or more impact.
3. ANTENNA RECEPTACLE - Connection to antenna mounted on top of the tailcone.

Figure 3-1.

- (3) PRIOR TO SIGHTING RESCUE AIRCRAFT: Conserve aircraft battery. Do not activate radio transceiver.
- (4) AFTER SIGHTING RESCUE AIRCRAFT: Place ELT function selector switch in the OFF position, preventing radio interference. Attempt contact with rescue aircraft with the radio transceiver set to a frequency of 121.5 MHz. If no contact is established, return the function selector switch to ON immediately.

(5) **FOLLOWING RESCUE:** Place ELT function selector switch in the OFF position, terminating emergency transmissions.

(6) **INADVERTENT ACTIVATION:** Following a lightning strike or an exceptionally hard landing, the ELT may activate although no emergency exists. Select 121.5 MHz on your radio transceiver. If the ELT can be heard transmitting, place the function selector switch in the OFF position; then immediately return the switch to ARM.

Section IV

OPERATING LIMITATIONS

OPERATIONS AUTHORIZED.

Your Cessna exceeds the requirements for airworthiness as set forth by the United States Government, and is certificated under FAA Type Certificate No. A20CE as Cessna Model No. 177RG.

The aircraft may be equipped for day, night, VFR, or IFR operation. Your Cessna Dealer will be happy to assist you in selecting equipment best suited to your needs.

Your aircraft must be operated in accordance with all FAA-approved markings and placards in the aircraft. If there is any information in this section which contradicts the FAA-approved markings and placards, it is to be disregarded.

MANEUVERS-NORMAL CATEGORY.

This aircraft is certificated in the normal category. The normal category is applicable to aircraft intended for non-aerobatic operations. These include any maneuvers incidental to normal flying, stalls (except whip stalls) and turns in which the angle of bank is not more than 60°. In connection with the foregoing, the following gross weight and flight load factors apply:

Gross Weight	2800 lbs
Flight Load Factor	
*Flaps Up	+3.8 -1.52
*Flaps Down	+2.0

*The design load factors are 150% of the above, and in all cases, the structure meets or exceeds design loads.

AIRSPEED LIMITATIONS (CAS).

The following is a list of the certificated calibrated airspeed (CAS) limitations for the aircraft.

Never Exceed Speed (glide or dive, smooth air)	195 MPH
Maximum Structural Cruising Speed	160 MPH
Maximum Speed, Gear Extended	140 MPH
Maximum Speed, Flaps Extended	
Flaps 10°	150 MPH
Flaps 10° to 30°	110 MPH
*Maneuvering Speed	130 MPH

*The maximum speed at which you may use abrupt control travel.

AIRSPEED INDICATOR MARKINGS.

The following is a list of the certificated calibrated airspeed markings (CAS) for the aircraft.

Never Exceed (glide or dive, smooth air).	195 MPH (red line)
Caution Range	160-195 MPH (yellow arc)
Normal Operating Range	70-160 MPH (green arc)
Flap Operating Range (10° to 30°)	60-110 MPH (white arc)

ENGINE OPERATION LIMITATIONS.

Power and Speed	200 BHP at 2700 RPM
---------------------------	---------------------

ENGINE INSTRUMENT MARKINGS.

OIL TEMPERATURE GAGE.

Normal Operating Range	Green Arc
Maximum Allowable	245° F (red line)

CYLINDER HEAD TEMPERATURE GAGE.

Normal Operating Range	200° to 475° F (green arc)
Maximum Allowable	475° F (red line)

OIL PRESSURE GAGE.

Minimum Idling 25 psi (red line)
Normal Operating Range 60-90 psi (green arc)
Maximum 100 psi (red line)

FUEL FLOW INDICATOR.

Normal Operating Range 6.0-13.0 gal/hr (green arc)
Maximum 10.0 psi (19.0 gal/hr) (red line)

NOTE

A placard, located on the pedestal below the engine controls, defines maximum power take-off/climb mixture settings as follows:

MAXIMUM POWER MIXTURE

ALTITUDE	S. L.	4000	8000	12,000
GAL/HR	17	15	13	10

[AVOID CONTINUOUS OPERATION BETWEEN 1400 AND 1750 RPM WITH LESS THAN 10" MANIFOLD PRESSURE.]

FUEL QUANTITY INDICATORS.

Empty (0.5 gallons unusable each tank) E (red line)

TACHOMETER.

Normal Operating Range 2100-2500 RPM (green arc)
Caution Range 1400-1750 RPM (yellow arc)
Maximum Allowable 2700 RPM (red line)

See
STC SA 477CH

MANIFOLD PRESSURE GAGE.

Normal Operating Range 15 to 25 in. Hg. (green arc)

WEIGHT AND BALANCE.

The following information will enable you to operate your Cessna within the prescribed weight and center of gravity limitations. To figure weight and balance, use the Sample Problem, Loading Graph, and Center

of Gravity Moment Envelope as follows:

Take the licensed empty weight and moment from appropriate weight and balance records carried in your airplane, and write them down in the column titled YOUR AIRPLANE on the Sample Loading Problem.

NOTE

The licensed empty weight and moment are recorded on the Weight and Balance and Installed Equipment Data sheet, or on revised weight and balance records, and are included in the aircraft file. In addition to the licensed empty weight and moment noted on these records, the c. g. arm (fuselage station) is also shown, but need not be used on the Sample Loading Problem. The moment which is shown must be divided by 1000 and this value used as the moment/1000 on the loading problem.

Use the Loading Graph to determine the moment/1000 for each additional item to be carried; then list these on the loading problem.

NOTE

Loading Graph information for the pilot, passengers, baggage and hatshelf is based on seats positioned for average occupants and baggage or hatshelf items loaded in the center of these areas as shown on the Loading Arrangements diagram. For loadings which may differ from these, the Sample Loading Problem lists fuselage stations for these items to indicate their forward and aft c. g. range limitation (seat travel and baggage or hatshelf area limitation). Additional moment calculations, based on the actual weight and c. g. arm (fuselage station) of the item being loaded, must be made if the position of the load is different from that shown on the Loading Graph. Reduced fuel weights may be measured for use with heavy cabin loadings by filling both tanks to the 22 gallon marker for 43 gallons (258 pounds) usable, or filling one tank completely with the other tank at 22 gallons for 51.5 gallons (309 pounds) usable. Both tanks may be filled for maximum range, provided gross weight is not exceeded.

Total the weights and moments/1000 and plot these values on the Center of Gravity Moment Envelope to determine whether the point falls within the envelope, and if the loading is acceptable.

LOADING ARRANGEMENTS

* Pilot or passenger center of gravity on adjustable seats positioned for average occupant. Numbers in parentheses indicate forward and aft limits of occupants center of gravity range.

** Arm measured to the center of the area shown.

NOTE:

The aft baggage wall (approximate station 188) can be used as a convenient interior reference point for determining the location of baggage area fuselage stations.

STATION (C.G. ARM)

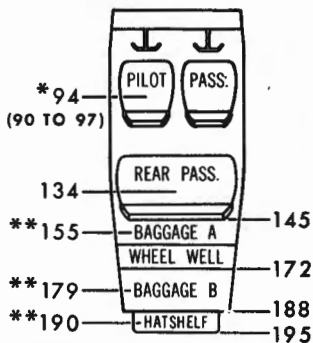

SAMPLE LOADING PROBLEM

1. Licensed Empty Weight (Use the data pertaining to your airplane as it is presently equipped. Includes unusable fuel)
2. Oil (9 Qts. - The weight of full oil may be used for all calculations. 9 Qts. = 17 Lbs. at 0.8 Moment/1000)
3. Usable Fuel (At 6 Lbs./Gal.)
 Standard Tanks (60 Gal. Maximum)
 Reduced Fuel (43 Gal.)
4. Pilot and Front Passenger (Station 90 to 97)
5. Rear Passengers
6. Baggage-Area "A" (on and forward of wheel well) - Sta. 145 to 172
7. Baggage-Area "B" (aft of wheel well) and Hatchet - Sta. 172 to 195
8. TOTAL WEIGHT AND MOMENT

	SAMPLE AIRPLANE		YOUR AIRPLANE	
	Weight (lbs.)	Moment (lb. - ins. /1000)	Weight (lbs.)	Moment (lb. - ins. /1000)
1757	183.7			
17	0.8	17	0.8	
258	28.7			
340	32.0			
340	45.6			
88	15.8			
2800	306.6			

9. Locate this point (2800 at 306.6) on the Center of Gravity Moment Envelope, and since this point falls within the envelope, the loading is acceptable.

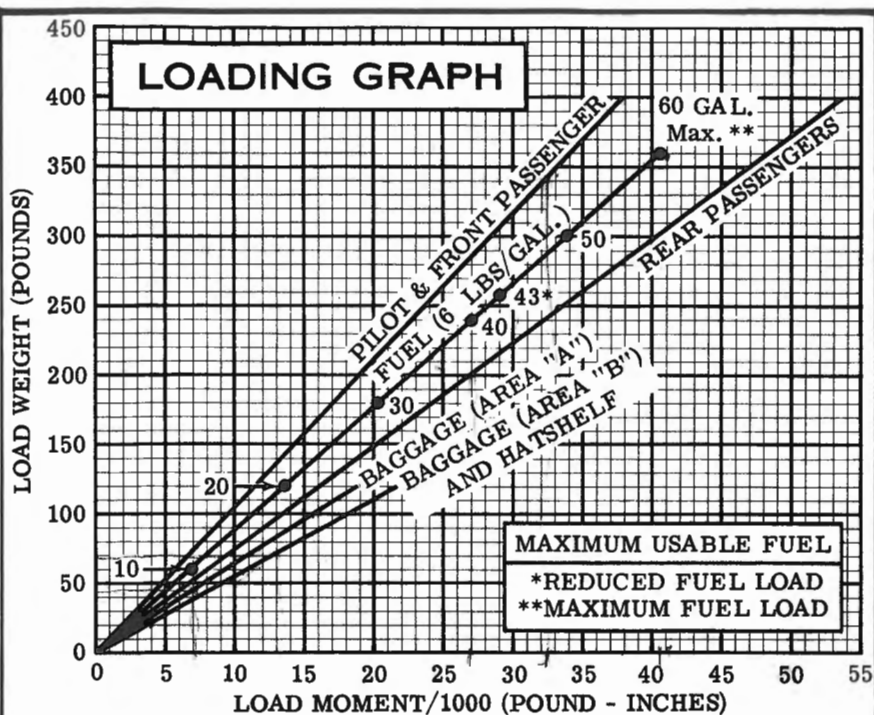

NOTES

- (1) Line representing adjustable seats shows the pilot and front passenger center of gravity on adjustable seats positioned for an average occupant. Refer to the Loading Arrangements diagram for forward and aft limits of occupant c.g. range.
- (2) Engine Oil: 9 Qts. = 17 Lbs. at 0.8 Moment/1000.
- (3) BAGGAGE (area "A") is located on and forward of the wheel well. BAGGAGE (area "B") is aft of the wheel well. Maximum baggage load, including the hatshelf, is 120 Lbs. This load may be distributed as desired between baggage areas, provided 12 Lbs. is not exceeded on the hatshelf.

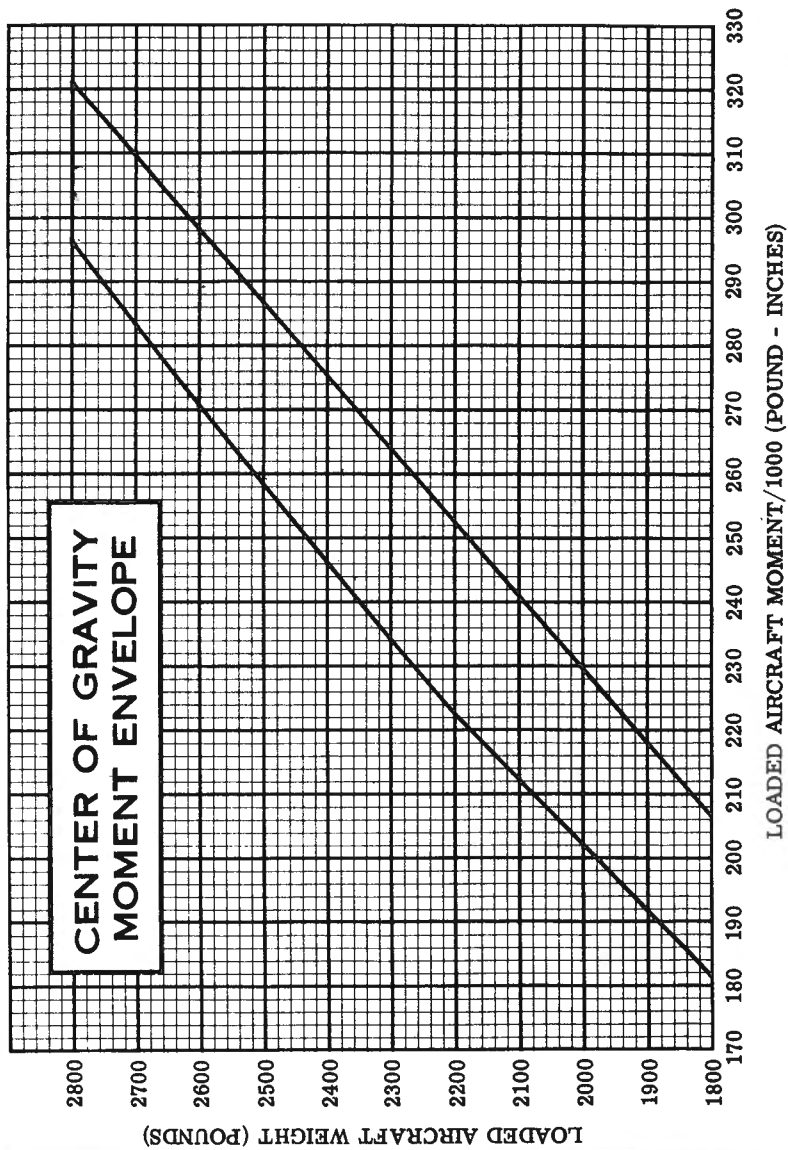

Section V

CARE OF THE AIRPLANE

If your aircraft is to retain that new plane performance and dependability, certain inspection and maintenance requirements must be followed. It is wise to follow a planned schedule of lubrication and preventive maintenance based on climatic and flying conditions encountered in your locality.

Keep in touch with your Cessna Dealer and take advantage of his knowledge and experience. He knows your aircraft and how to maintain it. He will remind you when lubrications and oil changes are necessary, and about other seasonal and periodic services.

GROUND HANDLING.

The aircraft is most easily and safely maneuvered by hand with the tow-bar attached to the nose wheel. When towing with a vehicle, do not exceed the nose gear turning angle of 39° either side of center, or damage to the gear will result. If the aircraft is towed or pushed over a rough surface during hangaring, watch that the normal cushioning action of the nose strut does not cause excessive vertical movement of the tail and the resulting contact with low hangar doors or structure. A flat nose tire or deflated strut will also increase tail height.

MOORING YOUR AIRPLANE.

Proper tie-down procedure is your best precaution against damage to your parked aircraft by gusty or strong winds. To tie-down your aircraft securely, proceed as follows:

- (1) Set the parking brake and install the control wheel lock.
- (2) Install a surface control lock over the fin and rudder.
- (3) Tie sufficiently strong ropes or chains (700 pounds tensile

strength) to the wing and tail tie-down fittings and secure each rope to a ramp tie-down.

(4) Tie a rope (no chains or cables) to the nose gear strut and secure to a ramp tie-down.

(5) Install a pitot tube cover.

WINDSHIELD-WINDOWS.

The plastic windshield and windows should be cleaned with an aircraft windshield cleaner. Apply the cleaner sparingly with soft cloths, and rub with moderate pressure until all dirt, oil scum and bug stains are removed. Allow the cleaner to dry, then wipe it off with soft flannel cloths.

If a windshield cleaner is not available, the plastic can be cleaned with soft cloths moistened with Stoddard solvent to remove oil and grease.

NOTE

Never use gasoline, benzine, alcohol, acetone, carbon tetrachloride, fire extinguisher or anti-ice fluid, lacquer thinner or glass cleaner to clean the plastic. These materials will attack the plastic and may cause it to craze.

Follow by carefully washing with a mild detergent and plenty of water. Rinse thoroughly, then dry with a clean moist chamois. Do not rub the plastic with a dry cloth since this builds up an electrostatic charge which attracts dust. Waxing with a good commercial wax will finish the cleaning job. A thin, even coat of wax, polished out by hand with clean soft flannel cloths, will fill in minor scratches and help prevent further scratching.

Do not use a canvas cover on the windshield unless freezing rain or sleet is anticipated since the cover may scratch the plastic surface.

PAINTED SURFACES.

The painted exterior surfaces of your new Cessna have a durable, long lasting finish and, under normal conditions, require no polishing or buffing. Approximately 15 days are required for the paint to cure completely; in most cases, the curing period will have been completed prior to delivery of the aircraft. In the event that polishing or buffing is required within the curing period, it is recommended that the work be done

by someone experienced in handling uncured paint. Any Cessna Dealer can accomplish this work.

Generally, the painted surfaces can be kept bright by washing with water and mild soap, followed by a rinse with water and drying with cloths or a chamois. Harsh or abrasive soaps or detergents which cause corrosion or scratches should never be used. Remove stubborn oil and grease with a cloth moistened with Stoddard solvent.

Waxing is unnecessary to keep the painted surfaces bright. However, if desired, the aircraft may be waxed with a good automotive wax. A heavier coating of wax on the leading edges of the wings and tail and on the engine nose cap and propeller spinner will help reduce the abrasion encountered in these areas.

When the aircraft is parked outside in cold climates and it is necessary to remove ice before flight, care should be taken to protect the painted surfaces during ice removal with chemical liquids. A 50-50 solution of isopropyl alcohol and water will satisfactorily remove ice accumulations without damaging the paint. A solution with more than 50% alcohol is harmful and should be avoided. While applying the de-icing solution, keep it away from the windshield and cabin windows since the alcohol will attack the plastic and may cause it to craze.

PROPELLER CARE.

Preflight inspection of propeller blades for nicks, and wiping them occasionally with an oily cloth to clean off grass and bug stains will assure long, trouble-free service. Small nicks on the propeller, particularly near the tips and on the leading edges, should be dressed out as soon as possible since these nicks produce stress concentrations, and if ignored, may result in cracks. Never use an alkaline cleaner on the blades; remove grease and dirt with carbon tetrachloride or Stoddard solvent.

LANDING GEAR CARE.

Cessna Dealer's mechanics have been trained in the proper adjustment and rigging procedures on the aircraft hydraulic system. To assure trouble-free gear operation, have your Cessna Dealer check the gear regularly and make any necessary adjustments. Only properly trained mechanics should attempt to repair or adjust the landing gear.

INTERIOR CARE.

To remove dust and loose dirt from the upholstery and carpet, clean the interior regularly with a vacuum cleaner.

Blot up any spilled liquid promptly with cleansing tissue or rags. Don't pat the spot; press the blotting material firmly and hold it for several seconds. Continue blotting until no more liquid is taken up. Scrape off sticky materials with a dull knife, then spot-clean the area.

Oily spots may be cleaned with household spot removers, used sparingly. Before using any solvent, read the instructions on the container and test it on an obscure place on the fabric to be cleaned. Never saturate the fabric with a volatile solvent; it may damage the padding and backing materials.

Soiled upholstery and carpet may be cleaned with foam-type detergent, used according to the manufacturer's instructions. To minimize wetting the fabric, keep the foam as dry as possible and remove it with a vacuum cleaner.

If your aircraft is equipped with leather seating, cleaning of the seats is accomplished using a soft cloth or sponge dipped in mild soap suds. The soap suds, used sparingly, will remove traces of dirt and grease. The soap should be removed with a clean damp cloth.

The plastic trim, headliner, instrument panel and control knobs need only be wiped off with a damp cloth. Oil and grease on the control wheel and control knobs can be removed with a cloth moistened with Stoddard solvent. Volatile solvents, such as mentioned in paragraphs on care of the windshield, must never be used since they soften and craze the plastic.

MAA PLATE/FINISH AND TRIM PLATE.

Information concerning the Type Certificate Number (TC), Production Certificate Number (PC), Model Number and Serial Number of your particular aircraft can be found on the MAA (Manufacturers Aircraft Association) plate located on the upper part of the left forward doorpost.

A Finish and Trim plate contains a code describing the interior color scheme and exterior paint combination of the aircraft. The code may be used in conjunction with an applicable Parts Catalog if finish and trim in-

formation is needed. This plate is located adjacent to the MAA plate on the left forward doorpost.

AIRCRAFT FILE.

There are miscellaneous data, information and licenses that are a part of the aircraft file. The following is a checklist for that file. In addition, a periodic check should be made of the latest Federal Aviation Regulations to ensure that all data requirements are met.

A. To be displayed in the aircraft at all times:

- (1) Aircraft Airworthiness Certificate (FAA Form 8100-2).
- (2) Aircraft Registration Certificate (FAA Form 8050-3).
- (3) Aircraft Radio Station License, if transmitter installed (FCC Form 556).

B. To be carried in the aircraft at all times:

- (1) Weight and Balance, and associated papers (latest copy of the Repair and Alteration Form, FAA Form 337, if applicable).
- (2) Aircraft Equipment List.

C. To be made available upon request:

- (1) Aircraft Log Book.
- (2) Engine Log Book.

Most of the items listed are required by the United States Federal Aviation Regulations. Since the Regulations of other nations may require other documents and data, owners of exported aircraft should check with their own aviation officials to determine their individual requirements.

Cessna recommends that these items, plus the Owner's Manual, Power Computer, Pilot's Checklist, Customer Care Program book and Customer Care Card, be carried in the aircraft at all times.

FLYABLE STORAGE.

Aircraft placed in non-operational storage for a maximum of 30 days or those which receive only intermittent operational use for the first 25 hours are considered in flyable storage status. Every seventh day during

these periods, the propeller should be rotated by hand through five revolutions. This action "limbers" the oil and prevents any accumulation of corrosion on engine cylinder walls.

IMPORTANT

For maximum safety, check that the ignition switch is OFF, the throttle is closed, the mixture control is in the idle cut-off position, and the airplane is secured before rotating the propeller by hand. Do not stand within the arc of the propeller blades while turning the propeller.

After 30 days, the aircraft should be flown for 30 minutes or a ground runup should be made just long enough to produce an oil temperature within the lower green arc range. Excessive ground runup should be avoided.

Engine runup also helps to eliminate excessive accumulations of water in the fuel system and other air spaces in the engine. Keep fuel tanks full to minimize condensation in the tanks. Keep the battery fully charged to prevent the electrolyte from freezing in cold weather. If the aircraft is to be stored temporarily, or indefinitely, refer to the Service Manual for proper storage procedures.

INSPECTION REQUIREMENTS.

As required by Federal Aviation Regulations, all civil aircraft of U. S. registry must undergo a complete inspection (annual) each twelve calendar months. In addition to the required ANNUAL inspection, aircraft operated commercially (for hire) must have a complete inspection every 100 hours of operation.

In lieu of the above requirements, an aircraft may be inspected in accordance with a progressive inspection schedule, which allows the work load to be divided into smaller operations that can be accomplished in shorter time periods.

The CESSNA PROGRESSIVE CARE PROGRAM has been developed to provide a modern progressive inspection schedule that satisfies the complete aircraft inspection requirements of both the 100 HOUR and ANNUAL inspections as applicable to Cessna aircraft.

CESSNA PROGRESSIVE CARE.

The Cessna Progressive Care Program has been designed to help you realize maximum utilization of your aircraft at a minimum cost and down-time. Under this program, your aircraft is inspected and maintained in four operations at 50-hour intervals during a 200-hour period. The operations are recycled each 200 hours and are recorded in a specially provided Aircraft Inspection Log as each operation is conducted.

The Cessna Aircraft Company recommends Progressive Care for aircraft that are being flown 200 hours or more per year, and the 100-hour inspection for all other aircraft. The procedures for the Progressive Care Program and the 100-hour inspection have been carefully worked out by the factory and are followed by the Cessna Dealer Organization. The complete familiarity of Cessna Dealers with Cessna equipment and factory-approved procedures provides the highest level of service possible at lower cost to Cessna owners.

CESSNA CUSTOMER CARE PROGRAM.

Specific benefits and provisions of the CESSNA WARRANTY plus other important benefits for you are contained in your CUSTOMER CARE PROGRAM book supplied with your aircraft. You will want to thoroughly review your Customer Care Program book and keep it in your aircraft at all times.

Coupons attached to the Program book entitle you to an initial inspection and either a Progressive Care Operation No. 1 or the first 100-hour inspection within the first 6 months of ownership at no charge to you. If you take delivery from your Dealer, the initial inspection will have been performed before delivery of the aircraft to you. If you pick up your aircraft at the factory, plan to take it to your Dealer reasonably soon after you take delivery, so the initial inspection may be performed allowing the Dealer to make any minor adjustments which may be necessary.

You will also want to return to your Dealer either at 50 hours for your first Progressive Care Operation, or at 100 hours for your first 100-hour inspection depending on which program you choose to establish for your aircraft. While these important inspections will be performed for you by any Cessna Dealer, in most cases you will prefer to have the Dealer from whom you purchased the aircraft accomplish this work.

SERVICING REQUIREMENTS.

For quick and ready reference, quantities, materials, and specifications for frequently used service items (such as fuel, oil, etc.) are shown on the inside back cover of this manual.

In addition to the EXTERIOR INSPECTION covered in Section I, COMPLETE servicing, inspection, and test requirements for your aircraft are detailed in the aircraft Service Manual. The Service Manual outlines all items which require attention at 50, 100, and 200 hour intervals plus those items which require servicing, inspection, and/or testing at special intervals.

Since Cessna Dealers conduct all service, inspection, and test procedures in accordance with applicable Service Manuals, it is recommended that you contact your Dealer concerning these requirements and begin scheduling your aircraft for service at the recommended intervals.

Cessna Progressive Care ensures that these requirements are accomplished at the required intervals to comply with the 100-hour or ANNUAL inspection as previously covered.

Depending on various flight operations, your local Government Aviation Agency may require additional service, inspections, or tests. For these regulatory requirements, owners should check with local aviation officials where the aircraft is being operated.

OWNER FOLLOW-UP SYSTEM.

Your Cessna Dealer has an Owner Follow-Up System to notify you when he receives information that applies to your Cessna. In addition, if you wish, you may choose to receive similar notification, in the form of Service Letters, directly from the Cessna Customer Services Department. A subscription form is supplied in your Customer Care Program book for your use, should you choose to request this service. Your Cessna Dealer will be glad to supply you with details concerning these follow-up programs, and stands ready, through his Service Department, to supply you with fast, efficient, low-cost service.

PUBLICATIONS.

Various publications and flight operation aids are furnished in the aircraft when delivered from the factory. These items are listed below.

- **CUSTOMER CARE PROGRAM BOOK**
- **OWNER'S MANUALS FOR YOUR
AIRCRAFT
AVIONICS AND AUTOPILOT**
- **POWER COMPUTER**
- **SALES AND SERVICE DEALER DIRECTORY**

The following additional publications, plus many other supplies that are applicable to your aircraft, are available from your Cessna Dealer.

- **SERVICE MANUALS AND PARTS CATALOGS FOR YOUR
AIRCRAFT
ENGINE AND ACCESSORIES
AVIONICS AND AUTOPILOT**

Your Cessna Dealer has a current catalog of all Customer Services. Supplies that are available, many of which he keeps on hand. Supplies which are not in stock, he will be happy to order for you.

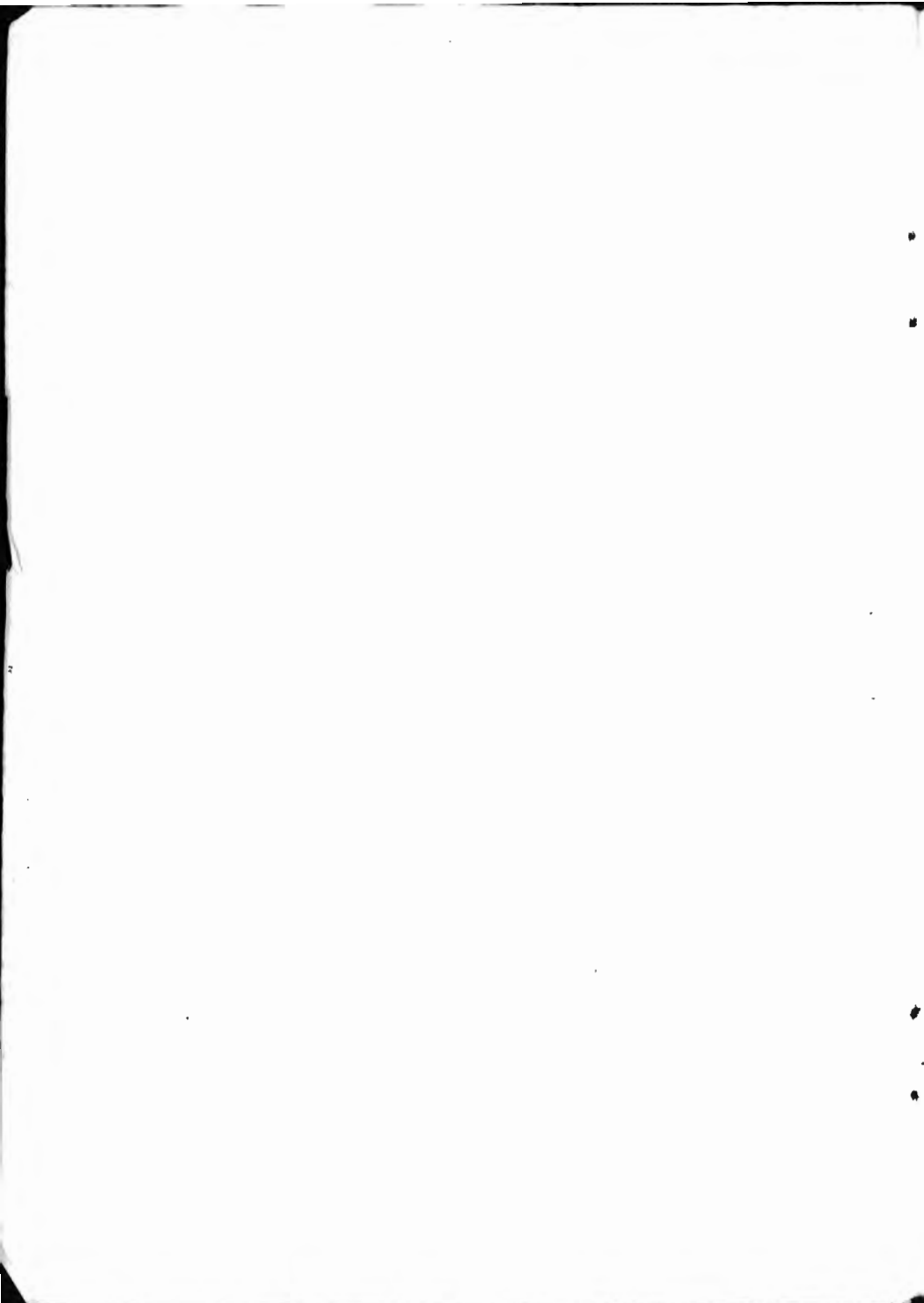

Section VI

OPERATIONAL DATA

The operational data charts on the following pages are presented for two purposes; first, so that you may know what to expect from your aircraft under various conditions, and second, to enable you to plan your flights in detail and with reasonable accuracy.

The data in the charts has been compiled from actual flight tests with the aircraft and engine in good condition and using average piloting techniques. Note also that the range charts make no allowances for wind, navigational errors, warm-up, take-off, climb, etc. You must estimate these variables for yourself and make allowances accordingly. Other indeterminate variables such as mixture leaning techniques, fuel metering characteristics, engine and propeller condition, and air turbulence may account for variations of 10% or more in maximum range. Speeds shown in the Cruise Performance charts reflect performance in the standard configuration. Speeds may be 2 to 3 MPH slower with optional radio antennas installed.

Remember that the charts contained herein are based on standard day conditions. In the case of take-off and climb performance, correction factors are included in the footnotes in these charts to show the effect of temperatures hotter than standard. These factors are based on moderate humidity conditions. Under extremely high humidity conditions, these correction factors may be twice as great as those shown. For more precise power, fuel consumption, and endurance information, consult the Cessna Power Computer supplied with your aircraft. With the Power Computer, you can easily take into account temperature variations from standard at any flight altitude.

AIRSPEED CORRECTION TABLE													
FLAPS UP	IAS-MPH	60	70	80	90	100	110	120	130	140	150	160	170
	CAS-MPH	61	71	81	91	101	111	120	129	138	147	157	166
FLAPS 10°	IAS-MPH	60	70	80	90	100	110	120	130	140	150	---	---
	CAS-MPH	63	73	83	92	101	111	120	129	138	147	---	---
FLAPS 30°	IAS-MPH	50	60	70	80	90	100	110	---	---	---	---	---
	CAS-MPH	57	66	75	83	92	101	110	---	---	---	---	---

Figure 6-1.





STALL SPEEDS - MPH CAS				
GROSS WEIGHT 2800 LBS	ANGLE OF BANK			
				
CONDITION	0°	20°	40°	60°
FLAPS UP	66	68	75	93
FLAPS 10°	61	63	70	86
FLAPS 30°	57	59	65	81
POWER OFF - GEAR UP OR DOWN - AFT CG				

Figure 6-2.

TAKE-OFF DATA

TAKE-OFF DISTANCE FROM HARD SURFACE RUNWAY WITH FLAPS 10°

GROSS WEIGHT POUNDS	AT SEA LEVEL & 59°F			AT 2500 FT. & 50°F			AT 5000 FT. & 41°F			AT 7500 FT. & 32°F		
	IAS MPH	HEAD WIND KNOTS	GROUND RUN	TOTAL TO CLEAR 50 FT OBS	GROUND RUN	TOTAL TO CLEAR 50 FT OBS	GROUND RUN	TOTAL TO CLEAR 50 FT OBS	GROUND RUN	TOTAL TO CLEAR 50 FT OBS	GROUND RUN	TOTAL TO CLEAR 50 FT OBS
2800	70	0 10 20	880 635 420	1585 1215 880	1070 775 520	1885 1460 1080	1305 955 655	2310 1810 1360	1590 1175 825	2900 2295 1755		
2400	65	0 10 20	620 430 270	1180 880 635	745 525 335	1365 1035 745	900 640 425	1615 1240 905	1090 790 530	1935 1500 1110		
2000	60	0 10 20	410 275 160	875 650 450	490 330 200	990 735 515	590 405 255	1135 855 605	710 495 315	1315 995 715		

NOTES: 1. Increase distance 10% for each 20°F above standard temperature for particular altitude.
 2. For operation on a dry, grass runway, increase distances (both "ground run" and "total to clear 50 ft. obstacle") by 8% of the "total to clear 50 ft. obstacle" figure.
 3. Landing gear extended until take-off obstacle is cleared.

MAXIMUM RATE-OF-CLIMB DATA

GROSS WEIGHT POUNDS	AT SEA LEVEL & 59°F			AT 5000 FT. & 41°F			AT 10,000 FT. & 23°F			AT 15,000 FT. & 5°F		
	IAS MPH	RATE OF CLIMB FT/MIN	GAL. OF FUEL USED	IAS MPH	RATE OF CLIMB FT/MIN	FROM S.L. FUEL USED	IAS MPH	RATE OF CLIMB FT/MIN	FROM S.L. FUEL USED	IAS MPH	RATE OF CLIMB FT/MIN	FROM S.L. FUEL USED
2800	95	925	1.5	93	685	3.1	91	440	5.1	89	200	7.7
2400	93	1170	1.5	91	895	2.8	89	620	4.2	87	350	5.9
2000	90	1490	1.5	89	1175	2.5	87	850	3.6	85	540	4.7

NOTES: 1. Full throttle, 2700 RPM, flaps and gear up, and mixture at recommended leaning schedule.
 2. Fuel used includes warm-up and take-off allowance.
 3. For hot weather, decrease rate of climb 30 ft./min. for each 10°F above standard day temperature for particular altitude.

Figure 6-3.

CRUISE PERFORMANCE

EXTENDED RANGE MIXTURE

Standard Conditions \searrow Zero Wind \searrow Gross Weight- 2800 Pounds

2500 FEET

RPM	MP	%BHP	TAS MPH	GAL/ HOUR	60 GAL (NO RESERVE)	
					ENDR. HOURS	RANGE MILES
2500	25	79	167	11.5	5.2	870
	24	75	163	10.8	5.6	910
	23	71	160	10.2	5.9	940
	22	67	156	9.6	6.2	970
2400	25	75	164	10.8	5.5	905
	24	71	160	10.2	5.9	935
	23	67	156	9.7	6.2	965
	22	63	152	9.1	6.6	1000
2300	25	72	160	10.3	5.9	935
	24	68	156	9.7	6.2	965
	23	64	153	9.2	6.5	995
	22	60	149	8.7	6.9	1020
2200	25	67	156	9.7	6.2	970
	24	64	152	9.2	6.5	995
	23	60	149	8.7	6.9	1020
	22	57	145	8.3	7.2	1050
2100	25	64	152	9.2	6.5	995
	24	60	149	8.7	6.9	1020
	23	57	145	8.3	7.2	1050
	22	54	142	7.9	7.6	1080
	21	50	138	7.5	8.0	1105
	20	47	134	7.1	8.4	1130
	19	44	130	6.8	8.9	1150
	18	40	124	6.4	9.3	1155
	17	37	117	6.1	9.8	1145

Figure 6-4 (Sheet 1 of 5).

CRUISE PERFORMANCE

EXTENDED RANGE MIXTURE

Standard Conditions \searrow Zero Wind \swarrow Gross Weight- 2800 Pounds
5000 FEET

RPM	MP	%BHP	TAS MPH	GAL/ HOUR	60 GAL (NO RESERVE)	
					ENDR. HOURS	RANGE MILES
2500	24	78	169	11.2	5.3	905
	23	74	165	10.6	5.7	940
	22	70	161	10.0	6.0	970
	21	65	157	9.4	6.4	1005
2400	25	78	170	11.3	5.3	900
	24	74	166	10.6	5.7	935
	23	70	162	10.0	6.0	970
	22	66	158	9.5	6.3	1000
2300	25	74	166	10.6	5.7	940
	24	70	162	10.0	6.0	970
	23	66	158	9.5	6.3	1000
	22	62	154	9.0	6.7	1030
2200	25	69	161	10.0	6.0	970
	24	66	158	9.5	6.3	1000
	23	62	154	9.0	6.7	1030
	22	59	151	8.6	7.0	1055
2100	25	66	158	9.5	6.3	1000
	24	63	155	9.0	6.6	1025
	23	59	151	8.8	7.0	1055
	22	56	147	8.1	7.4	1085
	21	52	144	7.7	7.8	1115
	20	49	140	7.3	8.2	1140
	19	45	135	6.9	8.6	1165
	18	42	129	6.6	9.1	1175
	17	38	122	6.3	9.5	1165

Figure 6-4 (Sheet 2 of 5).

CRUISE PERFORMANCE

EXTENDED RANGE MIXTURE

Standard Conditions \searrow Zero Wind \searrow Gross Weight- 2800 Pounds

7500 FEET

RPM	MP	%BHP	TAS MPH	GAL/ HOUR	60 GAL (NO RESERVE)	
					ENDR. HOURS	RANGE MILES
2500	22.5	74	169	10.6	5.7	960
	21	68	163	9.7	6.2	1010
	20	64	159	9.2	6.5	1040
	19	59	155	8.6	7.0	1075
2400	22.5	70	166	10.1	5.9	985
	21	64	160	9.2	6.5	1040
	20	60	155	8.7	6.9	1070
	19	56	151	8.2	7.3	1110
2300	22.5	66	162	9.5	6.3	1020
	21	61	156	8.8	6.8	1065
	20	57	152	8.3	7.2	1100
	19	53	148	7.8	7.7	1135
2200	22.5	63	158	9.1	6.6	1050
	21	57	153	8.4	7.2	1095
	20	54	149	7.9	7.6	1125
	19	50	145	7.5	8.0	1155
2100	22.5	59	155	8.6	7.0	1075
	21	54	149	8.0	7.5	1125
	20	51	145	7.5	7.9	1155
	19	47	140	7.2	8.4	1175
	18	44	135	6.8	8.9	1190
	17	40	127	6.4	9.3	1185

Figure 6-4 (Sheet 3 of 5).

CRUISE PERFORMANCE

EXTENDED RANGE MIXTURE

Standard Conditions \searrow Zero Wind \searrow Gross Weight- 2800 Pounds
10,000 FEET

RPM	MP	%BHP	TAS MPH	GAL/ HOUR	60 GAL (NO RESERVE)	
					ENDR. HOURS	RANGE MILES
2500	20	66	165	9.5	6.3	1045
	19	62	161	8.9	6.7	1080
	18	57	156	8.4	7.2	1120
	17	53	151	7.8	7.7	1160
2400	20	62	161	9.0	6.7	1080
	19	58	157	8.4	7.1	1115
	18	54	152	7.9	7.6	1155
	17	50	147	7.4	8.1	1180
2300	20	59	158	8.5	7.0	1110
	19	55	153	8.0	7.5	1145
	18	51	148	7.6	7.9	1175
	17	47	143	7.2	8.4	1200
2200	20	56	155	8.2	7.3	1135
	19	52	150	7.7	7.8	1170
	18	49	145	7.3	8.2	1190
	17	45	139	6.9	8.7	1210
2100	20	52	151	7.7	7.7	1165
	19	49	146	7.4	8.2	1185
	18	45	140	7.0	8.6	1205
	17	42	133	6.6	9.1	1205
	16	38	123	6.3	9.6	1175

Figure 6-4 (Sheet 4 of 5).

CRUISE PERFORMANCE

EXTENDED RANGE MIXTURE

Standard Conditions \searrow Zero Wind \searrow Gross Weight- 2800 Pounds
12,500 FEET

RPM	MP	%BHP	TAS MPH	GAL/ HOUR	60 GAL (NO RESERVE)	
					ENDR. HOURS	RANGE MILES
2500	18	60	162	8.6	6.9	1125
	17	55	157	8.1	7.4	1170
	16	51	151	7.6	7.9	1200
	15	46	143	7.0	8.5	1225
2400	18	56	158	8.2	7.3	1160
	17	52	153	7.7	7.8	1195
	16	47	146	7.2	8.3	1220
	15	43	137	6.7	8.9	1225
2300	18	53	154	7.8	7.7	1190
	17	49	149	7.4	8.2	1210
	16	45	141	6.9	8.7	1225
2200	18	50	151	7.5	8.0	1200
	17	47	145	7.1	8.4	1220
	16	43	136	6.7	9.0	1220
2100	18	47	145	7.2	8.4	1220
	17	43	138	6.8	8.9	1225
	16	40	128	6.4	9.3	1195

Figure 6-4 (Sheet 5 of 5).

LANDING DISTANCE TABLE

LANDING DISTANCE WITH FLAPS 30°, POWER OFF,
AND NO WIND ON HARD SURFACE RUNWAY

GROSS WEIGHT POUNDS	IAS AT 50' MPH	AT SEA LEVEL & 59° F		AT 2500 FT. & 50° F		AT 5000 FT. & 41° F		AT 7500 FT. & 32° F	
		GROUND ROLL	TOTAL TO CLEAR 50 FT. OBS.	GROUND ROLL	TOTAL TO CLEAR 50 FT. OBS.	GROUND ROLL	TOTAL TO CLEAR 50 FT. OBS.	GROUND ROLL	TOTAL TO CLEAR 50 FT. OBS.
2800	70	730	1350	775	1430	820	1515	865	1605

- NOTES:
1. Reduce landing distance 10% for each 4 knots of headwind.
 2. For operation on a dry, grass runway, increase distances (both "ground roll" and "total to clear 50 ft. obstacle") by 20% of the "total to clear 50 ft. obstacle" figure.

Figure 6-5.

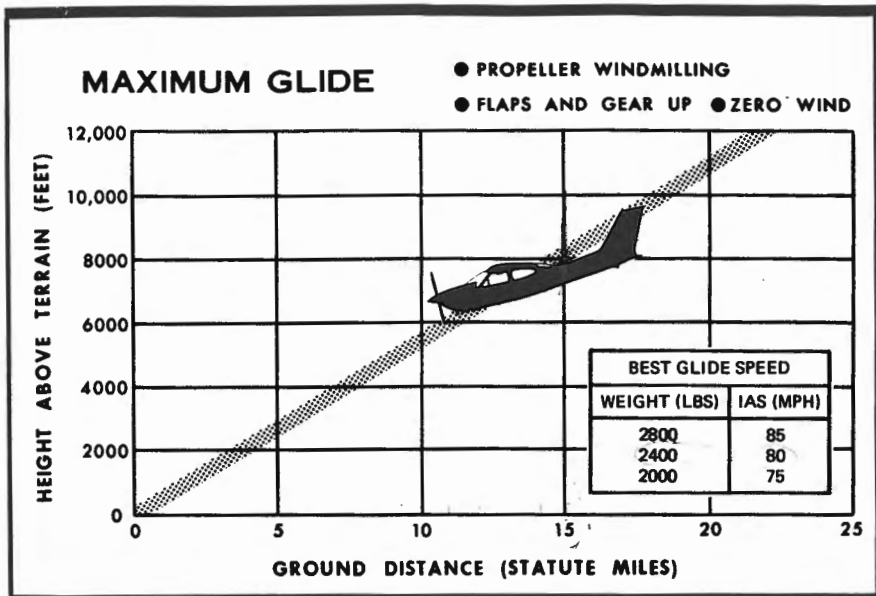

Figure 6-6.

Section VII

OPTIONAL SYSTEMS

This section contains a description, operating procedures, and performance data (when applicable) for some of the optional equipment which may be installed in your Cessna. Owner's Manual Supplements are provided to cover operation of other optional equipment systems when installed in your aircraft. Contact your Cessna Dealer for a complete list of available optional equipment.

COLD WEATHER EQUIPMENT

WINTERIZATION KIT.

For continuous operation in temperatures consistently below 20°F, the Cessna winterization kit should be installed to improve engine operation. The kit consists of two baffles to cover the engine air intakes in the cowling nose cap, a baffle to partially cover the oil cooler inlet scoop, and insulation for the crankcase breather line. Once installed, the crankcase breather insulation is approved for permanent use in both cold and hot weather.

GROUND SERVICE PLUG RECEPTACLE.

A ground service plug receptacle may be installed to permit the use of an external power source for cold weather starting and during lengthy maintenance work on the aircraft electrical system (with the exception of electronic equipment). The receptacle is located under a cover plate, aft of the baggage door on the left side of the tailcone.

NOTE

Electrical power for the aircraft electrical circuits is provided through a split bus bar having all electronic circuits on one side of the bus and other electrical circuits on the other side of the bus. When an

external power source is connected, a contactor automatically opens the circuit to the electronic portion of the split bus bar as a protection against damage to the transistors in the electronic equipment by transient voltages from the power source. Therefore, the external power source can not be used as a source of power when checking electronic components.

Just before connecting an external power source (generator type or battery cart), the master switch should be turned ON.

The ground service plug receptacle circuit incorporates a polarity reversal protection. Power from the external power source will flow only if the ground service plug is correctly connected to the aircraft. If the plug is accidentally connected backwards, no power will flow to the aircraft electrical system, thereby preventing any damage to electrical equipment.

The battery and external power circuits have been designed to completely eliminate the need to "jumper" across the battery contactor to close it for charging a completely "dead" battery. A special fused circuit in the external power system supplies the needed "jumper" across the contacts so that with a "dead" battery and an external power source applied, turning the master switch ON will close the battery contactor.

RADIO SELECTOR SWITCHES

RADIO SELECTOR SWITCH OPERATION.

Operation of the radio equipment is normal as covered in the respective radio manuals. When more than one radio is installed, an audio switching system is necessary. The operation of this switching system is described below.

TRANSMITTER SELECTOR SWITCH.

The transmitter selector switch is labeled TRANS, and has two positions. When two transmitters are installed, it is necessary to switch the microphone to the radio unit the pilot desires to use for transmission. This is accomplished by placing the transmitter selector switch in the position corresponding to the radio unit which is to be used. The up position selects the upper transmitter and the down position selects the lower

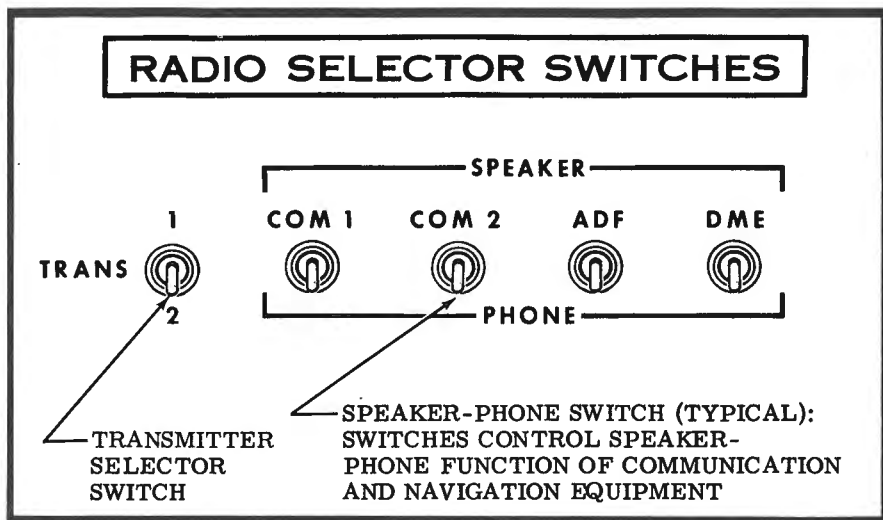

Figure 7-1.

transmitter.

The installation of Cessna radio equipment provides certain audio back-up capabilities and transmitter selector switch functions that the pilot should be familiar with. When the transmitter selector switch is placed in the No. 1 or No. 2 position, the audio amplifier of the corresponding transceiver is utilized to provide the speaker audio for all radios. If the audio amplifier in the selected transceiver fails, as evidenced by loss of speaker audio for all radios, place the transmitter selector switch in the other transceiver position. Since an audio amplifier is not utilized for headphones, a malfunctioning amplifier will not affect headphone operation.

SPEAKER-PHONE SWITCHES.

The speaker-phone switches determine whether the output of the receiver in use is fed to the headphones or through the audio amplifier to the speaker. Place the switch for the desired receiving system either in the up position for speaker operation or in the down position for headphones.

MICROPHONE-HEADSET

A microphone-headset combination is offered as optional equipment. Using the microphone-headset and a microphone keying switch on the left side of the pilot's control wheel, the pilot can conduct radio communications without interrupting other control operations to handle a hand-held microphone. Also, passengers need not listen to all communications. The microphone and headset jacks are located near the lower left corner of the instrument panel.

STATIC DISCHARGERS

If frequent IFR flights are planned, installation of optional wick-type static dischargers is recommended to improve radio communications during flight through dust or various forms of precipitation (rain, freezing rain, snow or ice crystals). Under these conditions, the build-up and discharge of static electricity from the trailing edges of the wings, rudder, stabilator, propeller tips, and radio antennas can result in loss of usable radio signals on all communications and navigation radio equipment. Usually the ADF is first to be affected and VHF communication equipment is the last to be affected.

Installation of static dischargers reduces interference from precipitation static, but it is possible to encounter severe precipitation static conditions which might cause the loss of radio signals, even with static dischargers installed. Whenever possible, avoid known severe precipitation areas to prevent loss of dependable radio signals. If avoidance is impractical, minimize airspeed and anticipate temporary loss of radio signals while in these areas.

CESSNA ECONOMY MIXTURE INDICATOR

The Cessna Economy Mixture Indicator is an exhaust gas temperature (EGT) sensing device which visually aids the pilot in adjusting the cruise mixture. Exhaust gas temperature varies with fuel-to-air ratio, power and RPM. However, the difference between the peak EGT and the EGT at the cruise mixture setting is essentially constant and this provides a useful leaning aid. Operating instructions are included in Section II.

TRUE AIRSPEED INDICATOR

A true airspeed indicator is available to replace the standard airspeed indicator in your aircraft. The true airspeed indicator has a calibrated rotatable ring which works in conjunction with the airspeed indicator dial in a manner similar to the operation of a flight computer.

TO OBTAIN TRUE AIRSPEED, rotate ring until pressure altitude is aligned with outside air temperature in degrees Fahrenheit. Then read true airspeed on rotatable ring opposite airspeed needle.

NOTE

Pressure altitude should not be confused with indicated altitude. To obtain pressure altitude, set barometric scale on altimeter to "29.92" and read pressure altitude on altimeter. Be sure to return altimeter barometric scale to original barometric setting after pressure altitude has been obtained.

OIL QUICK-DRAIN VALVE

An oil quick-drain valve is optionally offered to replace the drain plug in the oil sump drain port. The valve provides a quicker and cleaner method of draining engine oil. To drain the oil with this valve installed, slip a hose over the end of the valve, route the hose to a suitable container, then push upward on the end of the valve until it snaps into the open position. Spring clips will hold the valve open. After draining, use a screwdriver or suitable tool to snap the valve into the extended (closed) position and remove the drain hose.

ALPHABETICAL INDEX

A

- After Landing, 1-7
- Aircraft,
 - before entering, 1-1
 - file, 5-5
 - mooring, 5-1
 - securing, 1-7
- Airspeed Correction Table, 6-2
- Airspeed Indicator, True, 7-5
- Airspeed Indicator Markings, 4-2
- Airspeed Limitations, 4-2
- Alternate Source Valve, Static Pressure, 2-23
- Alternator Check, 2-15
- Ammeter, 2-6
- Authorized Operations, 4-1

B

- Balked Landing, 1-7, 2-22
- Before Landing, 1-7, 2-20
- Before Starting Engine, 1-4
- Before Take-Off, 1-4, 2-15
 - alternator check, 2-15
 - magneto check, 2-15
 - warm-up, 2-15

C

- Cabin Heating, Ventilating And Defrosting System, 2-10
- Capacity,
 - fuel, inside back cover
 - oil, inside back cover
- Care,
 - exterior, 5-2
 - interior, 5-4
 - landing gear, 5-3
 - propeller, 5-3

- Center Of Gravity Moment Envelope, 4-8
- Cessna Customer Care Program, 5-7
- Cessna Progressive Care, 5-7
- Circuit Breakers And Fuses, 2-6
- Climb,
 - enroute, 1-6, 2-17
 - maximum performance, 1-6
 - maximum rate-of-climb data chart, 6-3
 - normal, 1-6
- Cold Weather Equipment, 7-1
 - ground service plug receptacle, 7-1
 - static pressure alternate source valve, 2-23
 - winterization kit, 7-1
- Cold Weather Operation, 2-22
 - starting, 2-22
 - static pressure alternate source valve, 2-23
- Correction Table, Airspeed, 6-2
- Crosswind Landings, 2-21
- Crosswind Take-Offs, 2-17
- Cruise, 1-6, 2-18
 - leaning with EGT, 2-19
- Cruise Performance Chart, 2-18, 6-4, 6-5, 6-6, 6-7, 6-8
- Cylinder Head Temperature Gage, 4-2

D

- Diagram,
 - electrical system, 2-5
 - exterior inspection, 1-2, 1-3
 - fuel system, 2-2

- instrument panel, 1-8
- loading arrangements, 4-5
- maximum glide, 6-10
- principal dimensions, ii
- radio selector switches, 7-3
- taxing, 2-14
- Dimensions, Principal, ii
- Disorientation In Clouds, 3-4
 - emergency let-downs through clouds, 3-5
 - executing 180° turn in clouds, 3-5
 - recovery from spiral dive, 3-6
- Ditching, 3-3

E

- Economy Mixture Indicator, 7-5
 - operating instructions, 2-19
- Electrical Power Supply System Malfunctions, 3-11
 - excessive rate of charge, 3-11
 - insufficient rate of charge, 3-12
- Electrical System, 2-4
 - ammeter, 2-6
 - circuit breakers and fuses, 2-6
 - ground service plug receptacle, 7-1
 - master switch, 2-4
 - over-voltage sensor and warning light, 2-6
 - schematic, 2-5
- Emergency Hand Pump, 2-10
- Emergency Landing Without Engine Power, 3-2
- Emergency Let-Downs Through Clouds, 3-5
- Emergency Locator Transmitter (ELT), 3-12
 - control panel, 3-13
 - ELT operation, 3-12
- Empty Weight, inside front cover

- Engine,
 - before starting, 1-4
 - instrument markings, 4-2
 - oil, inside back cover
 - operation limitations, 4-2
 - starting, 1-4, 2-12
 - warm-up, 2-15
- Engine Failure, 3-1
 - after take-off, 3-1
 - during flight, 3-1
- Enroute Climb, 1-6, 2-17
 - maximum performance, 1-6
 - normal, 1-6
- Equipment, Cold Weather, 7-1
- Excessive Rate Of Electrical Charge, 3-11
- Executing 180° Turn In Clouds, 3-5
- Exterior Care, 5-2
- Exterior Inspection Diagram, 1-2, 1-3
- Exterior Lighting, 2-7

F

- File, Aircraft, 5-5
- Fires, 3-3
 - electrical fire in flight, 3-4
 - engine fire in flight, 3-3
- Flight In Icing Conditions, 3-6
- Flyable Storage, 5-5
- Forced Landing, 3-2
 - ditching, 3-3
 - emergency landing without engine power, 3-2
 - precautionary landing with engine power, 3-2
- Fuel System, 2-1
 - capacity, inside back cover
 - fuel flow indicator, 4-3
 - fuel grade, inside back cover
 - fuel quantity indicators, 4-3

fuel tank sump quick-drain valves, 2-4
quick-drain valve kit, 7-6
schematic, 2-2

Fuses And Circuit Breakers 2-6

G

Graph, Loading, 4-7
Gross Weight, inside front cover
Ground Handling, 5-1
Ground Service Plug Receptacle, 7-1

H

Handling Airplane On Ground, 5-1
Hand Pump, Emergency, 2-10
Harnesses, Shoulder, 2-11
Headset-Microphone, 7-4
Heating, Ventilating And Defrosting System, Cabin, 2-10
Hot Weather Operation, 2-23

I

Indicator, Economy Mixture, 7-5
operating instructions, 2-19
Indicator, Fuel Flow, 4-3
Indicator, Fuel Quantity, 4-3
Indicator, True Airspeed, 7-5
Inspection Requirements, 5-6
Instrument Markings, Engine, 4-2
Instrument Panel Diagram, 1-8
Insufficient Rate Of Electrical Charge, 3-12
Integrated Seat Belt/Shoulder Harnesses With Inertia Reels, 2-12
Interior Care, 5-4
Interior Lighting, 2-7

L

Landing, 2-21
after, 1-7
balked, 1-7, 2-22
before, 1-7, 2-20
crosswind, 2-21
distance table, 6-9
forced, 3-2
normal, 1-7
precautionary with power, 3-6
short field, 2-21
Landing Gear Lever, 2-9
Landing Gear Malfunction Procedures, 3-8
extension malfunctions, 3-9
landing with defective nose gear, 3-10
landing with partially extended main gear, 3-11
landing without positive indication of gear locking, 3-10
retraction malfunctions, 3-8
Landing Gear Retraction, 2-17
Landing Gear Servicing, inside back cover
main/nose wheel tire pressure, inside back cover
nose gear shock strut servicing, inside back cover
Landing Gear System, 2-9
care, 5-3
emergency hand pump, 2-10
gear lever, 2-9
gear retraction, 2-17
Leaning with EGT, 2-19
Let-Down, 1-6
Lighting Equipment, 2-7
exterior lighting, 2-7
interior lighting, 2-7
Limitations, Airspeed, 4-2
Limitations, Engine Operation, 4-2
Loading Arrangements Diagram, 4-5
Loading Graph, 4-7

Loading Problem, Sample, 4-6
Low Oil Pressure, 3-7

M

MAA Plate/Finish Trim Plate, 5-4
Magneto Check, 2-15
Magneto Malfunction, 3-7
Malfunctions, Landing Gear
 extension malfunctions, 3-9
 landing with defective nose gear, 3-10
 landing with partially extended main gear, 3-11
 landing without positive indication of gear locking, 3-10
 retraction malfunctions, 3-8
Maneuvers - Normal Category, 4-1
Manifold Pressure/Fuel Flow Indicator, 4-3
Markings, Airspeed Indicator, 4-2
Markings, Engine Instrument, 4-2
Master Switch, 2-4
Maximum Glide Diagram, 6-10
Maximum Performance Climb, 1-6
Maximum Performance Take-Off, 1-5
Maximum Rate-Of-Climb Data Chart, 6-3
Microphone-Headset, 7-4
Moment Envelope, Center Of Gravity, 4-8
Mooring Your Airplane, 5-1

N

Noise Abatement, 2-24
Normal Category Maneuvers, 4-1
Normal Climb, 1-6
Normal Landing, 1-7
Normal Take-Off, 1-5
Nose Gear Shock Strut, inside back cover

Index-4

O

Oil System,
 capacity, inside back cover
 oil/filter change, inside back cover
 oil grade, inside back cover
 pressure gage, 4-3
 quick-drain valve, 7-6
 temperature gage, 4-2
Operation, Cold Weather, 2-22
Operation, Hot Weather, 2-23
Operation Limitations, Engine, 4-2
Operations Authorized, 4-1
Over-Voltage Sensor and Warning Light, 2-6
Owner Follow-Up System, 5-8
 publications, 5-9

P

Painted Surfaces, 5-2
Performance - Specifications, inside front cover
Precautionary Landing With Engine Power, 3-6
Principal Dimensions Diagram, ii
Progressive Care, Cessna, 5-7
Propeller,
 care, 5-3
Publications, 5-9

Q

Quick-Drain Valve, Oil, 7-6

R

Radio Selector Switches, 7-2
 diagram, 7-3

operation, 7-2
speaker-phone switches, 7-3
transmitter selector switch,
7-2

Recovery From Spiral Dive, 3-6
Retraction, Landing Gear, 2-17
Rough Engine Operation Or Loss Of
Power, 3-7
 low oil pressure, 3-7
 magneto malfunction, 3-7
 spark plug fouling, 3-7

S

Sample Loading Problem, 4-6
Securing Aircraft, 1-7
Servicing Requirements, 5-8,
 inside back cover
 engine oil, inside back cover
 fuel, inside back cover
 landing gear, inside back cover
Short Field Landings, 2-21
Shoulder Harnesses, 2-11
Spark Plug Fouling, 3-7
Speaker-Phone Switches, 7-3
Spins, 3-6
Stalls, 2-20
 speed chart, 6-2
Starting, Engine, 1-4, 2-12, 2-22
Static Dischargers, 7-4
Static Pressure Alternate Source
 Valve, 2-23
Storage, Flyable, 5-5
Surfaces,
 painted, 5-2
System,
 cabin heating, ventilating
 and defrosting, 2-10

electrical, 2-4
fuel, 2-1
owner follow-up, 5-8

T

Table Of Contents, iii
Tachometer, 4-3
Take-Off, 1-5, 2-16
 before, 1-4, 2-15
 crosswind, 2-17
 data chart, 6-3
 maximum performance, 1-5
 normal, 1-5
 power check, 2-16
 wing flap settings, 2-16
Taxing, 2-13
 diagram, 2-14
Tire Pressure, inside back cover
Transmitter Selector Switch, 7-2
True Airspeed Indicator, 7-5

W

Weight,
 empty, inside front cover
 gross, inside front cover
Weight And Balance, 4-3
 center of gravity moment
 envelope, 4-8
 loading arrangements diagram,
 4-5
 loading graph, 4-7
 sample loading problem, 4-6
Windshield - Windows, 5-2
Wing Flap Settings, 2-16
Winterization Kit, 7-1

SERVICING REQUIREMENTS *

ENGINE OIL:

GRADE -- Aviation Grade SAE 50 Above 60°F.

Aviation Grade SAE 10W30 or SAE 30 Between 0° and 70°F.

Aviation Grade SAE 10W30 or SAE 20 Below 10°F.

Multi-viscosity oil with a range of SAE 10W30 is recommended for improved starting in cold weather. Detergent or dispersant oil, conforming to Specification No. MIL-L-22851, must be used.

NOTE

Your Cessna was delivered from the factory with a corrosion preventive aircraft engine oil. If oil must be added during the first 25 hours, use only aviation grade straight mineral oil (non-detergent) conforming to Specification No. MIL-L-6082.

CAPACITY OF ENGINE SUMP -- 8 Quarts.

Do not operate on less than 6 quarts. To minimize loss of oil through breather, fill to 7 quart level for normal flights of less than 3 hours. For extended flight, fill to 8 quarts. These quantities refer to oil dipstick level readings. During oil and oil filter changes, one additional quart is required when the filter element is changed.

OIL AND OIL FILTER CHANGE --

After the first 25 hours of operation, drain engine oil sump and oil cooler, clean the oil suction strainer, and change the filter element. Refill sump with straight mineral oil (non-detergent) and use until a total of 50 hours has accumulated or oil consumption has stabilized; then change to detergent oil. Drain the engine oil sump and oil cooler, clean the oil suction strainer, and change the filter element each 50 hours thereafter. The oil change interval may be extended to 100-hour intervals, providing the oil filter element is changed at 50-hour intervals. Change engine oil at least every 6 months even though less than the recommended hours have accumulated. Reduce intervals for prolonged operation in dusty areas, cold climates, or when short flights and long idle periods result in sludging conditions.

SERVICING REQUIREMENTS *

FUEL:

GRADE -- 100/130 Minimum Grade Aviation Fuel.

100/130 low lead aviation fuel with a lead content limited to 2 cc per gallon is also approved.

CAPACITY EACH TANK -- 30.5 Gallons.

REDUCED CAPACITY EACH TANK (INDICATED BY SMALL HOLES INSIDE FILLER NECK) -- 22 Gallons.

NOTE

To ensure desired fuel capacity when refueling, place the fuel selector valve in either LEFT or RIGHT position to prevent cross-feeding.

LANDING GEAR:

NOSE WHEEL TIRE PRESSURE -- 31 PSI on 5.00-5, 4-Ply Rated Tire.

MAIN WHEEL TIRE PRESSURE -- 68 PSI on 15 x 6.00-6, 6-Ply Rated Tires.

NOSE GEAR SHOCK STRUT --

Keep filled with MIL-H-5606 hydraulic fluid and inflated with air to 38 PSI.

* For complete servicing requirements, refer to the aircraft Service Manual.



"TAKE YOUR CESSNA HOME
FOR SERVICE AT THE SIGN
OF THE CESSNA SHIELD".



CESSNA AIRCRAFT COMPANY

WICHITA, KANSAS

